

LEGO

6+

4881

Designer Set



Ideas



Instructions



Quick Build
 Schnellbaumodelle
 Construction rapide
 Costruzione rapida
 Snel bouwen
 Construcción rápida
 Byg hurtigt
 Nopeaan rakentamiseen
 Bygg snabbt
 Construção Rápida
Γρήγορες Κατασκευές
 Kísérletezőknek



Experienced Build
 Könnnermodelle
 Construction normale
 Costruzione esperta
 Bouwen voor gevorderden
 Construcción experta
 Byg videre
 Kokeneelle rakentajalle
 Bygg mer
 Construção para Experimentados
Εμπειρικές Κατασκευές
 Haladóknak



Advanced Build
 Profi-modelle
 Construction avancée
 Costruzione avanzata
 Geavanceerd bouwen
 Construcción avanzada
 Byg avanceret
 Taitavalle rakentajalle
 Bygg avancerat
 Construção Avançada
Εξελιγμένες Κατασκευές
 Profi-knak





16



64



12



1



2



3



4



5

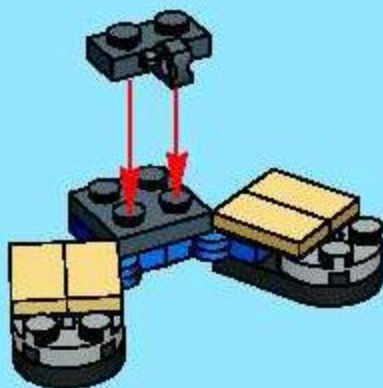

6

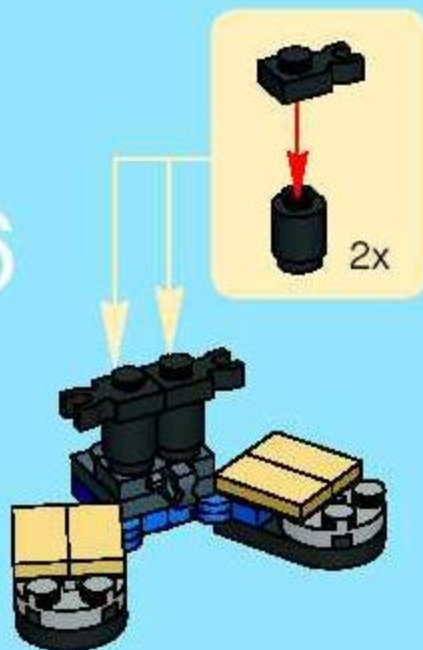

7

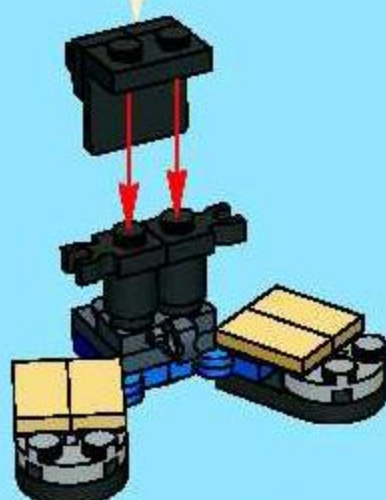

8

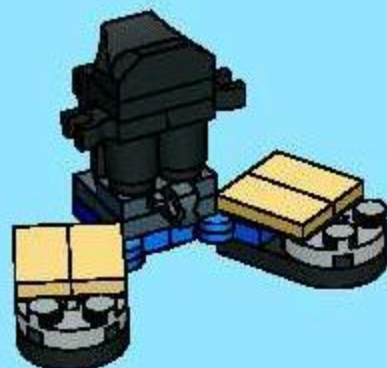

9





10

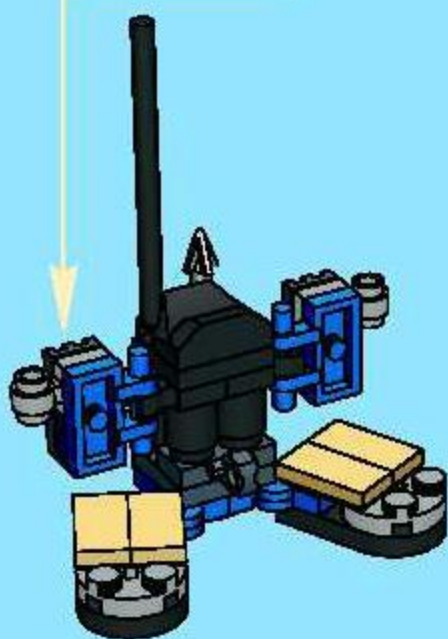

11

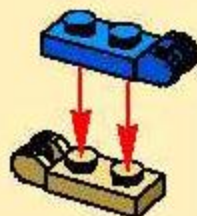
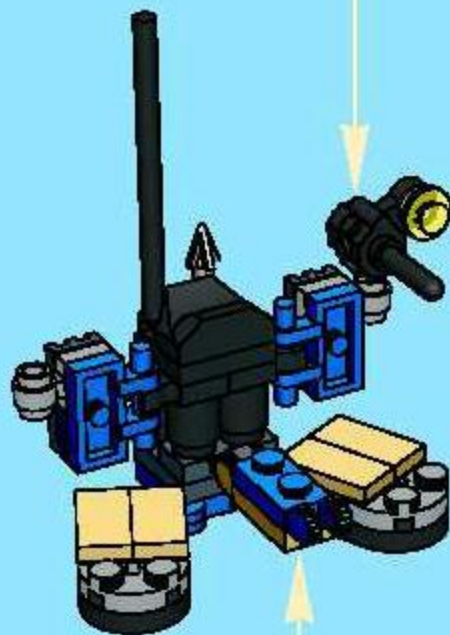

12

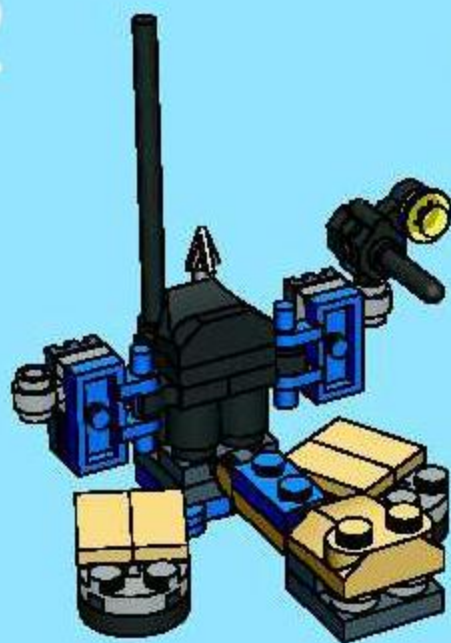

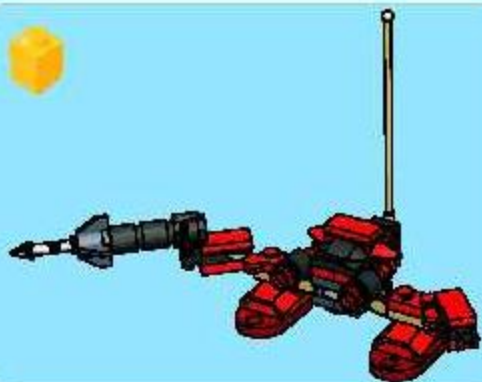

1

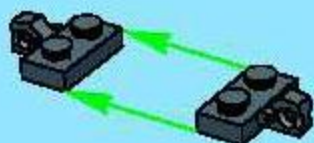

2



3



4



5



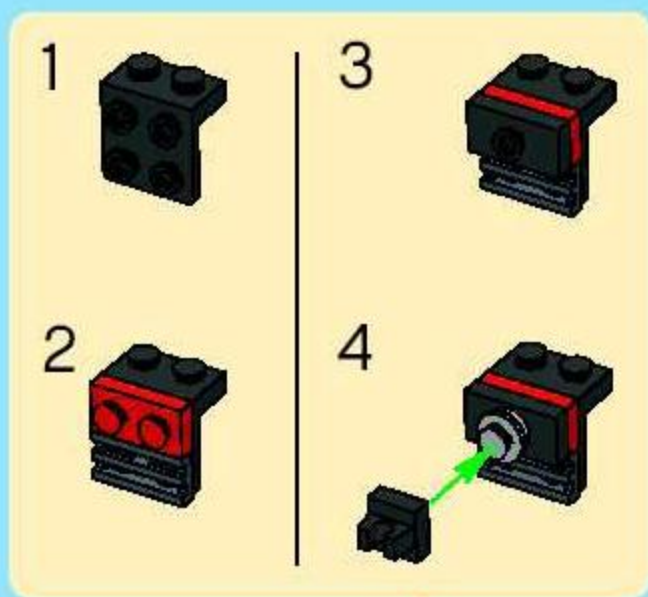

6



7



8



9



10

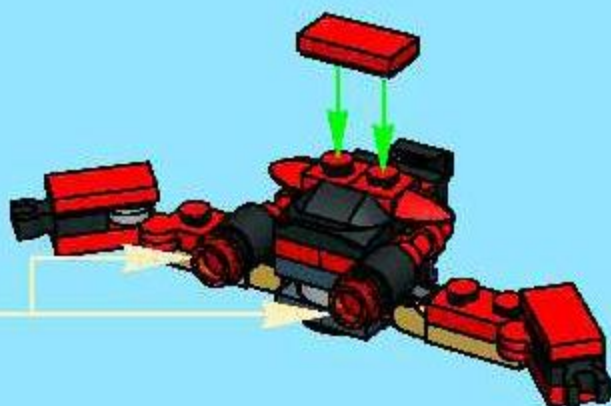

11

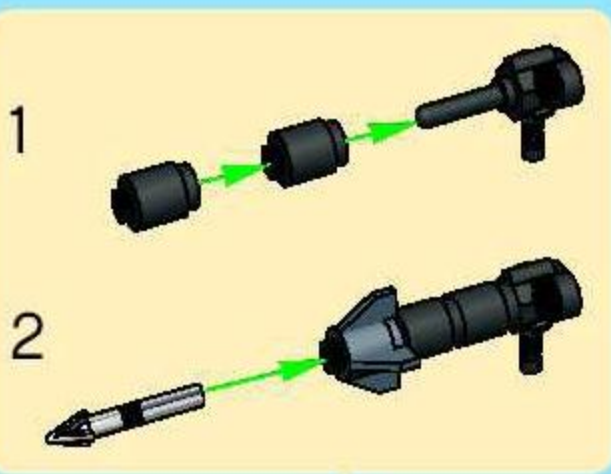
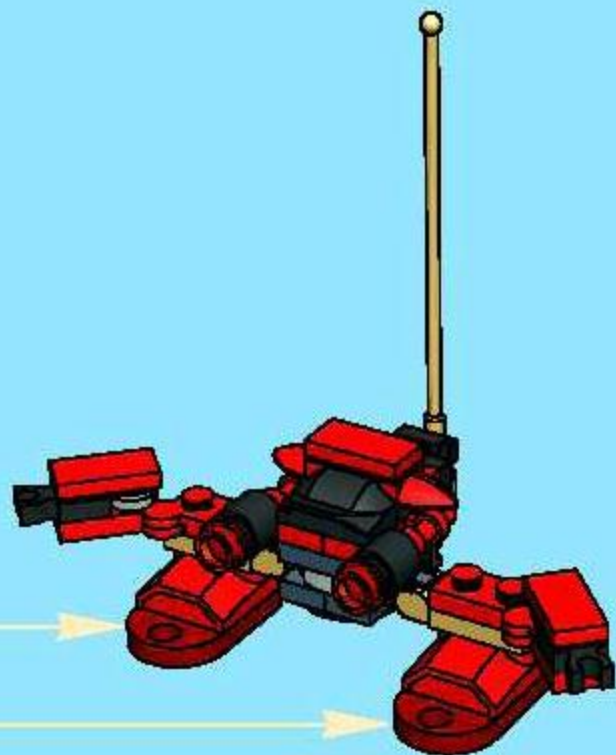

12

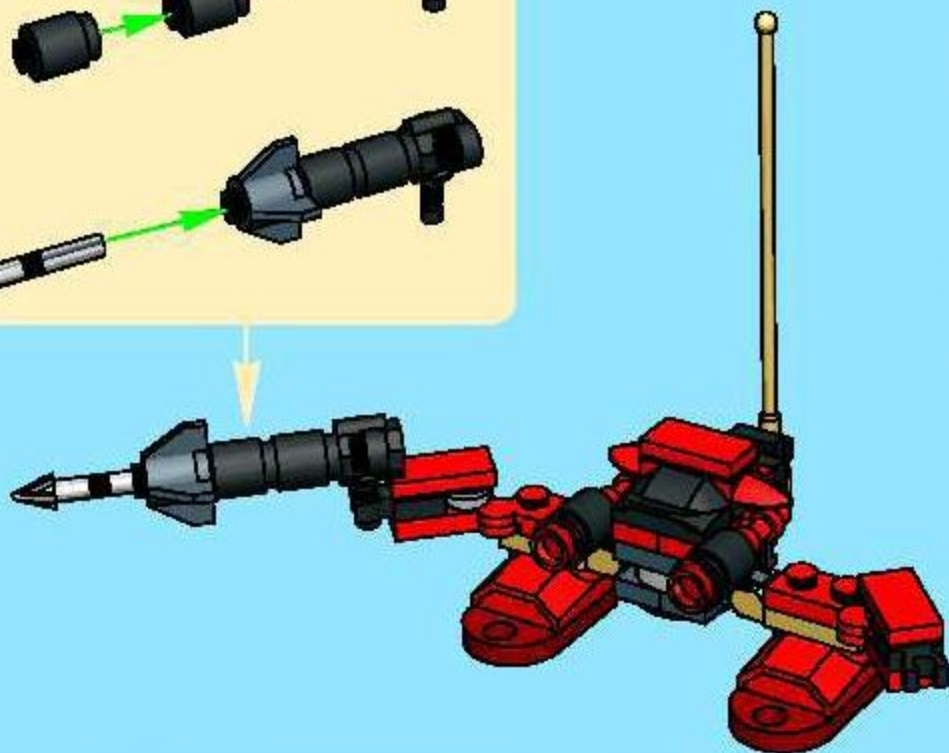



1



2



3



4



5



6

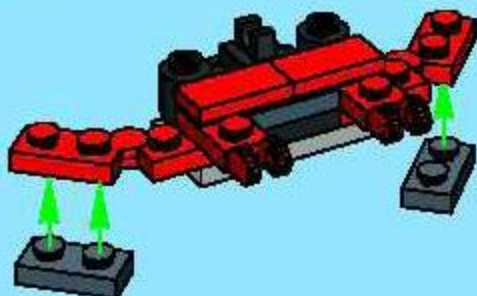

7

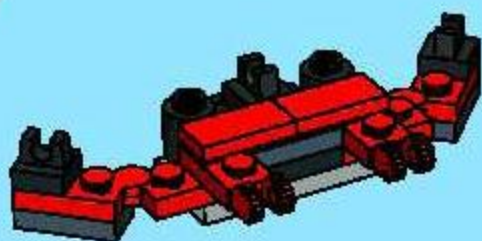

8

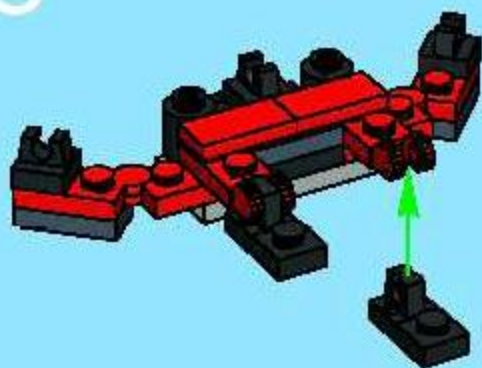

9

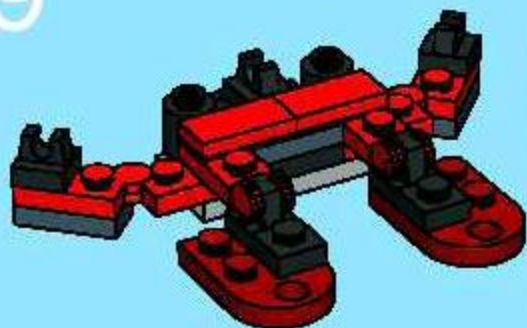

1



2



3



4



10



11









1



2



3



4



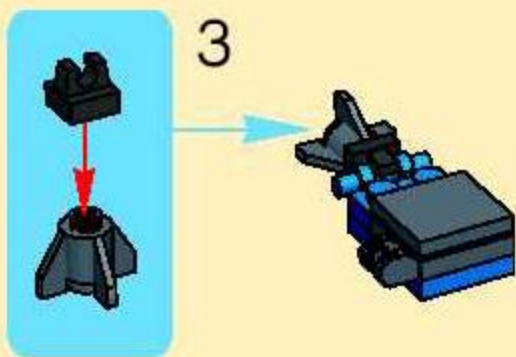
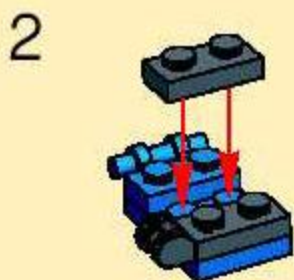
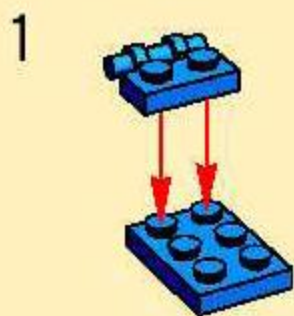

5



1

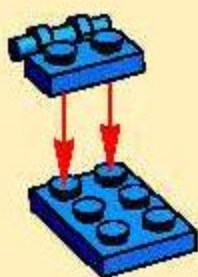

2



3

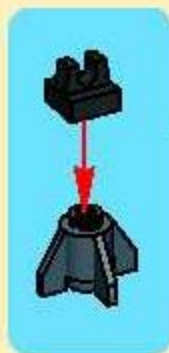

4



6



1

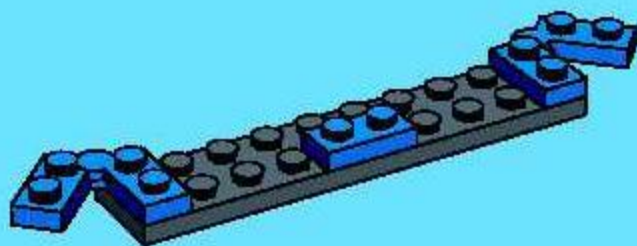

2

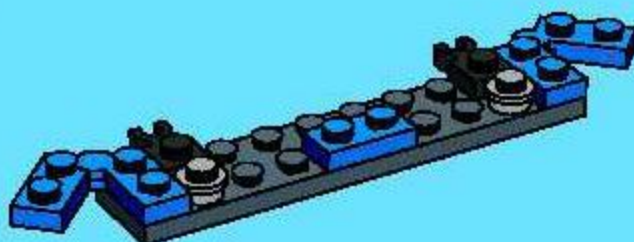

3



4

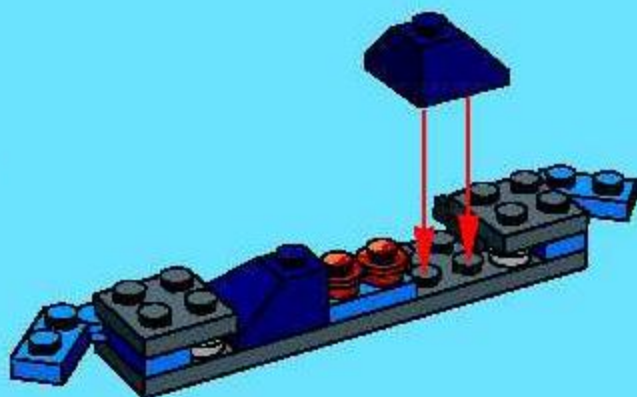

5

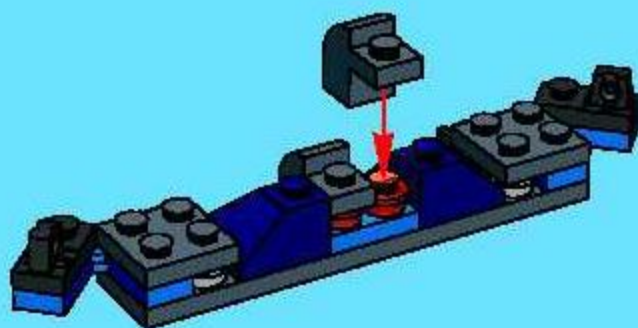

6



7

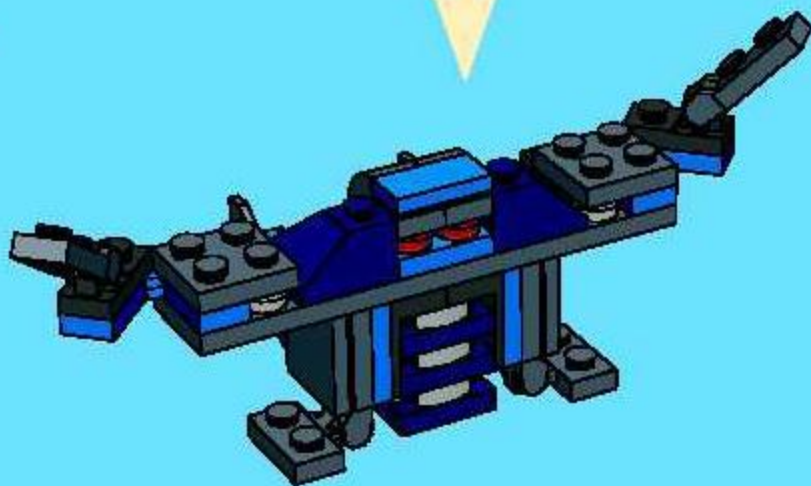

1



2



3



4



5



8

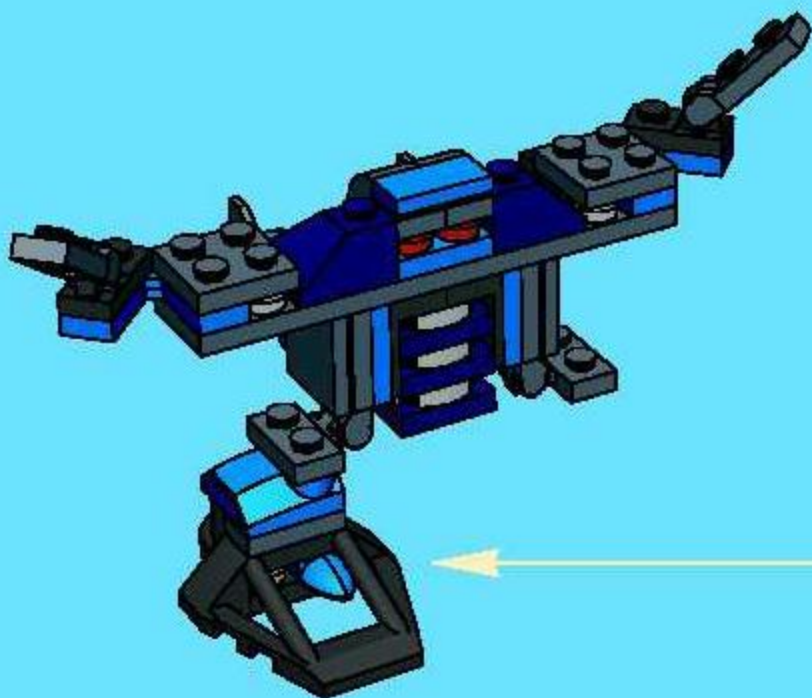

1



2



3



4



5



9



1



2



3



4



5

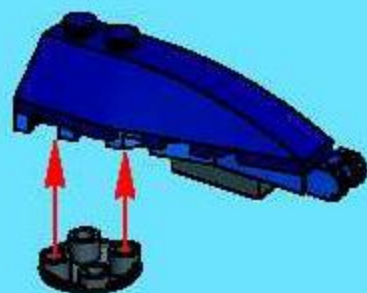

1



2



6



7

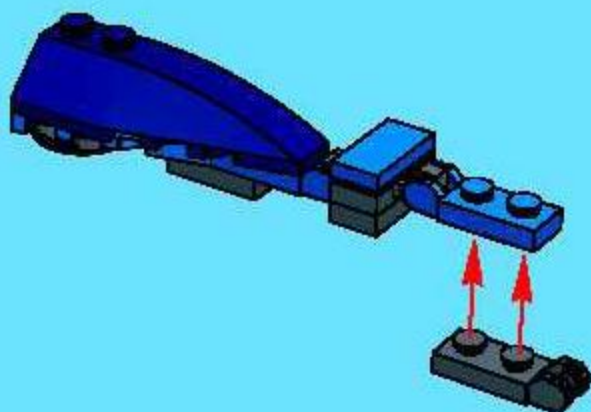

8

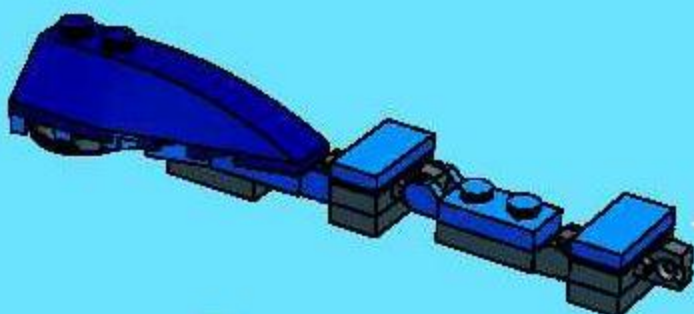

1



2



10

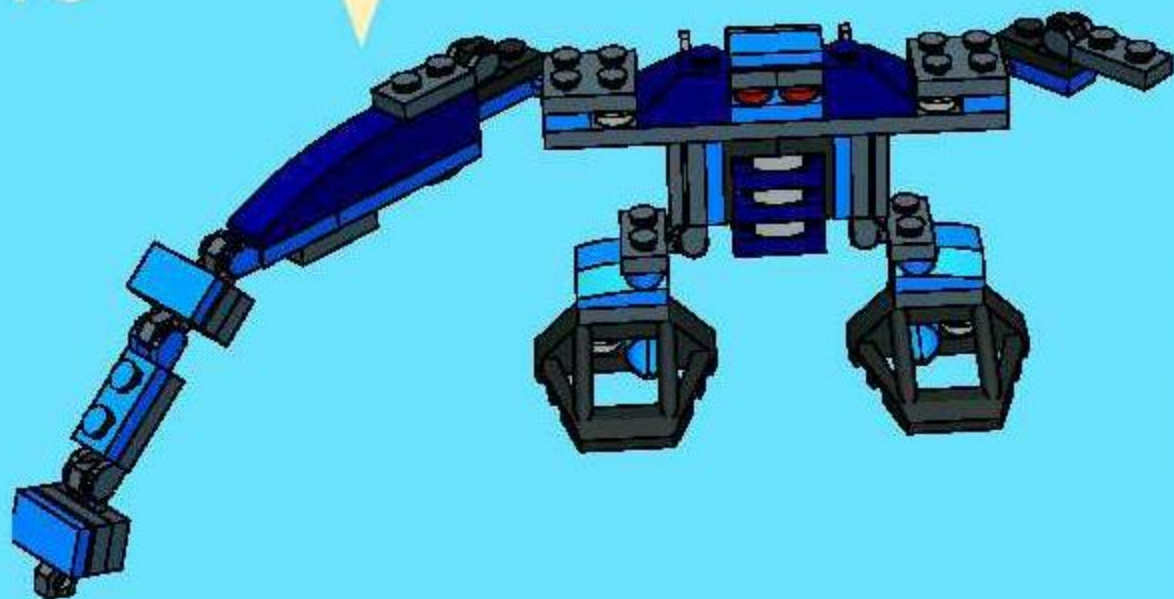

1



2



3



4



5

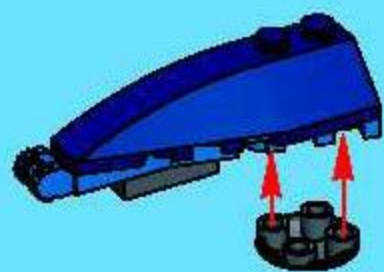

1

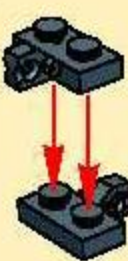

2



6



7

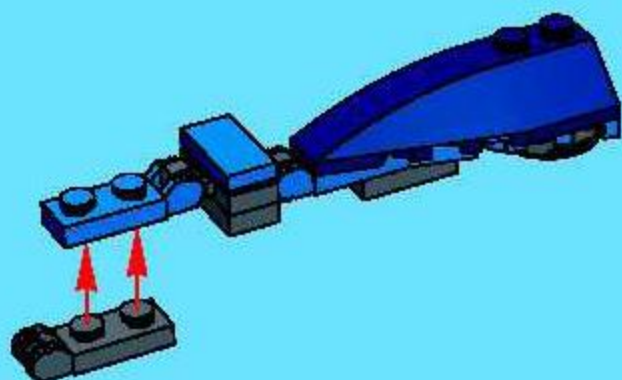

1

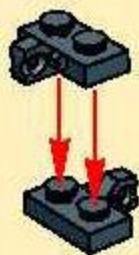

2



8

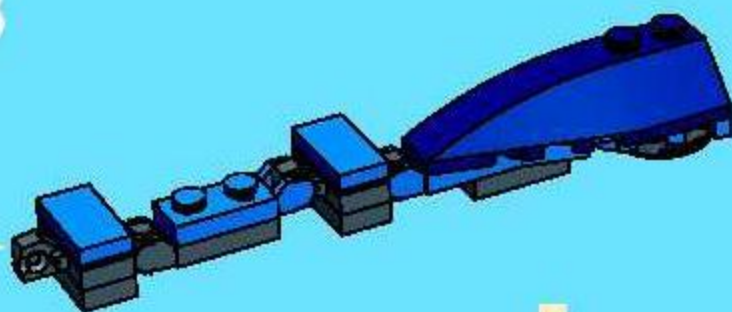

11





=



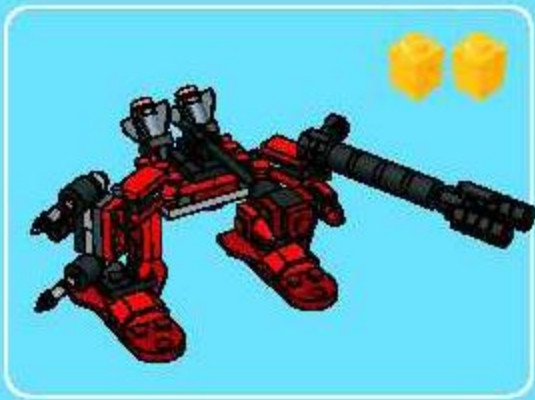

1

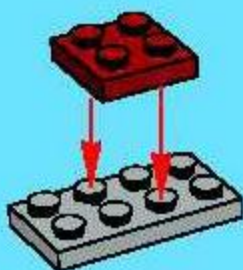

2



3

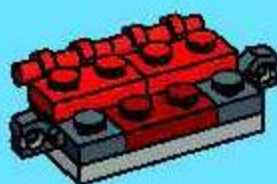

4

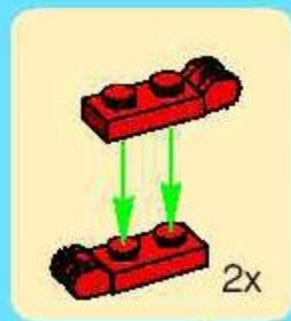
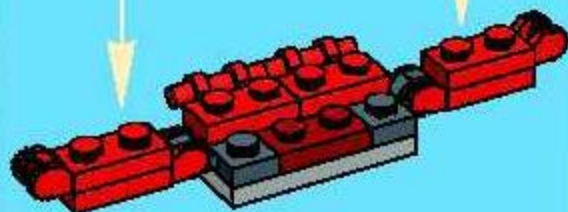

5

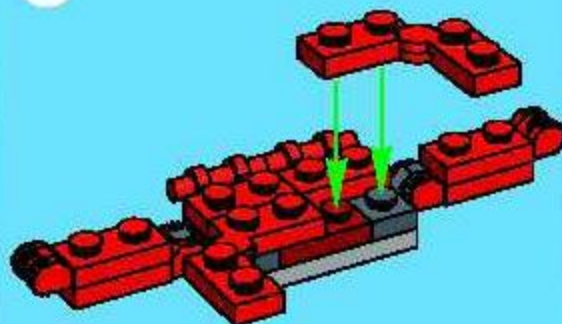

6

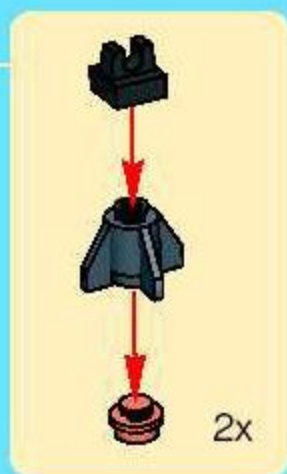

7



8

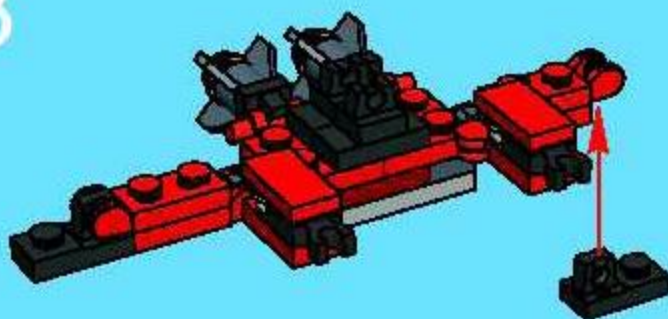

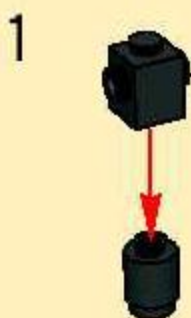

1



2



2x

10

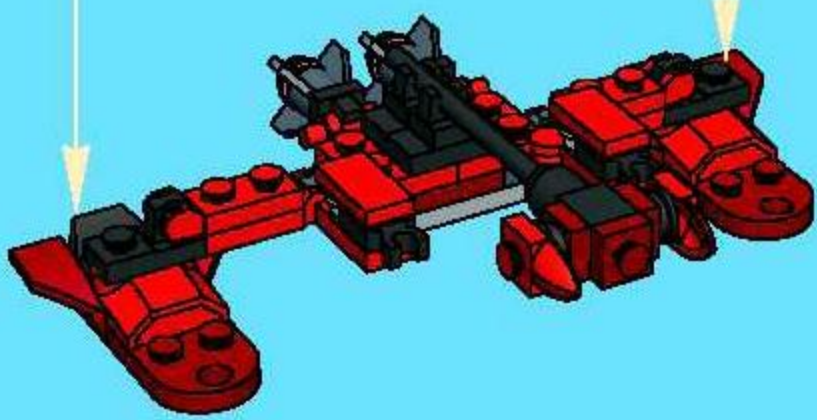

11

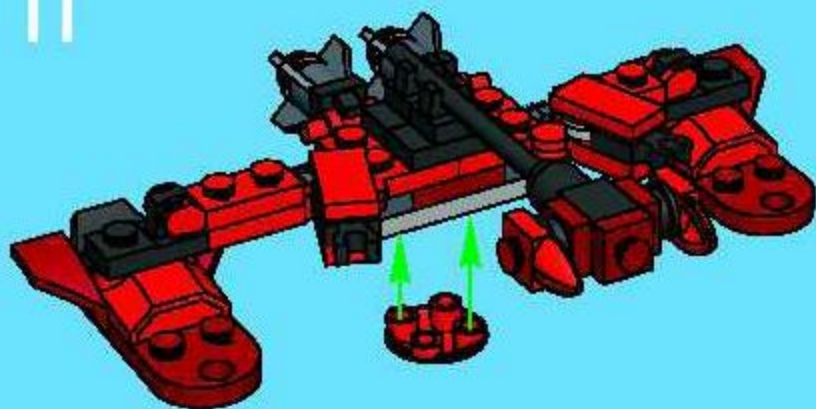

12



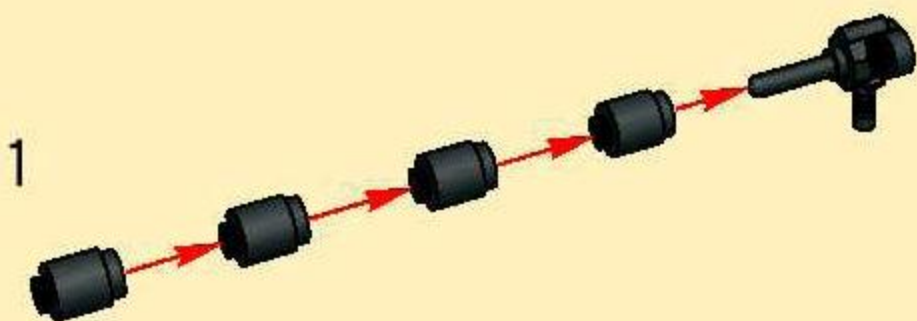

13



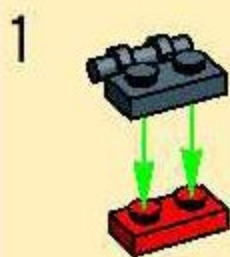

14

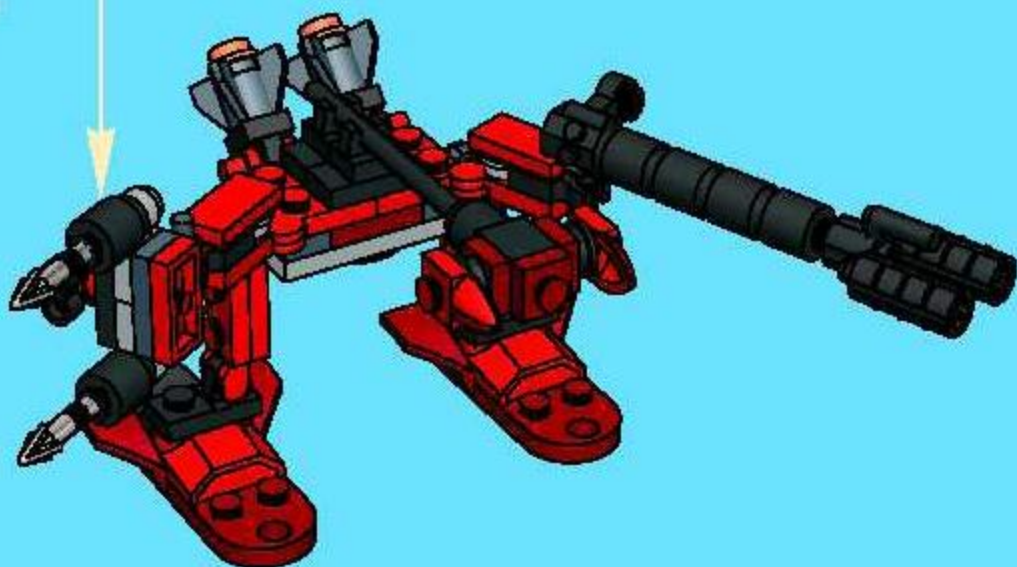



=

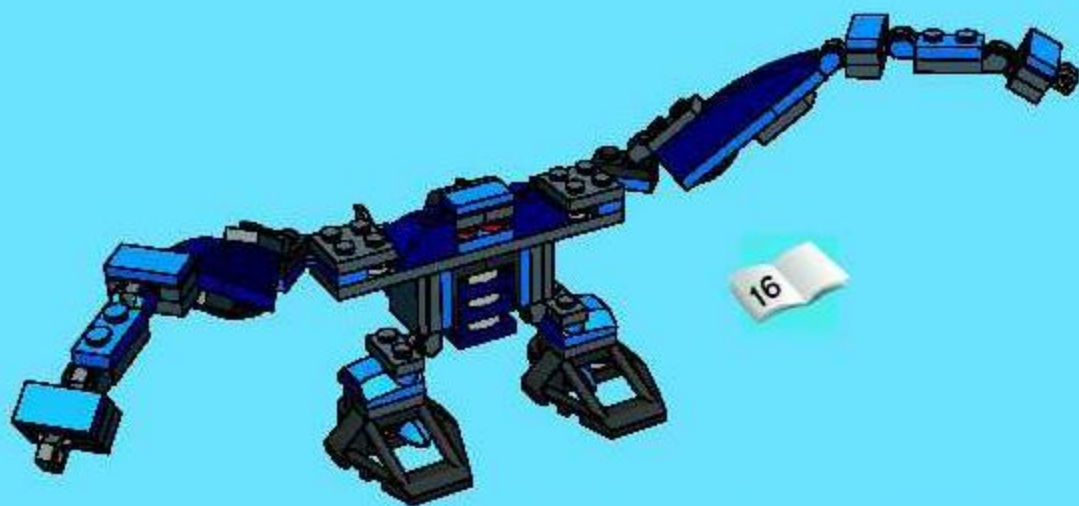

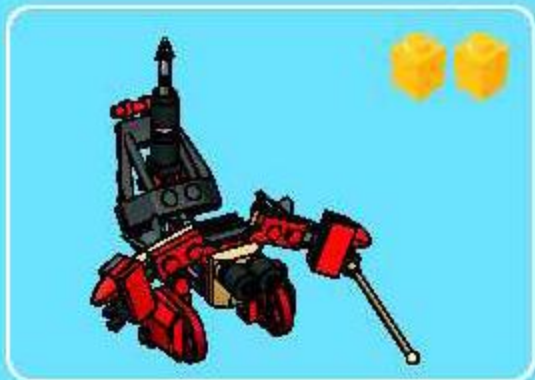

1

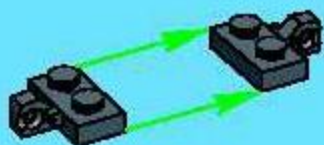

2



3



4

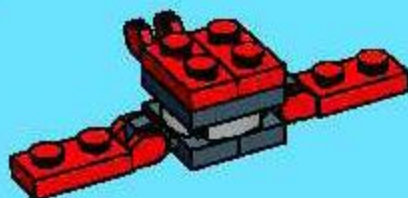

5

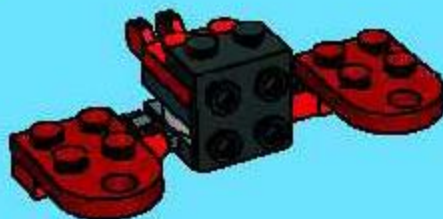

6



7

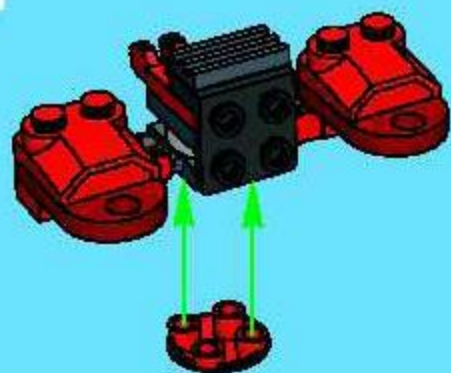

9



8



10



11

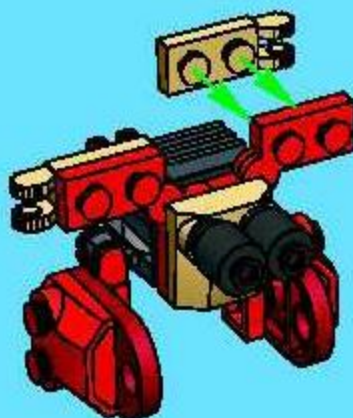

12

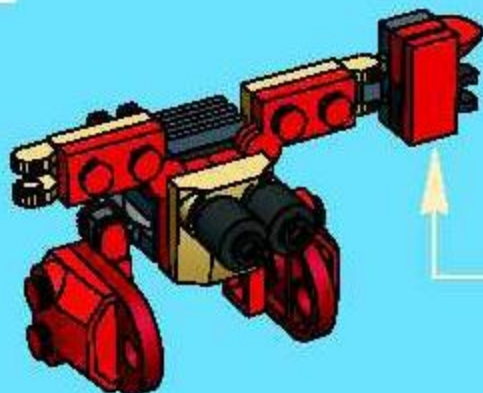

1



2



3



13

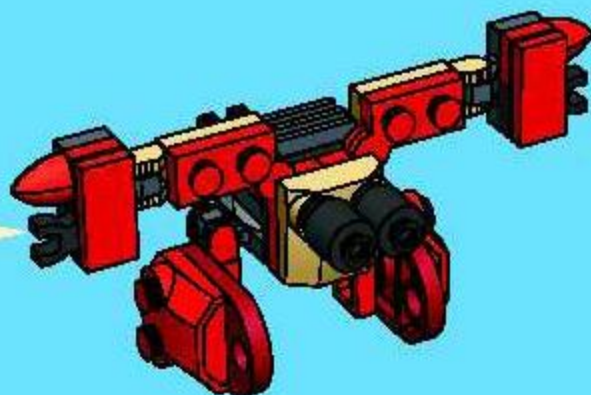

2x

14

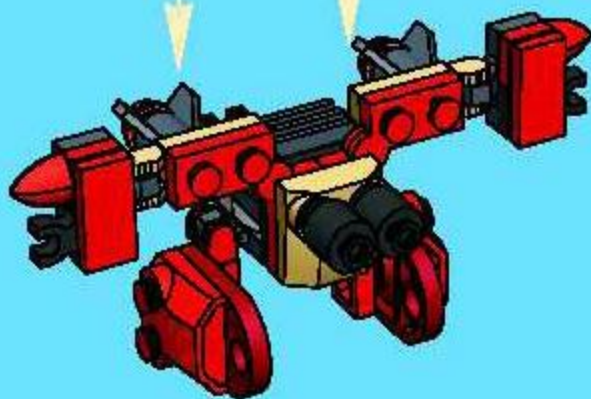

1

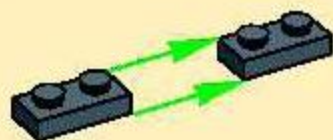

2

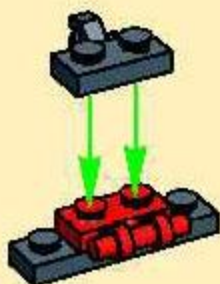

3



4

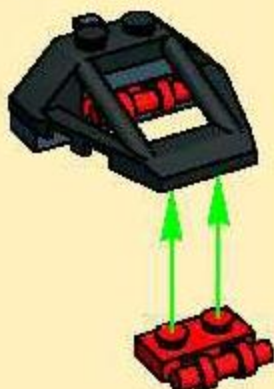

1



2



3



5



15

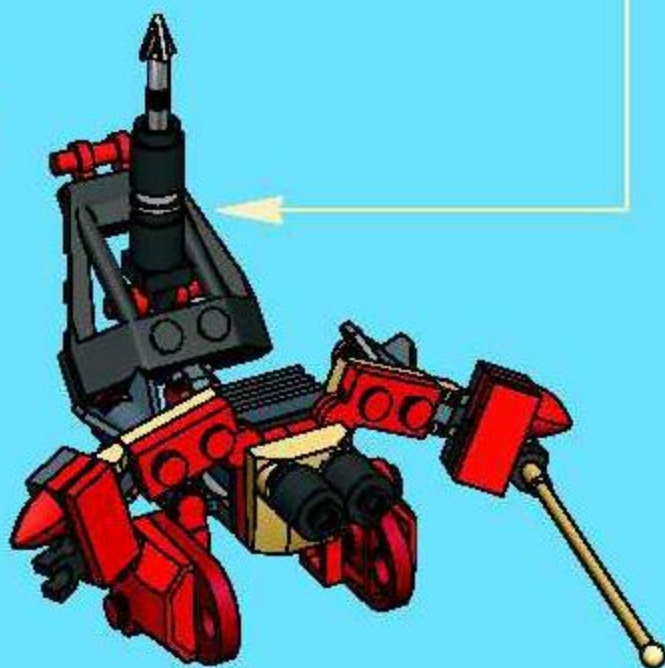





36





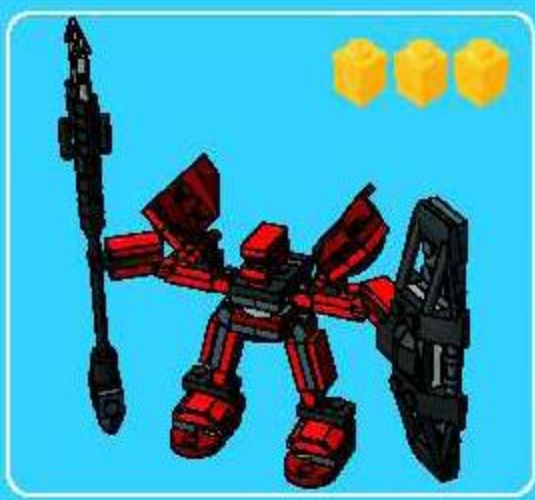

1

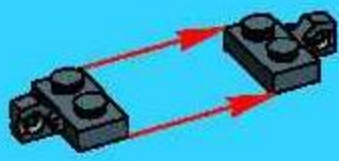

2



3



4

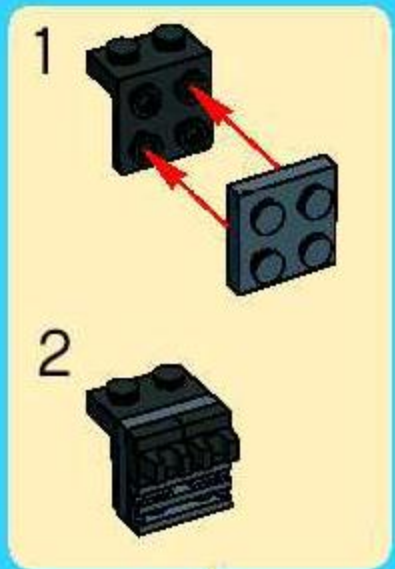

5



6



7

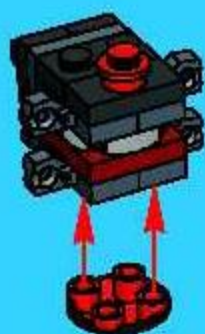

1



2



3



8



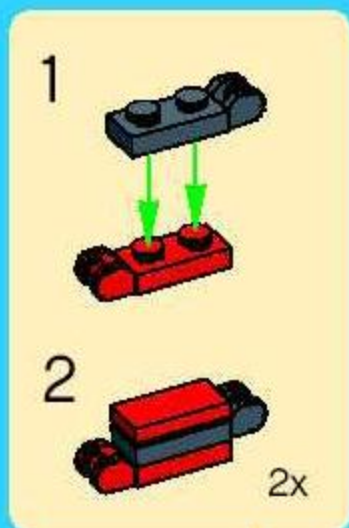

9



10



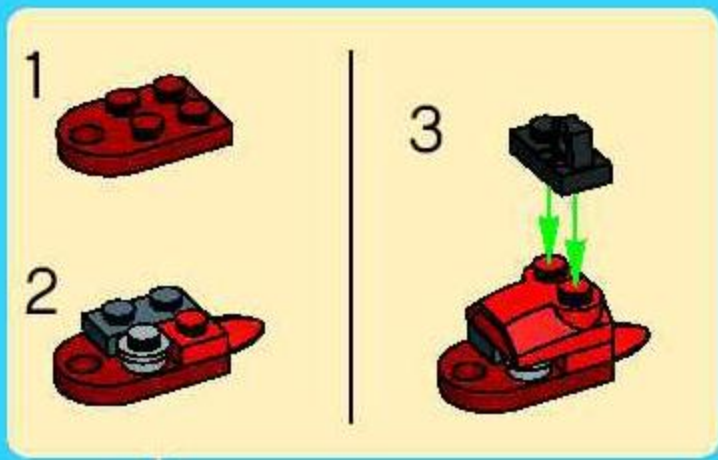

11



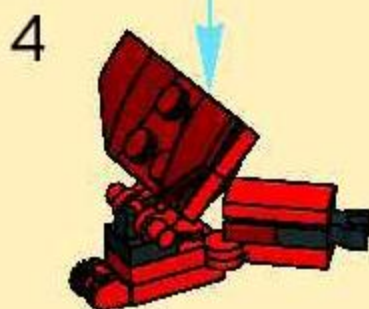
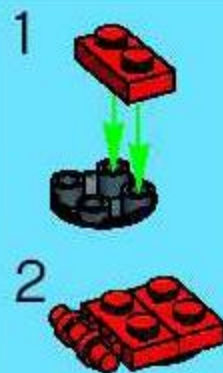
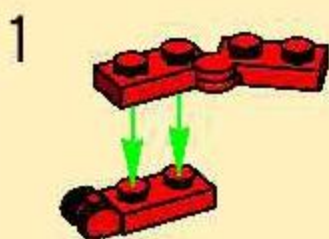

12

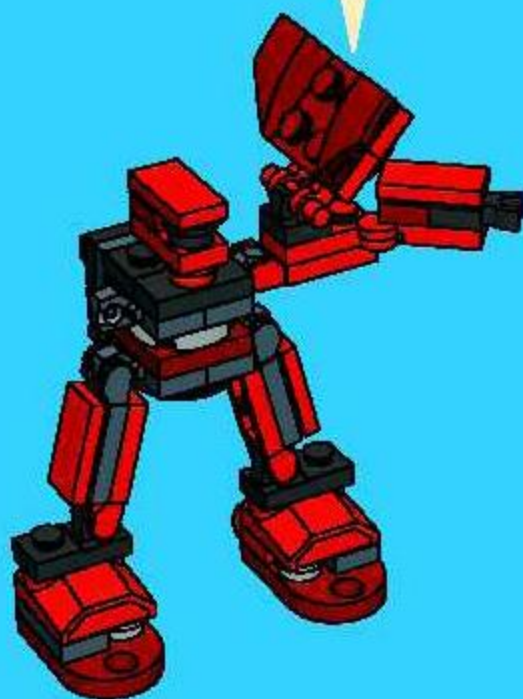

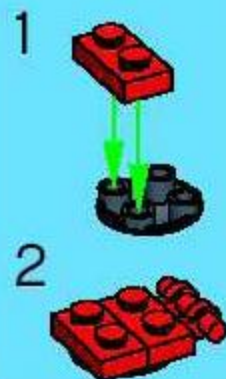
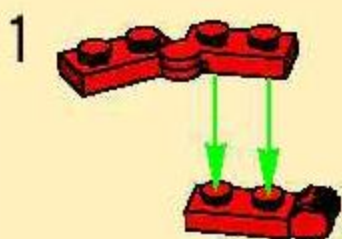

13

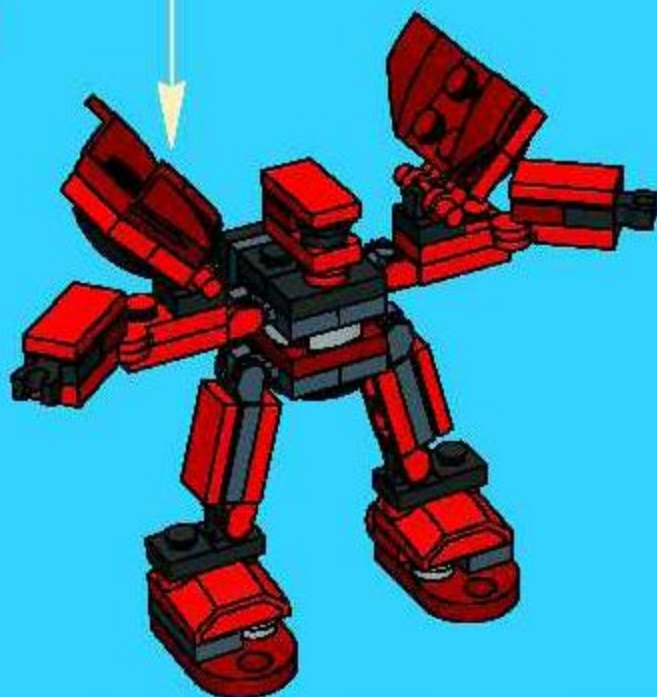

1

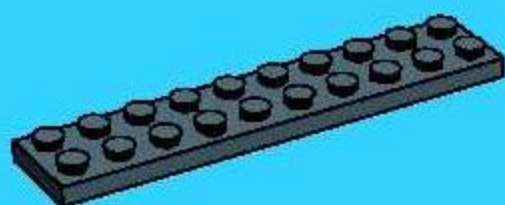

2

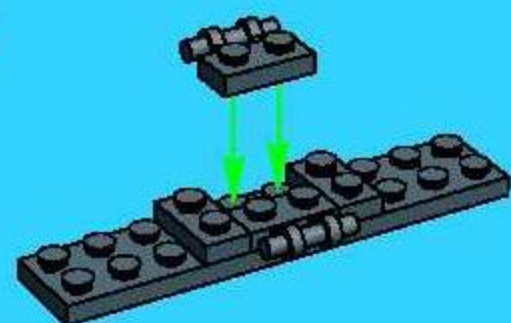

3



4

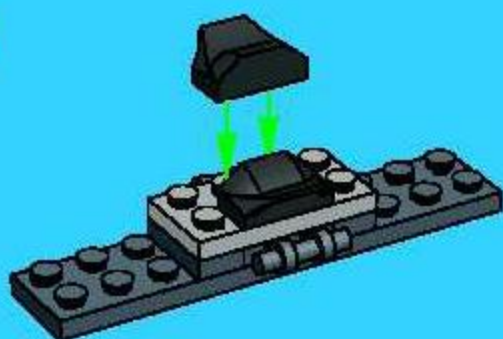

5



14

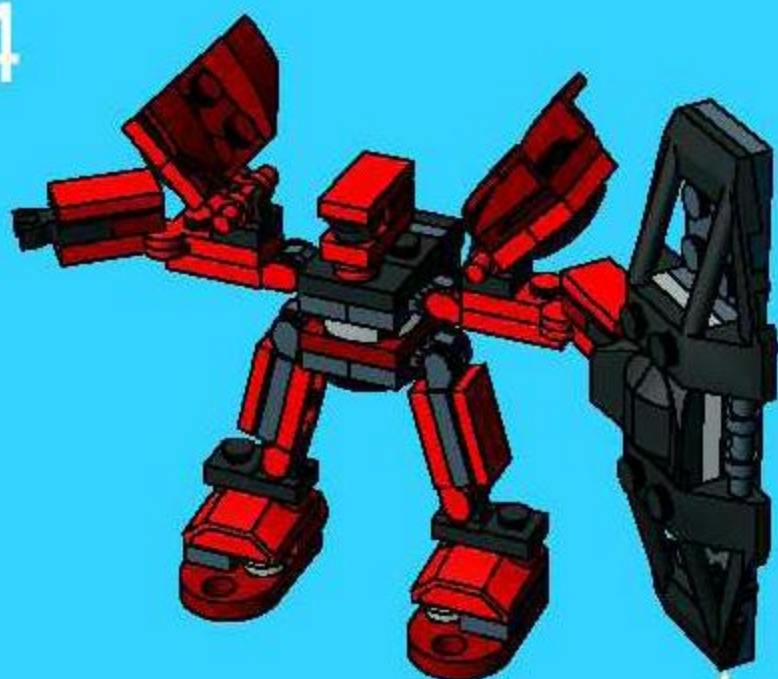

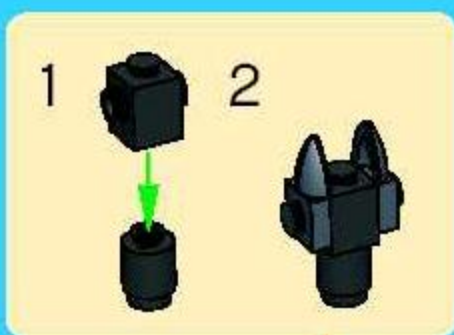
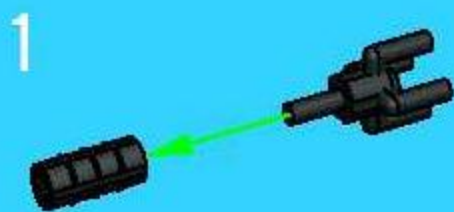

15





=



55



64



1

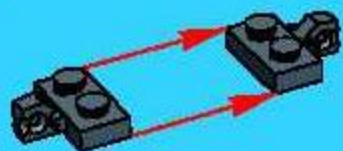

2



3



4



1

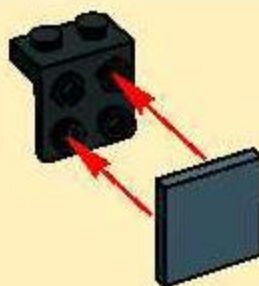

5



6



7

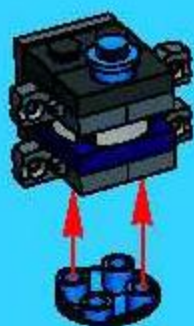

1



2



3



8



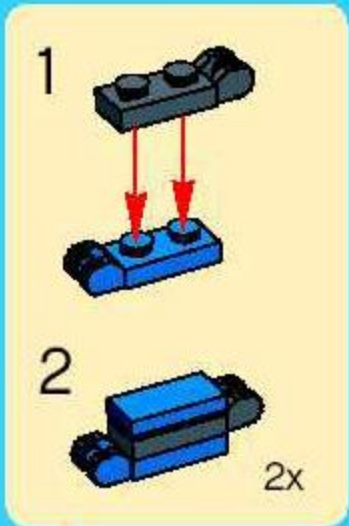

9



10



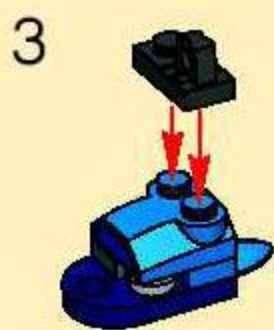

11



1

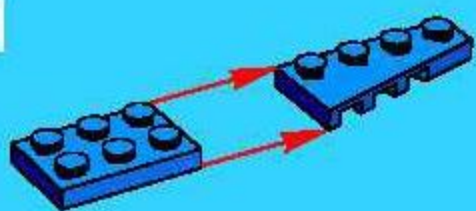

2

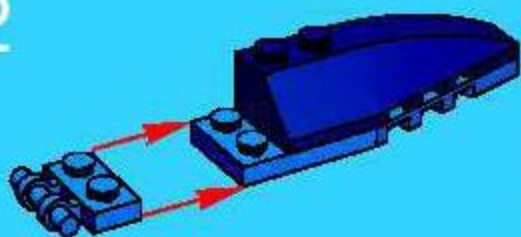

3

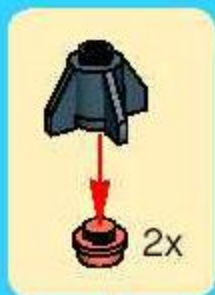

4

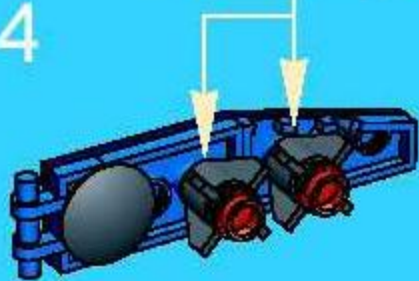

1

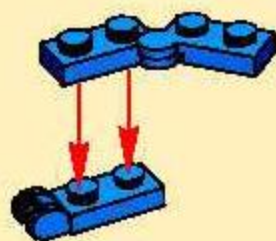

2



3

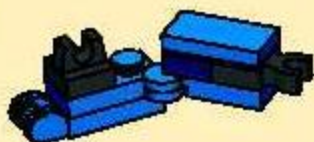

5



12

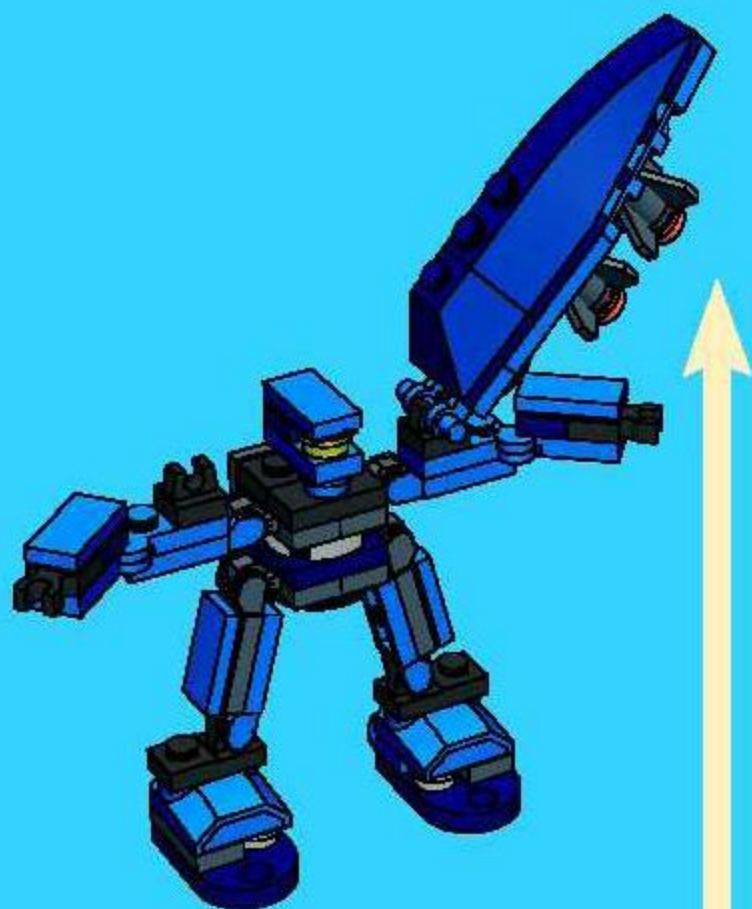

1

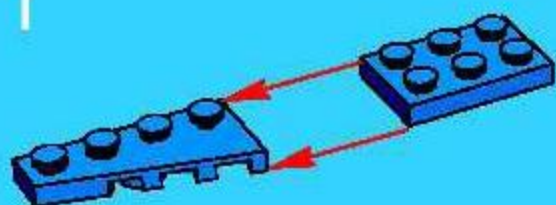

2

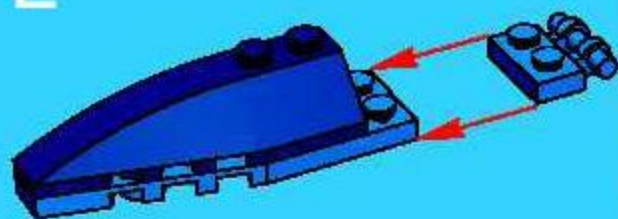

3

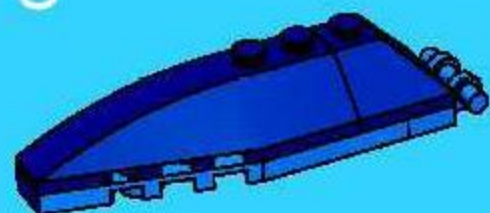

4



1

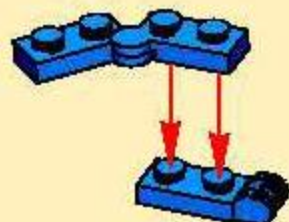

2



3



5

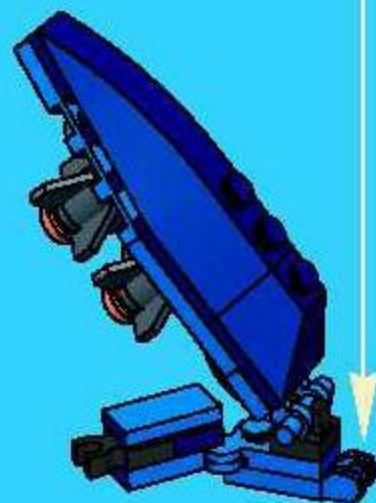

13

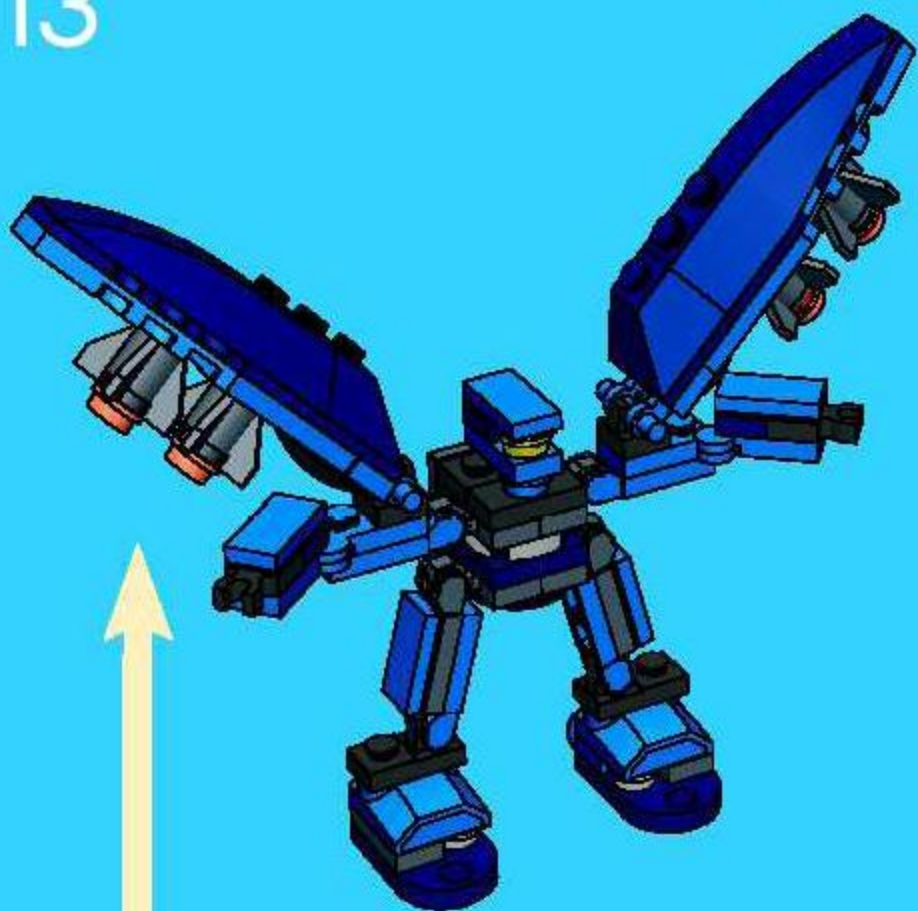



=



44



64



1

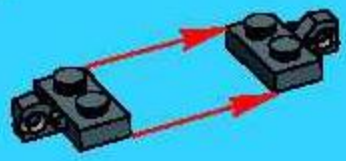

2



3



4



1

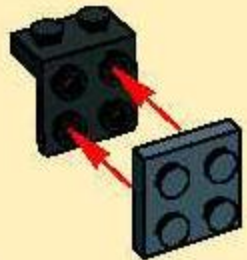

2



3



5



6



7

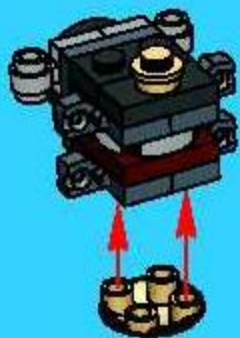

1



2



3



8



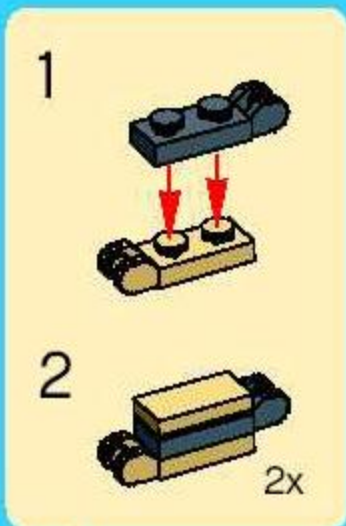

9

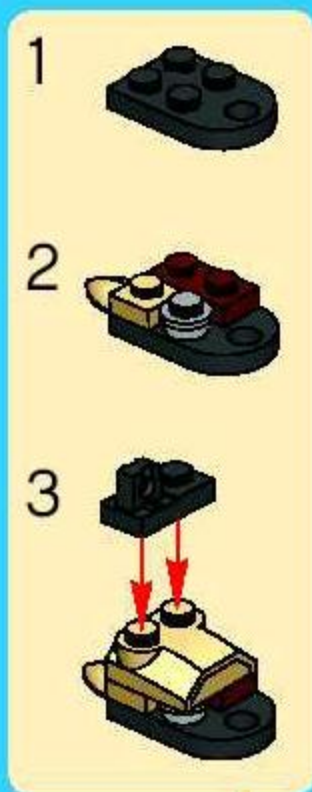
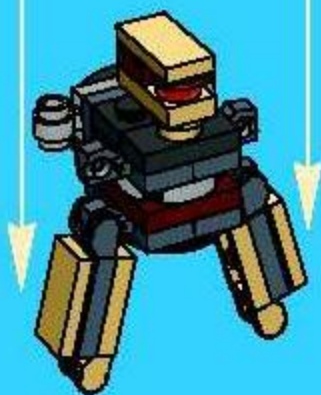

10



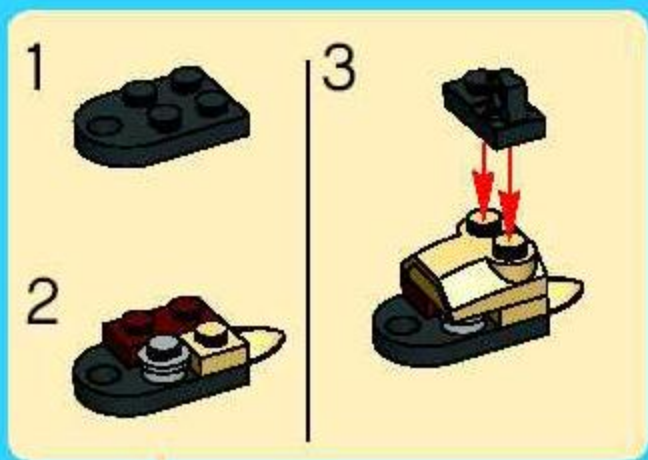

11



1

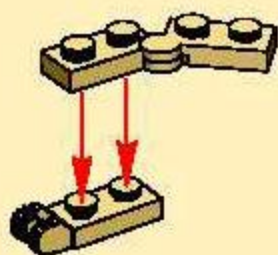

2

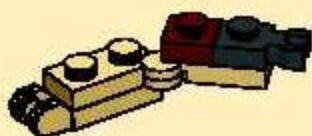

3



12



1

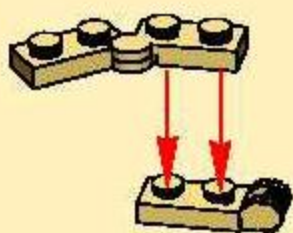

2



3



1



2



3

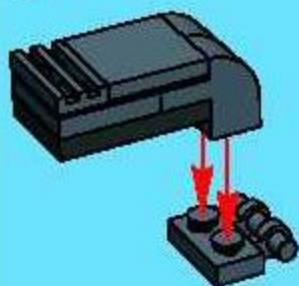

4



13



1

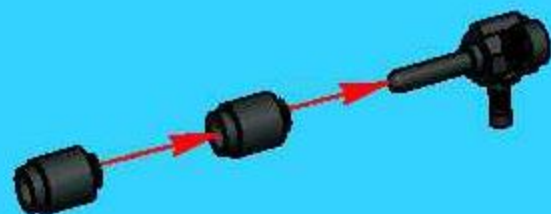

2



3



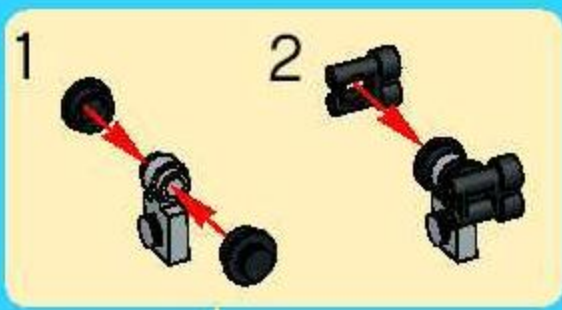

14



15



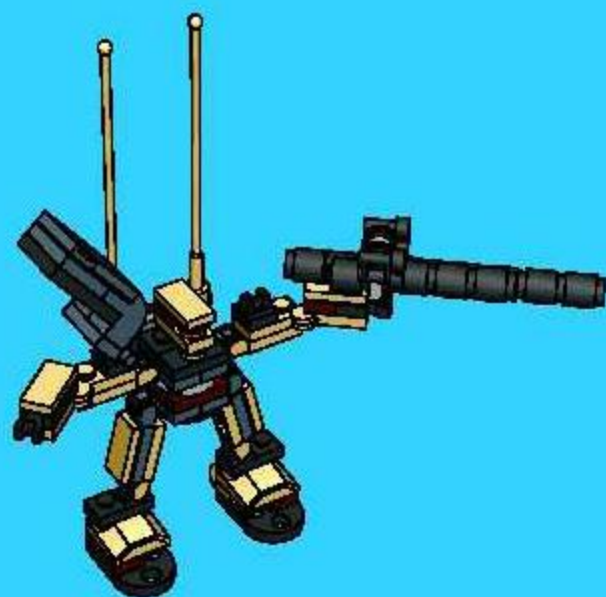

=



44























55









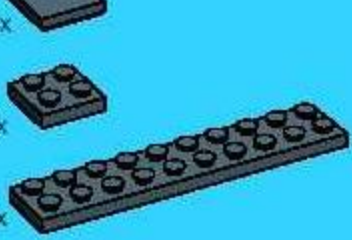













55







- 1x 
- 2x 
- 1x 
- 5x 
- 3x 
- 2x 
- 4x 
- 2x 
- 2x 
- 2x 
- 2x 
- 4x 
- 4x 
- 2x 
- 2x 
- 2x 
- 6x 
- 12x 
- 3x 
- 6x 
- 2x 
- 3x 
- 1x 

- 5x 
- 6x 
- 6x 
- 2x 
- 11x 
- 1x 
- 2x 
- 3x 
- 3x 
- 6x 
- 1x 
- 1x 
- 1x 
- 2x 
- 1x 
- 2x 
- 1x 
- 3x 
- 2x 
- 1x 
- 2x 
- 2x 
- 1x 

3x



2x



1x



6x



3x



3x



1x



3x



1x



2x



2x



1x



2x



5x



1x



4x



1x



2x



2x



2x



1x



1x



4x



2x



3x



1x



2x



2x



1x



1x



1x



2x



1x



5x



1x



2x



4x



2x



2x



2x



1x



1x



Win! Gagne! Gewinne! 当たります



WIN LEGO® PRODUCTS

We would like to know what you think about our new LEGO® product. If you could help us by answering a few questions you are in with a chance of winning an exciting LEGO prize. It will only take you about 3 minutes! Log on to the web address below for further instructions.



GAGNE DES PRODUITS LEGO®

Nous aimerions savoir ce que tu penses de ton nouveau produit LEGO®. Si tu veux bien nous aider en répondant à quelques questions, tu recevras peut-être bientôt un fantastique prix LEGO. Et cela ne te prendra que 3 minutes environ! Tu obtiendras davantage d'informations en visitant le site Internet indiqué ci-dessous.



GEWINNE LEGO® PRODUKTE

Wir sind sehr an deiner Meinung über dein neues LEGO® Produkt interessiert. Wenn du uns den Gefallen tust und ein paar Fragen beantwortest, kannst du einen tollen LEGO Preis gewinnen. Das Ganze dauert nur etwa 3 Minuten! Gehe einfach zu der unten angegebenen Webadresse - dort findest du weitere Informationen.



Estimado usuario LEGO®

Al contestar algunas preguntas en Inglés, francés, alemán o japonés, en el sitio www.acnielsen.aim.dk/lego, podrás participar en el sorteo de algunos valiosos premios LEGO®.



Caro Consumidor da LEGO®

Ao responder a algumas perguntas em Inglês, Francês, Alemão ou Japonês no endereço www.acnielsen.aim.dk/lego irá participar num concurso para ganhar valiosos prémios da LEGO®.



Kedves Új! LEGO® Vásárló

Ha ellátogat az www.acnielsen.aim.dk/lego honlapra és ott angol, francia, német vagy japán nyelven megválaszol az néhány kérdést, akkor részt vehet egy versenyben, amelyben értékes LEGO® díjakat nyerhet.



英語でレゴ®製品が当たります

私たちは、皆さんが新しいレゴ®製品についてどんな感想をお持ちか、知りたいと思っています。質問に答えて、あなたはレゴ®製品の抽選に参加できます。アンケートの回答には、あなたの名前が公開されません。詳しくは、以下のウェブアドレスまでアクセスしてください。

www.acnielsen.aim.dk/LEGO



LEGO

Designer Set

4882



4883



4886



©2004 The LEGO Group.

4262920



www.LEGO.com/create