

LEGO SYSTEM™

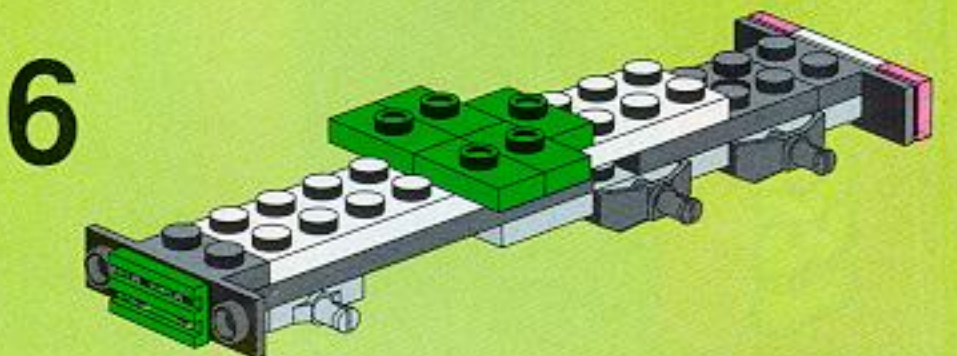

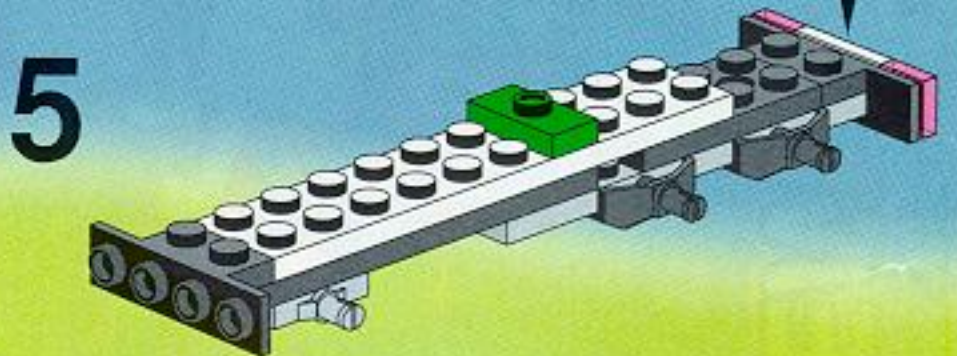

7

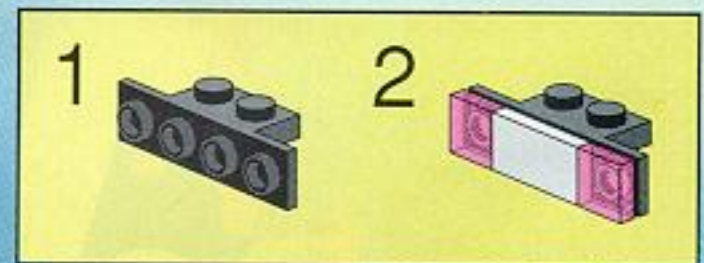
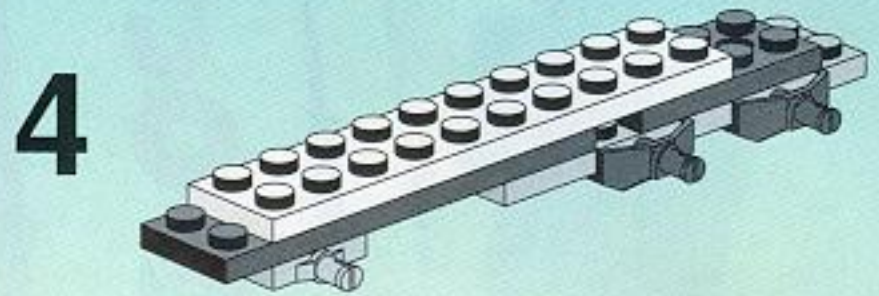
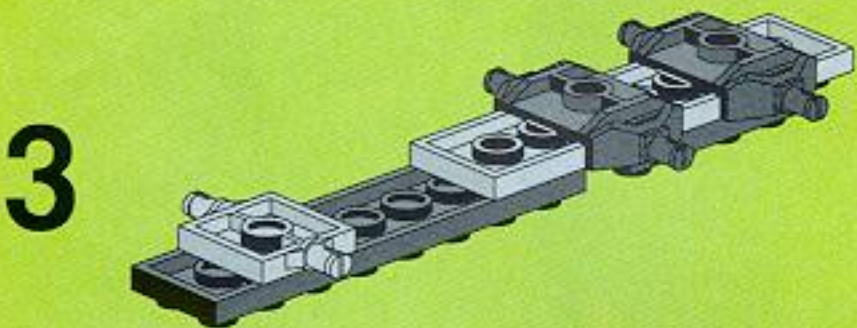
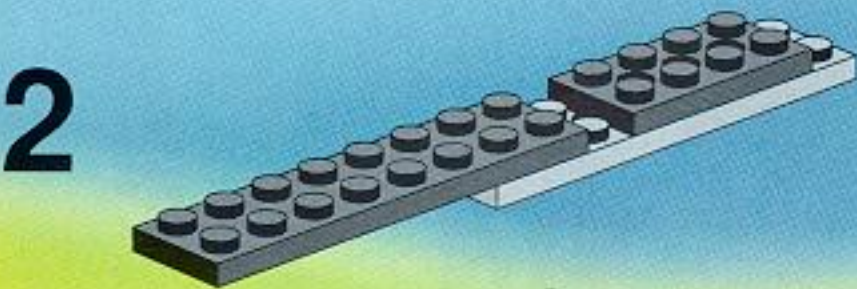
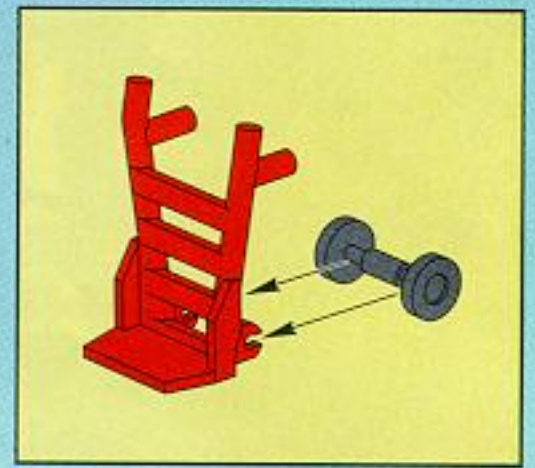
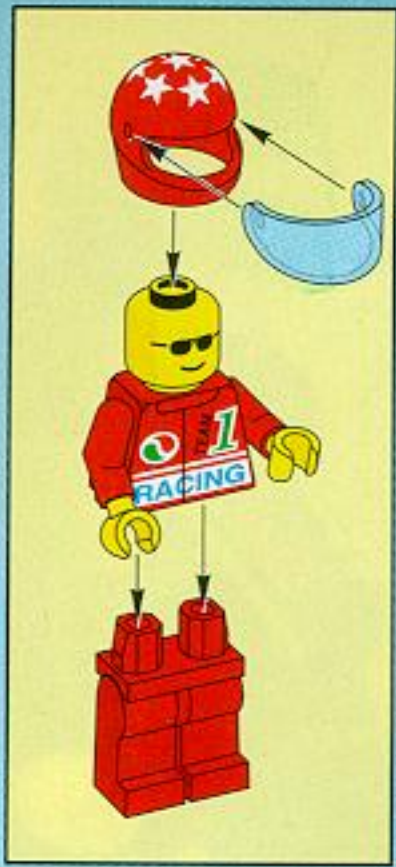
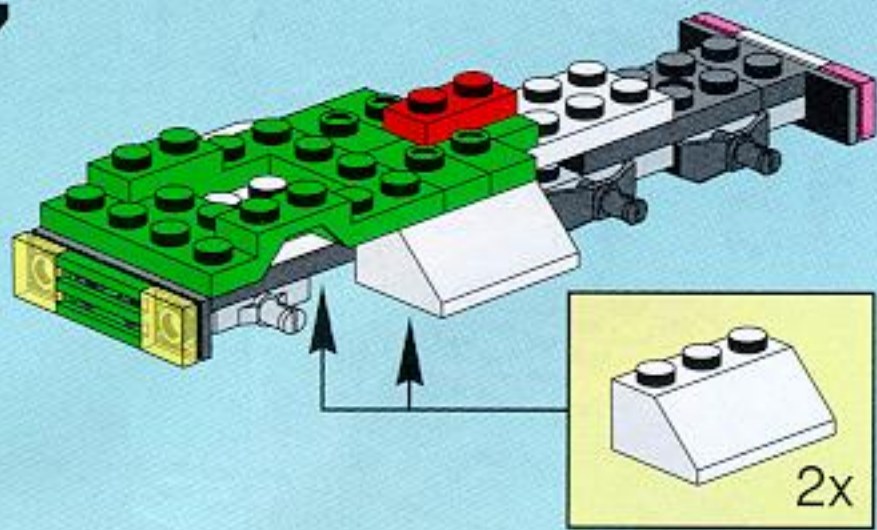

10

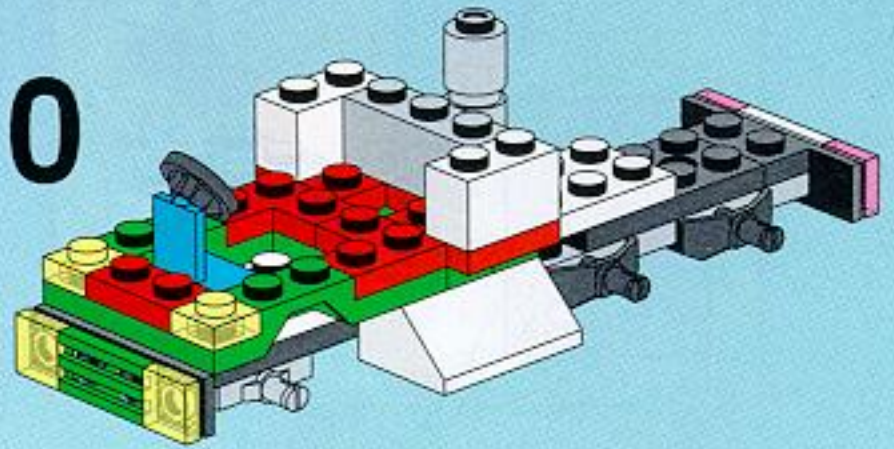

8

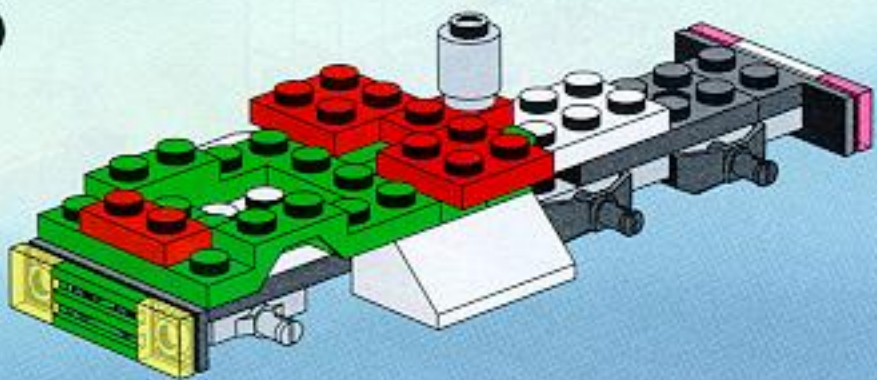

11

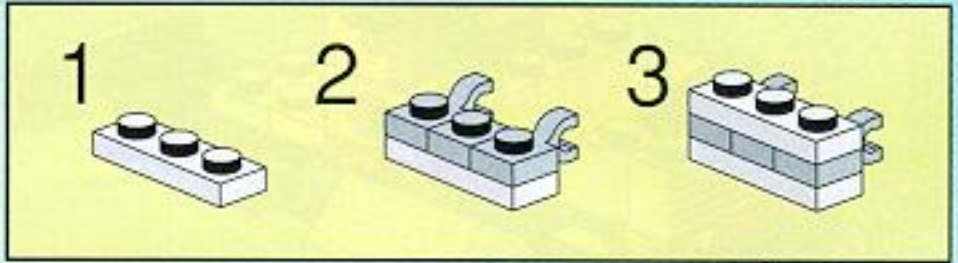
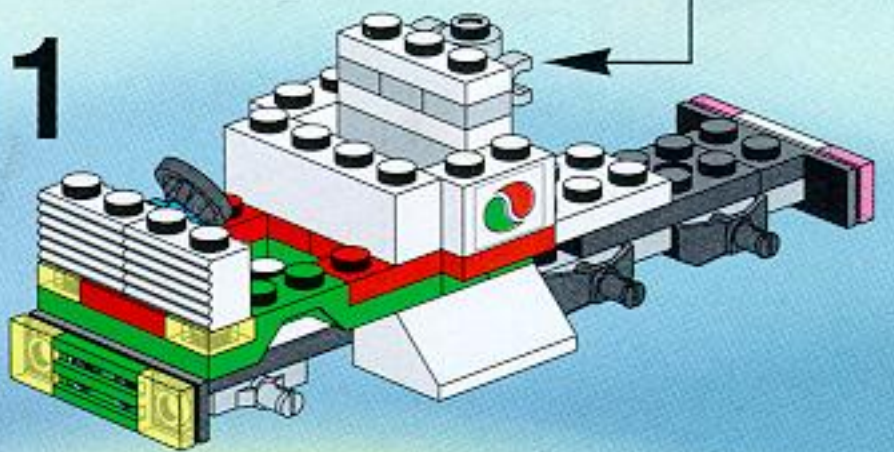

9

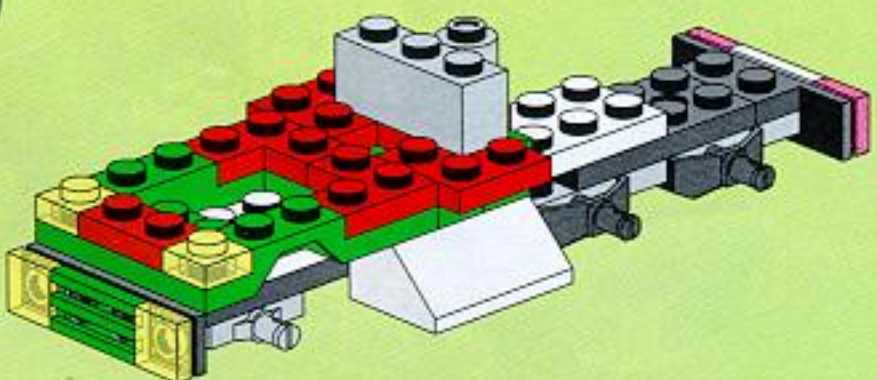

12

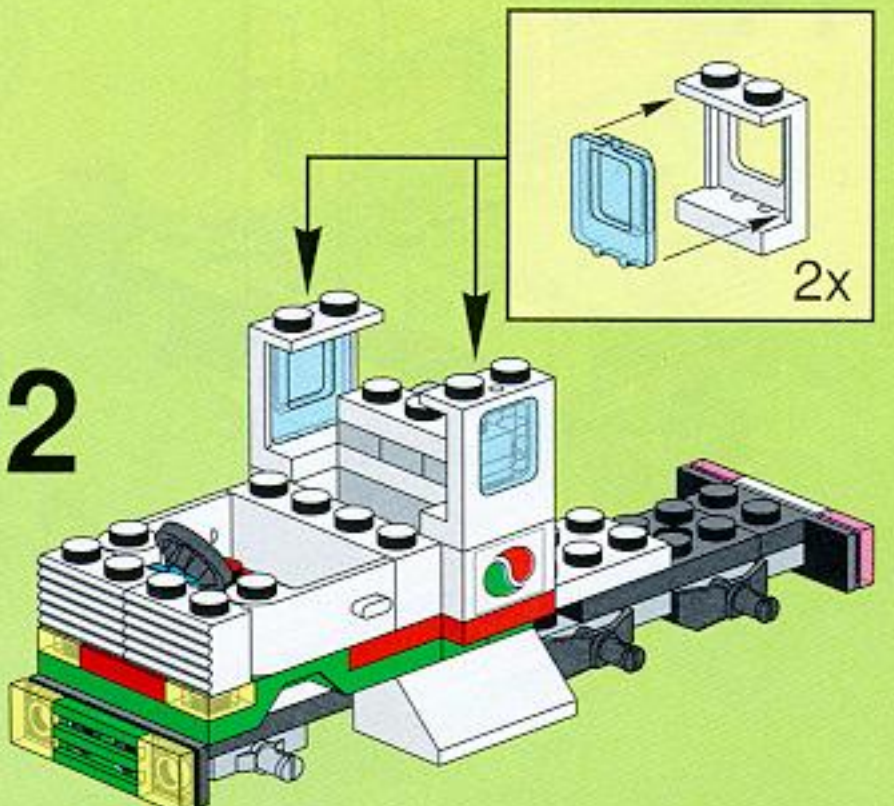

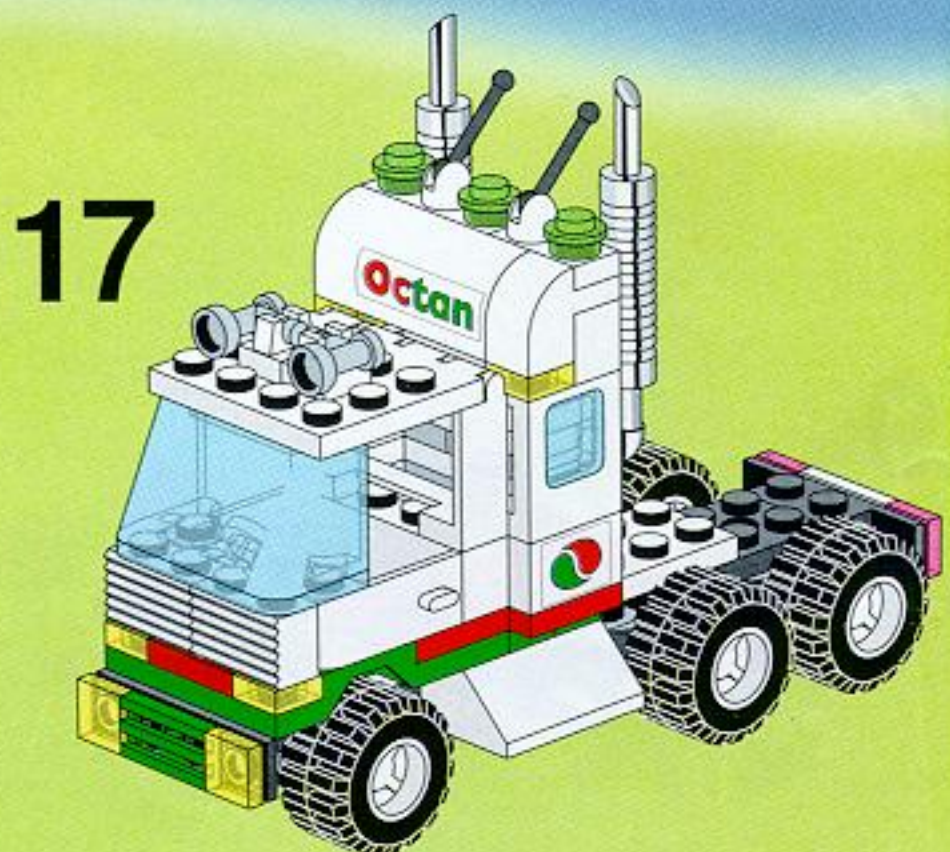
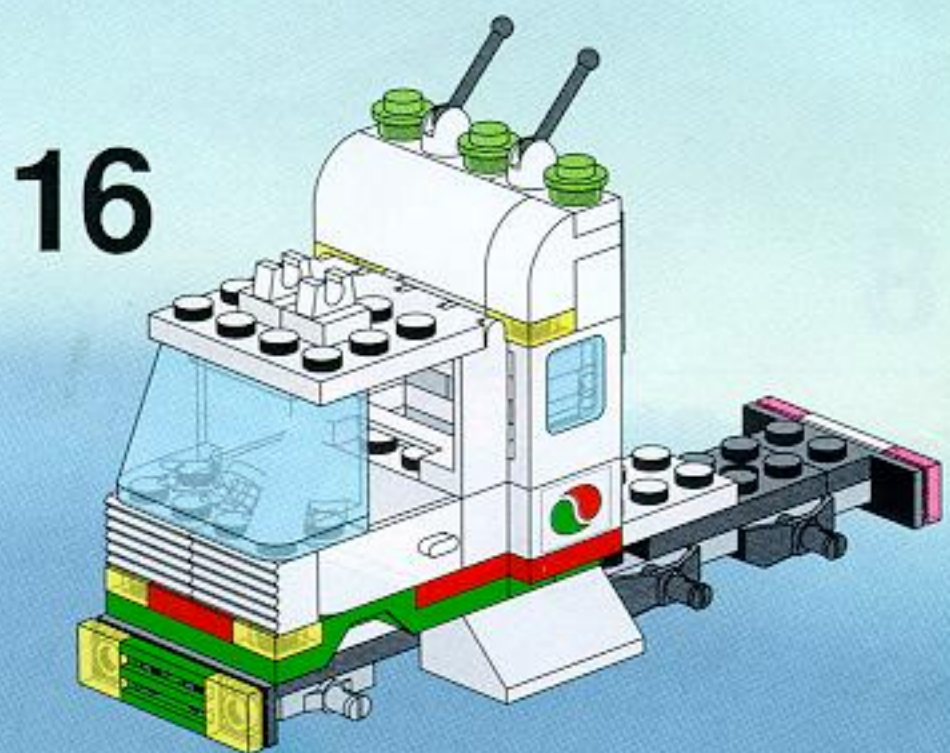
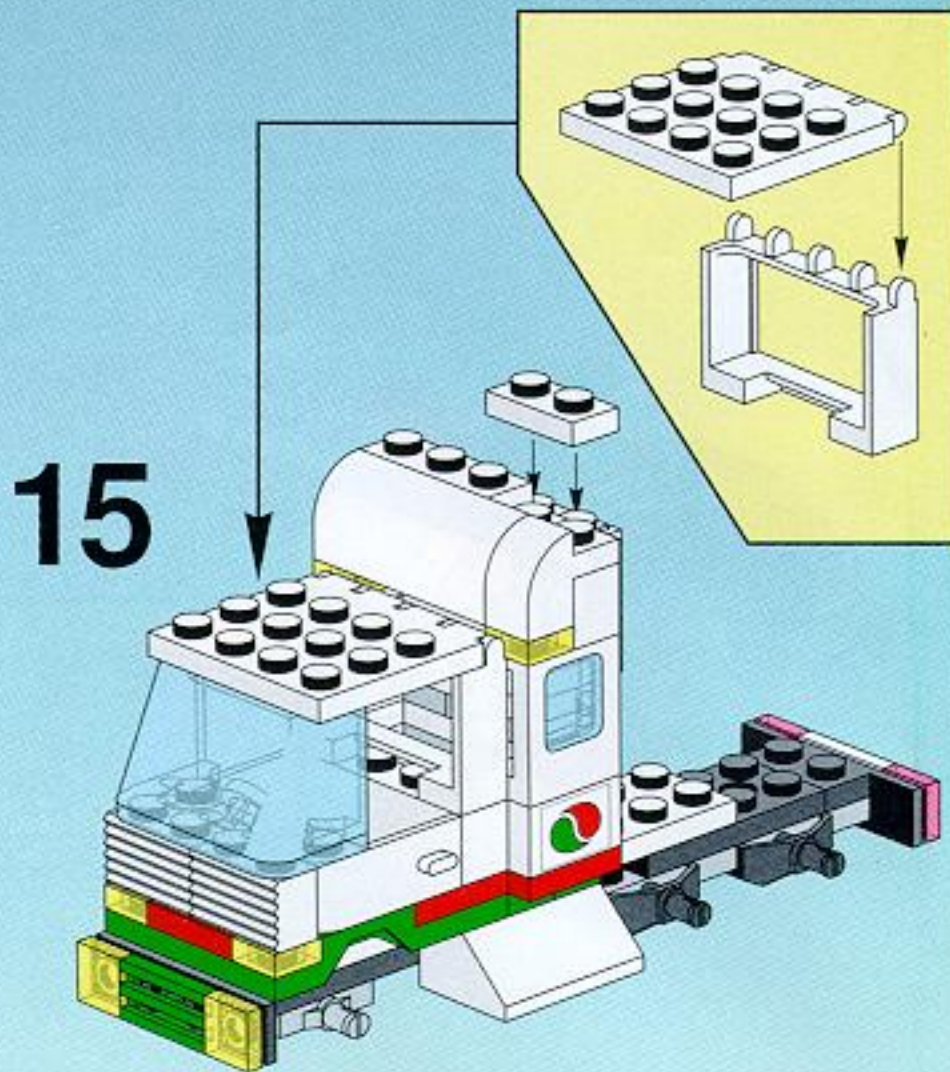
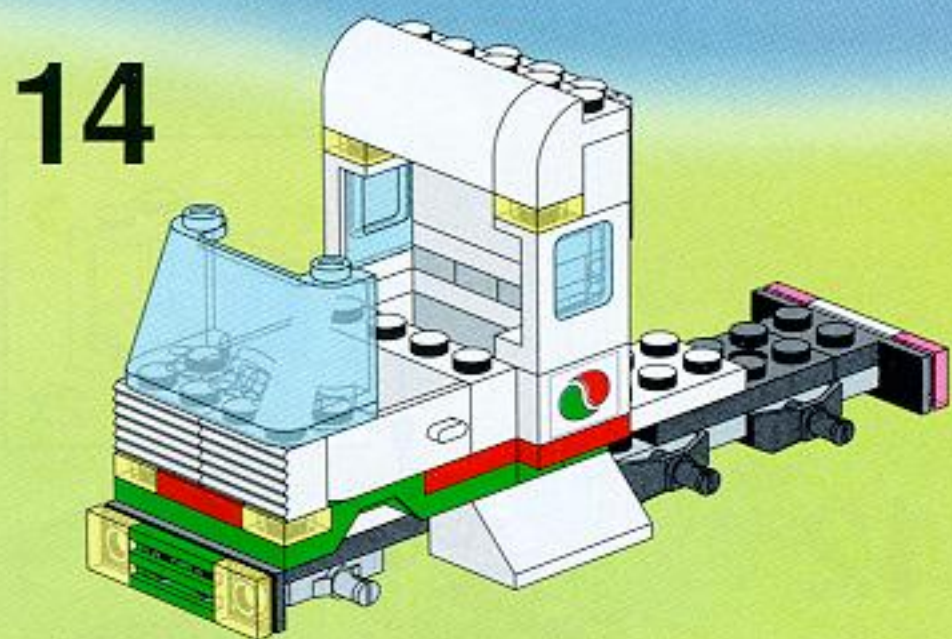
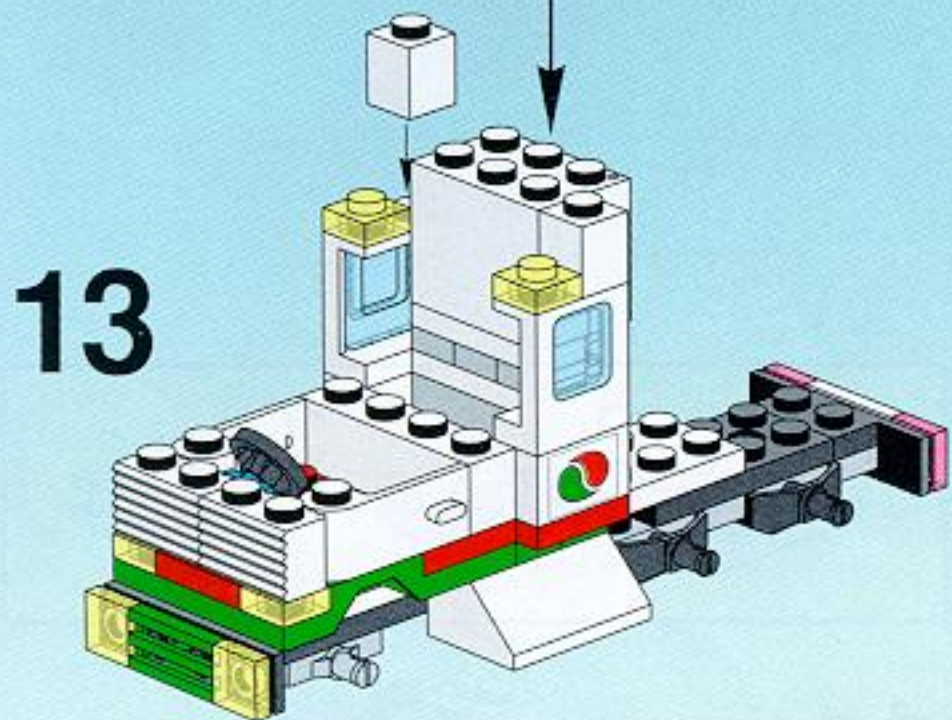
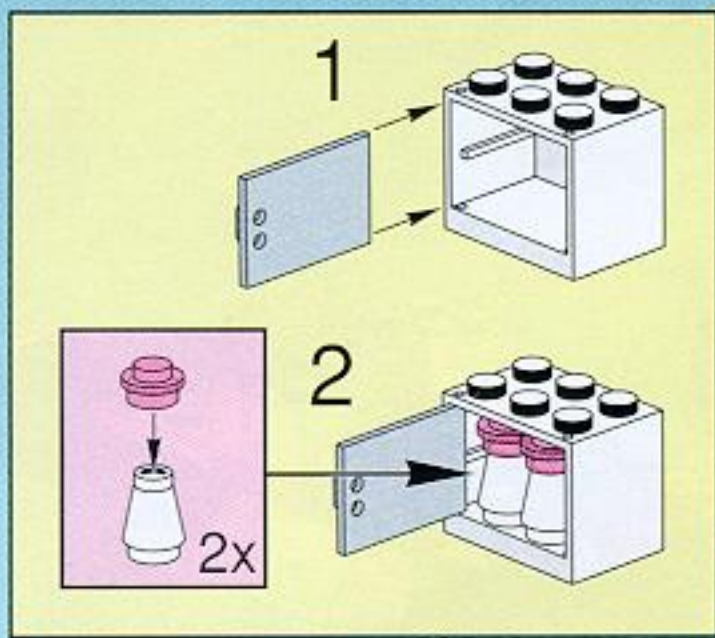

1

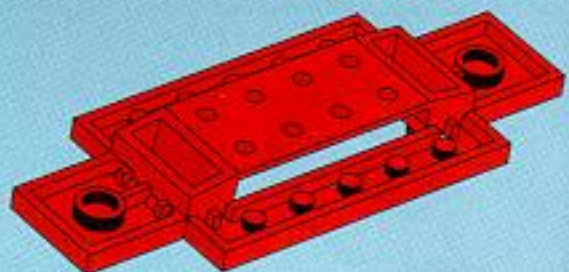

2

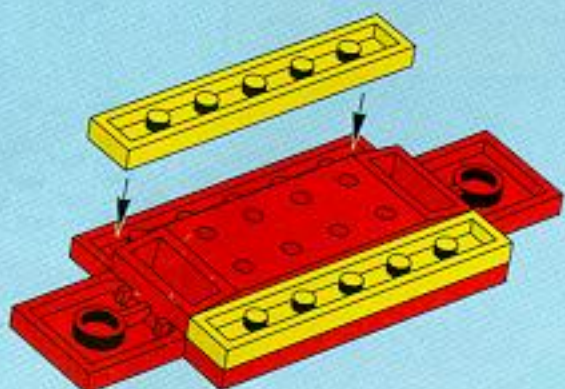

3

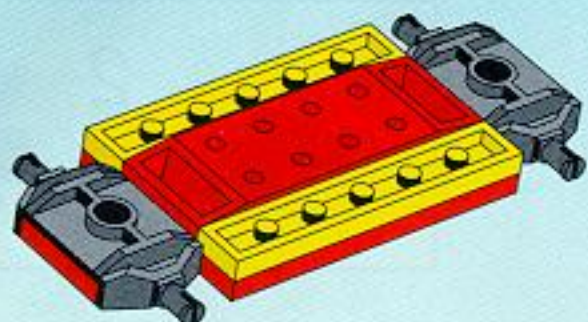

4



5

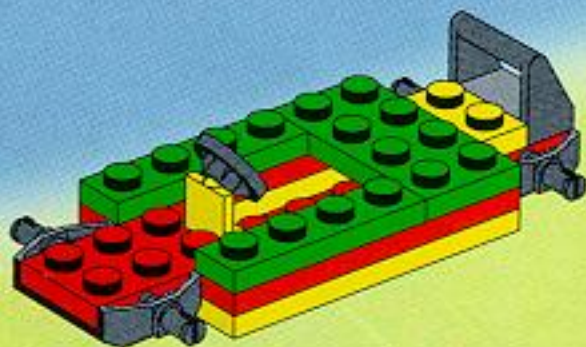

6

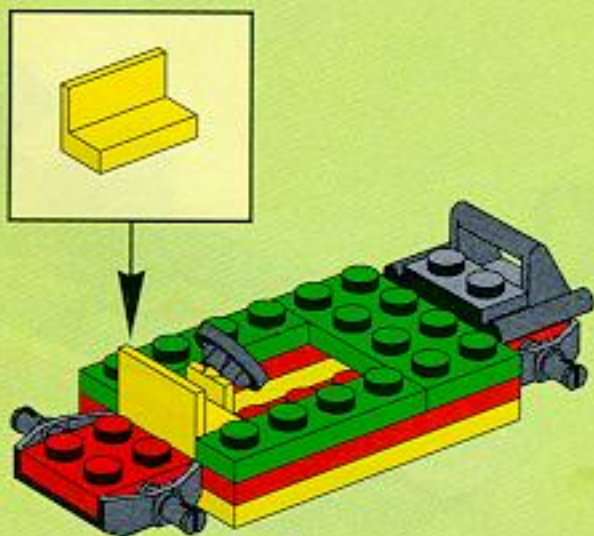

7

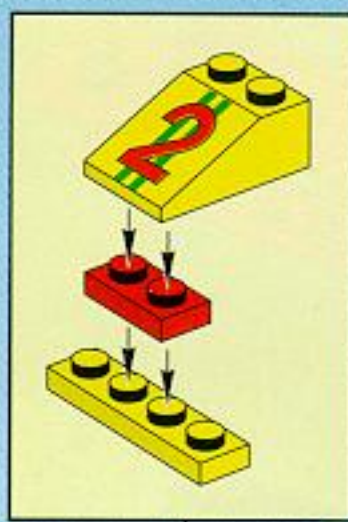

8

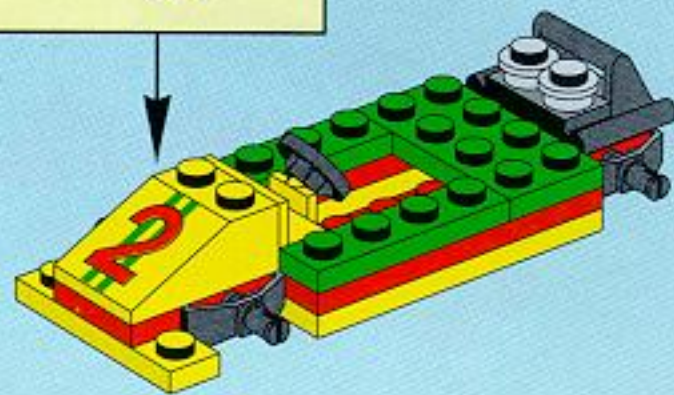

9

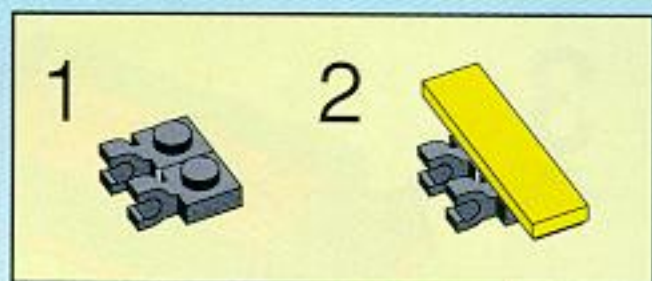

10

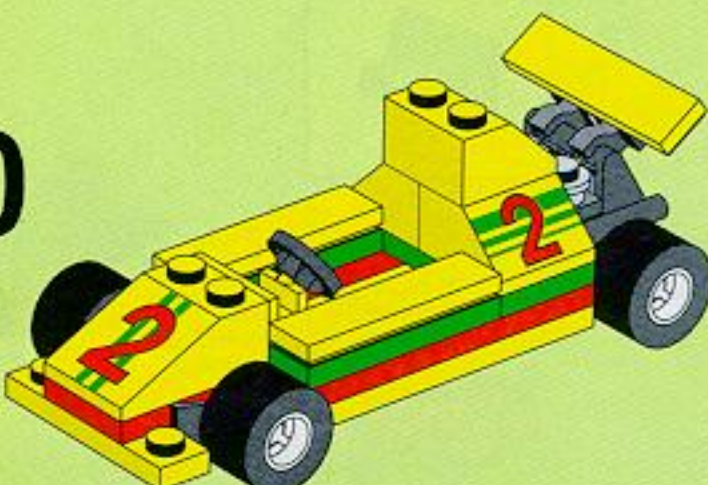
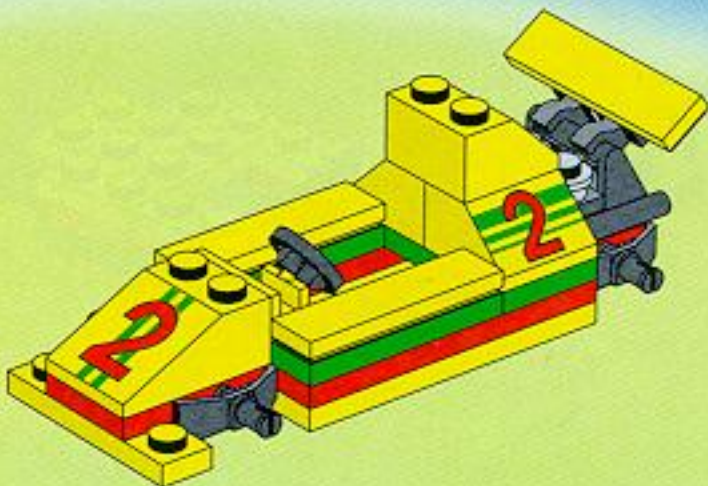
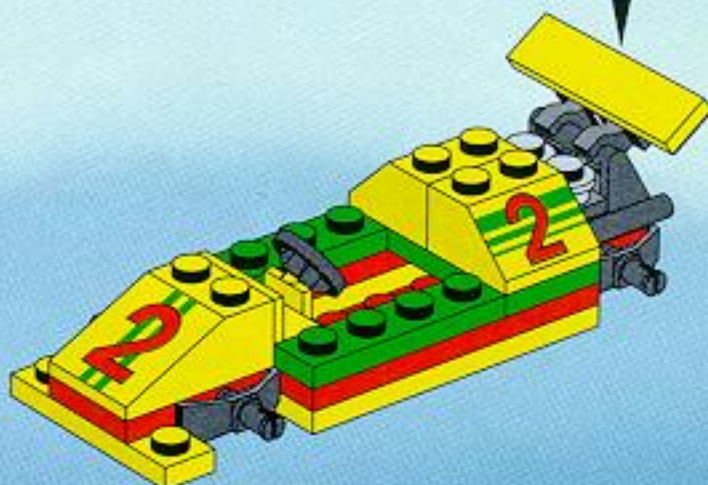

1

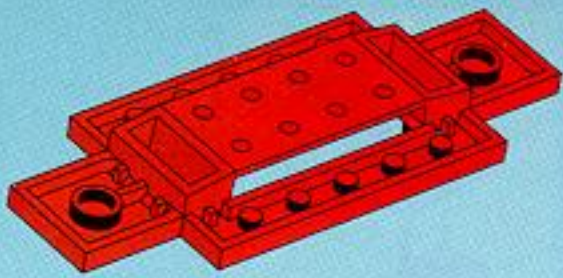

2

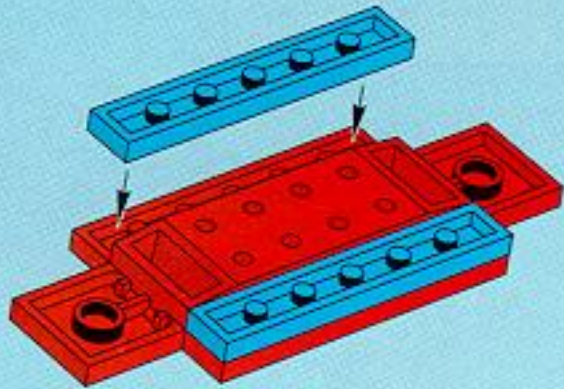

3

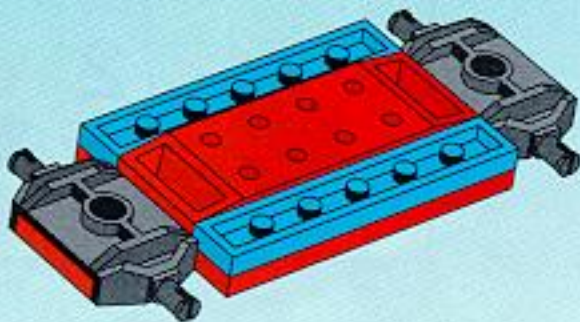

4

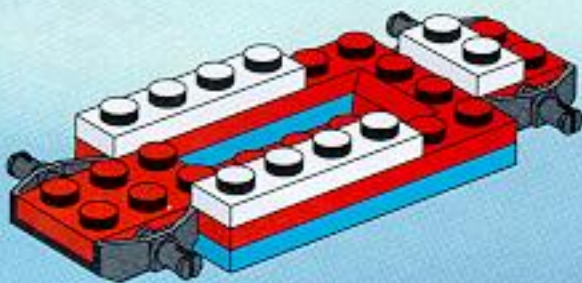

5

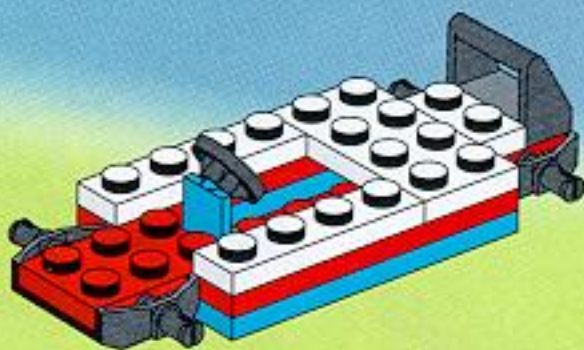

6

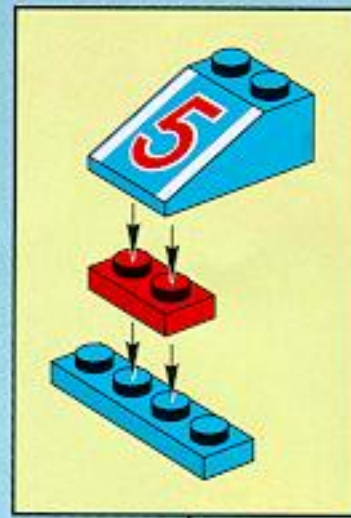
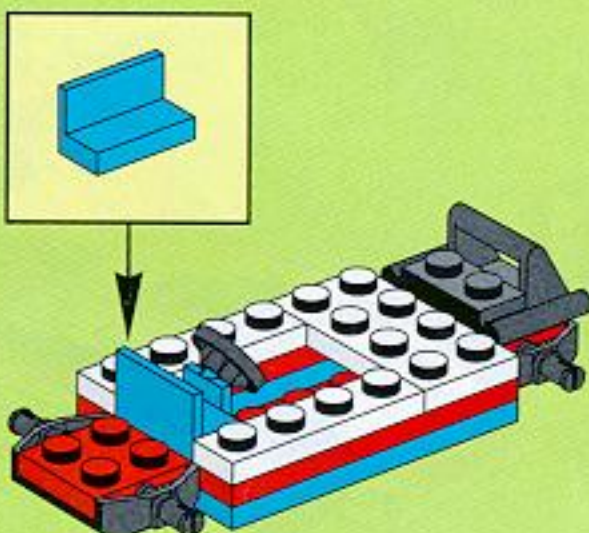

7

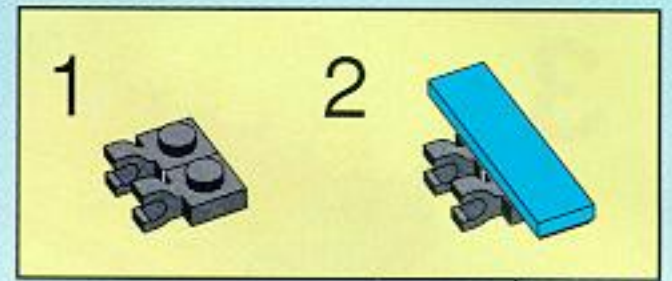
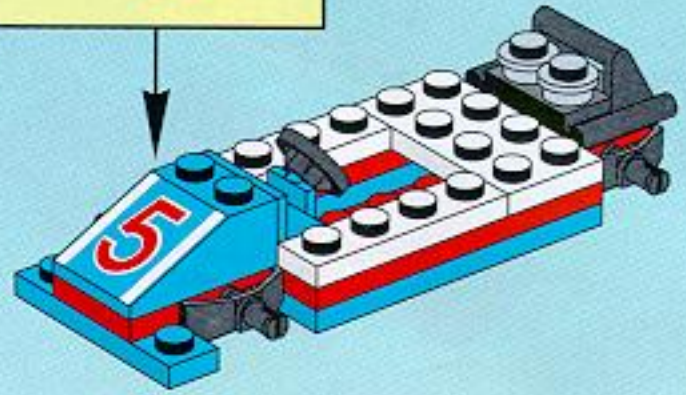

8

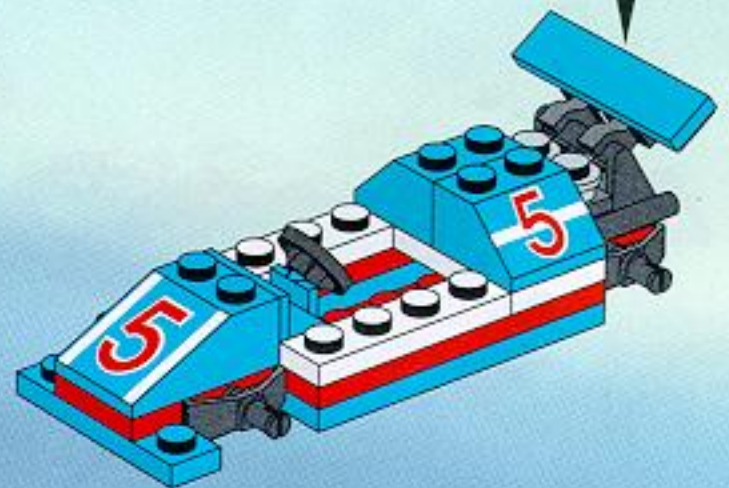

9

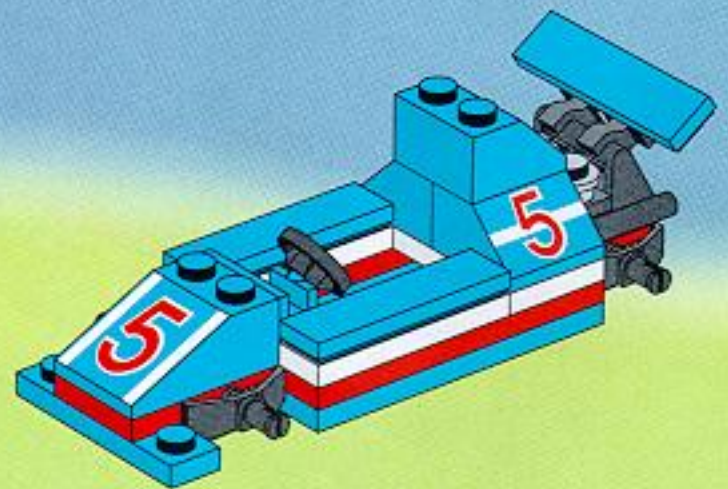

10

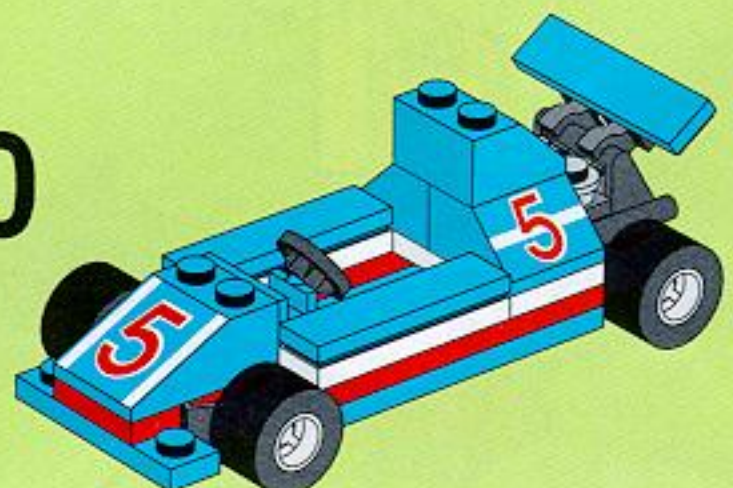

1

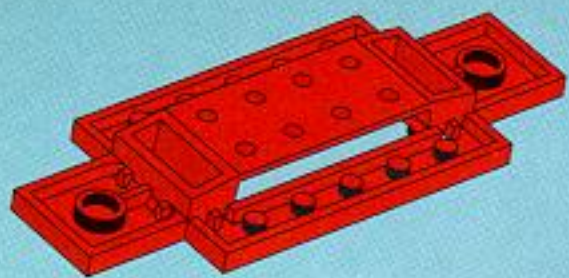

2

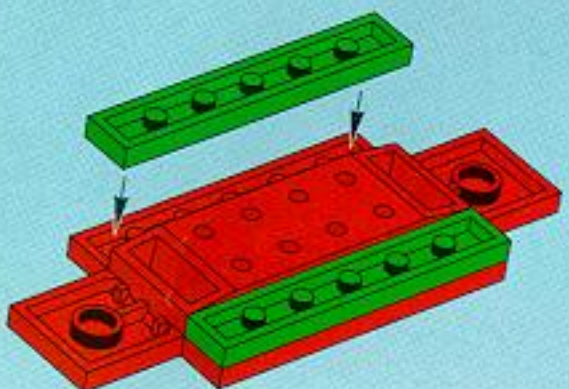

3

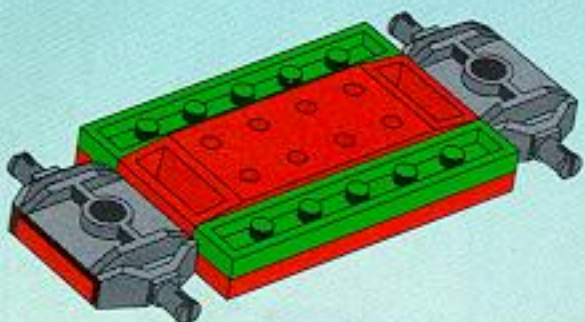

4

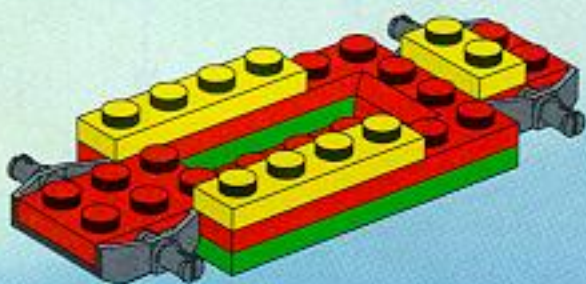

5

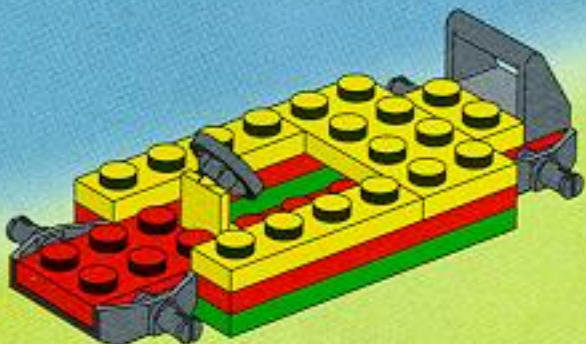

6

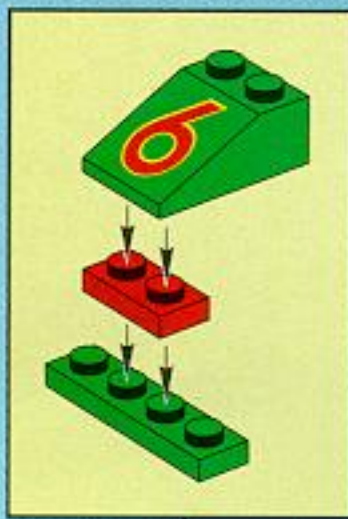
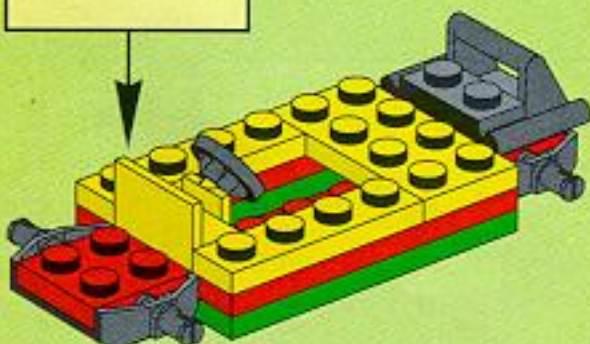
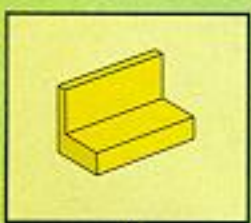

7

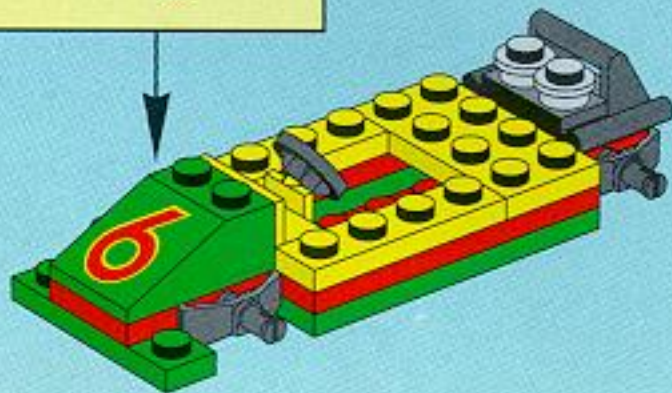

1



2



8

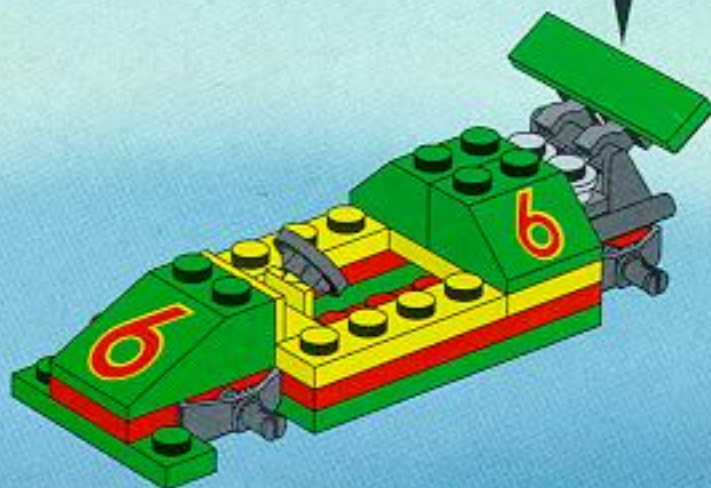

9

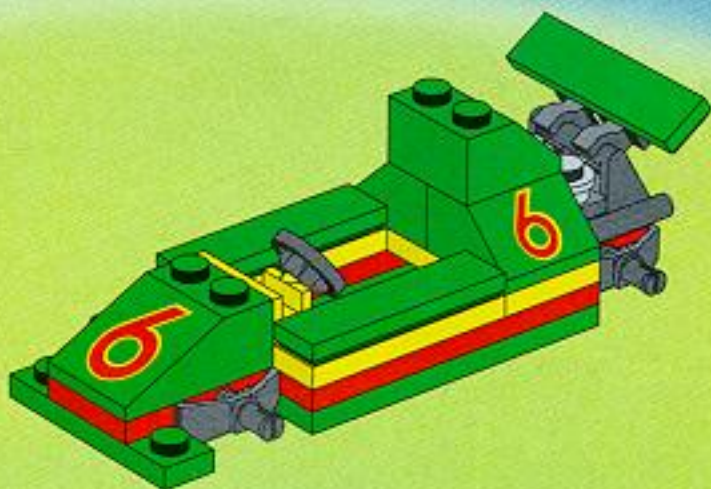

10

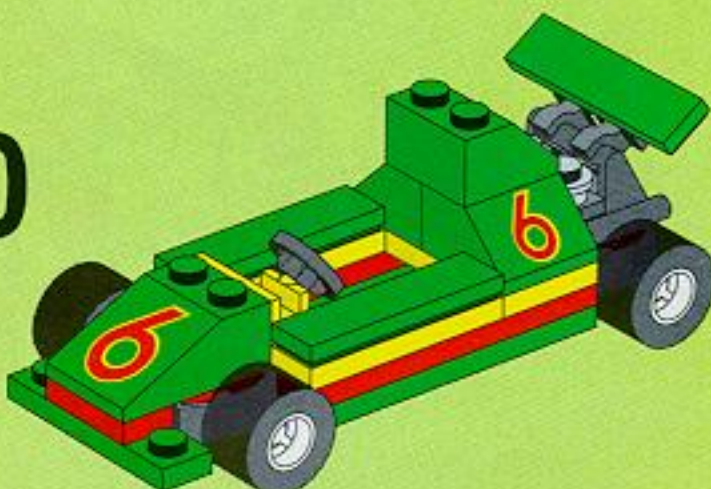

1

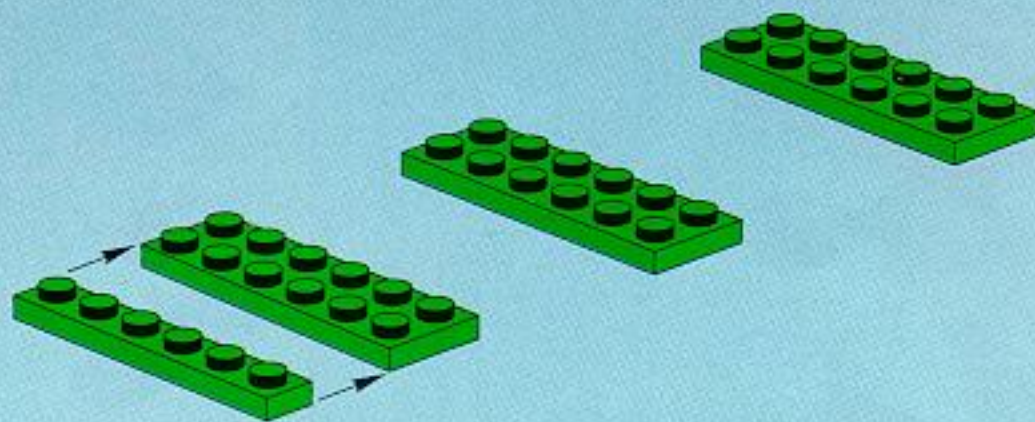

2

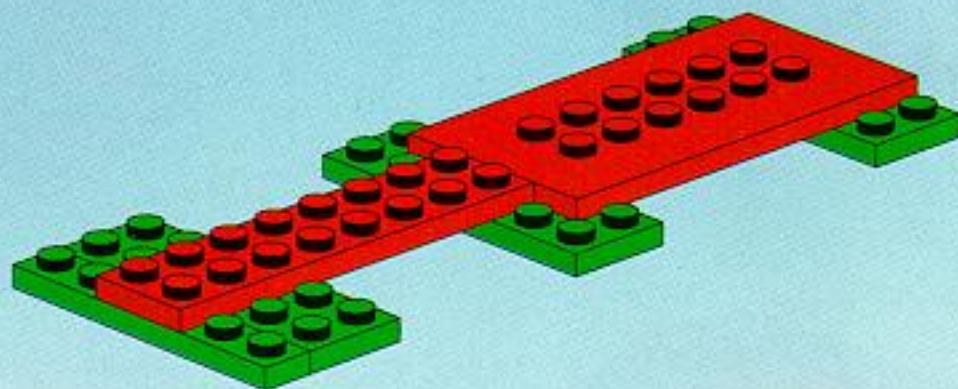

3

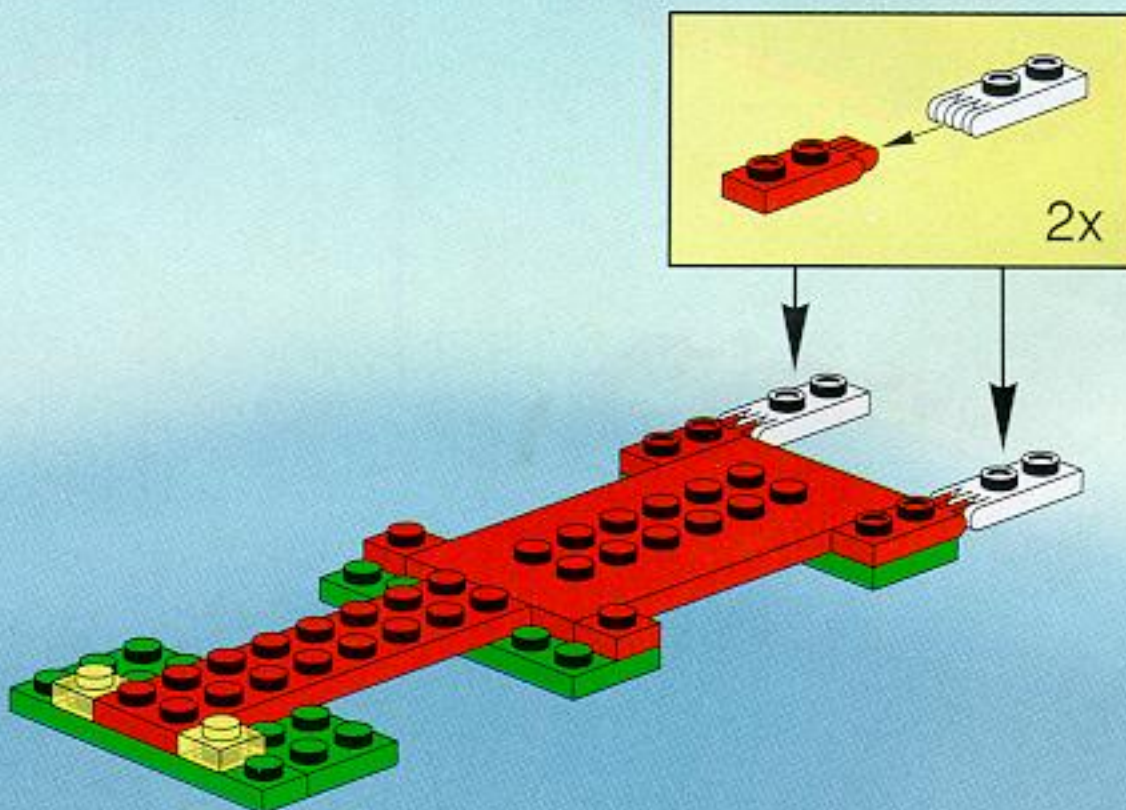

4

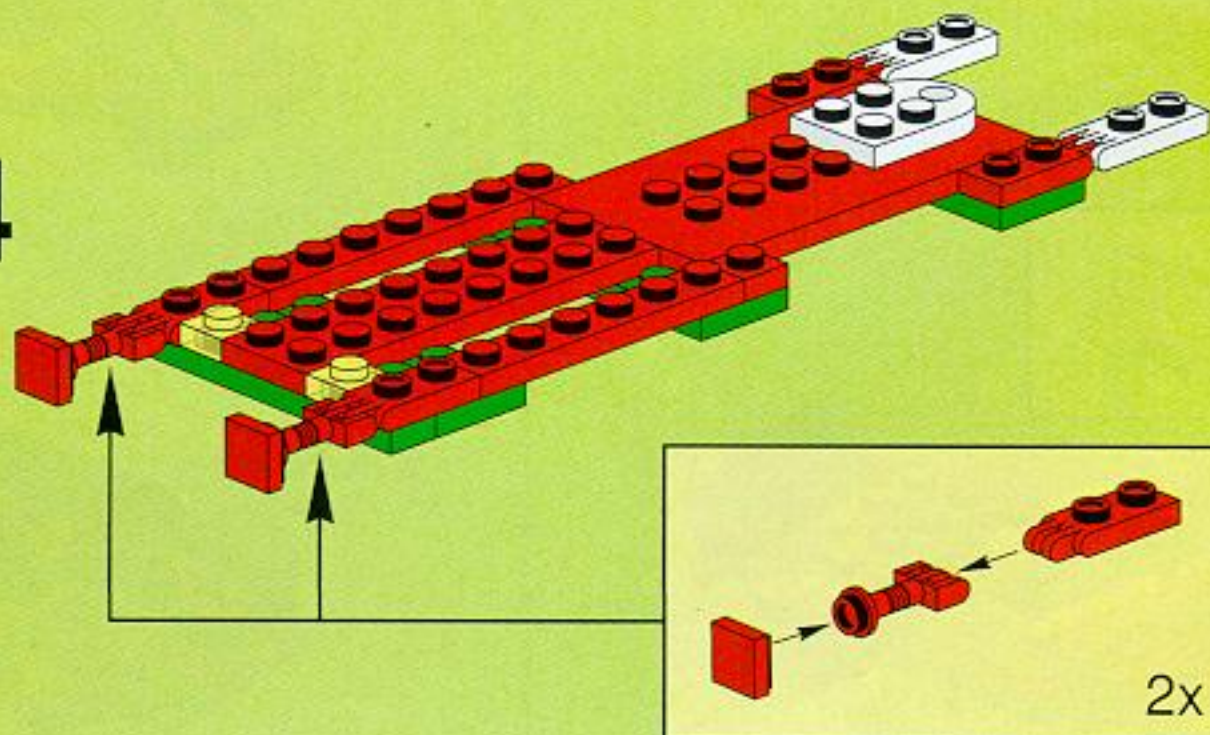

5

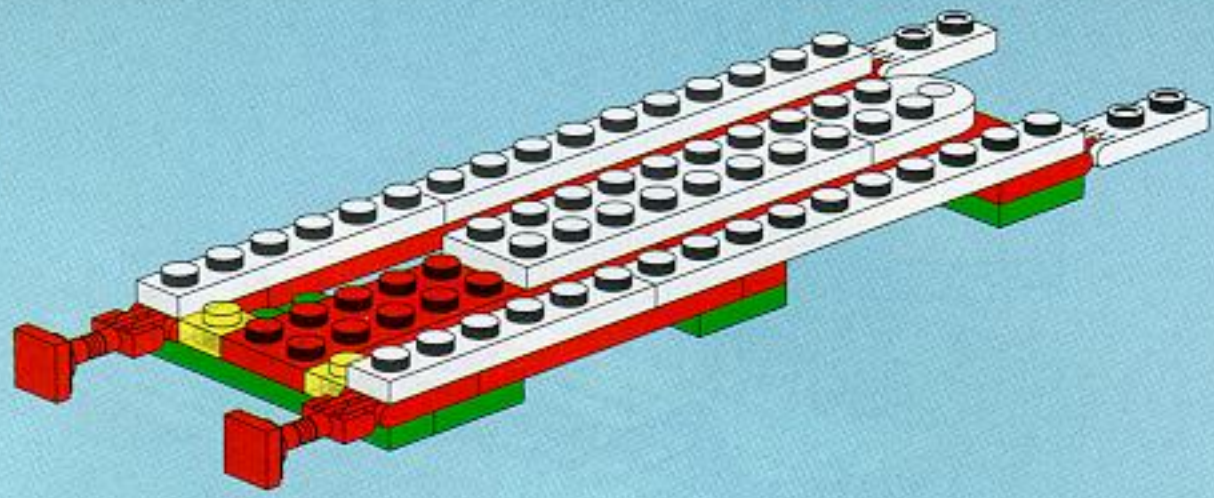

6

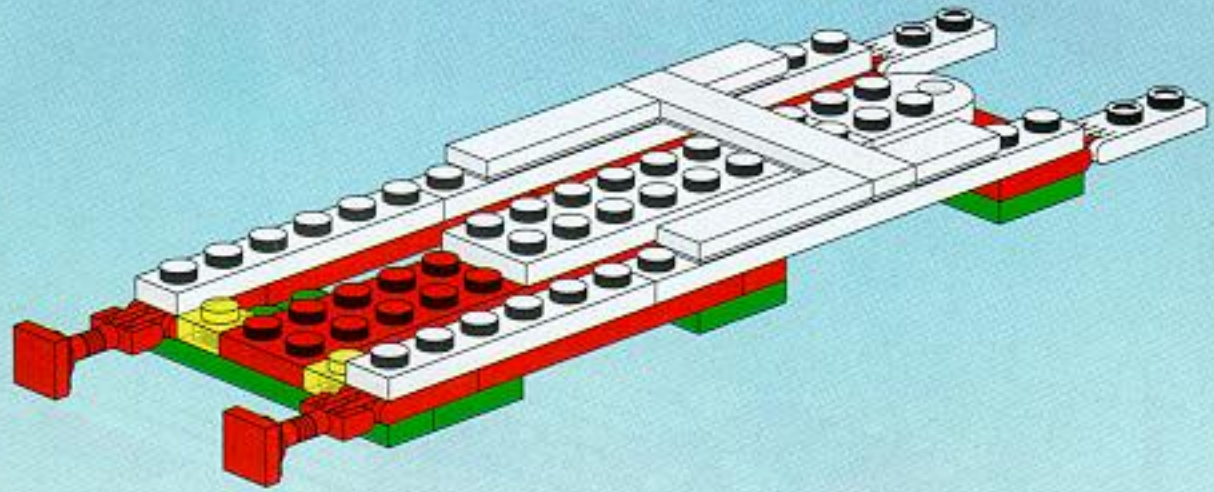

7

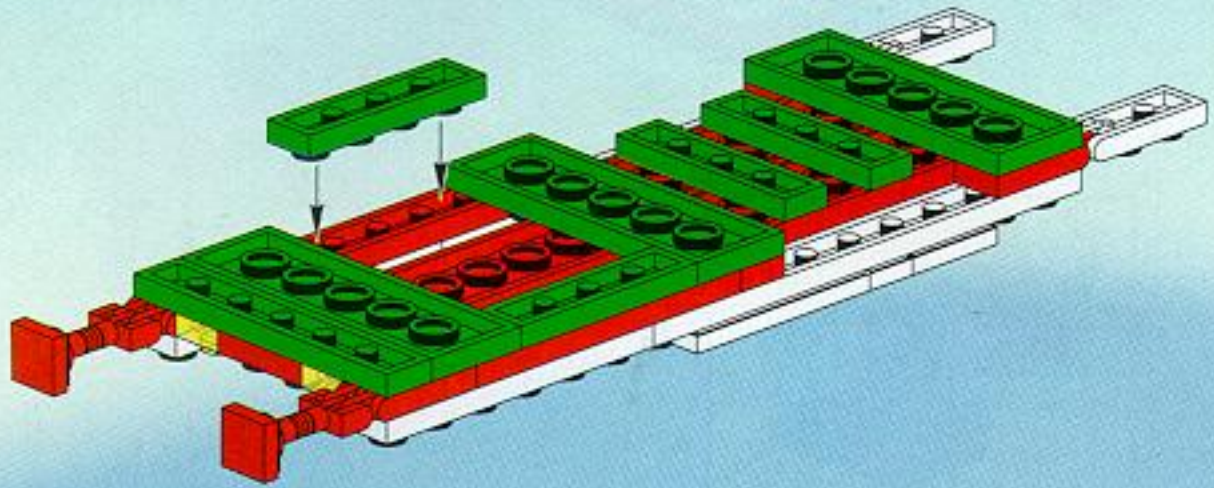

8

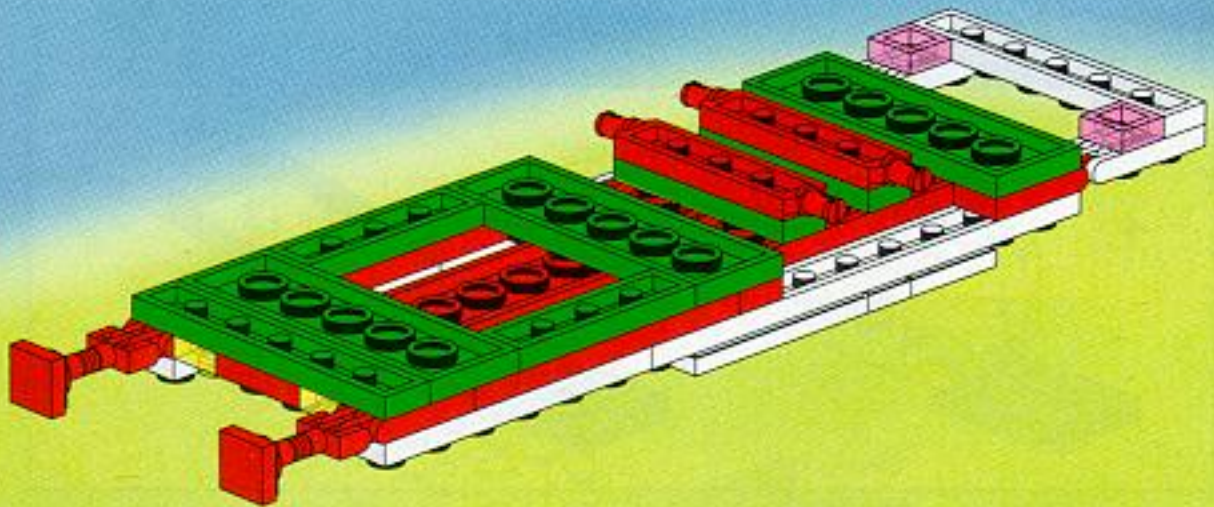

9

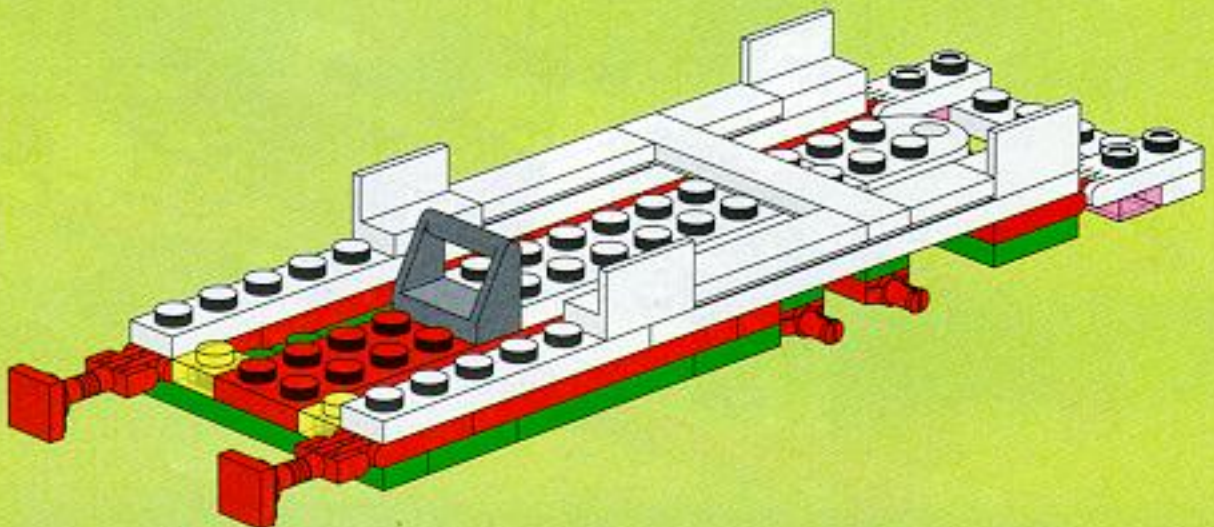

10

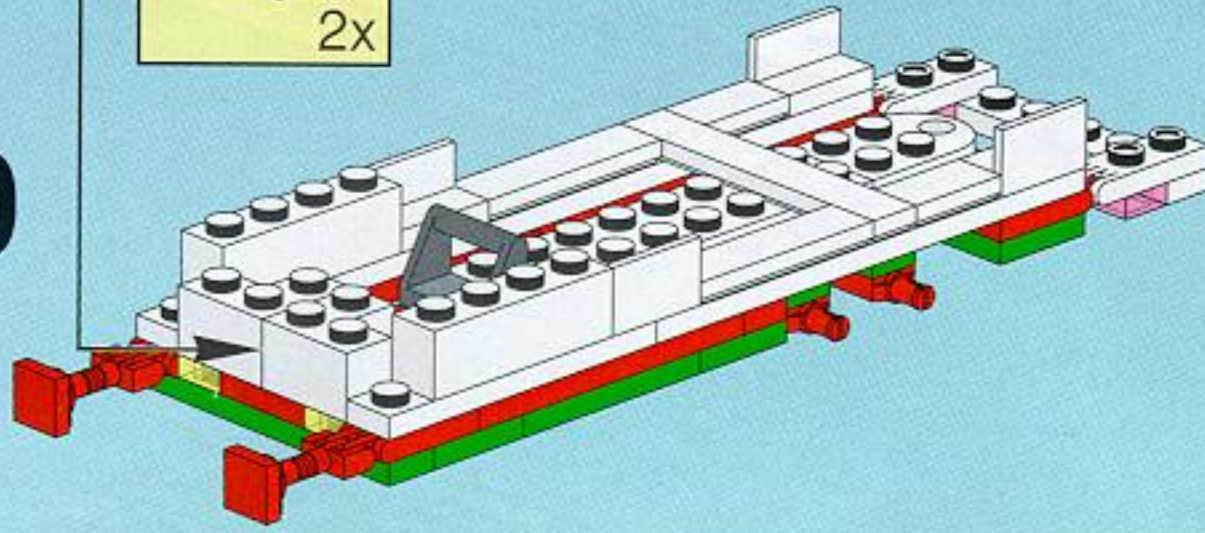
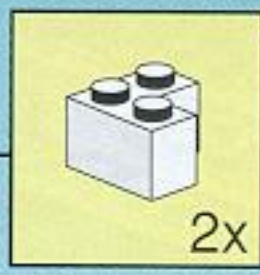

11

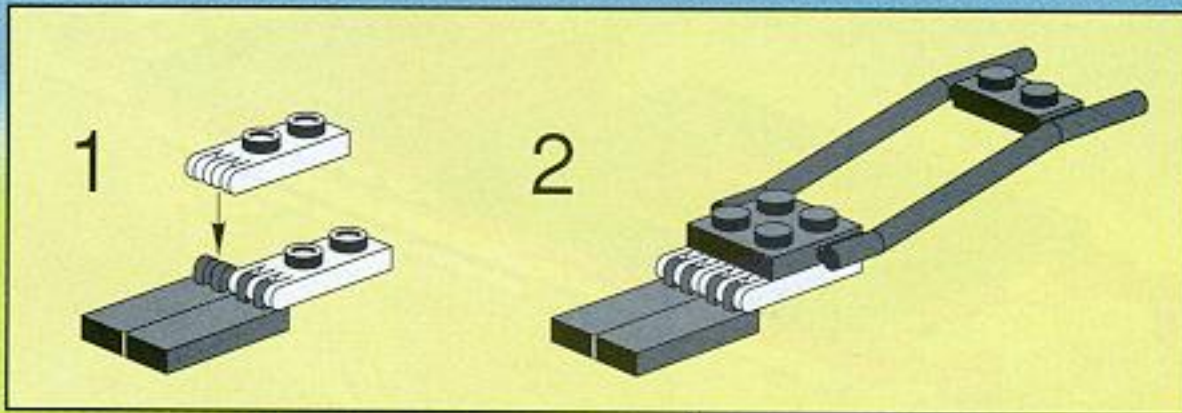
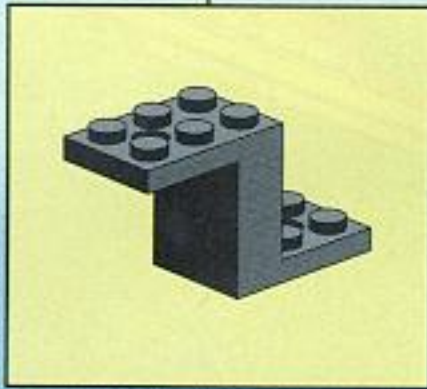
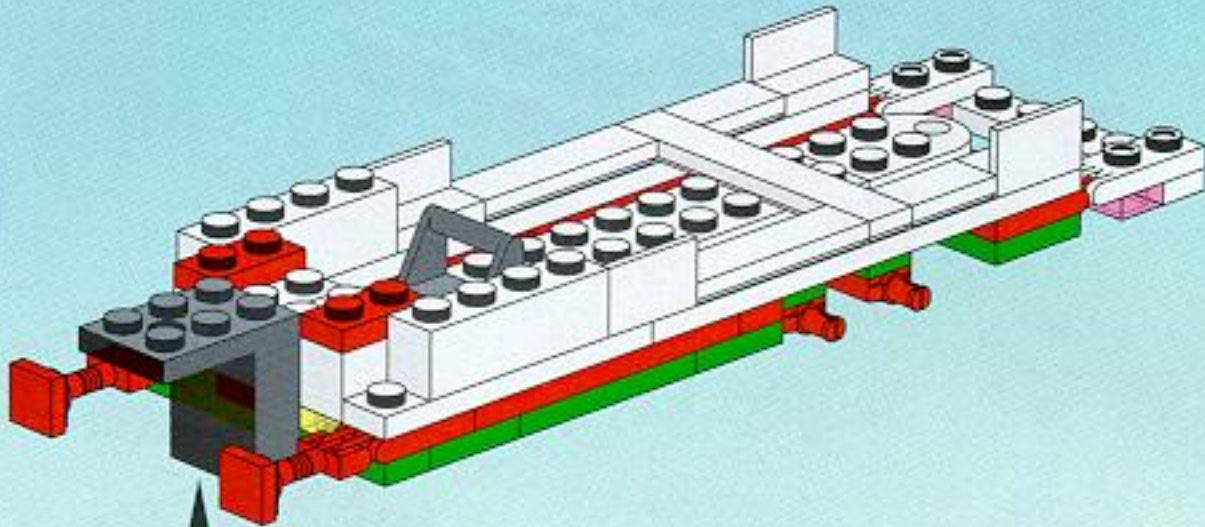

12

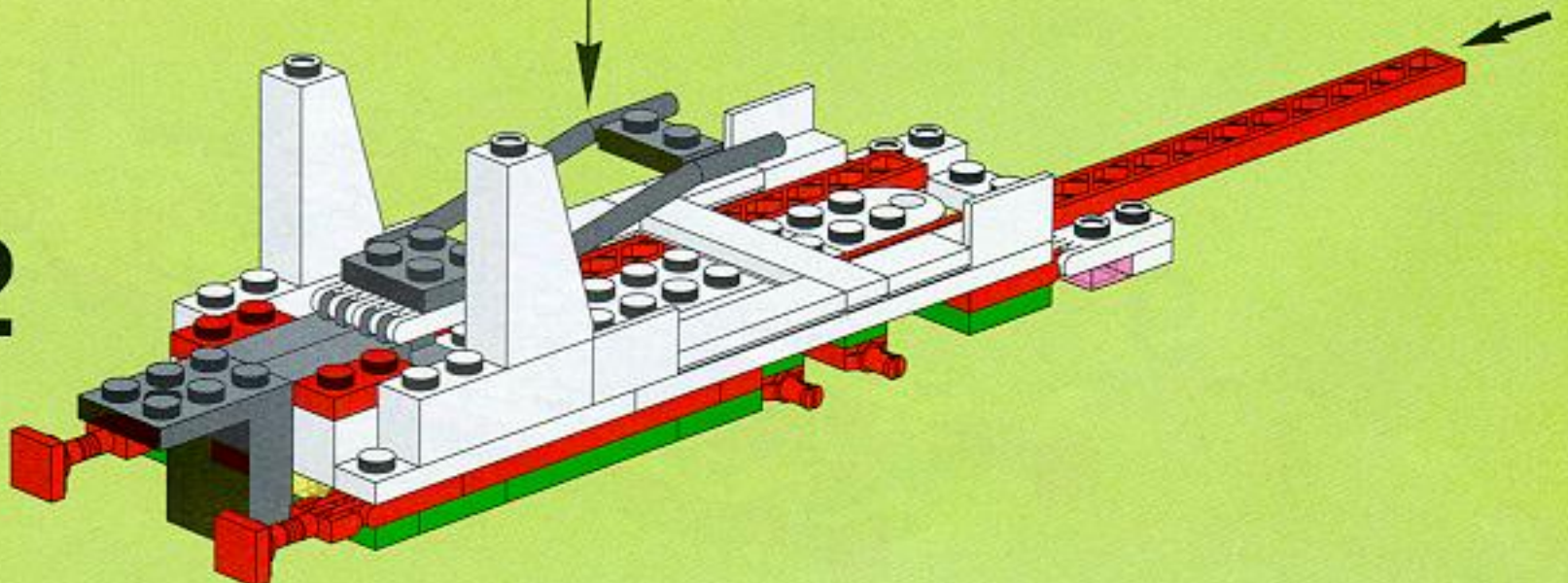

13

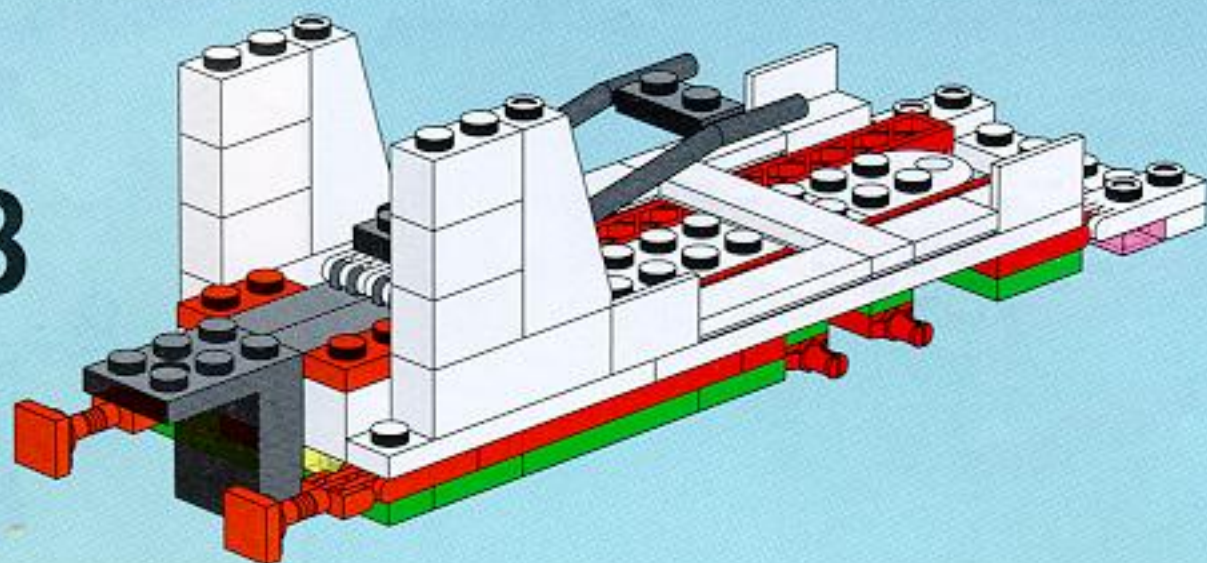

14

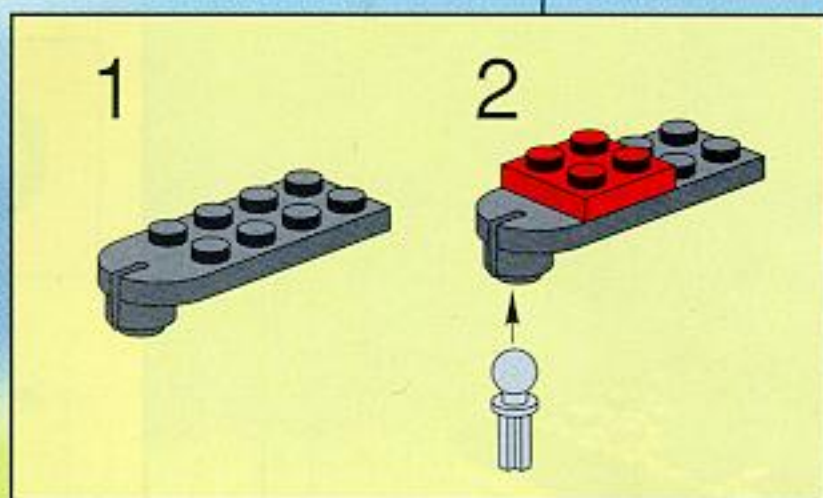
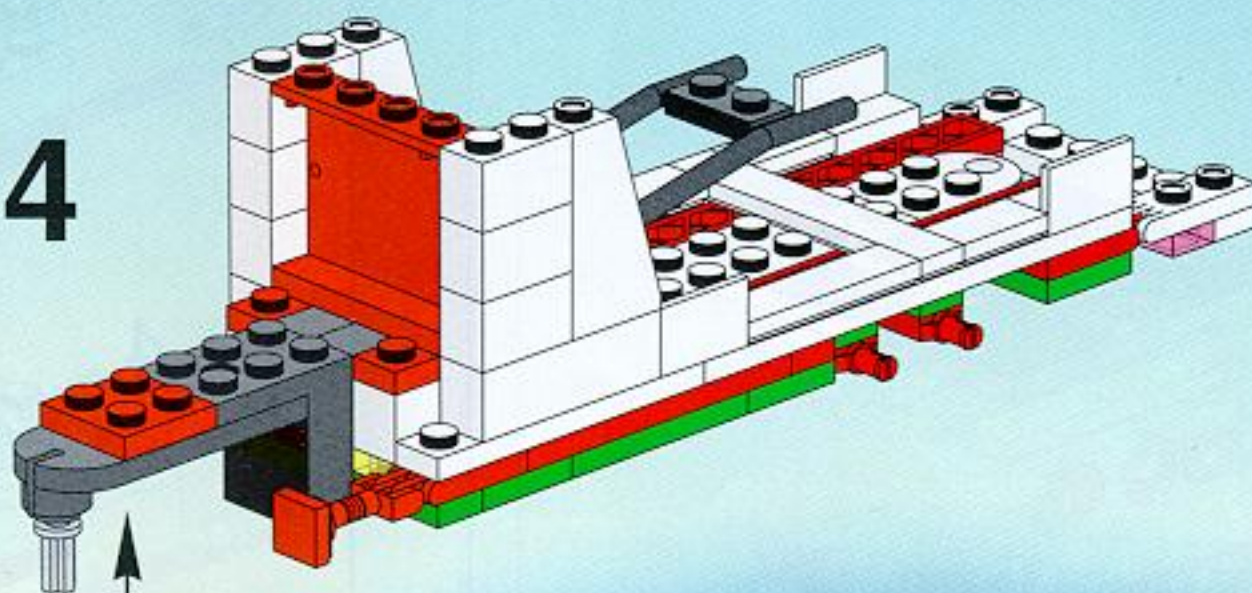

15

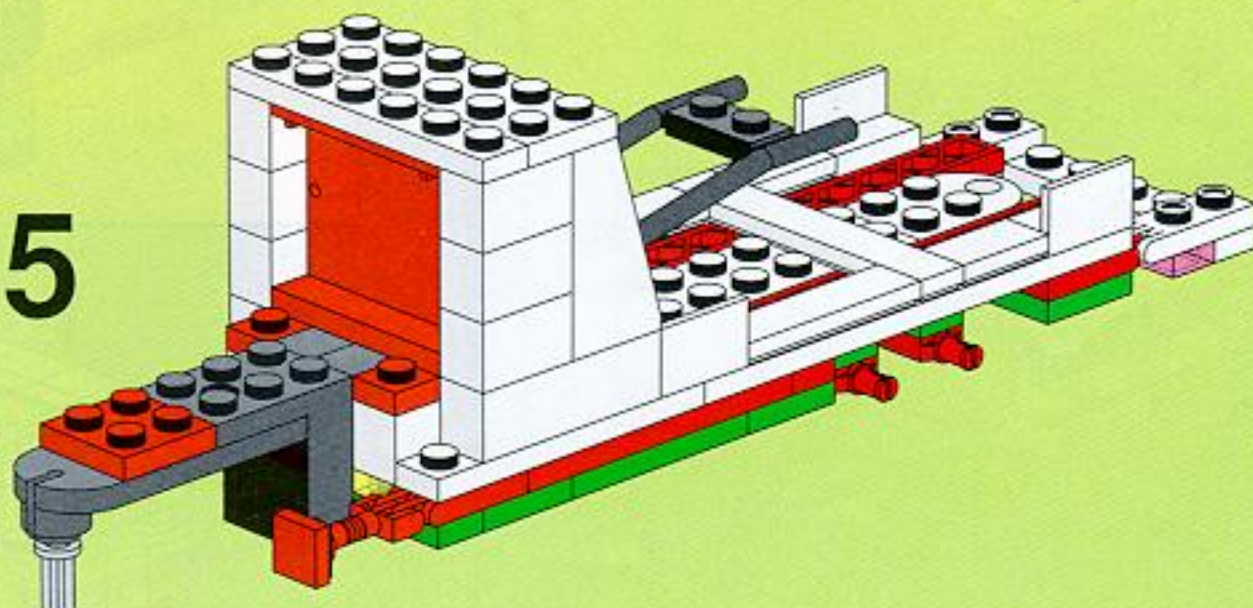

1



2

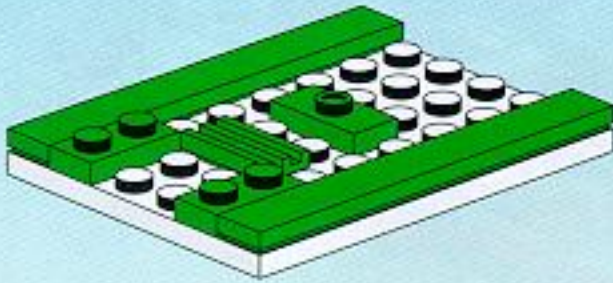

3

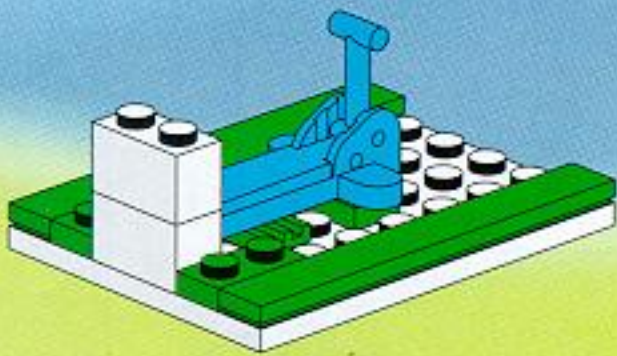

1

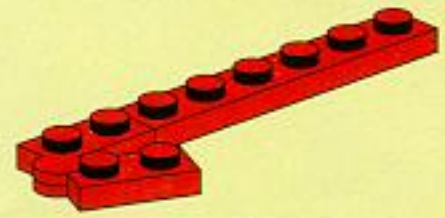

2

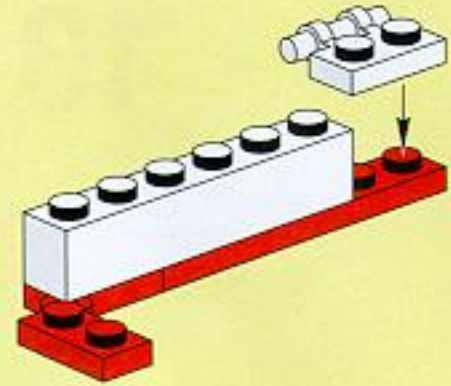

3

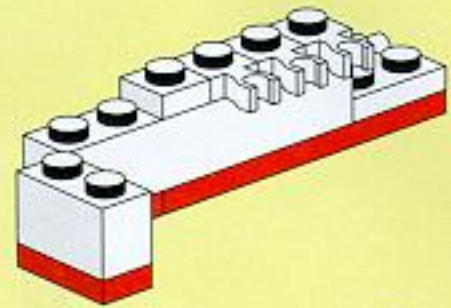

4

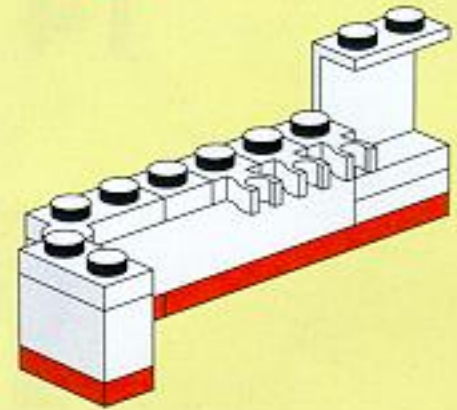

5

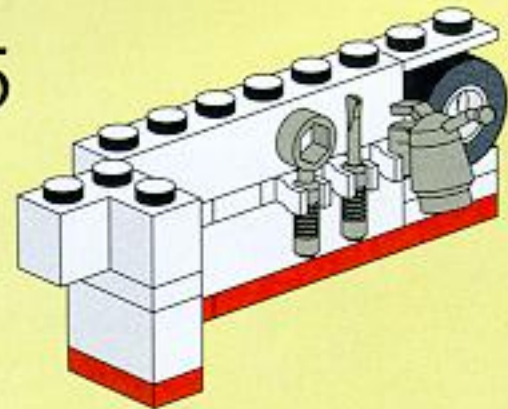

6

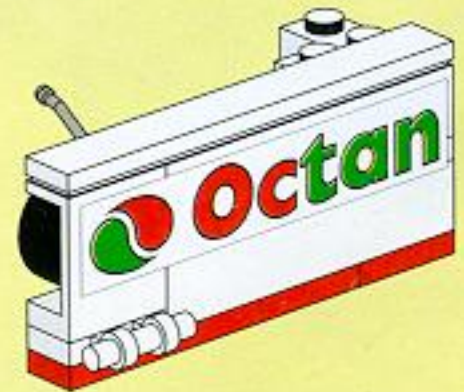

4

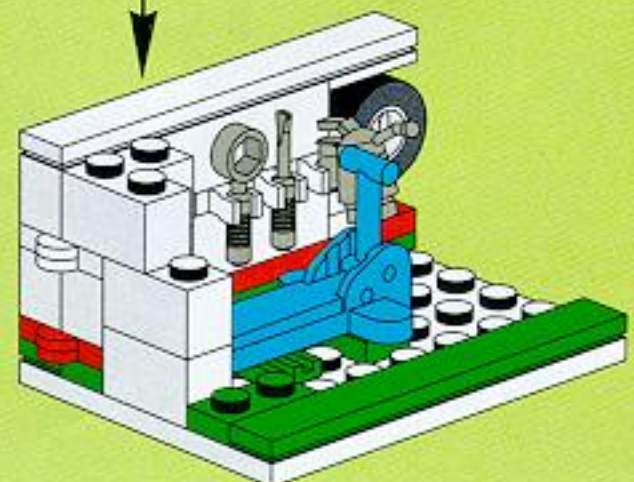

1

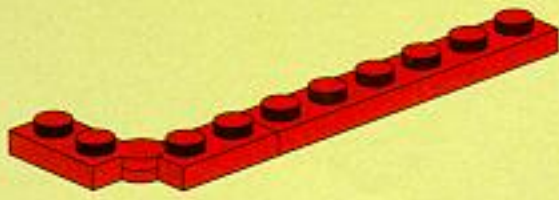

2

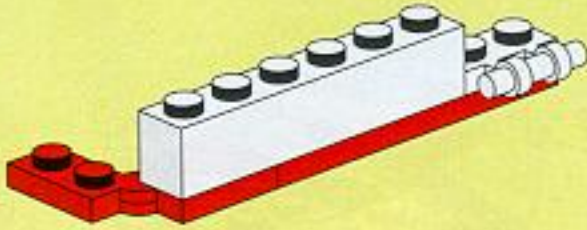

3

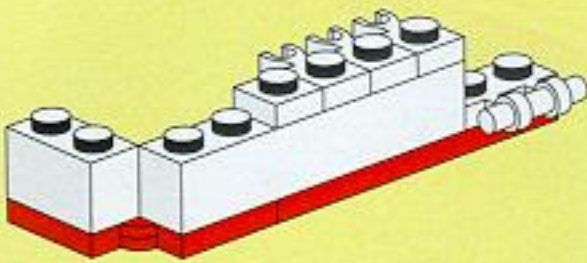

4

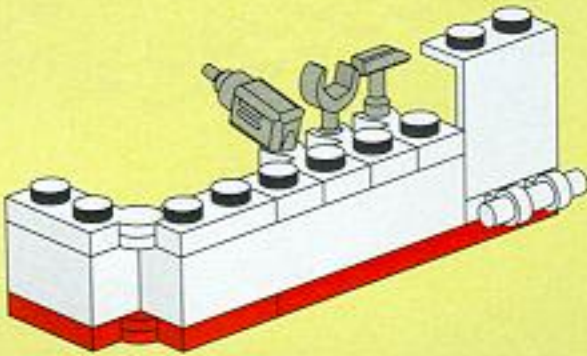

5

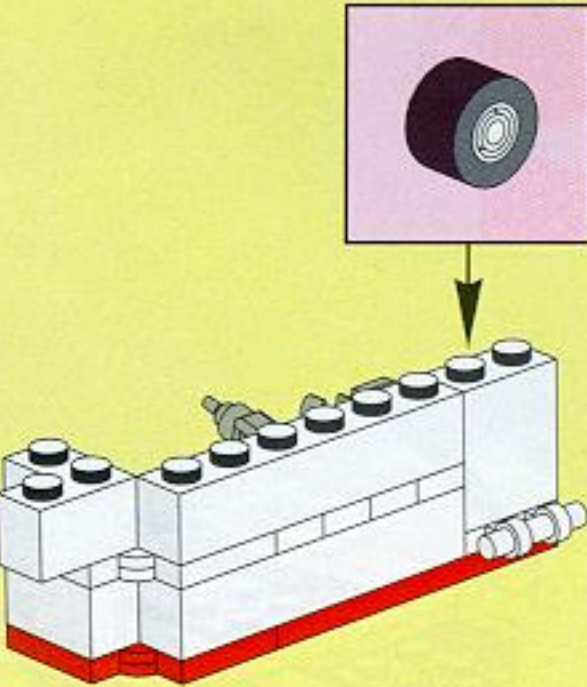

6

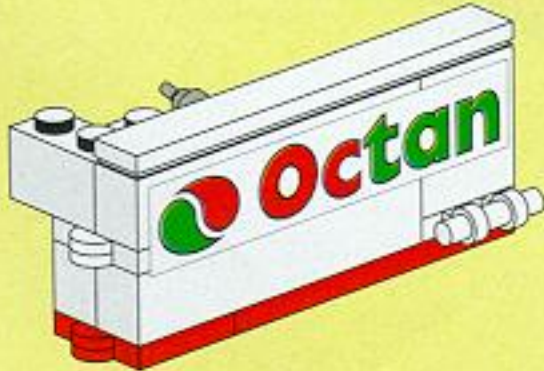

5

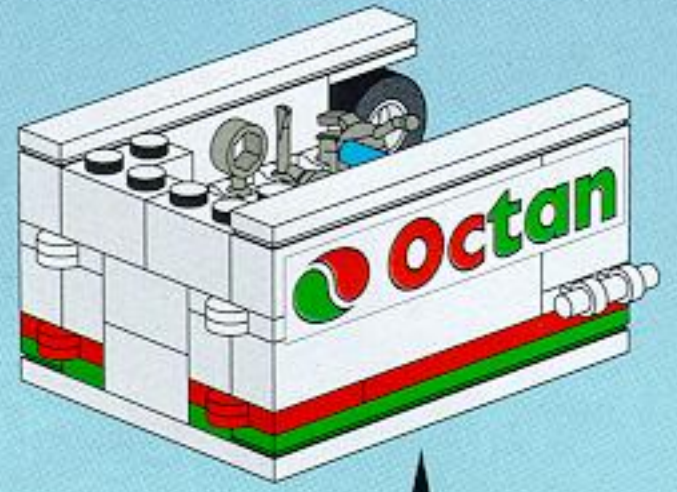

6

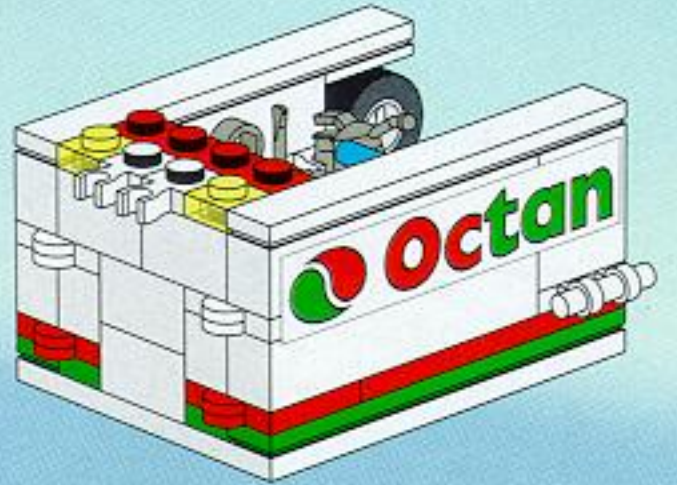

7



16

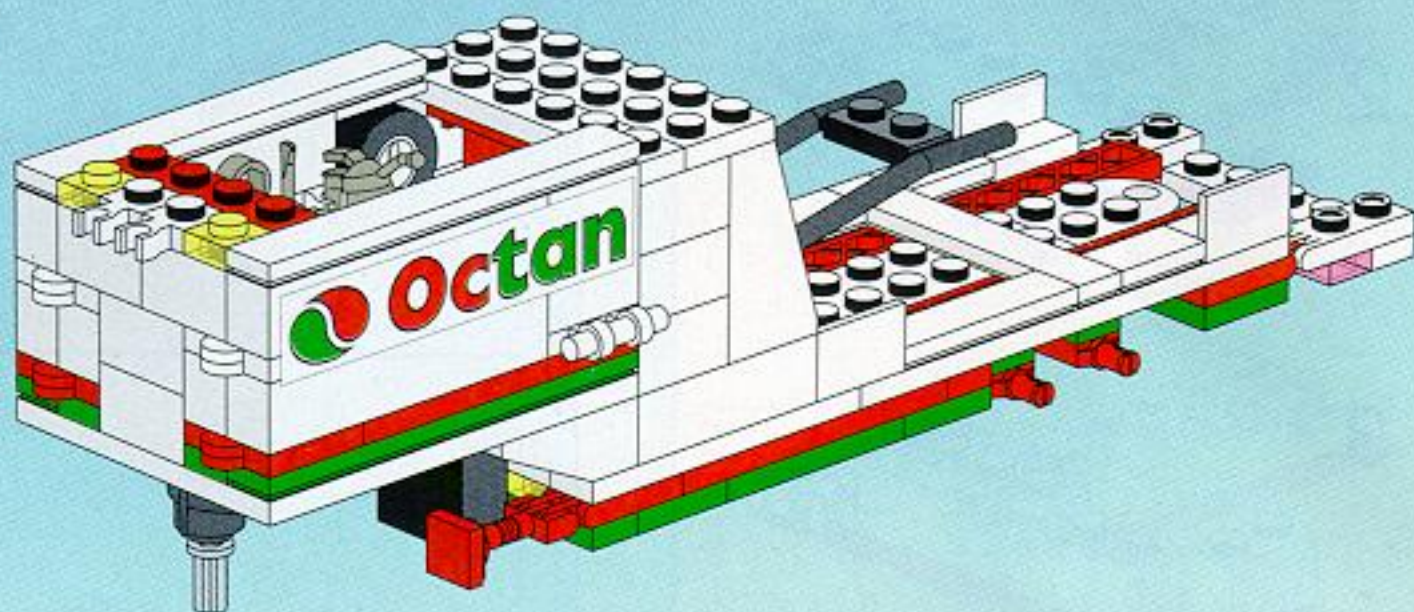

17

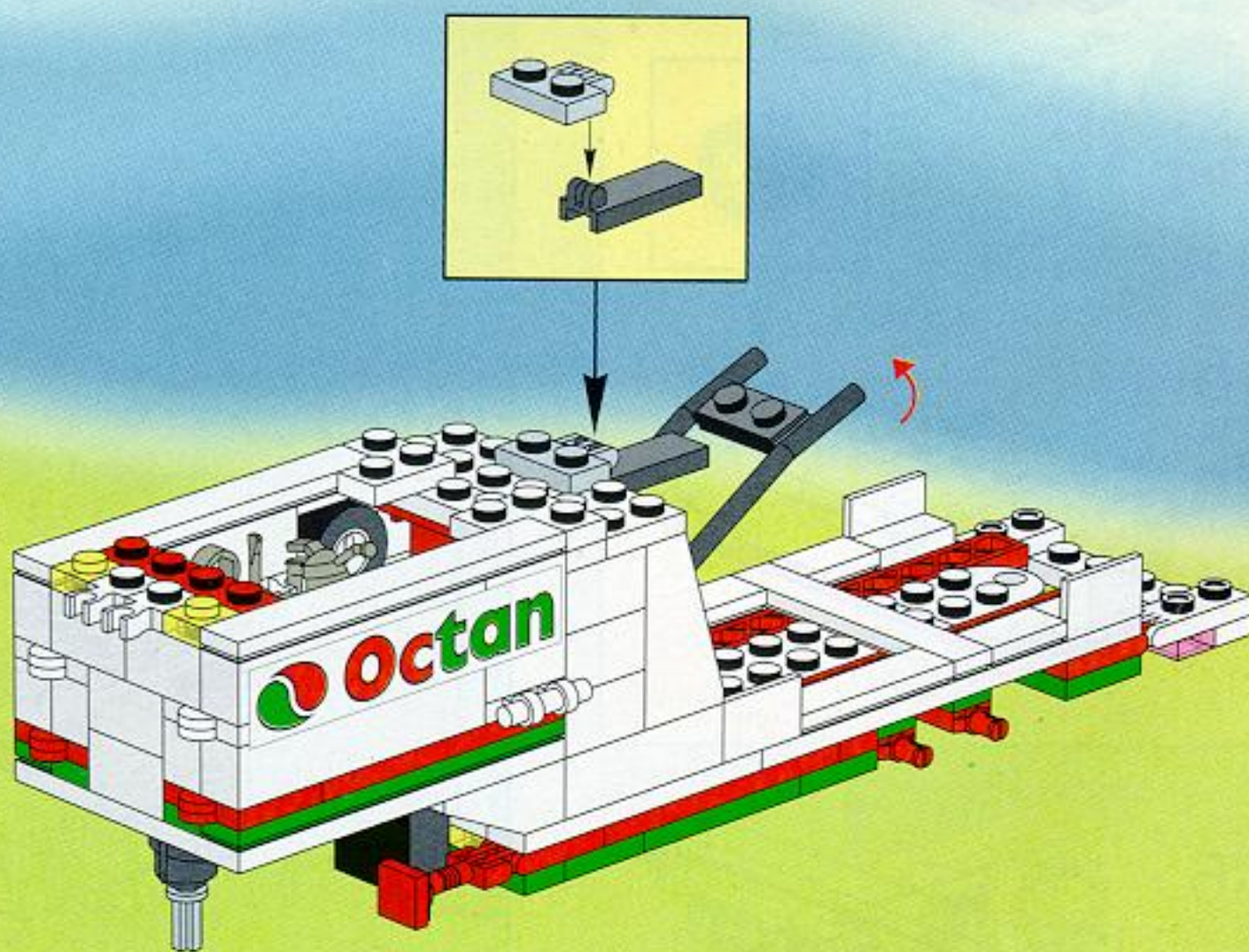

1

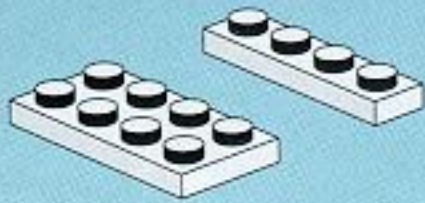

2

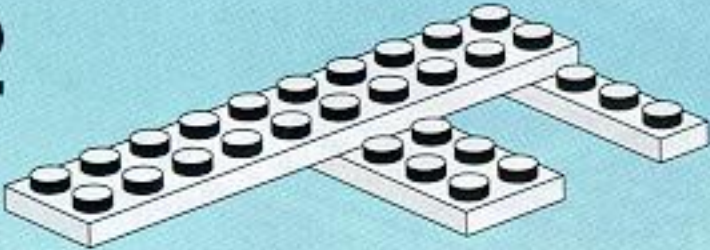

3

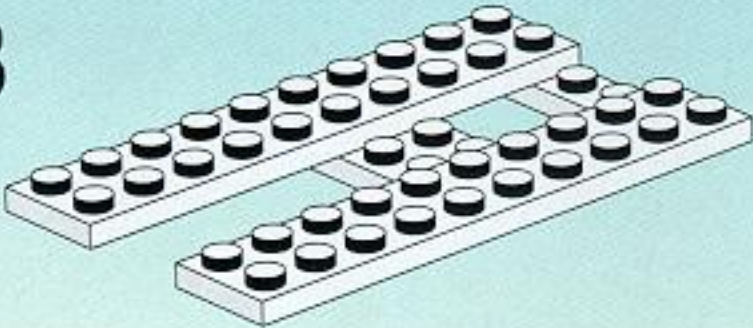

4

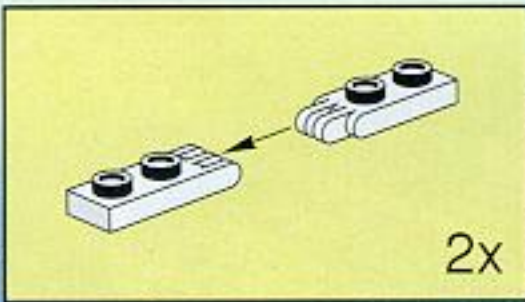
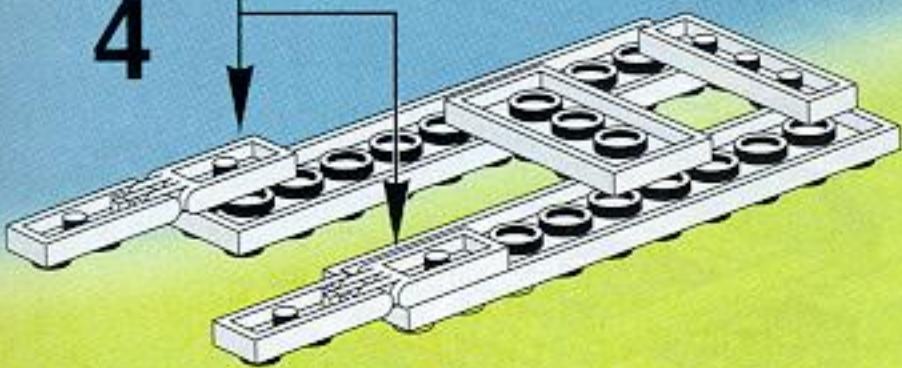

5

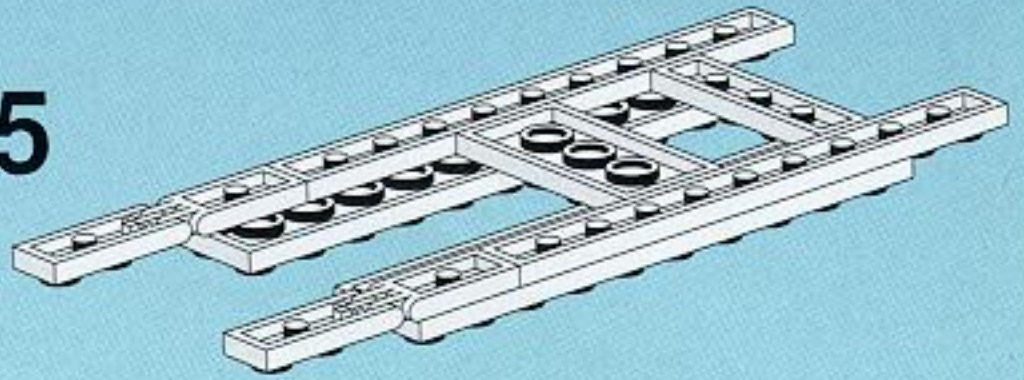

6

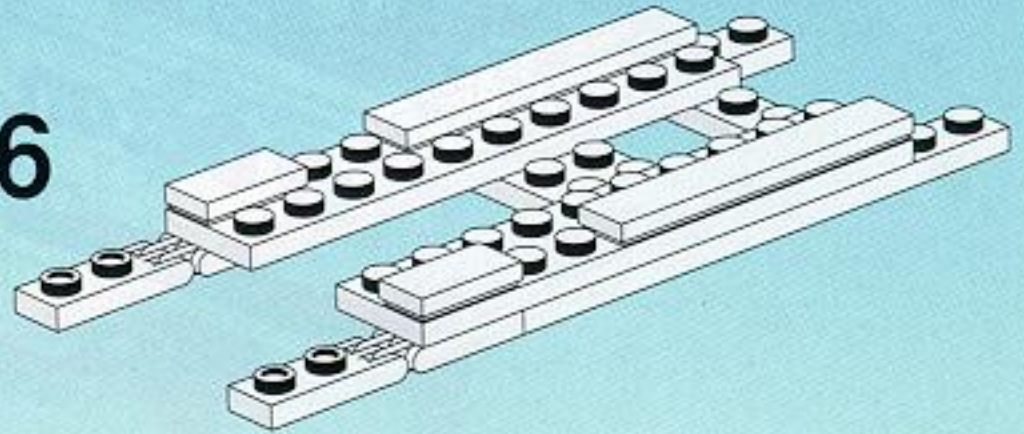

1

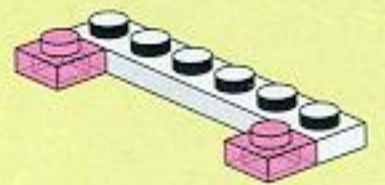

2

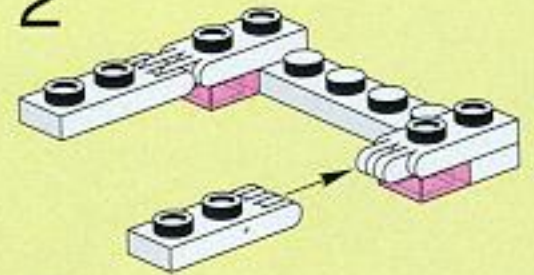

3

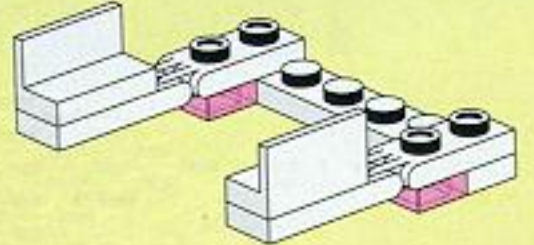

7

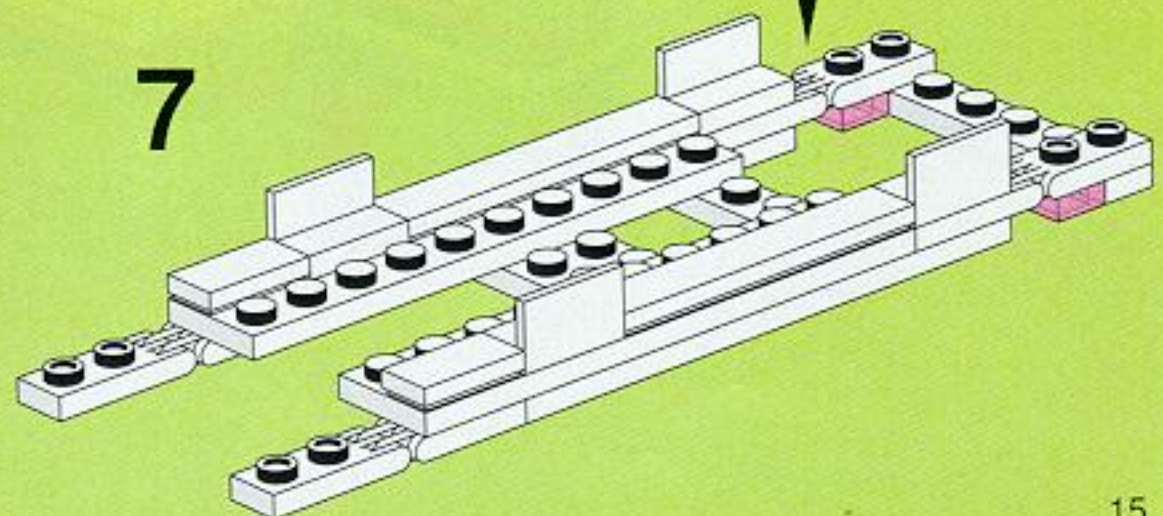

18

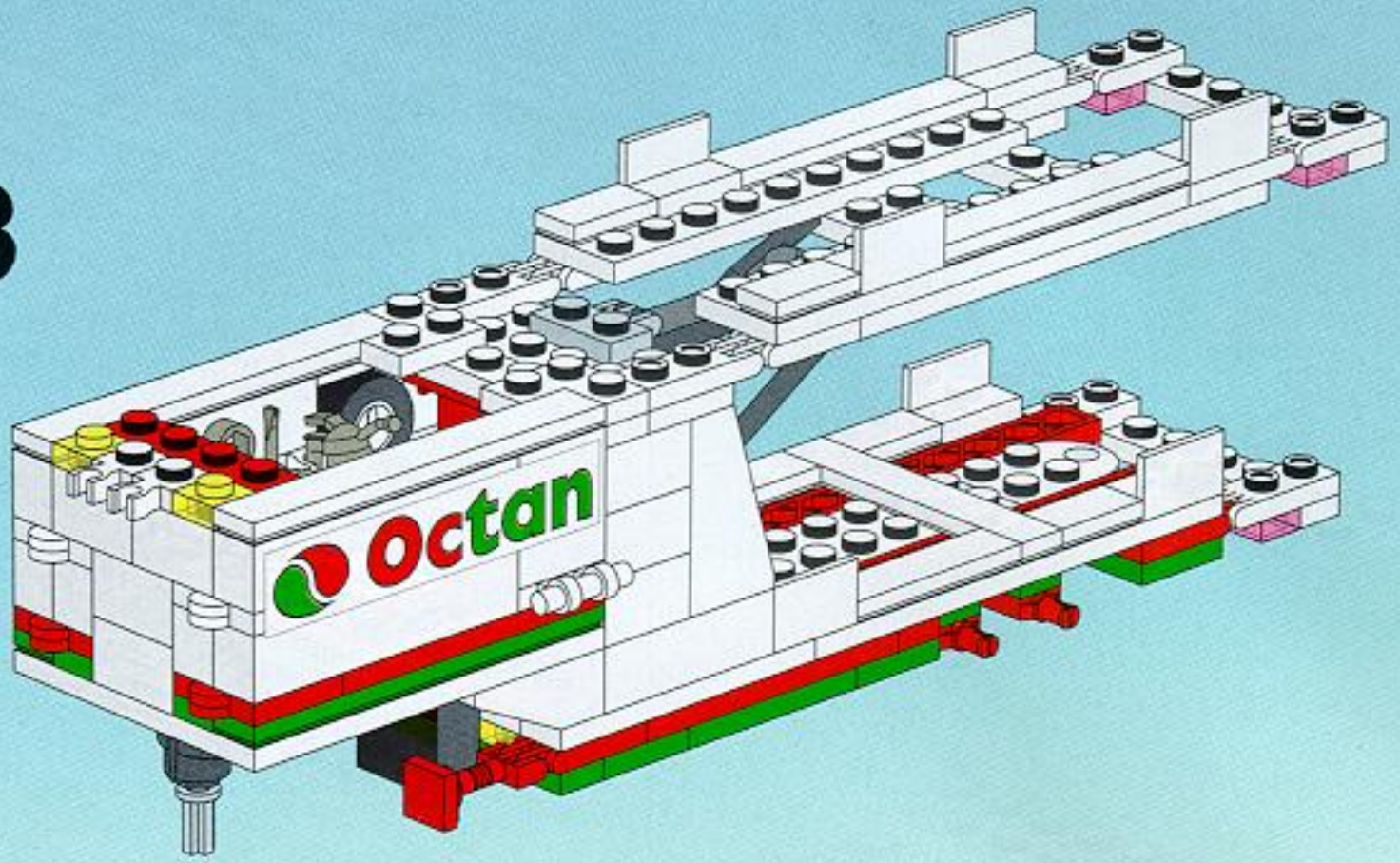

19

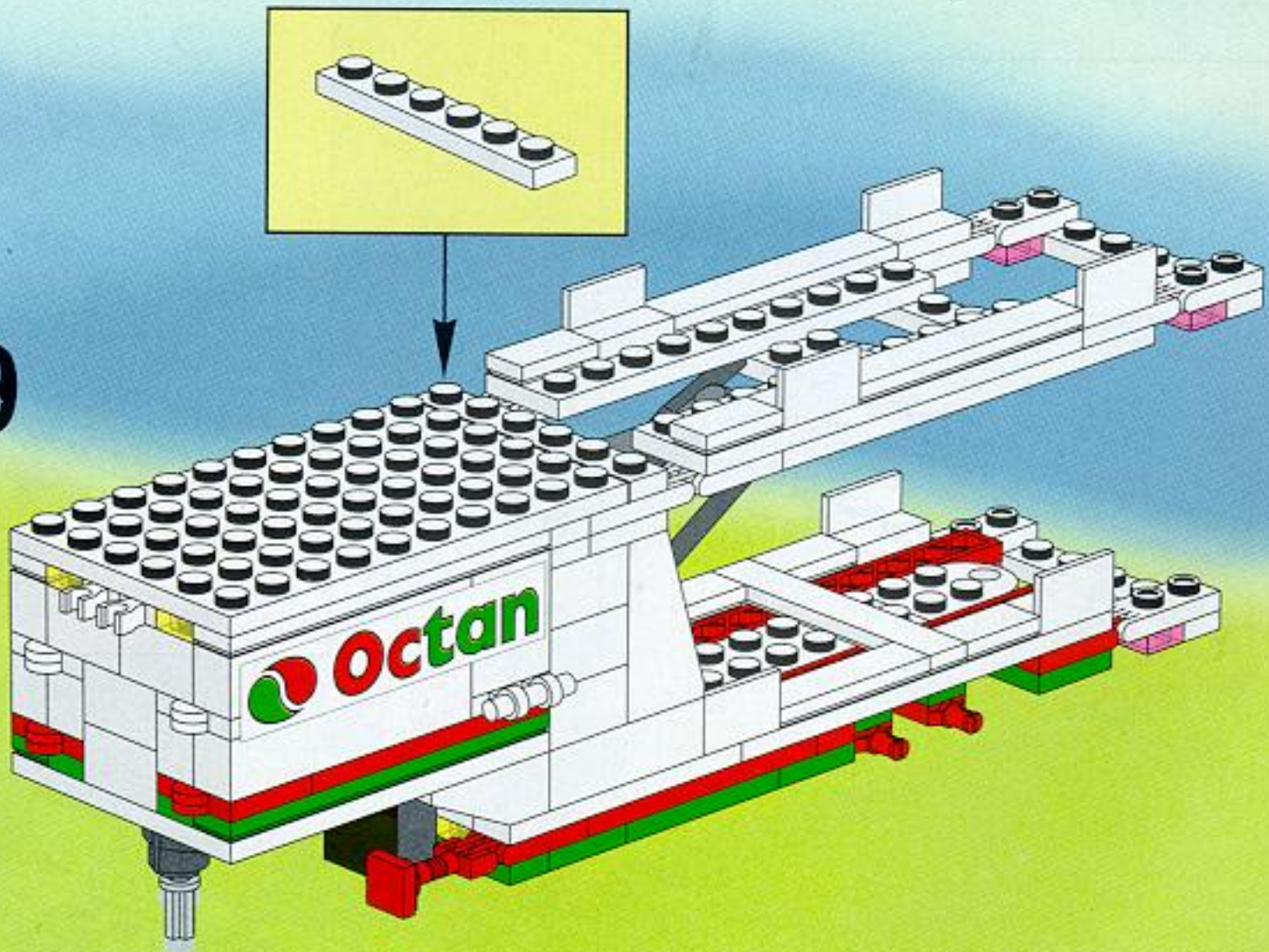

20

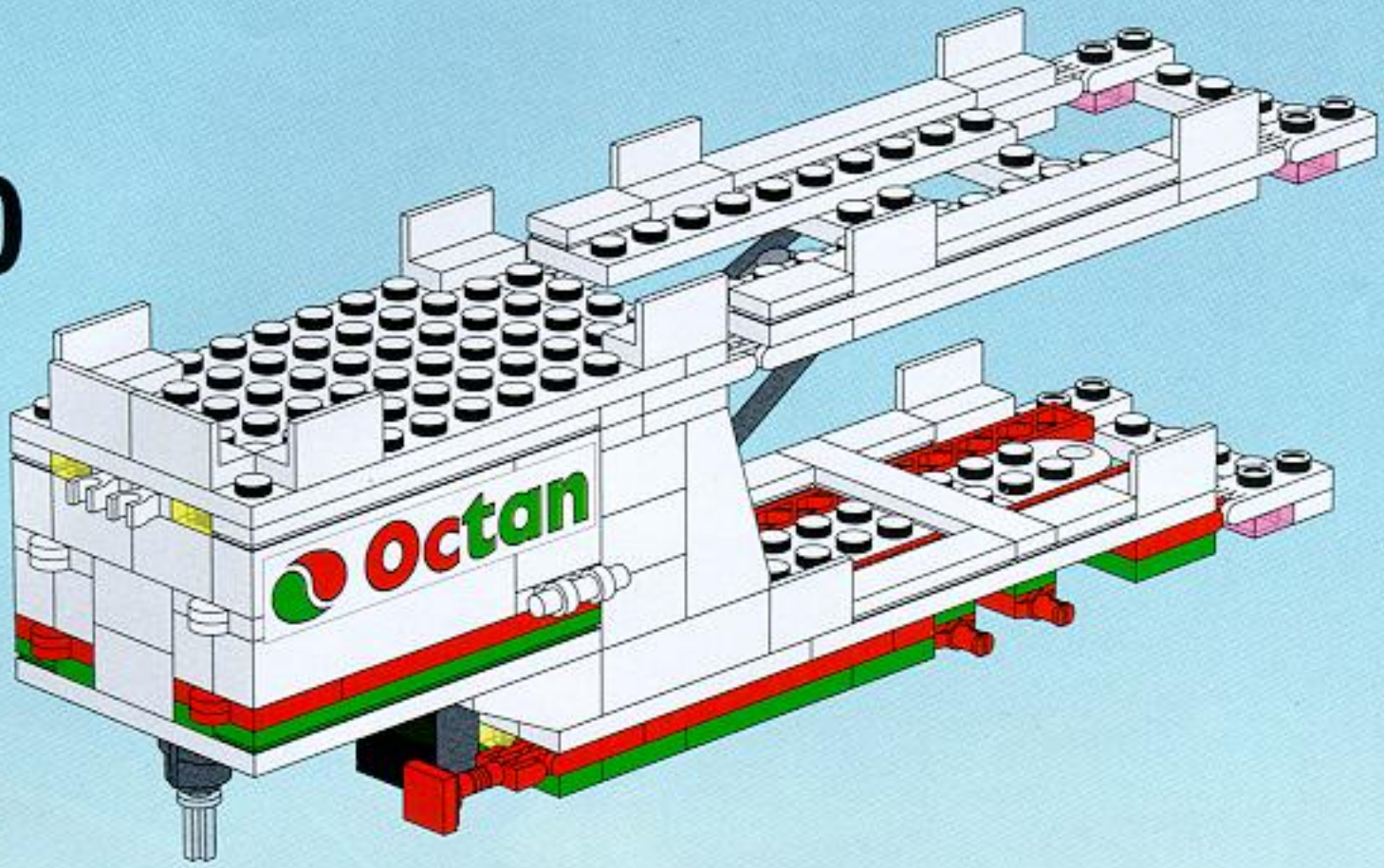

21

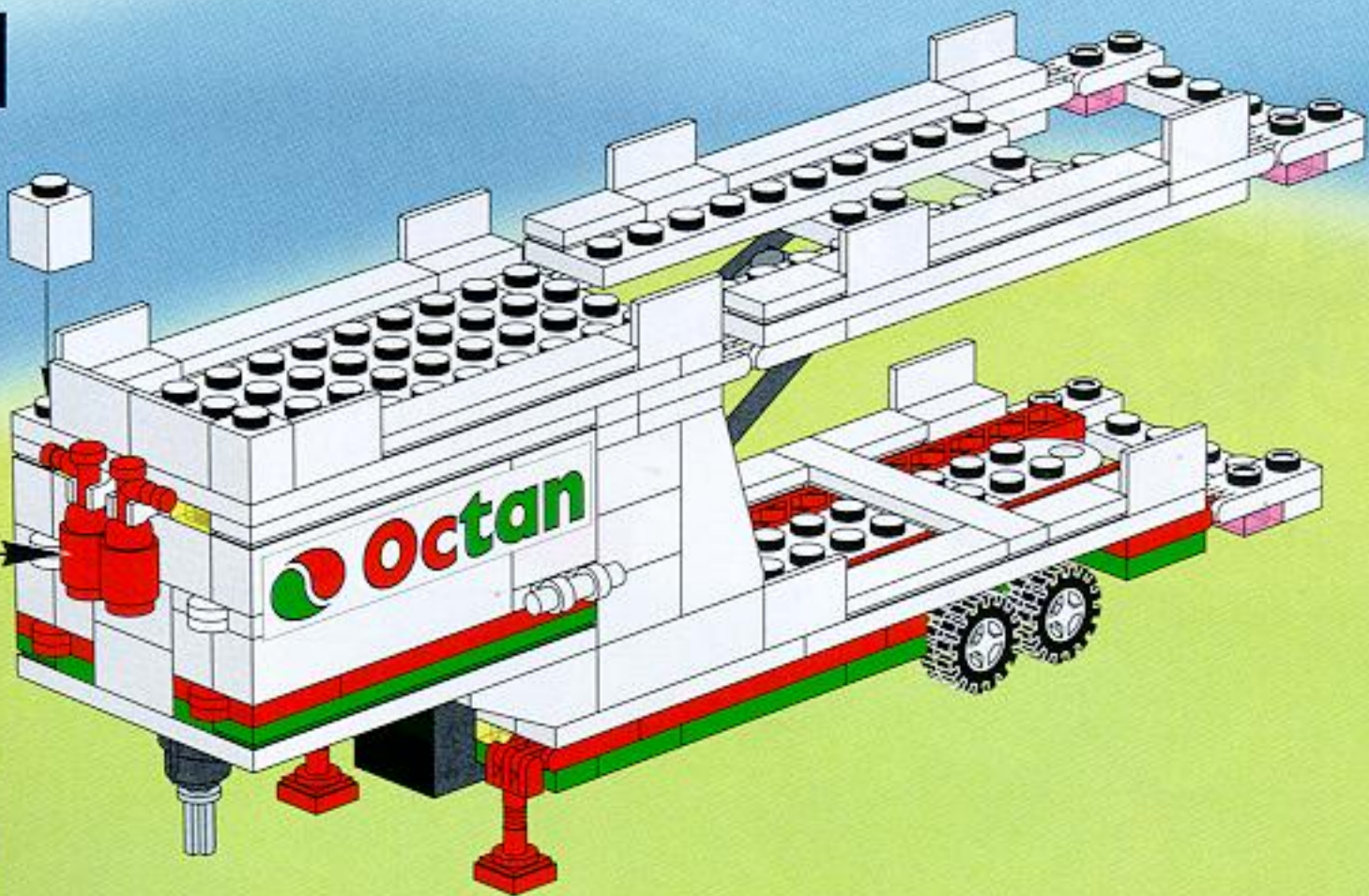

22



