

8504

JUDGE SLIZER

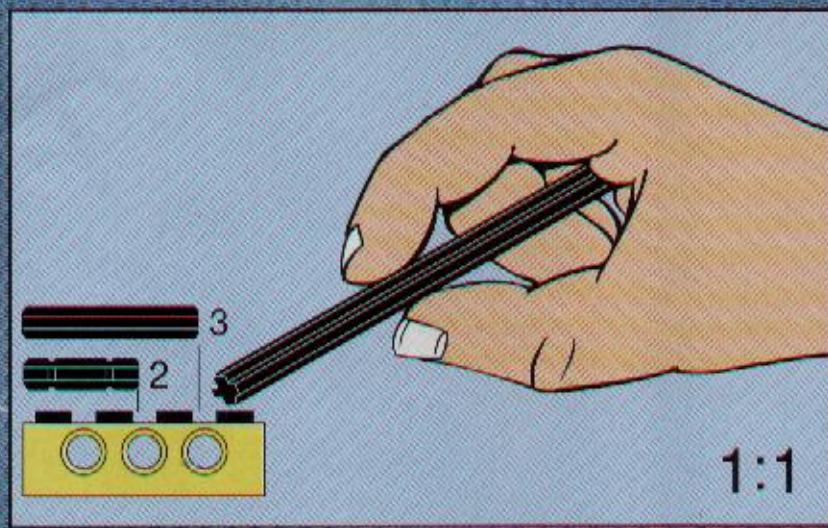

LEGO Technic



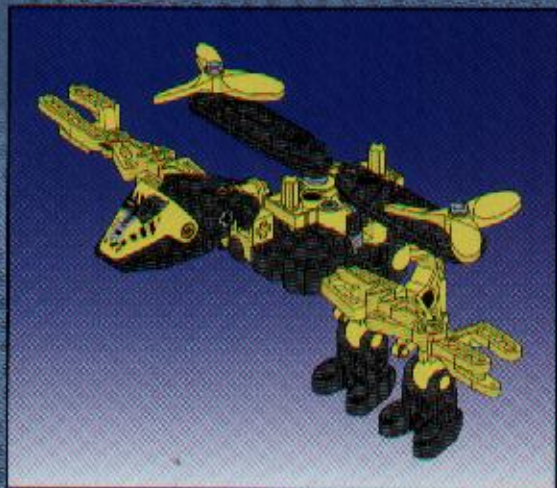

1



2

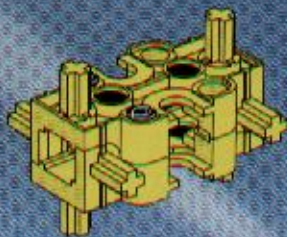

3

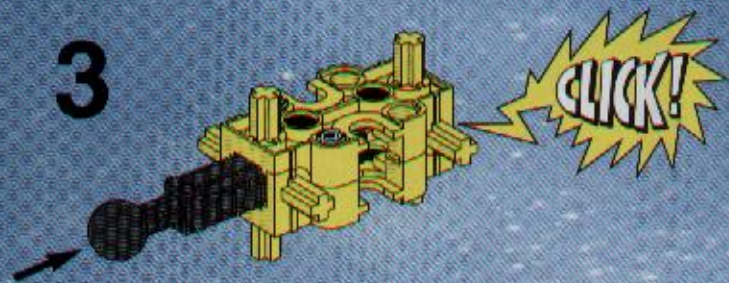

4

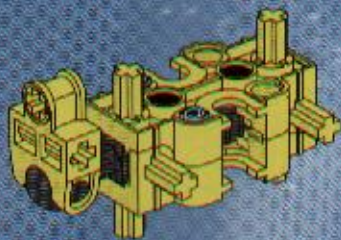

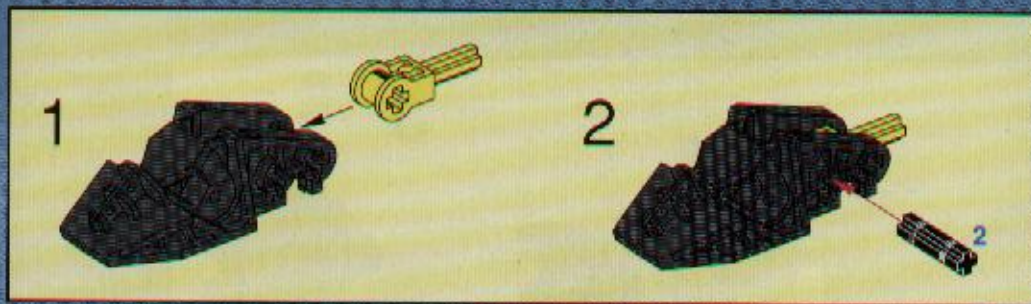

5



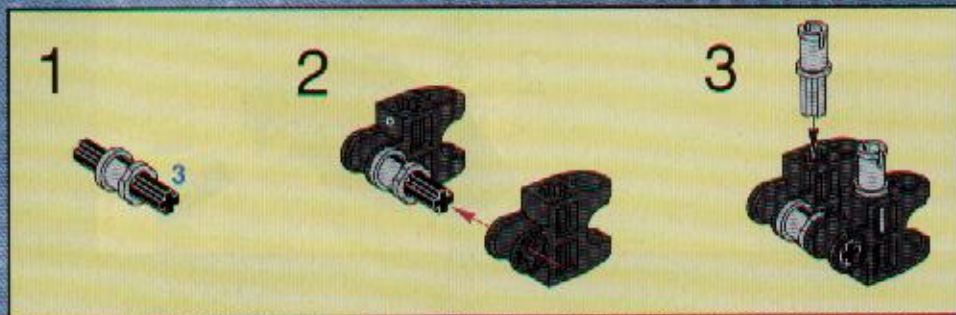

6

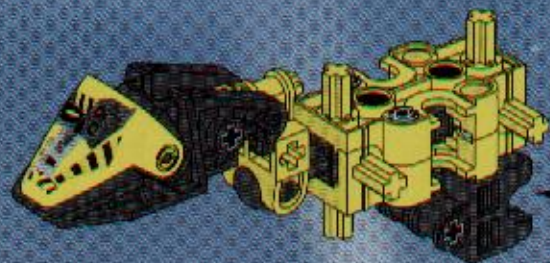

7

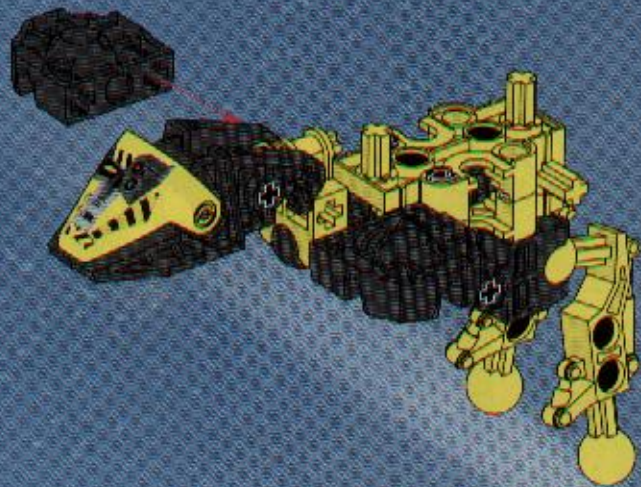

8

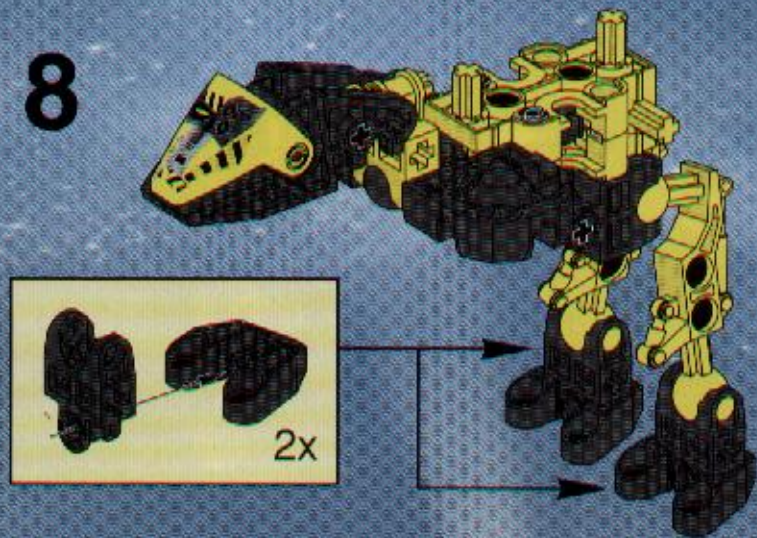

9

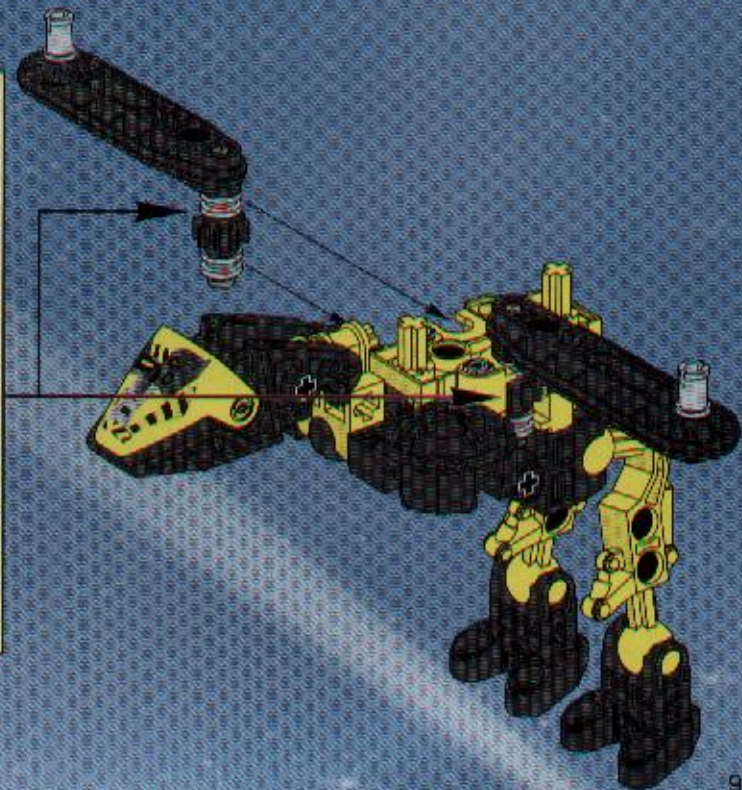
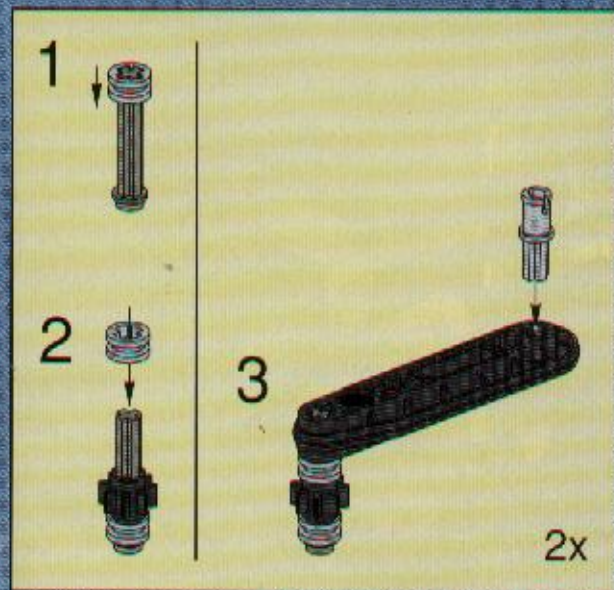

10

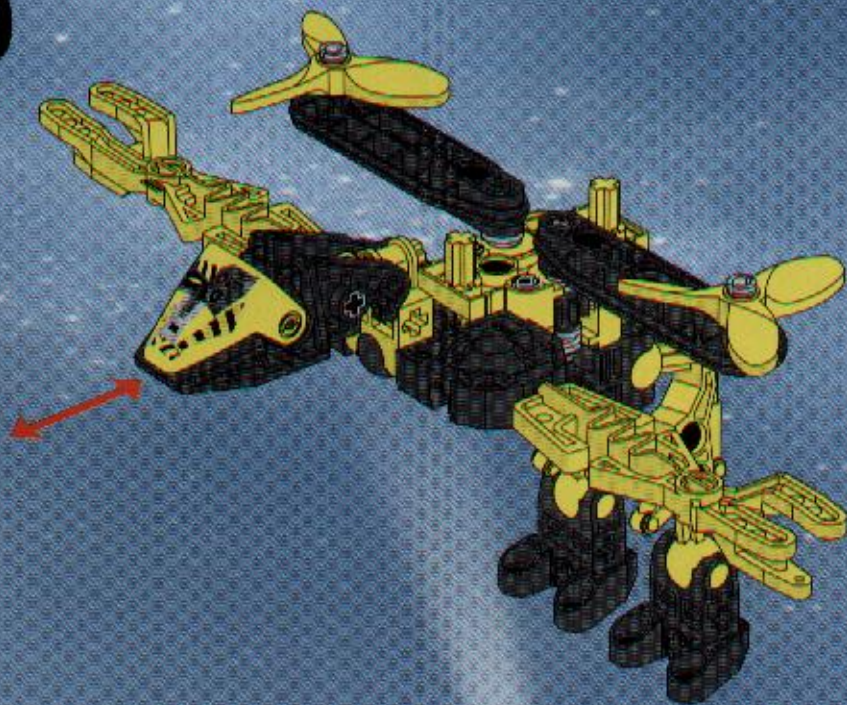





3



4





8504
+

8505
+

8506
+

8507

A vertical list of four small sub-assembly diagrams, each corresponding to a part number. Part 8504 is a small black and green head with a yellow visor. Part 8505 is a yellow and black chest with a black arm. Part 8506 is a blue and black torso with yellow and red joints. Part 8507 is a black leg with red and yellow joints. Each part is shown in a small, simplified view.

1



3



2



4



1

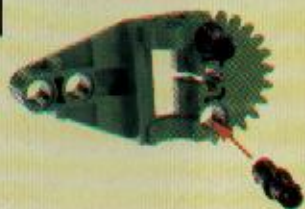

2



5







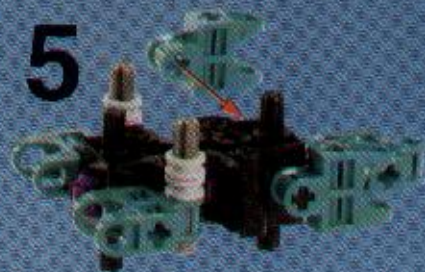
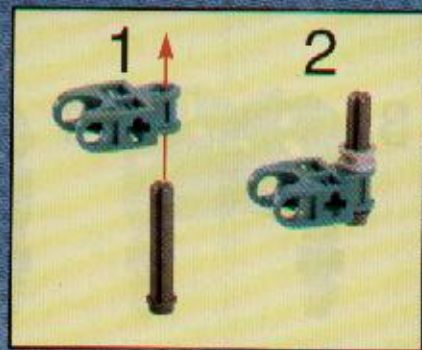

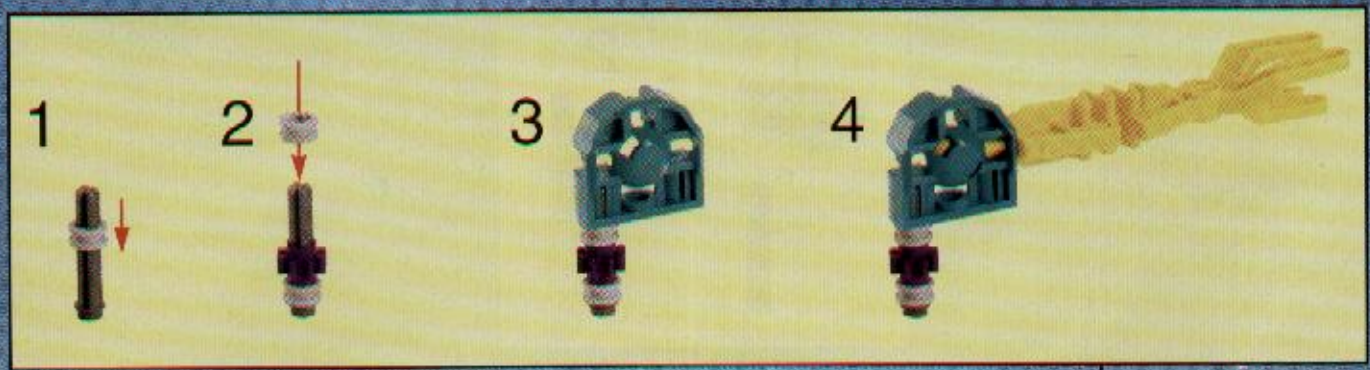

1



2



3



4



7

