

8505

JUNGLE  
SLIZER

LEGO Technic

4124717

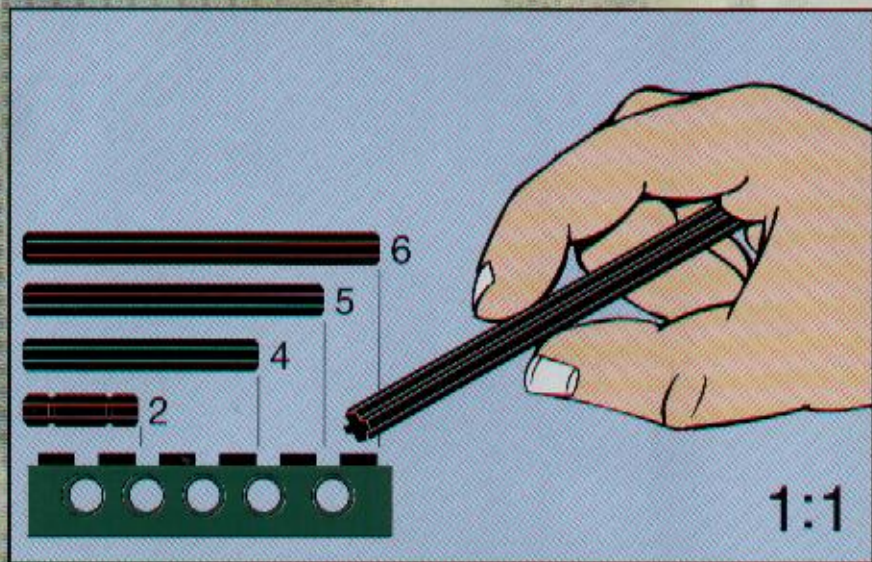





1



2

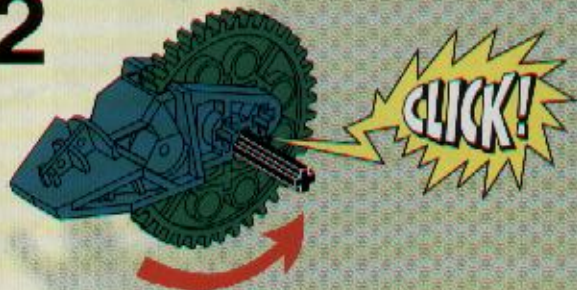

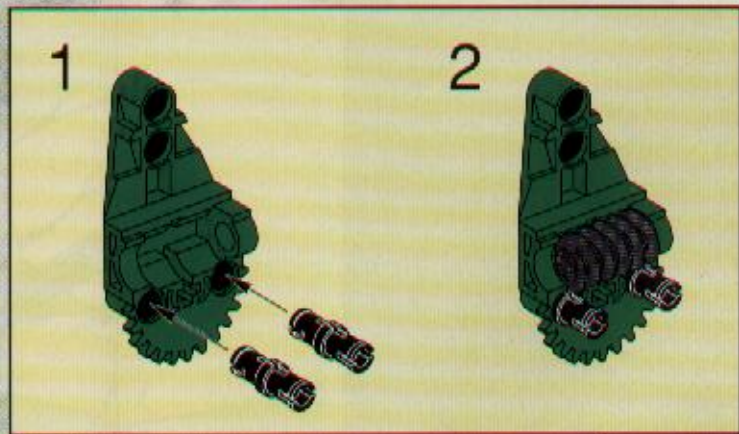

3



4

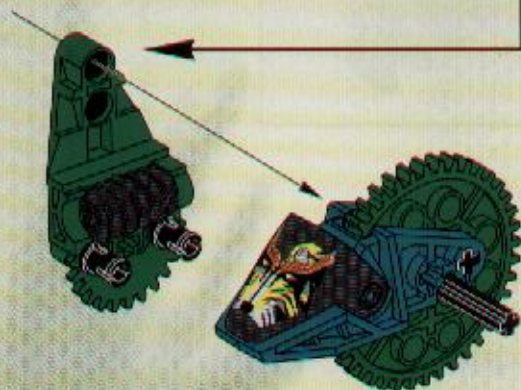



5



6

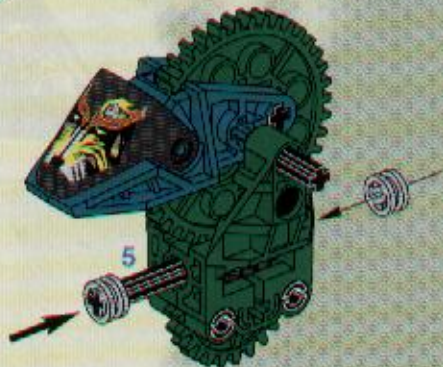

7

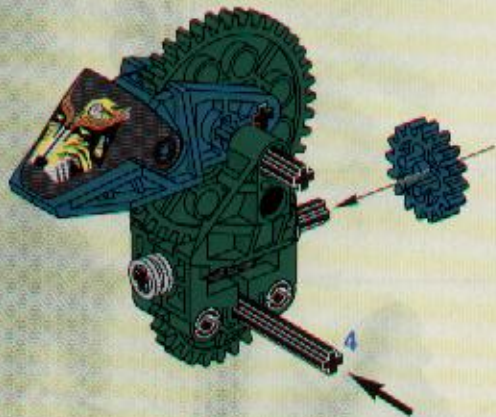



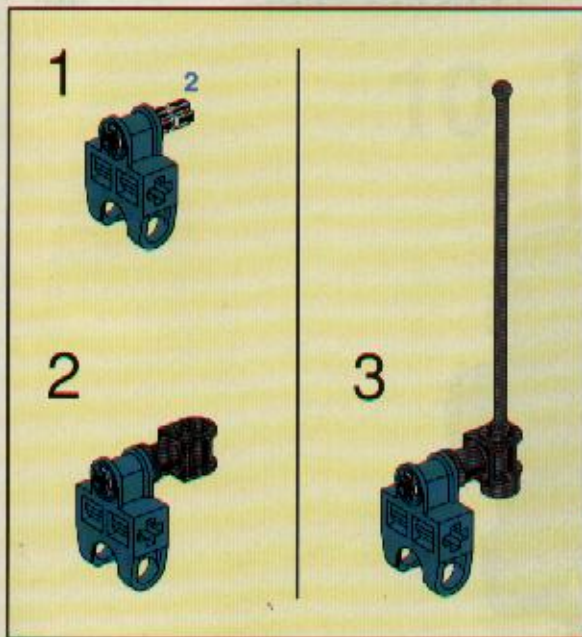

8

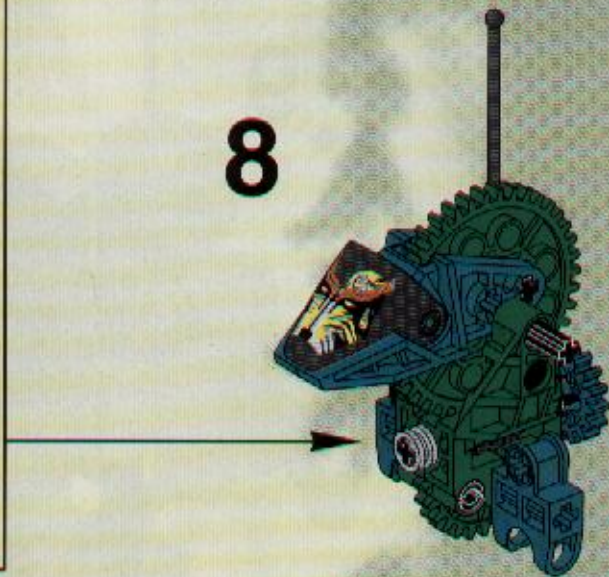

9

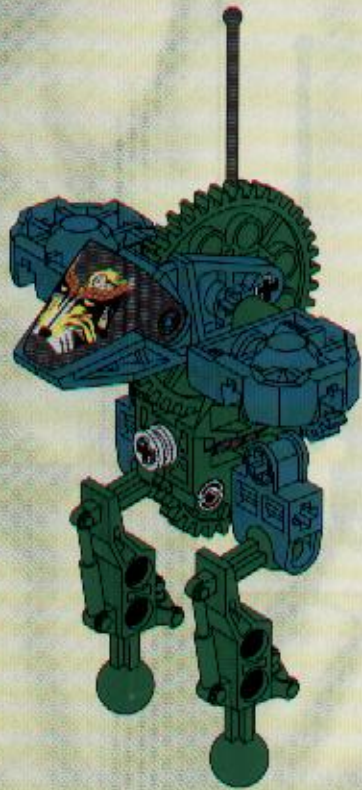



10



11







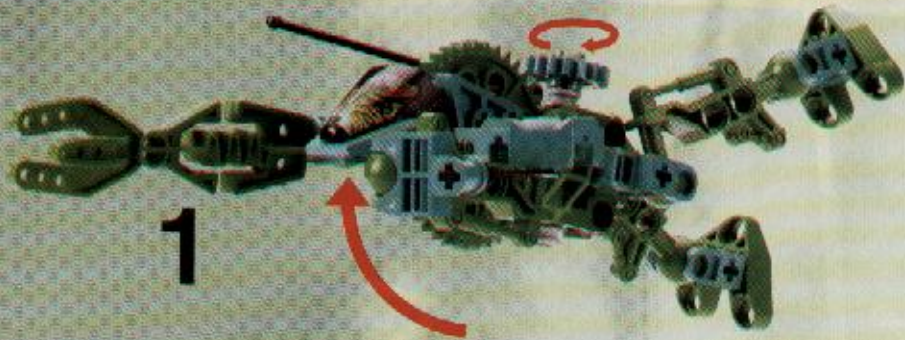

1



2

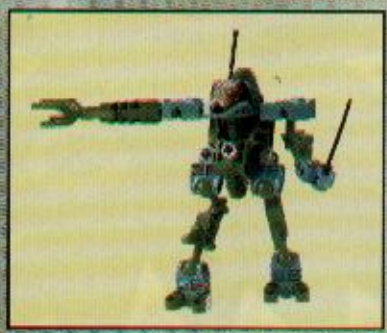



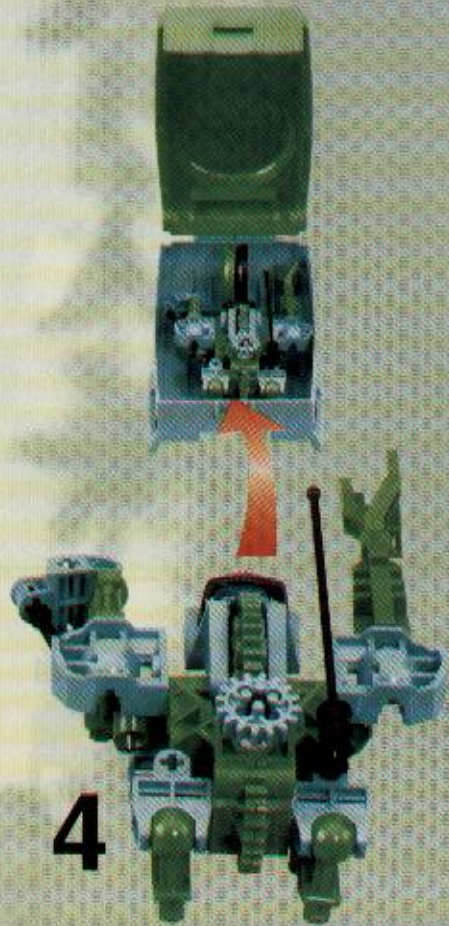

8504  
+

8505  
+

8506  
+

8507





1



3



2



4



1



2



5



6

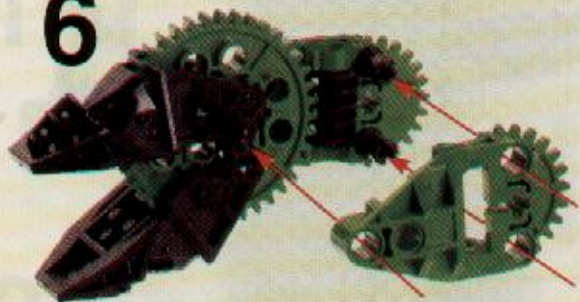

7

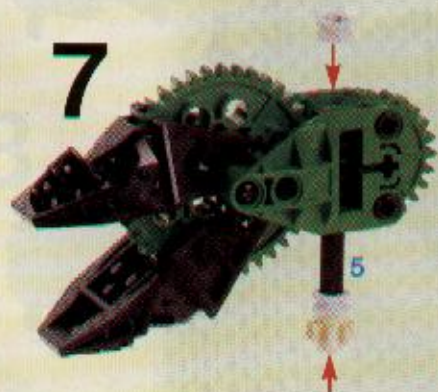

8

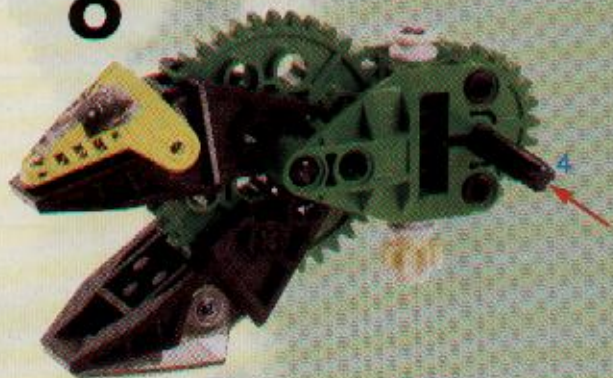



9



10



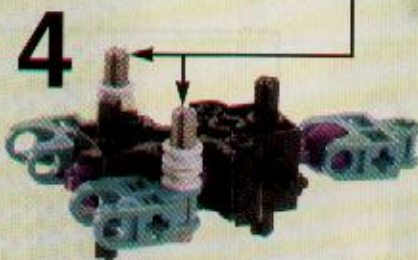
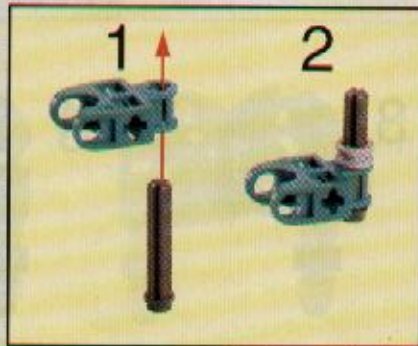
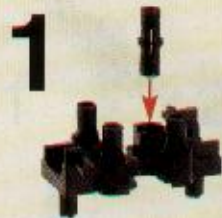



1



2



3



4



6

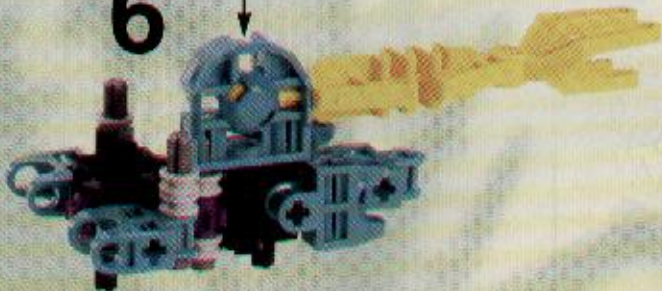





8504

# JUDGE SLIZER



**LEGO** Technic

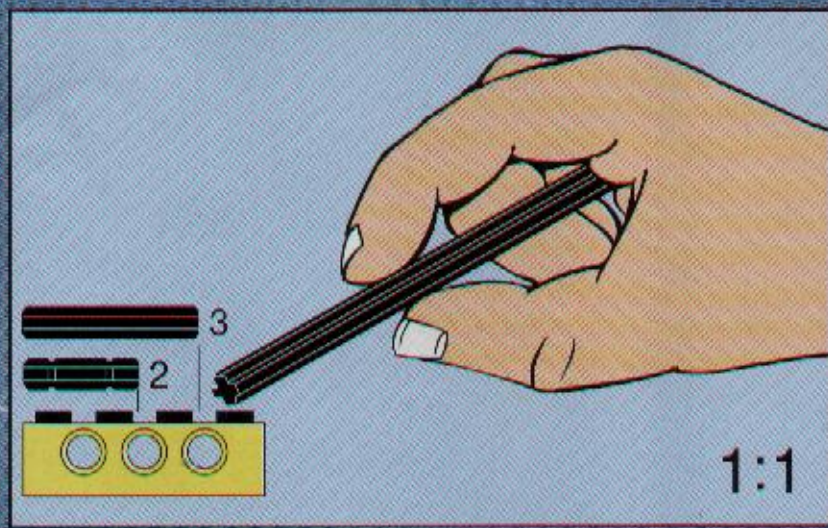



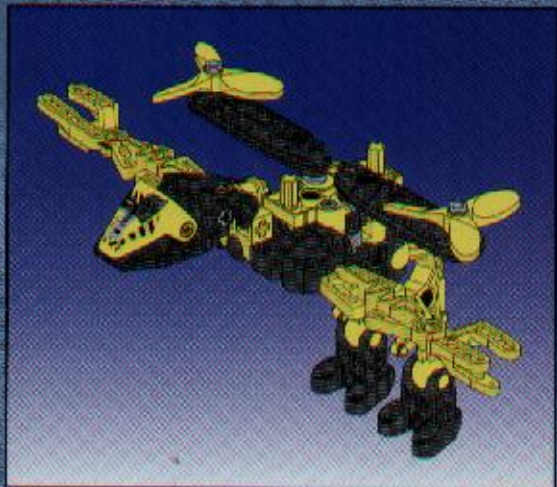

1



2

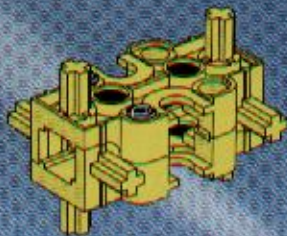



3

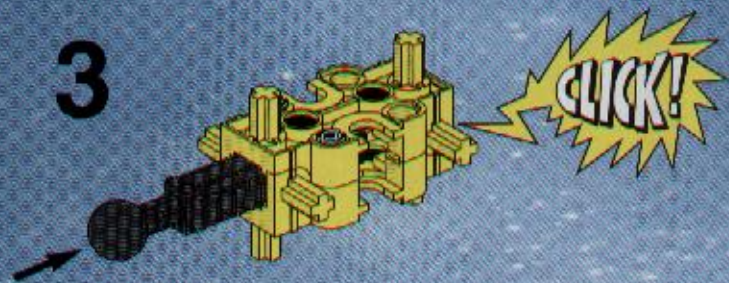

4

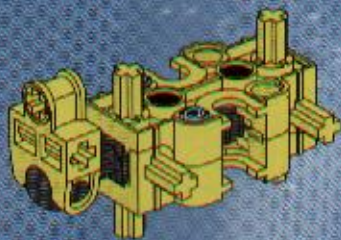



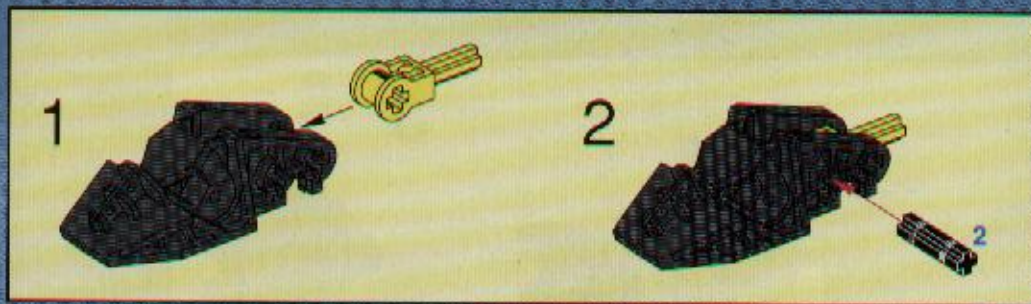

5





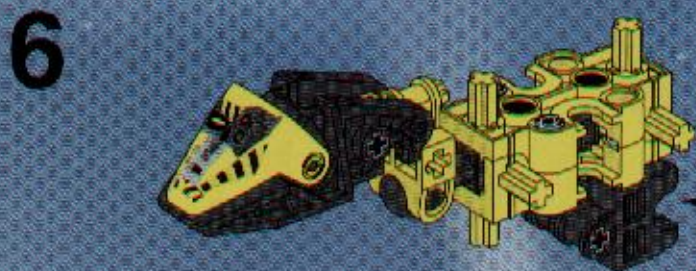
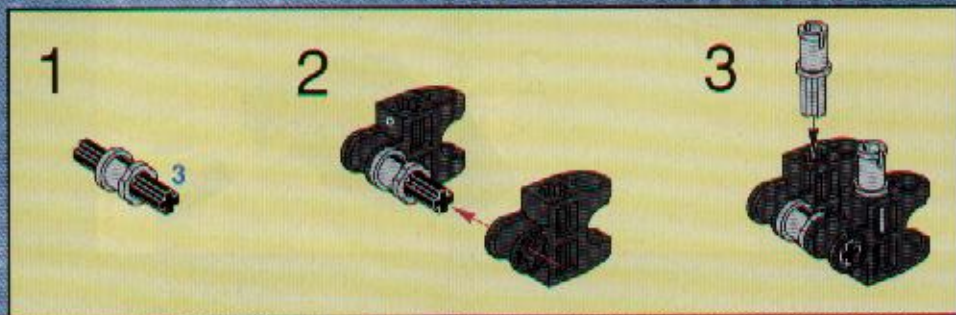



7

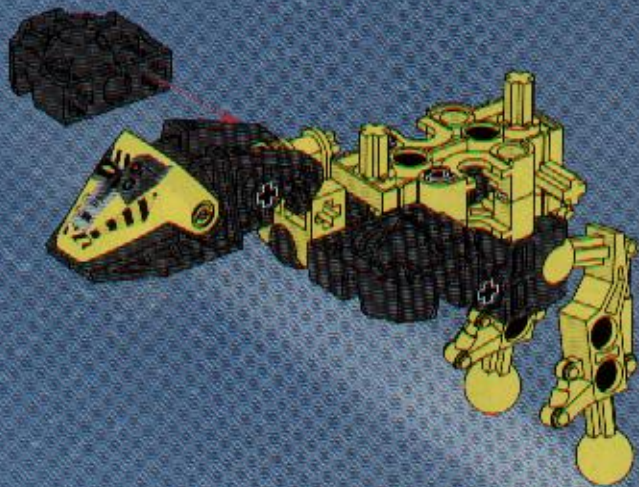



8

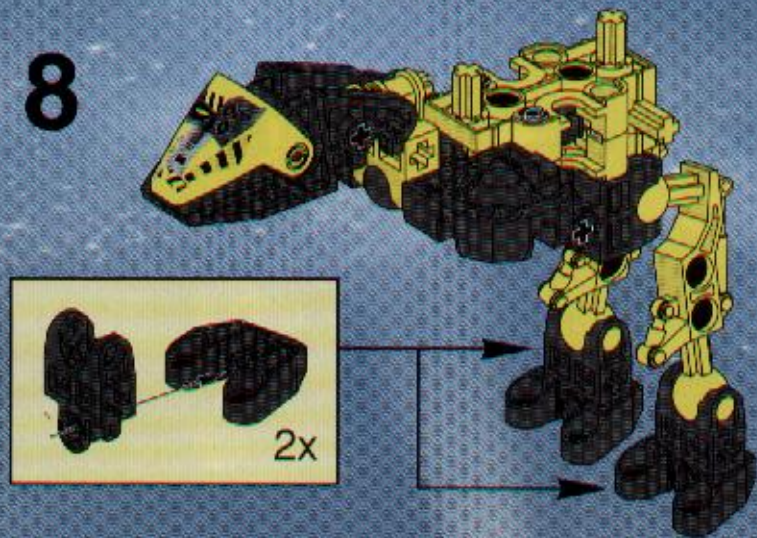



# 9

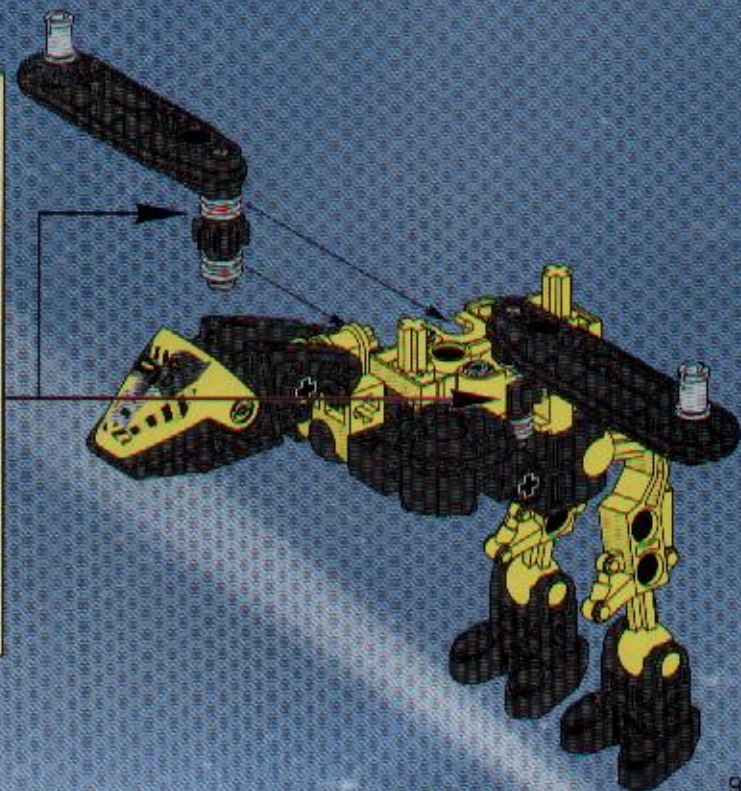
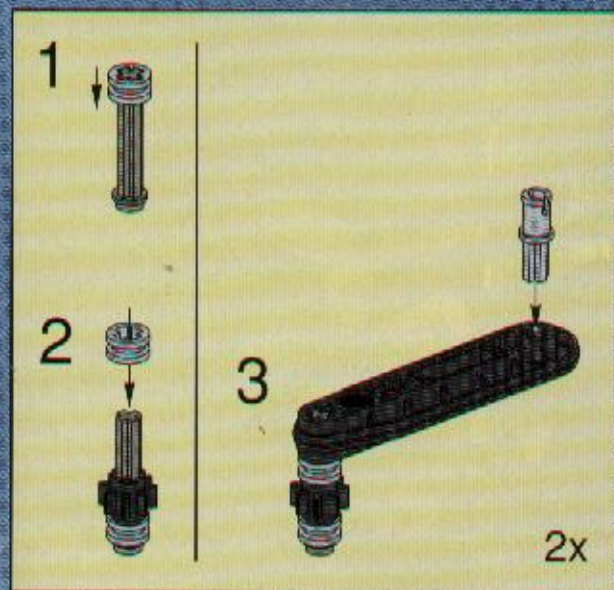



10

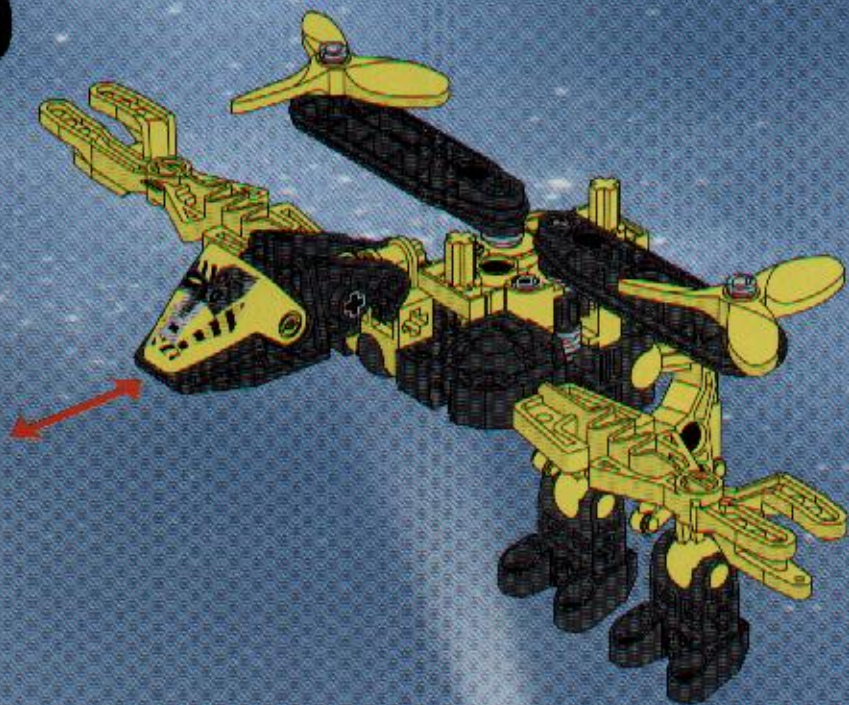









3



4







8504  
+

8505  
+

8506  
+

8507



1



3



2



4



1



2



5













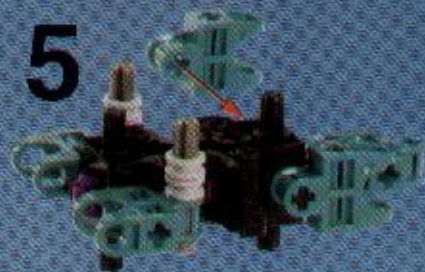
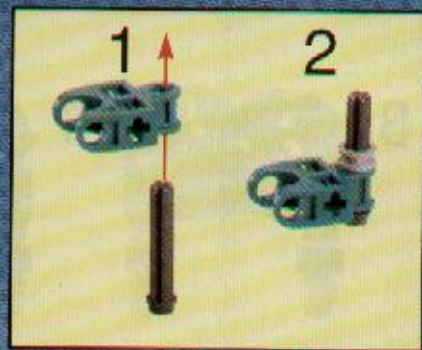



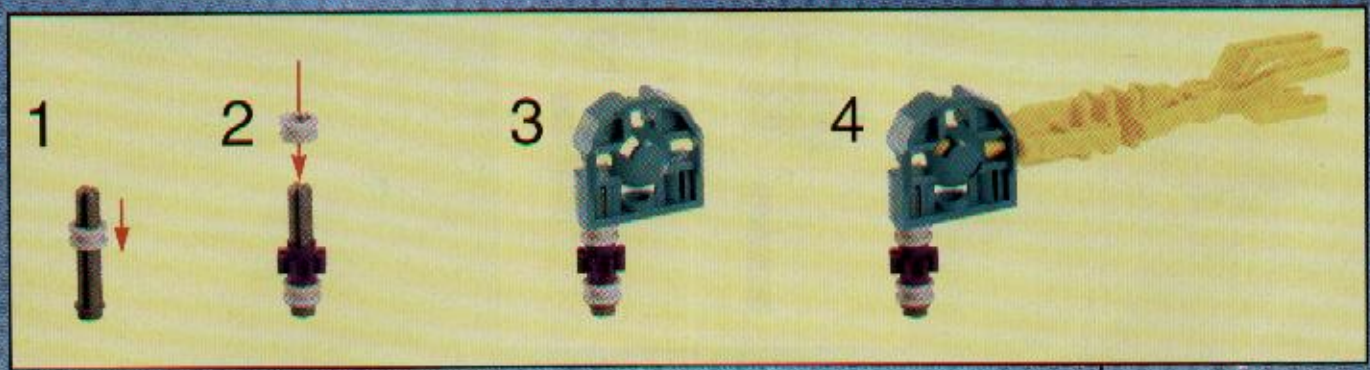



1



2



3



4



7

