

BIONICLE®

BITIL

MISTIKA



8696

www.BIONICLE.com

LEGO

1

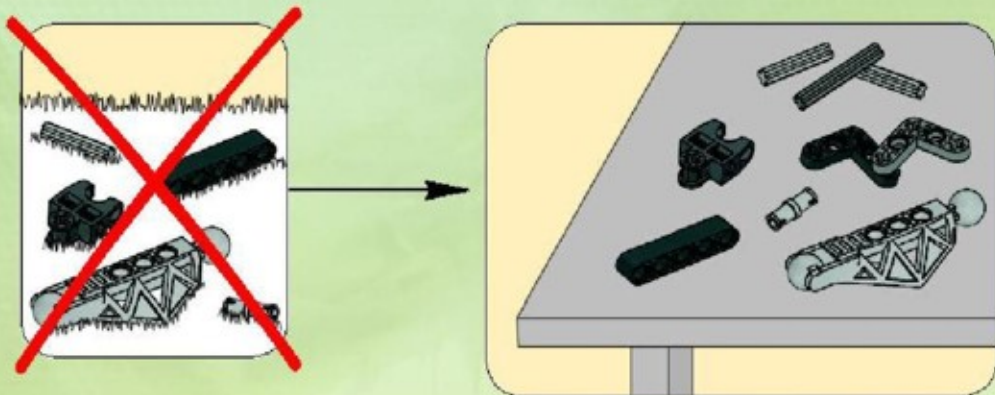

2

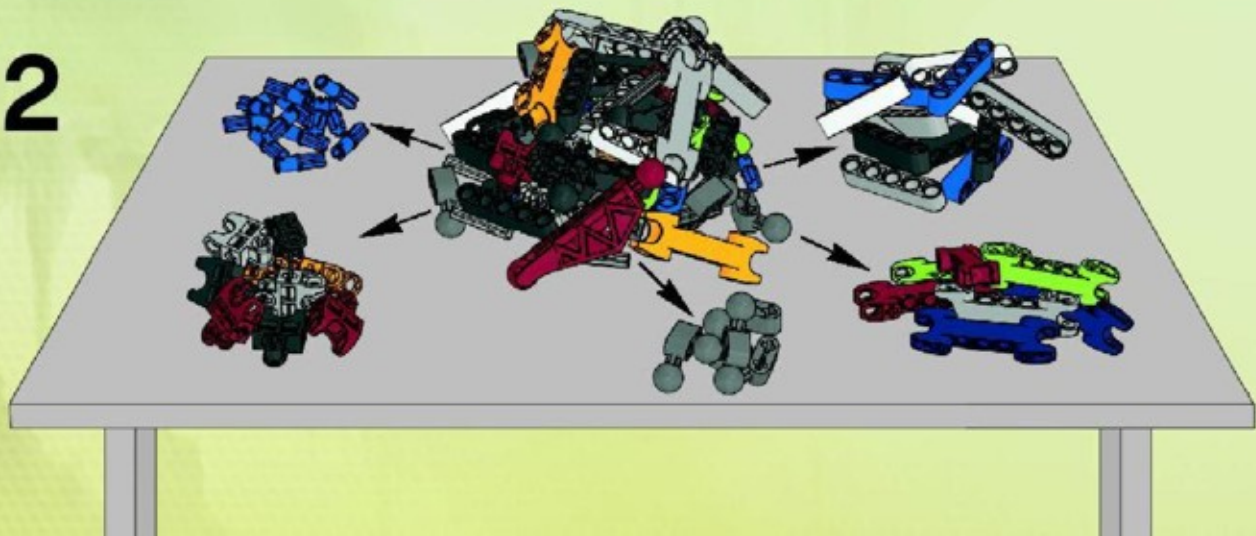

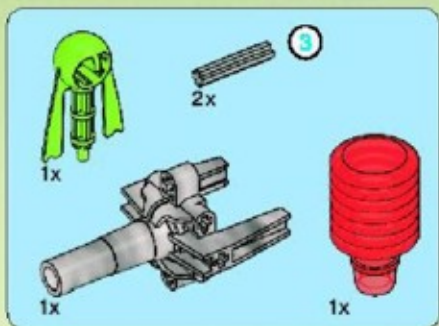

1

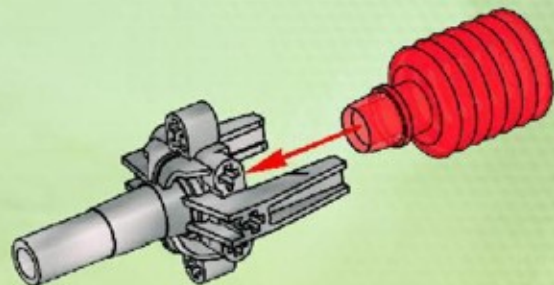

2

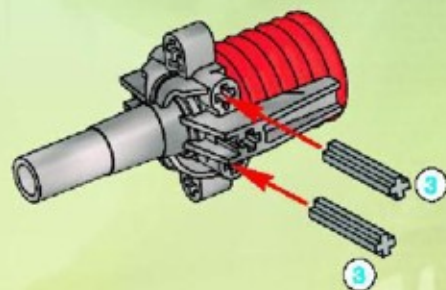

3

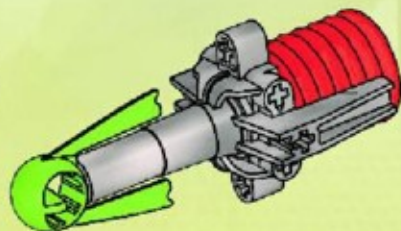



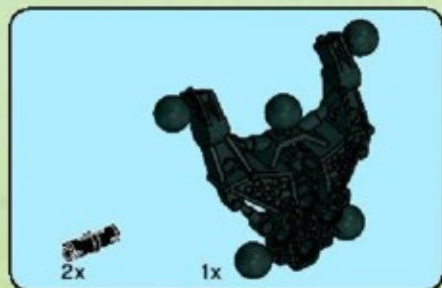

1

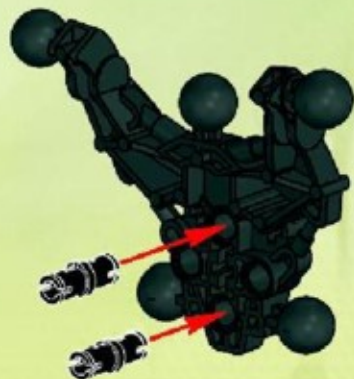



1x



1x

2

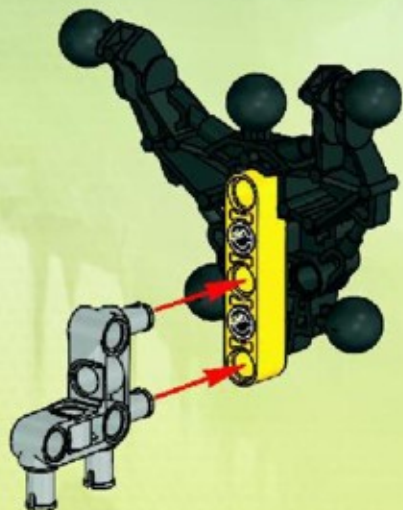

6



2x

3



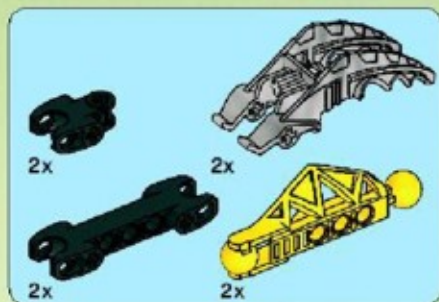

4

1

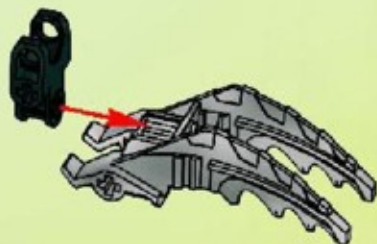

2



2x



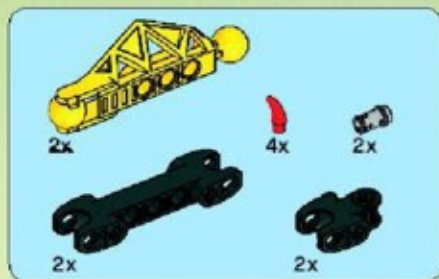

5

1



2



3

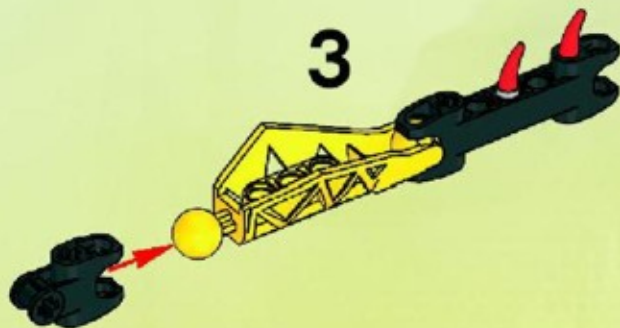

2x

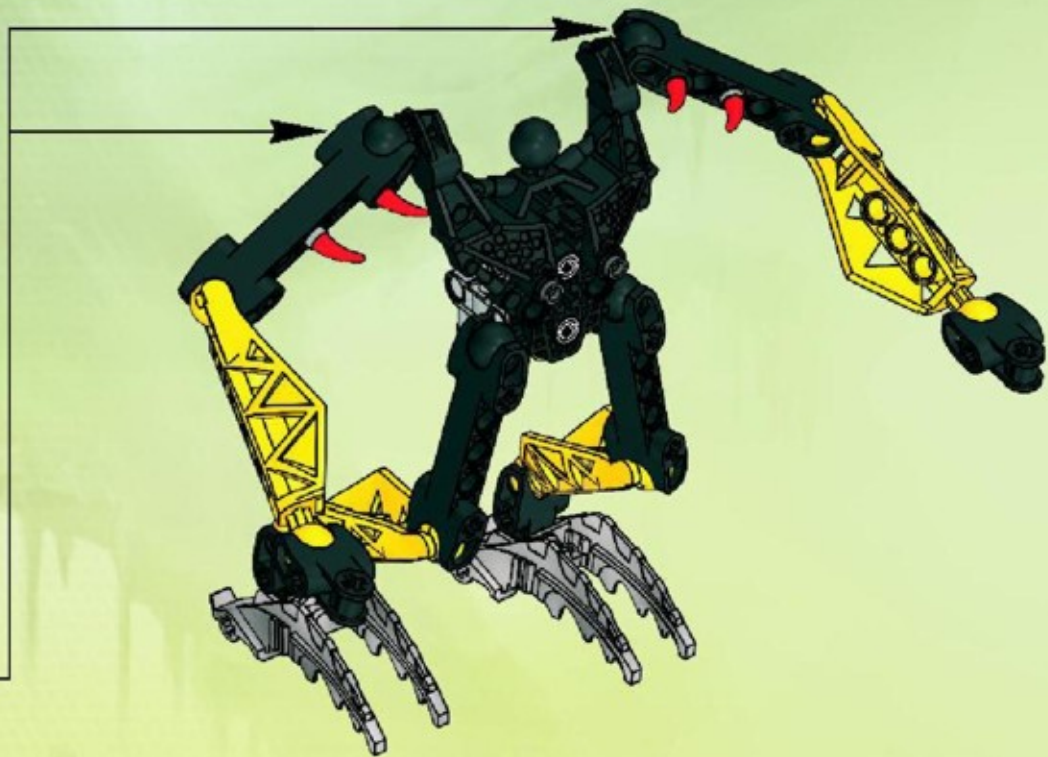

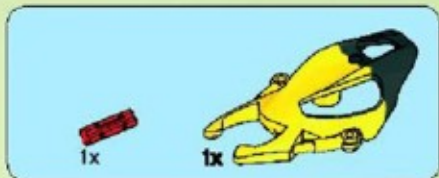

1



2



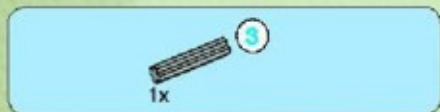

3

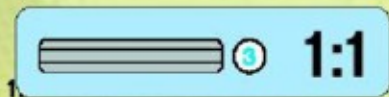

4

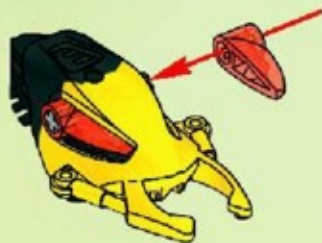



5



6



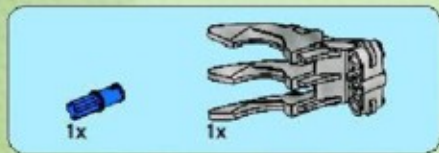

7

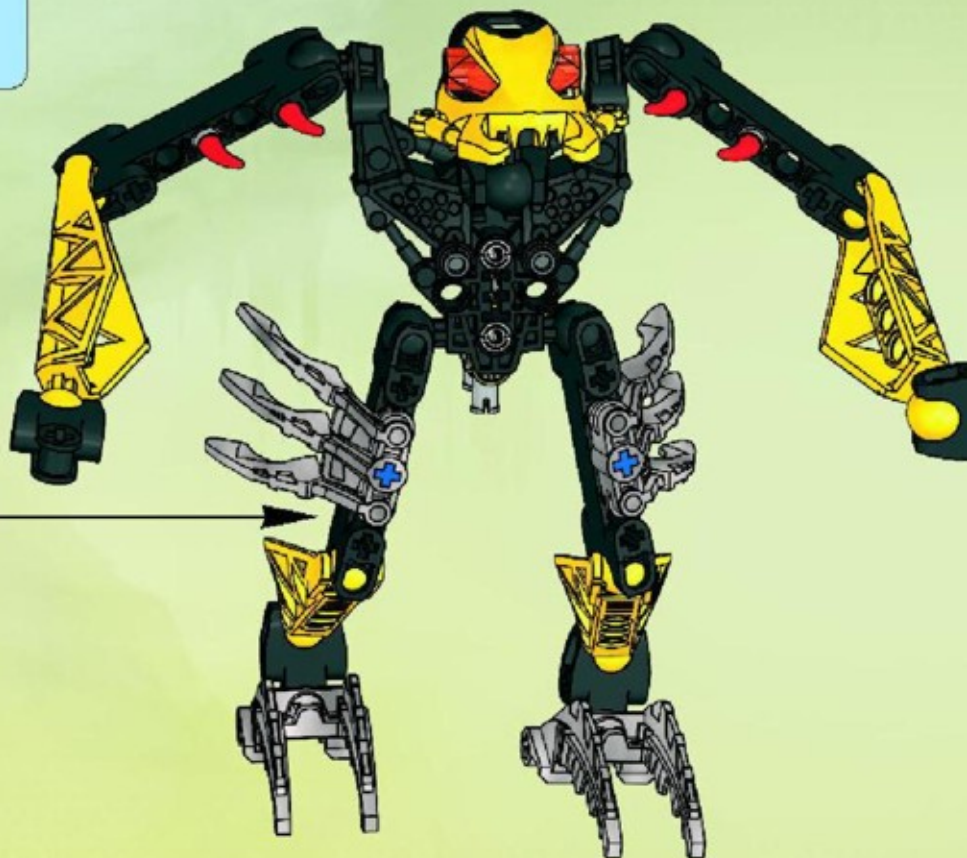
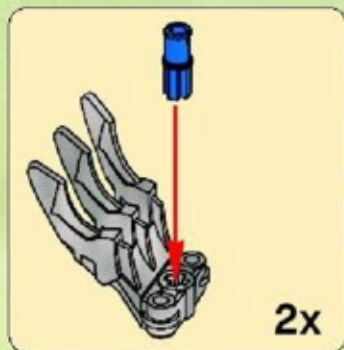



8

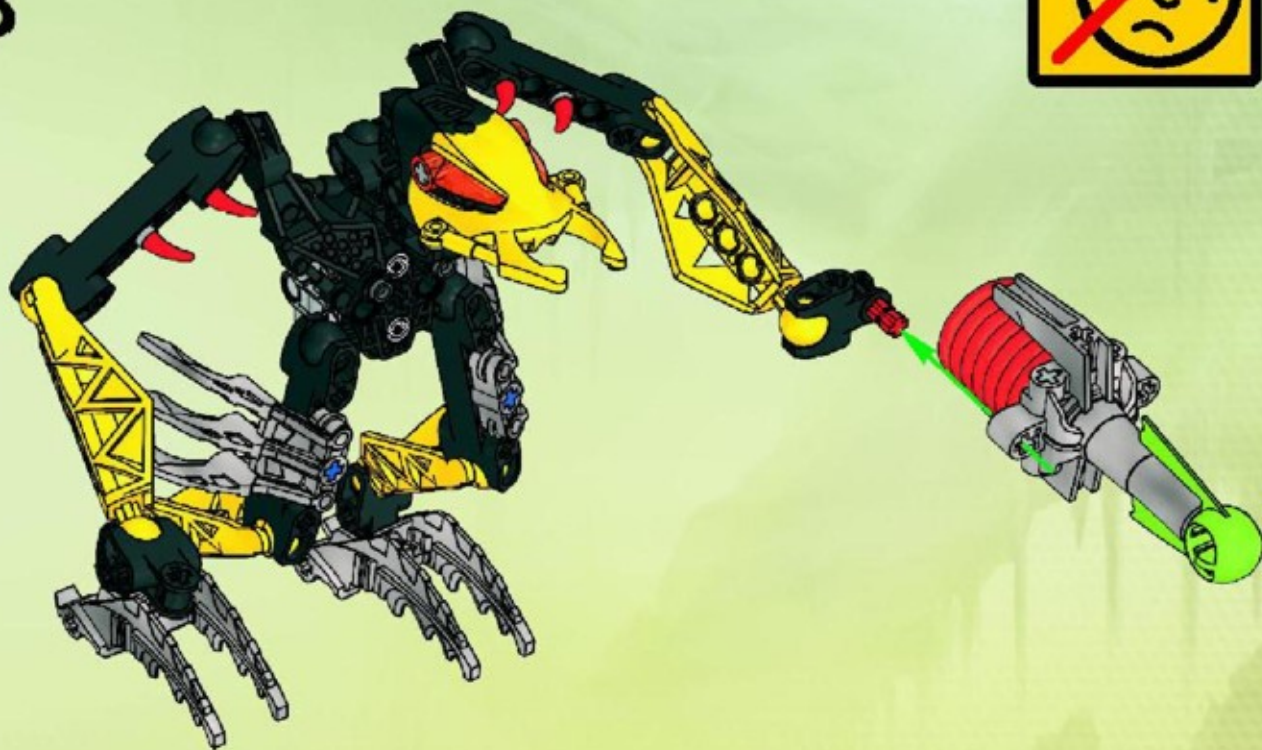

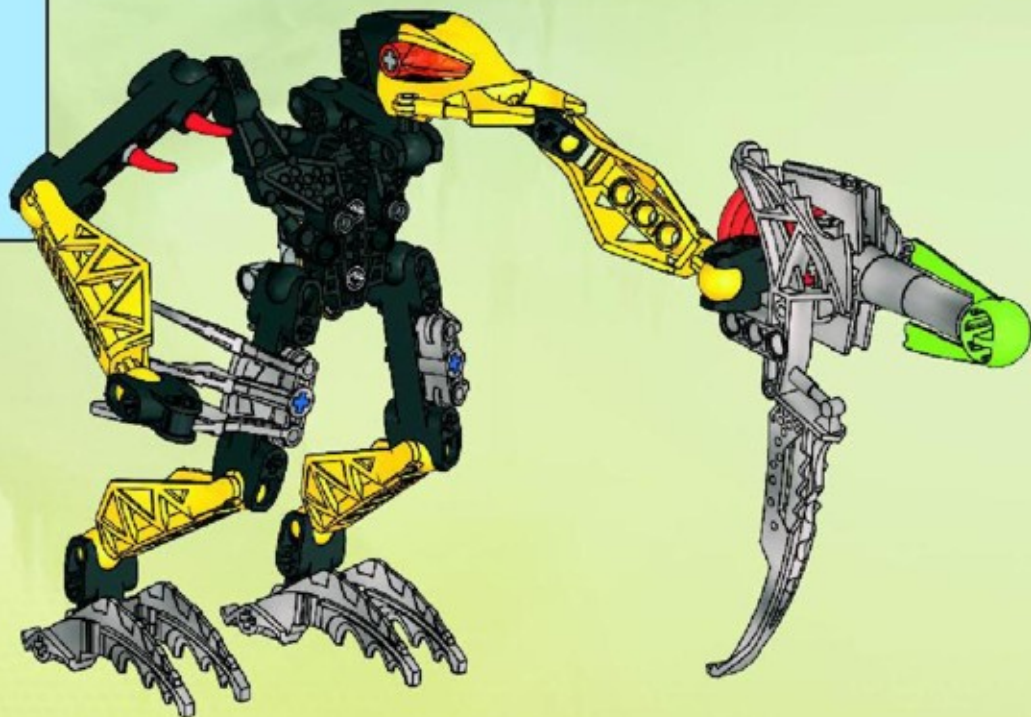
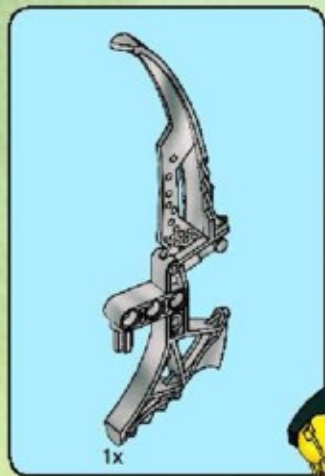

9

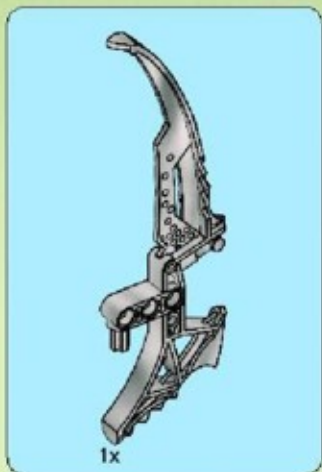

10



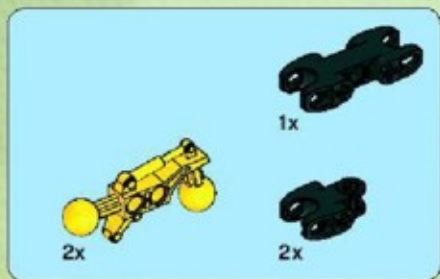

11

1

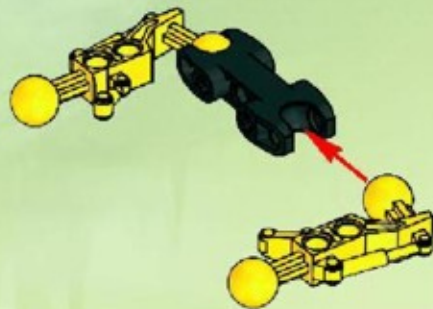

2

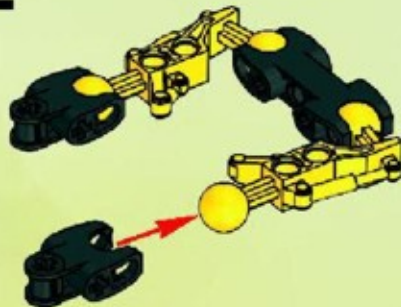



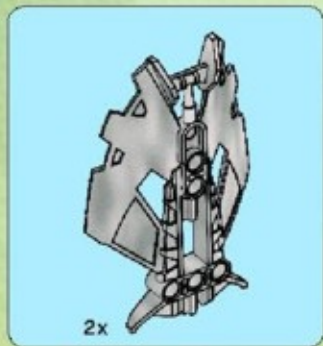

12

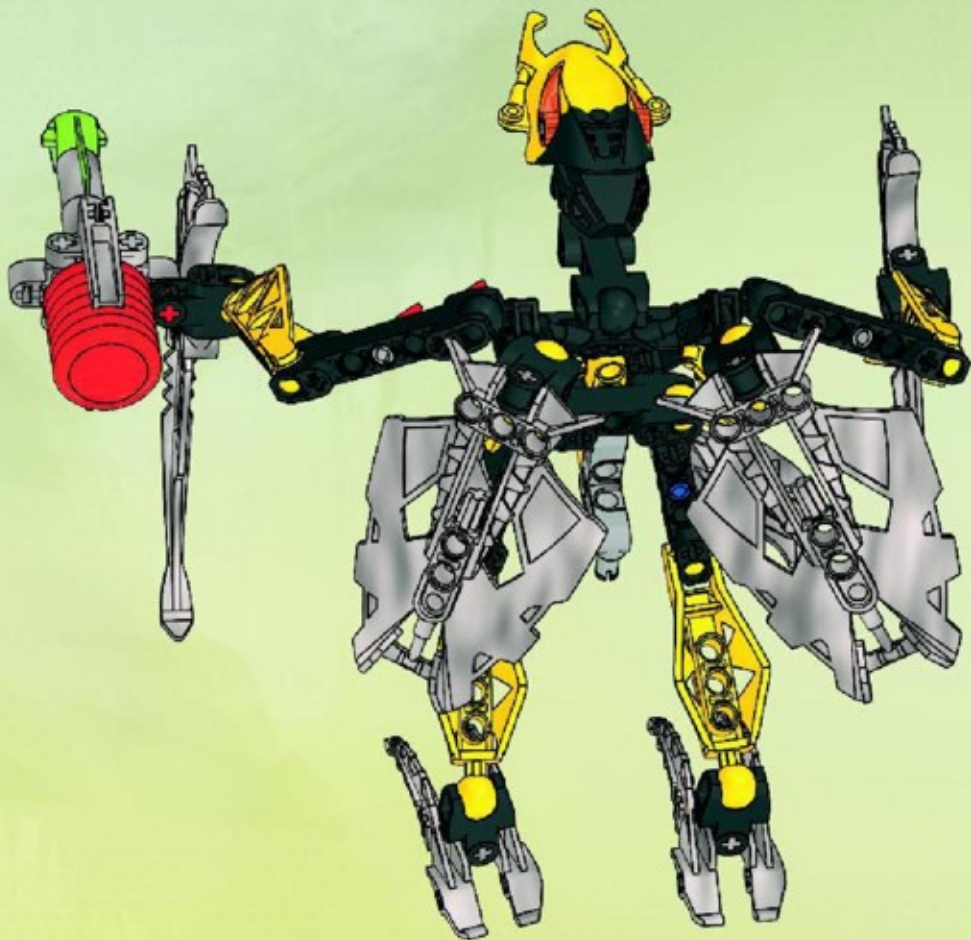

2x
4142865

4x
4276053

1x
4535379

2x
4163574

2x
4528082

1x
4142133

4x
4527054

1x
4538000

6x
4519244

2x
4519243

4x
4519224

1x
4528081

1x
4520075

2x
4121715

2x
4525722

1x
4296059

2x
4211483

3x
4211815

2x
4206482

2x
4211086

2x
4525710

2x
4526633

2x
4528083

2x
4525717

1x
4525719



Customer Service

Kundenservice

Service Consommateurs

Servicio Al Consumidor

www.lego.com/service or dial

: 00800 5346 5555																					
: 1-800-422-5346																					



8948



8696



8948+8696



22 8688



8689



8690



8694



8695



8696



club™



FREE LEGO Magazine • GRATUIT • GRATIS LEGO Magazin



Join Today!

**Abonne-toi
dès aujourd'hui!**

Meld je nu aan!

Jetzt anmelden!



  US & Canada only

1-866-534-6258 / 1-877-518-5346

(en français)



00800 5346 5555

www.LEGOclub.com

**VISIT THE WORLD'S
BIGGEST LEGO® SHOP!**

www.LEGOshop.com



WIN LEGO® PRODUCTS

No purchase necessary.
Open to residents of all countries where
not prohibited.
Go to www.aim.dk for official rules and details.

WIN LEGO® PRODUCTEN

Kopen niet nodig.
Open voor alle leeftijden, en in alle landen
waar geen verbod geldt.
Ga naar www.aim.dk voor officiële regels en details.

GEWINNE LEGO® PRODUKTE

Die Teilnahme am Gewinnspiel führt zu
keinerlei Kaufverpflichtungen.
Sie können in allen nicht ausgeschlossenen
Ländern teilnehmen.
Die offiziellen Regeln und nähere Informationen
finden Sie unter www.aim.dk.

GAGNE DES PRODUITS LEGO®

Aucun achat n'est nécessaire.
Ouvert à tous les âges et aux résidents de
tous les pays, sauf en cas d'interdiction.
Rendez-vous sur www.aim.dk pour obtenir plus
de détails et le règlement officiel.

レゴ®製品を「当てよう」

購入は不要です
禁止されていない限り、あらゆる
年代およびあらゆる国の居住者の
方々にご利用いただけます。
公認規則および詳細につきましては、
www.aim.dkをご覧ください

