



10199





## GB

### Important information about batteries

Never use different types of batteries together, or a combination of old and new batteries. Always remove the batteries if the product is not to be used for a long time or if the batteries have run down. Never use damaged batteries. Only use batteries of the type recommended, or a corresponding type. Insert the batteries so that the poles are correctly positioned. Rechargeable batteries must be recharged using the correct battery charger under the supervision of an adult. You cannot recharge batteries while they are still in the product, and you must never try to do so. Never attempt to recharge non-rechargeable batteries. Never short-circuit the battery holder.

## DE

### Wichtige Information zu Batterien

Benutzen Sie niemals unterschiedliche Arten von Batterien oder alte und neue gleichzeitig. Nehmen Sie stets die Batterien heraus, wenn mit dem Modell längere Zeit nicht gespielt wird oder wenn die Batterien leer sind. Verwenden Sie niemals beschädigte Batterien. Verwenden Sie ausschließlich empfohlene bzw. geeignete Batterien. Achten Sie beim Einsetzen der Batterien auf die richtige Polung. Wiederaufladbare Batterien sollten mit einem geeigneten Ladegerät aufgeladen werden – unter der Aufsicht eines Erwachsenen. Batterien können und sollten niemals aufgeladen werden, während sie sich im Modell befinden. Versuchen Sie unter keinen Umständen, „normale“ Batterien wieder aufzuladen. Schließen Sie das Batteriefach niemals kurz.

## FR

### Informations importantes concernant les piles

Ne jamais utiliser un mélange de différents types de piles, ou de piles neuves et de piles anciennes ou déjà utilisées. Toujours retirer les piles si le produit n'est pas utilisé durant une période prolongée ou si les piles sont vides. Ne jamais utiliser de piles endommagées. Utiliser uniquement des piles du type recommandé ou d'un type équivalent. En insérant les piles, respecter scrupuleusement le sens d'orientation des pôles (+/-). Les piles rechargeables doivent être rechargées en utilisant un chargeur de piles adéquat et sous la surveillance d'un adulte. Il est impossible de recharger les piles quand elles sont installées dans le produit. Ne jamais tenter de le faire. Ne jamais essayer de recharger des piles non-rechargeables. Ne jamais court-circuiter le compartiment des piles.

## IT

### Importanti informazioni sulle batterie

Non usare mai contemporaneamente batterie di tipo diverso o batterie nuove e usate insieme. Rimuovere sempre le batterie qualora il prodotto non venga utilizzato per periodi prolungati, oppure se le batterie sono esauste. Non utilizzare mai batterie danneggiate. Usare esclusivamente batterie del tipo raccomandato o un equivalente. Inserire le batterie avendo cura che la loro polarità sia corretta. Le batterie ricaricabili vanno ricaricate in un caricabatterie di tipo idoneo e con la supervisione di un adulto. Non è possibile e non bisogna mai tentare di ricaricare le batterie mentre queste sono inserite nel prodotto. Non tentare mai di ricaricare le batterie non ricaricabili. Non cortocircuitare mai il portabatterie.

## NL

### Belangrijke informatie over batterijen

Gebruik nooit verschillende soorten of nieuwe en oude batterijen tegelijkertijd. Verwijder de batterijen altijd als je het product lange tijd niet wilt gebruiken of als de batterijen leeg zijn. Nooit beschadigde batterijen gebruiken. Uitsluitend batterijen van het aanbevolen of overeenkomstige type gebruiken. Leg de batterijen met de polen in de juiste richting. Opladbare batterijen moeten in een voor dit doel bestemde oplader en onder toezicht van een volwassene opnieuw worden opgeladen. Opladbare batterijen kunnen niet in het product worden opgeladen en je mag dit ook niet proberen te doen. Probeer nooit niet-oplaadbare batterijen op te laden. Nooit de batterijhouder kortsluiten.

## ES

### Importante información sobre las baterías

No mezclar nunca diferentes tipos de baterías, ni utilizar baterías antiguas y nuevas a la vez. Sacar siempre las baterías, si el producto no se utiliza por un largo periodo de tiempo o si las baterías están desgastadas. No utilizar nunca baterías dañadas. Utilizar solo el tipo de baterías recomendado o uno correspondiente. Colocar las baterías de manera que los polos están en su posición correcta. Las baterías recargables deben cargarse con un cargador adecuado bajo la supervisión de un adulto. Las baterías no pueden ni deben recargarse mientras permanecen en el producto. No intentar nunca recargar baterías no recargables. Asegurarse que no se produzca un cortocircuito en el porta baterías.

## DA

### Vigtig information om batterier

Brug aldrig forskellige typer batterier sammen, eller nye og gamle batterier samtidig. Tag altid batterierne ud, hvis du ikke skal bruge produktet i længere tid, eller hvis batterierne er brugt op. Anvend aldrig beskadigede batterier. Der må kun anvendes batterier af samme eller tilsvarende type som anbefalet. Batterierne skal vende rigtigt når de i sættes. Genopladelige batterier skal oplades i en dertil beregnet oplader under opsyn af en voksen. Genopladelige batterier kan og må ikke forsøges oplades i produktet. Forsøg aldrig at genlade ikke-genopladelige batterier. Kortslut aldrig batterikassens kontaktpåder.

## FI

### Tärkeää tietoa paristoista

Älä koskaan käytä erityyppisiä paristoja yhdessä. Älä myöskään käytä samassa laitteessa sekä vanhoja että uusia paristoja. Poista paristot tuotteesta aina, kun se on pitemmän aikaa käytämättä, tai kun paristot ovat tyhjentyneet. Älä koskaan käytä viallisia paristoja. Käytä vain tuoteessa suositeltuja tai vastaavantyyppisiä paristoja. Aseta paristot siten, että navat osoitettavat oikeaan suuntaan. Ladattavat paristot on ladattava oikeanlaisella laiturilla aikuisen valvonnassa. Ne on poistettava tuotteesta lataamisen ajaksi. Älä koskaan yritä ladata paristoja, joita ei ole tarkoitettu ladattaviksi. Älä koskaan aiheuta oikosulkua pariston kosketin välillä.

## SV

### Viktig information om batterier

Använd aldrig olika sorters batterier samtidigt, och inte heller en kombination av gamla och nya batterier. Ta alltid ur batterierna om produkten under en längre tid inte ska användas eller om batterierna är slut. Använd aldrig skadade batterier. Använd bara batterier av den typ som rekommenderats, eller av en motsvarande typ. Sätt i batterierna så att polerna hamnar i rätt läge. Laddningsbara batterier måste laddas med rätt slags batteriladdare och under en vuxens överinnsyn. Du kan inte ladda batterierna medan de fortfarande sitter i produkten, och du får heller aldrig försöka göra det. Försök aldrig ladda icke laddningsbara batterier. Kortslut aldrig batteriutrymmets kontaktytor.

## PT

### Informações importantes acerca das pilhas

Nunca use tipos diferentes de pilhas em conjunto, nem uma combinação de pilhas velhas e novas. Retire sempre as pilhas se o produto não vai ser utilizado durante muito tempo ou se as pilhas se tiverem gastado. Nunca use pilhas danificadas. Use apenas pilhas do tipo recomendado ou de um tipo correspondente. Introduza as pilhas de forma a que os seus polos fiquem correctamente posicionados. Pilhas recarregáveis deverão ser recarregadas utilizando o recarregador de pilhas correcto sob a supervisão de um adulto. Não é possível recarregar pilhas recarregáveis enquanto elas ainda se encontram dentro do produto, e nunca devem ser feitas tentativas nesse sentido. Nunca tente recarregar pilhas não recarregáveis. Nunca faça curto-circuito do compartimento das pilhas.

## EL

### Σημαντικές πληροφορίες για τις μπαταρίες

Μη χρησιμοποιείτε ποτέ διαφορετικούς τύπους μπαταριών, ή παλιές και καινούριες μπαταρίες μαζί. Βγάτε πάντα τις μπαταρίες αν δεν χρησιμοποιήσετε το προϊόν για αρκετό καιρό ή αν οι μπαταρίες έχουν αδειάσει. Ποτέ μη χρησιμοποιείτε χαλασμένες μπαταρίες. Χρησιμοποιείτε μόνο μπαταρίες του συνιστούμενου τύπου, ή αντίστοιχου τύπου. Βεβαιώτε τις μπαταρίες με την σωστή πολικότητα. Θα πρέπει να φορτίσετε τις επαναφορτιζόμενες μπαταρίες χρησιμοποιώντας τον κατάλληλο φορτιστή μπαταριών υπό την επίβλεψη ενός ενήλικου. Δεν μπορείτε να επαναφορτίσετε τις μπαταρίες όταν αυτές βρίσκονται μέσα στο προϊόν, και ποτέ μην επιχειρήσετε να κάνετε κάτι τέτοιο. Μην επιχειρήσετε ποτέ να επαναφορτίσετε μη επαναφορτιζόμενες μπαταρίες. Ποτέ μη βραχυκυκλώσετε τη θήκη των μπαταριών.

## JA

### 電池の取り扱いに関する注意

異なるタイプの電池や、古い電池と新しい電池を混ぜて使用しないで下さい。長時間商品を使用しない時や電池が切れれば、必ず電池を取り外して下さい。電池は推奨されている種類か、もしくは対応する種類のみを使用して下さい。電極を確認して正しい方向に電池を入れてください。充電電池を使用する際は保護者の監督のもと、正しく充電をして使用して下さい。製品の中に入れては充電電池を充電することは絶対に避けてください。充電電池ではない電池を充電したり、電極をショートさせたりしないでください。



1

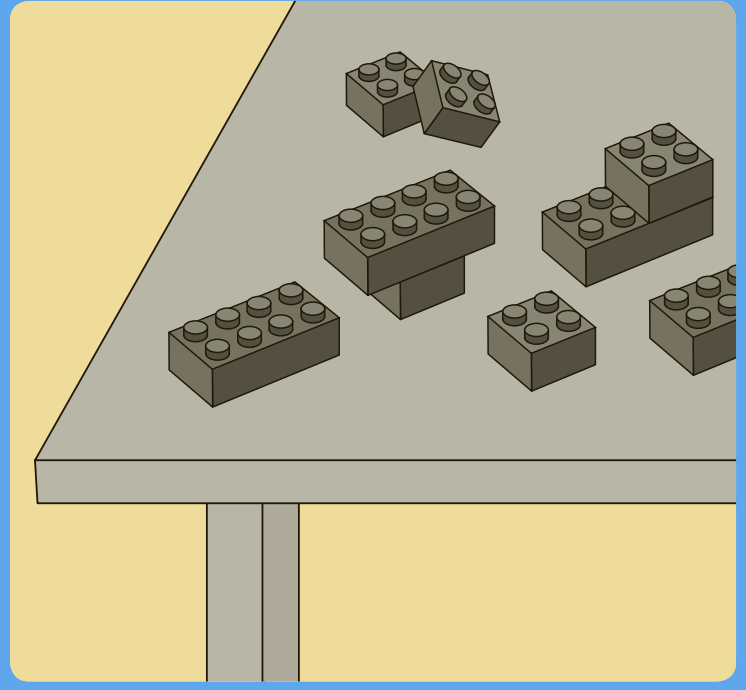
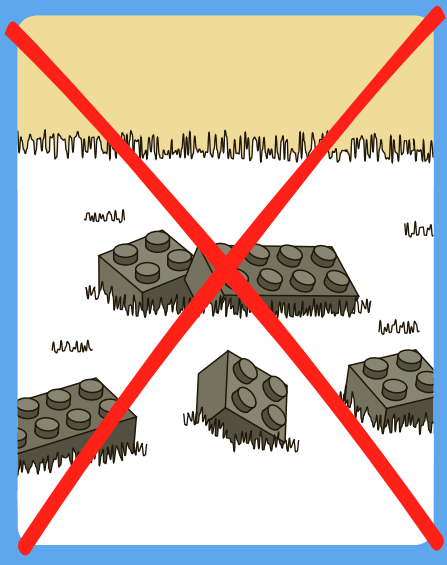

2

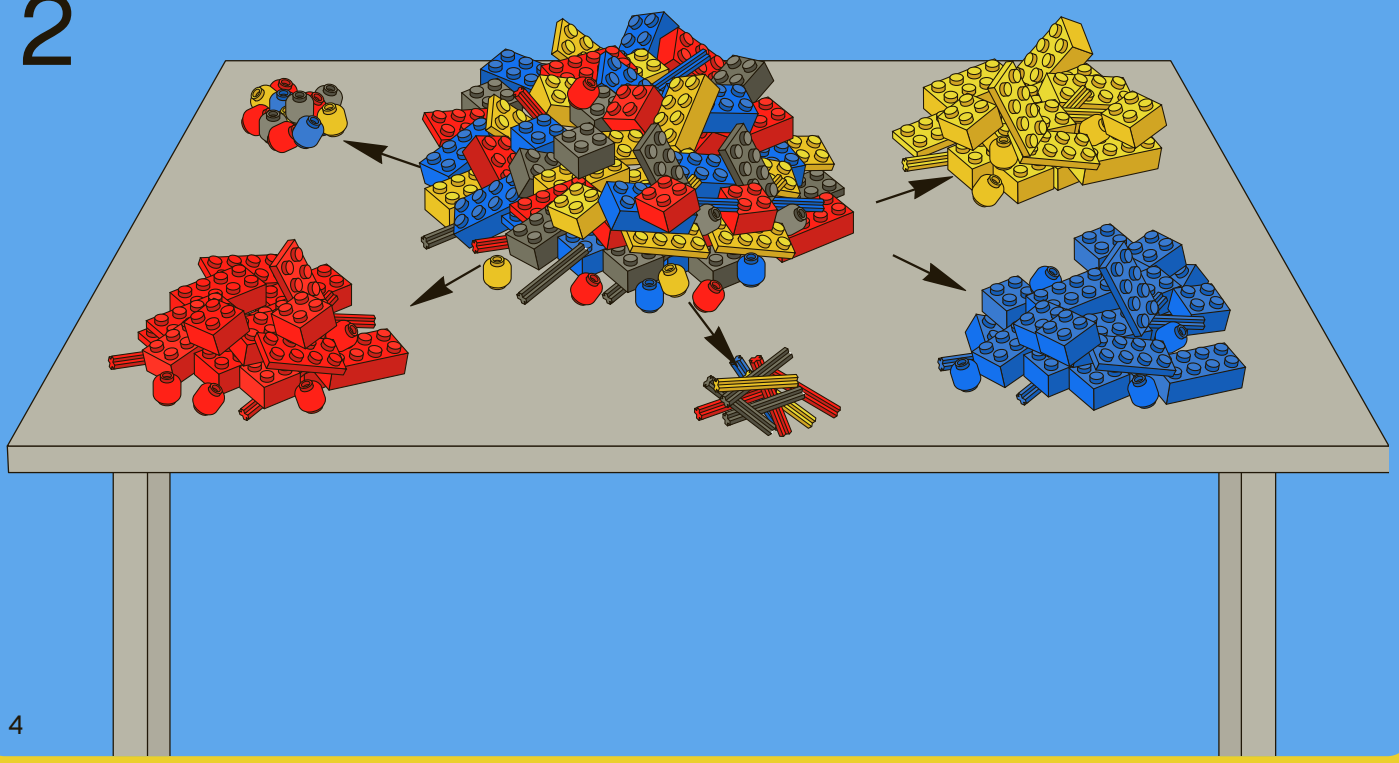

3

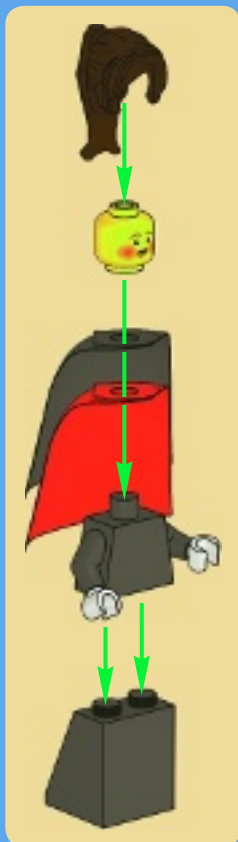

4

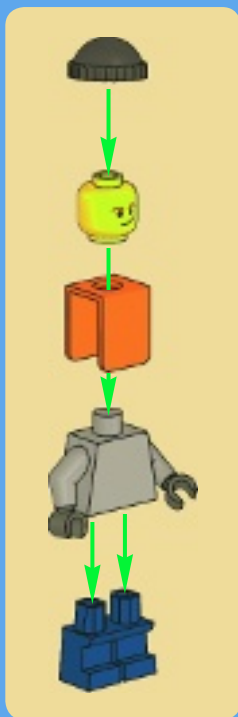



1x

1



1x



1x

2



2x



1x

3



1x



2x



1x

4



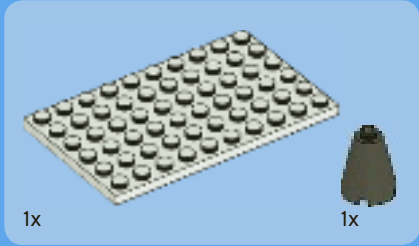

1

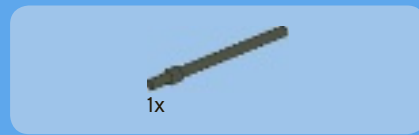

2



3

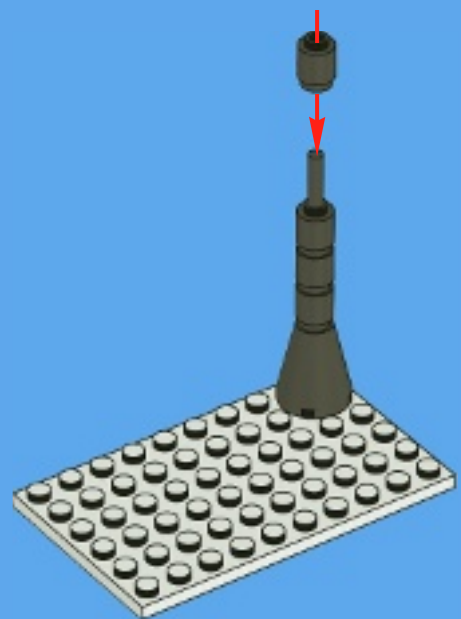



2x



1x



2x



2x



2x



1x

# 4



2x



2x



2x



4x



2x

# 5

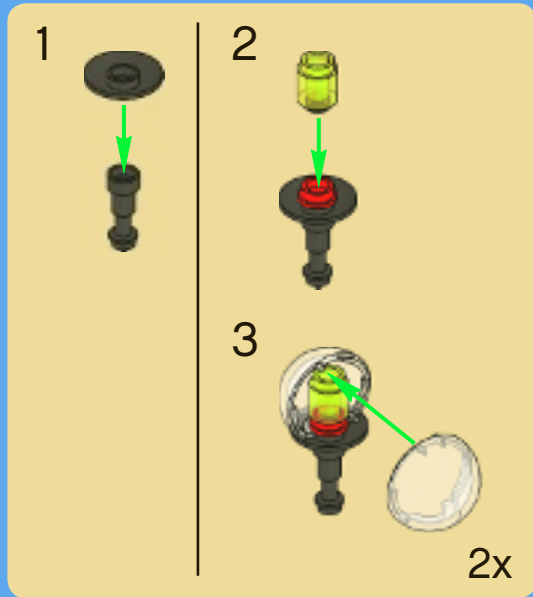



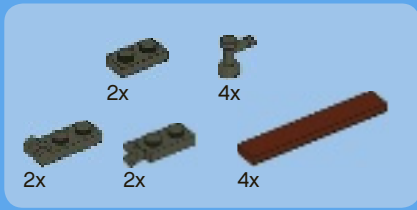

# 6

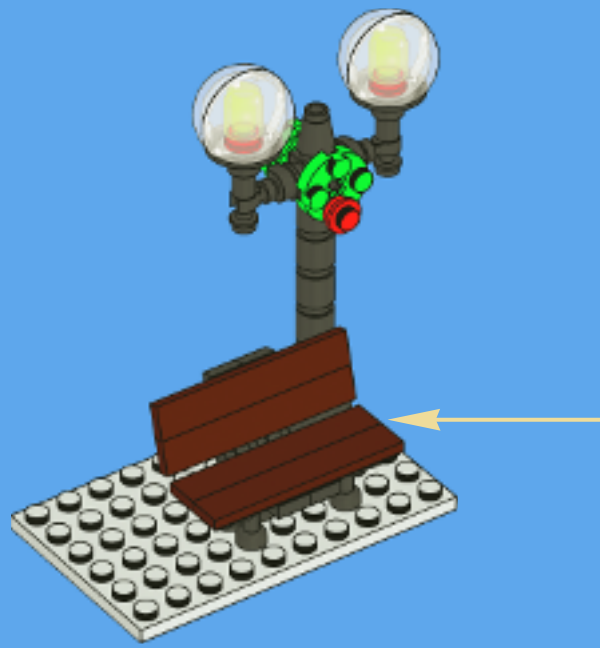
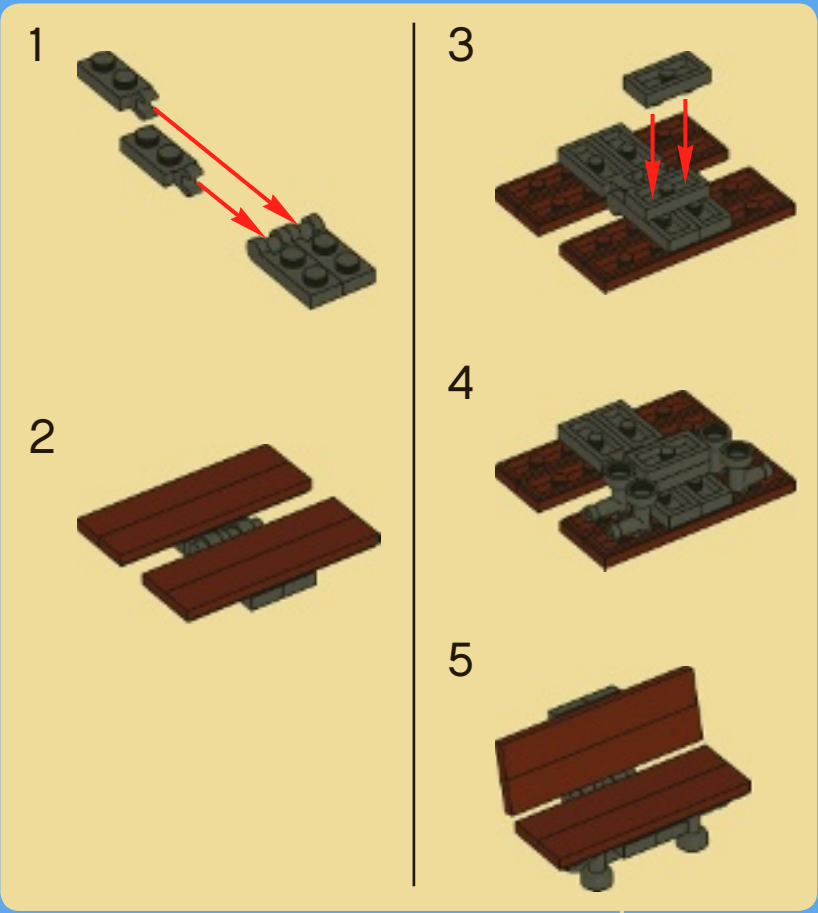

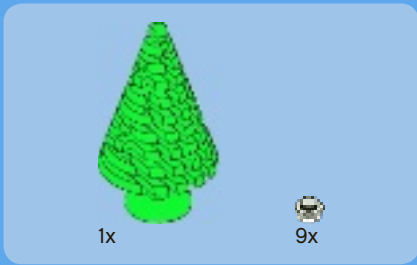

7

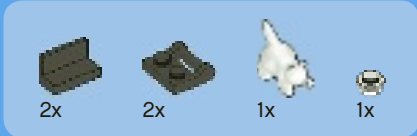

8

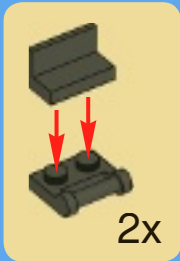

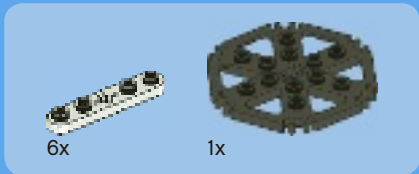

1

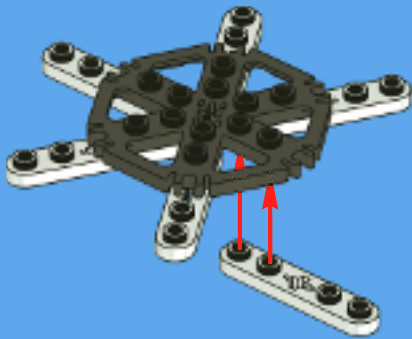

2

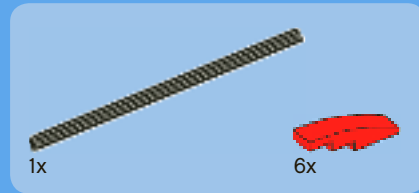
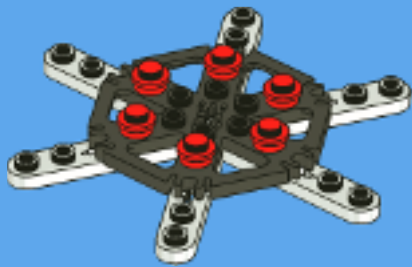

3

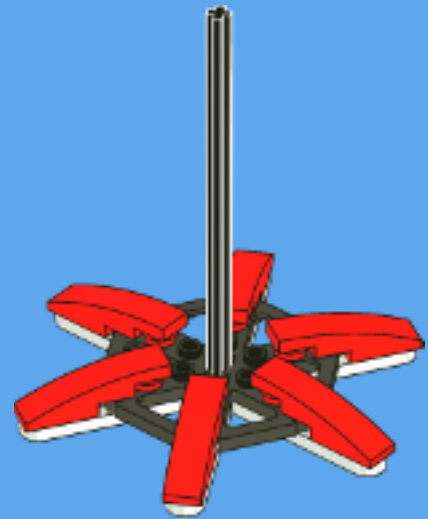

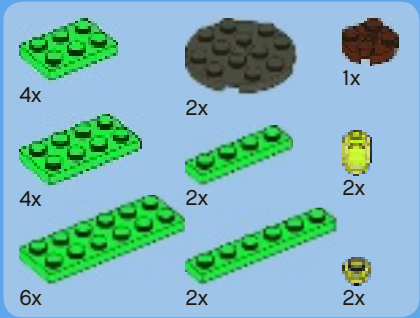

4

1



2

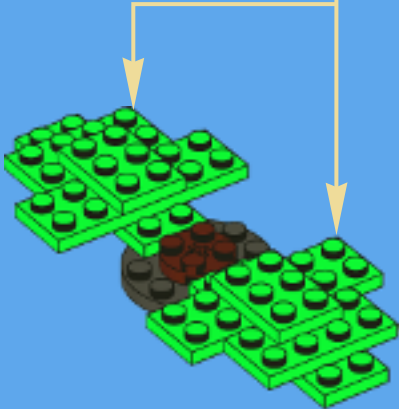

1



2

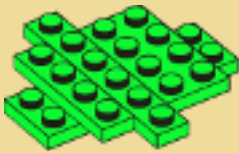

3

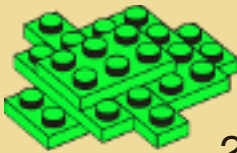

2x

3



4



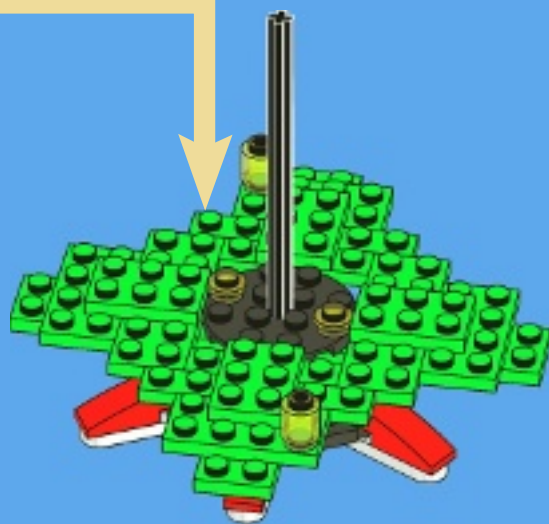

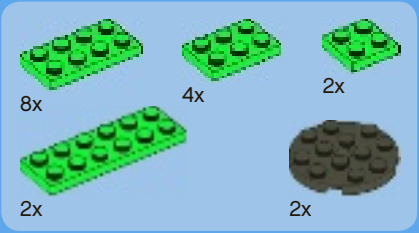

# 5

1



3

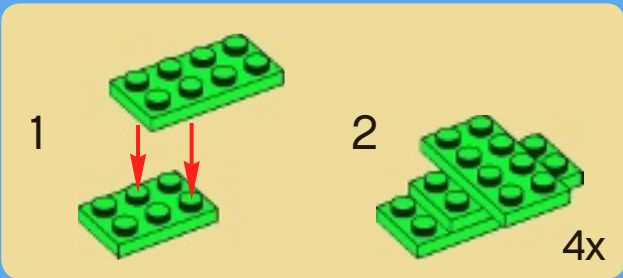
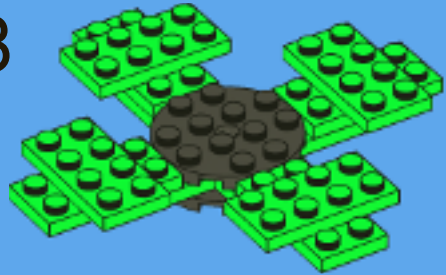

2

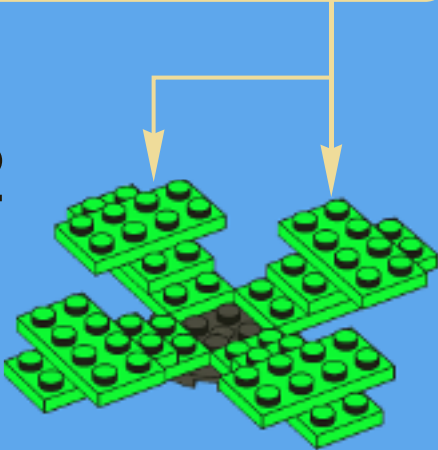

4

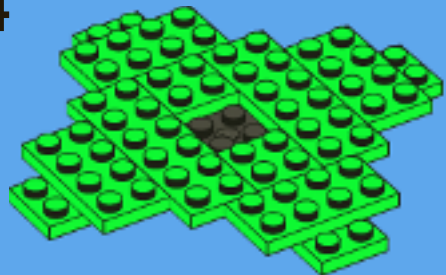

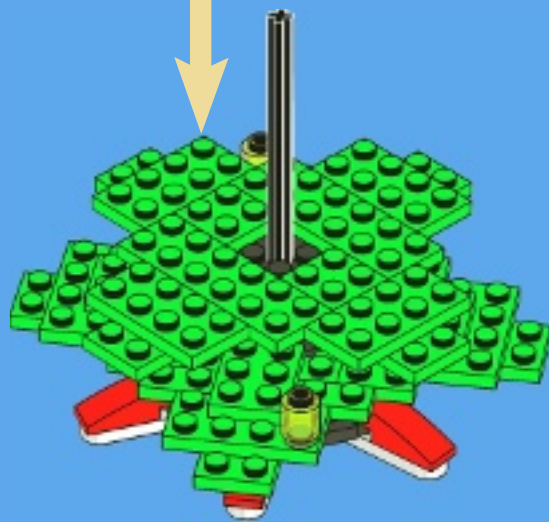



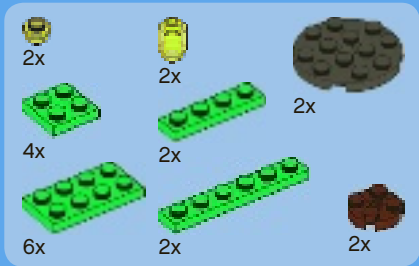

6

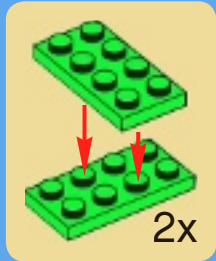

1



2

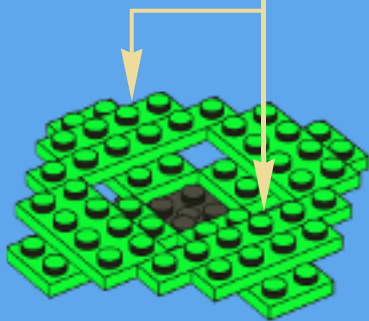

3

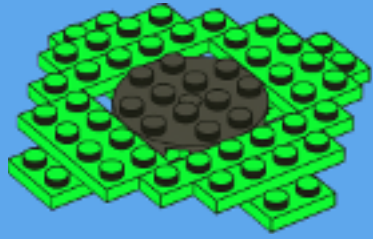

4

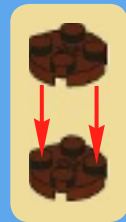
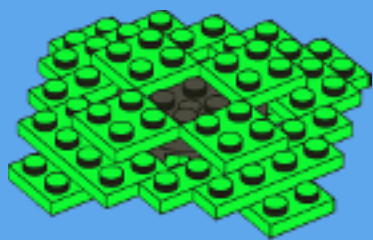

5



6





7

1



2

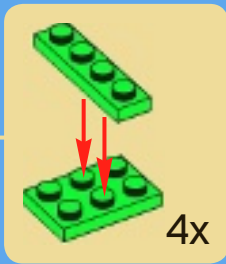

3

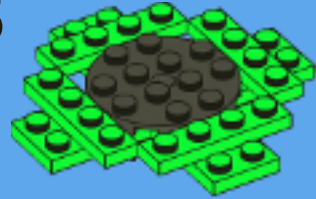

4

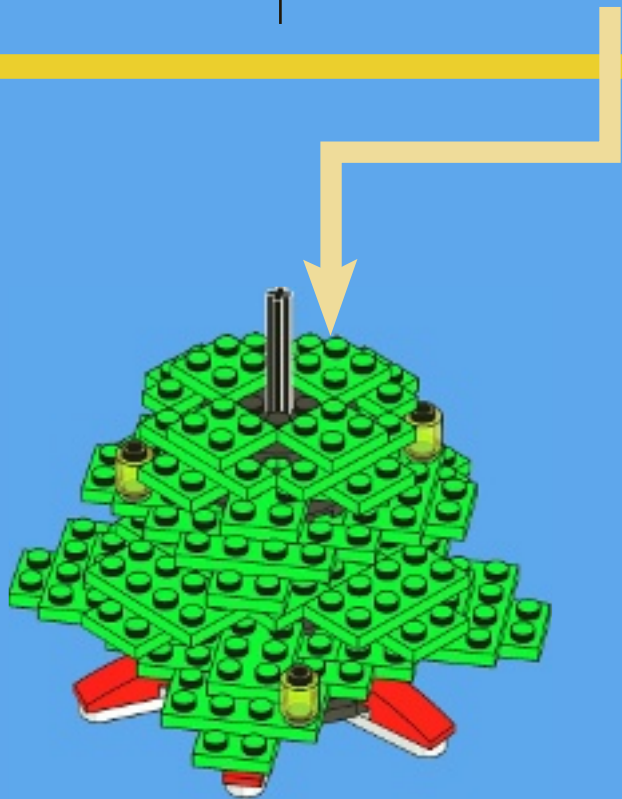
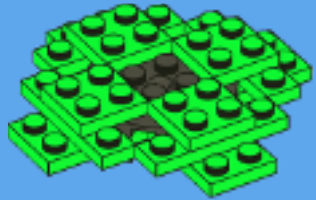



# 8

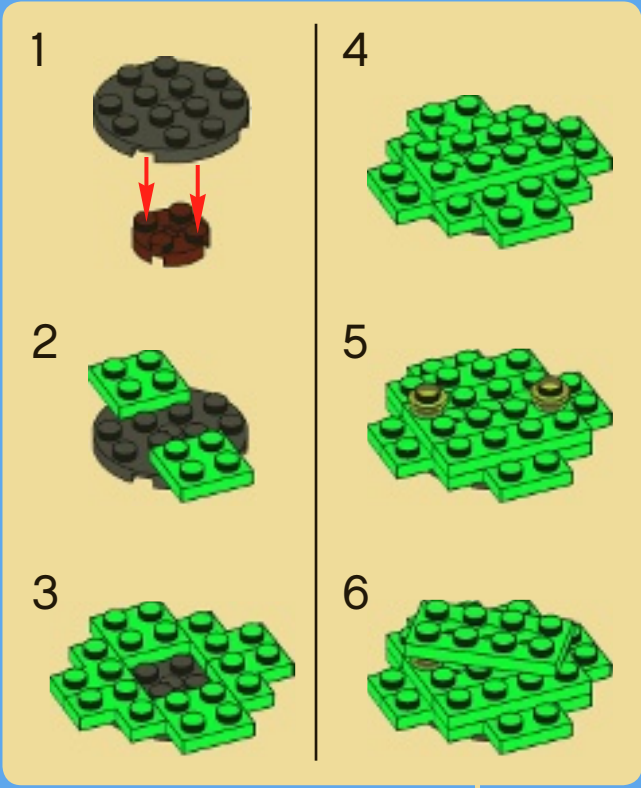

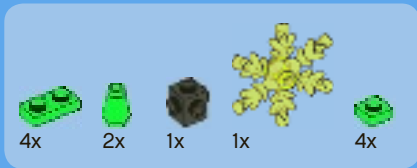

# 9

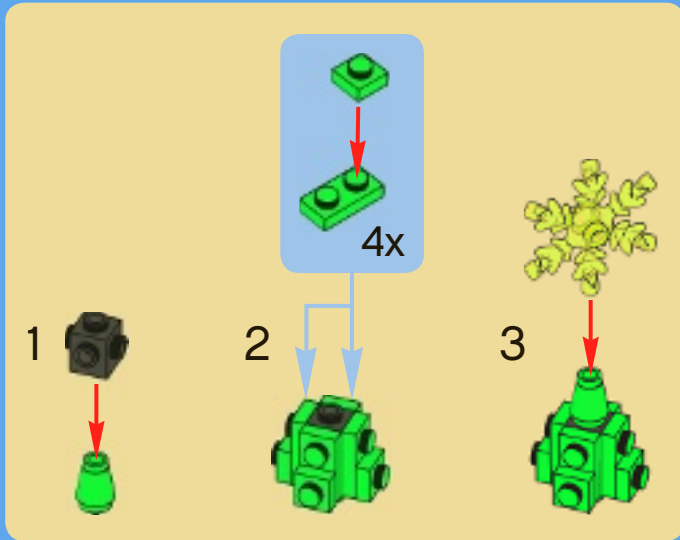



6x

# 10



6x



1x



2x

1

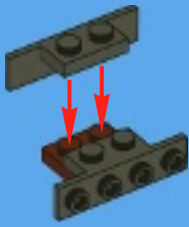

1x



1x

2



2x



1x

3

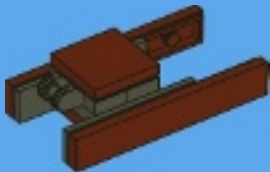

1x



1x



2x

4

1



2

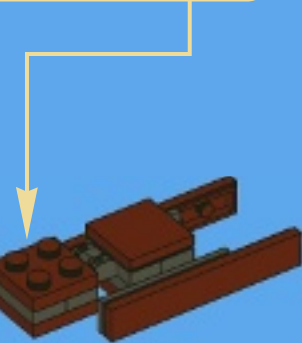
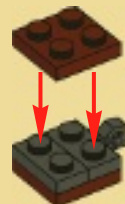

1x

5

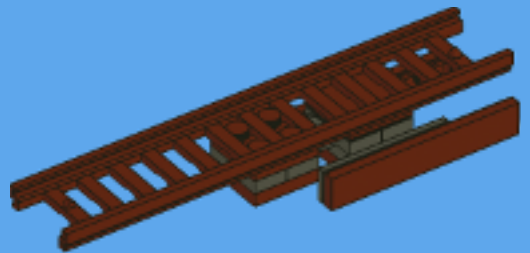



1x

# 11

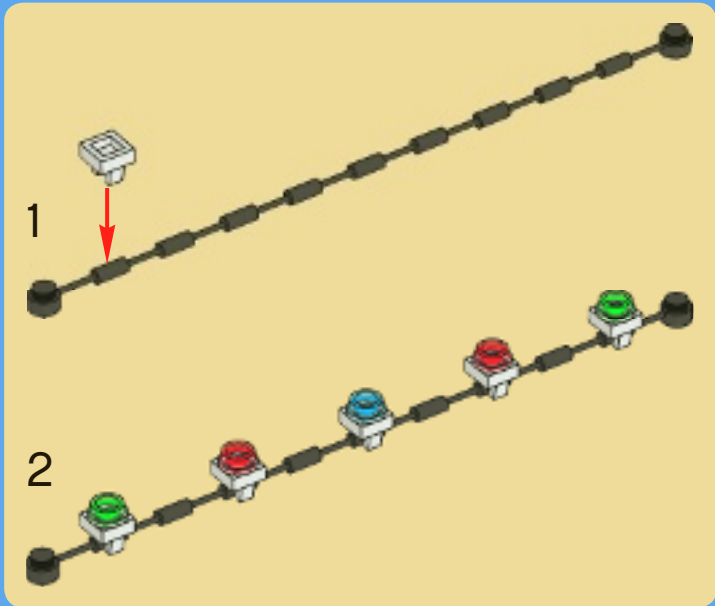



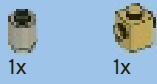

1

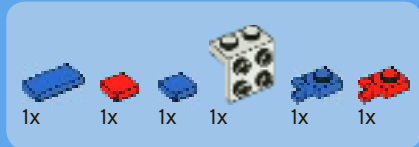

2



1

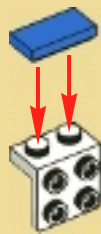

2



4

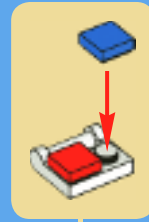

5

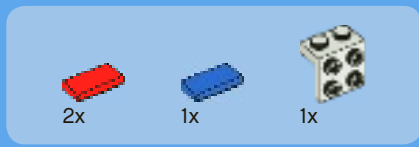
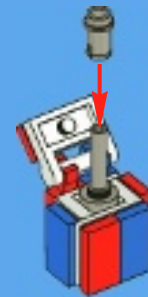

3



1

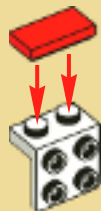

2



6

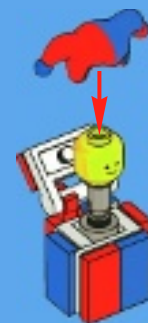

- 4x
- 3x
- 2x
- 2x
- 1x
- 2x
- 1x
- 2x
- 2x
- 1x
- 2x
- 2x
- 2x
- 2x

# 12

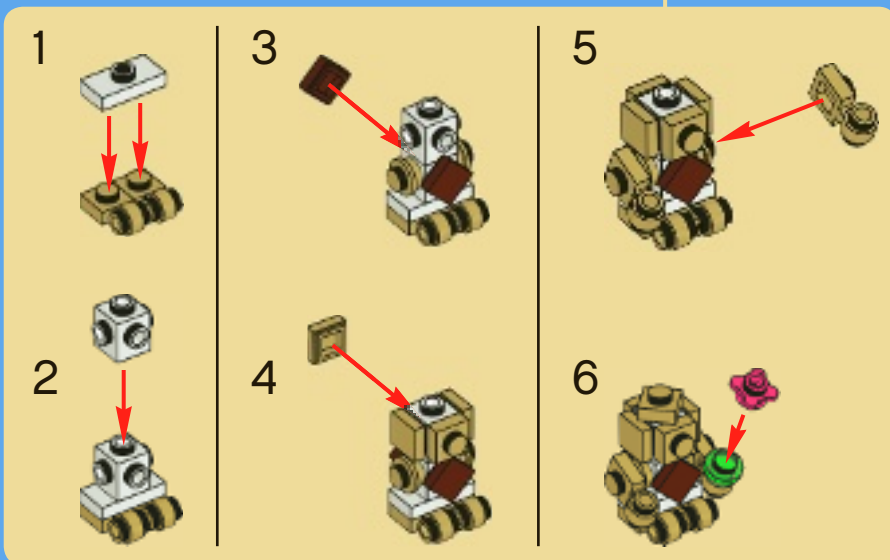
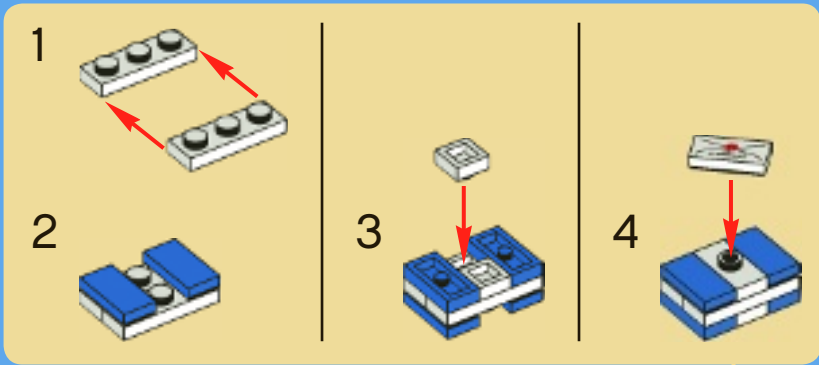

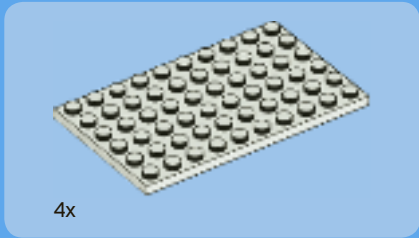

1

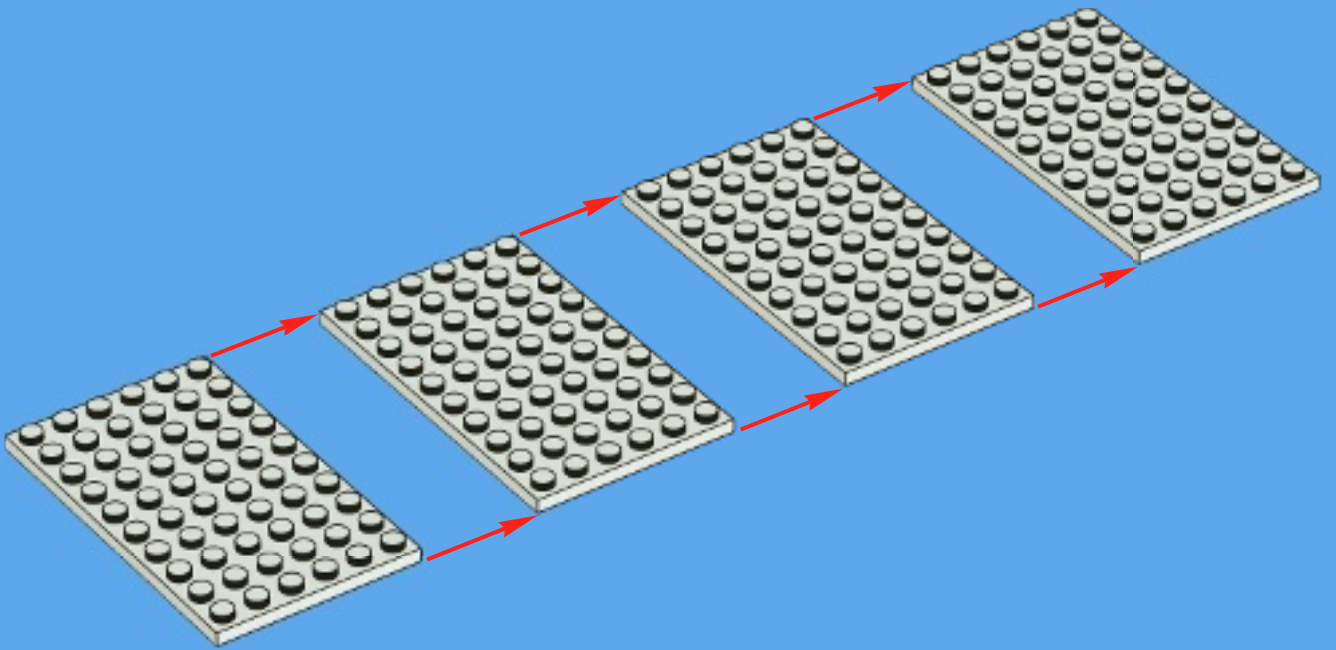



2

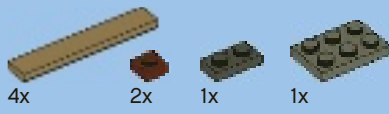
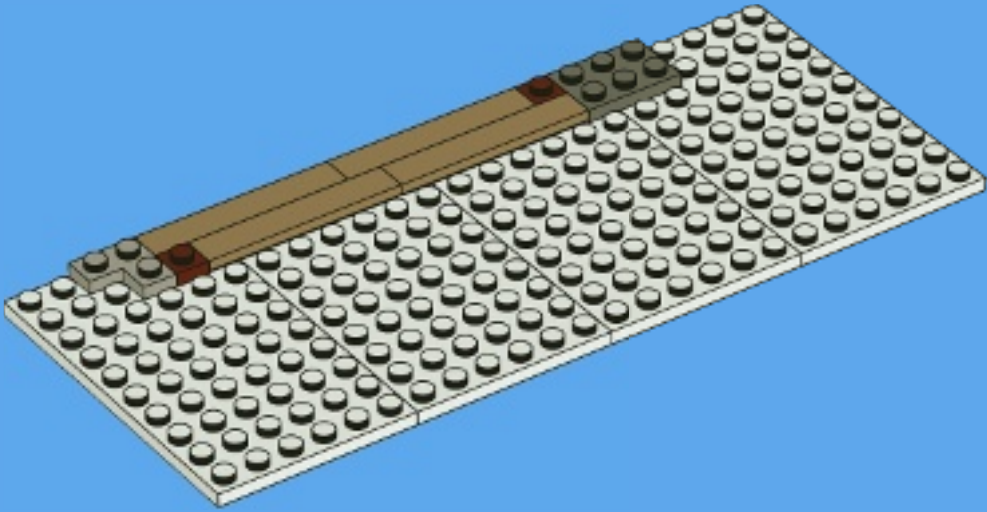

3

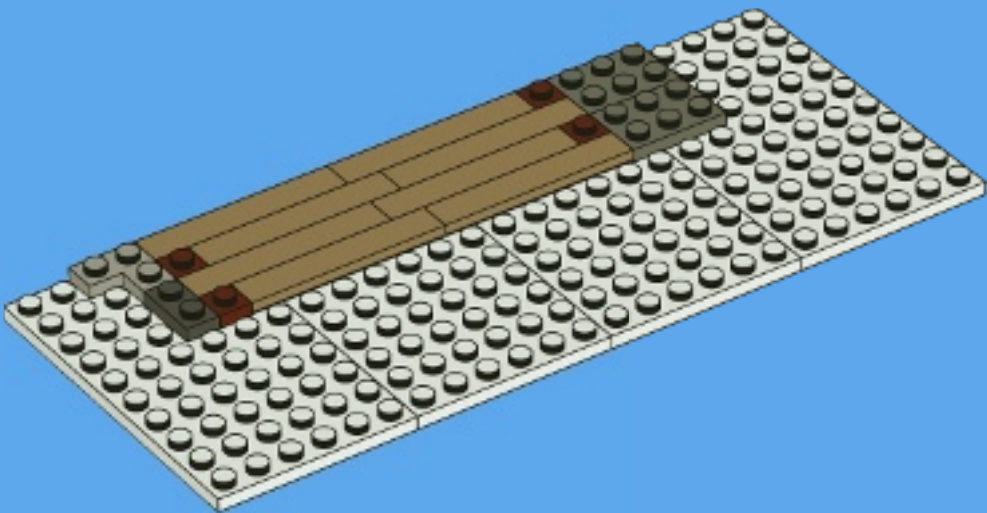

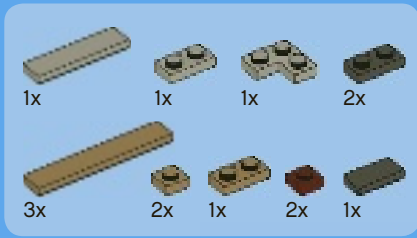

4

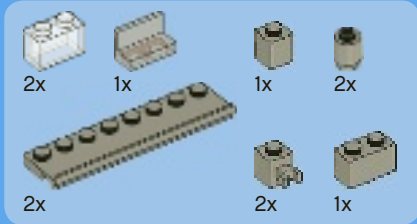
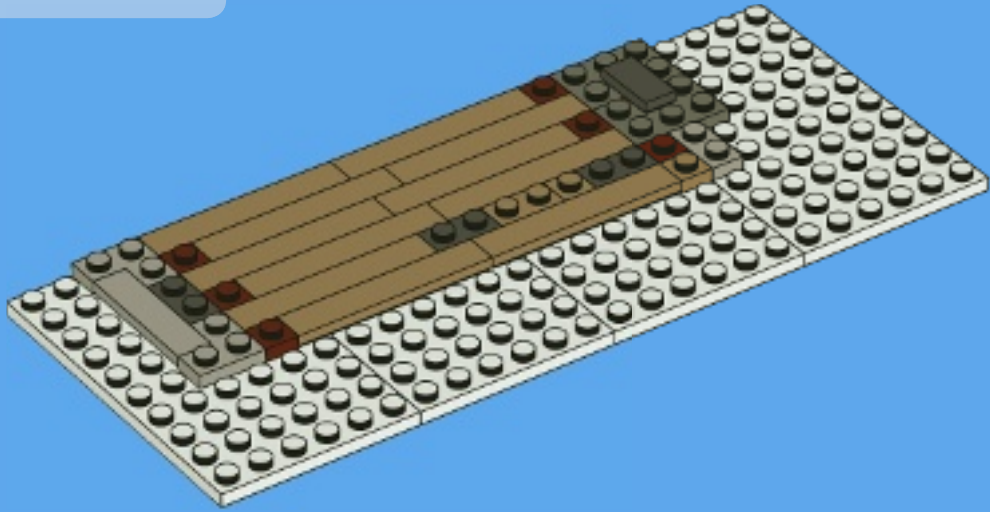

5

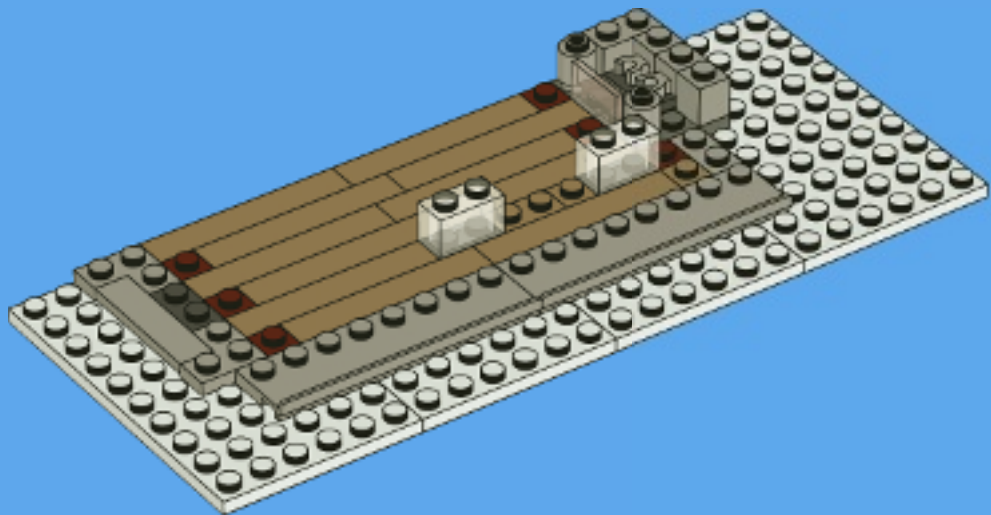

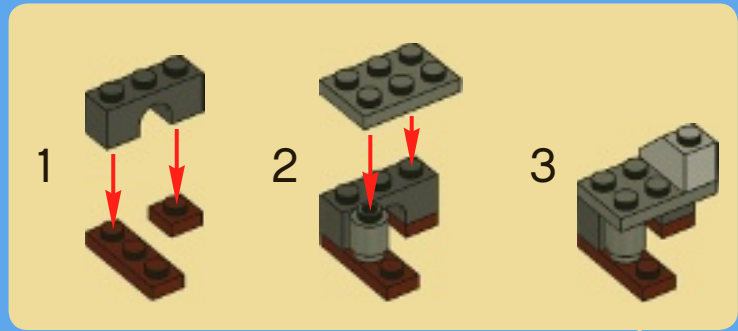

6

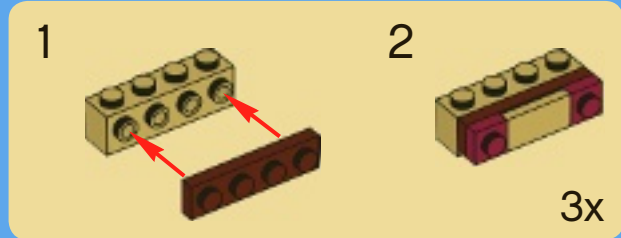
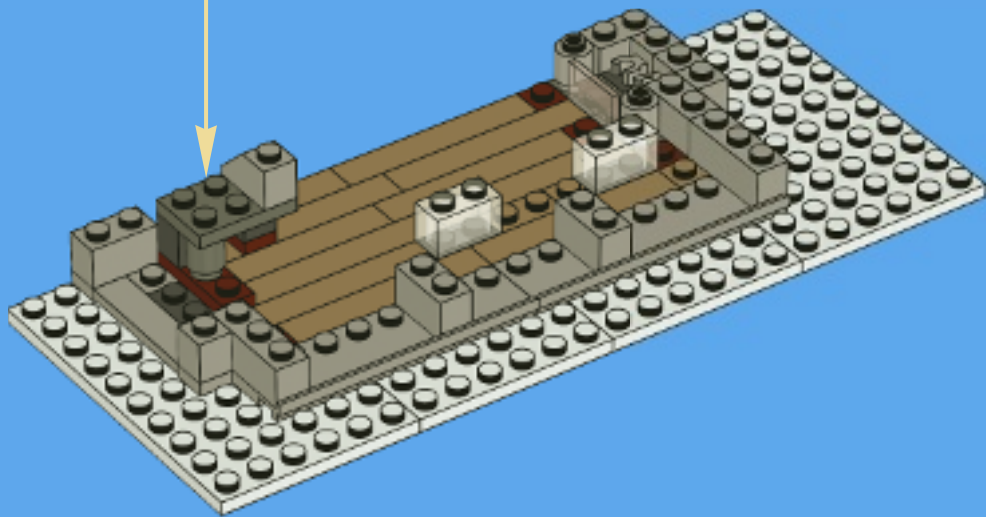

7

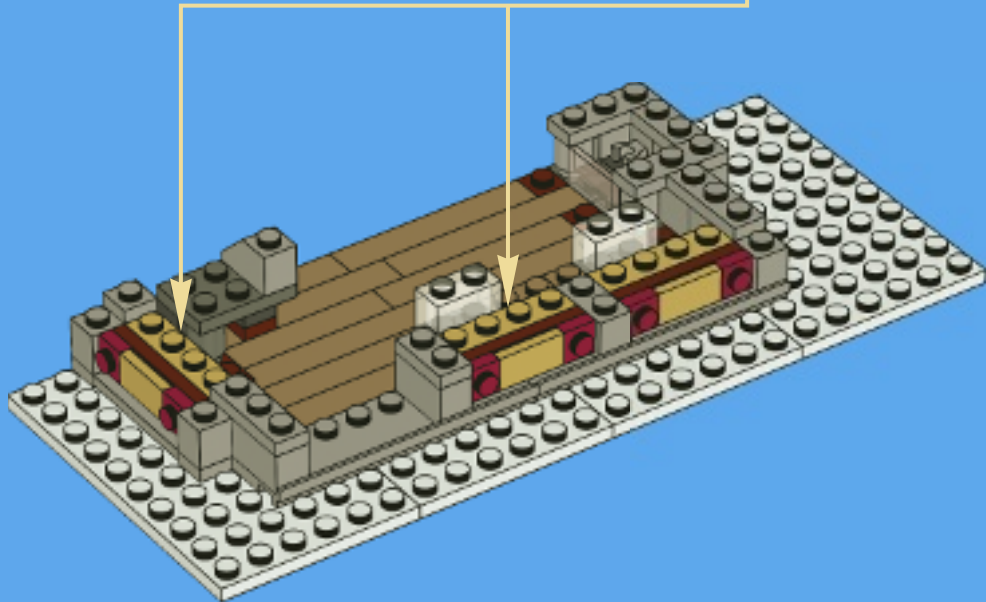

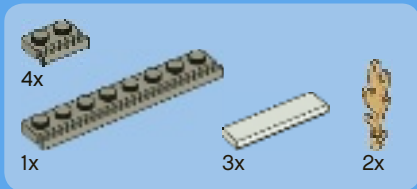

8

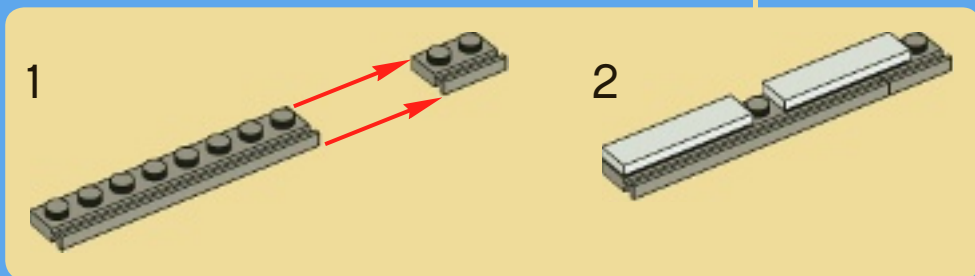
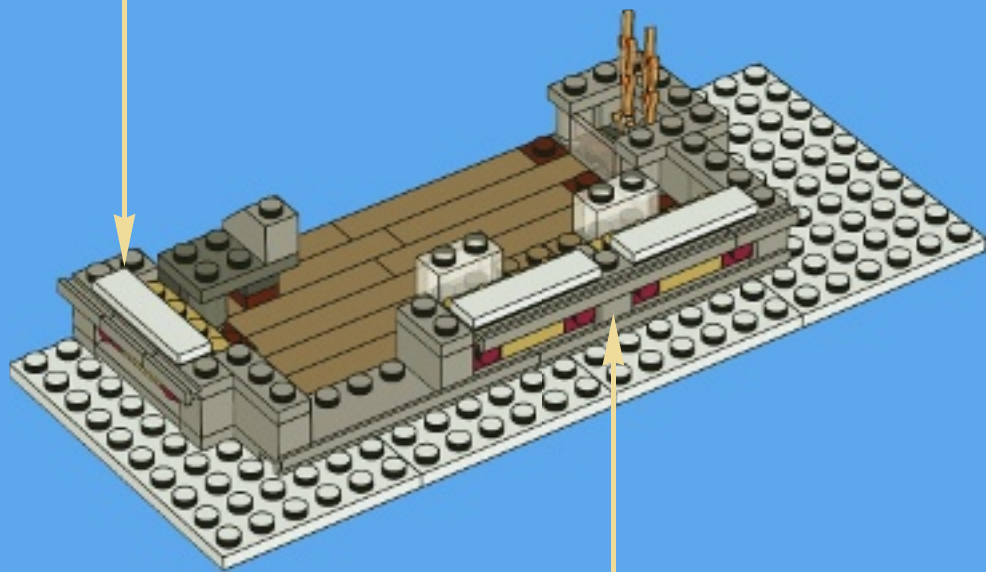
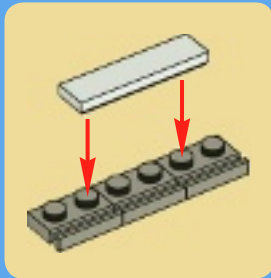

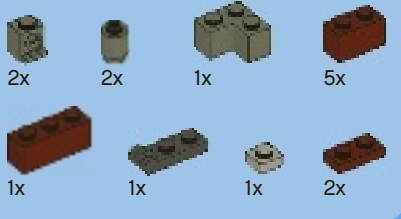

9

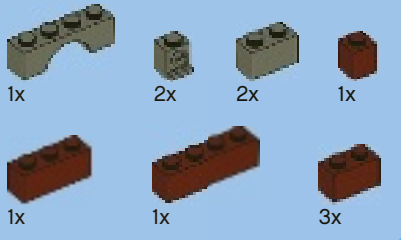
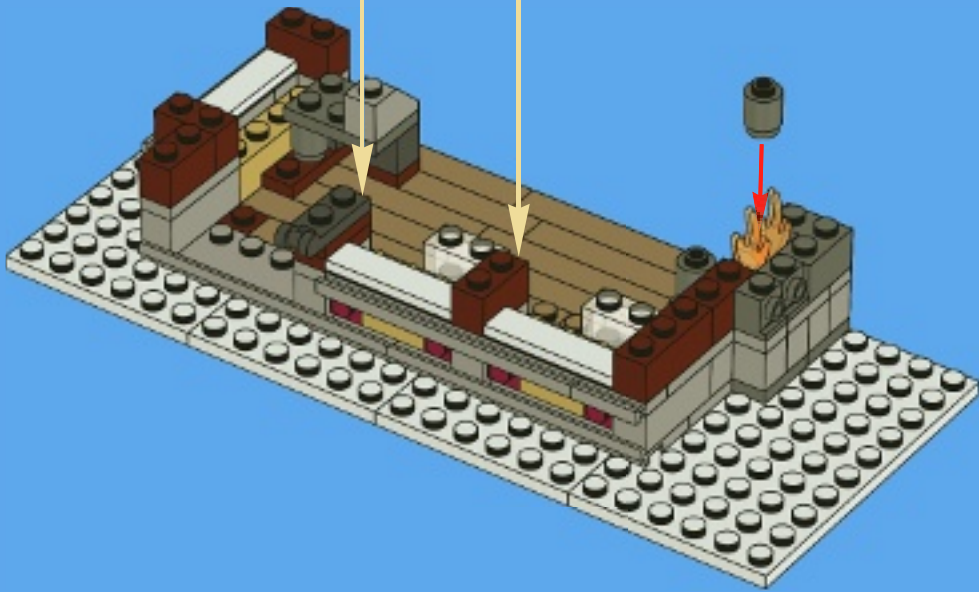
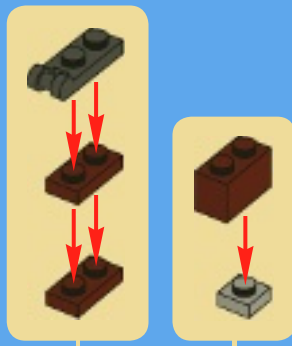

10

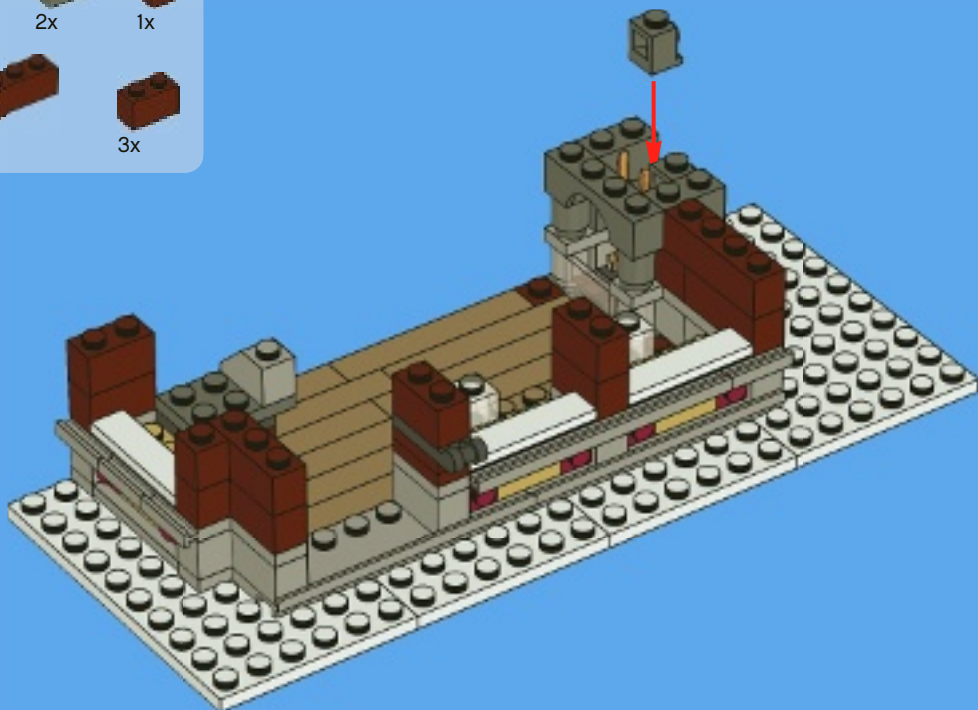





# 11

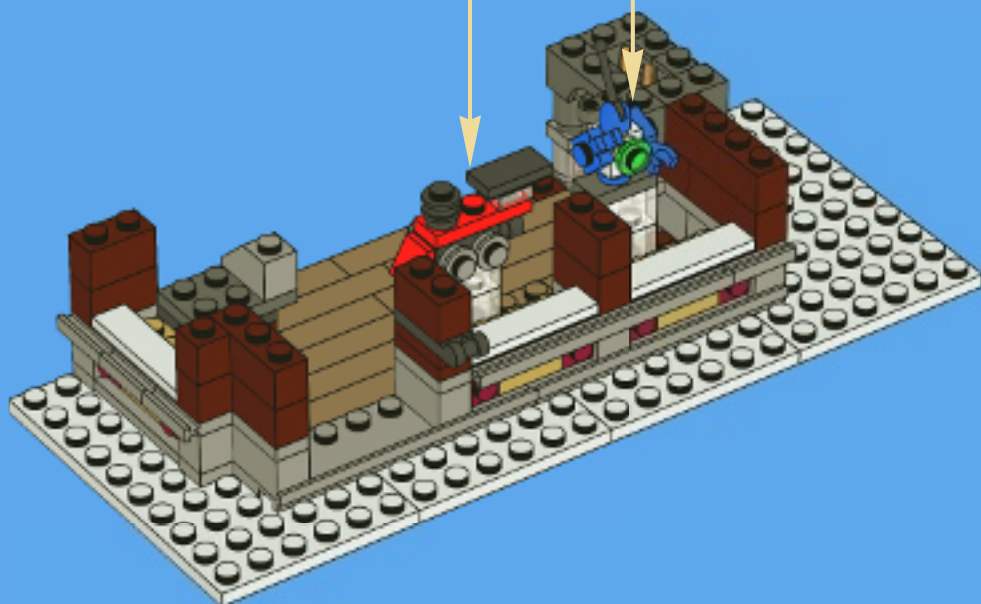
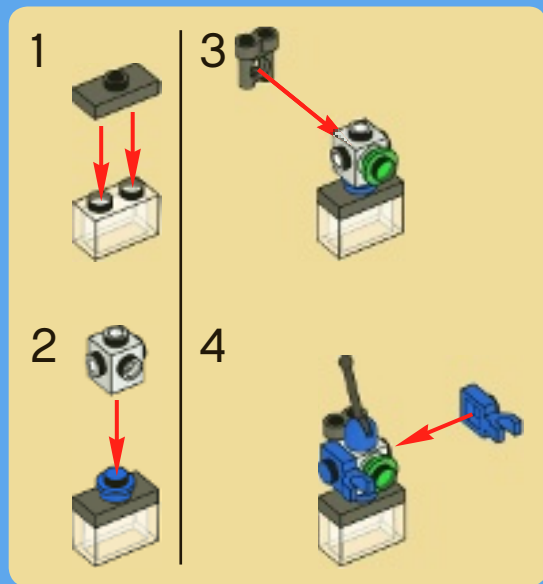
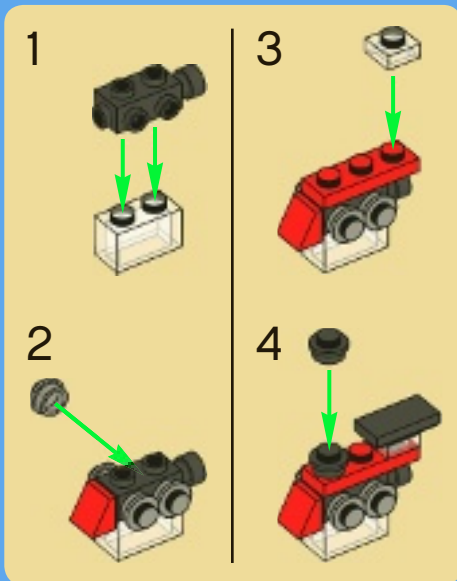

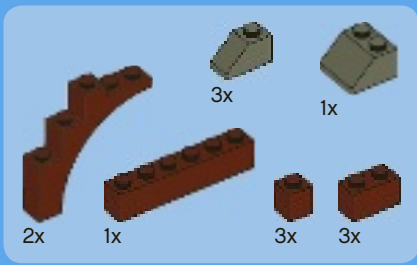

12

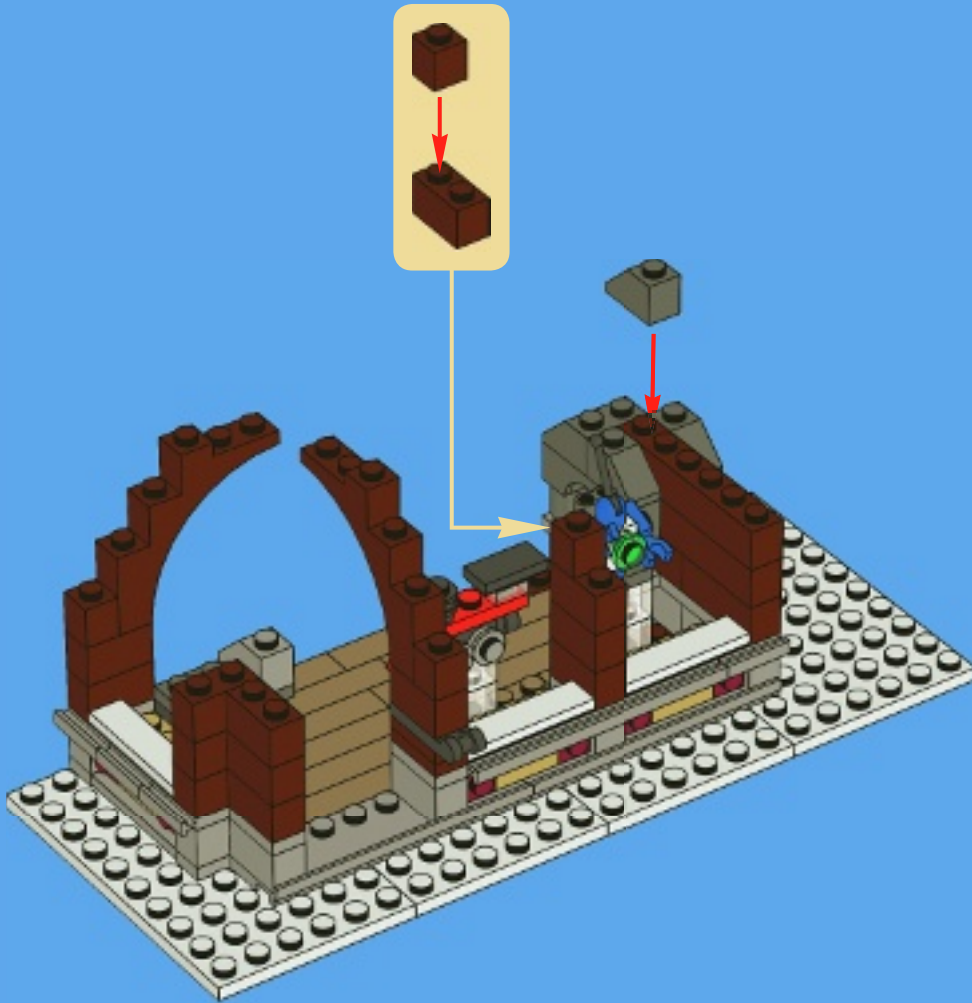

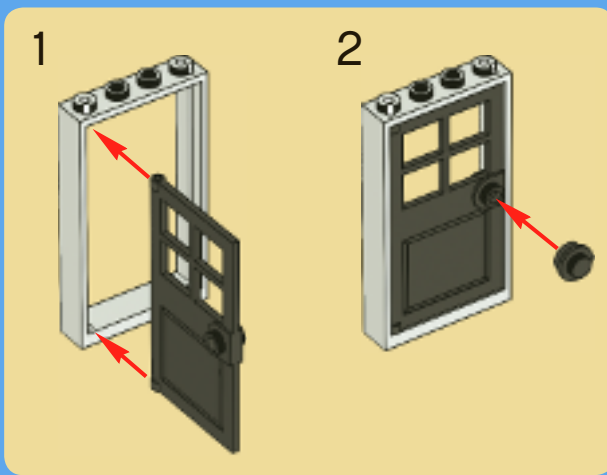
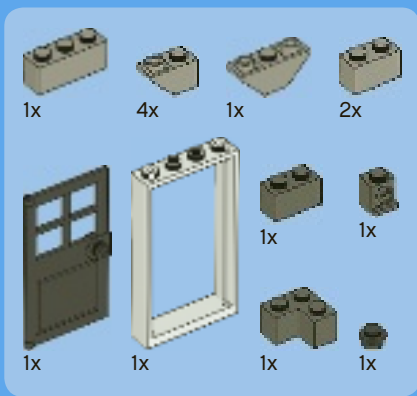

13

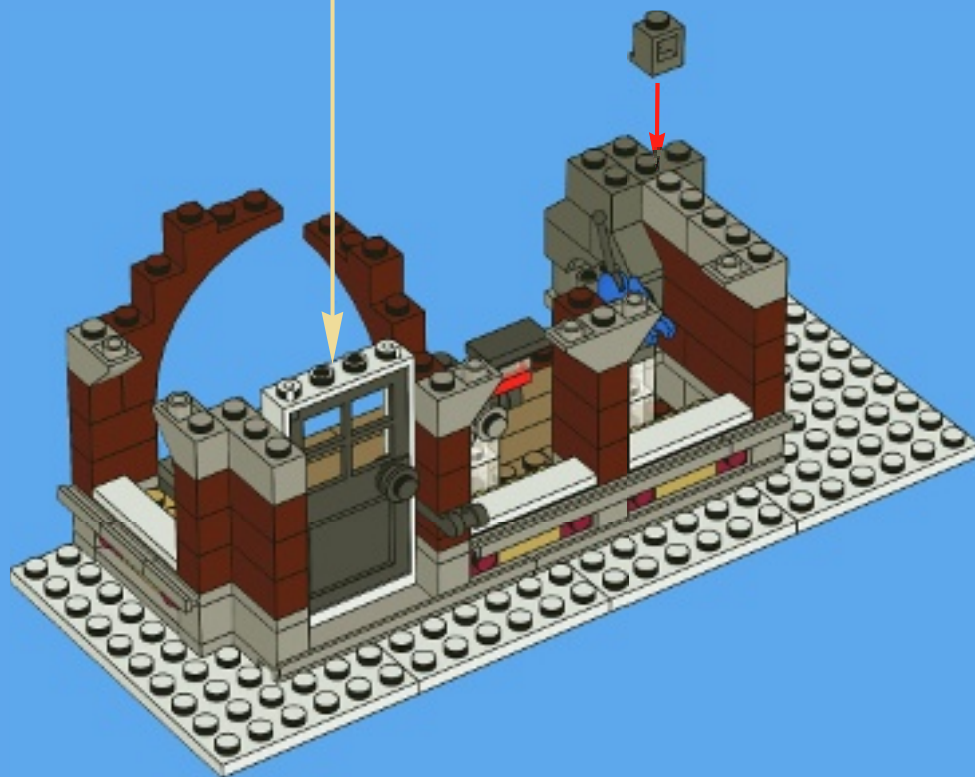



# 14

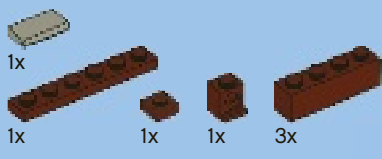
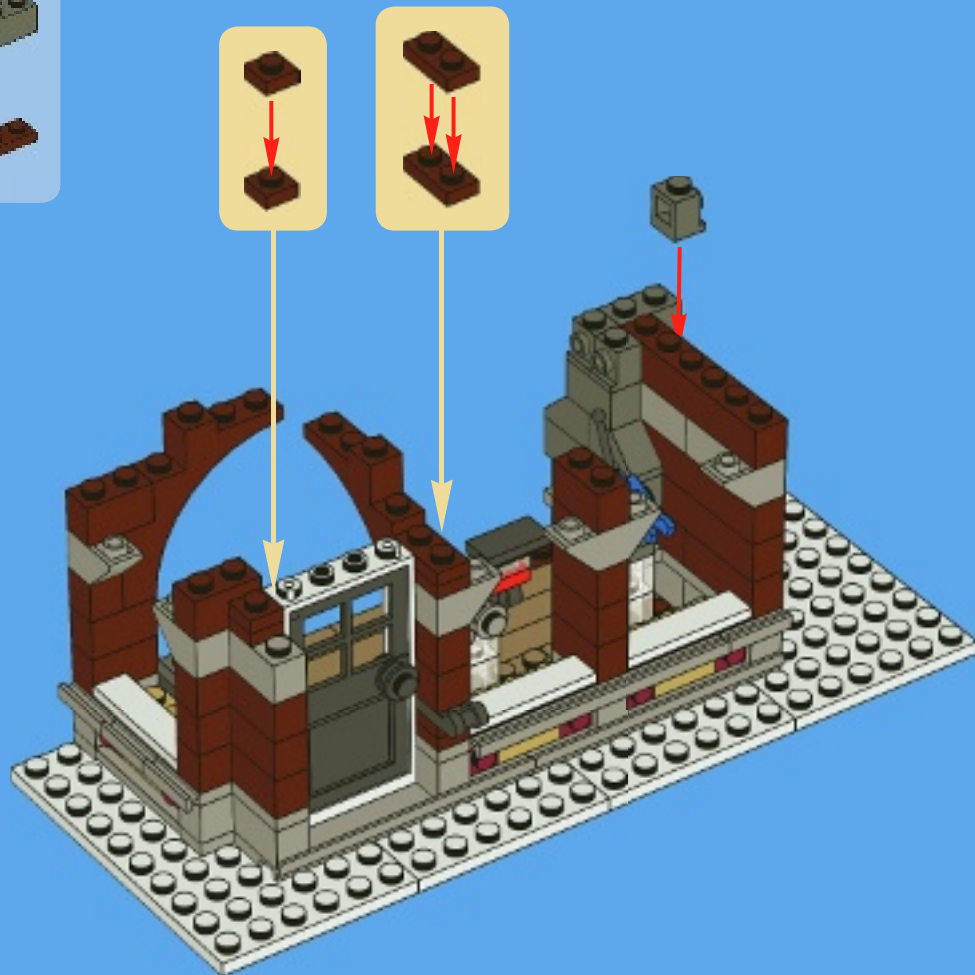

# 15

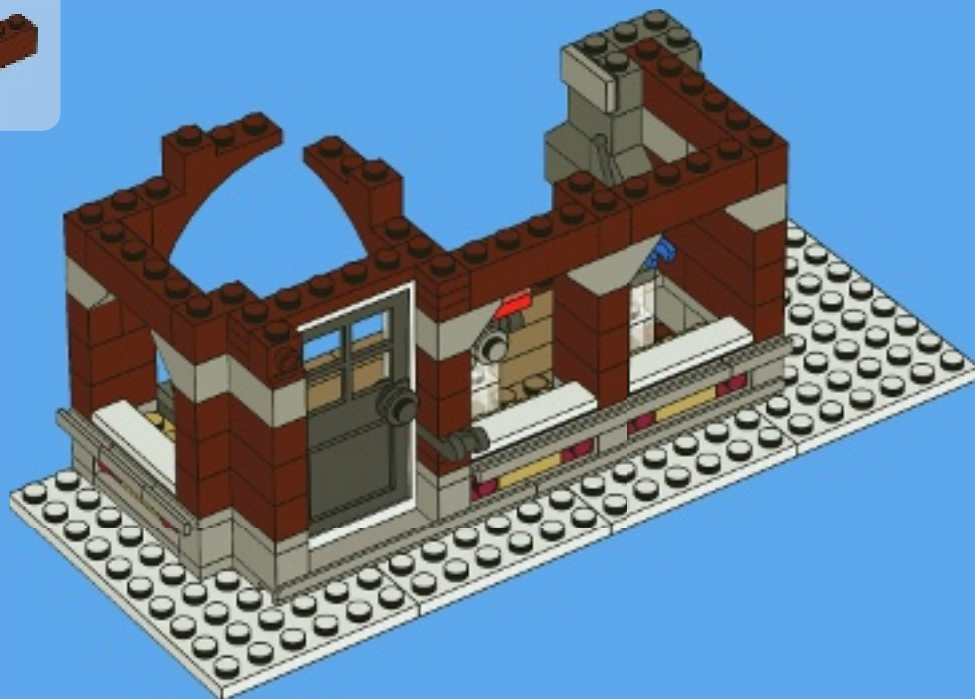

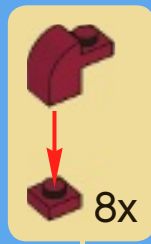

16

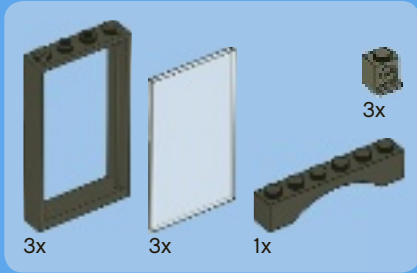

17

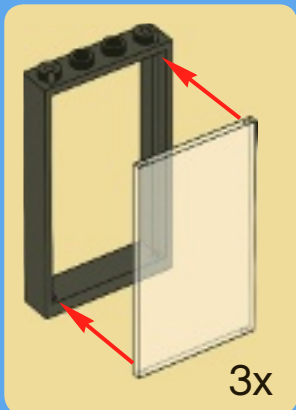

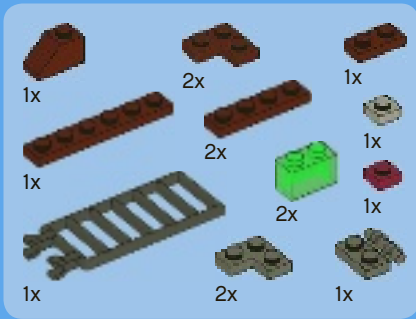

# 18

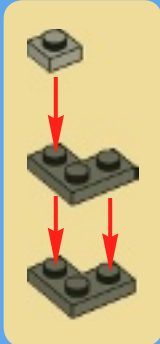
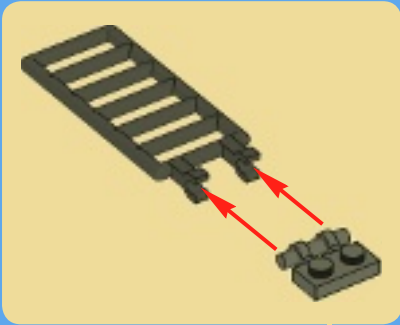

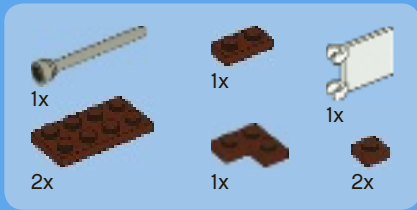

# 19

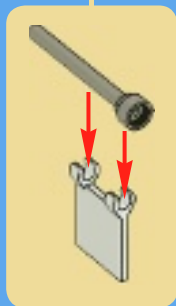
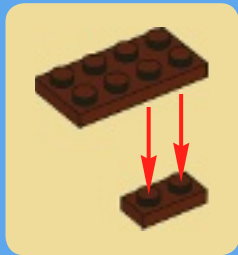
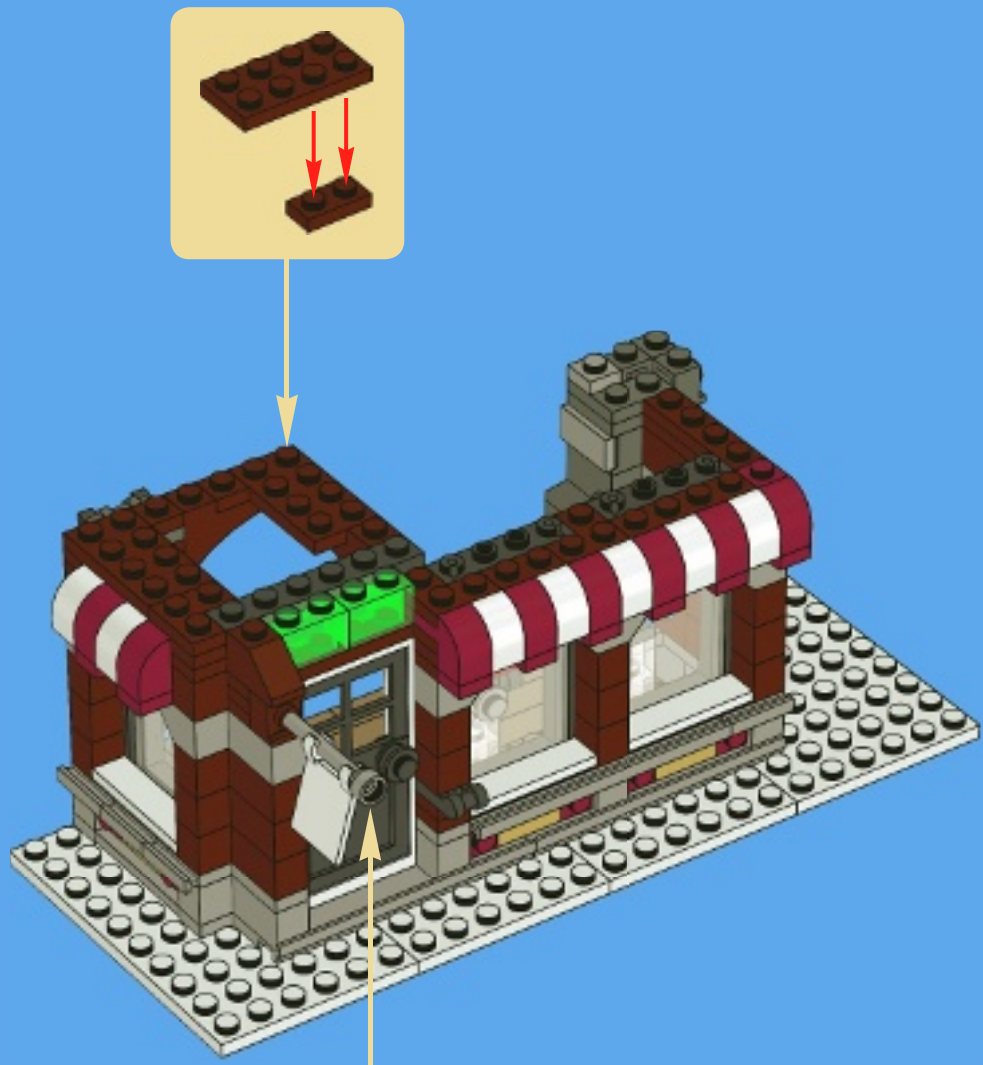

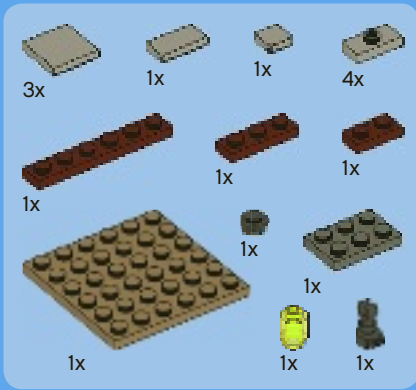

# 20





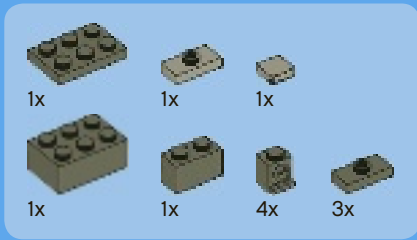

# 21

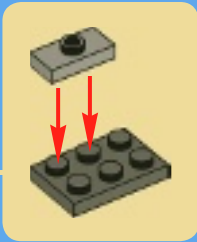
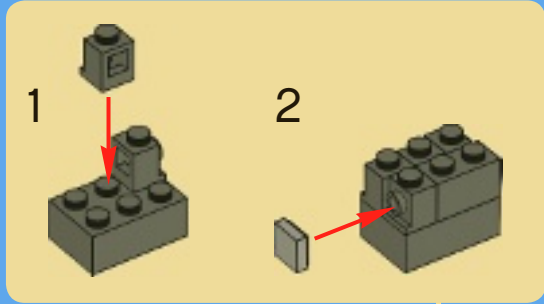

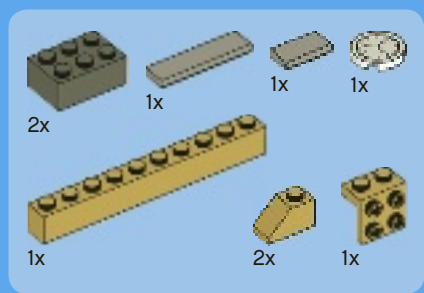

22

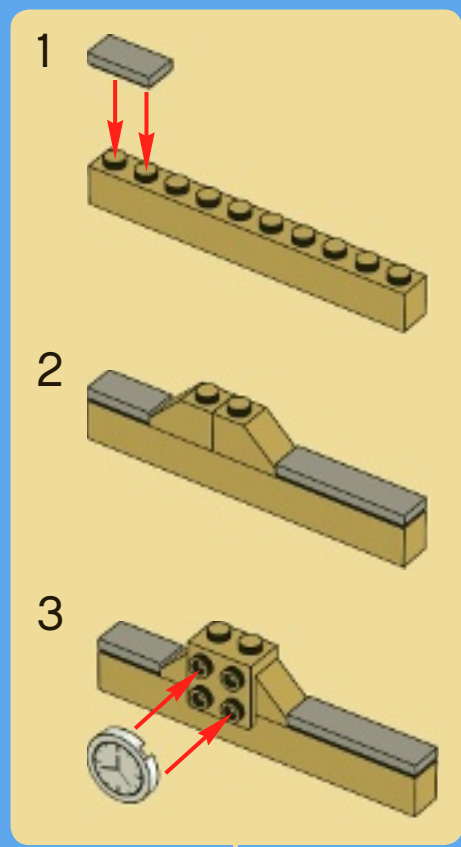

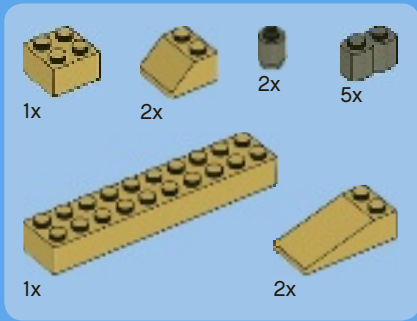

# 23

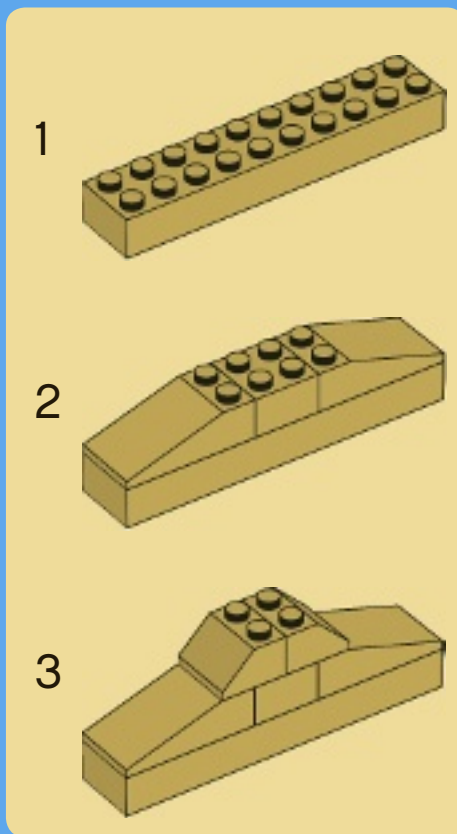



# 24



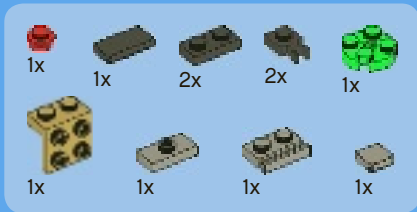

# 25

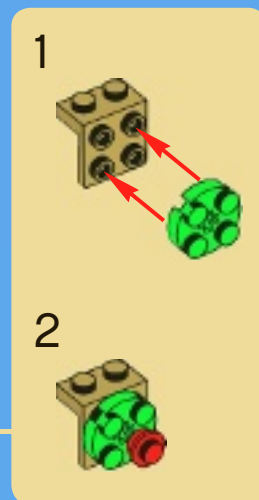
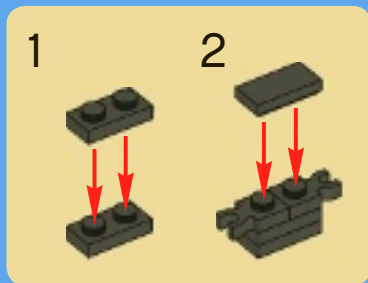

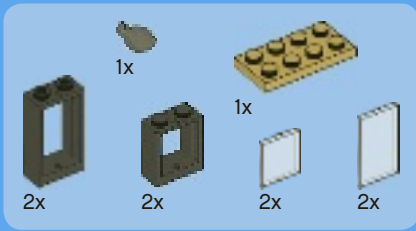

# 26

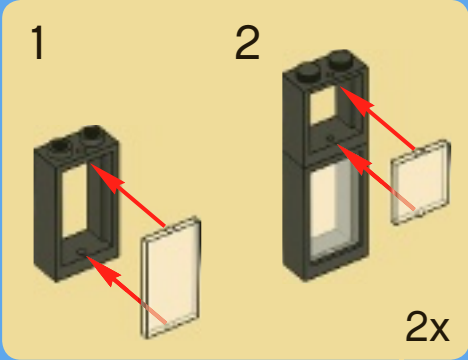

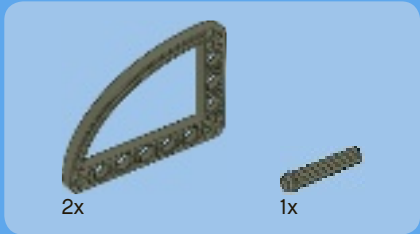

1

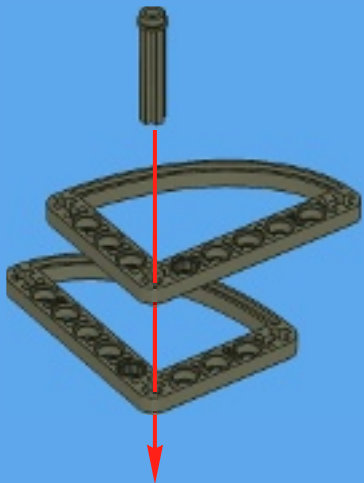

2

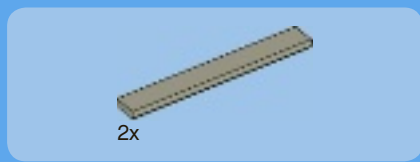
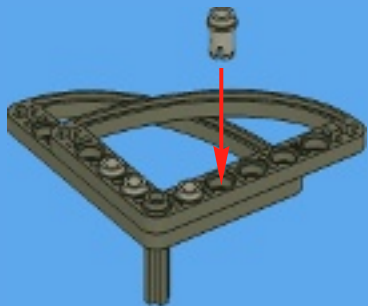

3



4

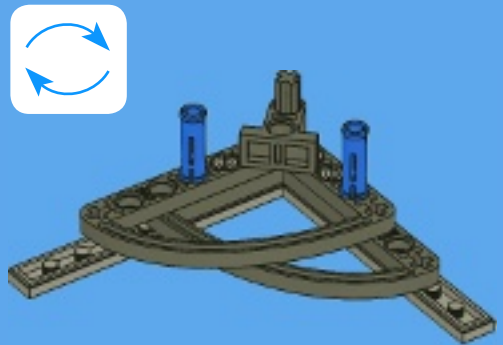

5

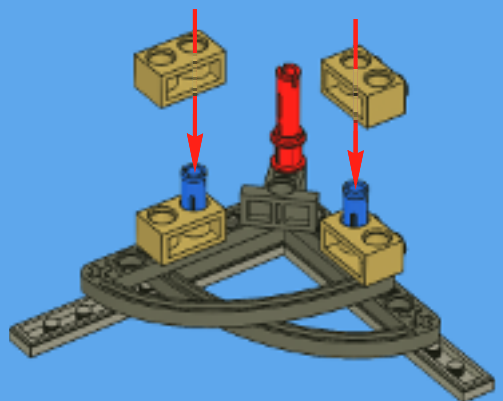

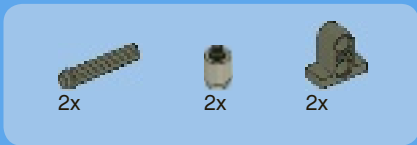

6

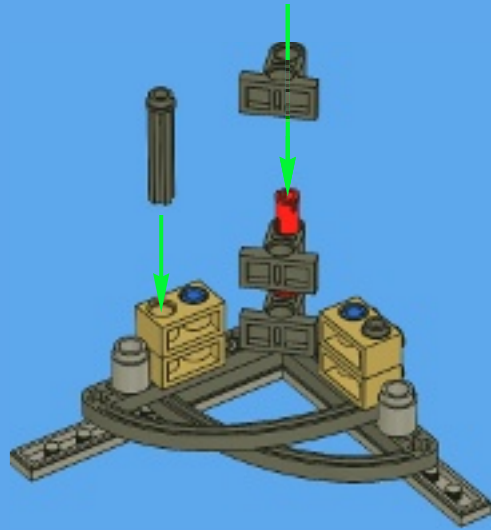

27





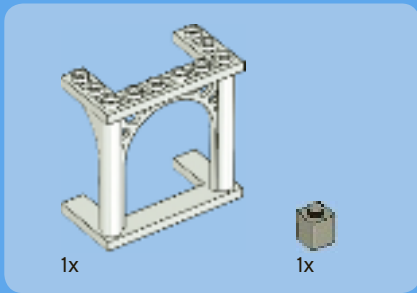

28



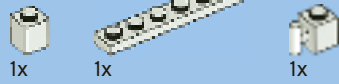

1

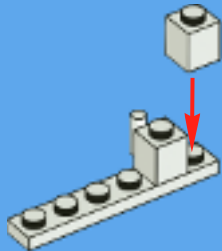

2

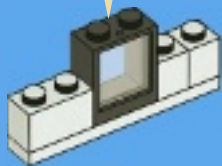
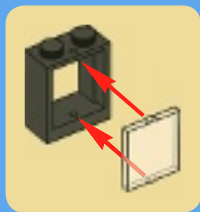

3

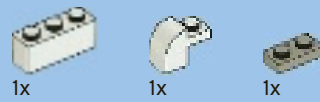
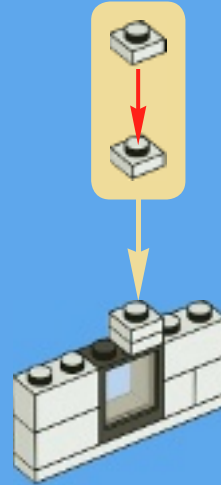

4

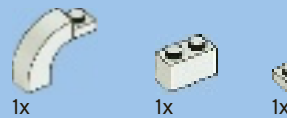
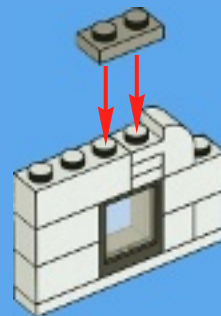

5

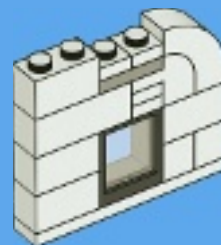



6

1

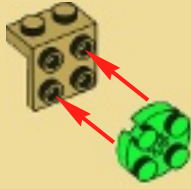

2

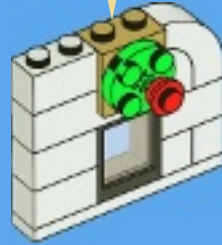

29



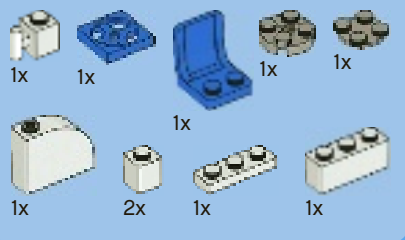

# 30

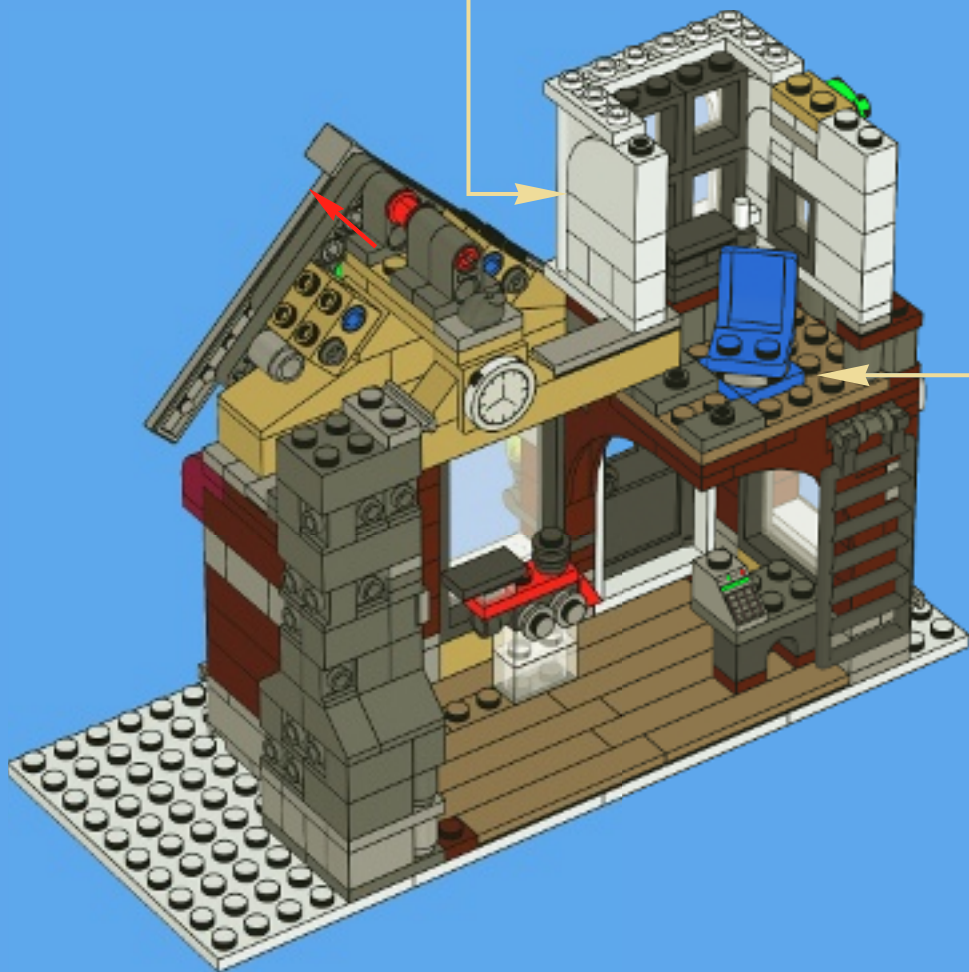
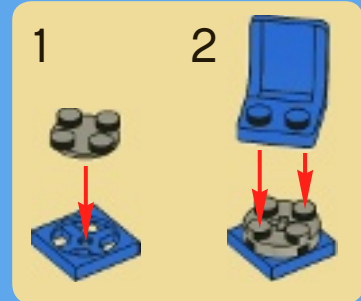
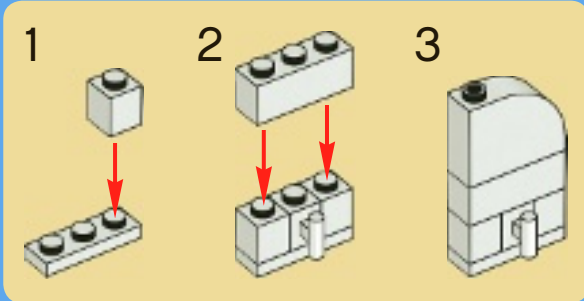



# 31

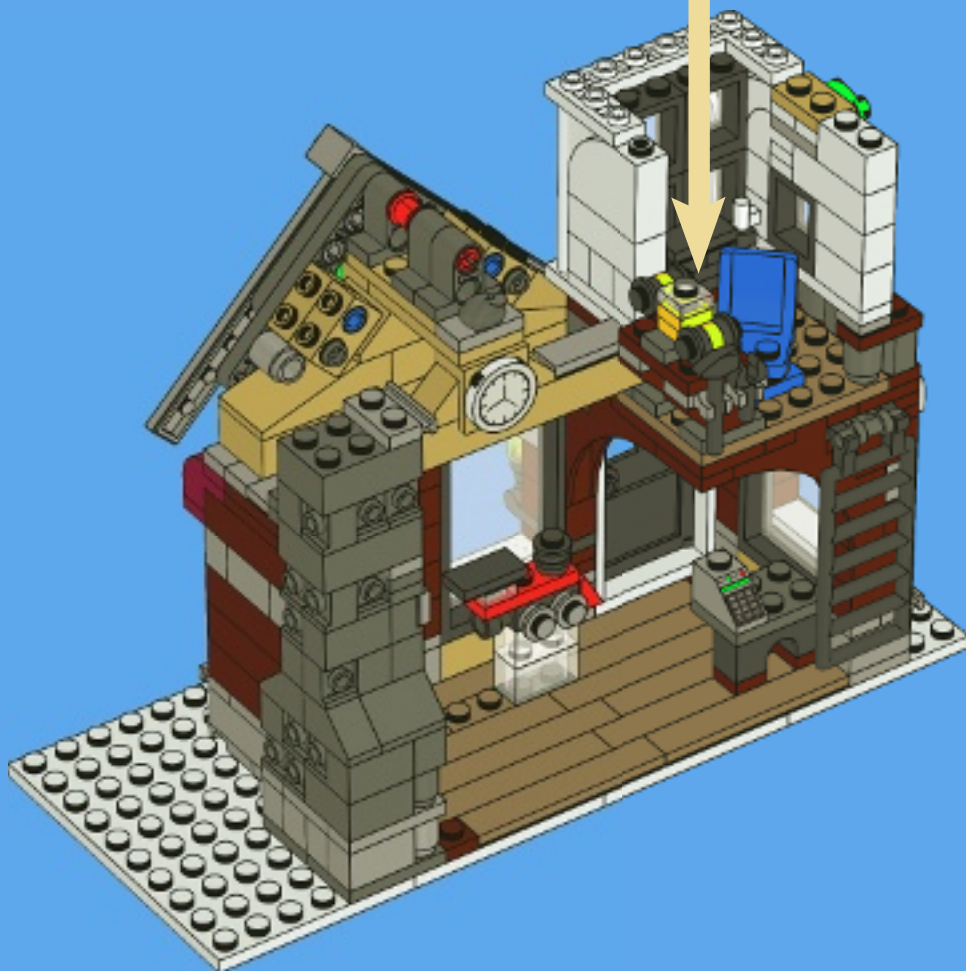
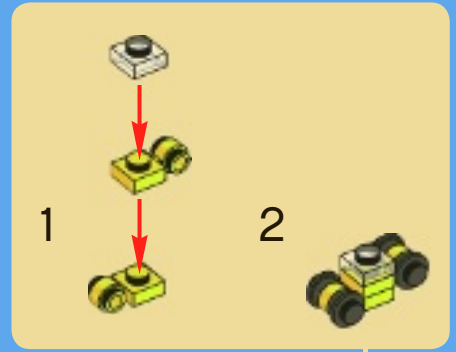
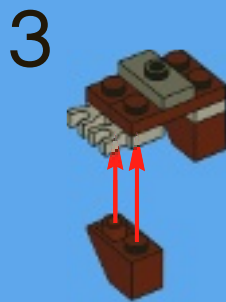
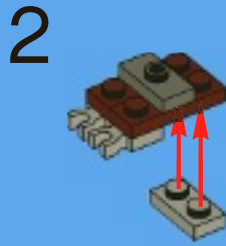
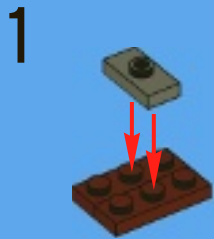

32

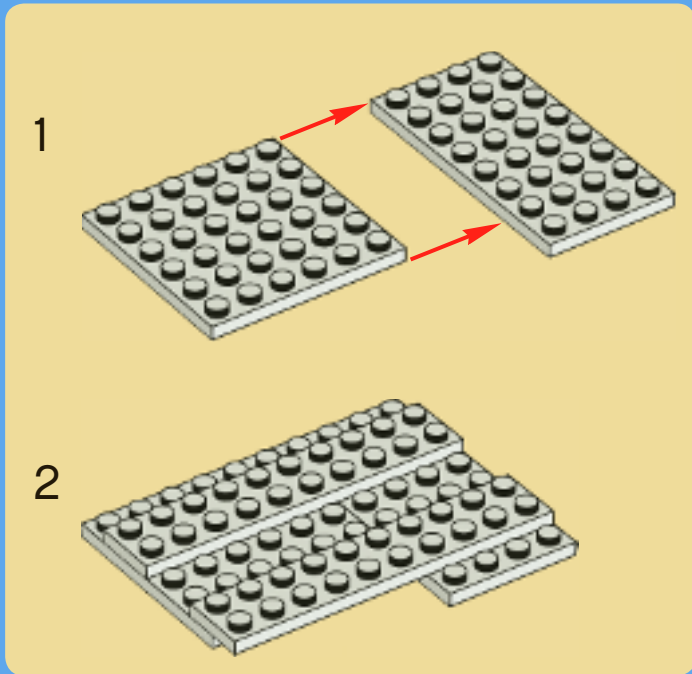
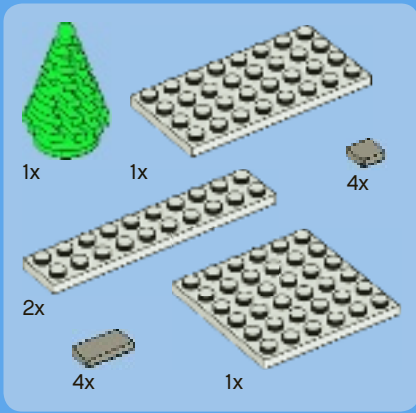

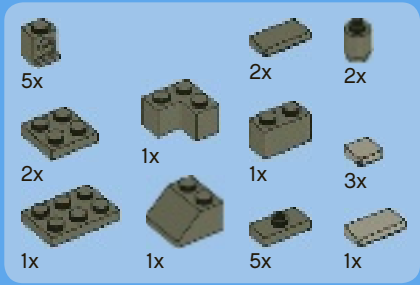

# 33

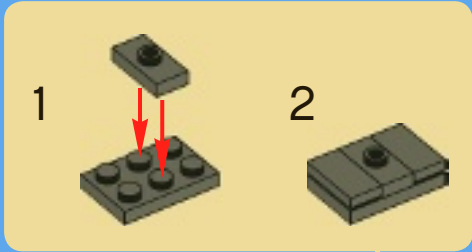
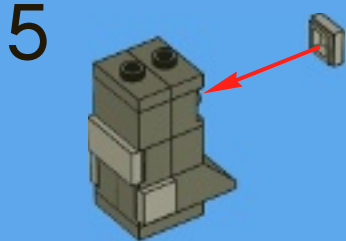
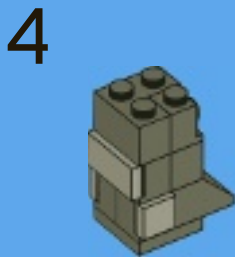
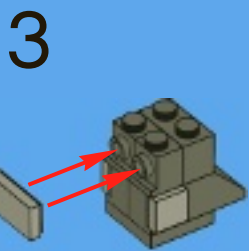
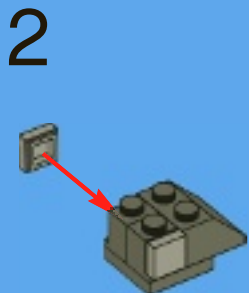
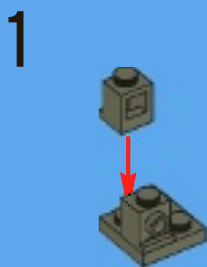

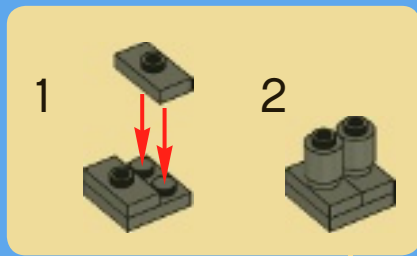



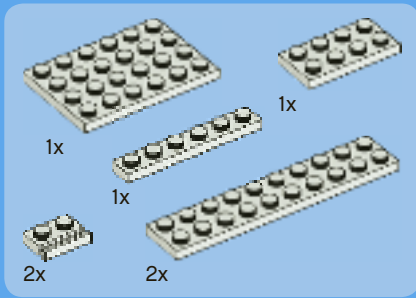

# 34

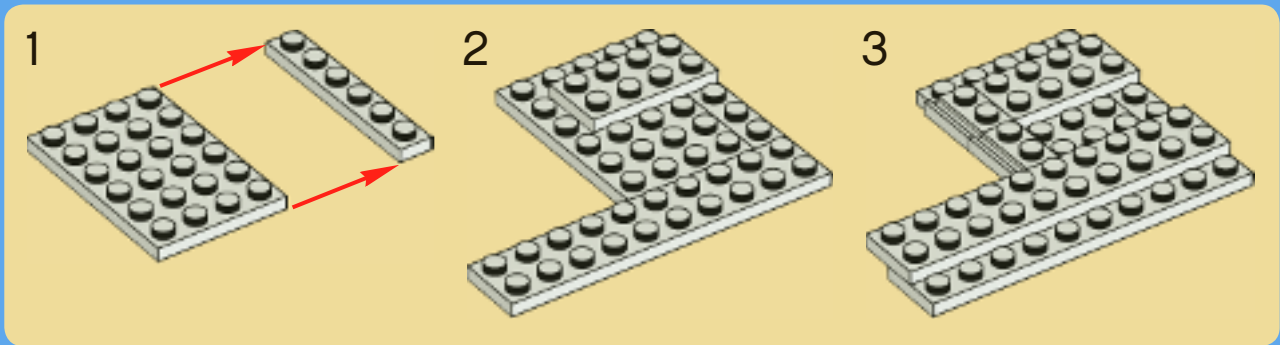



1x



6x



1x



1x

# 35



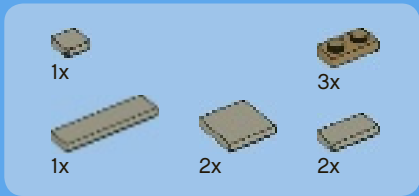

36





37

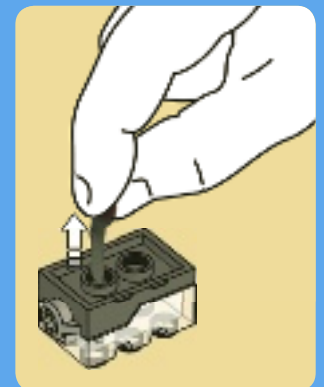
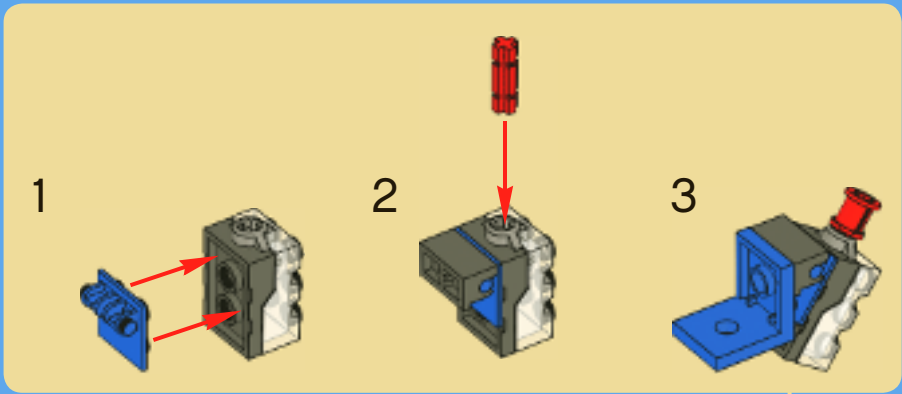



1x



4x

# 38



- 1x
- 1x
- 2x
- 1x
- 4x
- 2x
- 4x
- 1x
- 2x
- 2x
- 1x

# 39

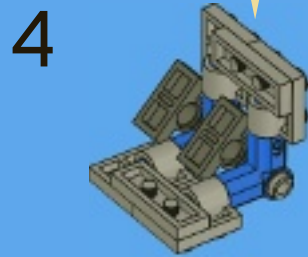
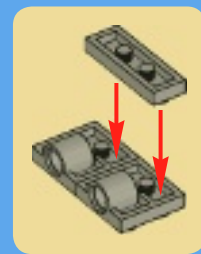
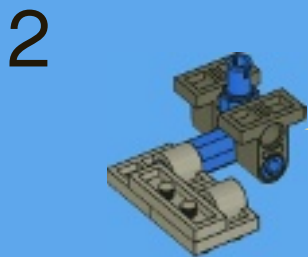
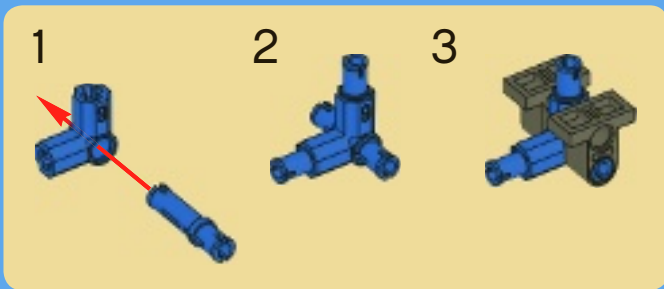
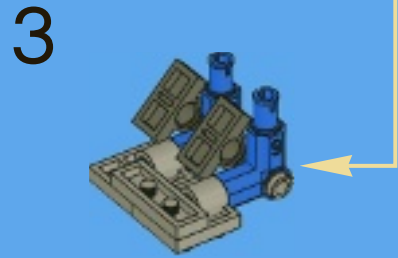
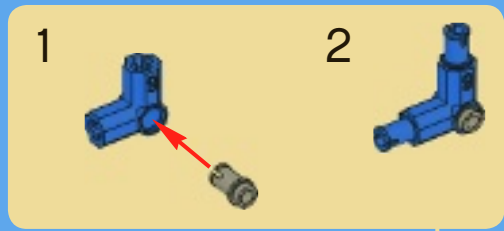
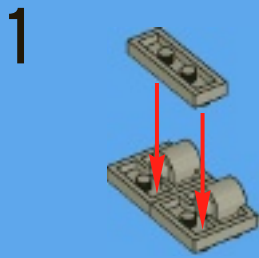

5

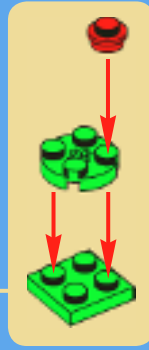

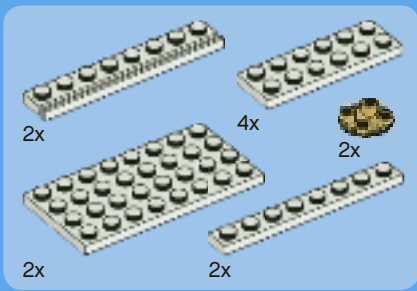

# 40

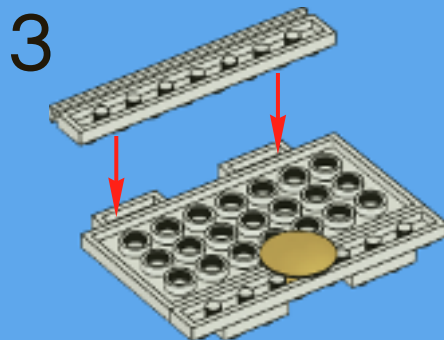
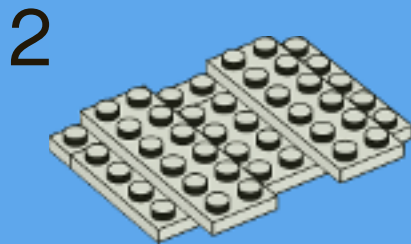
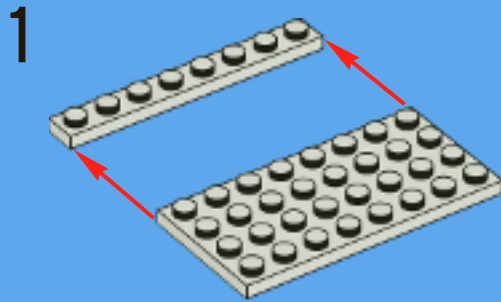

2x







41





3x  
300501



4x  
300401



2x  
362201



4x  
4111971



2x  
4119013



1x  
4216652



6x  
4504369



8x  
609101



1x  
4502026



1x  
4141668



5x  
302401



1x  
4119410



4x  
362301



3x  
243101



2x  
302001



3x  
366601



4x  
379501



2x  
346001



1x  
303201



1x  
4144012

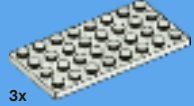

3x  
303501



4x  
383201

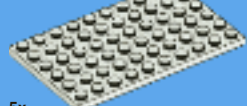

5x  
4528341



5x  
255501



2x  
379401



2x  
4277926



2x  
4249563



1x  
4222017



6x  
4527839



2x  
4501853



11x  
614101



1x  
4507355



2x  
474001

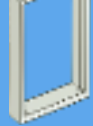

1x  
4541956



1x  
4288245



2x  
73737



1x  
4523403



1x  
9327



1x  
362601



2x  
4222968



1x  
4285963



1x  
4114306



1x  
4166138



1x  
4522675



1x  
4213568

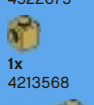

3x  
4201062



4x  
4523145



6x  
4121972



2x  
4114322



2x  
4530709



2x  
4159553



3x  
4125253



3x  
4114026



2x  
4114309



4x  
4173465



3x  
4278046



2x  
4161734



2x  
4278422



1x  
4507055



1x  
4525656



1x  
4504379



6x  
4520782



2x  
307021



2x  
306921



1x  
362321



2x  
4524644



13x  
614121



1x  
4275873



1x  
4540429



1x  
4275868



1x  
4524903



2x  
4174747



1x  
4143210



1x  
4227155



1x  
4142865



1x  
4140806



2x  
4206330



2x  
302323



4x  
306923



3x  
4520946



1x  
395623



1x  
614123



1x  
407923



1x  
4296152



1x  
4299355



1x  
368023



1x  
4195007



4x  
4206482



2x  
4112205



3x  
4514553



2x  
408124



2x  
4193511



1x  
4506998



1x  
4116809



2x  
4549416



2x  
4293369



1x  
4506812



1x  
9336

- 2x 473326
- 1x 4523339
- 4x 306226
- 1x 4529236
- 1x 394226
- 1x 4273703
- 1x 4512727
- 1x 345526
- 3x 306926
- 9x 302326
- 2x 4550017
- 1x 4185620
- 1x 4515340
- 2x 4225201
- 2x 4535739
- 3x 4515368
- 2x 4282746
- 1x 4539442
- 10x 614126
- 2x 474026
- 9x 4515350

- 3x 4521439
- 2x 4536522
- 1x 4521208
- 3x 4535834
- 4x 459926
- 2x 486526
- 1x 602026
- 2x 4538456
- 1x 4538722
- 1x 4508362
- 1x 4286968
- 3x 4249857
- 1x 4157108
- 1x 609326
- 2x 4105175
- 1x 452226
- 1x 4124171
- 1x 4289538

- 1x 4533412
- 1x 370826
- 2x 4529239
- 4x 302428
- 4x 302328
- 13x 302228
- 4x 4157120
- 12x 302128
- 10x 371028
- 18x 302028
- 4x 366628
- 8x 379528
- 2x 4549434
- 5x 403228
- 2x 243528
- 2x 347128
- 1x 74040

12

- 4x 306540
- 2x 3000840
- 3x 4552035
- 2x 4536998
- 3x 4508261
- 4x 4518410
- 2x 3005741
- 1x 3005743
- 7x 3006844
- 6x 3005744
- 1x 4549435
- 2x 306548
- 4x 3005748
- 1x 4119478
- 1x 4210280
- 1x 4200798
- 2x 4544069

- 2x 4549436
- 4x 4528604
- 11x 4507047
- 1x 4530712
- 1x 4530129
- 8x 4539082
- 15x 4539114
- 2x 4261397
- 1x 4216479
- 1x 4490082
- 6x 4523159
- 1x 4527065
- 1x 4526177

4x  
4211242



14x  
4211149



2x  
4211220



4x  
4211225



2x  
4211193



1x  
4225469



2x  
4211222



1x  
4211199



2x  
4544167



15x  
4221744



2x  
4211288



10x  
4211150



5x  
4211257



1x  
4271949



3x  
4216695



5x  
4211152



8x  
4211190



2x  
4211186



6x  
4211204



3x  
4221590



4x  
4211159



3x  
4211389



7x  
4211388



3x  
4211428



2x  
4533772



5x  
4211412



1x  
4228198



4x  
4211437



1x  
4251563



3x  
4211399



11x  
4211415



5x  
4211398



10x  
4211414



5x  
4211413



2x  
4211353



6x  
4211429



3x  
4211356



2x  
4211481



2x  
4211479



6x  
4211451



5x  
4211568



4x  
4211359



1x  
4211498



2x  
4222019



4x  
4211525



2x  
4211475



1x  
4211473



1x  
4211740



1x  
4198316



1x  
4540203



6x  
4211483



1x  
4502039



1x  
4292298



6x  
4211088



3x



4x  
4211105



20x  
4211044



5x  
4211095



7x  
4211090



3x  
4211135



2x  
4211054



1x  
4210999



2x  
4211052



2x  
4211094



2x  
4210635



6x  
4211043



10x  
4211119



5x  
4210763



1x  
4210660



1x  
4222693



1x  
4211051



2x



1x  
4272368



1x  
4211066



2x  
4508729



3x  
4211086



1x  
4211268



2x  
4508729

3x  
4211086



**Customer Service**  
**Kundenservice**  
**Service Consommateurs**  
**Servicio Al Consumidor**

[www.lego.com/service](http://www.lego.com/service) or dial

: 00800 5346 5555  
: 1-800-422-5346



10196





10194



10193





# STAR WARS



10198



LEGO, the LEGO logo and the Minifigure are trademarks of the/son des marques de commerce de/son marcas registradas de LEGO Group. ©2009 The LEGO Group. ©2009 Lucasfilm Ltd. & TM: All rights reserved. Used under authorization/Tous droits réservés. Utilisé sous autorisation./Todos los derechos reservados. Usado bajo autorización.

FREE! GRATIS! GRATUIT!



club  
MAGAZINE™

www.LEGOclub.com



00800 5346 5555\*



1-866-534-6258 • 1-877-518-5346

US & Canada only

Canada seulement



VISIT THE WORLD'S  
BIGGEST LEGO® SHOP!

www.LEGOshop.com

\* FreePhone. Mobile charges may apply. \* Numéro sans Frais. Des Frais peuvent s'appliquer avec les téléphones cellulaires. \* Gebührenfrei, Kosten für Anrufe aus Mobilfunknetzen können abweichen. \* Gratis telefonnummer vanaf vaste lijn. \* Det er et gratis nummer, når du ringer fra Posttelefon. \* Det er gratis, når du ringer fra en Post telefon.

**YES!** I want to join the LEGO® Club FREE! **OUI!** Je veux m'abonner au Club LEGO® GRATUITEMENT! **Ja!** Ich möchte Mitglied im kostenlosen LEGO® Club werden. **Ja!** Ik wil graag GRATIS lid worden van de LEGO® Club. **Ja!** Jeg ønsker å melde meg inn i LEGO® Club gratis! **Ja!** Jag vill gå med i LEGO® Club GRATIS!

First name - Prénom  
Vorname - Voornaam  
Fornavn - Förnamn

Last name - Nom de Famille  
Name - Achternam  
Etternavn - Efternamn

Date of Birth - Date de naissance  
Geburtsdag - Geboortedatum  
Fødselsdato - Födelsedatum

Boy - Garçon  
Junge - Jongen  
Gutt - Pojke

Girl - Fille  
Mädchen - Meisje  
Jente - Flicka

Street - Adresse  
Straße, Hausnr.  
Straat, huisnr. - Adress

City - Ville  
Ort - Woonplaats  
Poststed - Postort

Zip/Postcode - Code Postal  
PLZ - Postcode - Postnummer

Country  
Pays - Land

Please tick below if you would like to receive other communication from the LEGO Group. Si vous aimeriez recevoir d'autres communications de la part de la Compagnie LEGO, veuillez s.v.p. cocher ici. Als u graag andere informatie van de LEGO Groep wilt ontvangen, kruis dan a.u.b. dit vakje aan. Ich möchte über Produkte, Angebote, Aktionen und weitere interessante Themen von der LEGO Gruppe informiert werden\* (bitte ankreuzen). Om du vill få annan information från LEGO Gruppen, sätt kryss här. Hvis du ønsker å motta annen informasjon fra LEGO Gruppen, merker du av her.

Post - Poste  
Per Post

Email - Courriel  
Per E-Mail  
E-Mail

Ich möchte über Produkte, Angebote, Aktionen und weitere interessante Themen von sonstigen LEGO Partnerunternehmen informiert werden\* (bitte ankreuzen).  Per Post  Per E-Mail

US, CA, UK, IRE The English language version of the magazine can only be mailed to addresses in the US, Canada, the UK, and Republic of Ireland. Club membership is valid for two years and includes free copies of the LEGO Club Magazine. In the US and Canada please allow up to 6 weeks for delivery of your first magazine. In the UK and Republic of Ireland please allow six to 14 weeks for delivery of your first magazine. By signing this form you consent the LEGO Club to use your child's data for LEGO mailings. The data will only be used for LEGO mailings and will not be sold, rented or otherwise disclosed to any company outside the LEGO Company except for disclosure to companies acting as our agents to help us provide services requested by the child. This coupon is valid for one free membership per person, group or organisation. Photocopied coupons are accepted. La version française du magazine peut être postée uniquement au Canada. L'abonnement est valide pour 2 ans et inclut des exemplaires gratuits du Magazine LEGO. Aux E.-U. et au Canada, attendre 6 semaines pour la livraison initiale. En remplissant ce formulaire, vous consentez à ce que LEGO utilise les informations de votre enfant pour des envois postaux de LEGO. L'information sera utilisée uniquement pour des envois postaux par LEGO et ne sera en aucun cas, vendue, louée, échangée ou divulguée à d'autres compagnies autres que la compagnie LEGO, à l'exception des compagnies affiliées qui nous procurent des services auxquels l'enfant a fait la demande. Das deutschsprachige LEGO Club Magazin kann nur an Adressen in Deutschland, Österreich und der Schweiz verschickt werden. Die kostenlose Mitgliedschaft beinhaltet die Zusendung des LEGO Club Magazins und endet nach zwei Jahren. Mit der Anmeldung gehen Sie keine Verpflichtungen ein. Es kann bis zu drei Monate dauern, bis das erste Magazin zugestellt wird. Mit Ihrer Unterschrift erklären Sie sich damit einverstanden, dass die Daten Ihres Kindes zum Zweck einer LEGO Club Mitgliedschaft von der LEGO Gruppe gespeichert und verarbeitet werden. Die Daten werden vertraulich behandelt, nicht an Dritte weitergegeben und nicht veräußert. Externe Dienstleister erhalten Ihre Daten nur, soweit es für die Abwicklung von LEGO Kommunikation erforderlich ist. Wenn Sie von uns nicht mehr kontaktiert werden möchten, können Sie der Verwendung Ihrer Daten für Werbezwecke widersprechen unter: 00800 5346 5555 (Anruf gebührenfrei, Kosten für Anrufe aus Mobilfunknetzen können abweichen). \* Die Einwilligungen kann ich jederzeit (insgesamt oder zum Teil) ohne Einfluss auf die LEGO Club Mitgliedschaft bei der LEGO Gruppe widerrufen. \* Het LEGO Club Magazine kan alleen worden gestuurd naar adressen in Nederland. Het lidmaatschap is 2 jaar geldig en geeft recht op toezending van het gratis LEGO Club Magazine. Het eerste magazine zal na 12 tot 14 weken toegestuurd worden. Het lidmaatschap kan op ieder moment opgezegd worden. Door dit formulier te tekenen geeft u de LEGO Club toestemming om bovenstaande gegevens te gebruiken voor het toesturen van LEGO mailings. Uw gegevens worden uitsluitend gebruikt voor mailings van LEGO en zullen niet worden verkocht, verhuurd of op welke wijze dan ook verstrekt aan derden buiten de LEGO Groep, uitgezonderd de organisaties die namens ons optreden om de service te verlenen waar uw kind om gevraagd heeft. \* Den norske utgaven av magasinet sendes kun til adresser i Norge. Medlemskap i klubben gjelder i 2 år og inkluderer gratisutgaver av LEGO Magazine. Påregnet opp til seks uker leveringstid for første magasin. Ved å underrette dette skjemaet, gir du ditt samtykke til at LEGO Club kan bruke opplysningene om barnet ditt i LEGO forsendelser. Dataene vil utelukkende bli brukt i LEGO forsendelser og vil ikke bli solgt, utleid eller på annen måte gjøres tilgjengelig for selskaper utenfor LEGO gruppen, unntatt selskaper som er våre agenter og som hjelper oss å tilby tjenestene barnet etterspur. Dette skjemaet gjelder for ett gratis medlemskap per person, gruppe eller organisasjon. \* Den svenska versionen av tidningen kan endast skickas till adresser i Sverige. Club-medlemskapet är giltigt i 2 år och innefattar gratis exemplar av LEGO Club Magazine. Vänligen räkna med 6 veckor för leverans av din första tidning. Genom att skicka in det här formuläret godkänner du att LEGO Club använder barnets uppgifter för LEGO utskick. Uppgifterna kommer bara att användas för LEGO utskick och kommer inte att säljas, hyras ut eller vidarebefordras till något företag som inte tillhör LEGO Gruppen, med undantag av företag som agerar som våra ombud för att tillhandahålla tjänster som barnet har begärt. Den här kupongen gäller för ett gratis medlemskap per person, grupp eller organisation.

Parent's signature - Signature d'un parent - Unterschrift Erziehungsberechtigte/r  
Handtekening ouders - Førelses/Foresetsnes underskrift - Förälders/Förmyndares underskrift

Mail to: / Poster à:  
BG29

LEGO® Club  
P.O. Box 1157  
Enfield, CT USA  
06083-1157

Mail to:  
BIO9U

LEGO® Club  
33 Bath Road  
Slough SL1 3UF  
United Kingdom

Per Post an:  
BIO9C

LEGO® Club  
Postfach 14 15  
D-36243 Niederaula

Stuur op naar:  
BIO9N

LEGO® Club  
Postbus 40250  
3504 AB Utrecht

Send til:  
BIO9O

LEGO® Club Norge  
Postboks 58  
1314 Vøyenega

Skickas till:  
BIO9S

LEGO® Club Sverige  
Ubox 841  
202 29 Malmö

Date  
Datum  
Date

# WIN LEGO® PRODUCTS

Fill out a survey and you might WIN a cool LEGO product!  
NO PURCHASE NECESSARY  
Open to all residents where not prohibited  
Go to [www.acnielsen.aim.dk/LEGO](http://www.acnielsen.aim.dk/LEGO) to fill out a survey for a chance to win a LEGO product.

# WIN LEGO® PRODUCTEN

Vul een enquêteformulier in en maak kans op een cool LEGO® product!  
Kopen niet nodig  
Iedereen uit landen waar geen enquêteverbod geldt mag deelnemen.  
Ga naar [www.acnielsen.aim.dk/LEGO](http://www.acnielsen.aim.dk/LEGO), vul een enquêteformulier in en maak kans op een LEGO product.

# GEWINNE LEGO® PRODUKTE

Nimm an der Umfrage teil und GEWINNE ein tolles LEGO® Produkt!  
Die Teilnahme am Gewinnspiel führt zu keinerlei Kaufverpflichtungen  
Teilnahme in allen nicht ausgeschlossenen Ländern möglich  
Wir verlosen unter allen Teilnehmern der Umfrage auf [www.acnielsen.aim.dk/LEGO](http://www.acnielsen.aim.dk/LEGO) LEGO Produkte.

# GAGNE DES PRODUITS LEGO®

Réponds à un questionnaire et tu pourrais GAGNER un produit LEGO® très cool !  
Aucune obligation d'achat.  
Ouvert à tous les résidents des pays autorisés.  
Visite [www.acnielsen.aim.dk/LEGO](http://www.acnielsen.aim.dk/LEGO) pour répondre à un questionnaire et avoir une chance de gagner un produit LEGO.

# レゴ®製品を「当てよう」

アンケートに記入して、かっこいいレゴ®製品を当てよう！  
お買い上げの必要はありません。  
禁止されていない限り、すべての皆様にご利用いただけます。

[www.acnielsen.aim.dk/LEGO](http://www.acnielsen.aim.dk/LEGO)にアクセスして、アンケートにご記入ください。当選者にはレゴ製品を差し上げます。

[www.nielsen.com/LEGO](http://www.nielsen.com/LEGO)



©2009 The LEGO Group. 4616181