



# PIRATES *of the* CARIBBEAN

ON STRANGER TIDES



4192



1

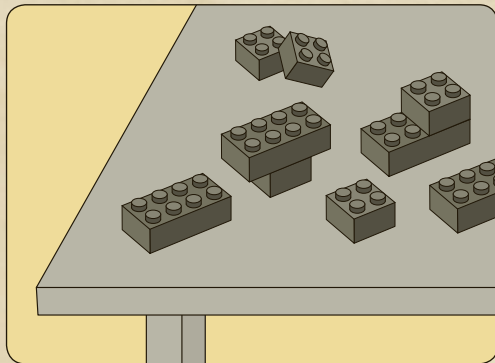

2

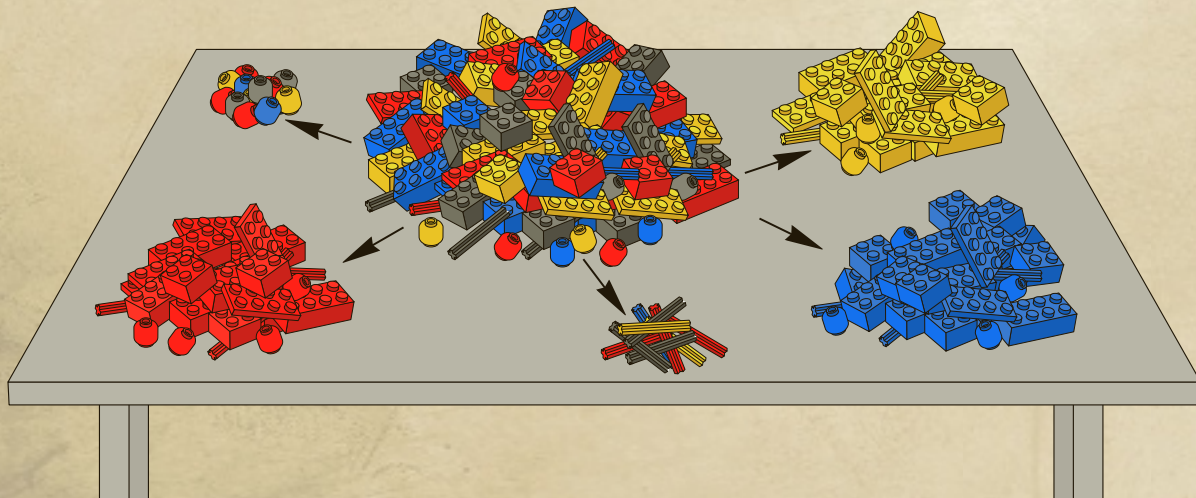

2

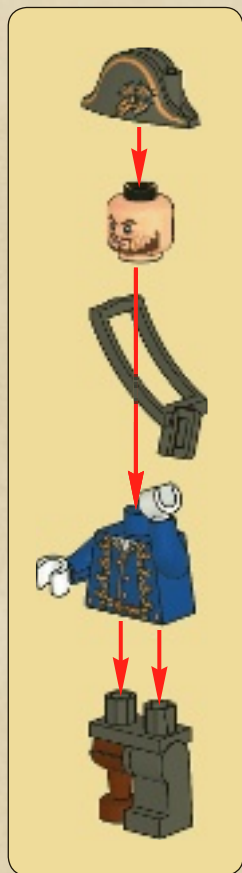

1

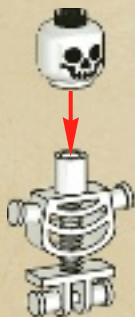

2

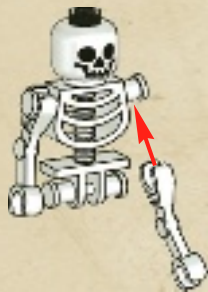

3





1

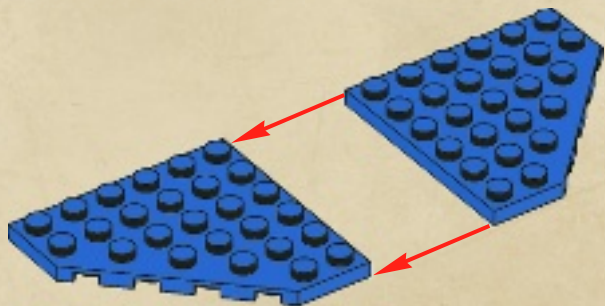

2

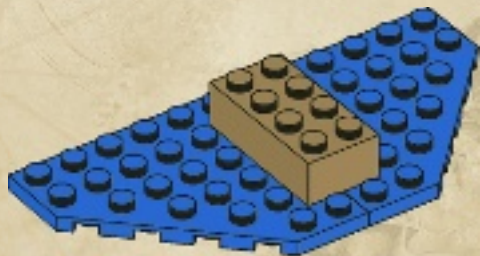



4x

3

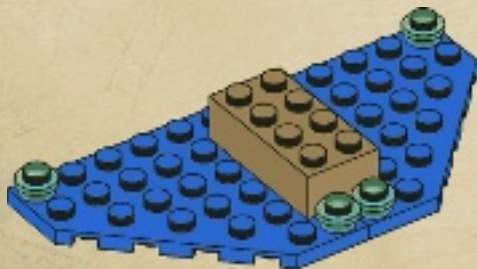

1x

4

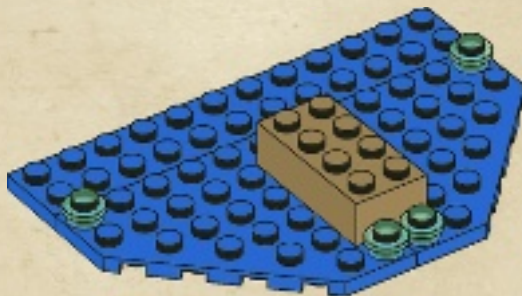



2x

5

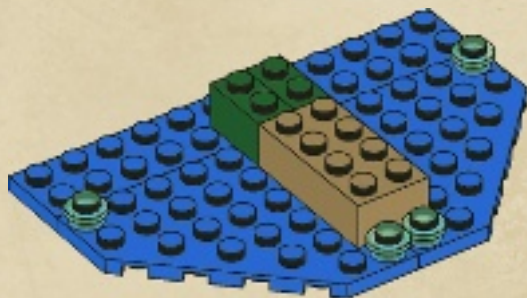

2x



2x

6

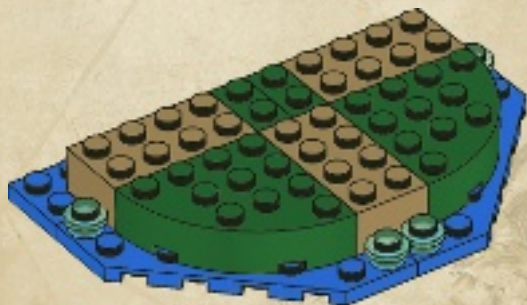



2x



2x

# 7

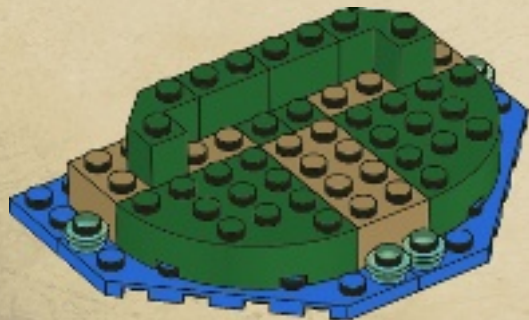

4x



1x

# 8

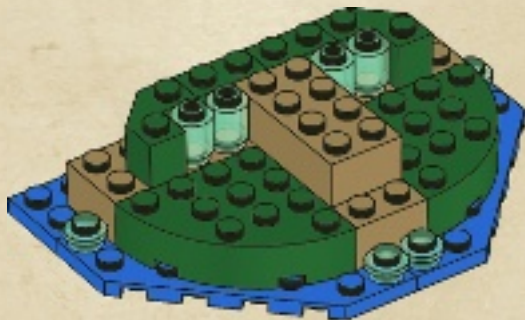





2x



2x

# 9

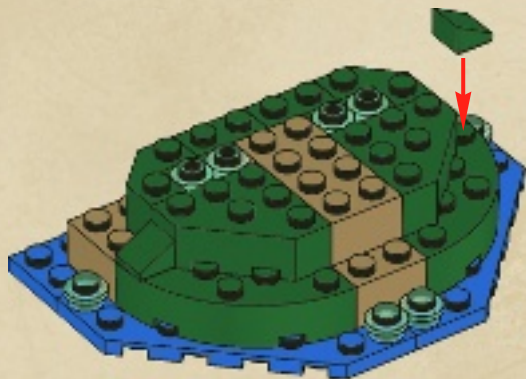

3x

# 10

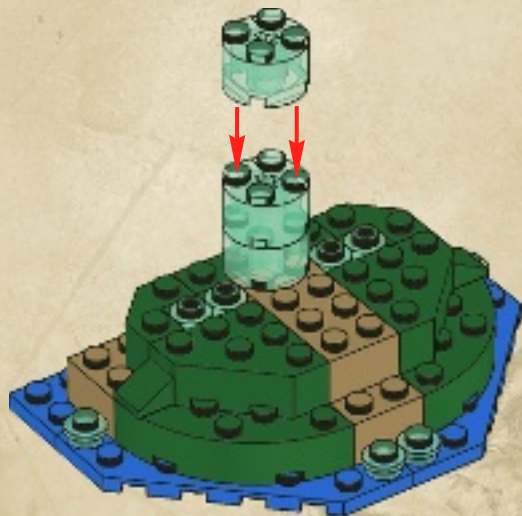



2x



2x

# 11

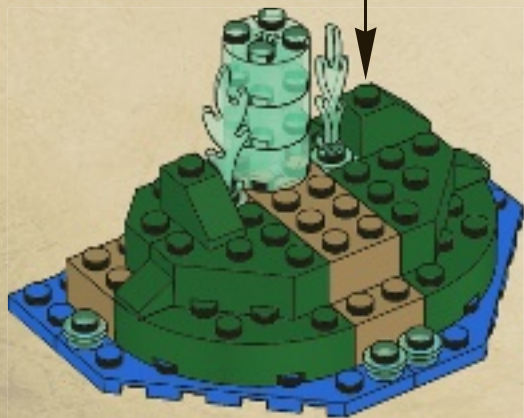

2x

# 12

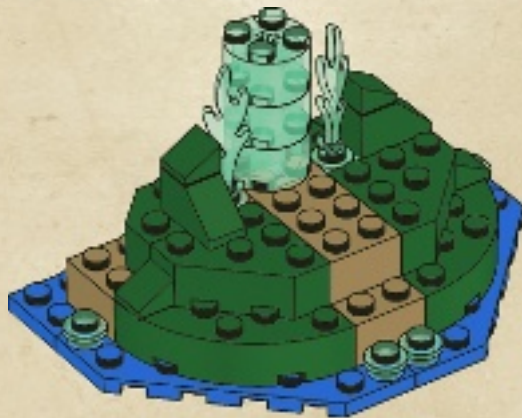

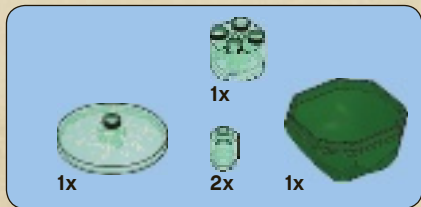

# 13

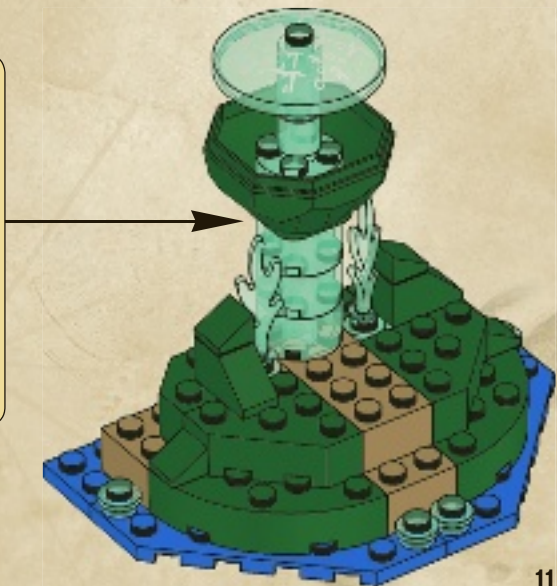
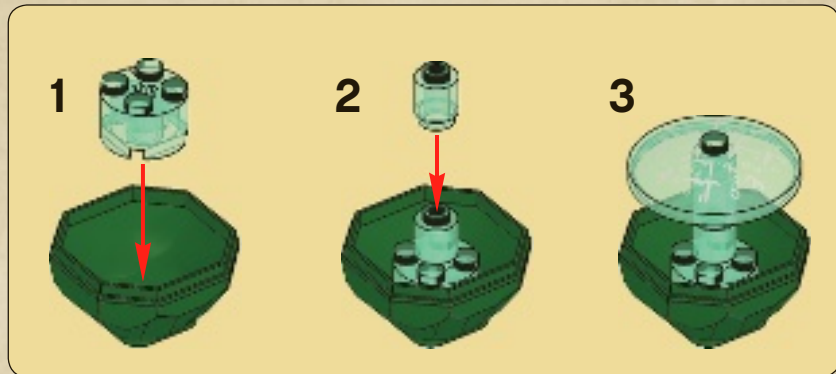

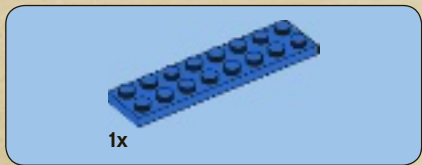

1x

1

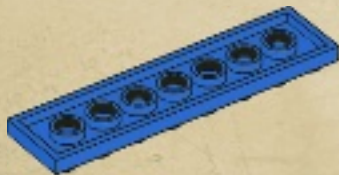

1x

2

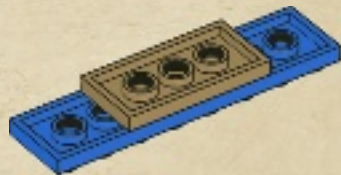



2x

3

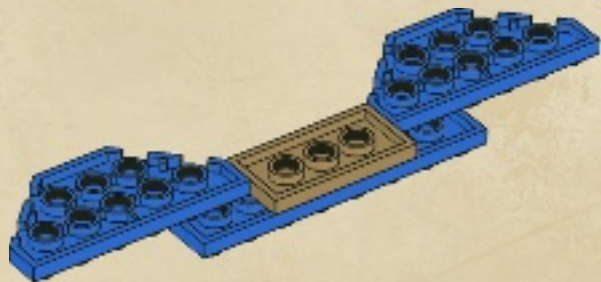

2x

4

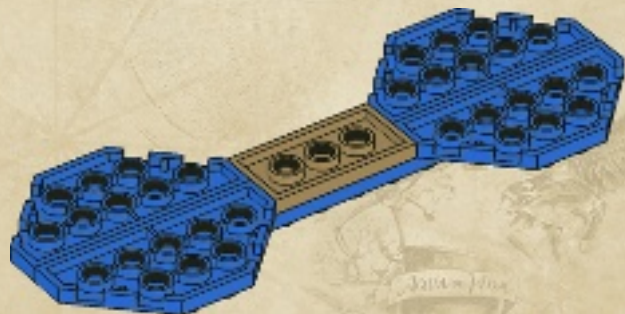



5

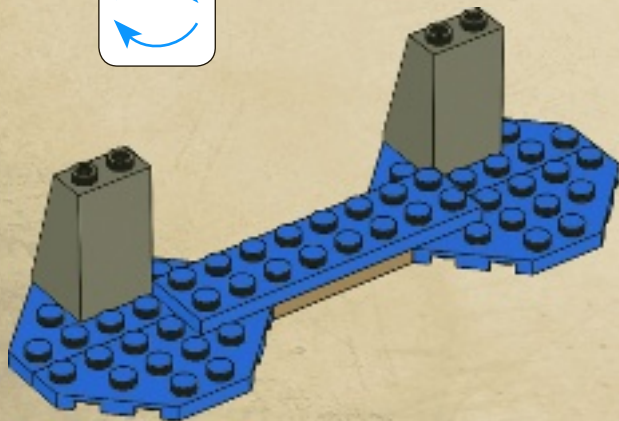

6

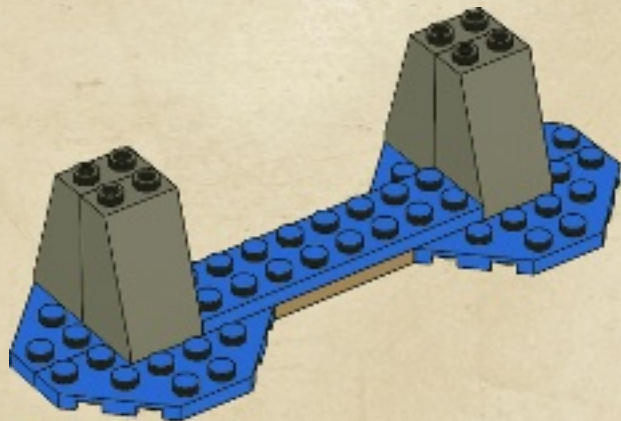

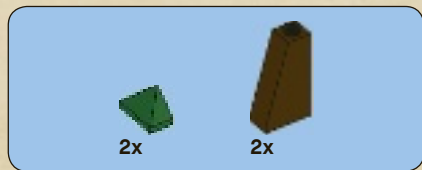

7

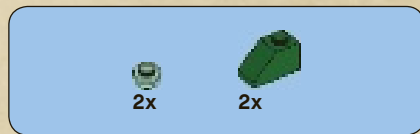
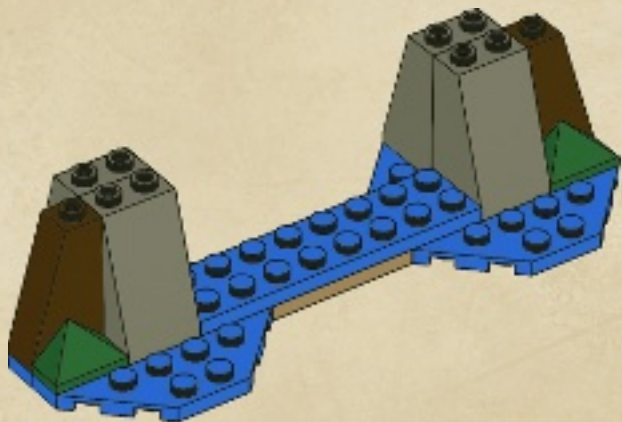

8

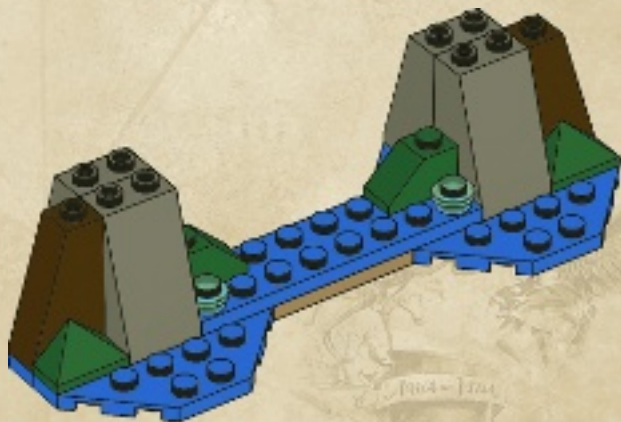



9

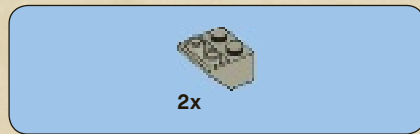
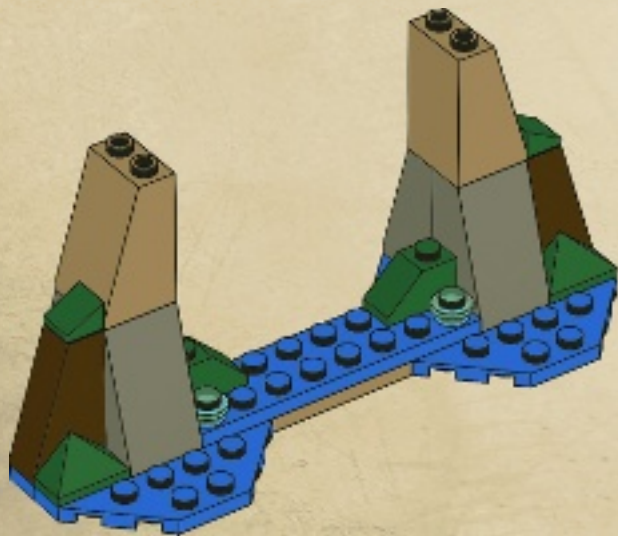

10

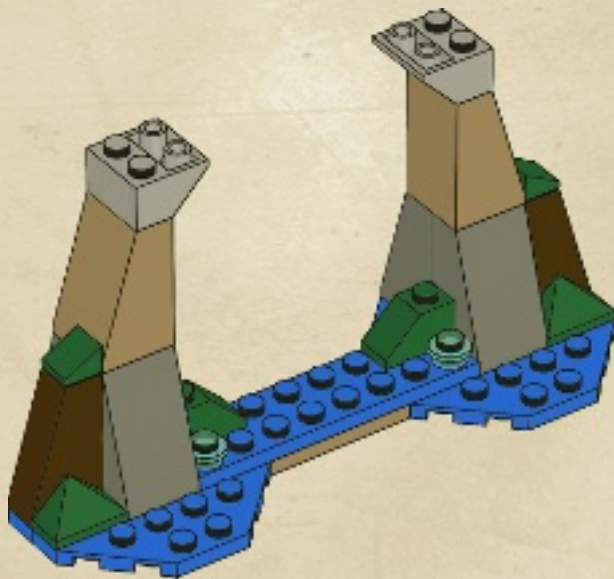



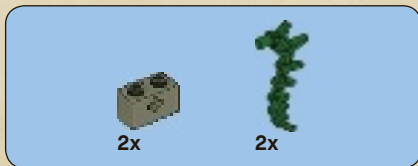

11

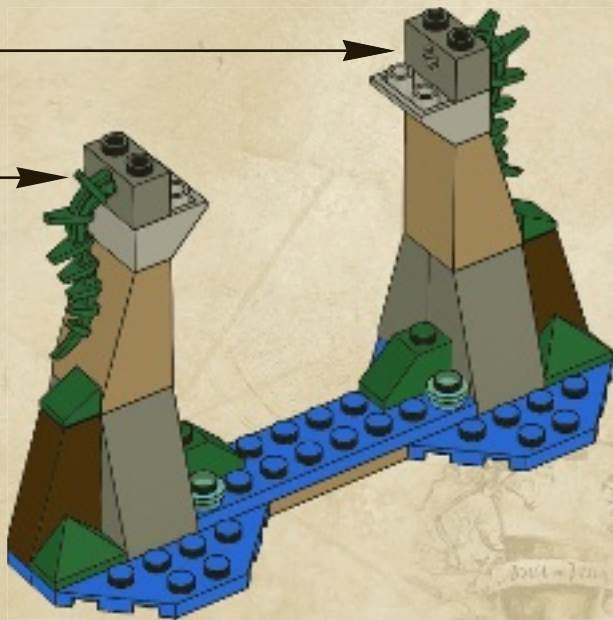
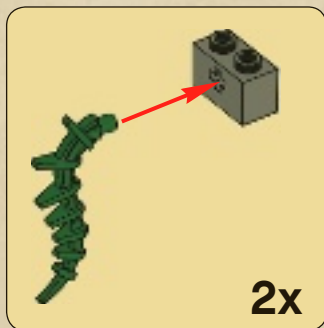

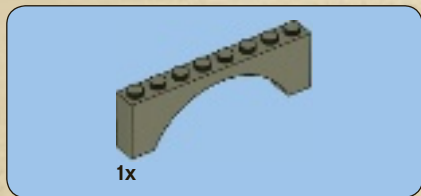

12

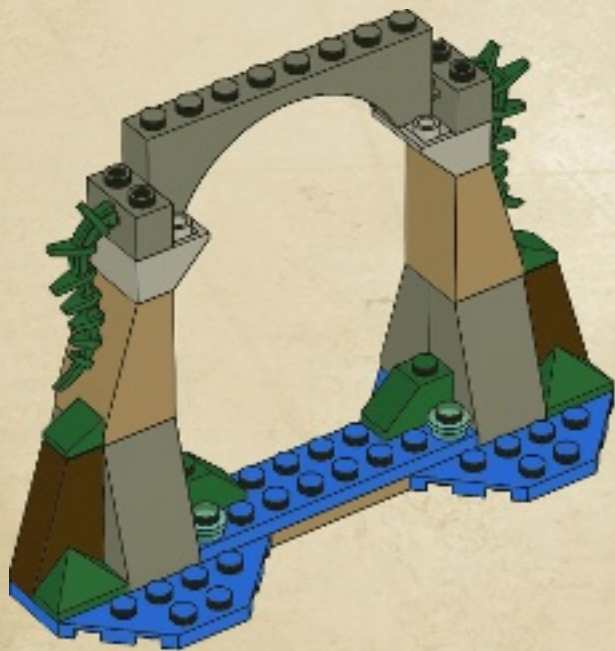



2x



2x

# 13

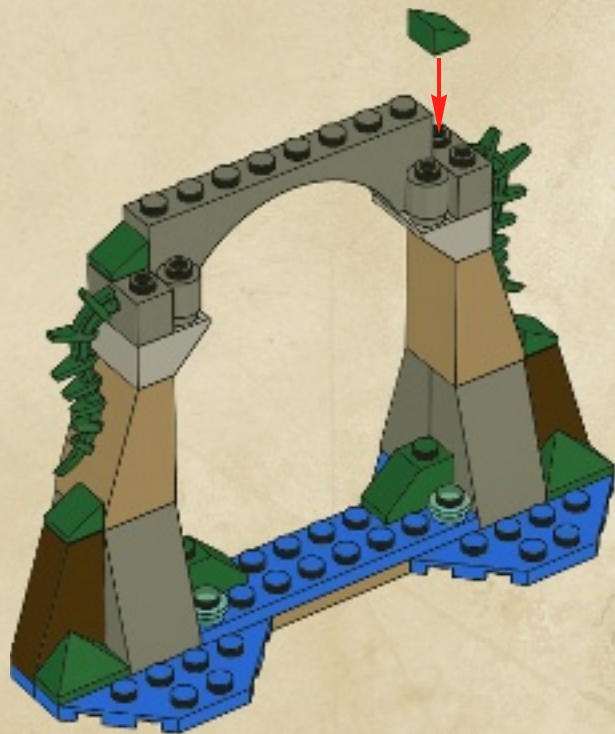



2x

14

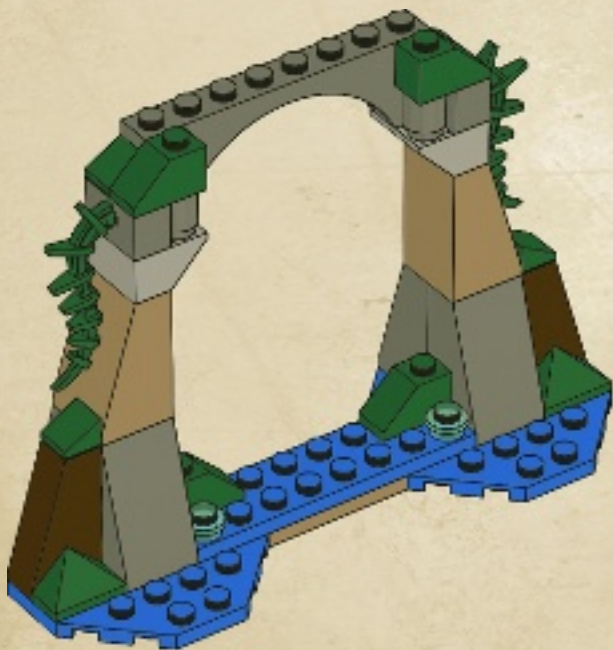



3x



2x

15

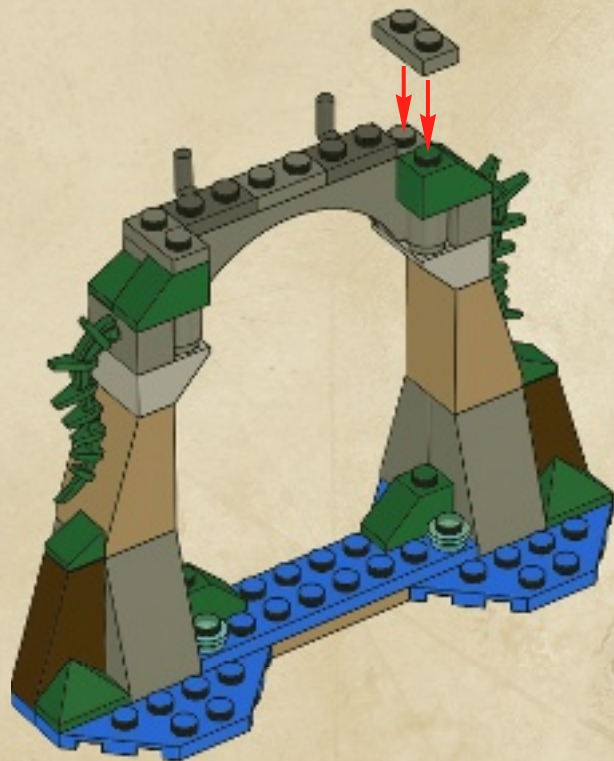



1x

16

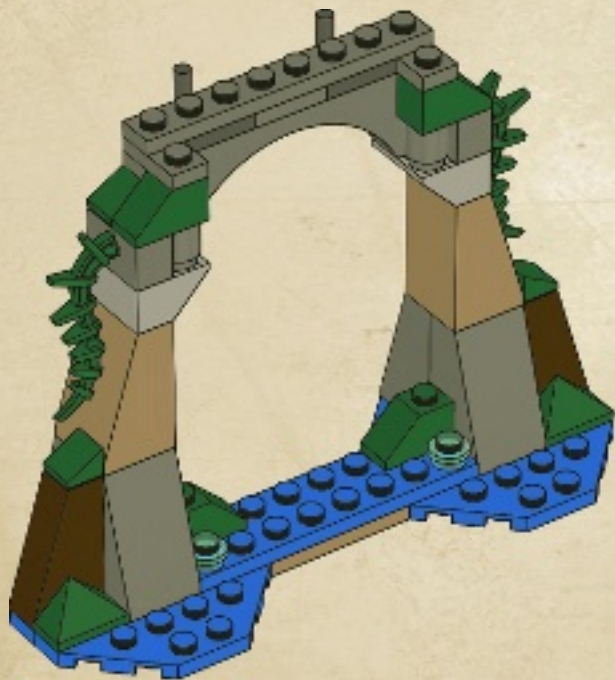



2x



2x

17



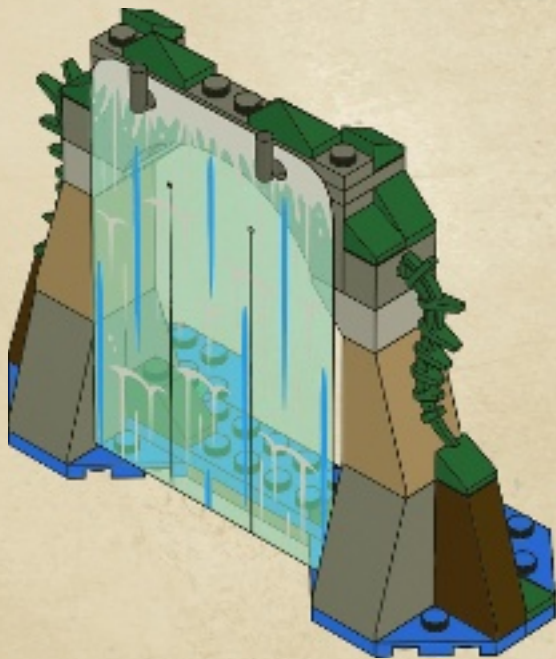
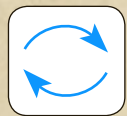
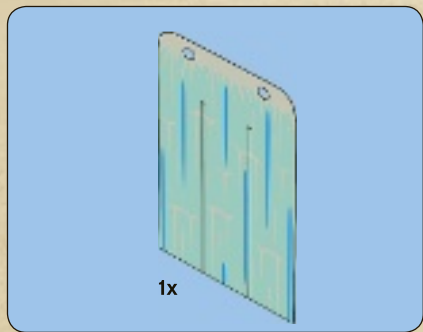

18





1x



4x



1x

# 19



1

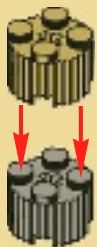

2



3



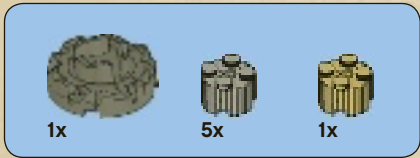

20

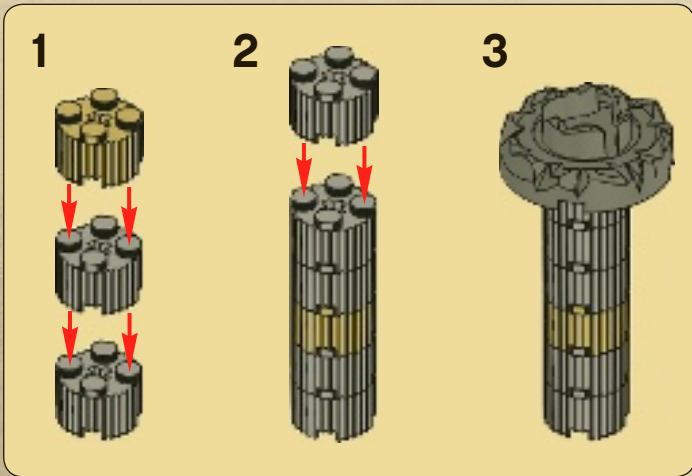





2x  
626601



2x  
4260649



1x  
4508143



1x  
82359



2x  
4518562



1x  
303423



1x  
244523



4x  
241923



2x  
4579039



1x  
4626967



1x  
4631232



1x  
4636302



1x  
4636720



1x  
4621786



1x  
4620193



1x  
4636467



2x  
4569733



1x  
4540696



6x  
4183544



4x  
4178398



6x  
4163917



1x  
4633964



2x  
4155537



1x  
4631777



4x  
4247145



2x  
4613790



1x  
4267874



1x  
4636703



1x  
4625361



1x  
4619461



1x  
4619527



2x  
4631911



2x  
4631908



2x  
4631909



10x  
4504375



4x  
4266666



6x  
4255624



1x  
4631910



2x  
4294148



4x  
4245570



1x  
4210998



2x  
4210789



2x  
4210935



2x  
4211090



4x  
4210696



1x  
4220973



3x  
4211063



2x  
4563480



9x  
4610816



2x  
4211436



1x  
4619544



1x  
4634052



1x  
4625156



2x  
4612717



1x  
4633916



2x  
4505990



1x  
4620396



**Customer Service**

**Kundenservice**

**Service Consommateurs**

**Servicio Al Consumidor**

[www.lego.com/service](http://www.lego.com/service) or dial



00800 5346 5555 :



1-800-422-5346 :





# PIRATES OF THE CARIBBEAN

ON STRANGER TIDES





Disney  
**PIRATES of the  
CARIBBEAN**  
THE VIDEO GAME



[videogames.LEGO.com](http://videogames.LEGO.com)



© Disney. LEGO® Pirates of the Caribbean: The Video Game software © 2011 TT Games Publishing Ltd. Produced by TT Games under license from the LEGO Group. LEGO, the LEGO logo, the Brick and the Knob configurations and the Minifigure are trademarks of the LEGO Group. © 2011 The LEGO Group.





[www.LEGOclub.com](http://www.LEGOclub.com)



LEGO® Club Email



LEGO® Club Magazine

**LEGO club**

**FREE! GRATIS! GRATUIT!**

**SIGN UP ONLINE!**

**[www.LEGOclub.com](http://www.LEGOclub.com)**



**00800 5346 5555\***



**1-866-534-6258 • 1-877-518-5346**

US & Canada only

Outside continental

- \* Freephone. Mobile charges may apply.
- \* Numéro sans frais. Des frais peuvent s'appliquer avec les téléphones cellulaires.
- \* Gebührenfrei. Kosten für Anrufe aus Mobilfunknetzen können abweichen.
- \* Gratis telefonnummer vanaf vaste lijn.
- \* Det er et gratis nummer, når du ringer fra fasttelefon.
- \* Det är gratis, när du ringer från en fast telefon.
- \* Numéro sans frais. Des frais peuvent s'appliquer avec les téléphones portables.



# WIN!

Go to [www.LEGOsurvey.com/product](http://www.LEGOsurvey.com/product) to fill out a survey for a chance to win a cool LEGO® Product.

No purchase necessary.

Open to all residents where not prohibited.



## [www.LEGOsurvey.com/product](http://www.LEGOsurvey.com/product)

### GEWINNE!

Nimm an der Umfrage auf [www.LEGOsurvey.com/product](http://www.LEGOsurvey.com/product) teil und hab die Chance ein cooles LEGO® Produkt zu gewinnen!

Die Teilnahme am Gewinnspiel führt zu keinerlei Kaufverpflichtungen. Teilnahme in allen nicht ausgeschlossenen Ländern möglich.

### WIN!

Ga naar [www.LEGOsurvey.com/product](http://www.LEGOsurvey.com/product), vul een enquêteformulier in en maak kans op een cool LEGO® product.

Geen aankoopverplichting. Iedereen mag deelnemen, uitgezonderd ingezetenden van landen waar een enquêteverbod geldt.

### GAGNE!

Visite [www.LEGOsurvey.com/product](http://www.LEGOsurvey.com/product) pour répondre à un questionnaire et avoir une chance de gagner un produit LEGO® très cool!

Aucune obligation d'achat. Ouvert à tous les résidents des pays autorisés.

### 当てよう!

[www.LEGOsurvey.com/product](http://www.LEGOsurvey.com/product) にアクセスして、アンケートにご記入ください。当選者にはレゴ®製品を差し上げます。

お買い上げの必要はありません。禁止されていない限り、すべての皆様にご利用いただけます。



[www.LEGO.com](http://www.LEGO.com)

1643084

LEGO, the LEGO logo and the Minifigure are trademarks of the LEGO Group. ©2011 The LEGO Group. © Disney Enterprises, Inc. and Jerry Bruckheimer, Inc.