

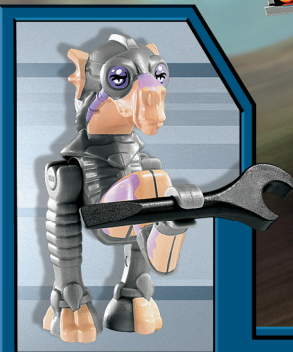

STAR WARS



9675



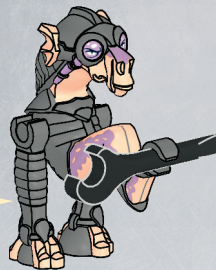
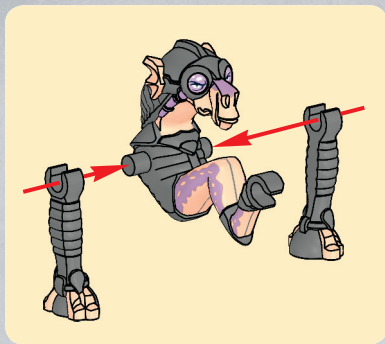

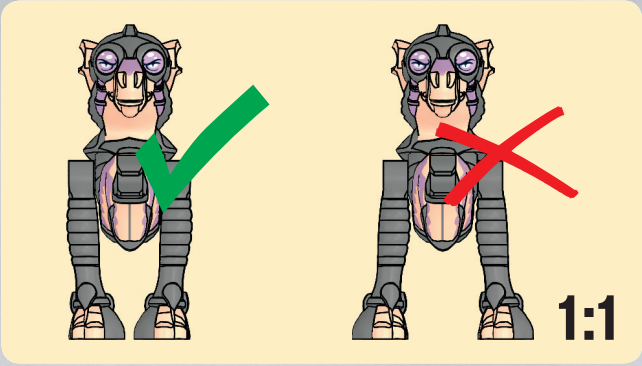

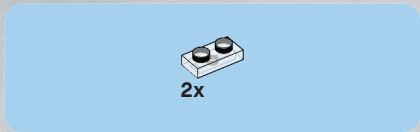
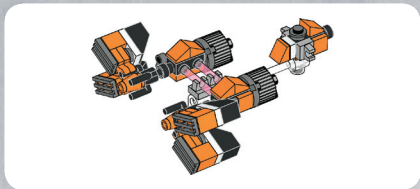

1

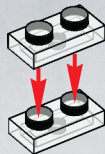

4

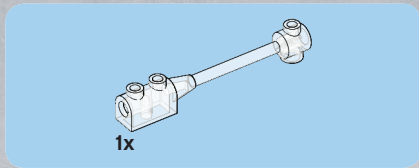

2

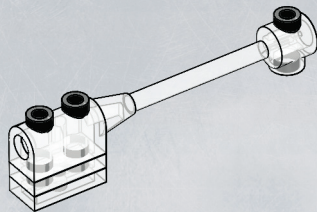

2x

3

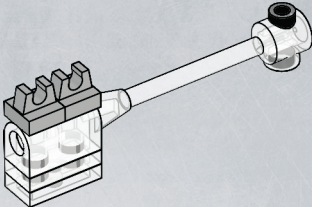

5

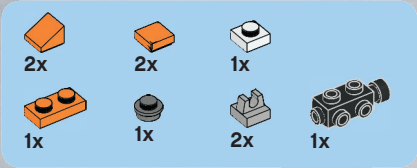

4

1

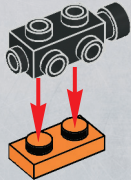

2

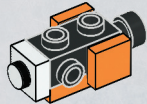

3

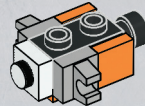

4

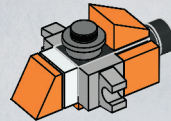

6

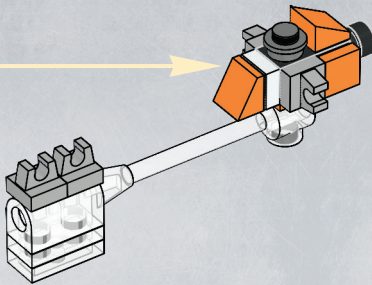
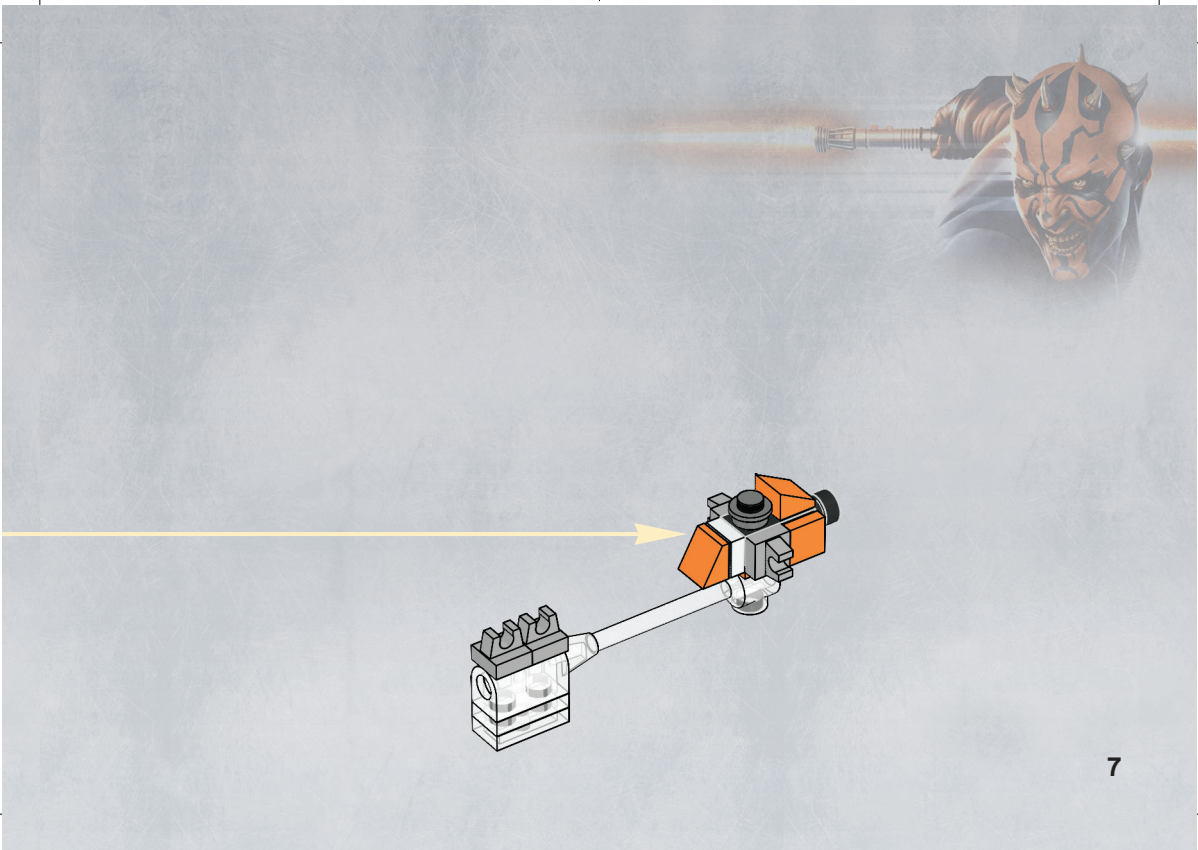

7





1

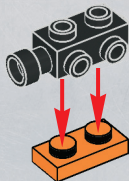

8



2

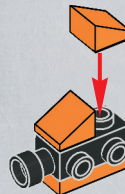

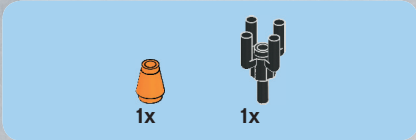

3

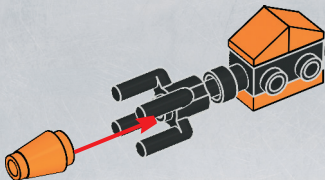

2x

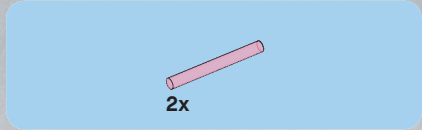

4

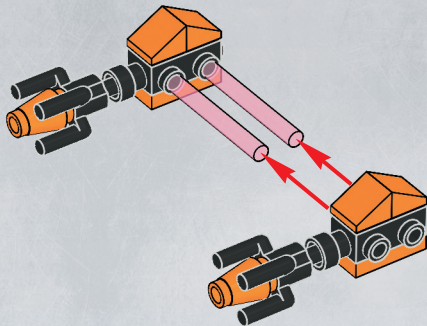

9



5

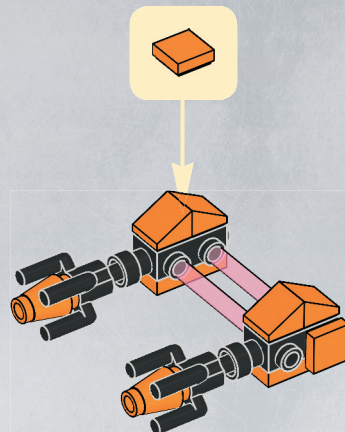

10



6

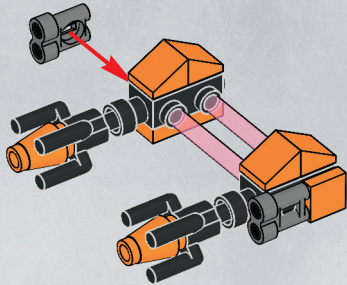

7

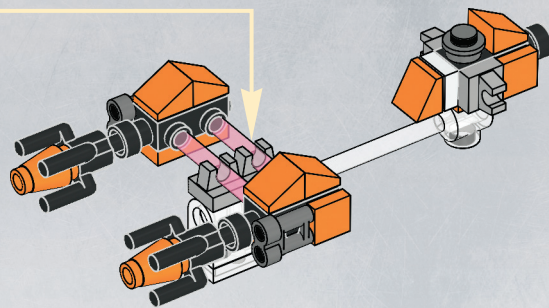

12



1x



1x

1

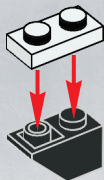

1x



1x

2





2x

3

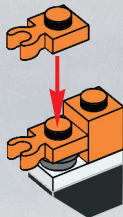

14



1x

4

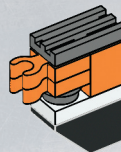

4x

8

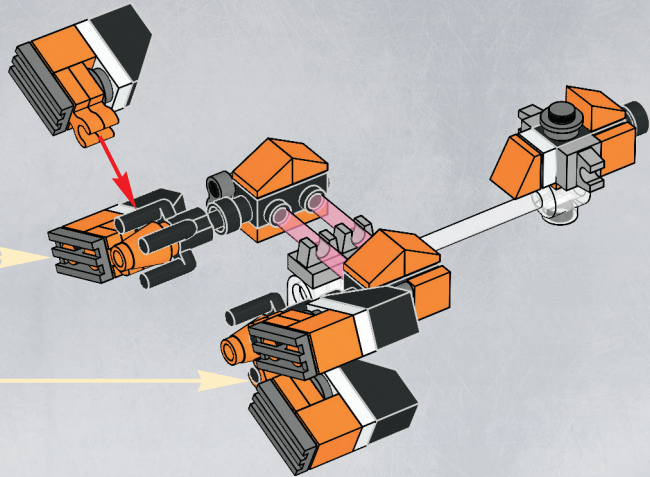

15



2x



2x

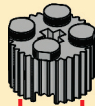

2x

9

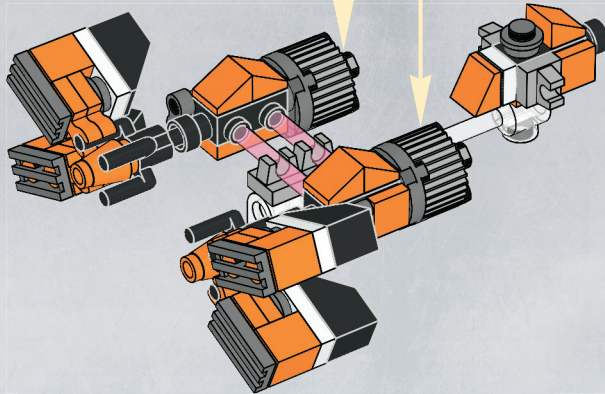

16

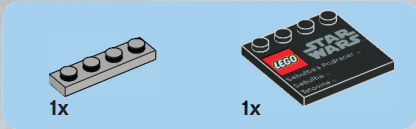

1

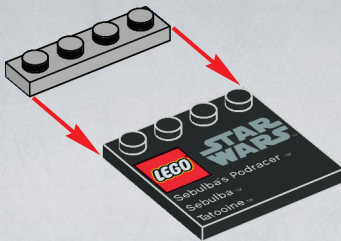

2



17

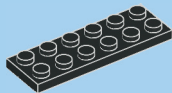

1x

3



18

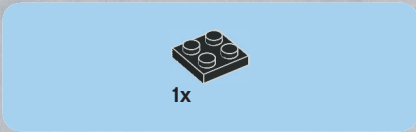

4

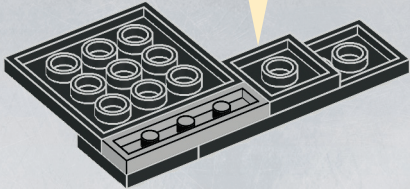
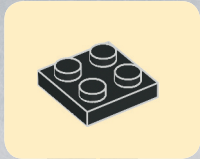

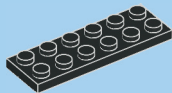

1x

5



20

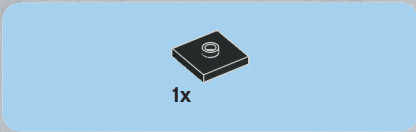

6

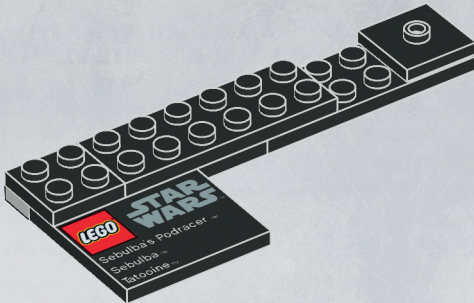



7

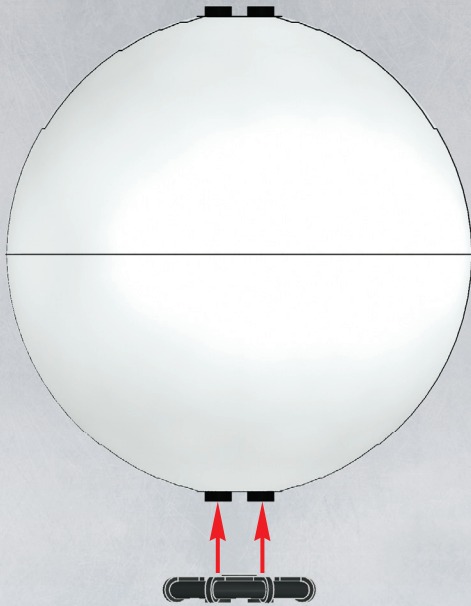

22

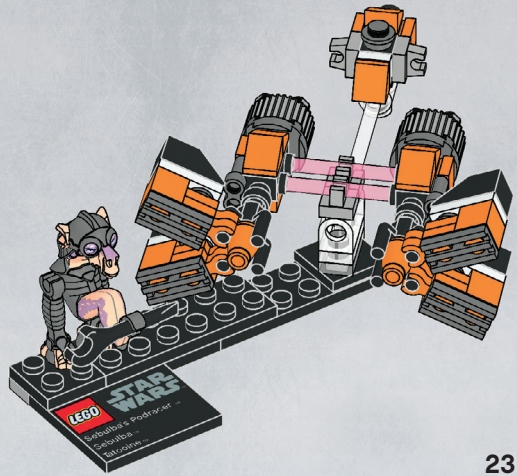



8

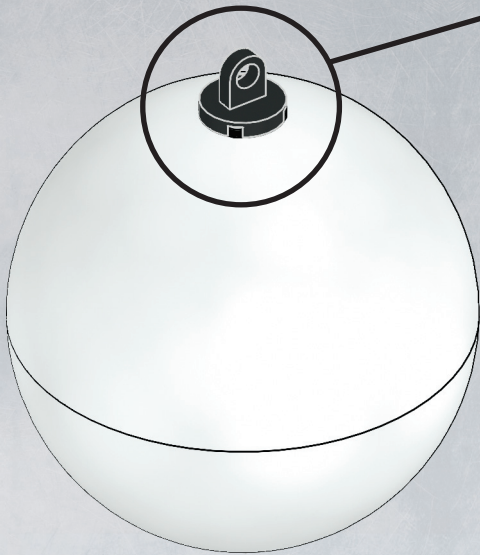

24



1x
302401



4x
302301



4x
4210631



5x
4210633



2x
4211042



1x
4622289



2x
4622290



2x
4211051



8x
4587052



2x
4655286



2x
4167842

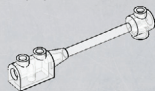

1x
4164065



2x
4650645



1x
4211445



4x
4211369



1x
400626



2x
4532220



4x
4173805



2x
4518029



6x
4504371



3x
4177932



4x
4558595



1x
4514342



1x
237626



2x
379526



1x
4655294



3x
4523339



4x
366526



1x
4565323



2x
302226



Customer Service

Kundenservice

Service Consommateurs

Servicio Al Consumidor

www.lego.com/service or dial



: 00800 5346 5555

: 1-800-422-5346



9493



9492



9491



9490



9489



9488





9488



9489



9490



9491



9492



9493



9488



9489



9490



9491



9492



9493



9488



9489



9490



9491



9492



9493



9488



9489



9490



9491



9492



9493

ACE ASSAULT II

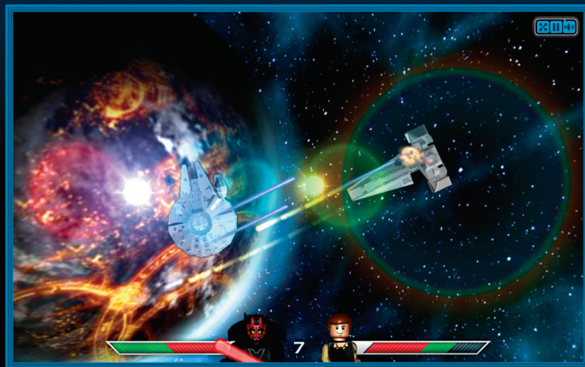

0704



starwars.LEGO.com



STAR WARS III

THE CLONE WARS™



videogames.LEGO.com
www.LucasArts.com



LucasArts and the LucasArts logo are registered trademarks of Lucasfilm Ltd. © 2005-2010 Lucasfilm Entertainment Company Ltd. or Lucasfilm Ltd. & ® or TM as indicated.
All rights reserved. LEGO, the LEGO logo and the Minifigure are trademarks of The LEGO Group. © 2005-2010 The LEGO Group. All rights reserved.



STAR WARS™

BATTLE OF HOTH™

© 2012 Lucasfilm Ltd. & TM. All rights reserved.



3866
Star Wars

8+   2/4 10-20



GAMES





www.LEGOclub.com



LEGO® Club Email

LEGO club™

FREE! GRATIS! GRATUIT!



LEGO® Club Magazine

SIGN UP ONLINE!

www.LEGOclub.com

00800 5346 5555*



1-866-534-6258 • 1-877-518-5346

US & Canada only

Canada seulement

BI110

- * Freephone. Mobile charges may apply.
- * Numéro sans frais. Des frais peuvent s'appliquer avec les téléphones cellulaires.
- * Gebührenfrei, Kosten für Anrufe aus Mobilfunknetzen können abweichen.
- * Gratis telefoonnummer vanaf vaste lijn.
- * Det er et gratis nummer, når du ringer fra fasttelefon.
- * Det är gratis, när du ringer från en fast telefon.
- * Numéro sans frais. Des frais peuvent s'appliquer avec les téléphones portables.





WIN!

Go to www.LEGOsurvey.com/product
to fill out a survey for a chance
to win a cool LEGO® Product.
No purchase necessary.
Open to all residents where not prohibited.



www.LEGO.com

www.LEGOsurvey.com/product

GEWINNE!

Nimm an der Umfrage auf www.LEGOsurvey.com/product teil und hab die Chance ein cooles LEGO® Produkt zu gewinnen! Die Teilnahme am Gewinnspiel führt zu keinerlei Kaufverpflichtungen. Teilnahme in allen nicht ausgeschlossenen Ländern möglich.

WIN!

Ga naar www.LEGOsurvey.com/product, vul een enquêteformulier in en maak kans op een cool LEGO® product. Geen aankoopverplichting, iedereen mag deelnemen, uitgezonderd ingezetenden van landen waar een enquêteverbod geldt.

GAGNE!

Visite www.LEGOsurvey.com/product pour répondre à un questionnaire et avoir une chance de gagner un produit LEGO® très cool ! Aucune obligation d'achat. Ouvert à tous les résidents des pays autorisés.

当てよう!

www.LEGOsurvey.com/product にアクセスして、アンケートにご記入ください。当選者にはレゴ製品を差し上げます。お買い上げの必要はありません。禁止されていない限り、すべての皆様にご利用いただけます。

6003447

LEGO and the LEGO logo are trademarks of the LEGO Group. ©2012 The LEGO Group.
© 2012 Lucasfilm Ltd. & TM. All rights reserved.