



STAR WARS



75015





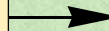

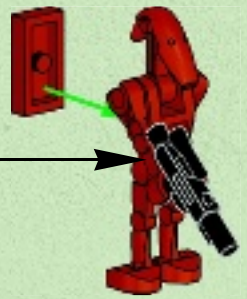
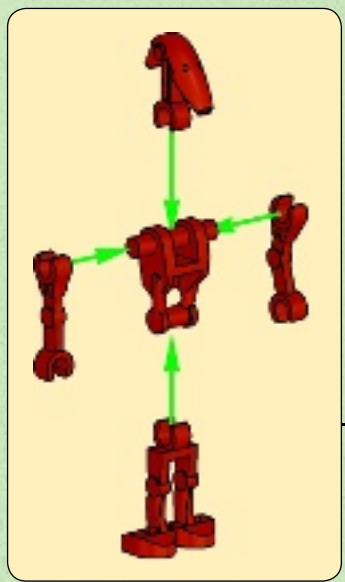
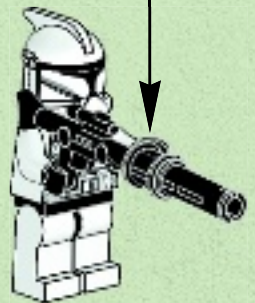
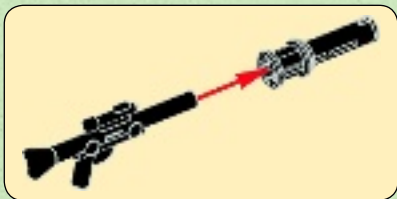



1

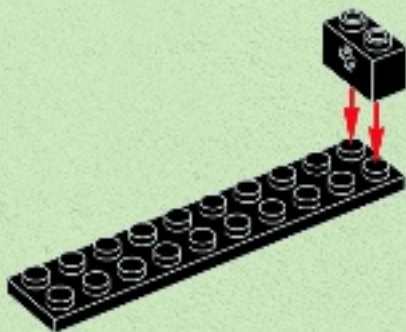

2

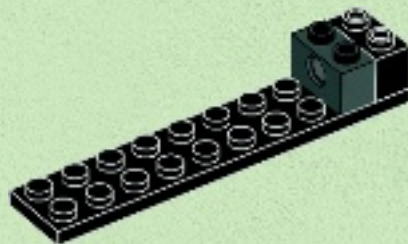



2x



2x

3

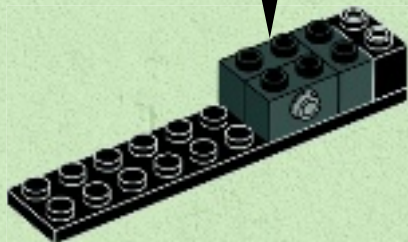
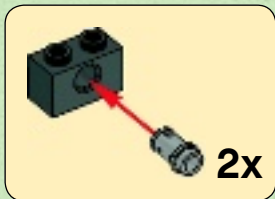

1x



2x

4

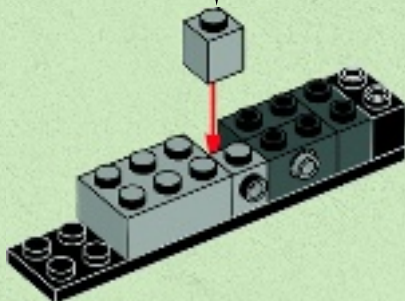



1x



1x

5

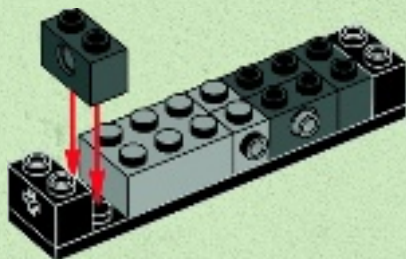

1x



1x



1x



2x

6

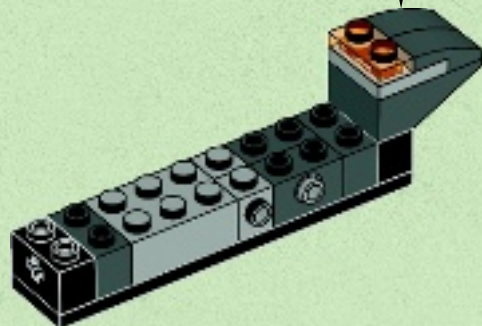
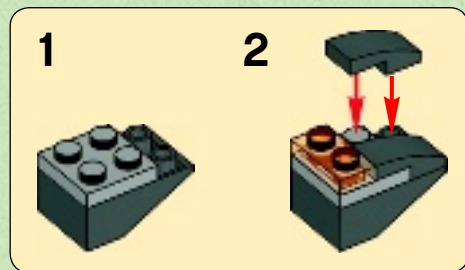



2x



2x

7

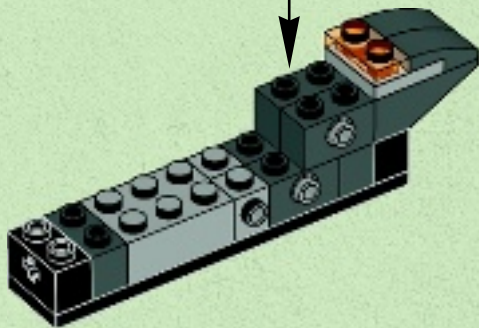
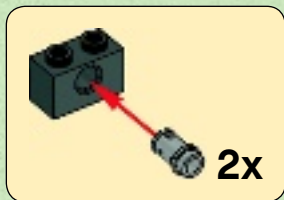

8



2x

8

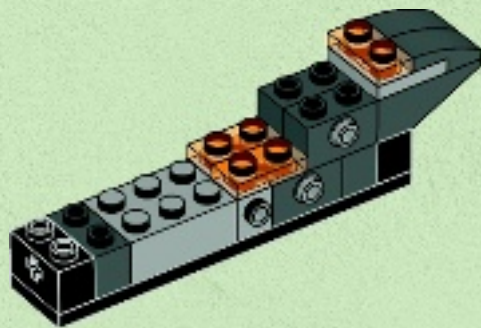



2x



2x

9

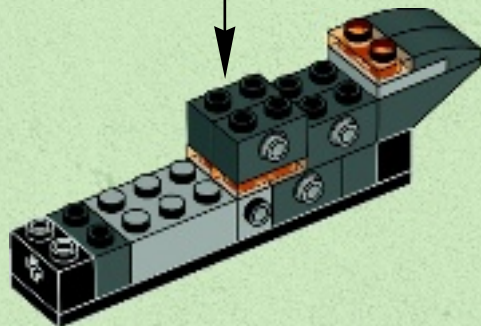
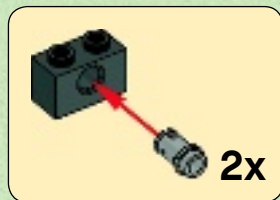

1x



1x

10

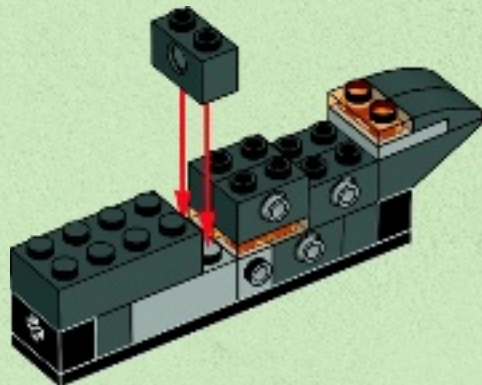



2x



1x

11

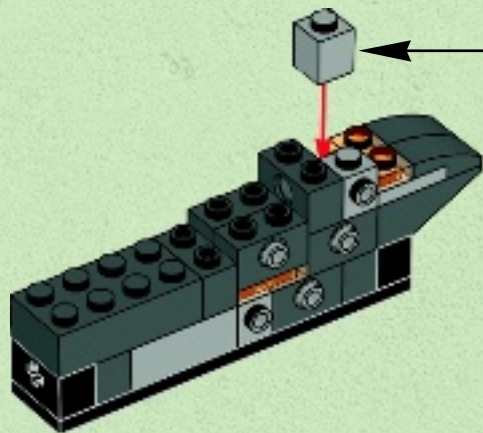

3x

12

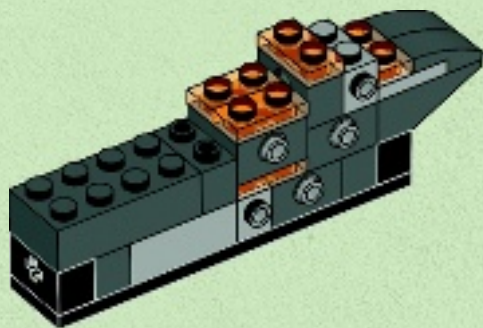



4x

13

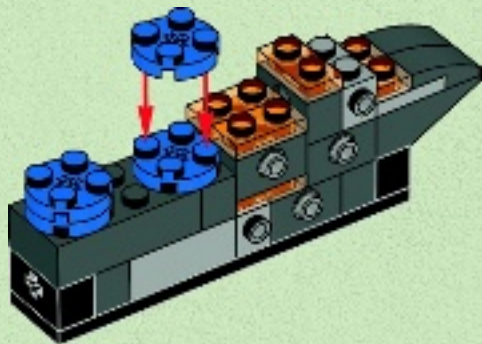

2x

14

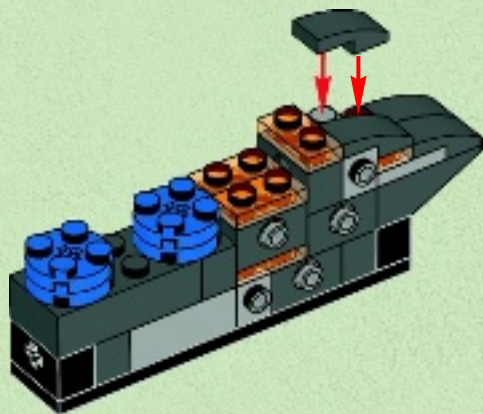



15

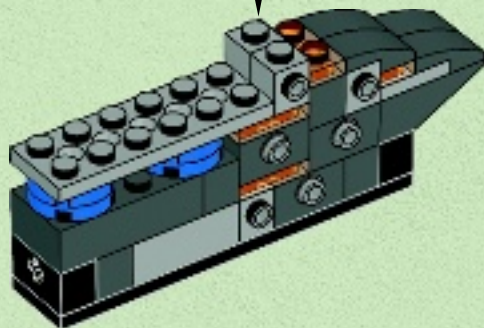
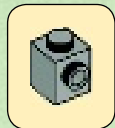

16

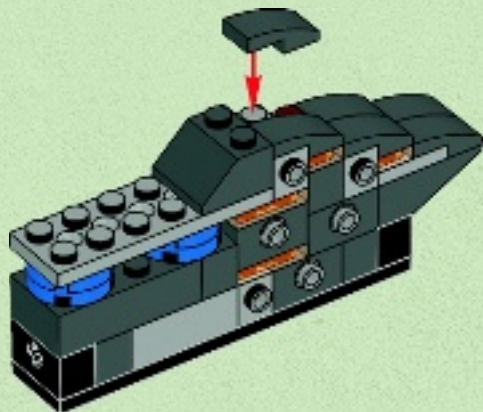



6x

17



3x

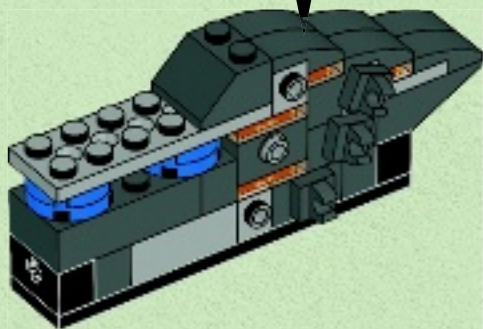

6x

18

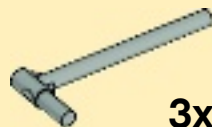

3x

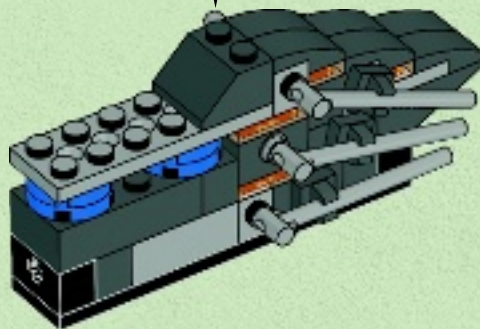

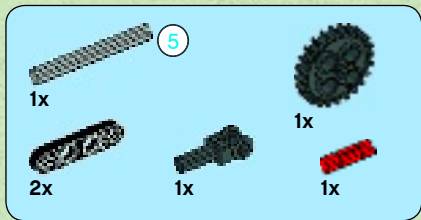

19

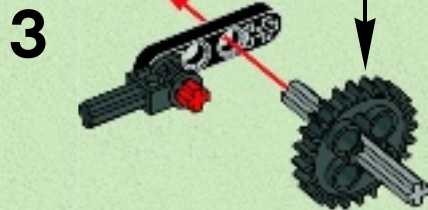
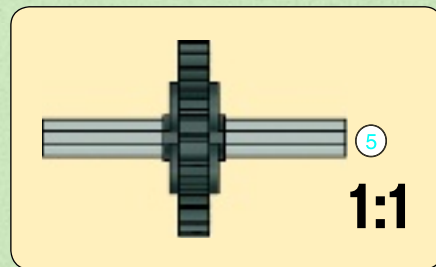

4

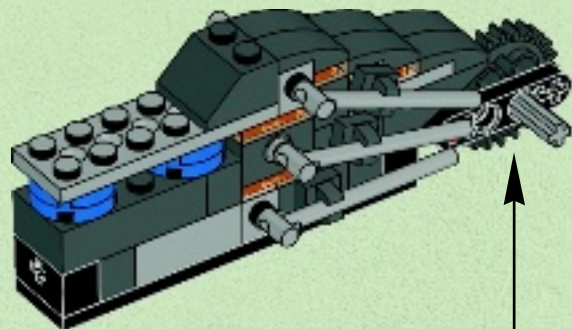



1

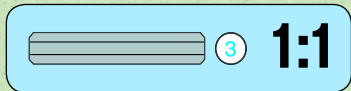

2

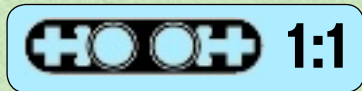
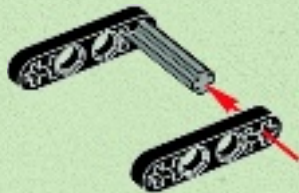

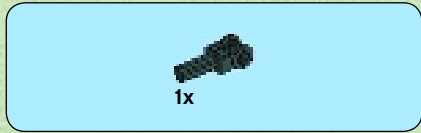

3

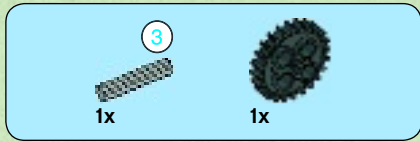
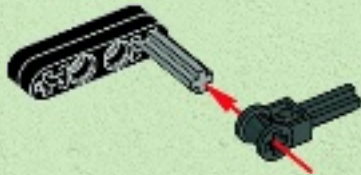

4

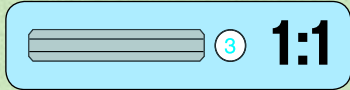
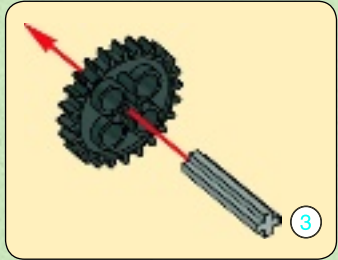
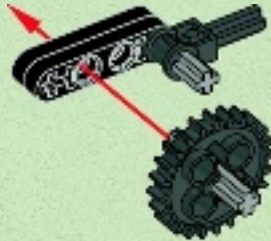



2x

5

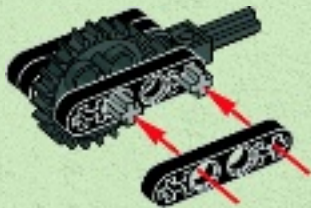

1:1

20

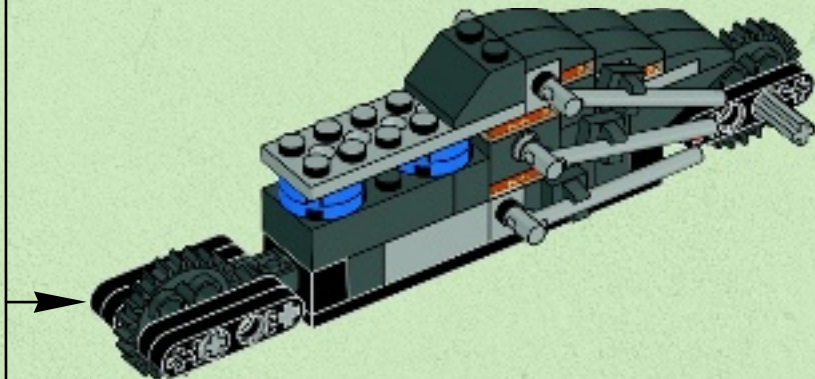



2x



2x

21

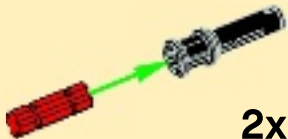

2x

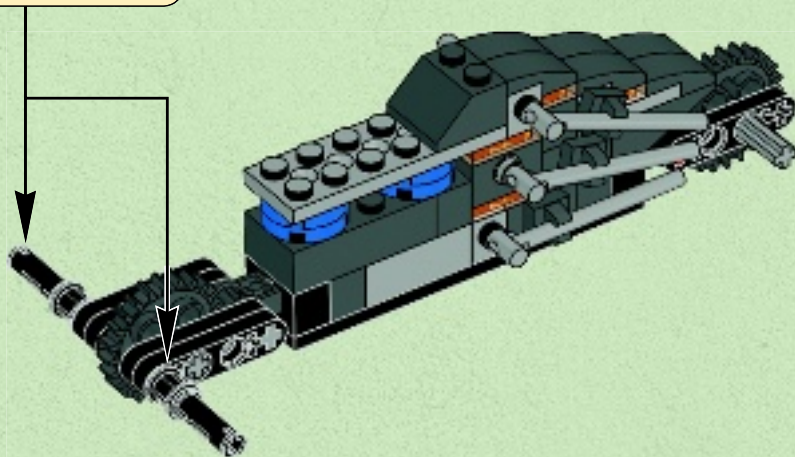

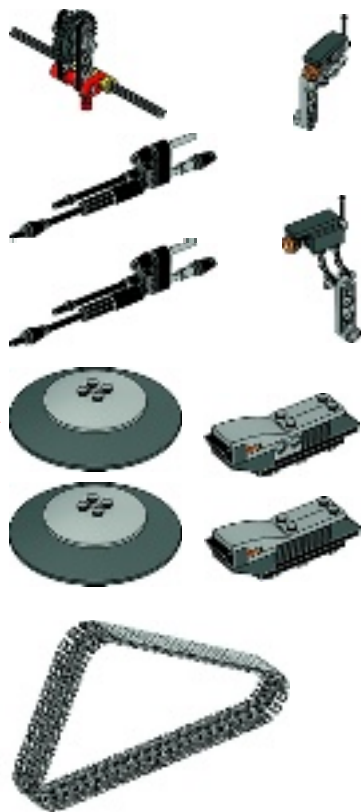

1



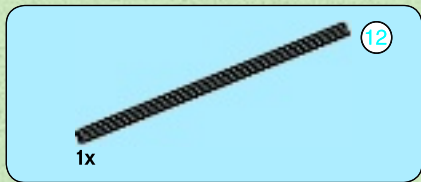

2

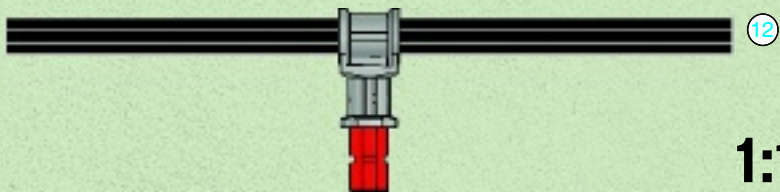



2x

3

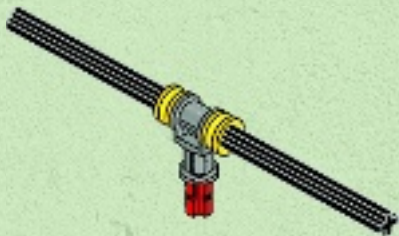

1x



1x

4

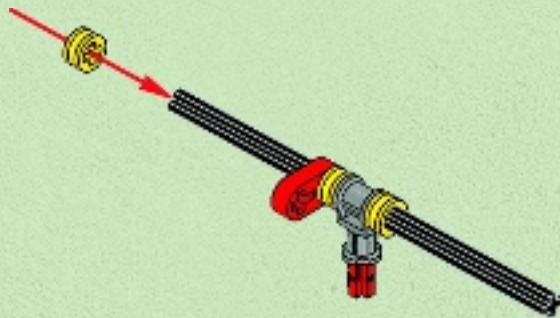

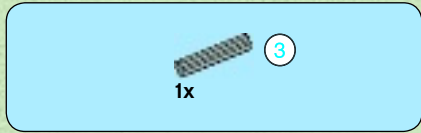

5

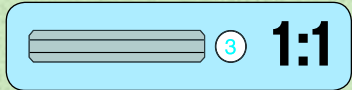
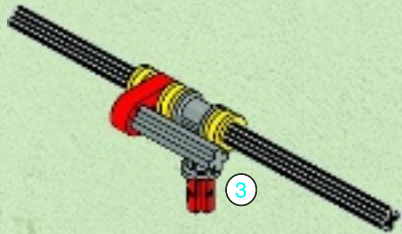

6

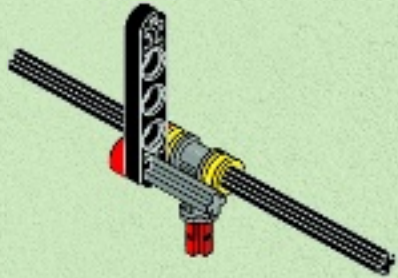



7

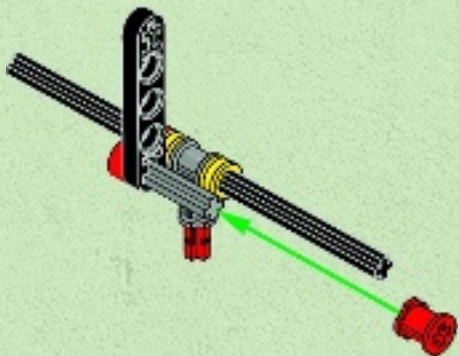

3



8

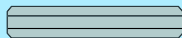
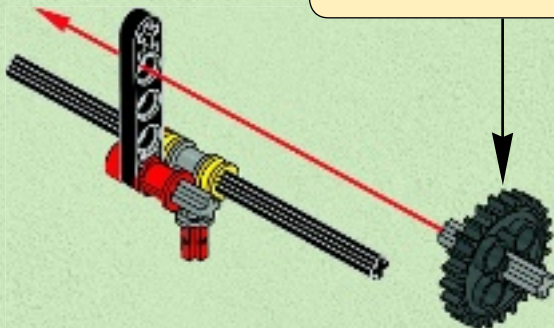

1:1



1x

9

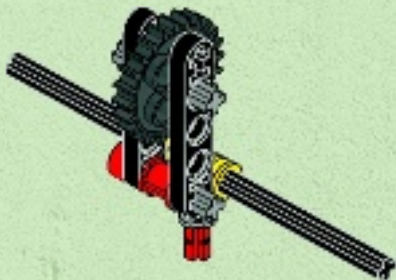

1:1



1x



1x

10

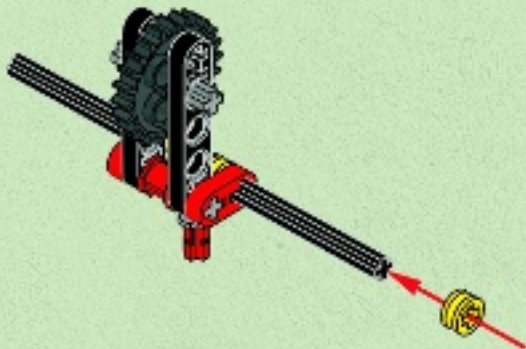

22

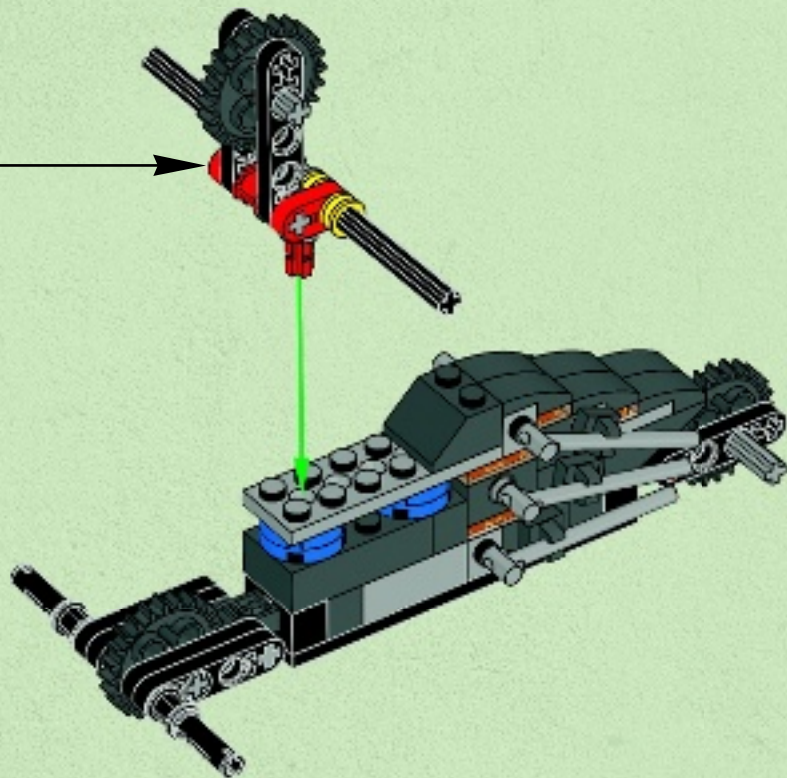



2x

23

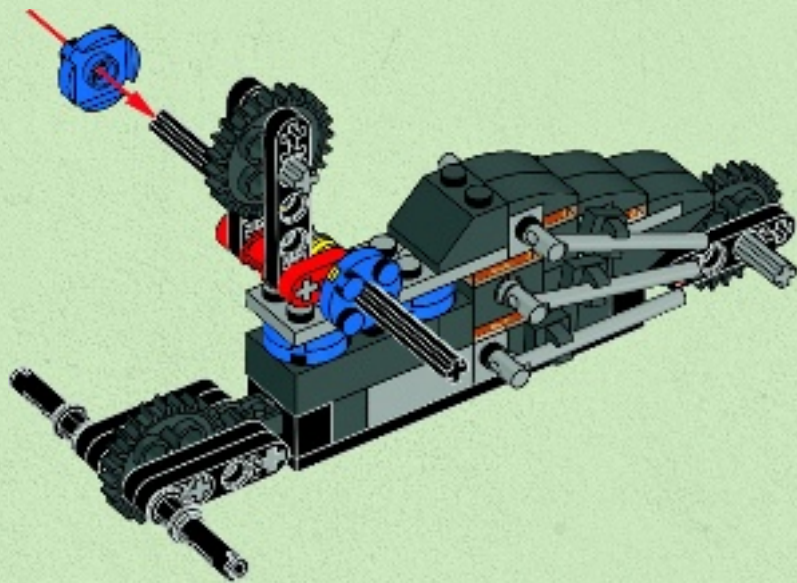



24

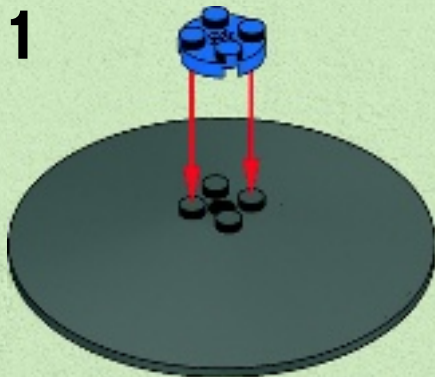

2



2x

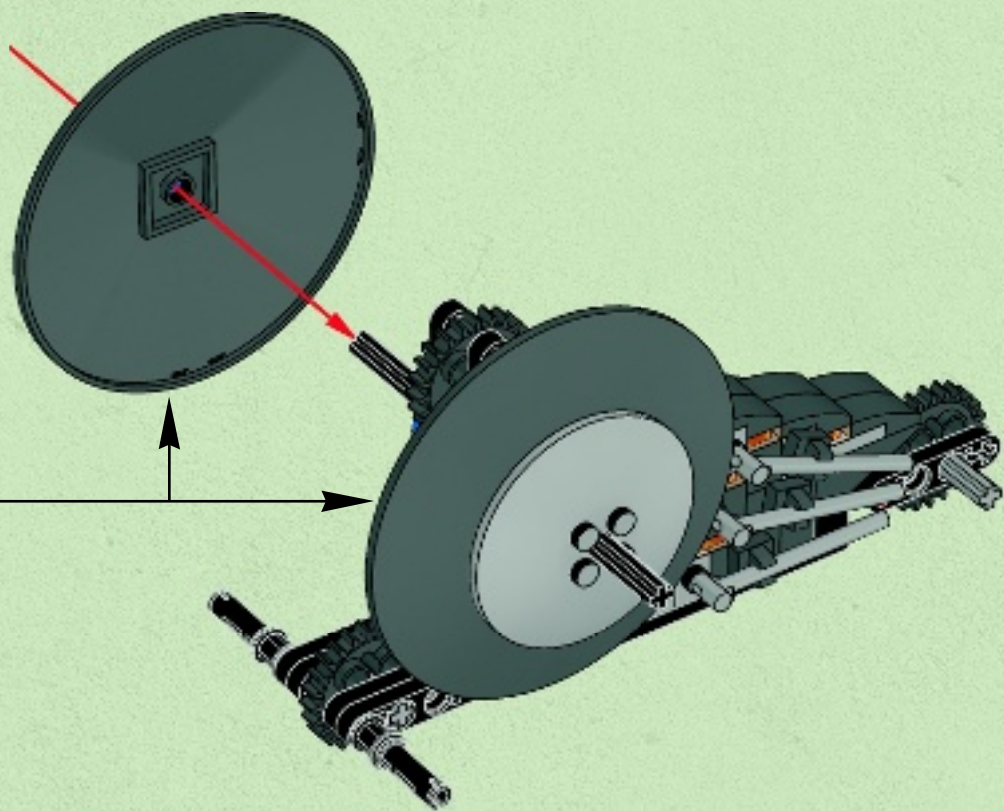

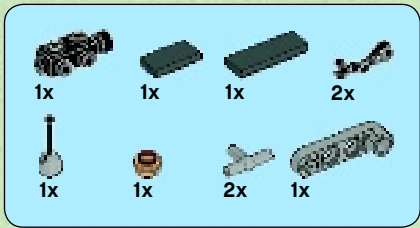

25

1

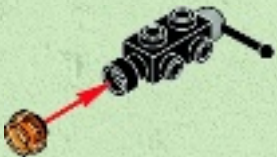

2



3



4

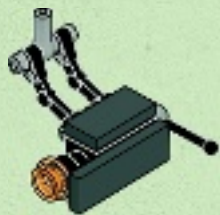

5

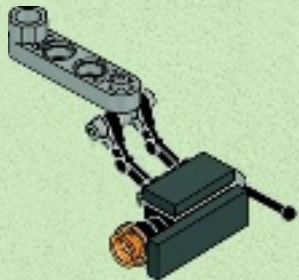

6

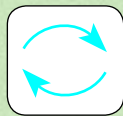

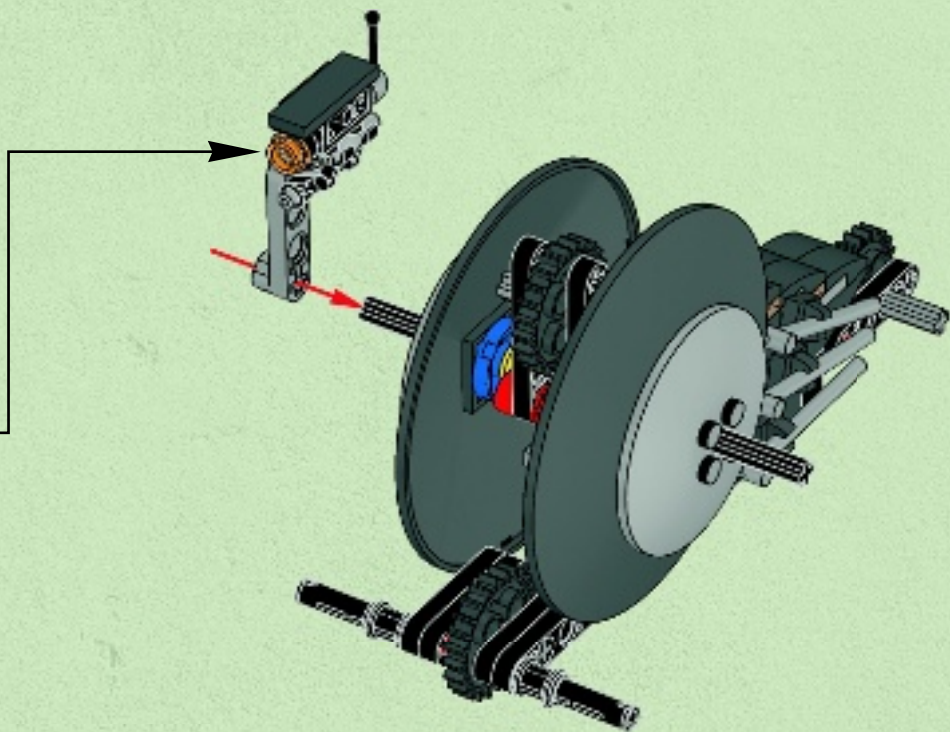

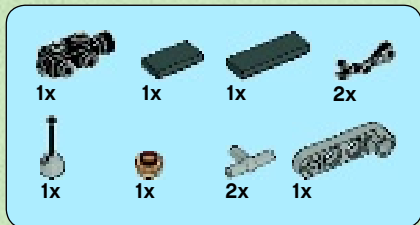

26

1



2



3

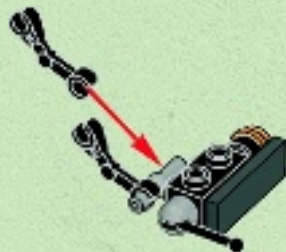

4



5

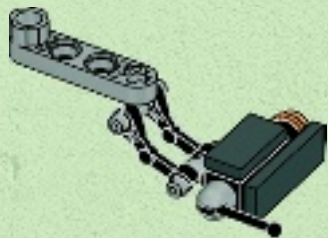

6

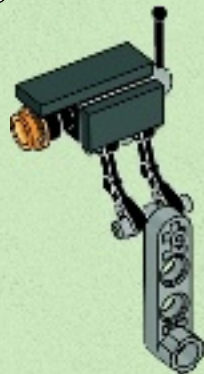
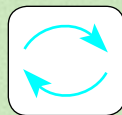

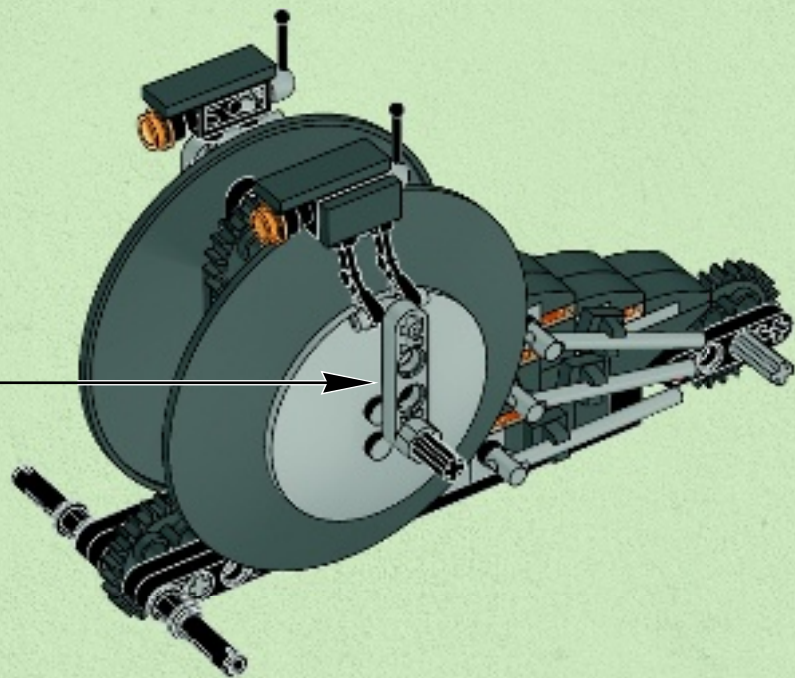

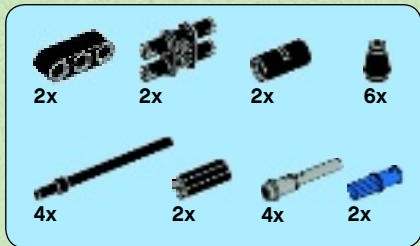

27

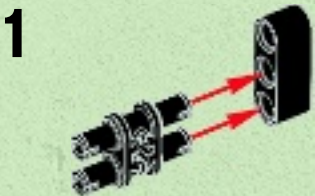

2

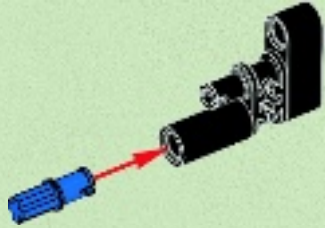

3

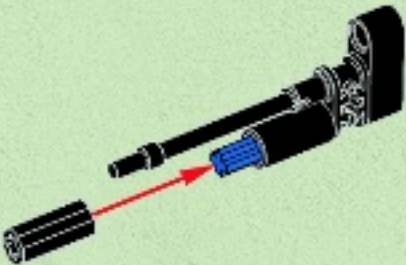

4

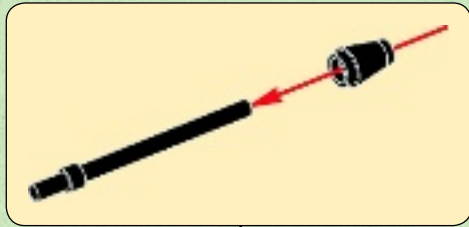

5

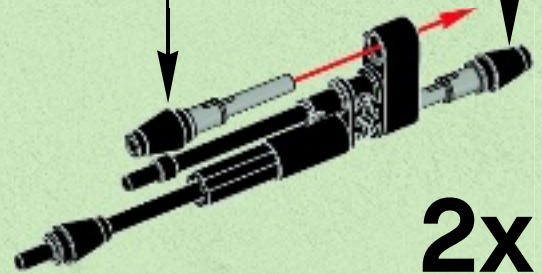
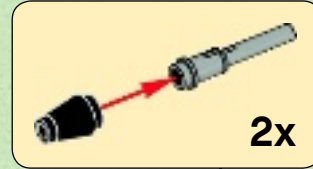

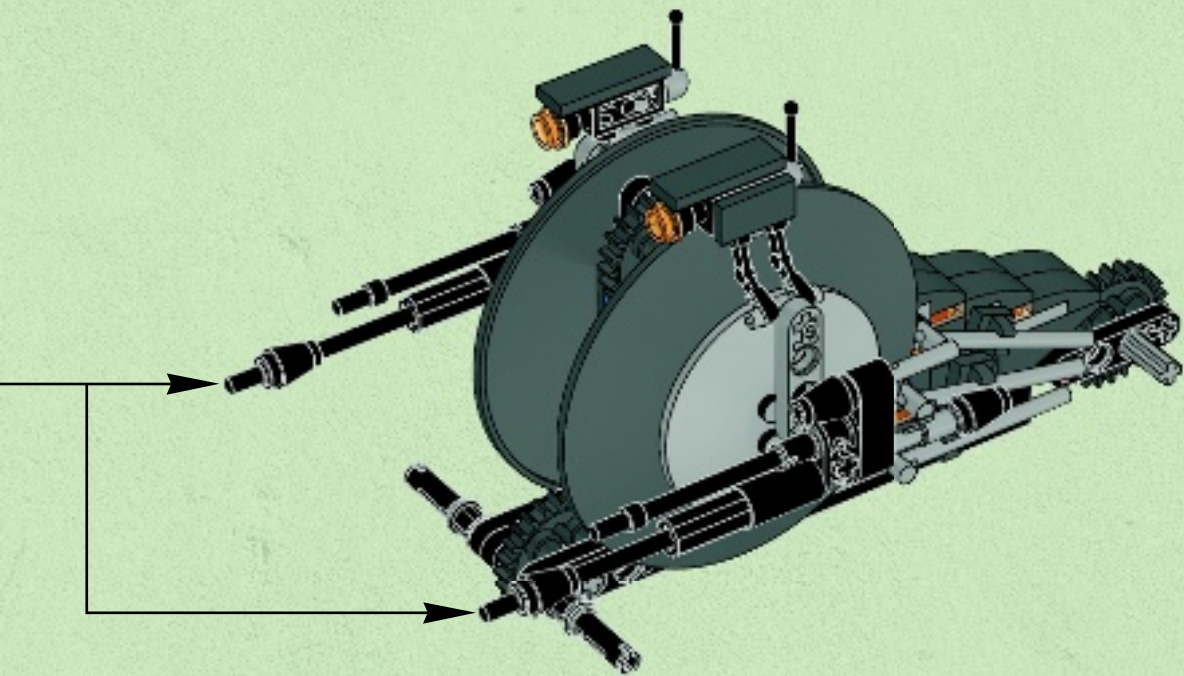



2x

28

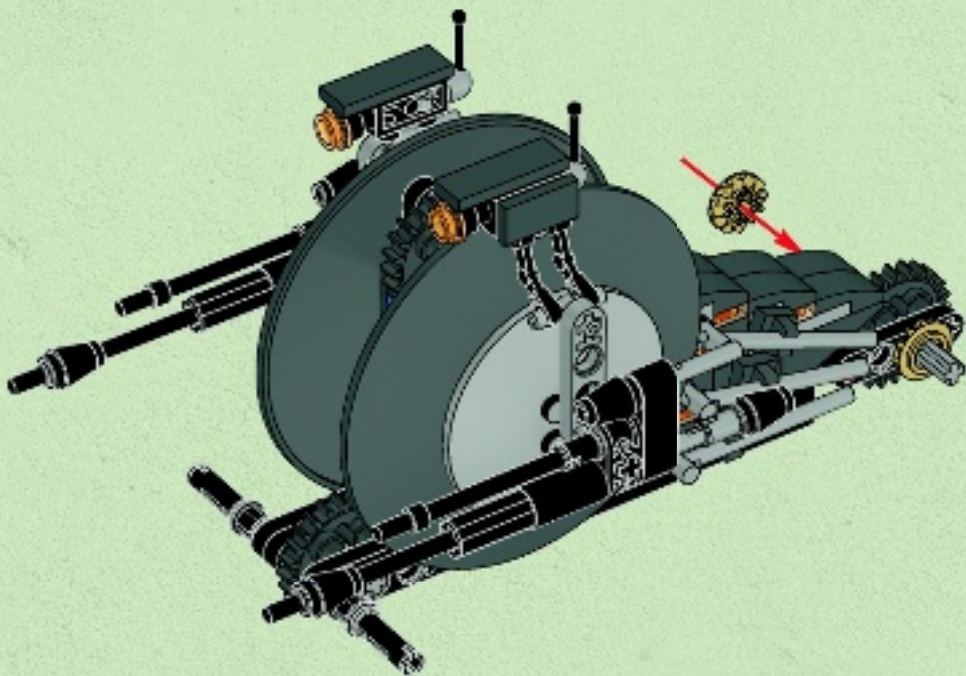

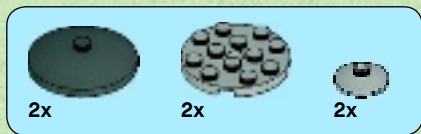

29

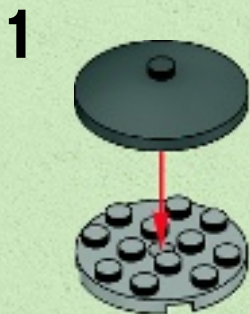

2x

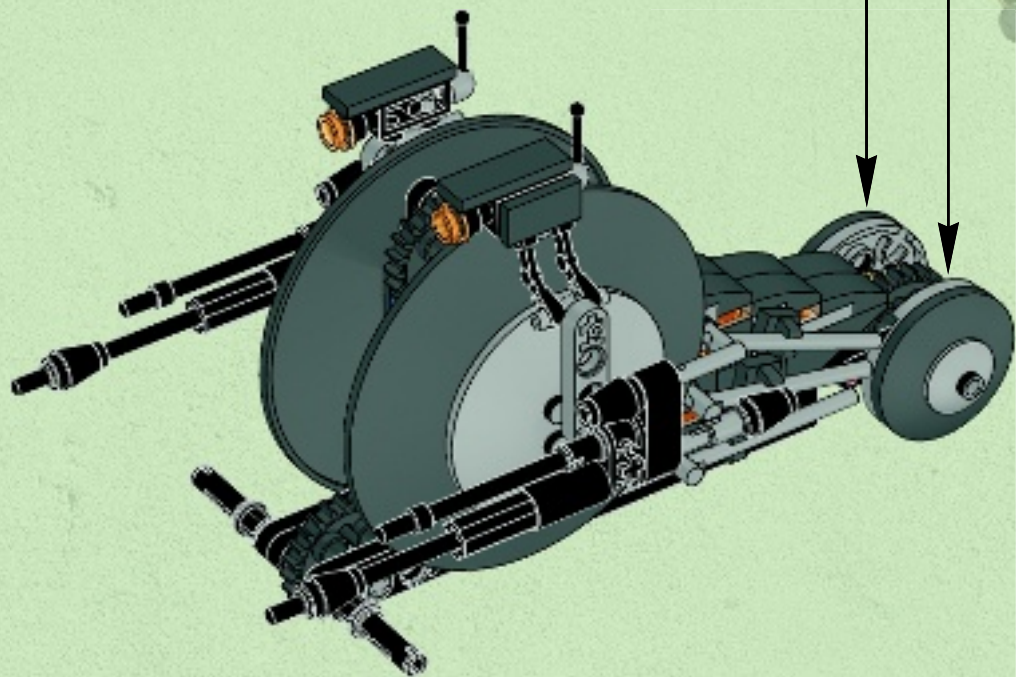



1x



1x

1



2x

2

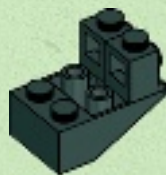

1x

3





1x



1x

4



1x

5

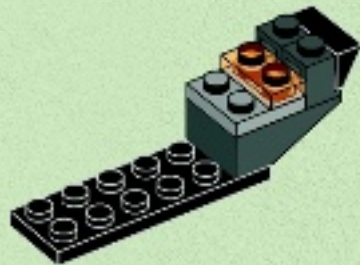



1x

6

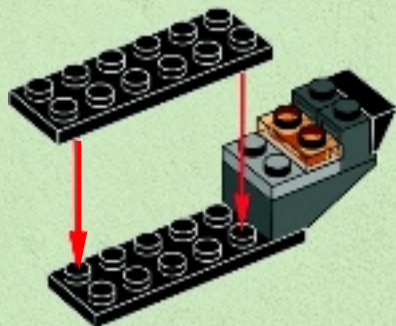

1x

7

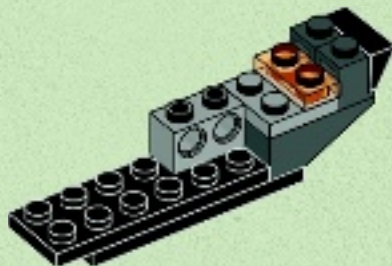



3x

8

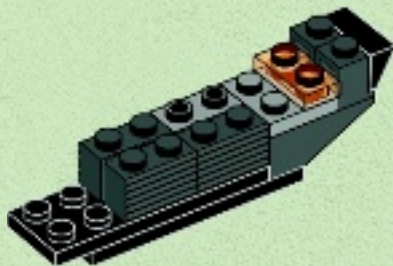

1x



1x

9

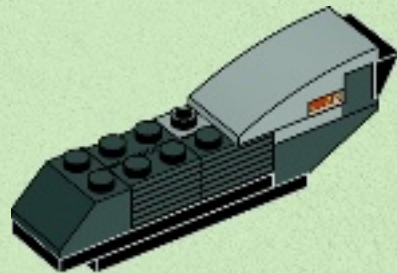



2x

10

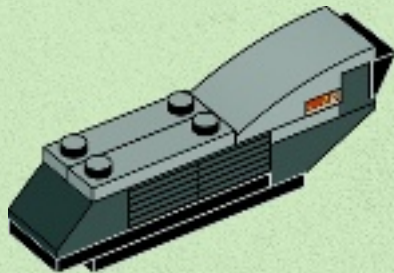

3x

11

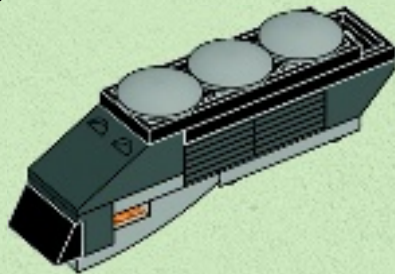
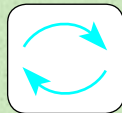

30

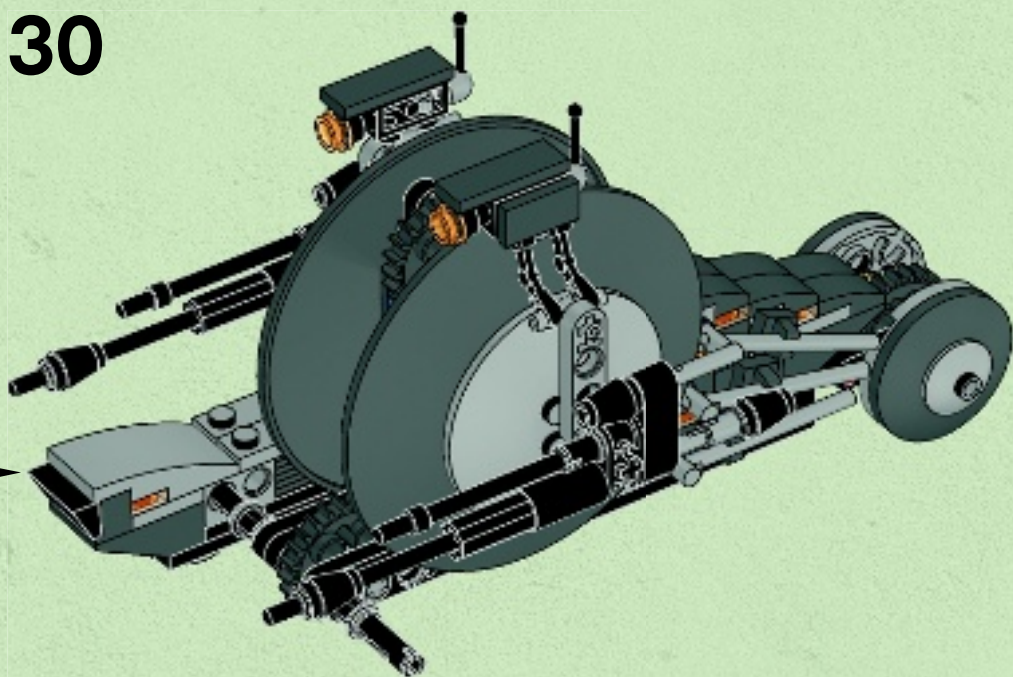



1x



1x

1



2x

2

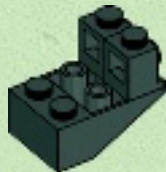

1x

3

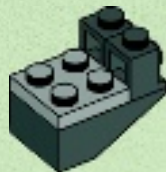



1x



1x

4



1x

5

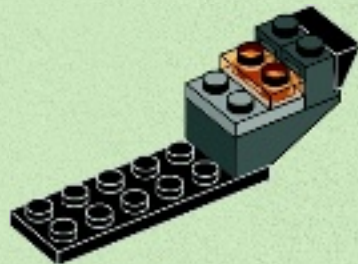



1x

6

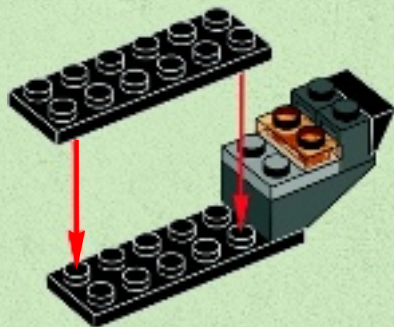

2x

7

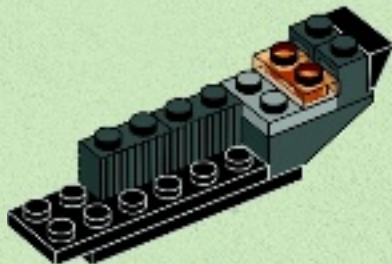



1x



1x

8

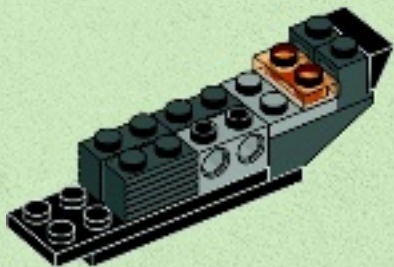

1x



1x

9

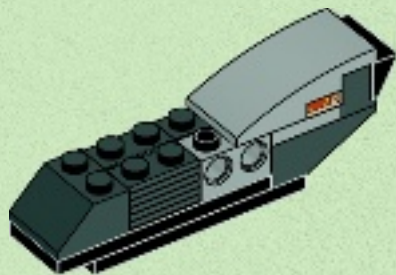



2x

10

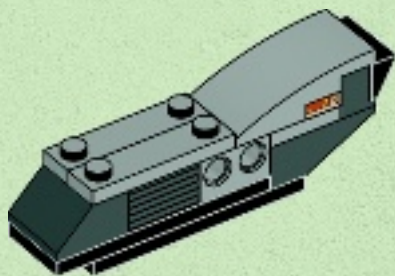

3x

11

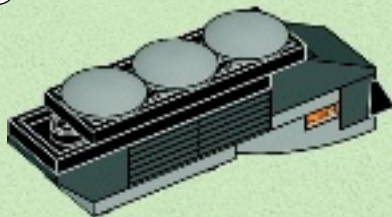
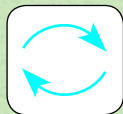

31

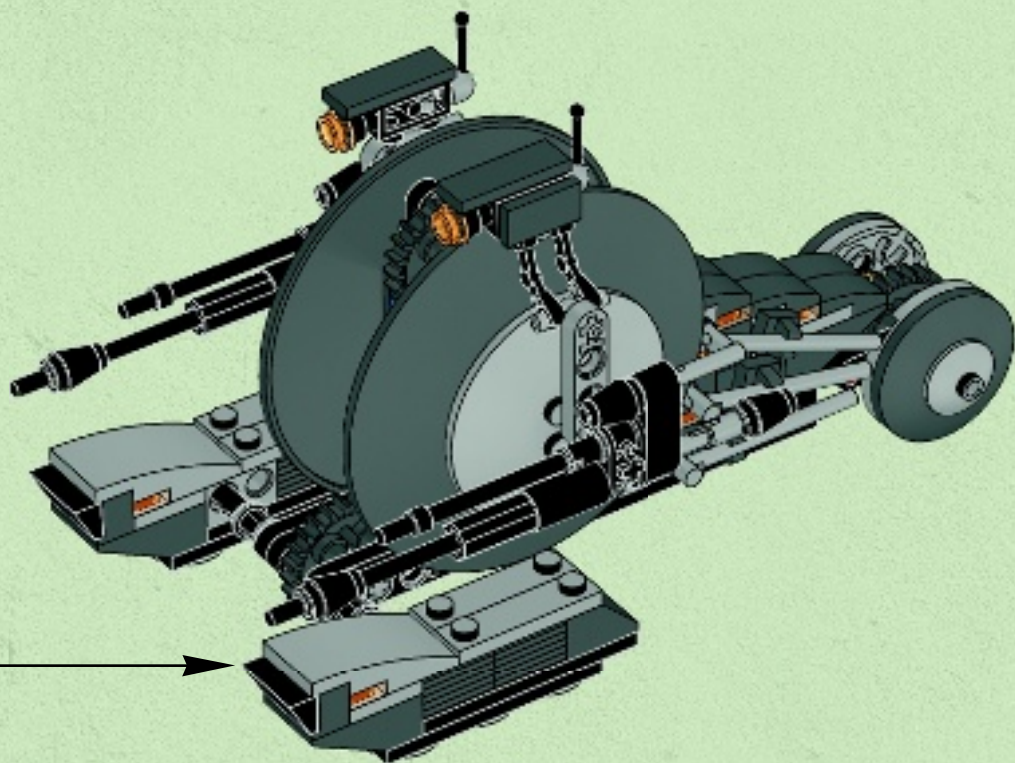



60x

32

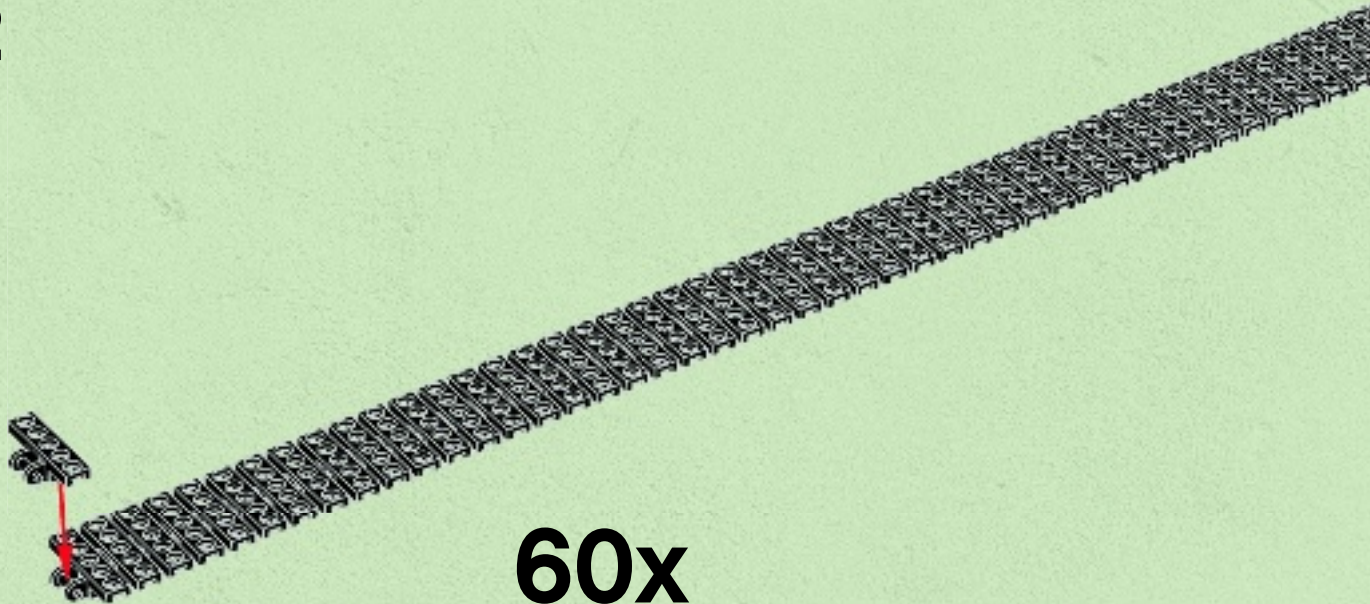

60x

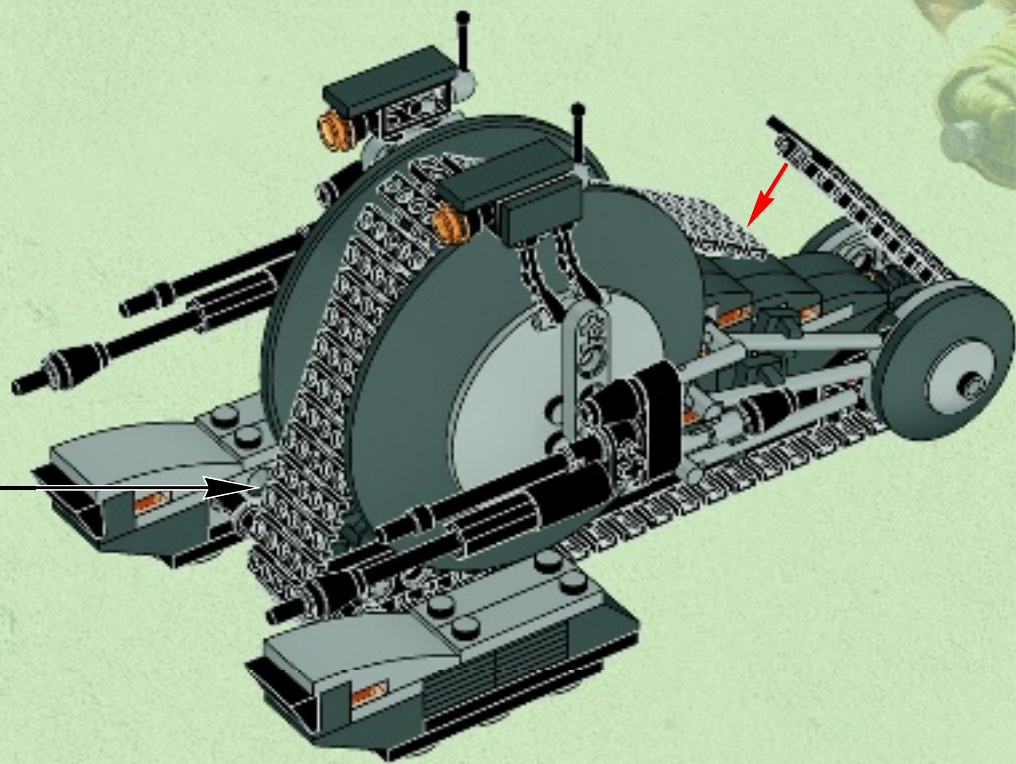

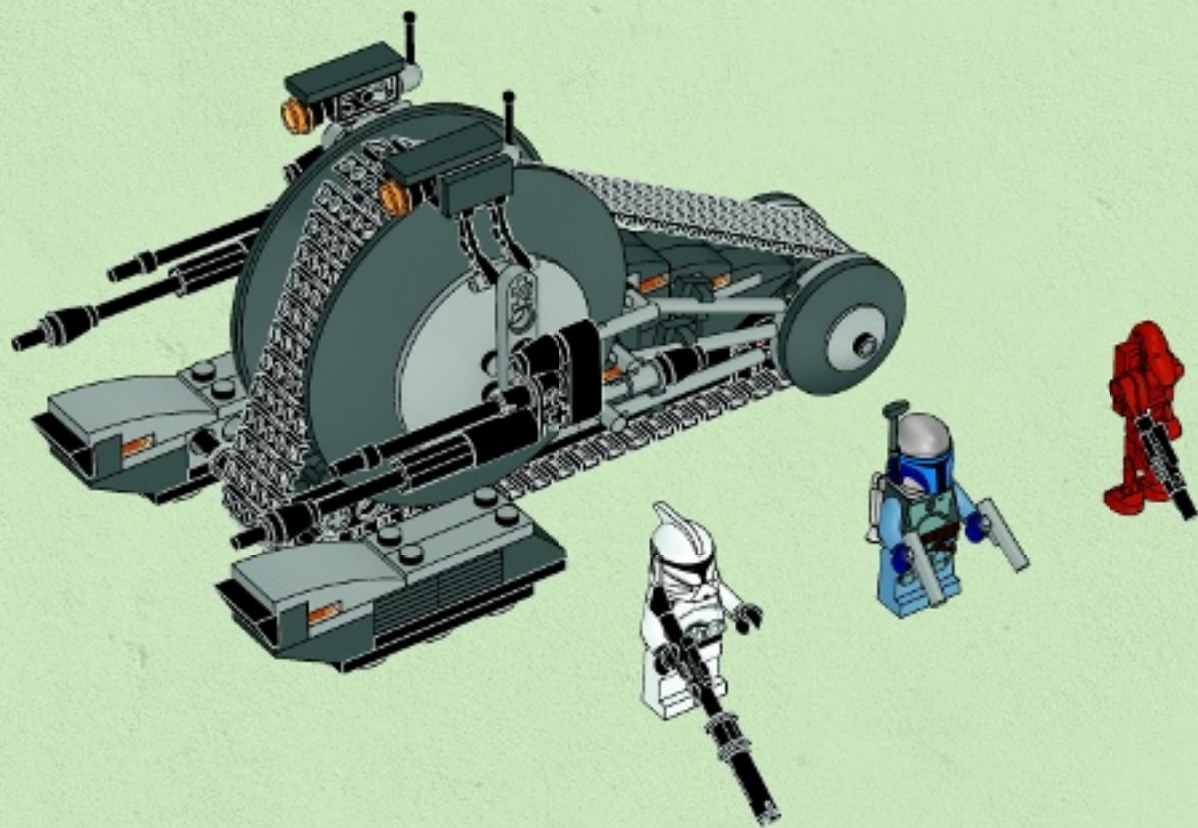



Customer Service

Kundenservice

Service Consommateurs

Servicio Al Consumidor

LEGO.com/service or dial



: 00800 5346 5555

: 1-800-422-5346



Internet Connection Required
Internetverbindung erforderlich
Connexion Internet requise
Se requiere conexión a Internet
Requer ligação à Internet
Internetkapcsolat szükséges

LEGO.com/starwars

75015



75016



75017



75018



75019



75020



75021



75022





WIN!

Go to www.LEGOsurvey.com/product to fill out a survey for a chance to win a cool LEGO® Product.

No purchase necessary.

Open to all residents where not prohibited.



www.LEGOsurvey.com/product

GEWINNE!

Nimm an der Umfrage auf www.LEGOsurvey.com/product teil und hab die Chance ein cooles LEGO® Produkt zu gewinnen!

Die Teilnahme am Gewinnspiel führt zu keinerlei Kaufverpflichtungen. Teilnahme in allen nicht ausgeschlossenen Ländern möglich.

WIN!

Ga naar www.LEGOsurvey.com/product, vul een enquêteformulier in en maak kans op een cool LEGO® product.

Geen aankoopverplichting. Iedereen mag deelnemen, uitgezonderd ingezetenden van landen waar een enquêteverbod geldt.

GAGNE!

Visite www.LEGOsurvey.com/product pour répondre à un questionnaire et avoir une chance de gagner un produit LEGO® très cool!

Aucune obligation d'achat. Ouvert à tous les résidents des pays autorisés.

当てよう!

www.LEGOsurvey.com/product にアクセスして、アンケートにご記入ください。当選者にはレゴ®製品を差し上げます。

お買い上げの必要はありません。禁止されていない限り、すべての皆様にご利用いただけます。



LEGO.com

6050669

LEGO and the LEGO logo are trademarks of the LEGO Group. ©2013 The LEGO Group. © 2013 Lucasfilm Ltd. & TM. All rights reserved.