

# Friends



41006



1



2



3



4



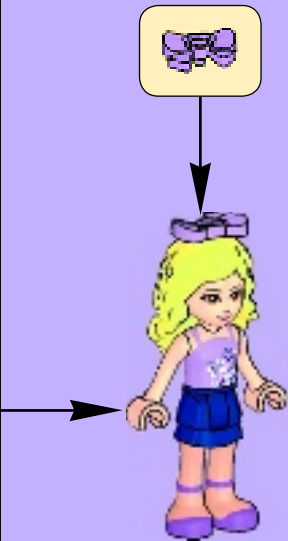
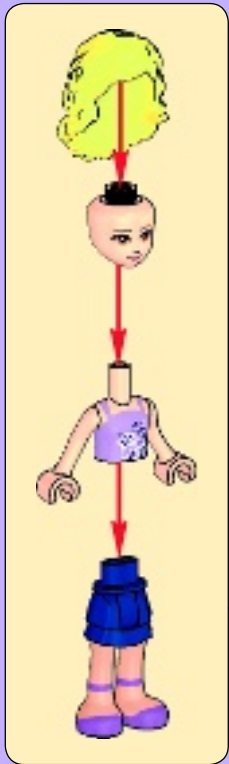
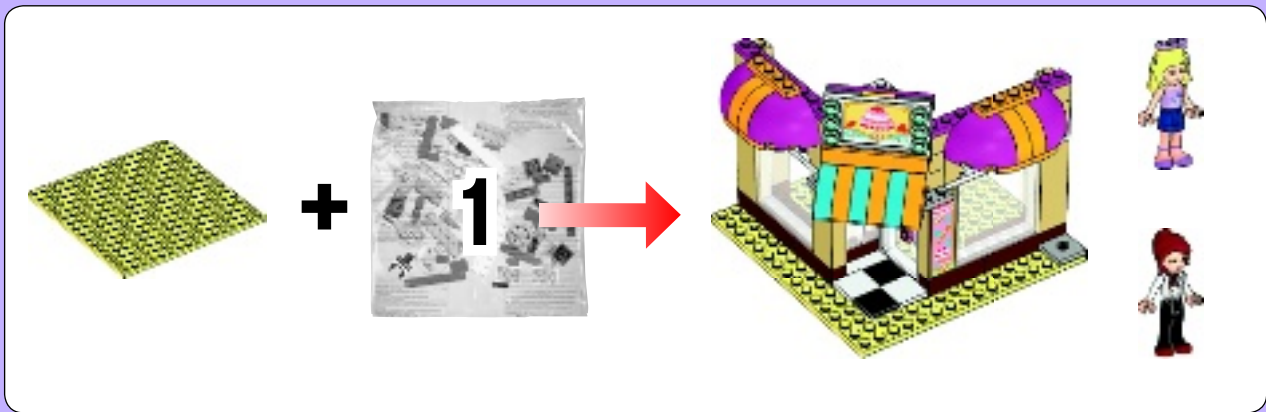

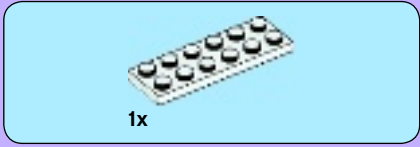

1x

1

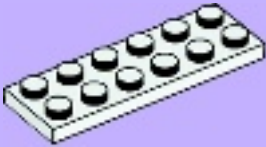

3x

2

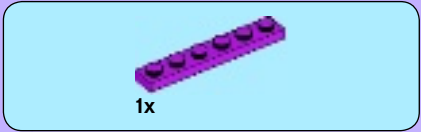
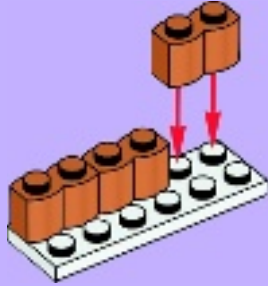

1x

3





2x

4



2x



2x

6



1x



1x

5



2x



2x

7



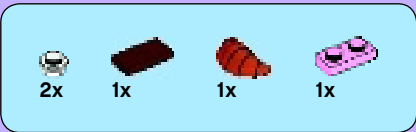

8

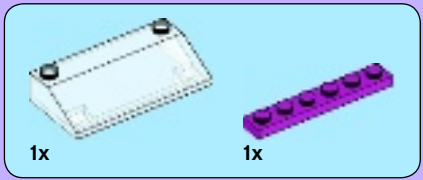
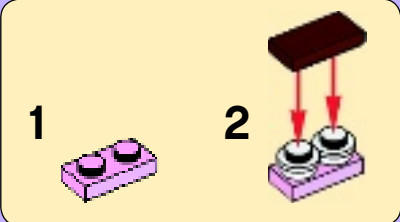

9

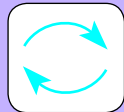



1

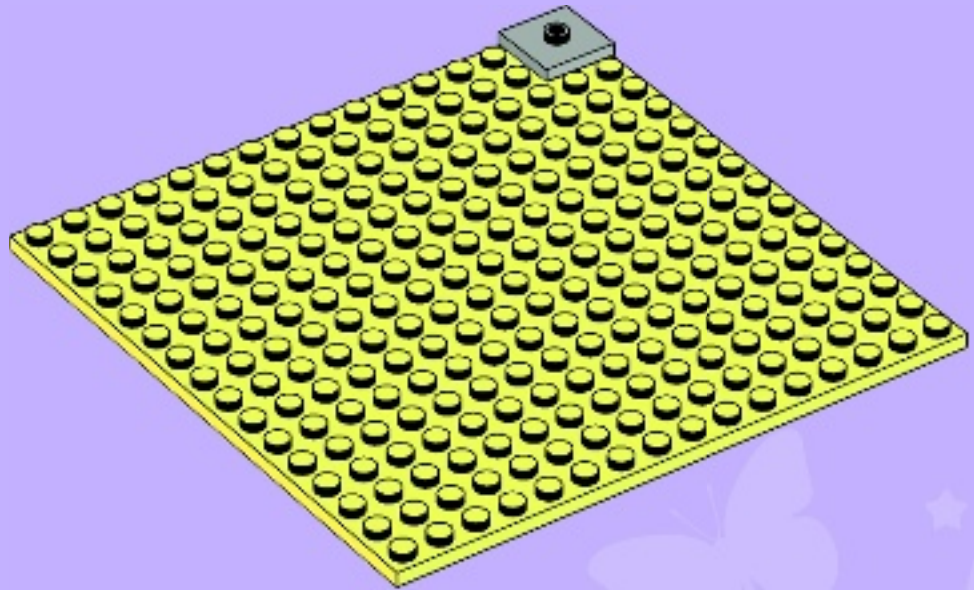

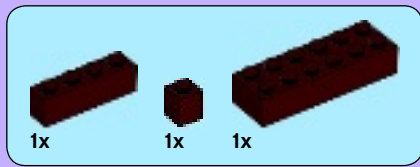

2

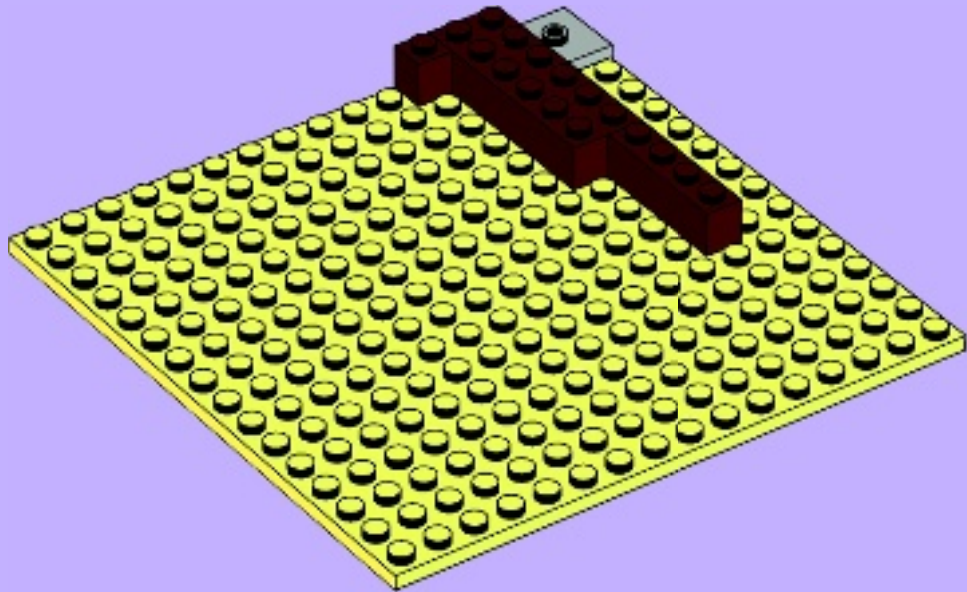



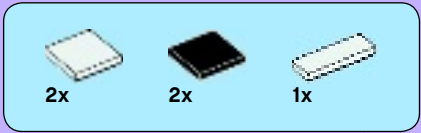

3

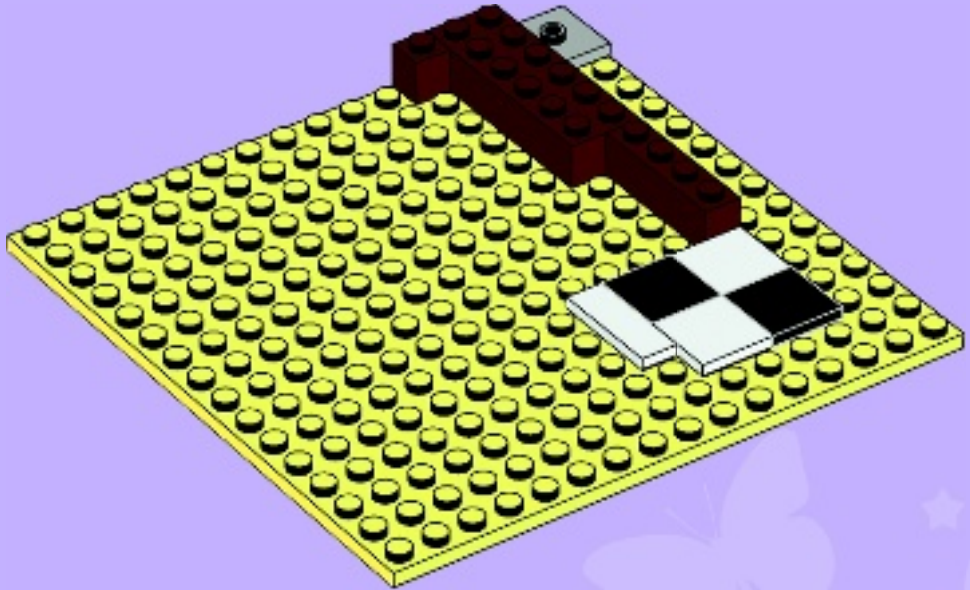



2x

4

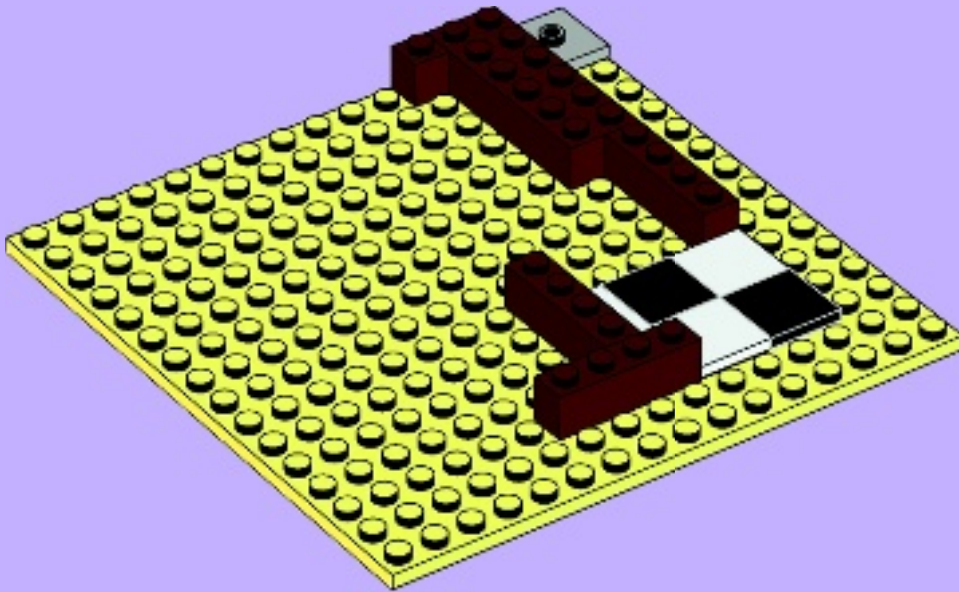

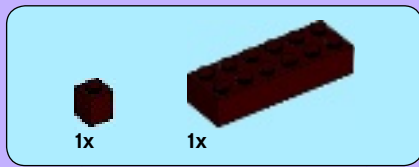

5

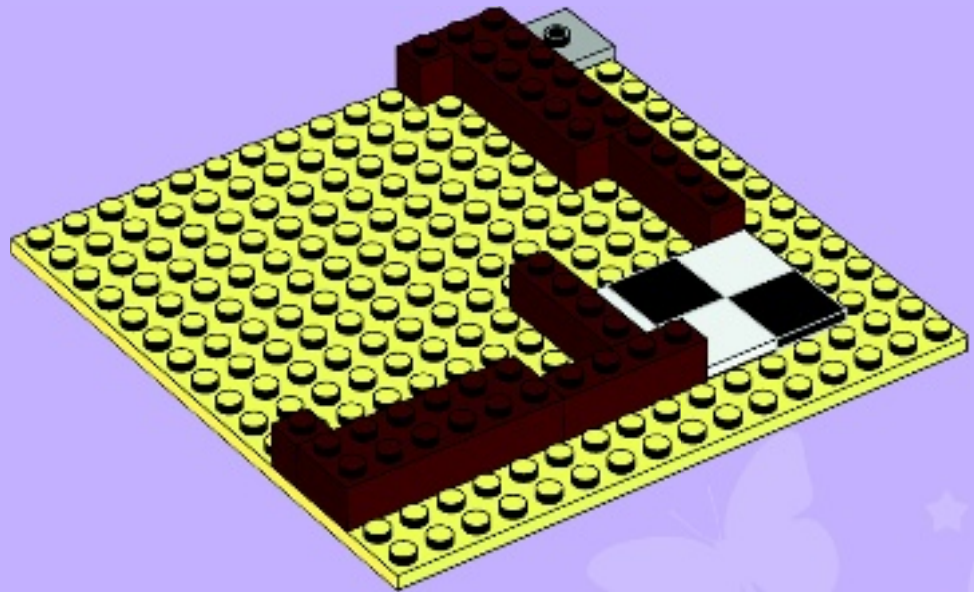

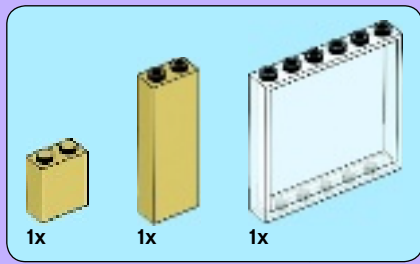

6

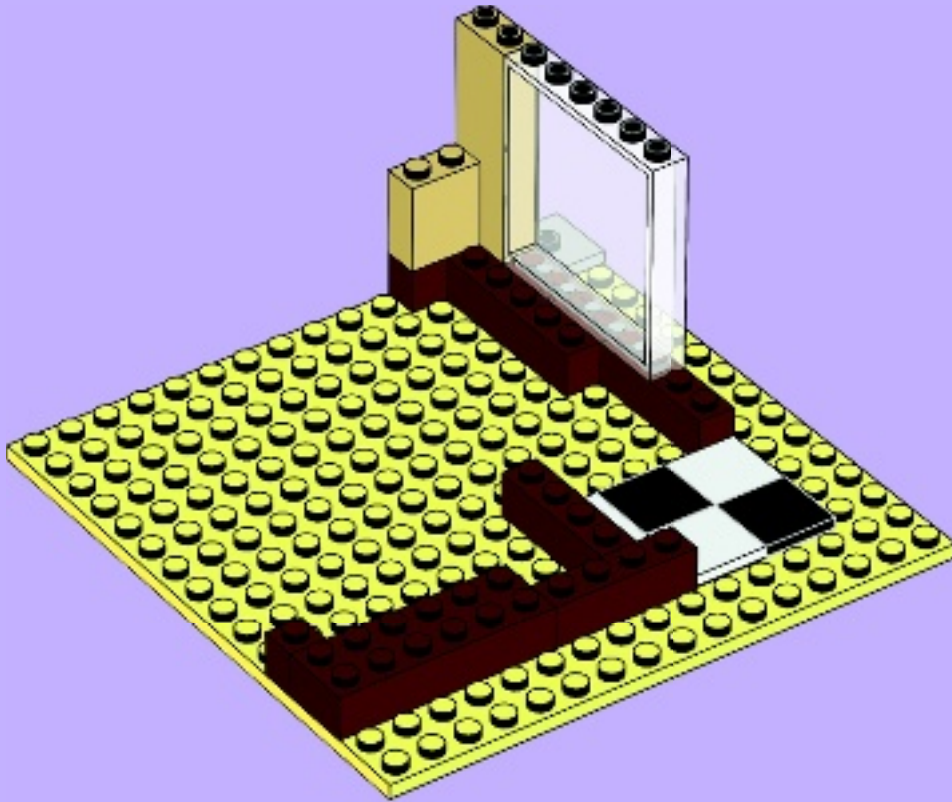

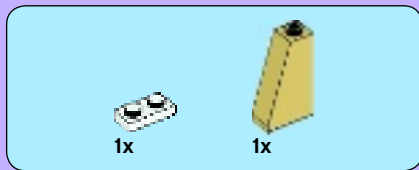

7

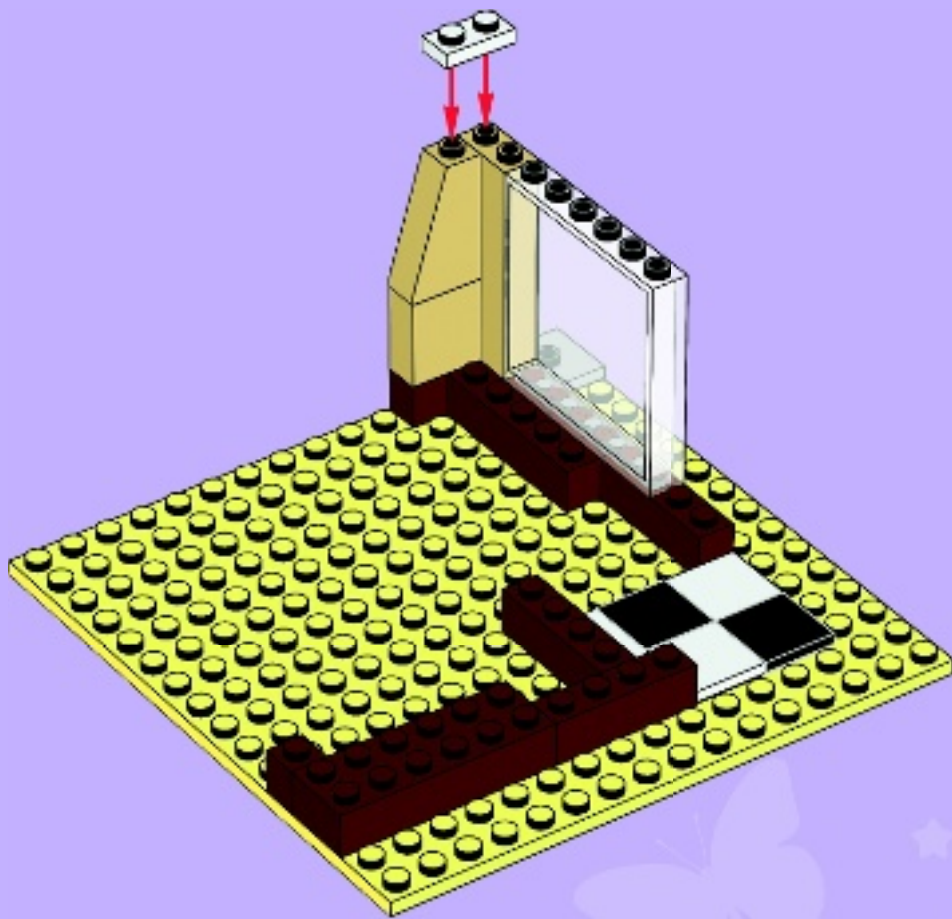

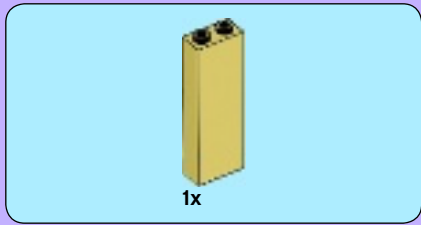

8

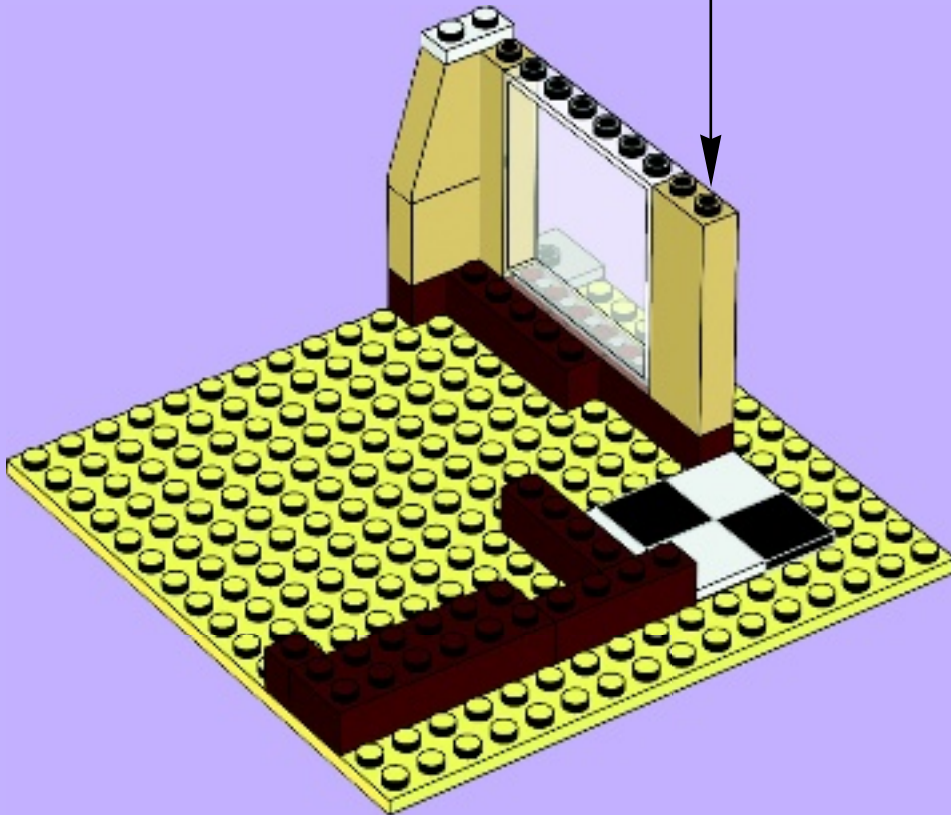
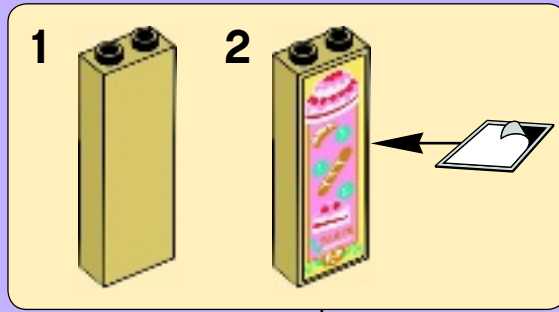

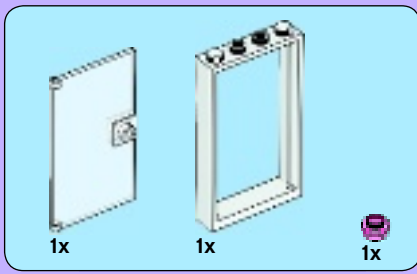

9

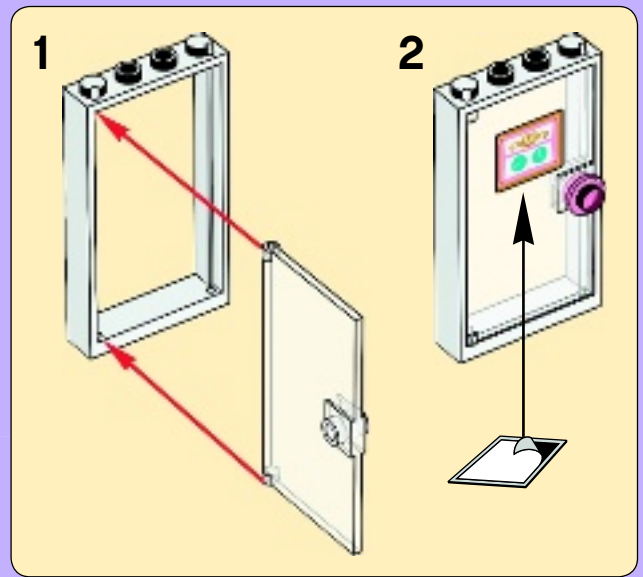
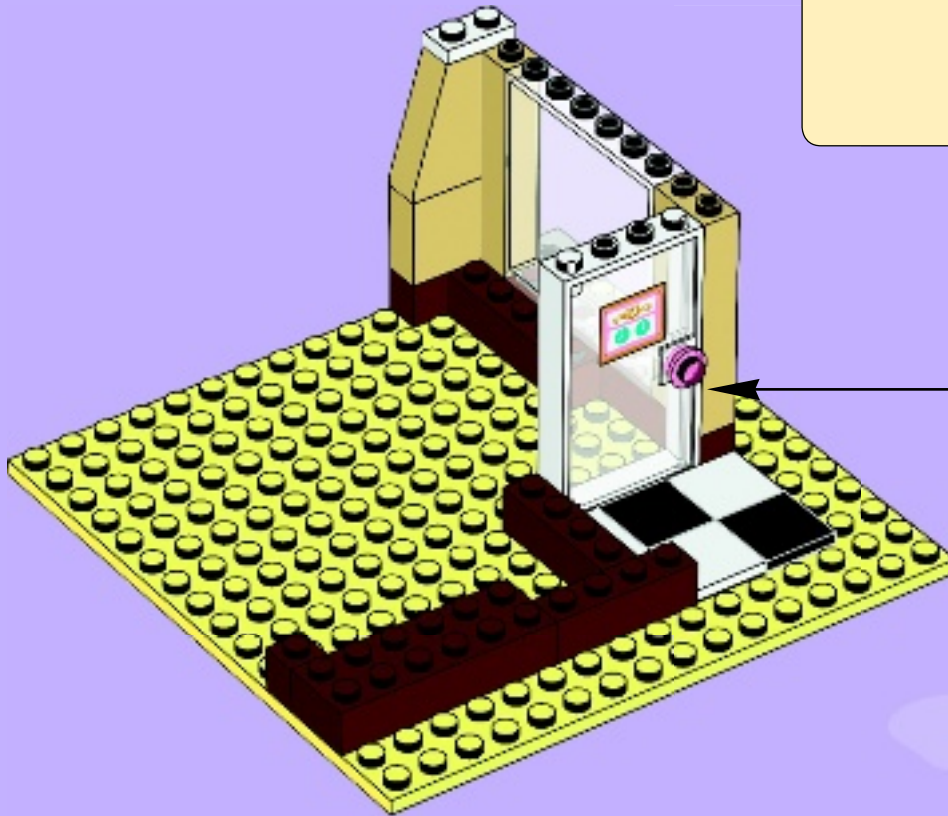



10

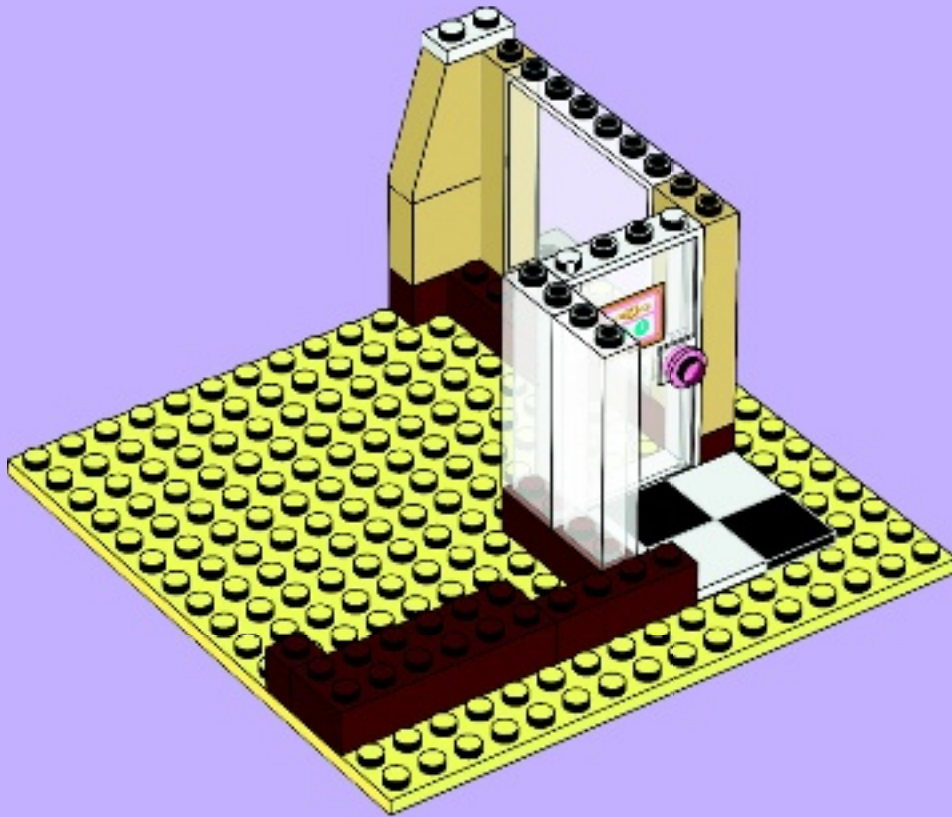



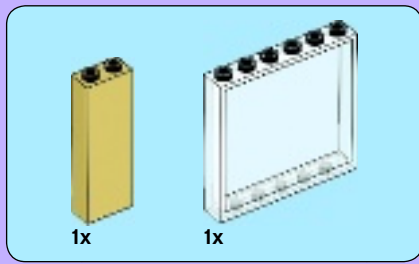

# 11

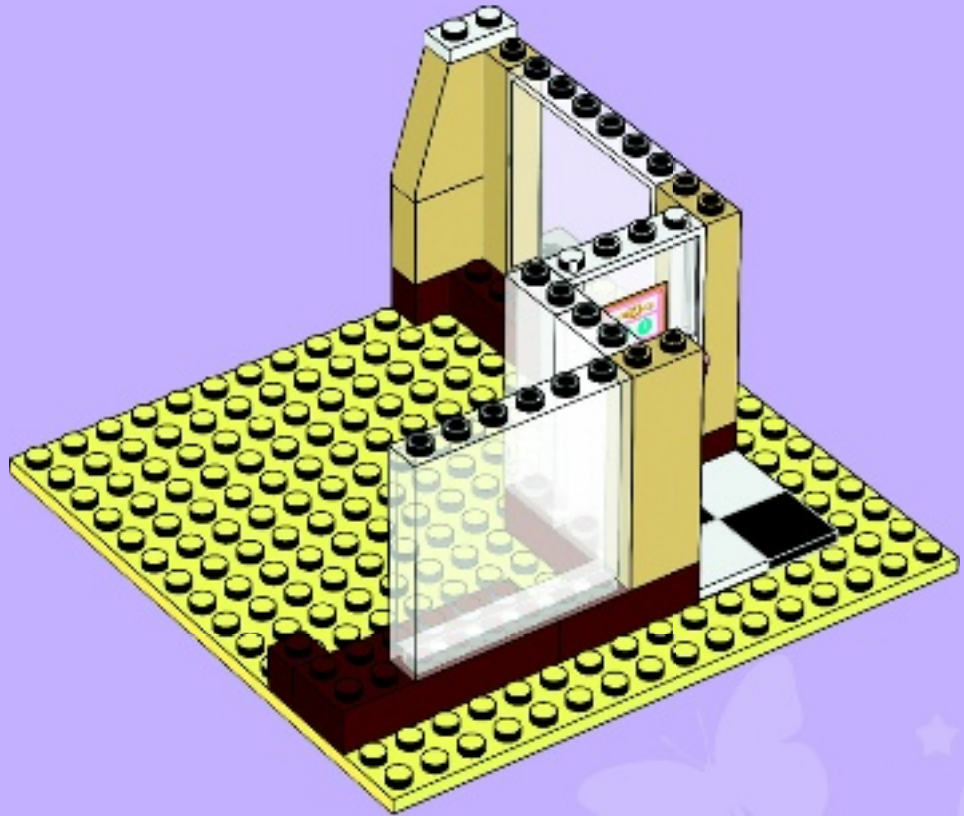

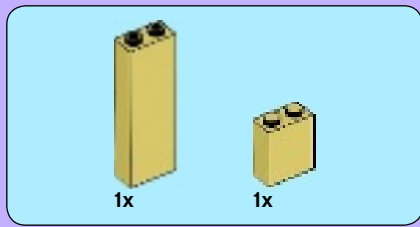

12

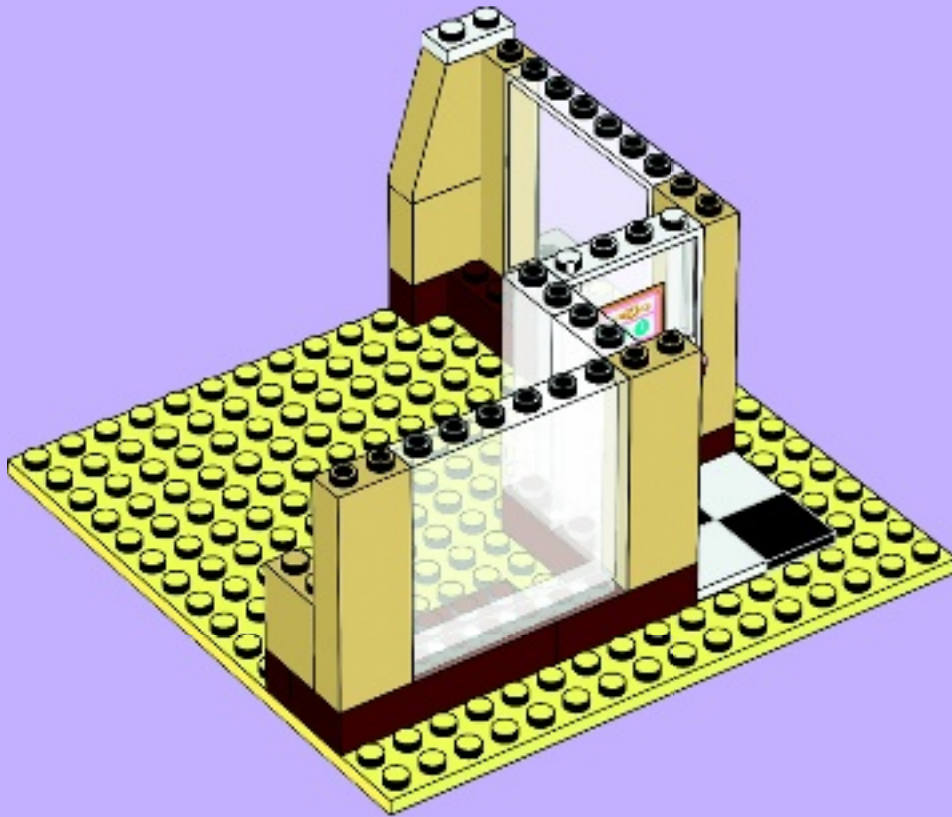

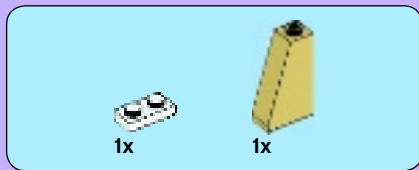

# 13

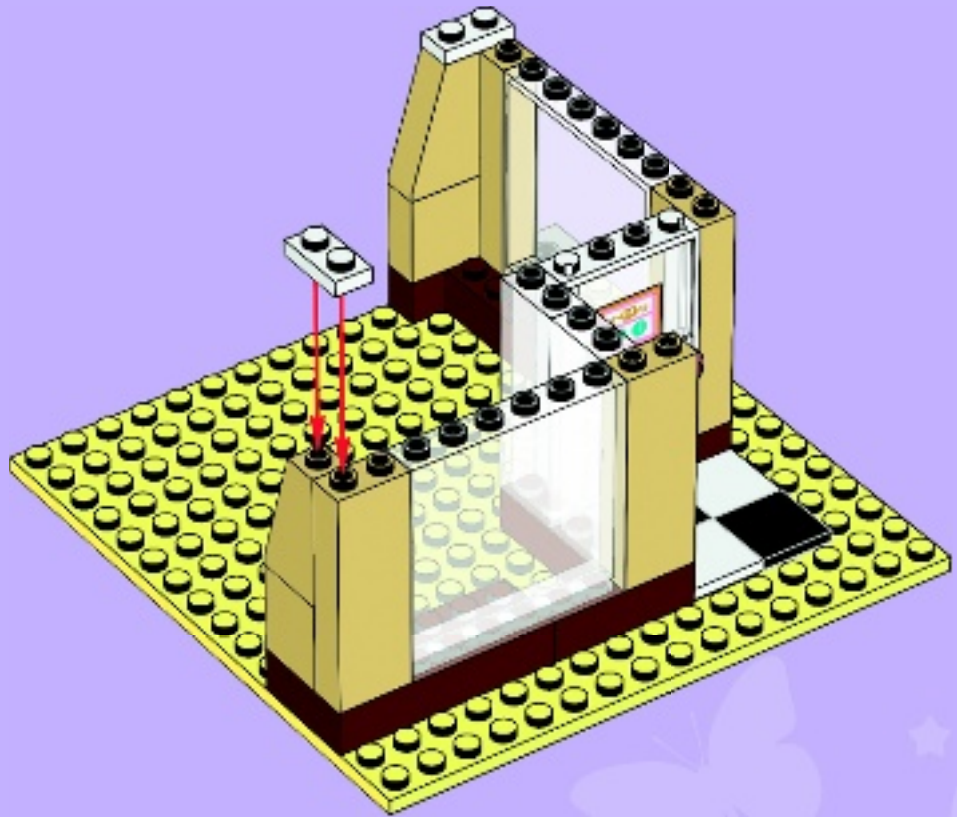

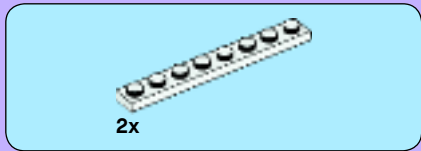

14

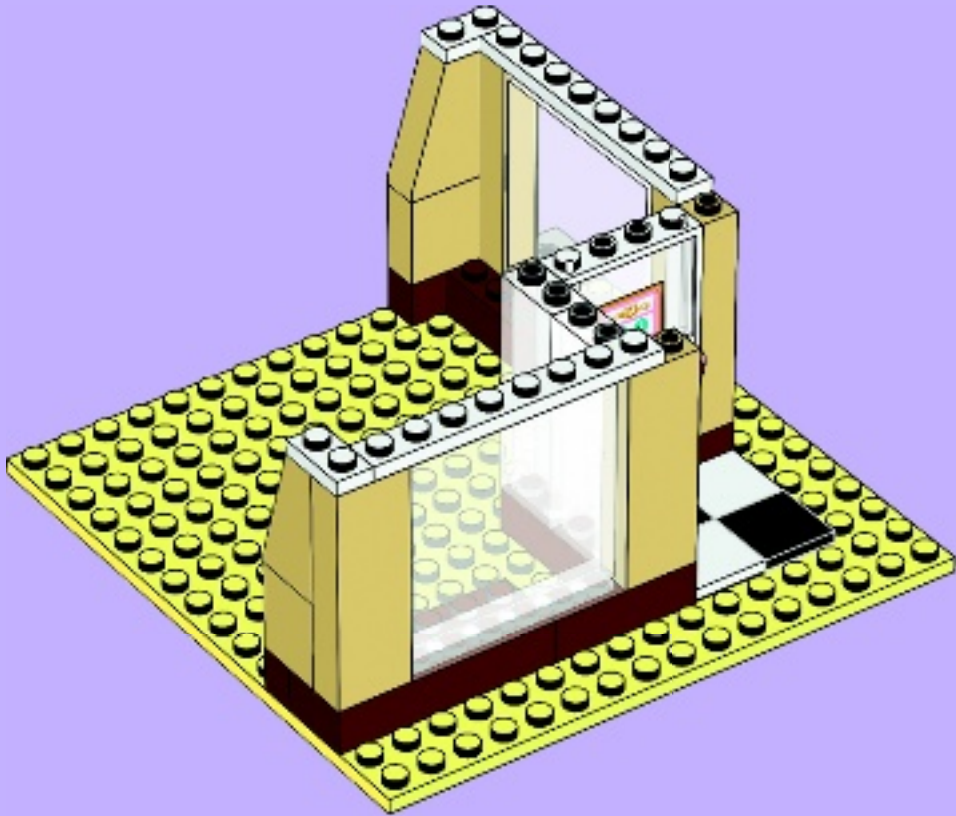

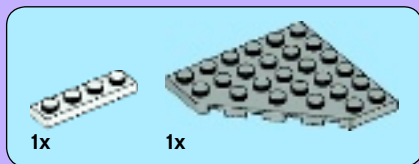

15

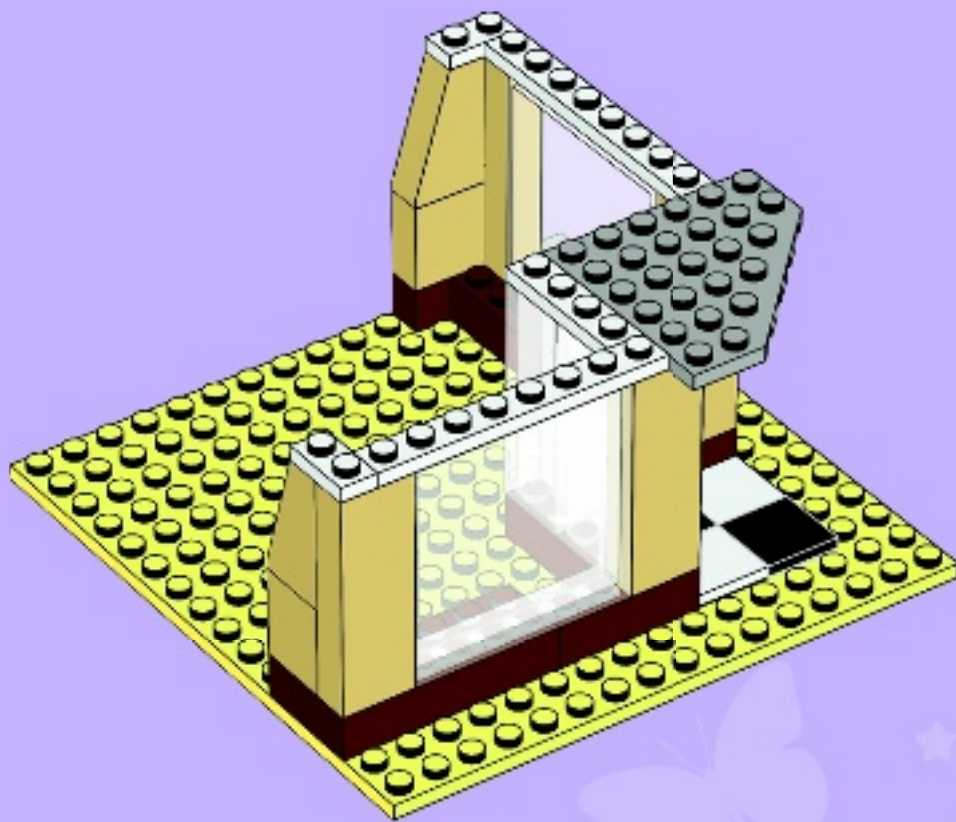





2x

17

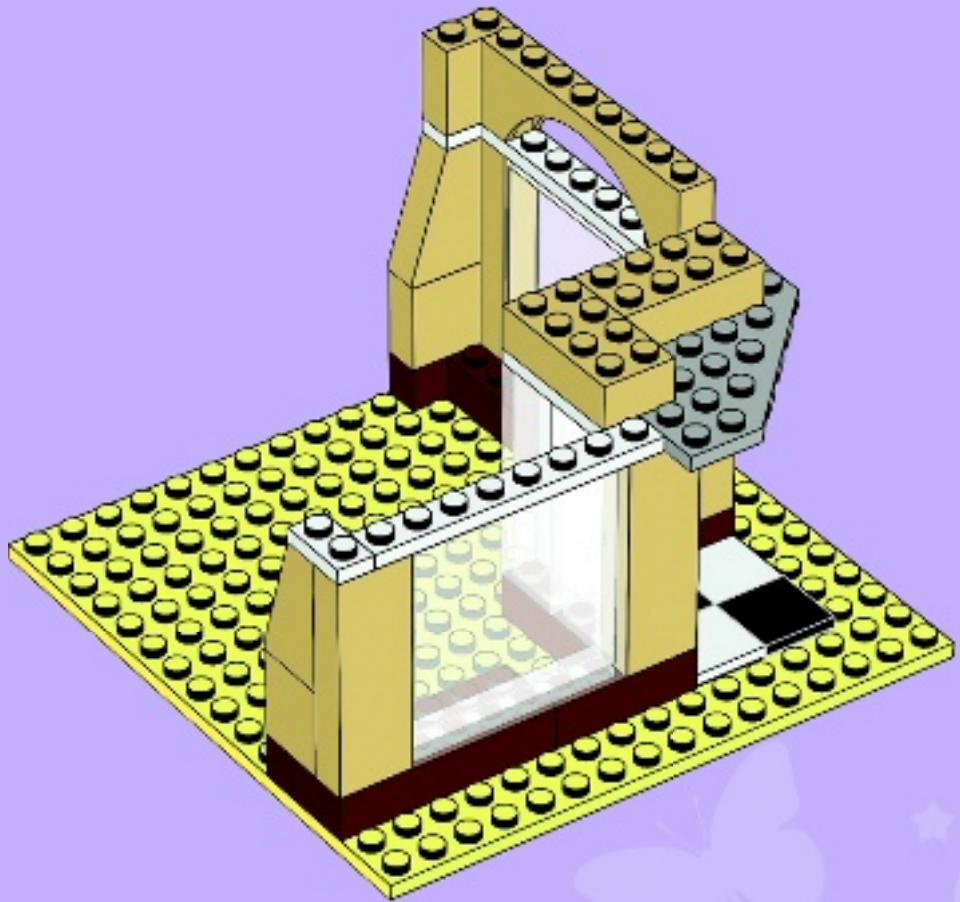



1x



1x

# 18

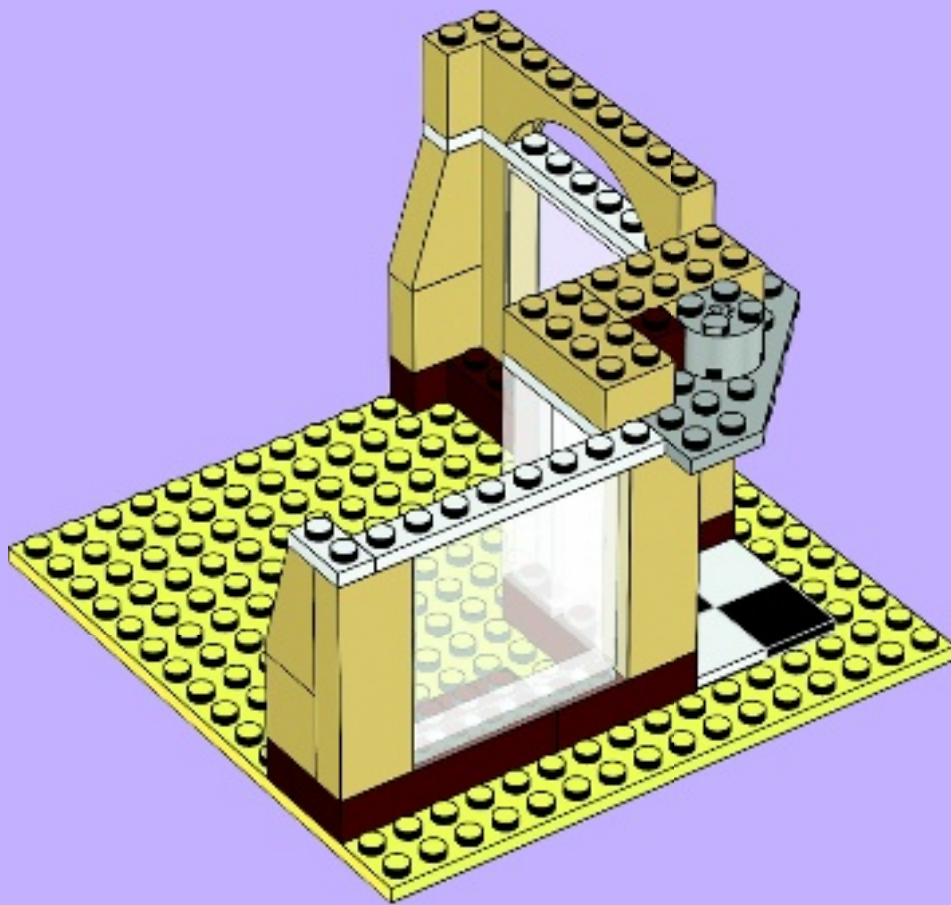



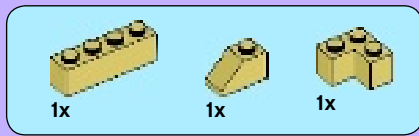

# 19

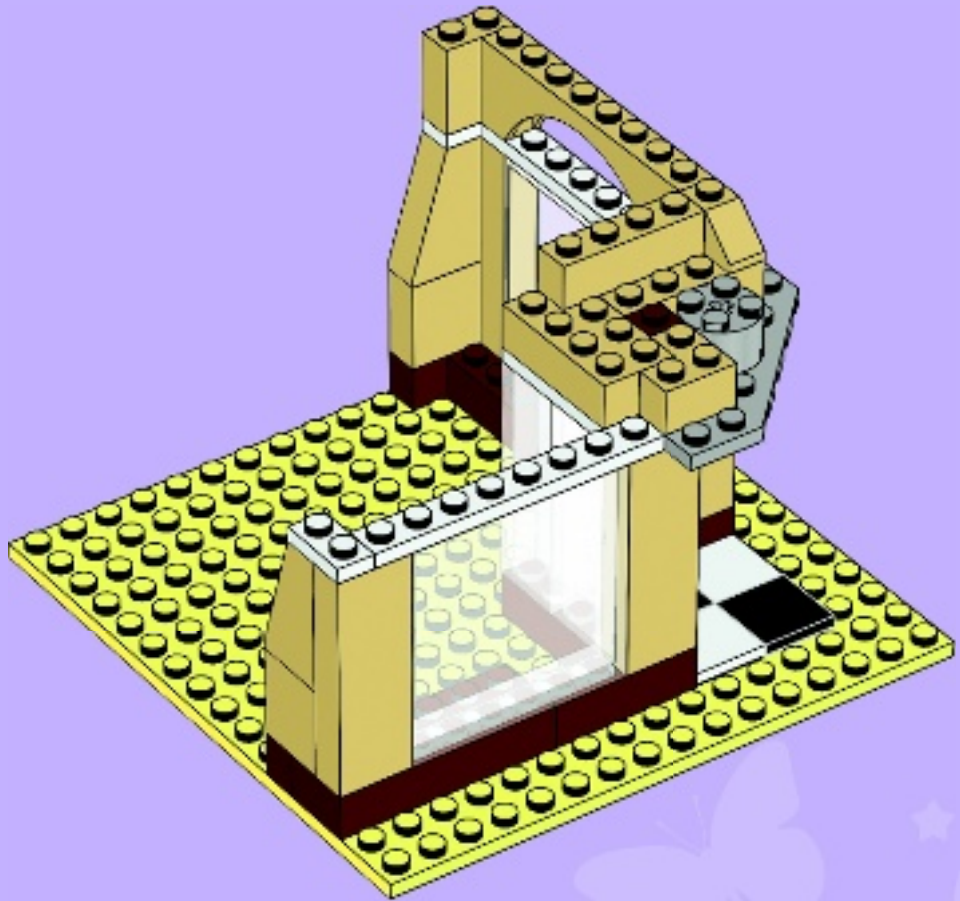

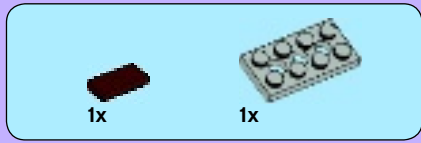

20

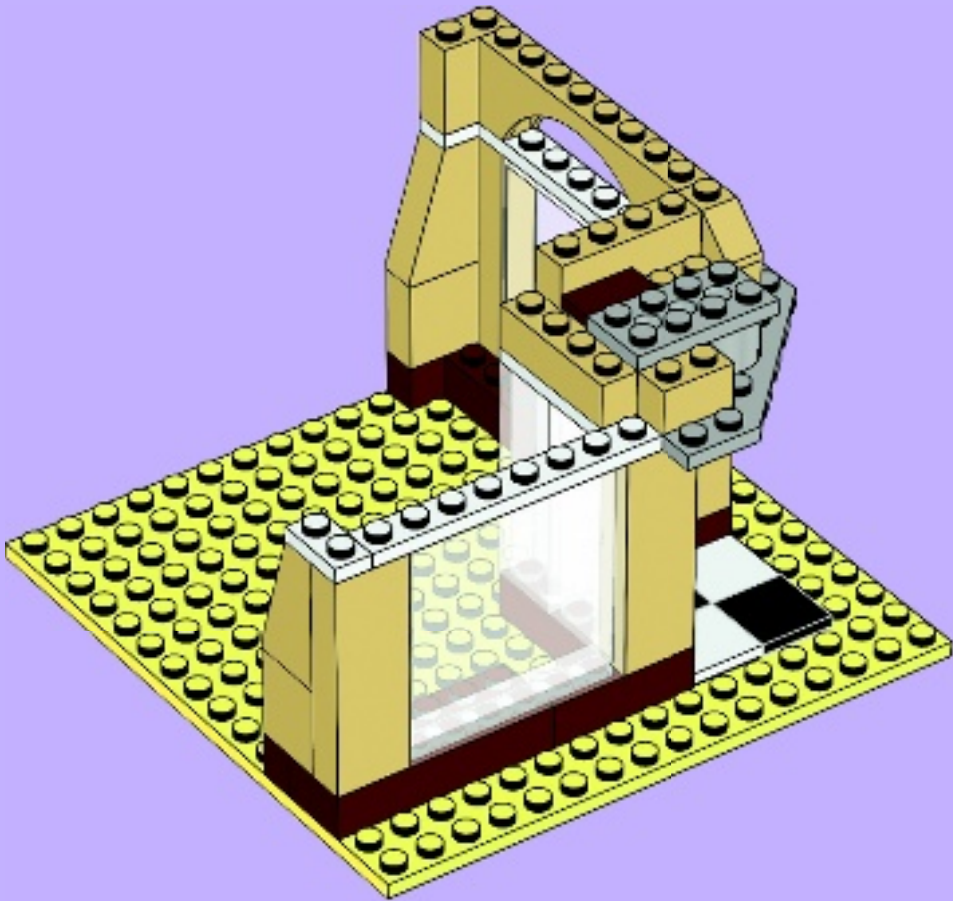

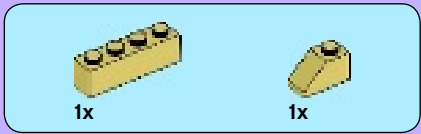

21

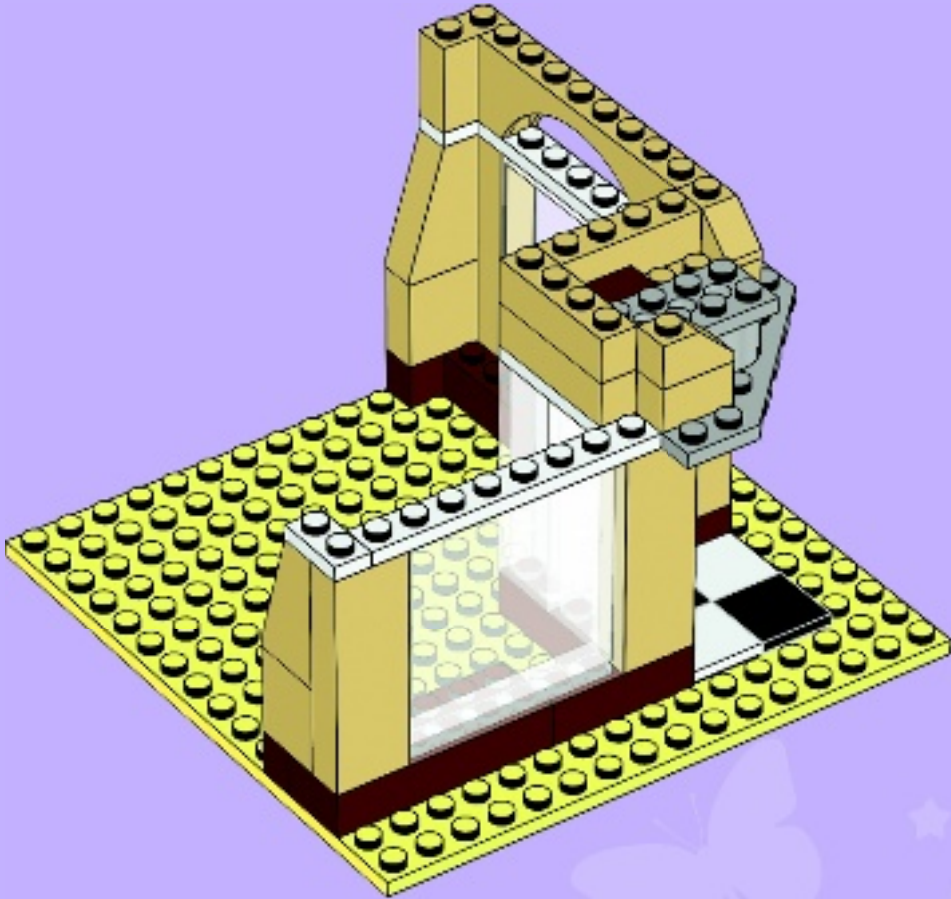

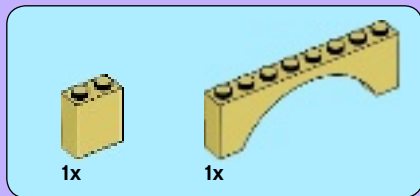

22

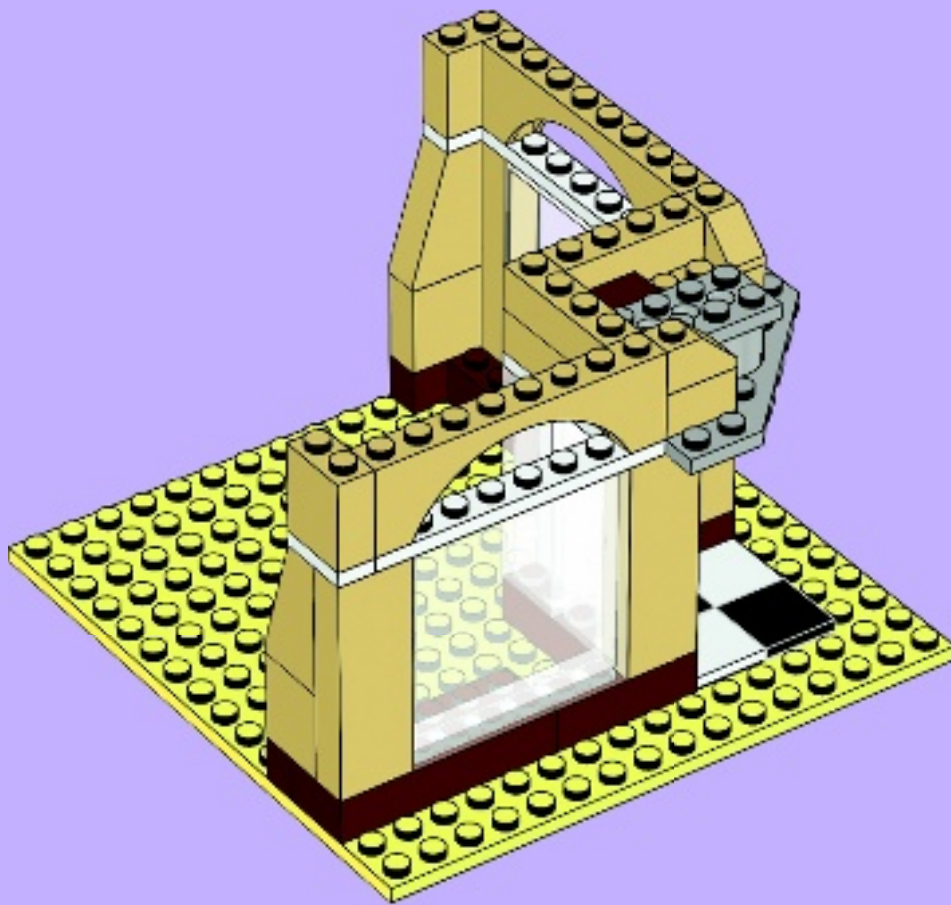



2x



2x

# 23

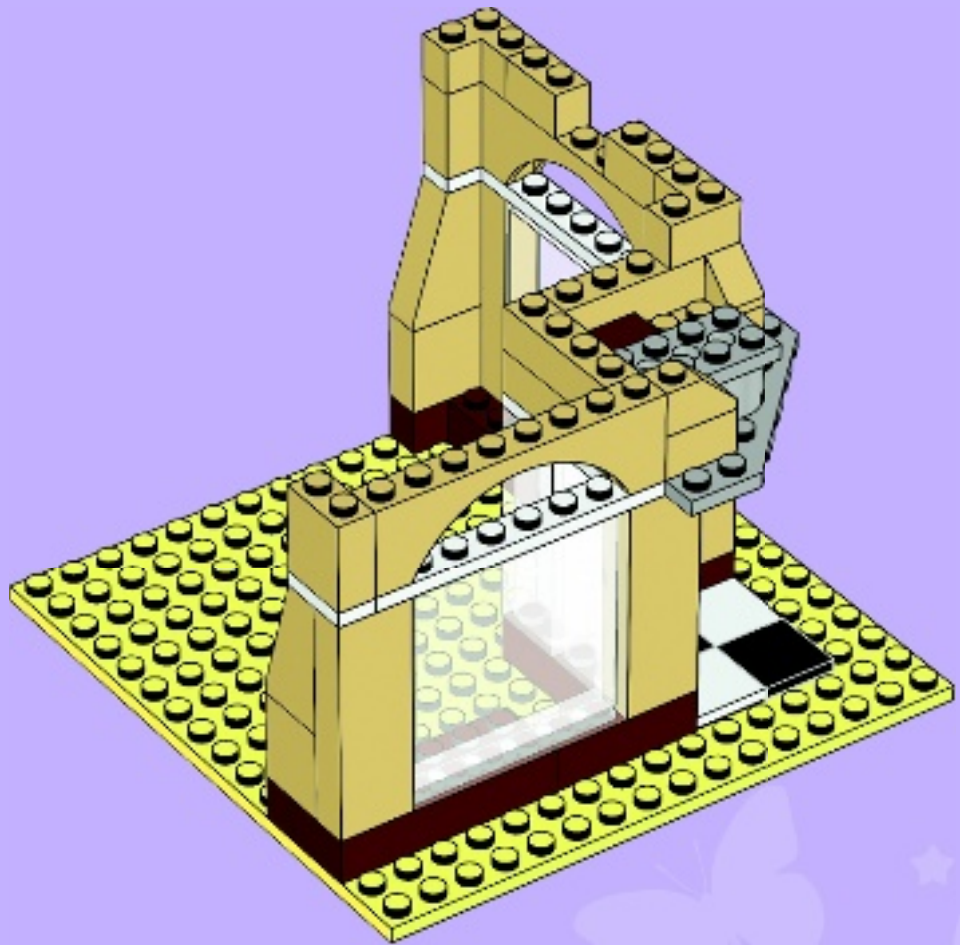



24

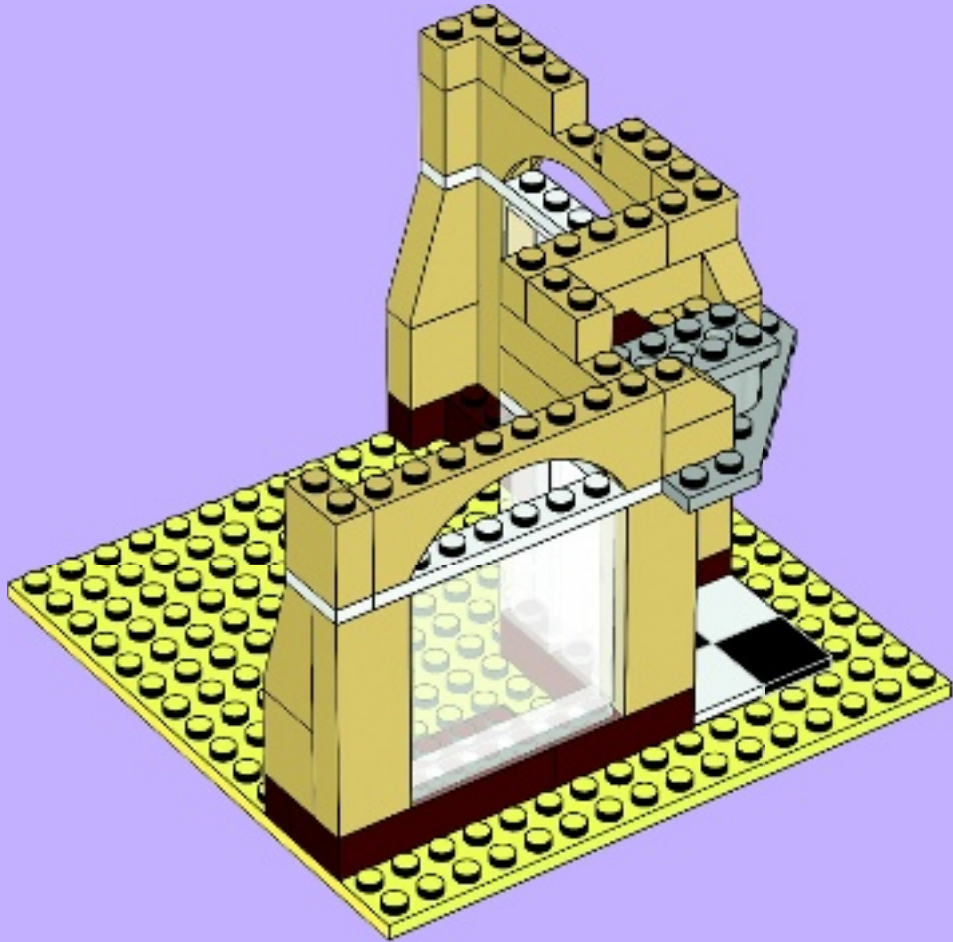



2x



2x

# 25

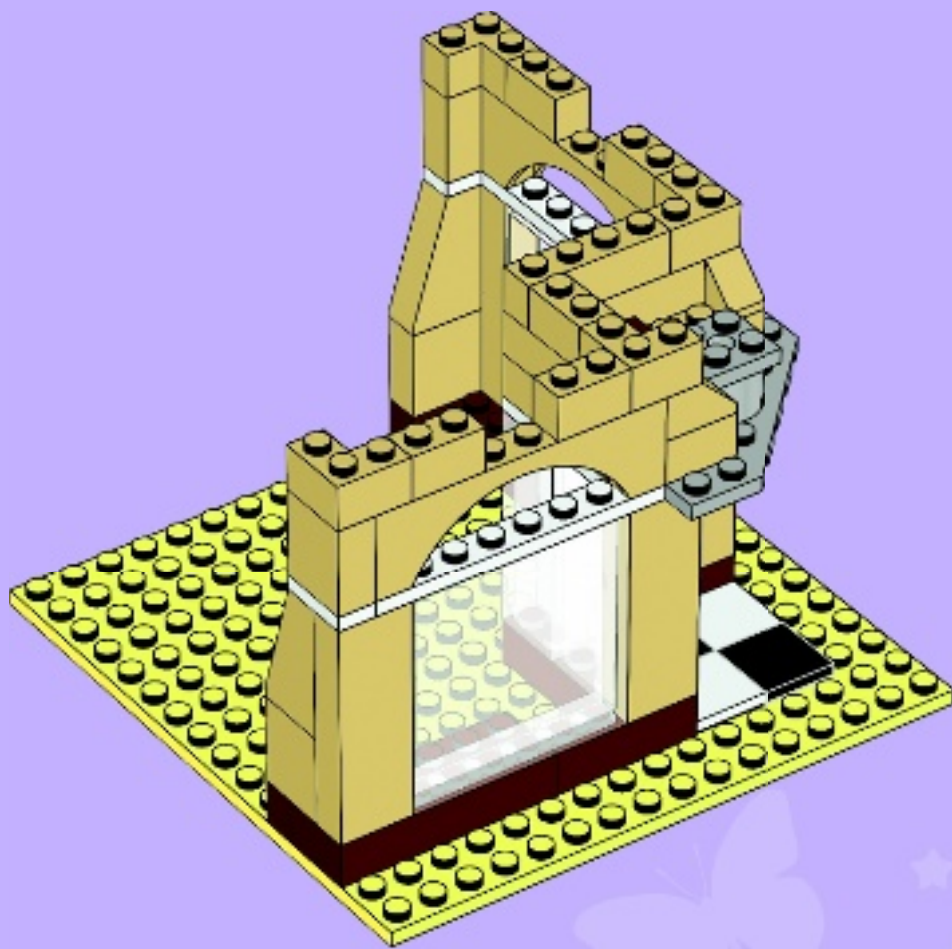



# 26

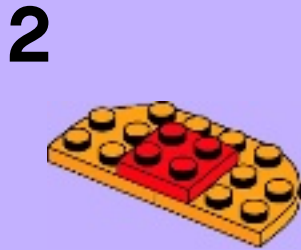
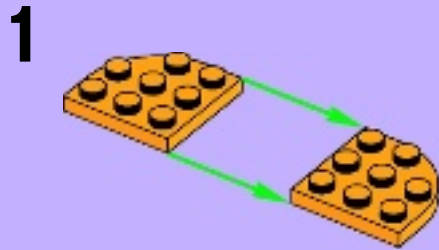



4

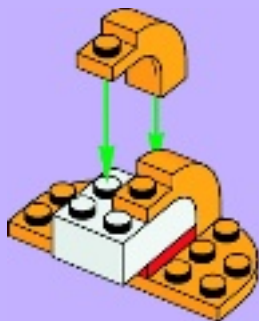

5

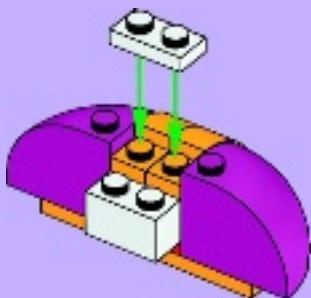

6

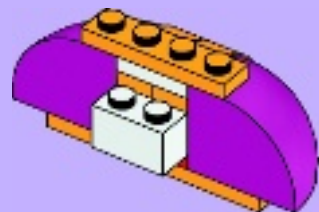

2x



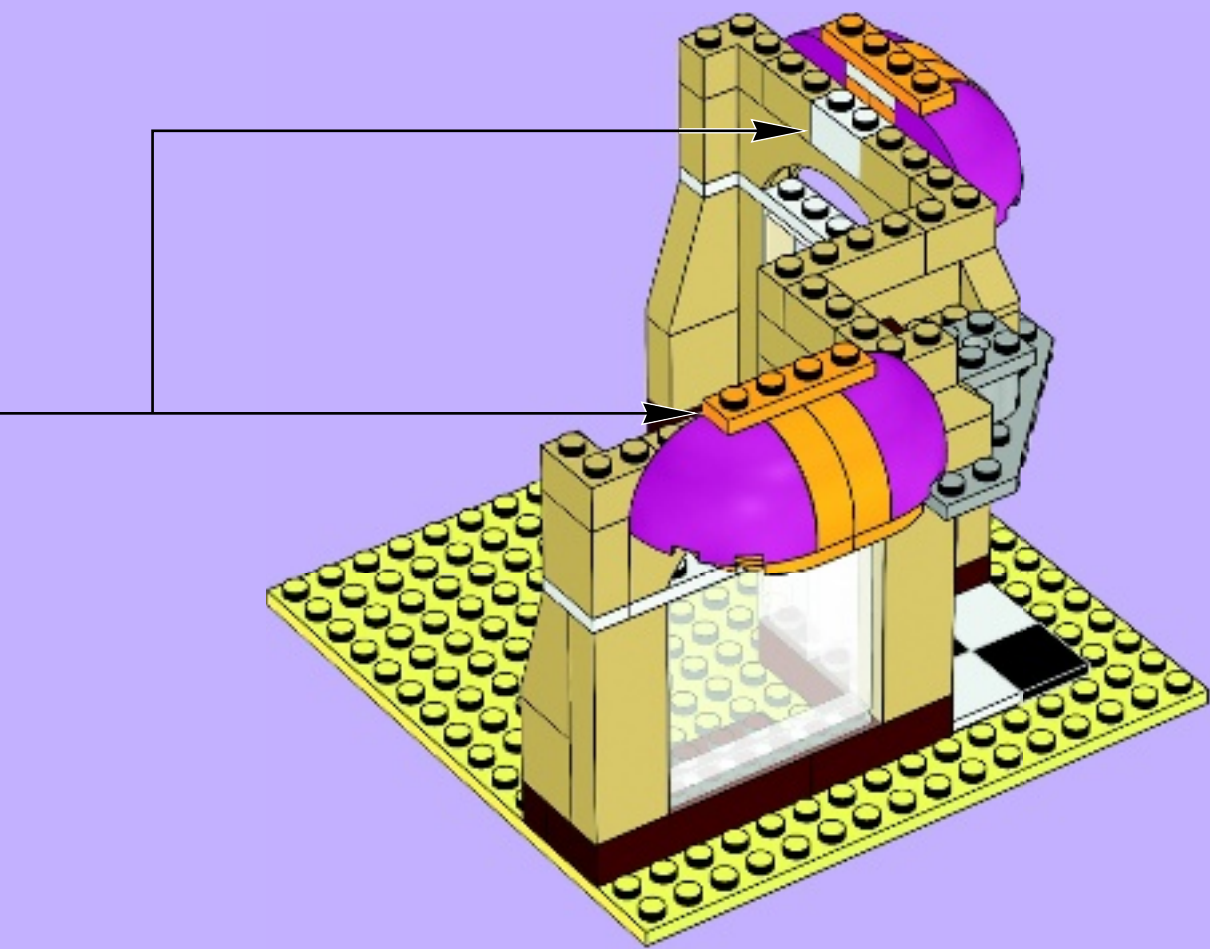

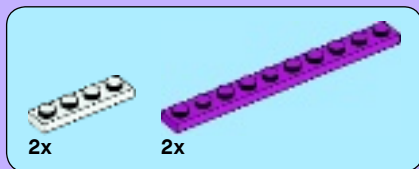

27

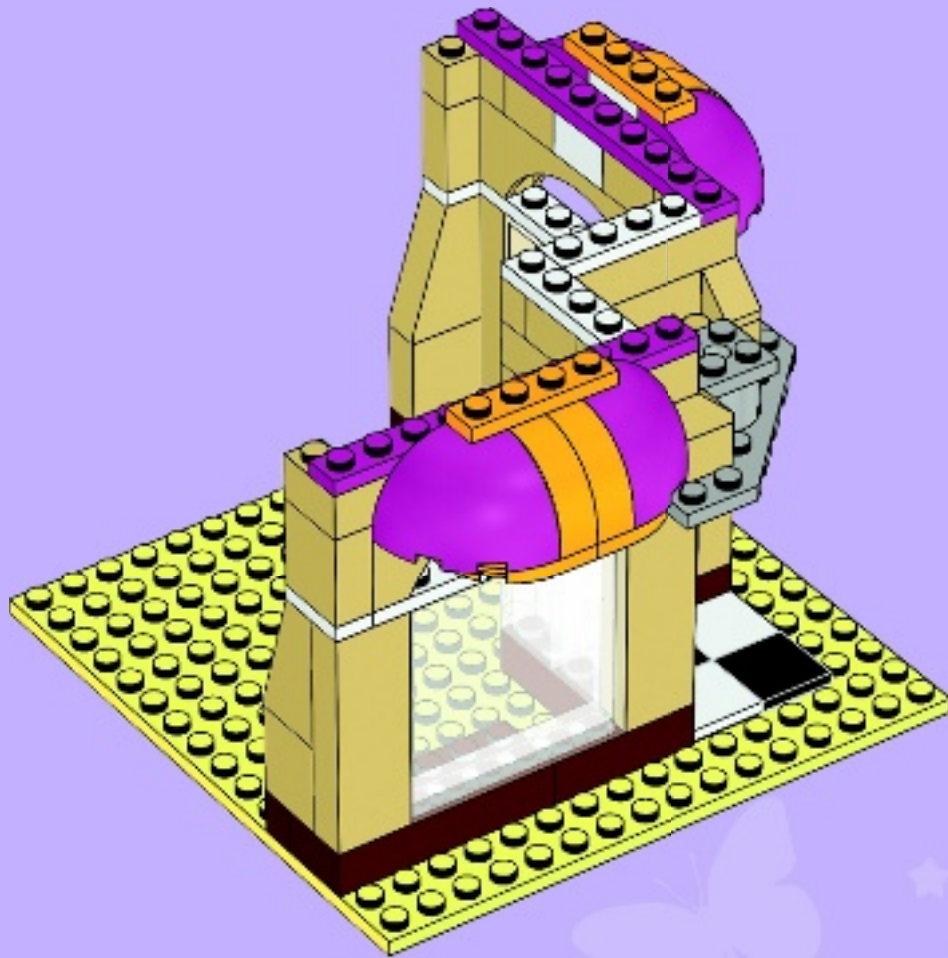

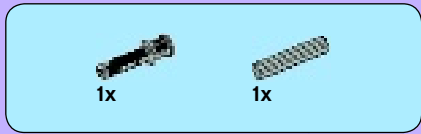

28

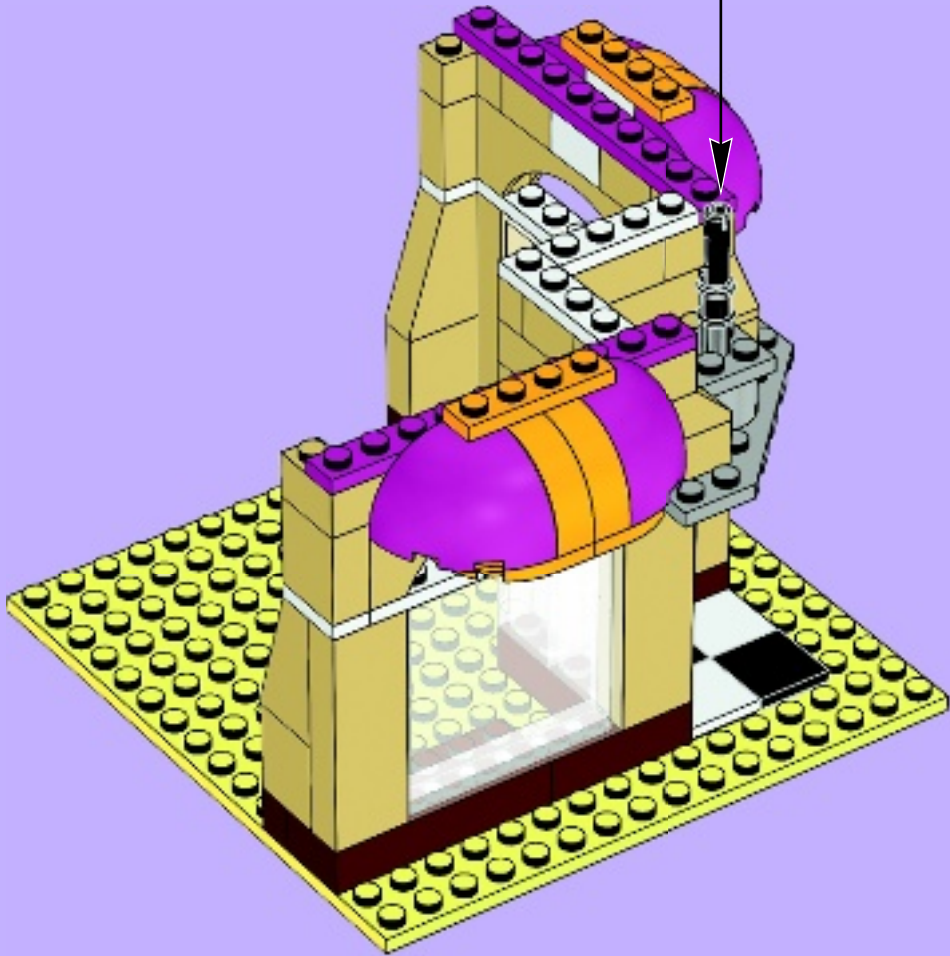
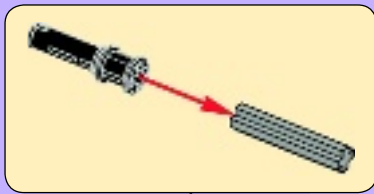

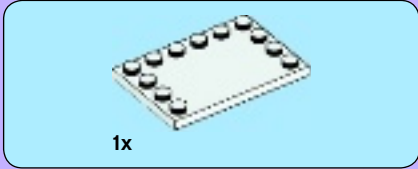

1

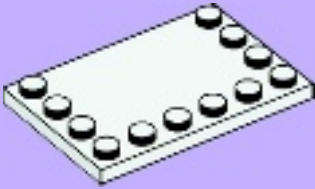

2

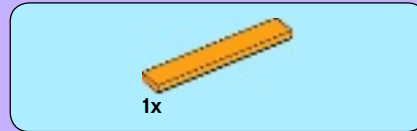
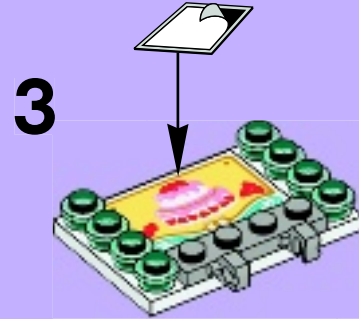

4







6

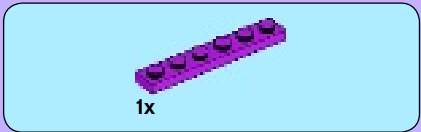

7

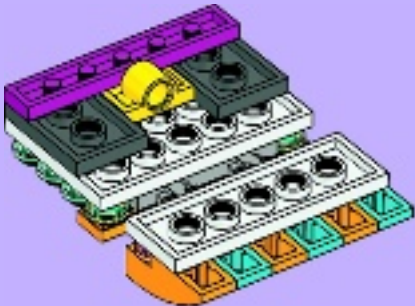

8

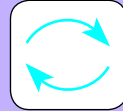

29

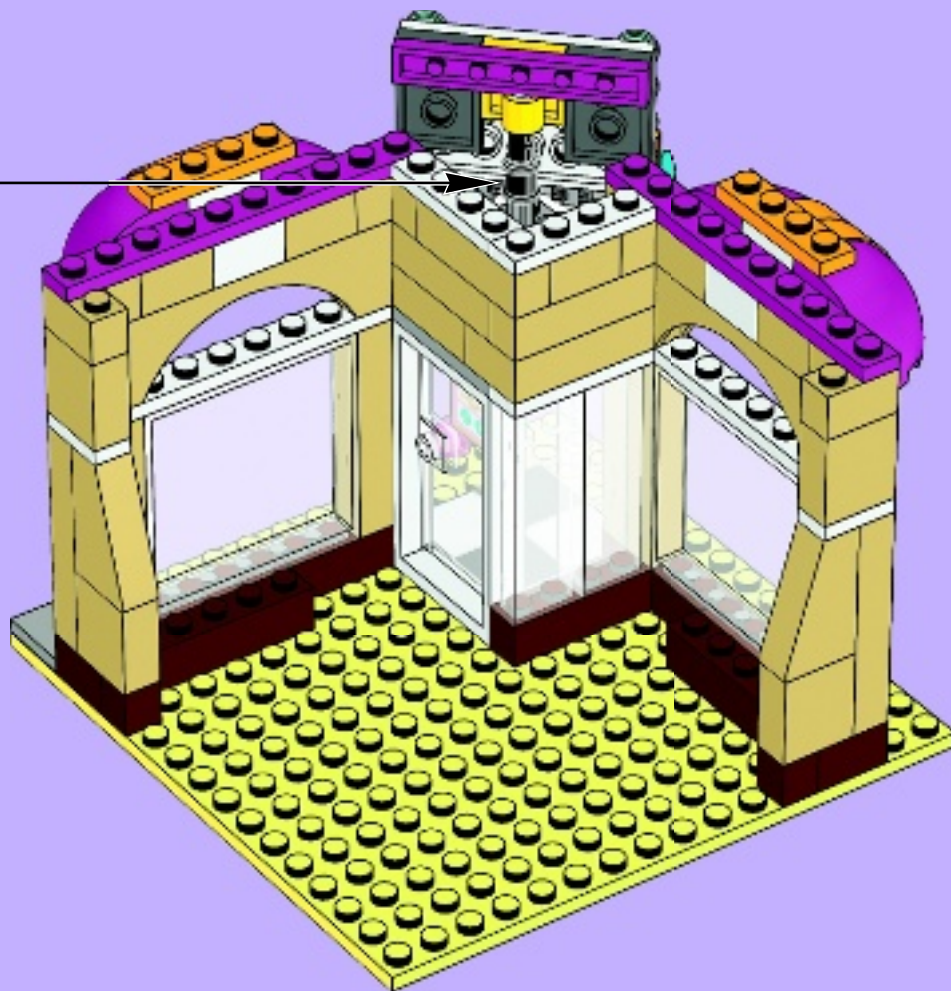
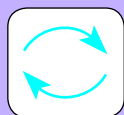





30

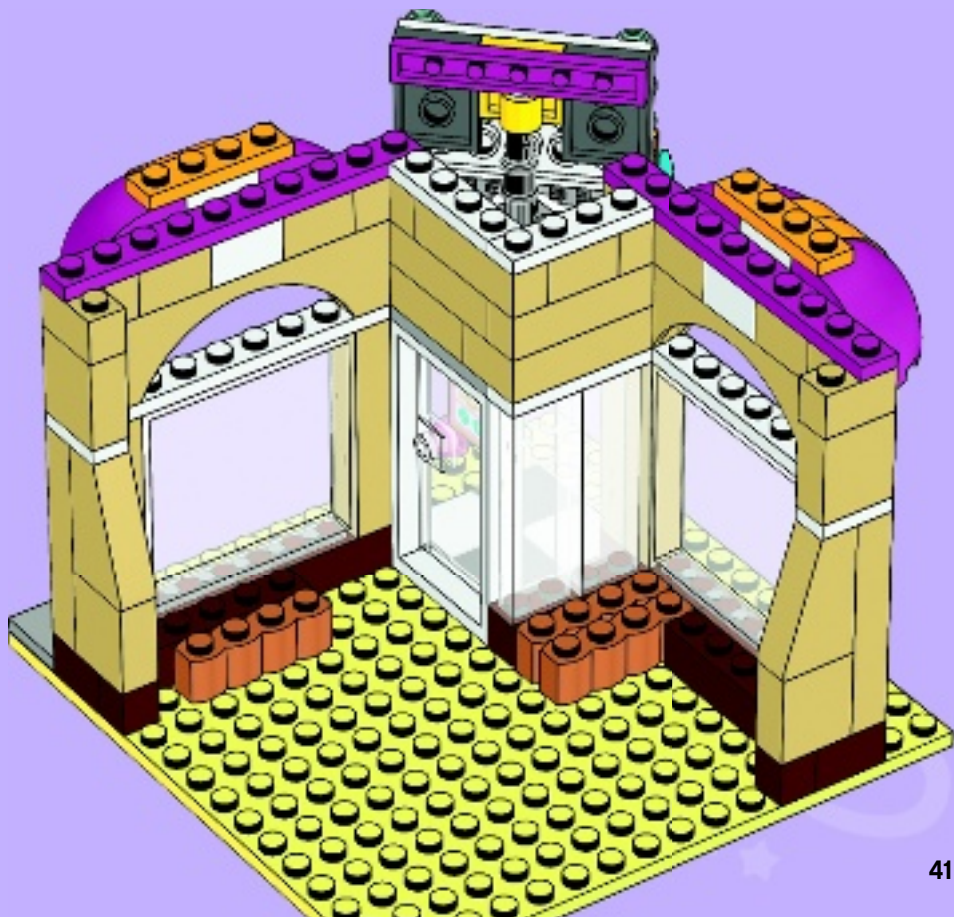



2x

# 31

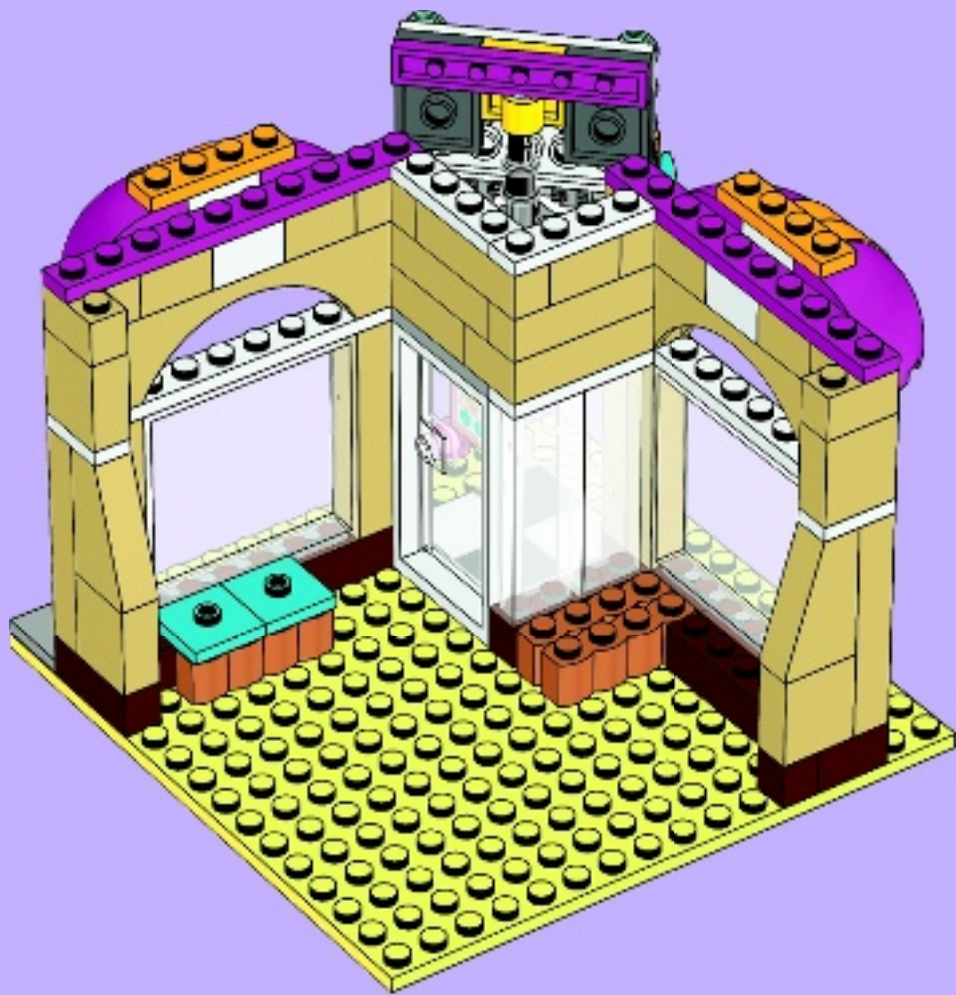



32





1x



1x

# 33

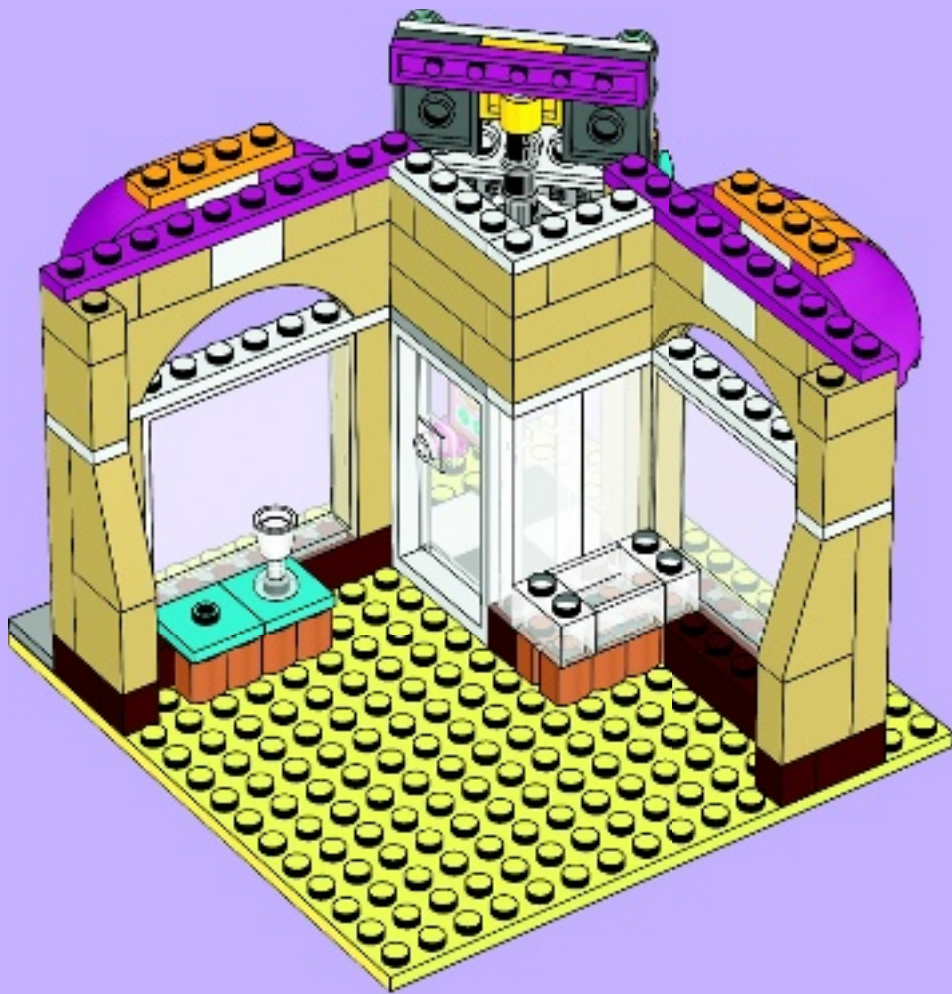



2x

34





1x



2x

# 35

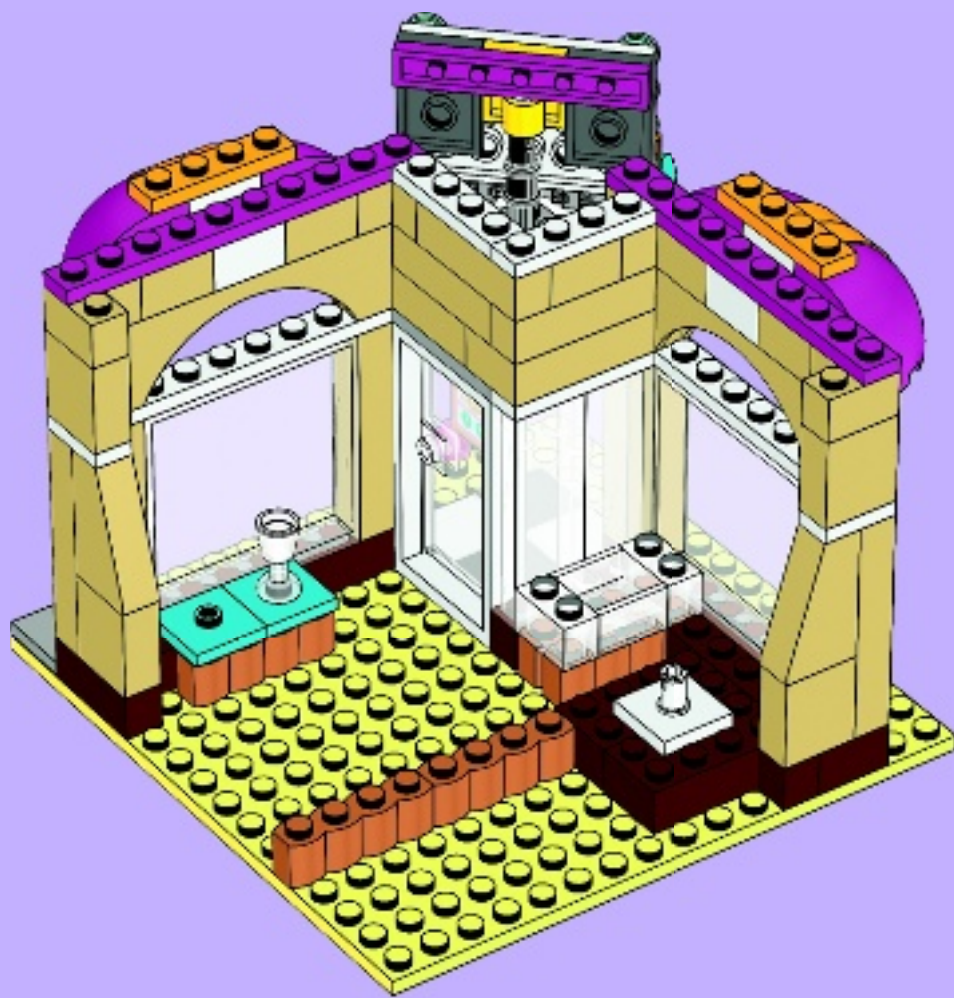



1x



1x

# 36



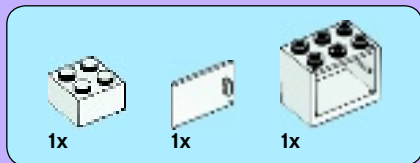

37

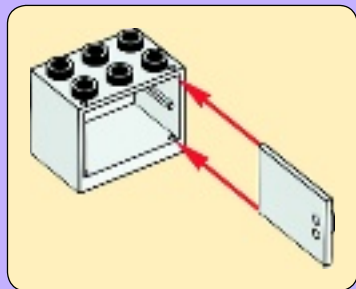
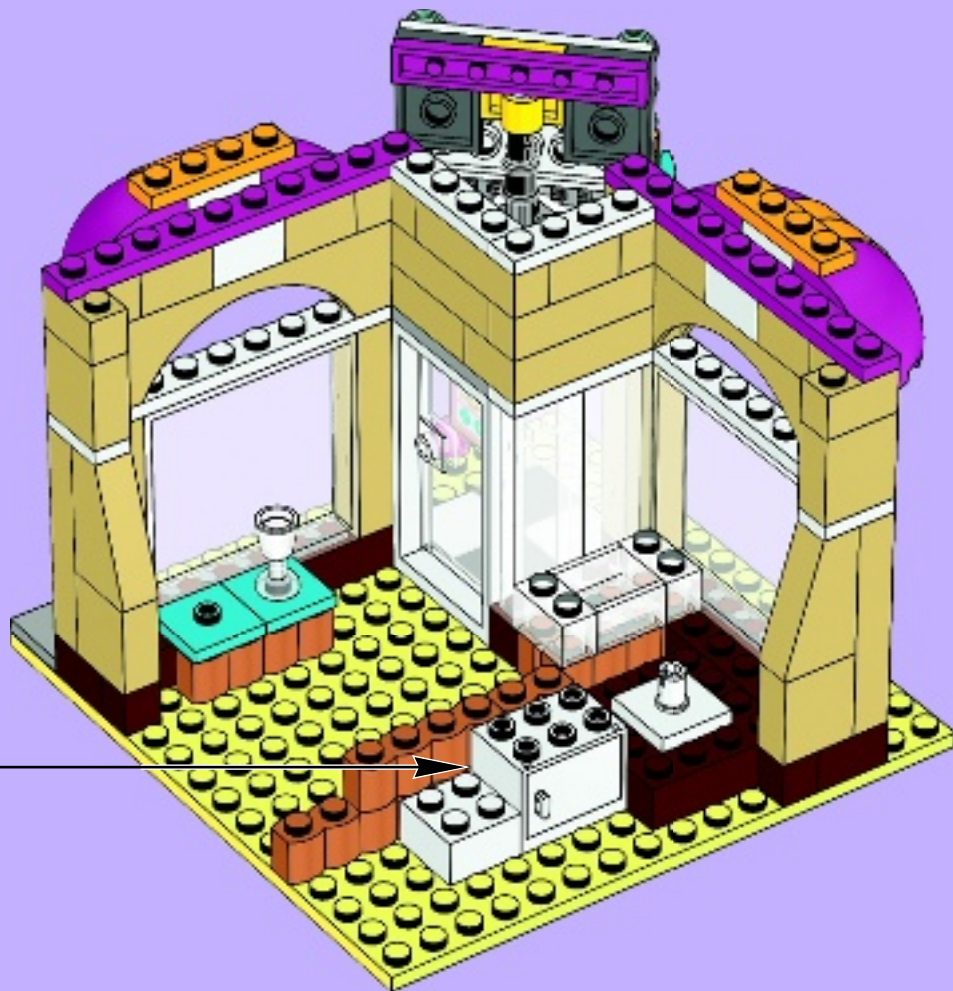





1x



1x

# 38



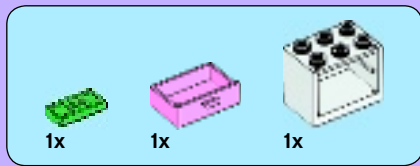

# 39

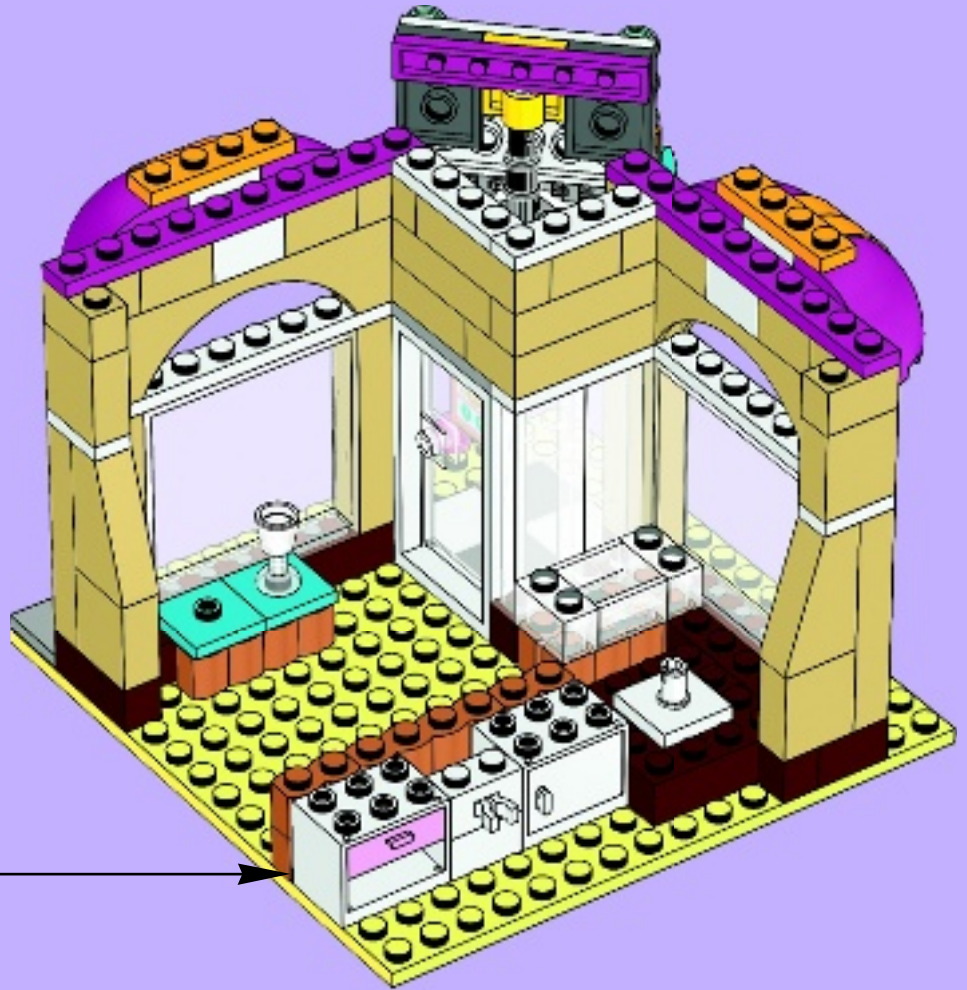
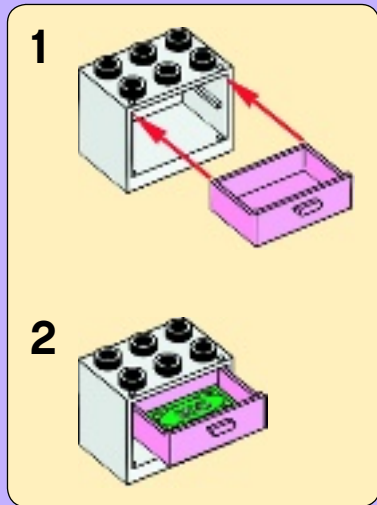



3x

# 40



1x



1x

# 41

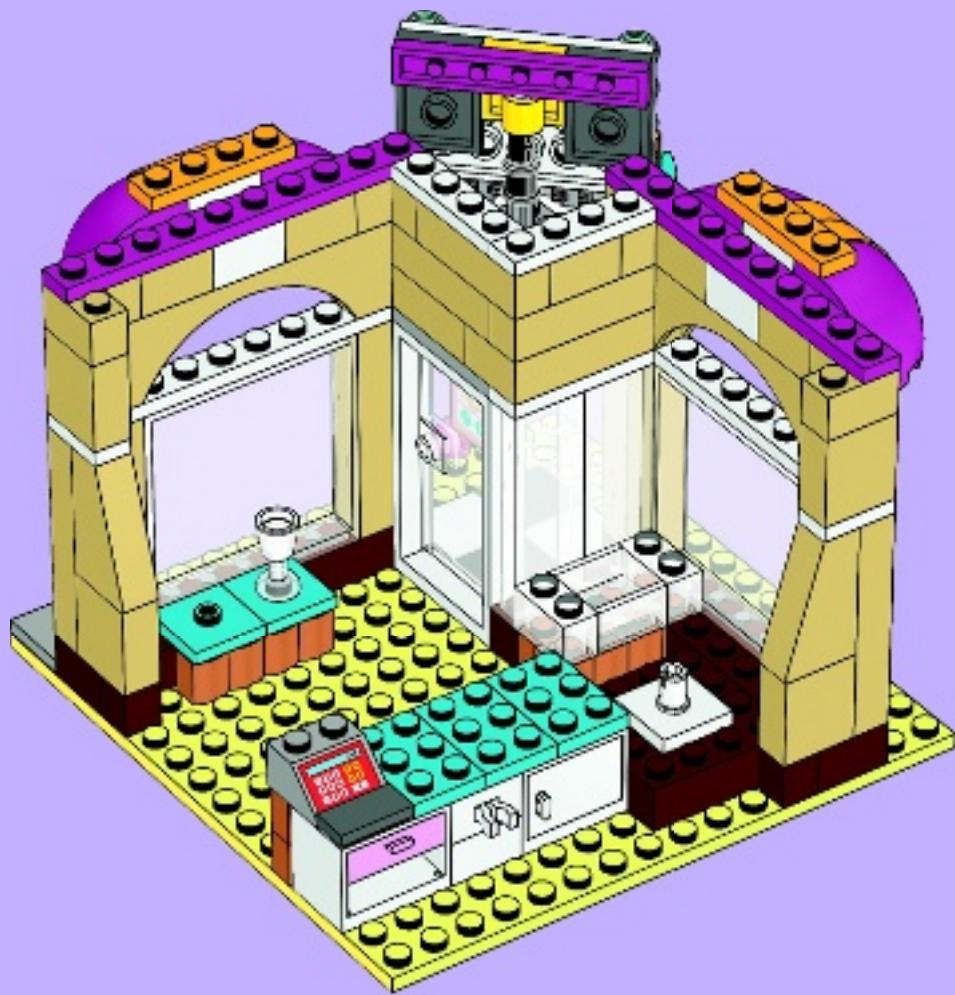







1x



1x

# 42



			
1x	4x	1x	2x

# 43

- 1 
- 2 
- 3 



2x

4x



2x



4x

# 44

1



2



3



4





1x

1



4x



4x

2



4x



1x

3



2x

4





45



-   
1x
-   
1x
-   
1x
-   
1x

# 46





47



2x  2x  4x 

48

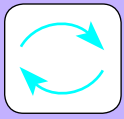

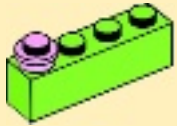
1 

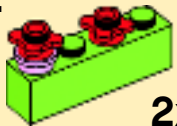
2  2x



# 49

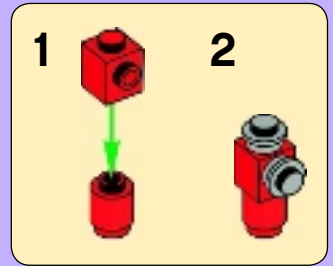



1

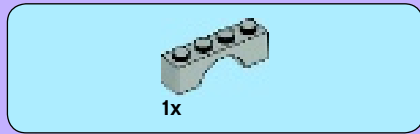

2

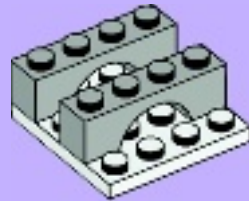

3



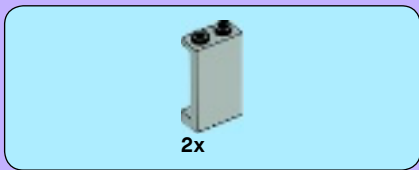

4

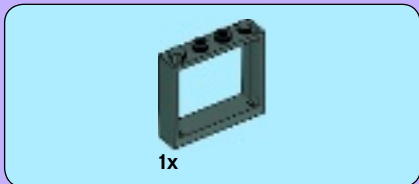

5

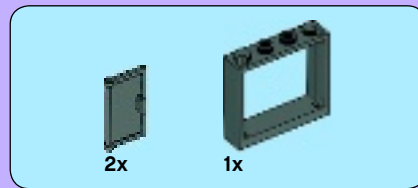

6

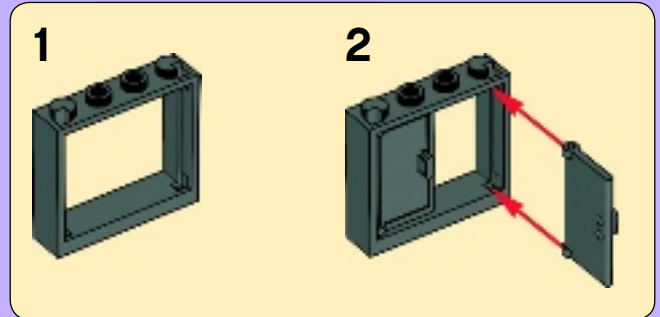



2x

7



2x



2x

8







1x



1x



1x

# 50





**Andrea**



**Mia**



**Stephanie**



**Friends**



**Emma**



**Olivia**



■ 41005



■ 41006



■ 41009



■ 41010



■ 41013



■ 41015



Friends



Friends



41006



41013



41010



# Heartlake City





41009



41005



41015





6x  
614101



1x  
459901



1x  
300301



1x  
4117061



1x  
4650644



1x  
4261470



1x  
246001



2x  
306801



1x  
4558168



4x  
302301



3x  
371001



2x  
621501



2x  
4619665



1x  
4558956



1x  
4541956



1x  
4243812



1x  
4163986



3x  
379501



2x  
346001



4x  
6022046



4x  
4654105



2x  
6040150



2x  
4625630



5x  
4566522



1x  
4558886



1x  
306221



2x  
302221



6x  
6035617



1x  
459921



4x  
6035590



3x  
6022064



2x  
6020073



1x  
4654129



4x  
6022078



1x  
6037810



1x  
4295260



1x  
3006841



8x  
4646864



3x  
4211242



2x  
4211151



2x  
4211159



1x  
4520638



3x  
4211225



2x  
4211201



2x  
4216615



2x  
4234716



2x  
6035618



1x  
4273743



1x  
4211815



1x  
4211520



1x  
4211444



1x  
4211840



2x  
4211435



2x  
4585429



1x  
4211526



1x  
4622060



1x  
4565393



2x  
4515341



2x  
4211525



2x  
4211525

2x  
4121972

2x  
4129996

1x  
4140562

7x  
4109995

4x  
4159279

4x  
4114064

5x  
4124455

2x  
4596319

3x  
4113916

2x  
4114319

1x  
4621315

2x  
4211090

2x  
4521386

1x  
4211052

4x  
4211043

2x  
4551044

1x  
4567338

4x  
4222960

1x  
6019089

3x  
4599535

1x  
6033935

1x  
6035620

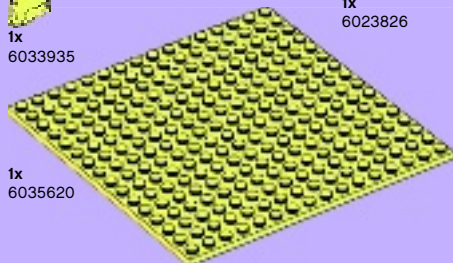

1x  
244424

8x  
4163917

5x  
4651231

6x  
4651232

1x  
6006758

1x  
4622738

2x  
4619520

3x  
6035598

4x  
6003008

5x  
4619513

1x  
4649736

1x  
6023826

2x  
4645394

1x  
4542700

2x  
4504229

1x  
3000240

2x  
306540

2x  
4624313

7x  
4113106

1x  
4521504

2x  
306826

1x  
6023004

1x  
4140801

1x  
4654128

1x  
4654127

7x  
4517996

1x  
4599534

1x  
6043921

1x  
6017024

1x  
6049711

1x  
6049749

Customer Service

Kundenservice

Service Consommateurs

Servicio Al Consumidor

LEGO.com/service or dial

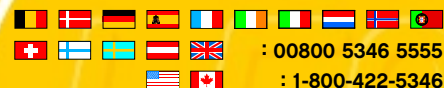

: 00800 5346 5555

: 1-800-422-5346



# Win!

Go to [www.LEGOsurvey.com/product](http://www.LEGOsurvey.com/product) to fill out a survey for a chance to win a cool LEGO® Product.

No purchase necessary. Open to all residents where not prohibited.



## [www.LEGOsurvey.com/product](http://www.LEGOsurvey.com/product)

### Gewinne!

Nimm an der Umfrage auf [www.LEGOsurvey.com/product](http://www.LEGOsurvey.com/product) teil und hab die Chance ein cooles LEGO® Produkt zu gewinnen!  
Die Teilnahme am Gewinnspiel führt zu keinerlei Kaufverpflichtungen. Teilnahme in allen nicht ausgeschlossenen Ländern möglich.

### Win!

Ga naar [www.LEGOsurvey.com/product](http://www.LEGOsurvey.com/product), vul een enquêteformulier in en maak kans op een cool LEGO® product.  
Geen aankoopverplichting. Iedereen mag deelnemen, uitgezonderd ingezetenden van landen waar een enquêteverbod geldt.

### Gagne!

Visite [www.LEGOsurvey.com/product](http://www.LEGOsurvey.com/product) pour répondre à un questionnaire et avoir une chance de gagner un produit LEGO® très cool!  
Aucune obligation d'achat. Ouvert à tous les résidents des pays autorisés.

### 当てよう!

[www.LEGOsurvey.com/product](http://www.LEGOsurvey.com/product) にアクセスして、アンケートにご記入ください。当選者にはレゴ®製品を差し上げます。  
お買い上げの必要はありません。  
禁止されていない限り、すべての皆様にご利用いただけます。