



Friends



41026



1



2

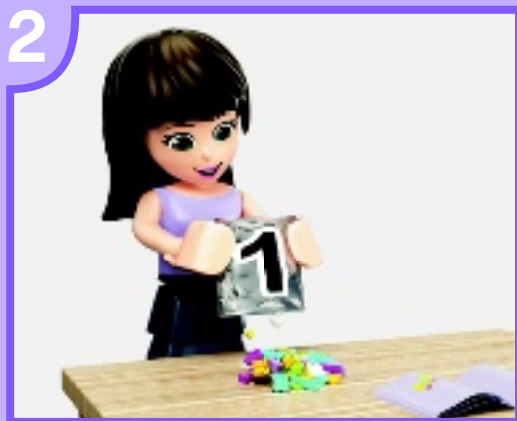

3



4



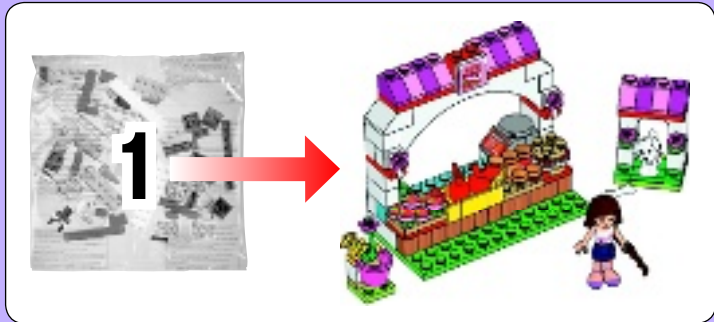



1

1



2



3



1



2



3



4



5





1

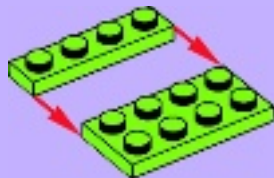

6



2

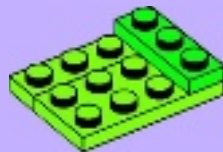

3

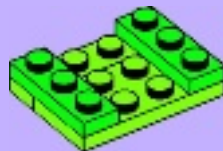



2x

4

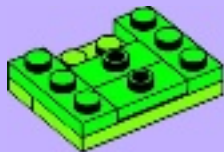

2x

5

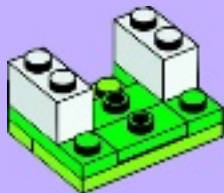

1x

6

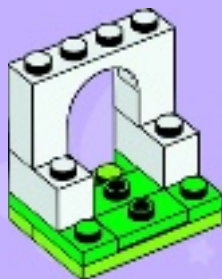



2x



2x

7

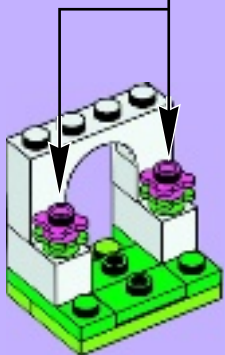
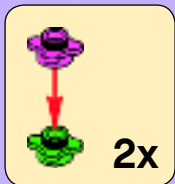

8



1x



2x



2x

8

1



2

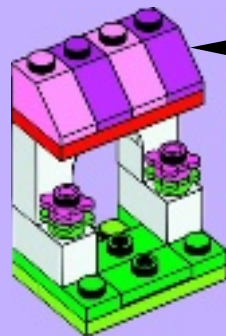
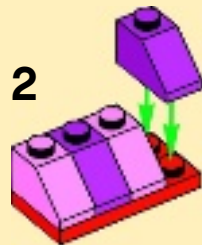

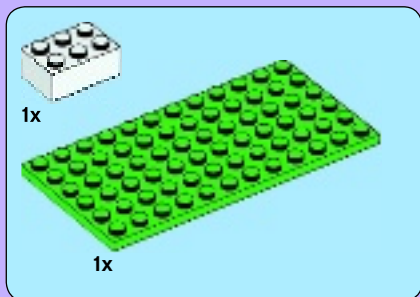

1





2x

2

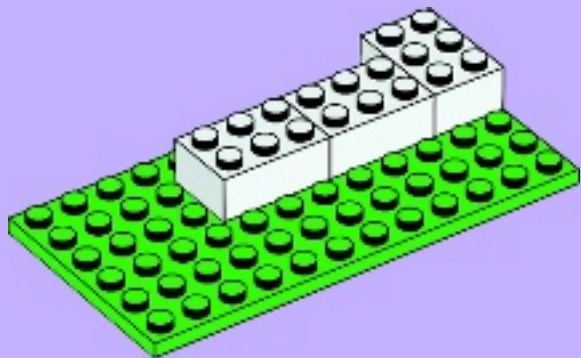

2x

3

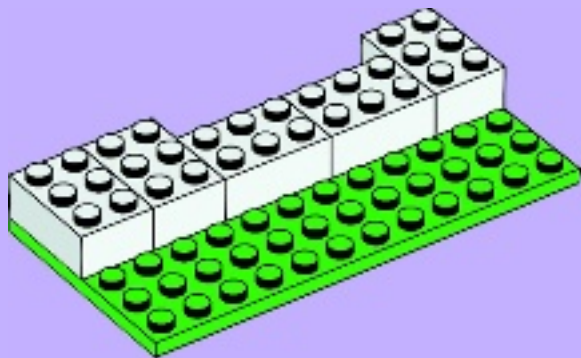



4

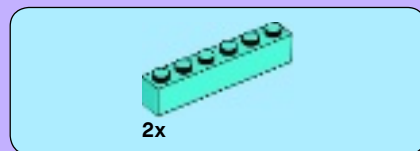
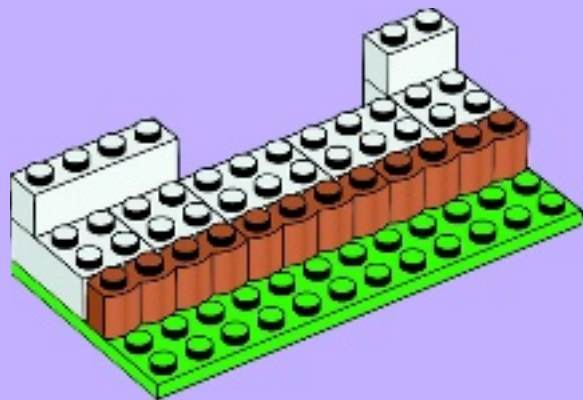

5

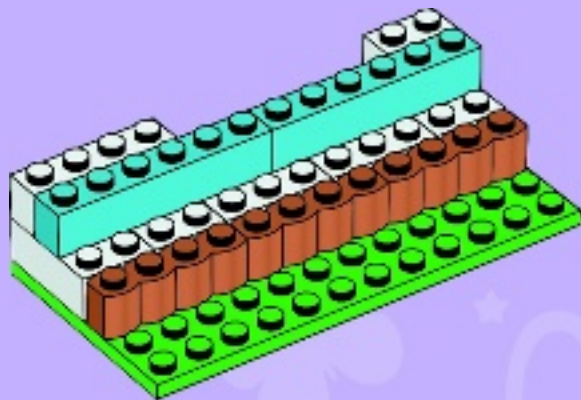



6

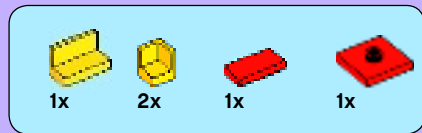
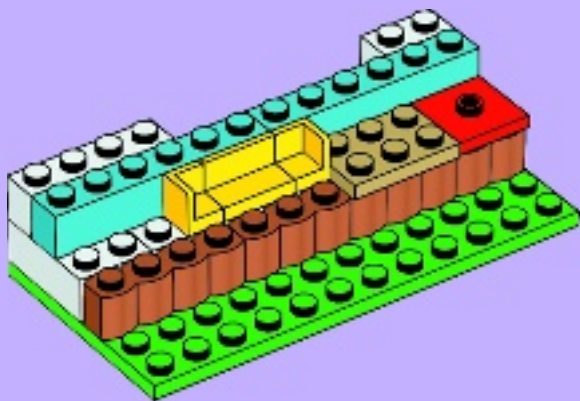

7

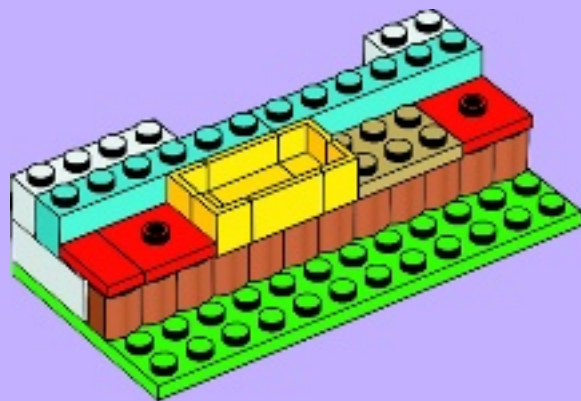



2x



1x

8

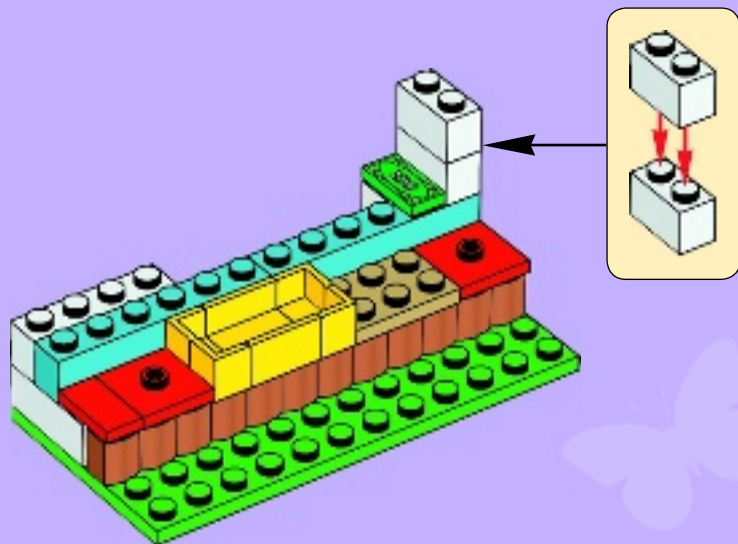

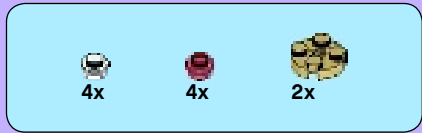

9

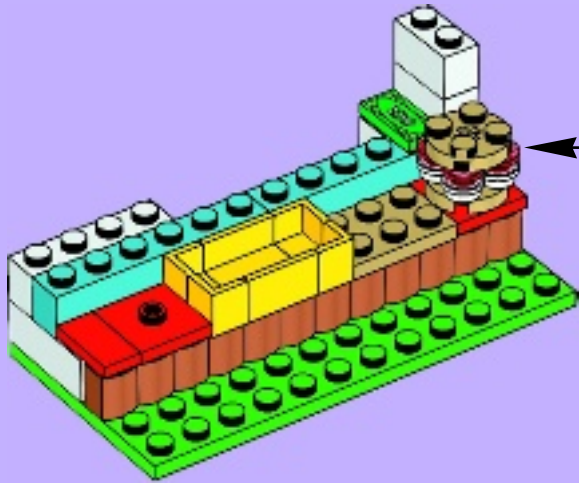



10

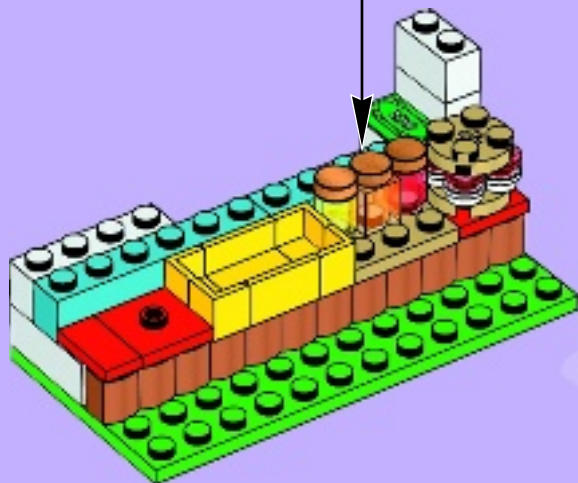



1x



1x



2x

11

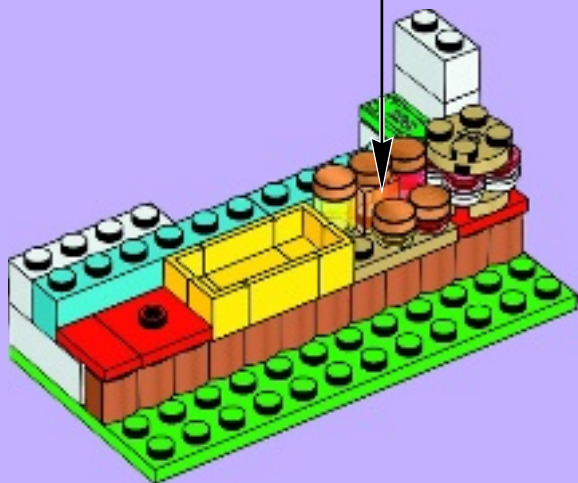



12

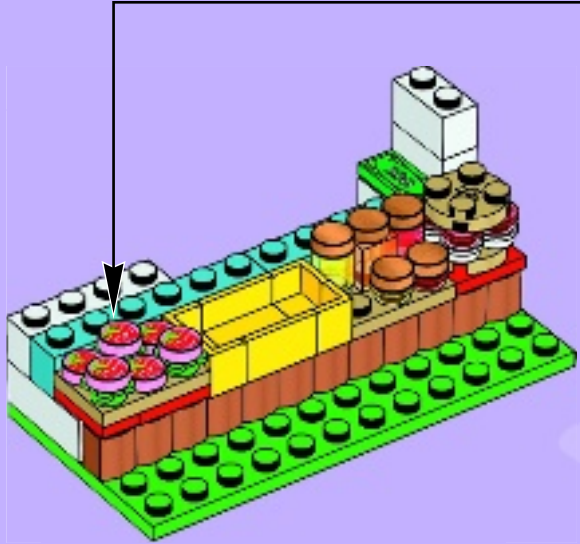



1x



1x



1x

13

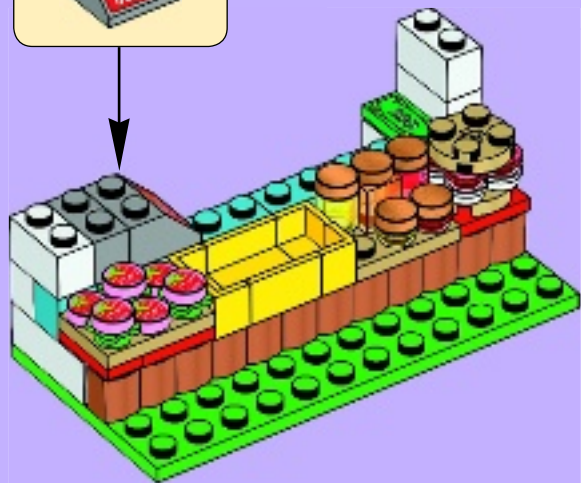

1x



1x

14

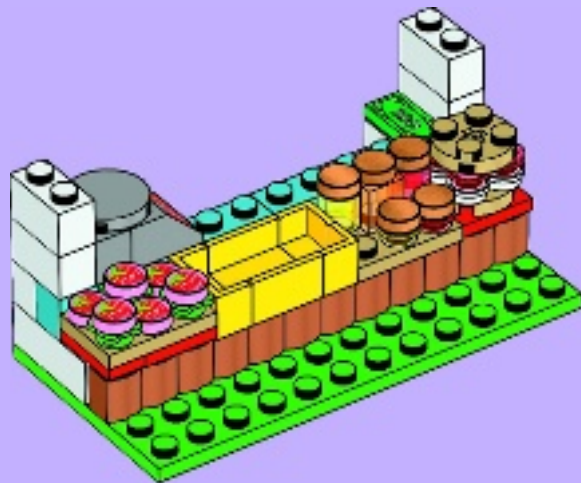



2x

15

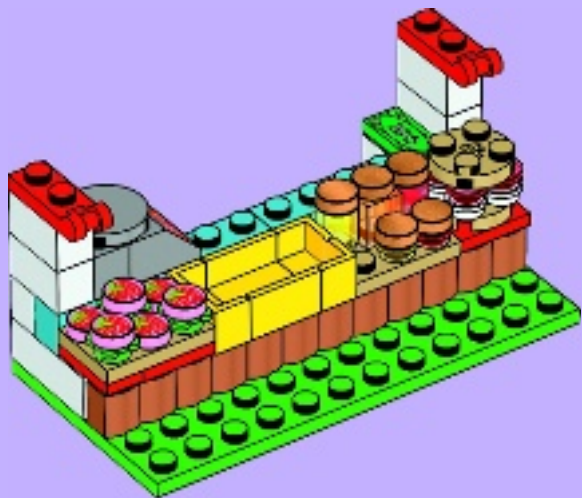

2x

16



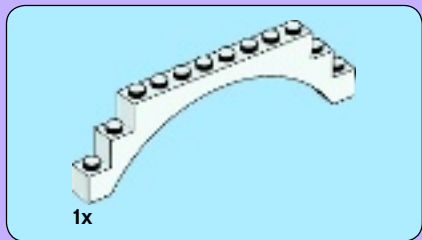

17

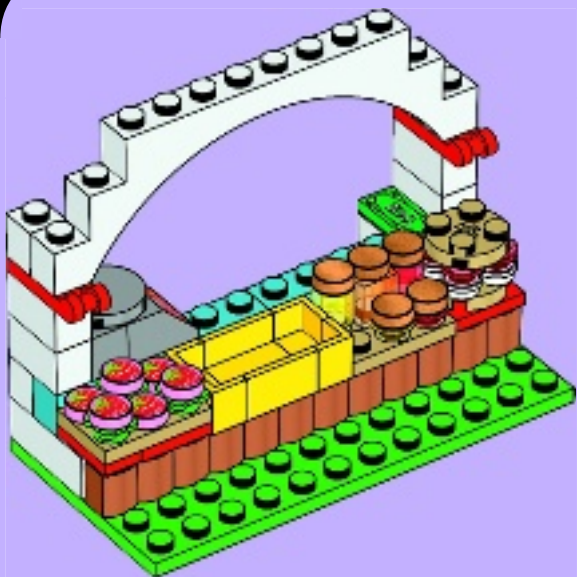

20

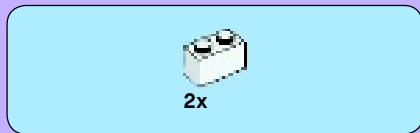

18





2x



2x



2x

19



2x

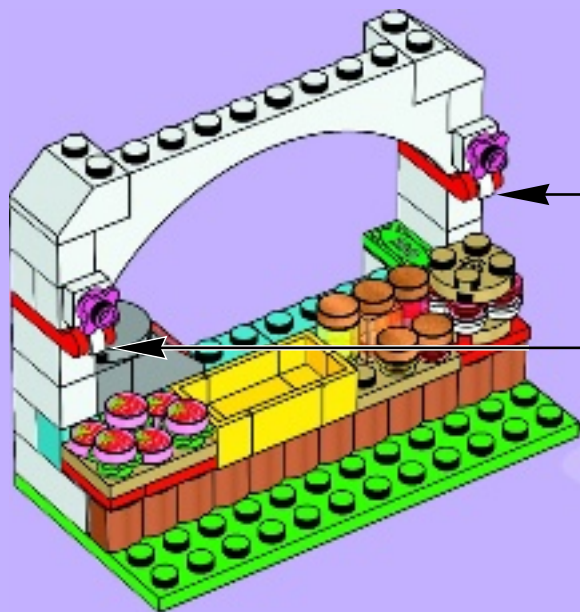

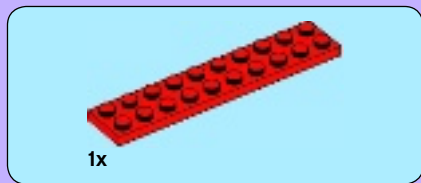

20

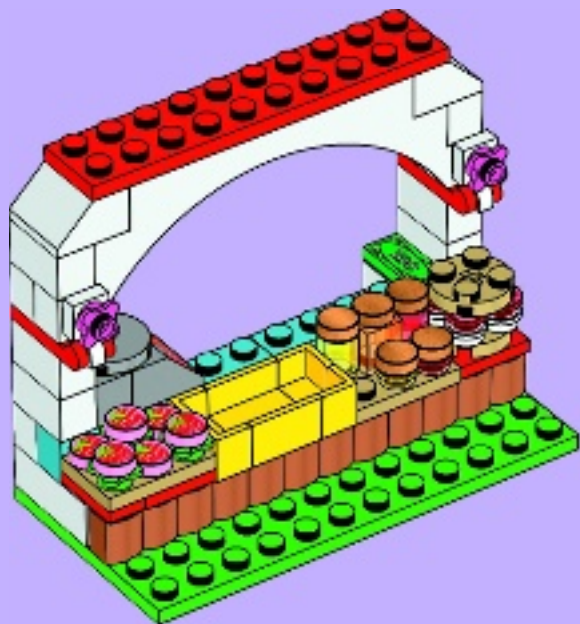



4x



4x

21

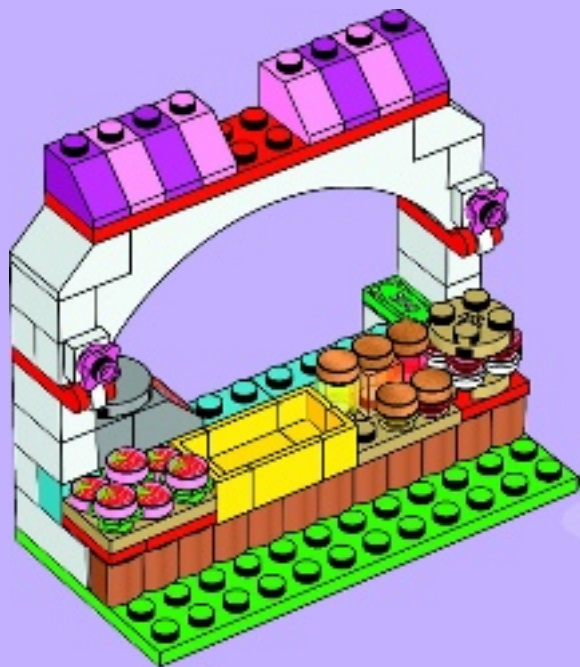



1x



1x

22

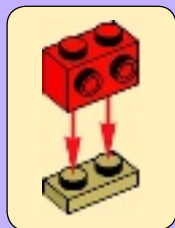



1x



1x



2x

23



2x



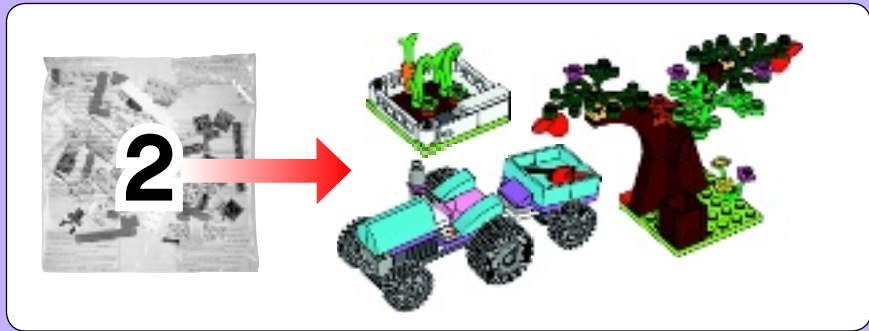

1



1x



2x

2



2x



2x



6x

3

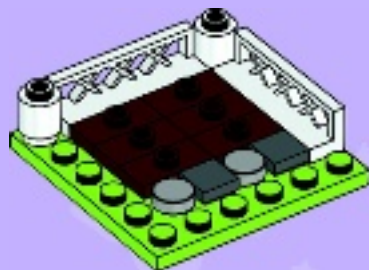



4

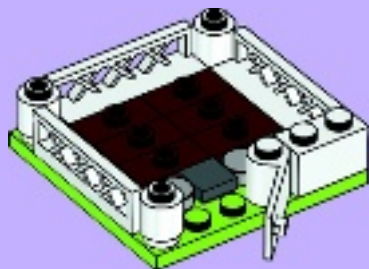

5

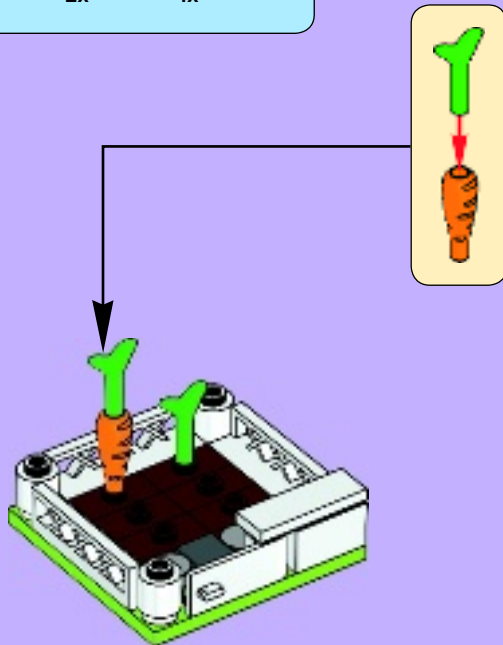



2x

6

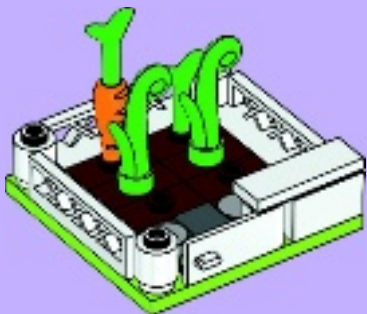

2x



2x

7



2x

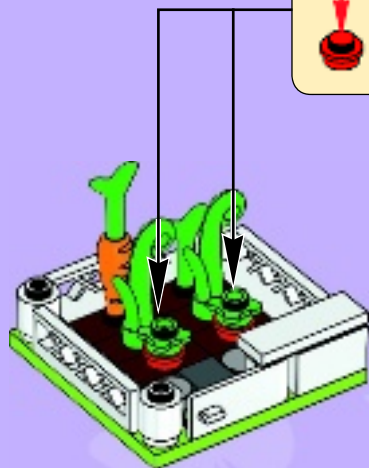



1

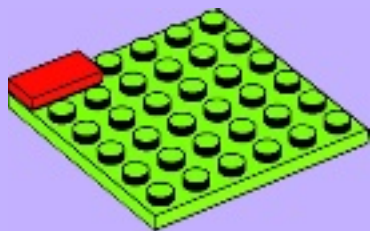

2



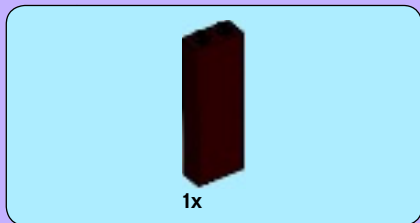

3

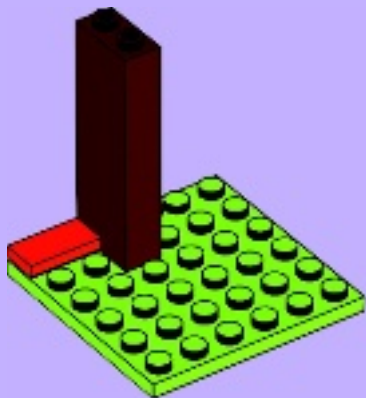

4





5

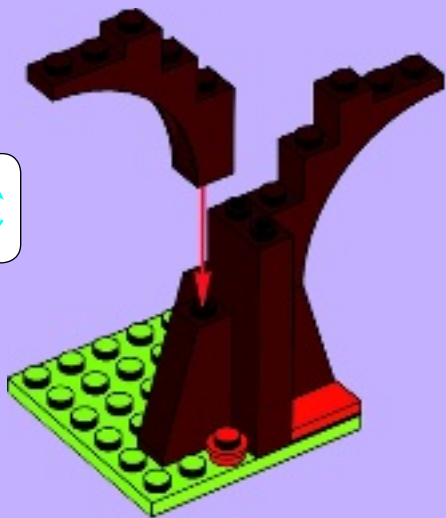
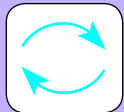

6





1x

7



3x

8

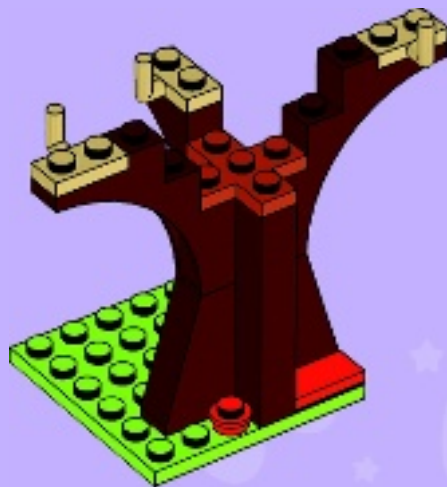

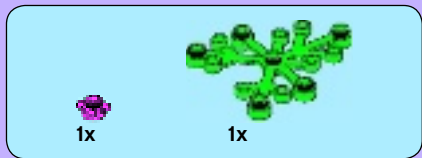

9

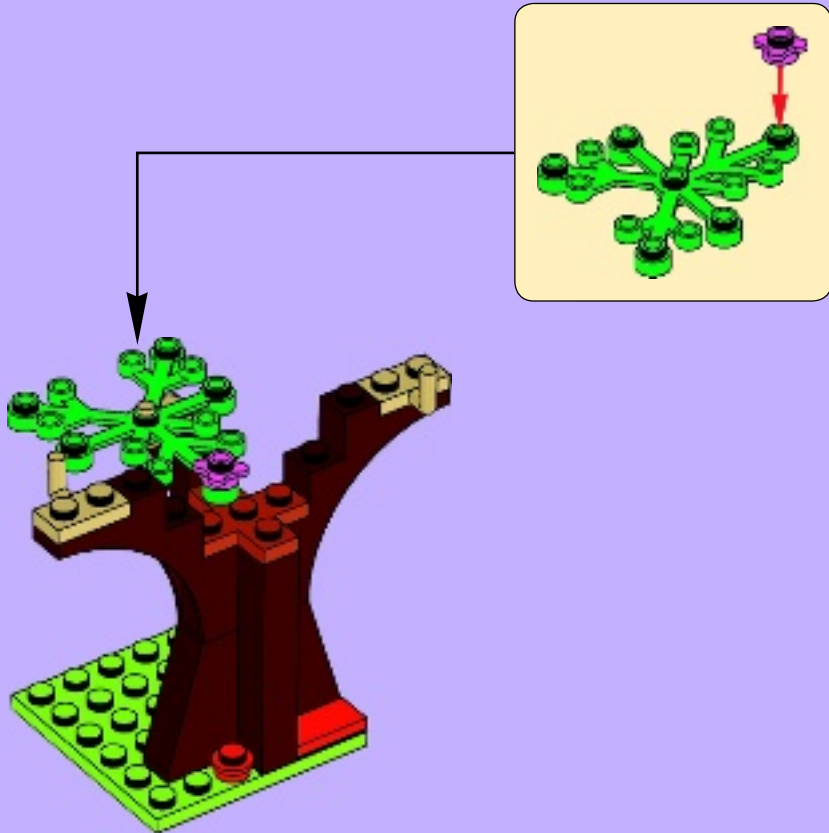



10

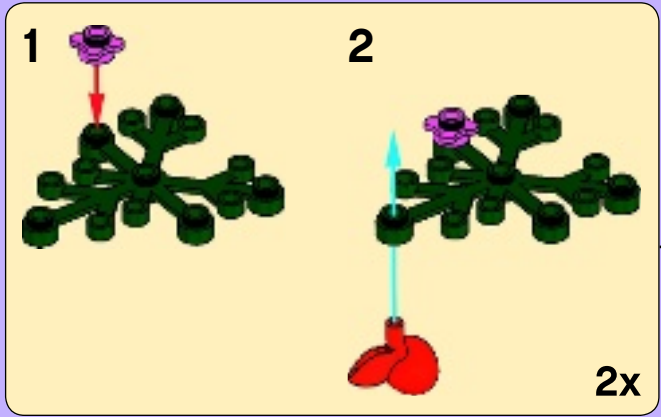



11

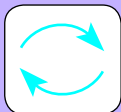

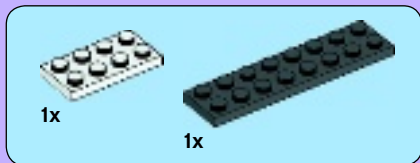
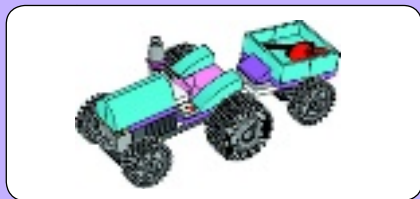

1



2





1x



1x

3



2x

4

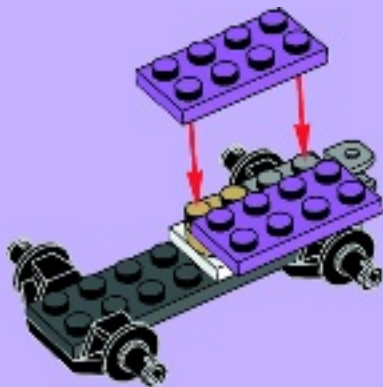



3x

5



1x

6





2x



1x



1x

7

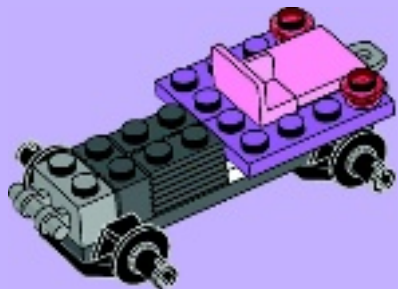

1x



1x

8

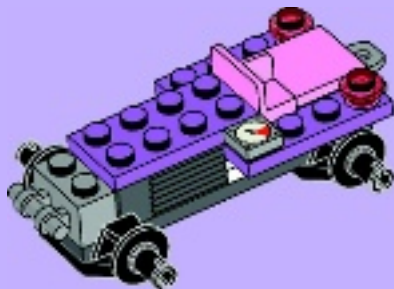



2x



1x



1x



2x

9

1



2



3

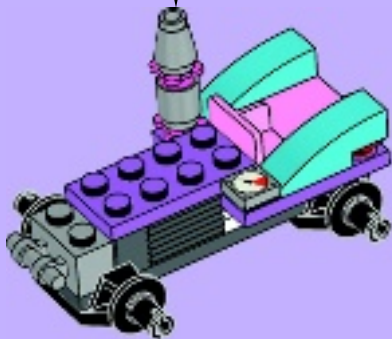

1x



2x

10



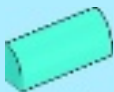

2x

11

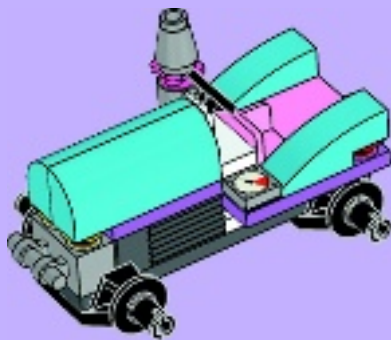

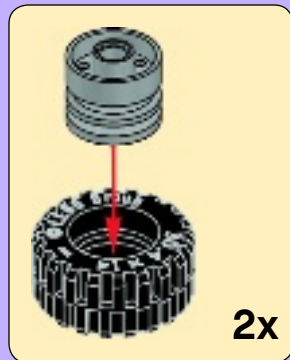

12

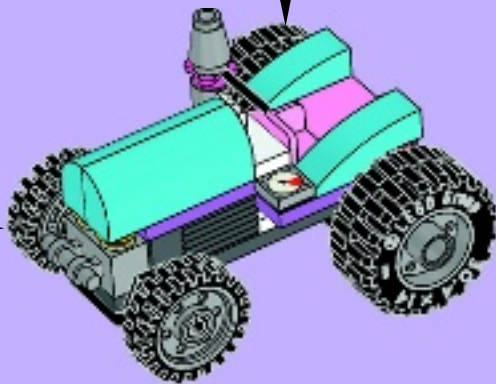
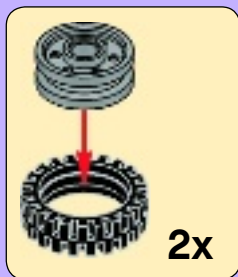



1

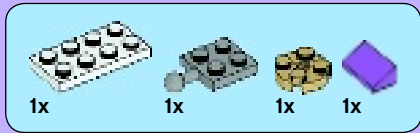

2





3

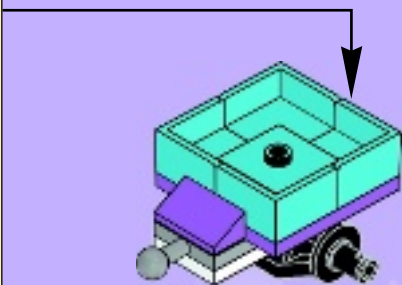
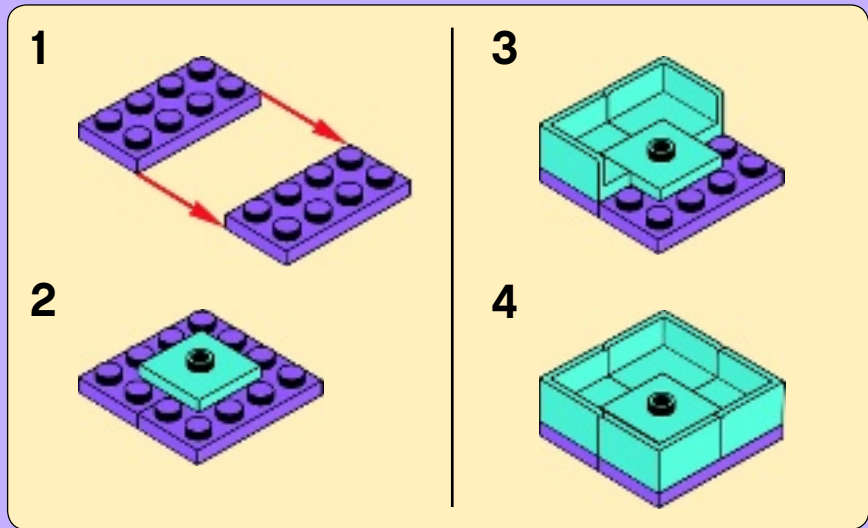



4

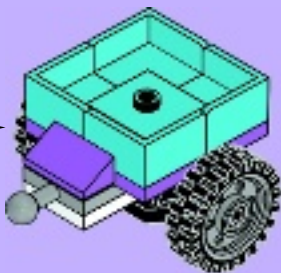
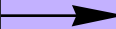
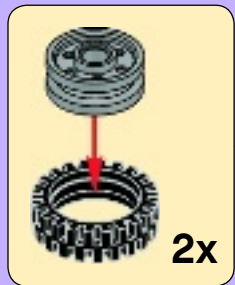

5

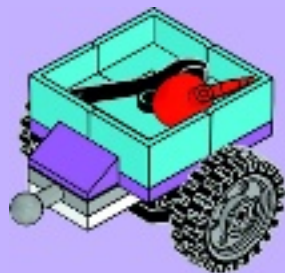

13

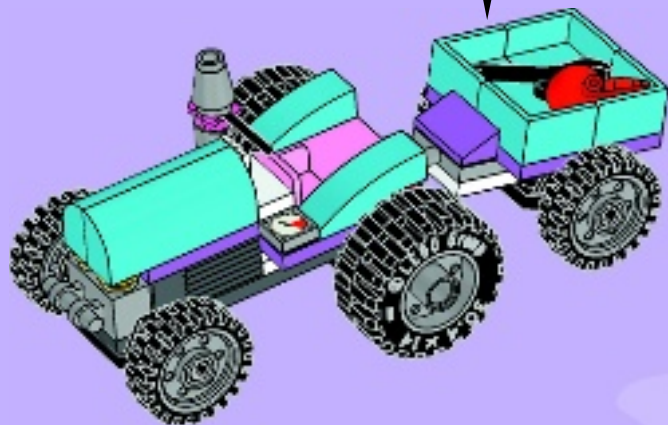





■ 41035



■ 41037



■ 41026



■ 41027



■ 41039



■ 41028



■ 41029

LEGO Friends



1x
6017039



2x
300501



11x
300401



5x
300201



1x
301001



3x
306201



2x
303901



1x
6031098

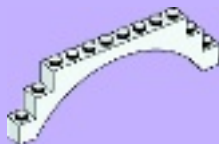

1x
6044693



1x
4558168



2x
302001



2x
4538353



4x
614101



1x
4537987



3x
4550171



1x
6059077



1x
4600294



1x
9551



2x
4113917



2x
4118790



3x
4655257



5x
4140562



1x
6017003



1x
6019155



2x
306921



2x
4581308



1x
302021



1x
383221



2x
4515365



3x
614121



1x
6062390



5x
6054438



1x
379424



4x
4201587



1x
4599537



2x
486524



1x
400626



4x
4541455



2x
4619323



3x
4217725



2x
379428



2x
4107758



2x
374128



1x
4613823

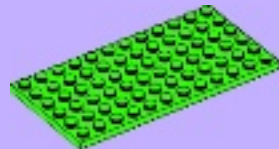

1x
4541414



7x
4619599



2x
6050929



2x
4119479



1x
4295260



1x
6062215



1x
3006841



7x
3005741



Customer Service

Kundenservice

Service Consommateurs

Servicio Al Consumidor

LEGO.com/service or dial



: 00800 5346 5555

: 1-800-422-5346



Friends



41039



41026



41029

Heartlake City





41027



41035



41037



41028





Friends



LEGO.com/friends

iPhone, iPad and iPod touch are trademarks of Apple Inc., registered in the U.S. and other countries.
iPod, iPhone et iPod touch sont des marques d'Apple Inc., enregistrées aux États-Unis et dans d'autres pays.
iPhone, iPad e iPod touch son marcas comerciales de Apple Inc., registradas en EE. UU. y otros países.

LEGO Friends



NINTENDO 3DS. NINTENDO DS.

© 2014 The LEGO Group.™ & © WBEI. (s14) "3DS", "DS"™ & © 2014 Nintendo. All rights reserved/Tous droits réservés/Todos los derechos reservados.

WB GAMES LOGO, WBIE LOGO, WB SHIELD:™ & © Warner Bros. Entertainment Inc. (s14)



Visit www.esrb.org for rating information



Win!

Go to LEGO.com/productfeedback to fill out a survey for a chance to win a cool LEGO® Product.

No purchase necessary.
Open to all residents
where not prohibited.



LEGO.com/productfeedback

Gewinne!

Nimm an der Umfrage auf LEGO.com/productfeedback teil und hab die Chance ein cooles LEGO® Produkt zu gewinnen!

Die Teilnahme am Gewinnspiel führt zu keinerlei Kaufverpflichtungen. Teilnahme in allen nicht ausgeschlossenen Ländern möglich.



LEGO.com

6089959 / 6089960

Win!

Ga naar LEGO.com/productfeedback, vul een enquêteformulier in en maak kans op een cool LEGO® product.

Geen aankoopverplichting.
Iedereen mag deelnemen, uitzonderend ingezetenden van landen waar een enquêteverbod geldt.

Gagne!

Visite LEGO.com/productfeedback pour répondre à un questionnaire et avoir une chance de gagner un produit LEGO® très cool !

Aucune obligation d'achat.
Ouvert à tous les résidents des pays autorisés.

当てよう!

LEGO.com/productfeedbackにアクセスして、アンケートにご記入ください。当選者にはレゴ製品を差し上げます。

お買い上げの必要はありません。

禁止されていない限り、すべての皆様にご利用いただけます。

LEGO and the LEGO logo are trademarks of the/sont des marques de commerce de/son marcas registradas de LEGO Group. ©2014 The LEGO Group.