



STAR WARS

75073



 LEGO.com

MICROFIGHTERS

SERIES 2

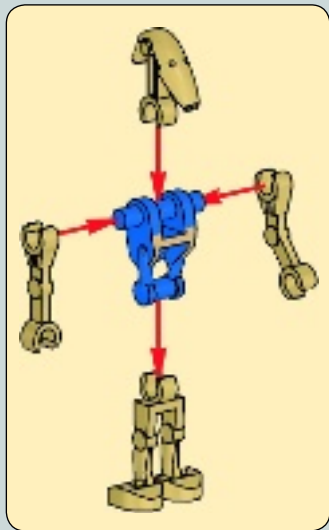



1

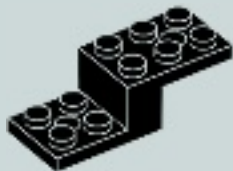



1x

2



4

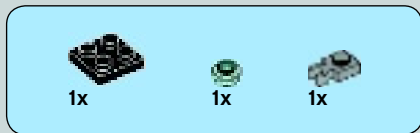

3





1x



1x



1x

1



2



4



6



5

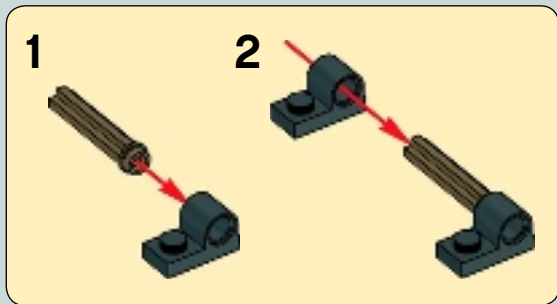



2x



1x

6

1



2

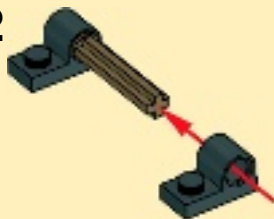



7

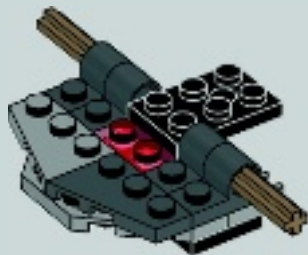



2x

8

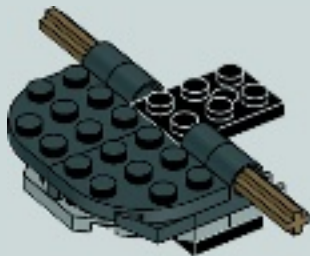



1x



2x

9

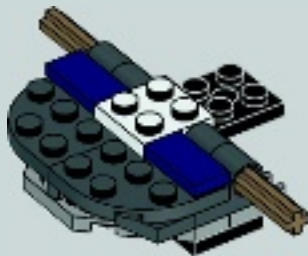



2x

10

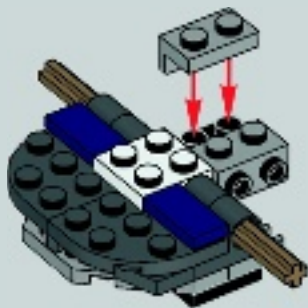

12



1x

11

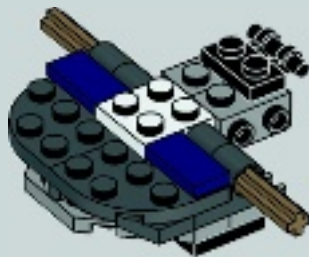

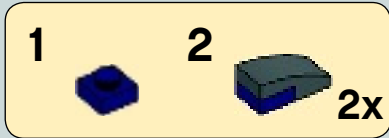

12

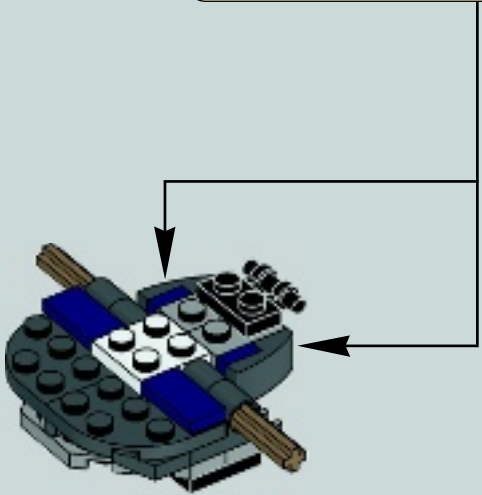



1x



1x

13

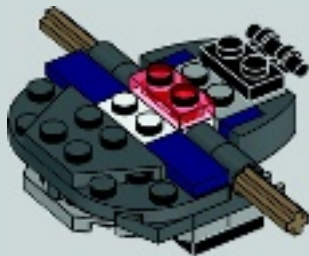



1x

14

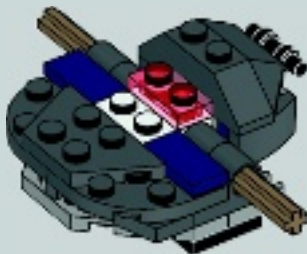



1x

15

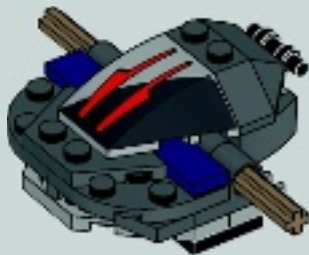

16



2x

16

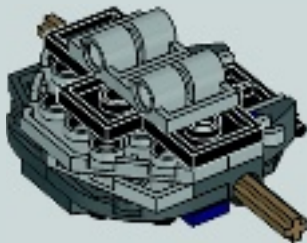
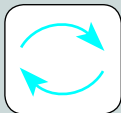

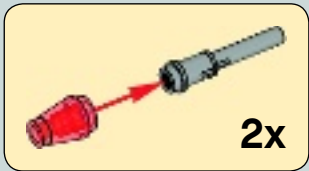

17

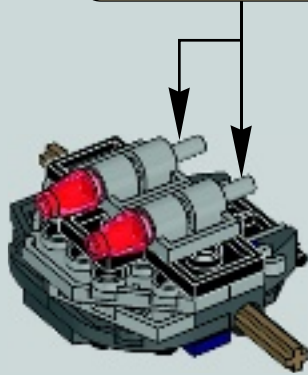

18



2x



1x

1





1x

2



20



2x

3





4

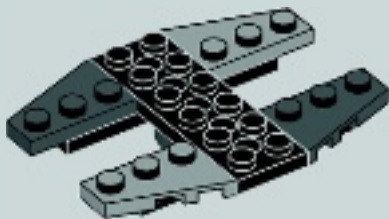
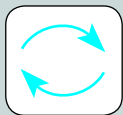



1x



1x

5

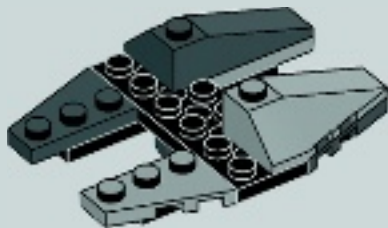

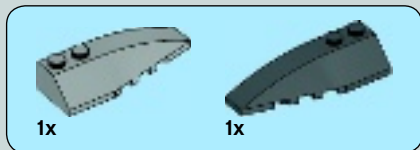

6

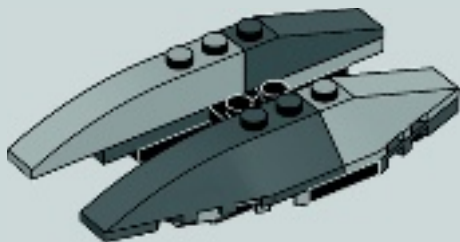



2x

7

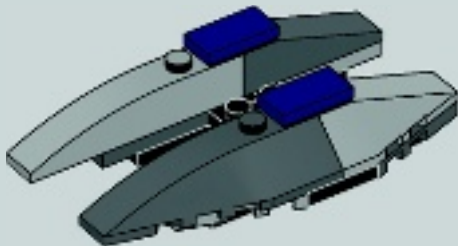

2x

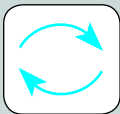

18

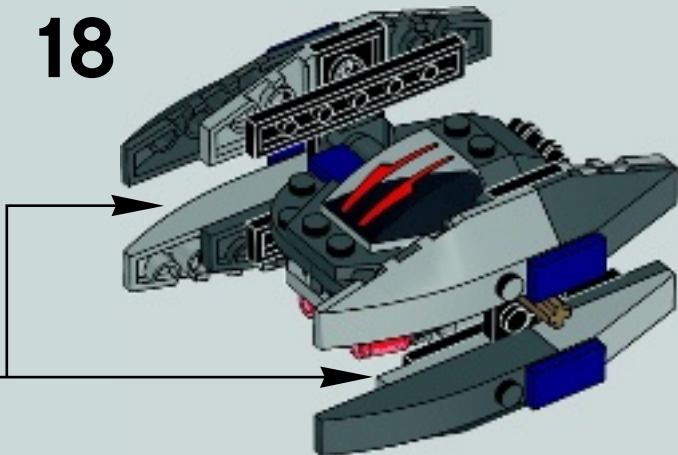



2x



2x

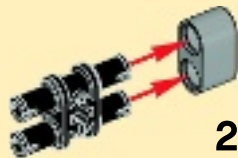

2x

19

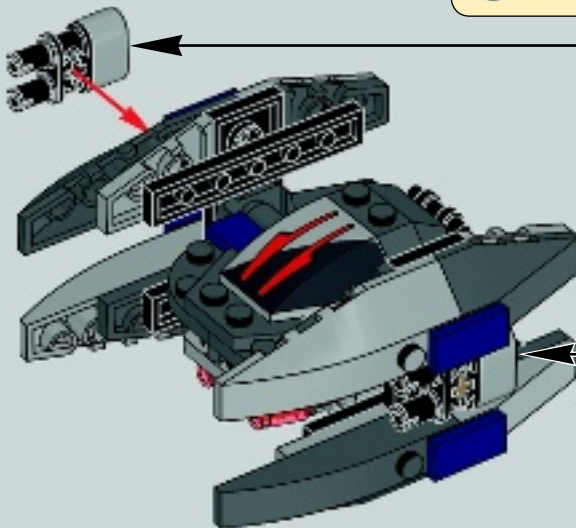

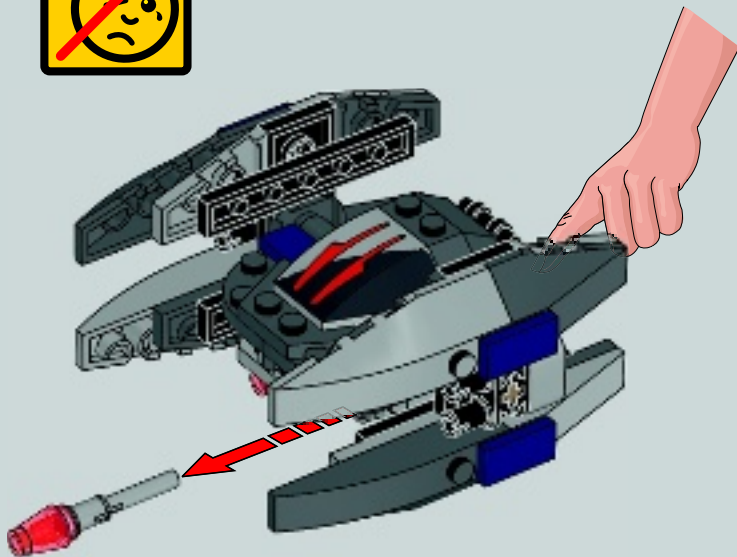

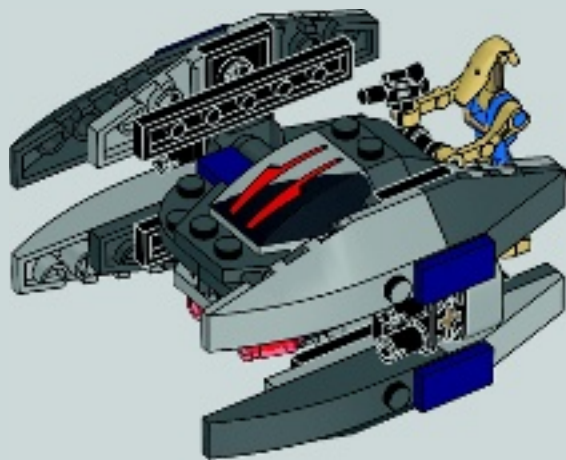



1x
302201



1x
4508093



1x
4545336



1x
6029182



1x
4261885



1x
4614789



1x
6039194



4x
366626



1x
4140588



2x
3200126



1x
4609050



2x
4119589



2x
302226



2x
4544720



2x
4201019



2x
4163917



2x
6031821



2x
4184108



6x
4528488



2x
4180418



1x
6096629



2x
4212007



2x
4594238



2x
4654582



2x
4211376



5x
4211794



2x
4211862



2x
4520320



1x
4211352



2x
6063681



1x
6027686



4x
6019987



5x
4210869



2x
4211042



2x
6029948



1x
4527082



2x
4212075



2x
4210866



Customer Service

Kundenservice

Service Consommateurs

Servicio Al Consumidor

LEGO.com/service or dial



: 00800 5346 5555



: 1-800-422-5346

LEGO

**STAR
WARS**



MICROFIGHTERS

STAR WARS © & ™ 2015 Lucasfilm Ltd. © 2015 The LEGO Group. ™ & © WBEI.

Apple, the Apple logo, iPad, iPhone and iPod touch are trademarks of Apple Inc., registered in the U.S. and other countries. App Store is a service mark of Apple Inc.

Google Play is a trademark of Google Inc.



STAR WARS

Download the Microfighters App!



MICROFIGHTERS



WIN

GO TO WWW.LEGO.COM/PRODUCTFEEDBACK AND
GIVE US YOUR SHORT **FEEDBACK** ABOUT THIS
LEGO® SET FOR A CHANCE TO WIN
A COOL LEGO PRIZE.



LEGO.com/productfeedback

GEWINNE



Erzähle uns auf
www.LEGO.com/productfeedback

etwas über die Erfahrungen, die
du mit diesem LEGO® Set gemacht
hast, und sichere dir die Chance auf
einen coolen LEGO Preis!

GAGNE



Rends-toi sur
www.LEGO.com/productfeedback

et donne-nous quelques commen-
taires sur ce produit LEGO® pour
avoir une chance de gagner un
prix LEGO !

GANA



Visita
www.LEGO.com/productfeedback

y envíanos tu opinión acerca de este
set LEGO®. ¡Participarás en el sorteo
de un premio LEGO!

获取奖品



登录
www.LEGO.com/productfeedback

给出关于此乐高®套装的简短反馈，
就有机会获得炫酷乐高奖品

LEGO and the LEGO logo are trademarks of the LEGO Group. ©2015 The LEGO Group.
© & ™ Lucasfilm Ltd.

6106665