



# Architecture

21032  
Sydney  
Australia



[LEGO.com/architecture/booklet](http://LEGO.com/architecture/booklet)

# Sydney

As Australia's largest and most famous city, Sydney encompasses both striking modern architecture and many of the country's most important historical landmarks.

Founded as a colony in 1788, the city now stretches around the world's largest natural harbor, reaching towards the stunning Blue Mountains in the west.

One third of the city's growing population of 4.8 million inhabitants were born overseas, making Sydney one of the most varied and vibrant cities in the world and a magnet for over three million international visitors every year.

*[ "If Paris is the city of lights,  
Sydney is the city of fireworks." ]*

Baz Luhrmann









*Ralph Alphonso*

## Sydney Opera House

The Sydney Opera House is a masterpiece of modern architecture, and one of the most celebrated buildings of the 20<sup>th</sup> century. Set against the stunning backdrop of Sydney Harbor, its shells appear like billowing sails filled by the sea winds. Since its opening in 1973, the Opera House has become one of the world's busiest performing arts centers, welcoming over 8 million visitors a year and staging almost 2,000 performances annually.





## Sydney Harbour Bridge

The Sydney Harbour Bridge, also affectionately known as the 'Coathanger', was opened on March 19<sup>th</sup>, 1932, after six years of construction. This famous Sydney symbol is constructed in steel and contains six million hand-driven rivets. The top of

the arch is 439 ft. (134 m) above sea level. The 160 ft. (49 m) wide deck makes Sydney Harbour Bridge the widest long-span bridge in the world.



# Sydney Tower

The Sydney Tower has been an integral part of the Sydney skyline for over 30 years. The 1,014 ft. (309 m) tall tower is the tallest structure in Sydney and its 420 windows allow the perfect view of the city. If you spent the whole day in the tower's observation deck, you would be the first person to see the sun rise over Sydney and the last to see it set.









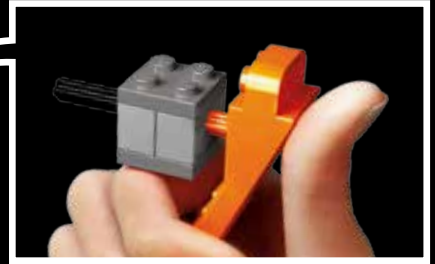
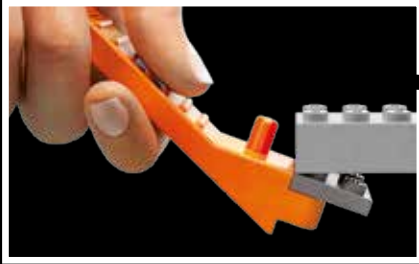
## Deutsche Bank Place

Although a recent addition to the Sydney skyline, the Deutsche Bank Place is nevertheless one of the city's most distinctive structures. Completed in 2005, its unusual design was guided by a narrow building site and the need to ensure sufficient sunlight for the surrounding public spaces. Constructed in concrete, glass and steel, the 790 ft. (240 m) building was designed by the internationally renowned architects Foster + Partners.

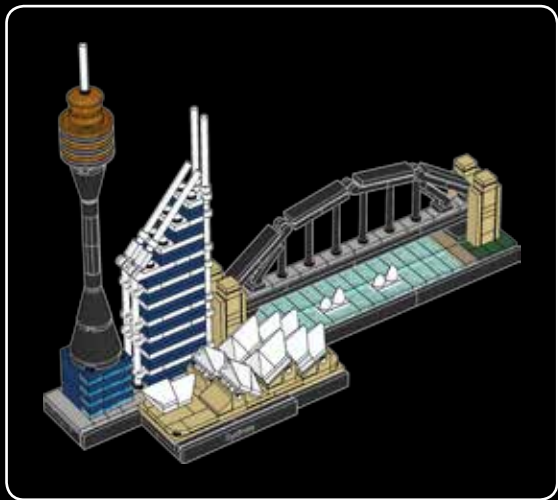


Photo courtesy of Investa

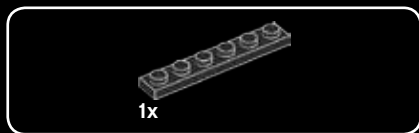
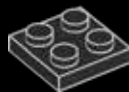




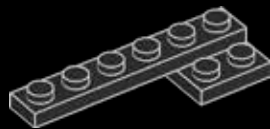
[LEGO.com/brickseparator](https://LEGO.com/brickseparator)



1



2

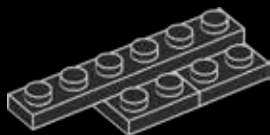


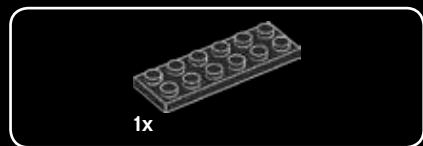




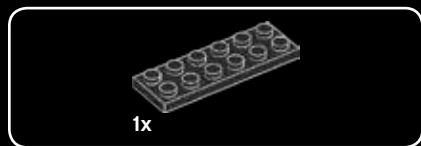
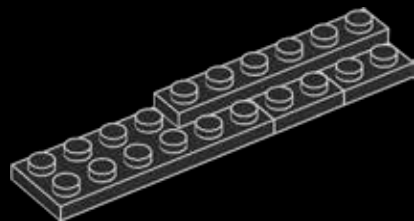
1x

**3**

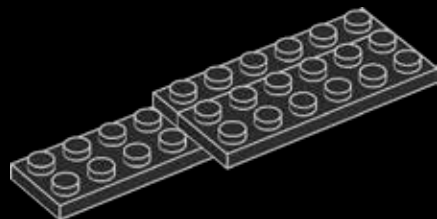




4



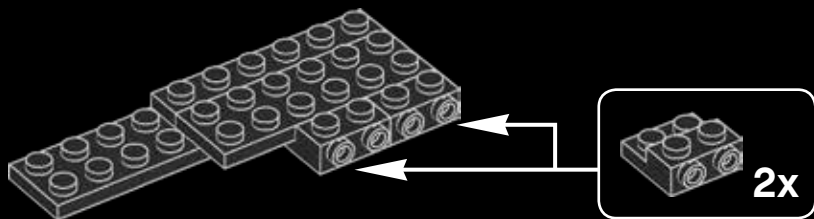
5

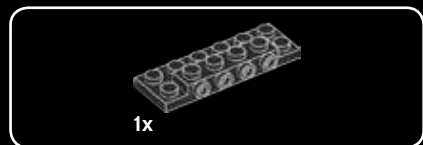




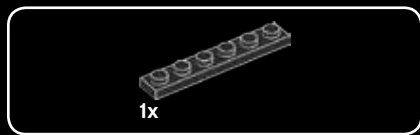
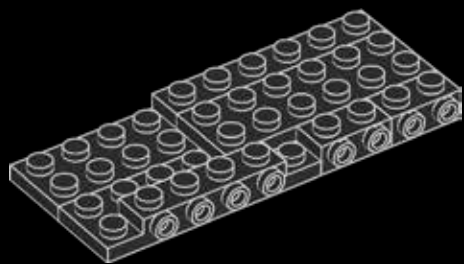
2x

6

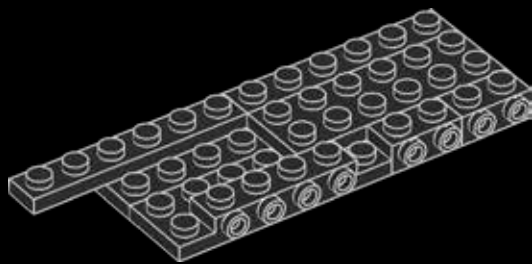


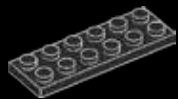


7



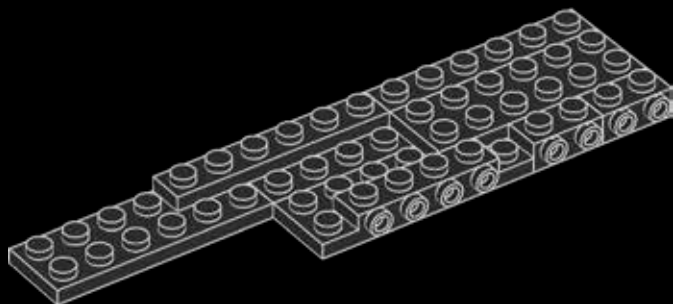
8



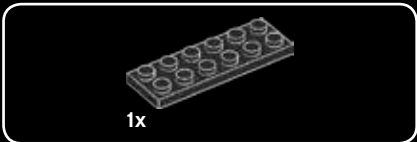


1x

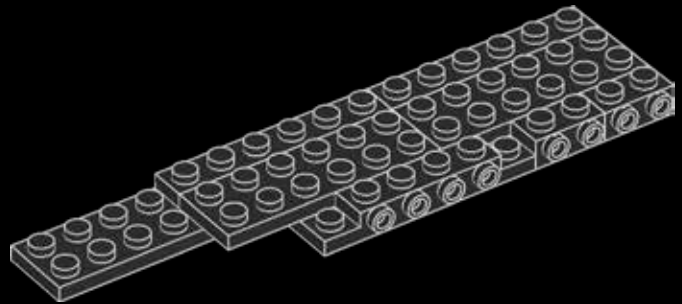
9







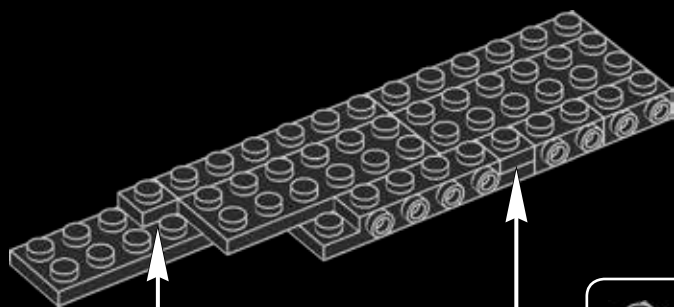
10



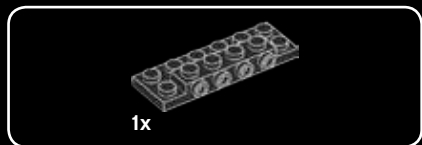


2x

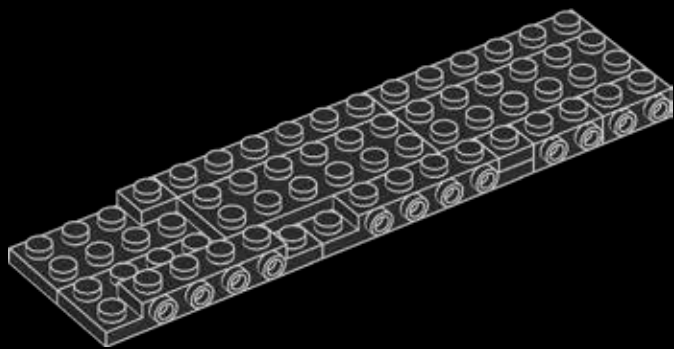
11

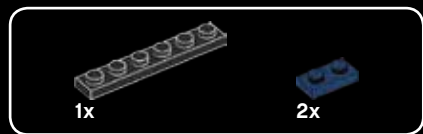


2x

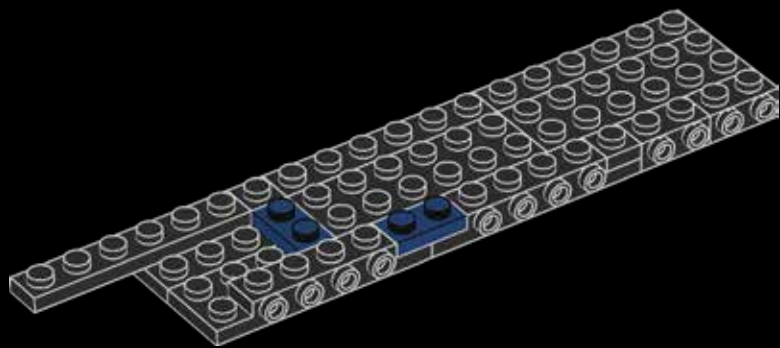


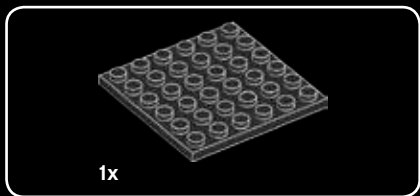
12



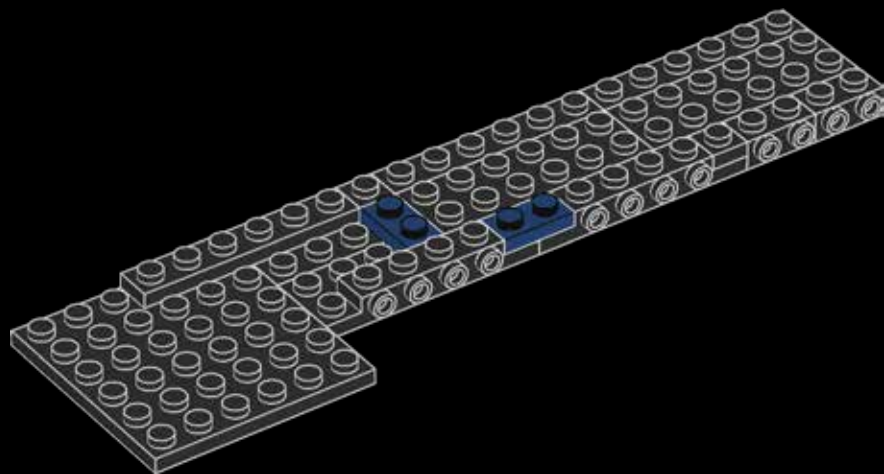


13

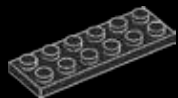




14

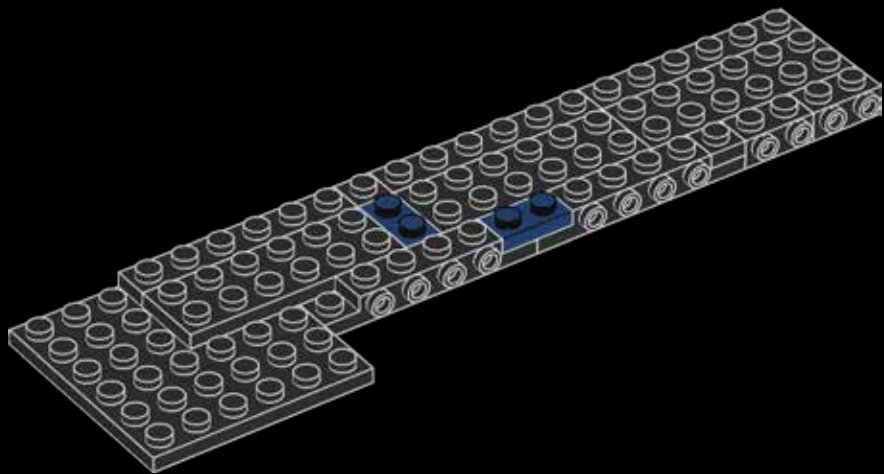


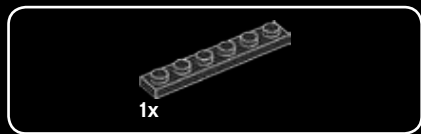




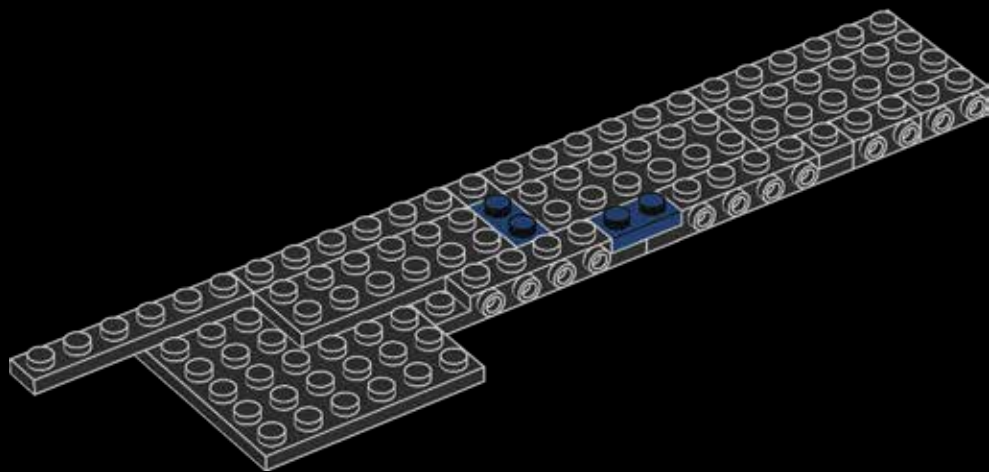
1x

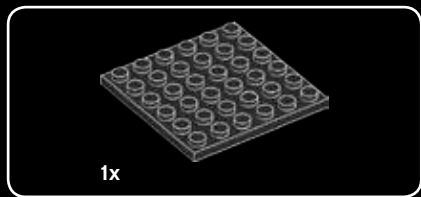
15



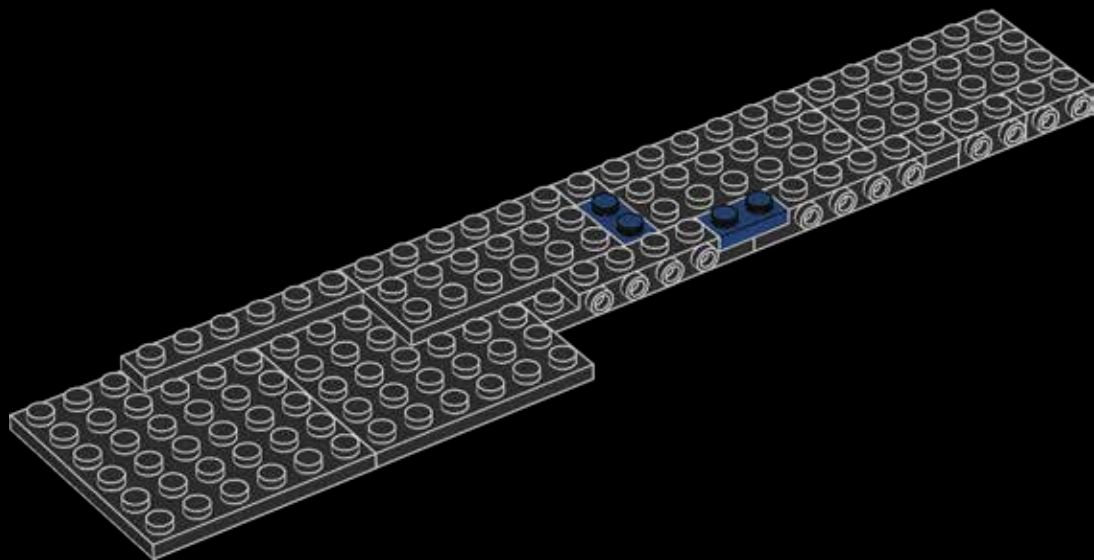


16

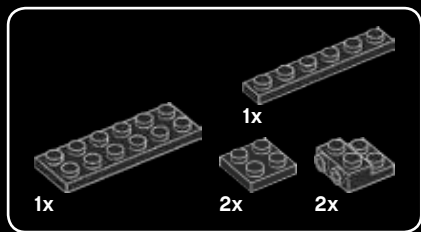




17

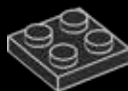




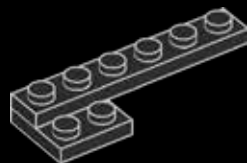


19

1

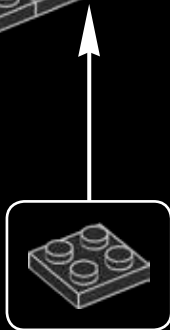
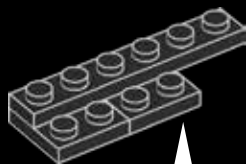


2

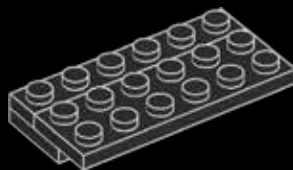




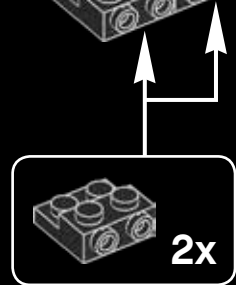
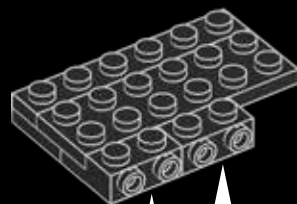
**3**

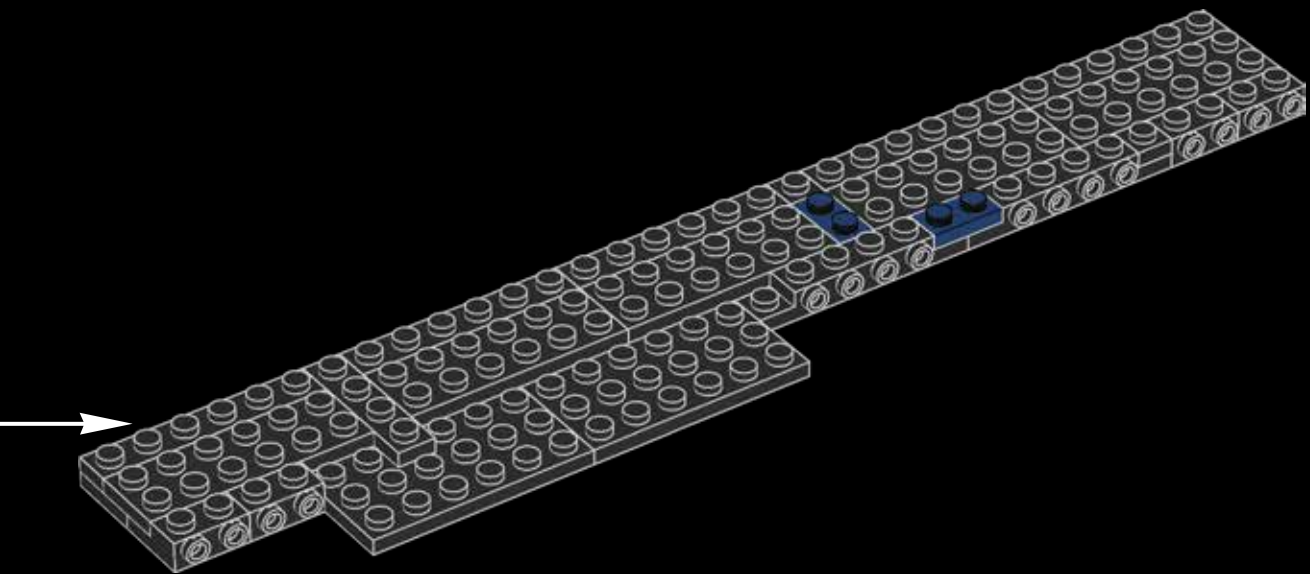


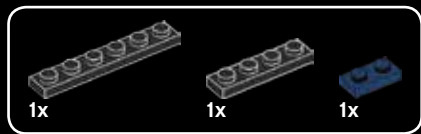
**4**



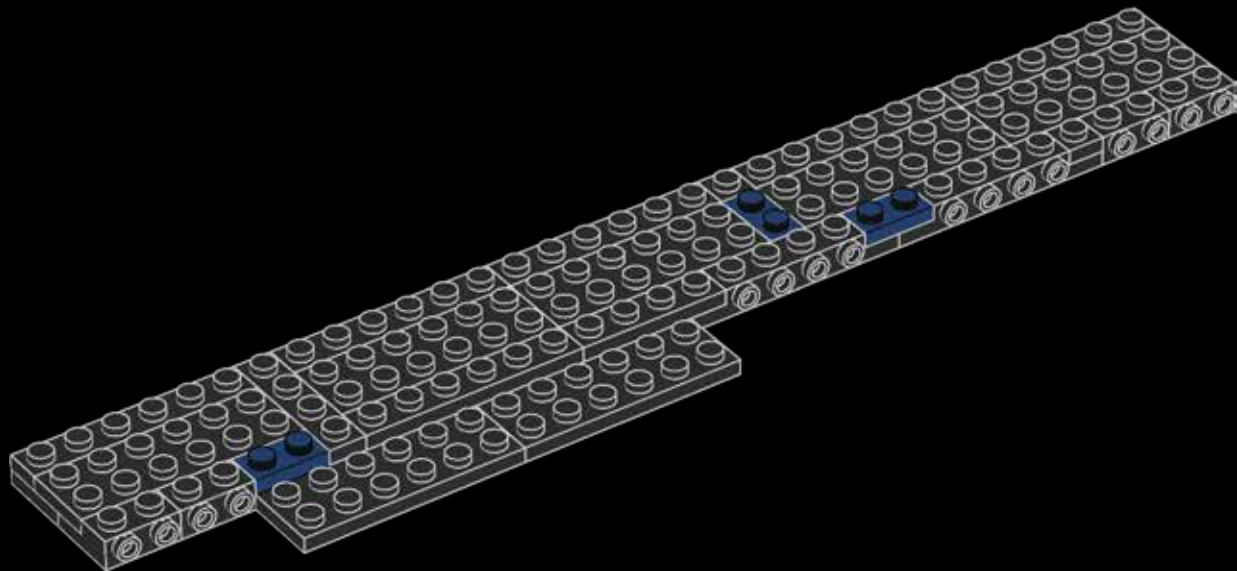
**5**







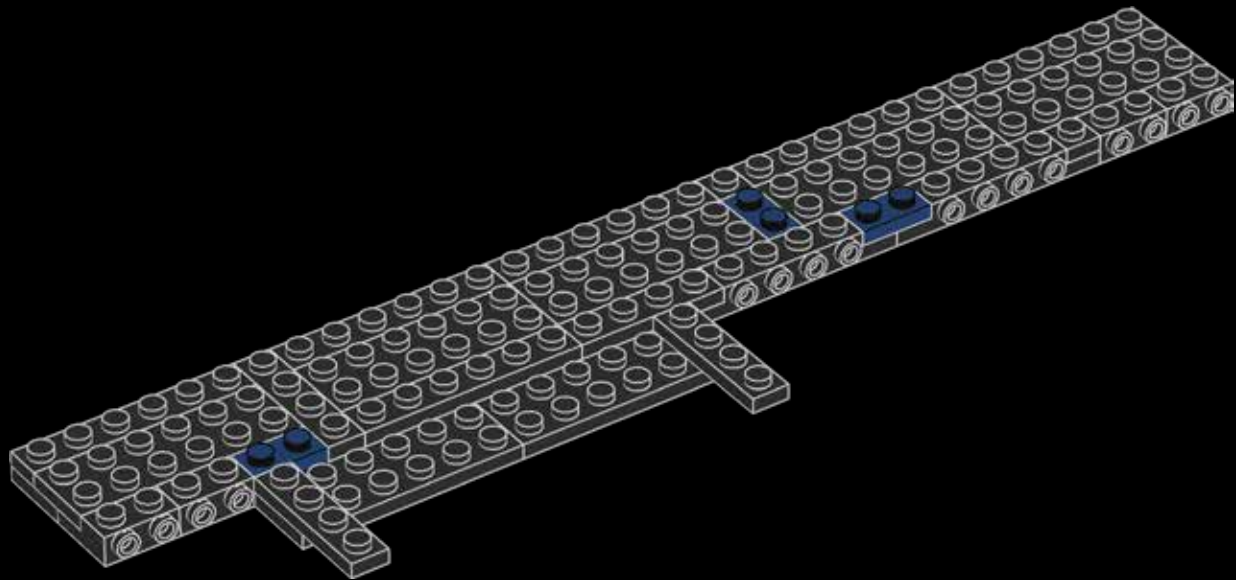
20

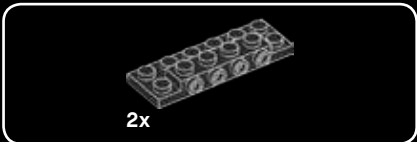




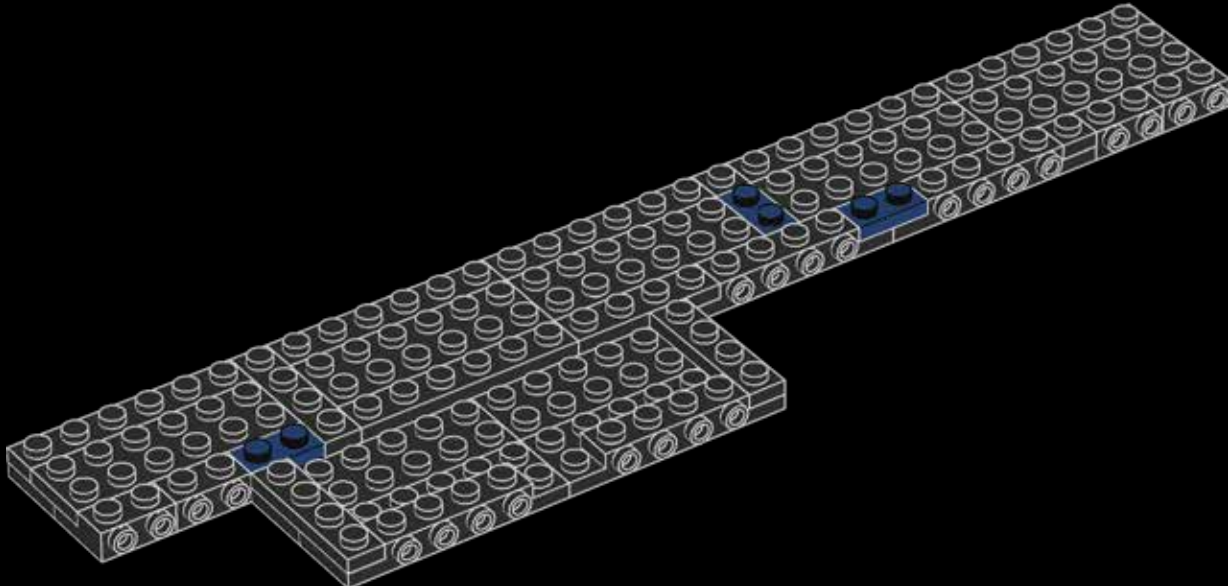
2x

21





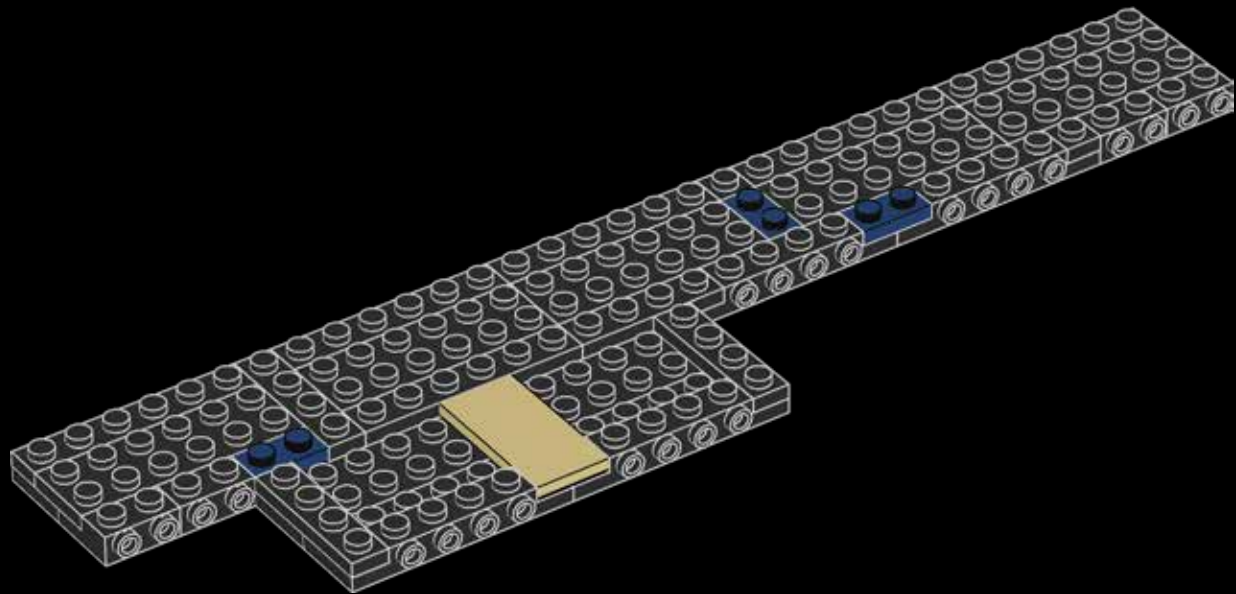
22



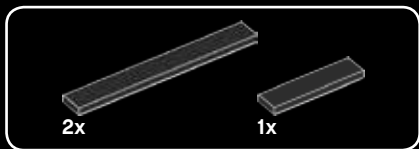


1x

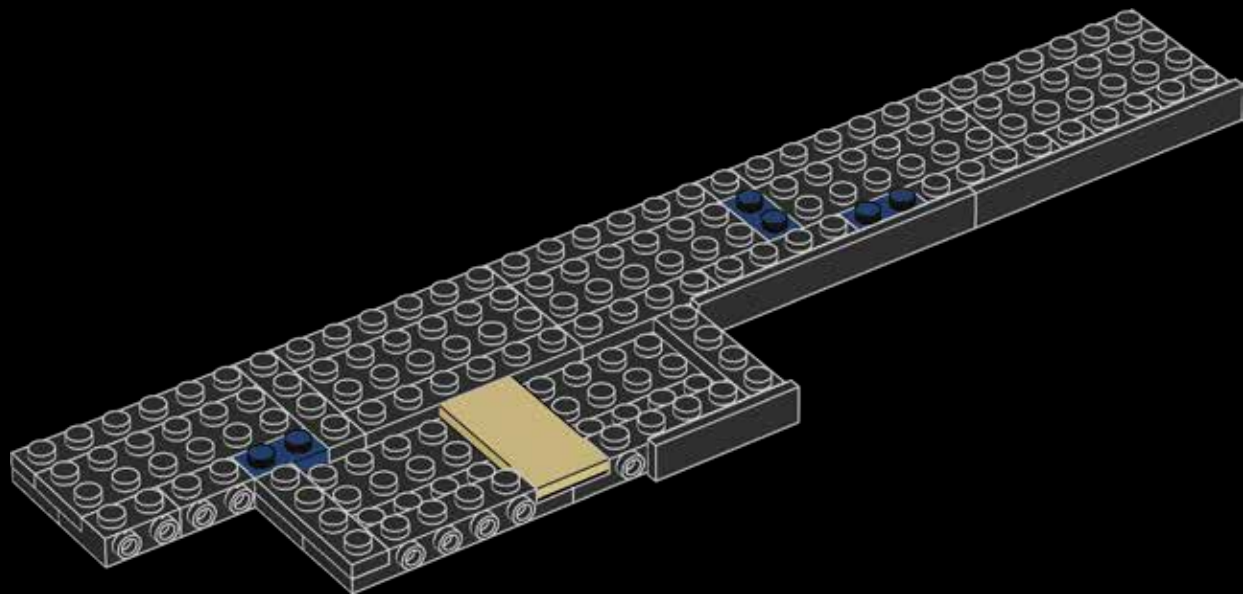
23

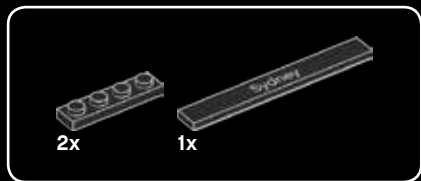


34



24





25

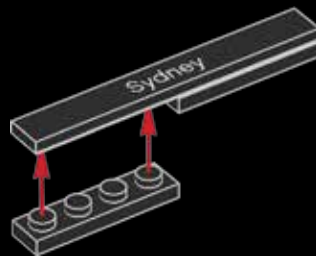
1



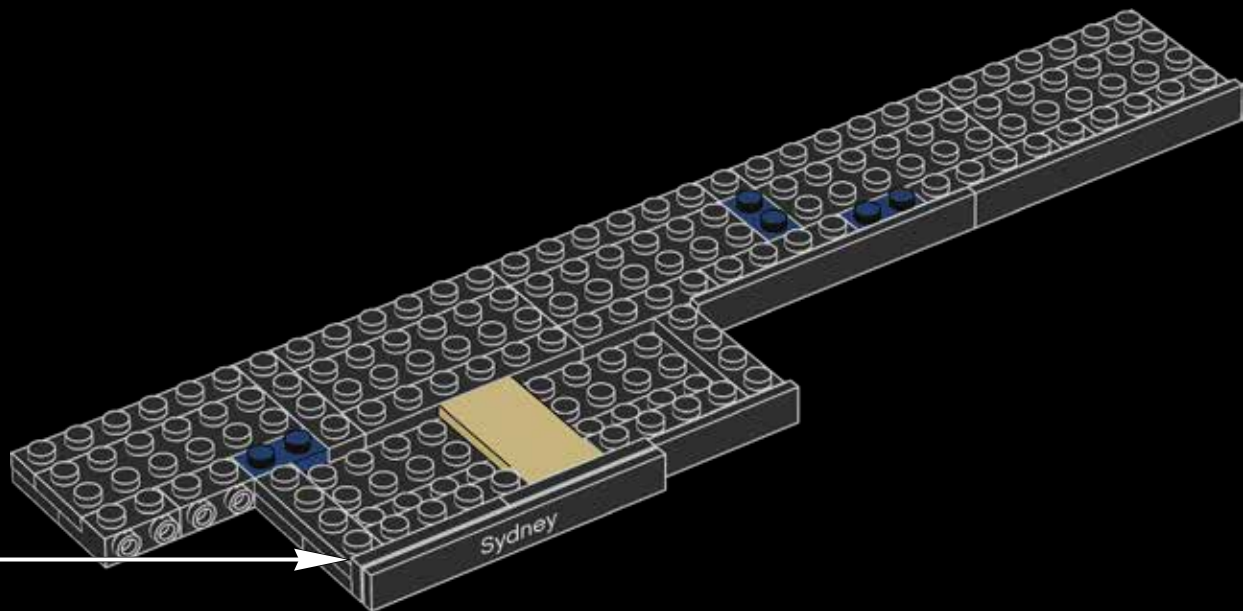
2



3



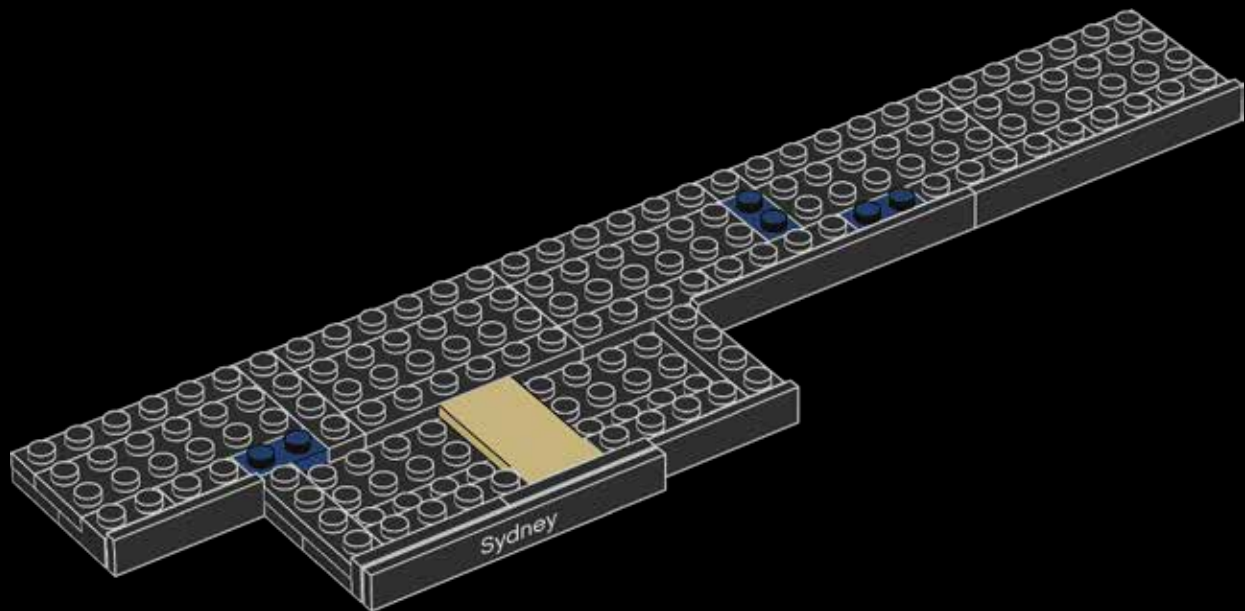




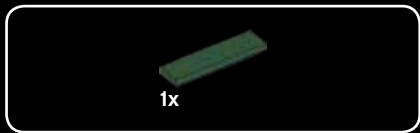


1x

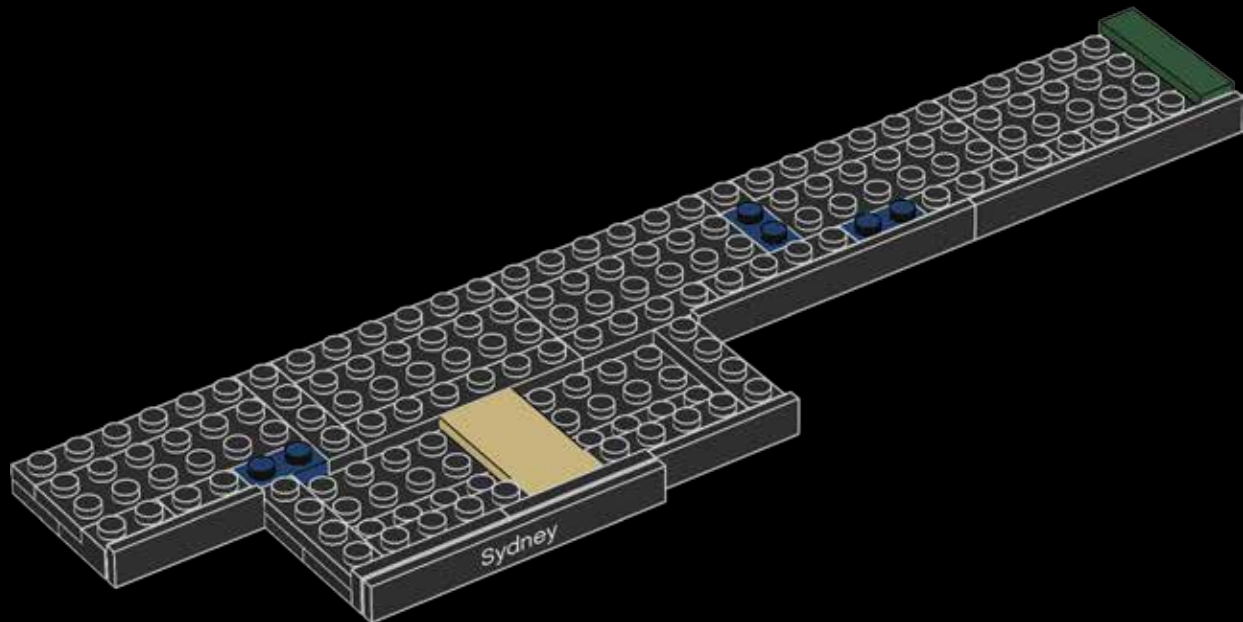
26

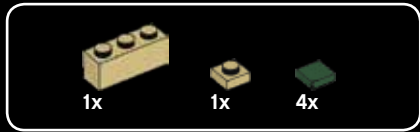


38

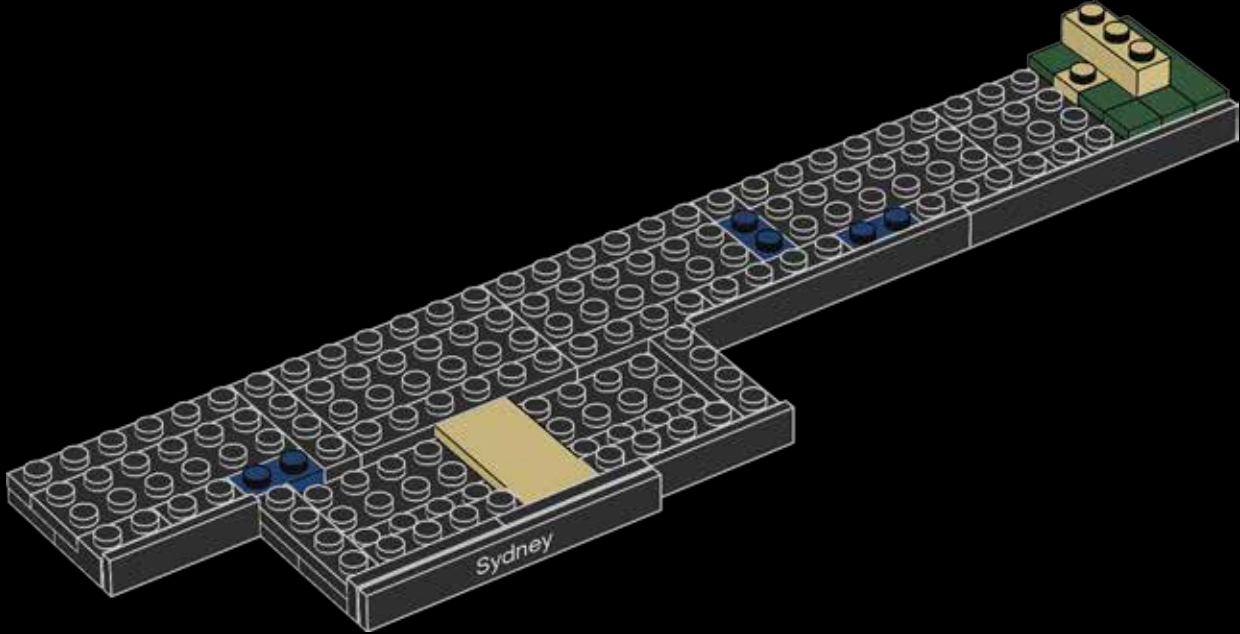


27





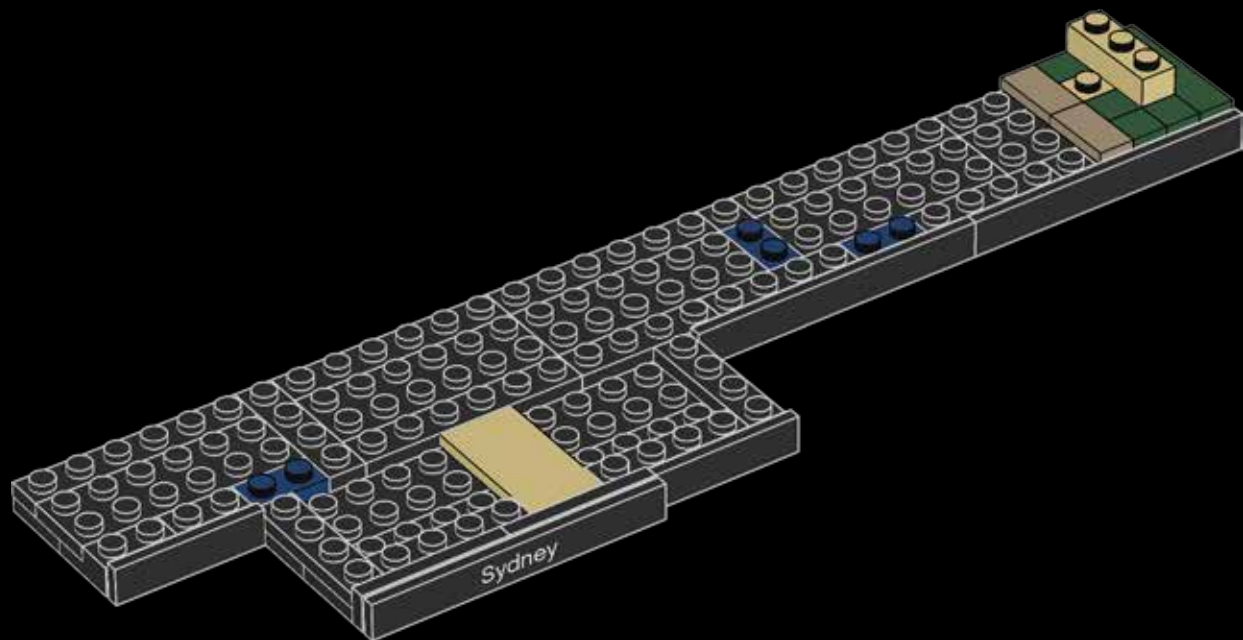
28





2x

29



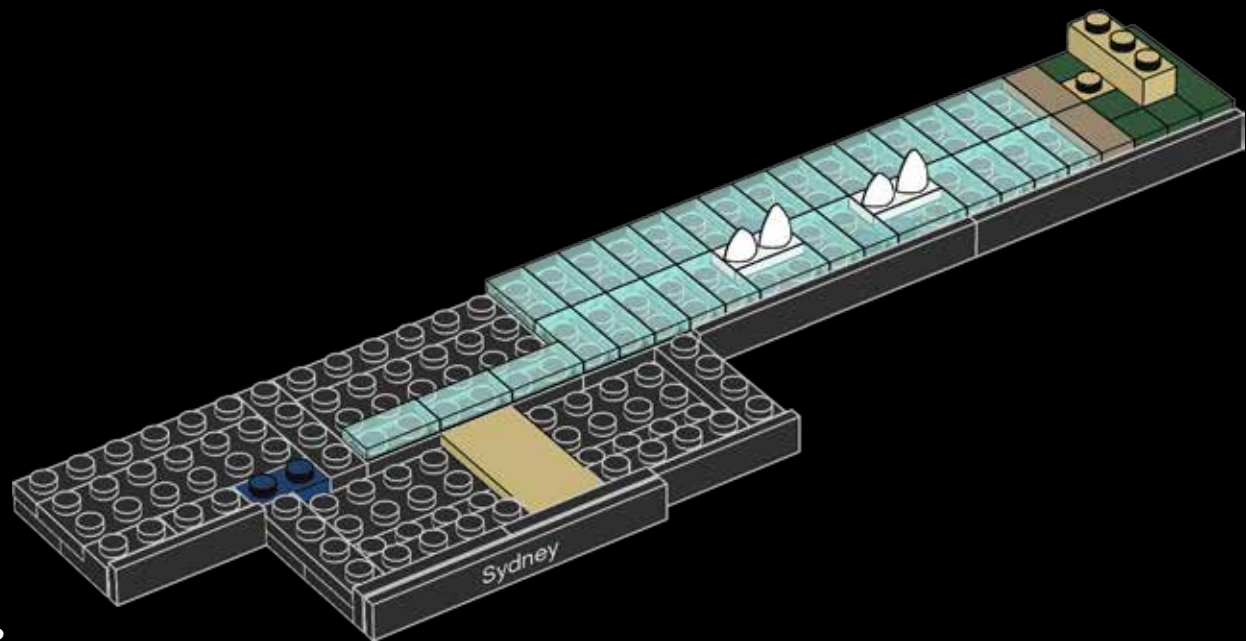


31x



2x

# 30



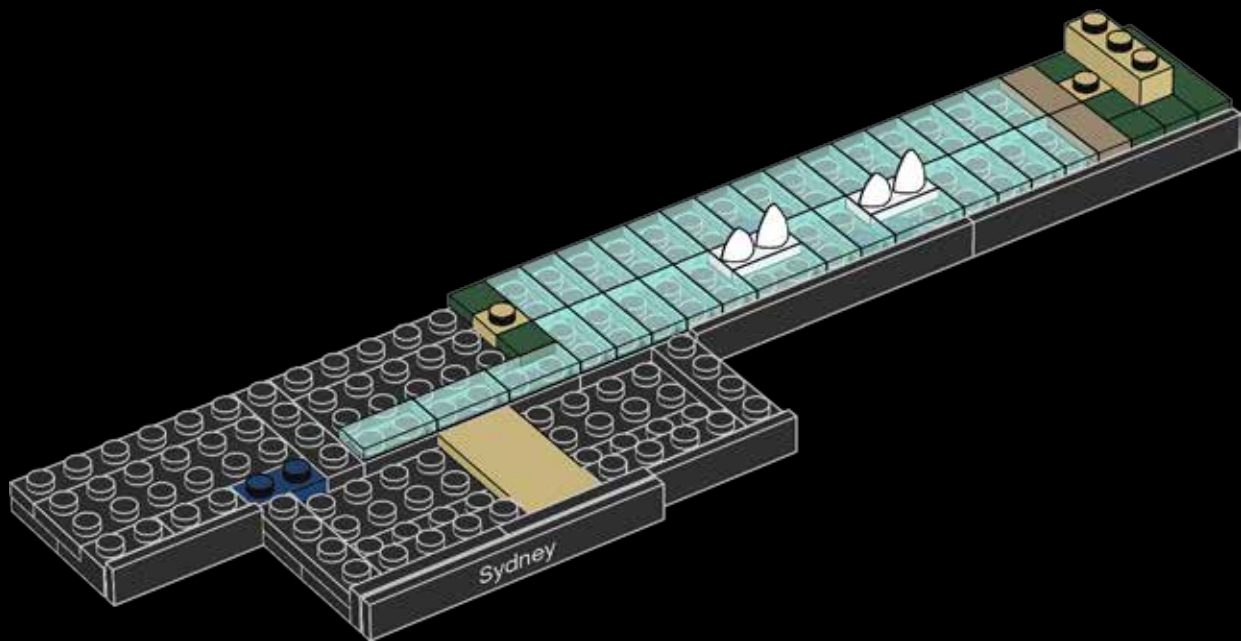


1x



2x

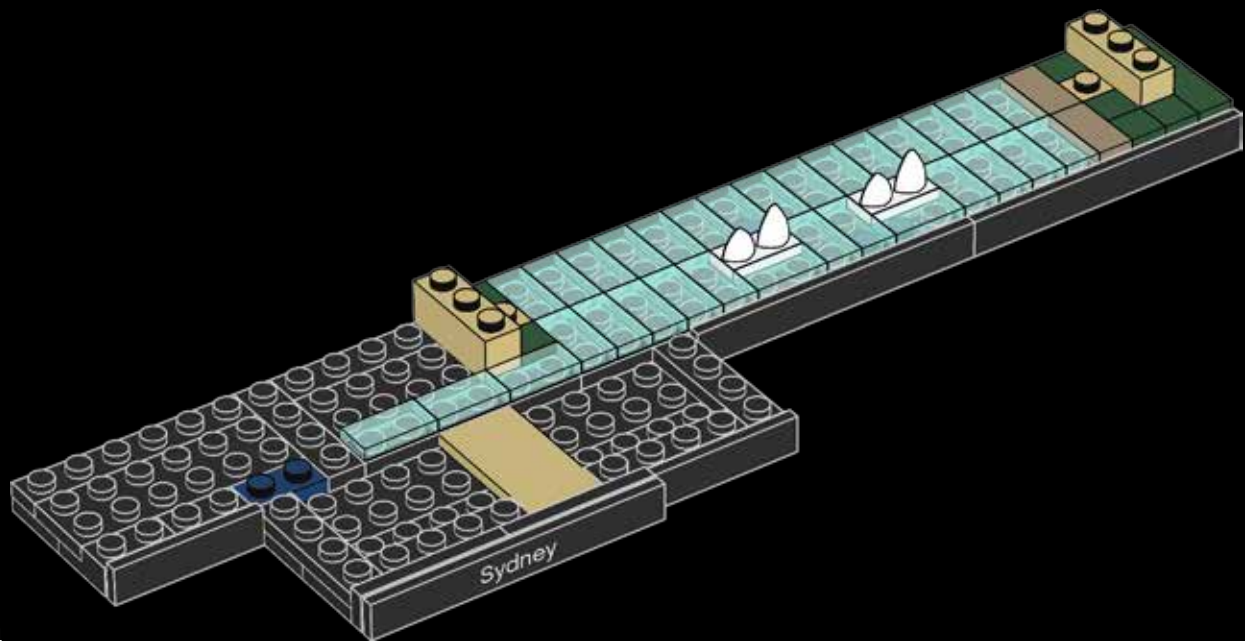
# 31





1x

32









2x

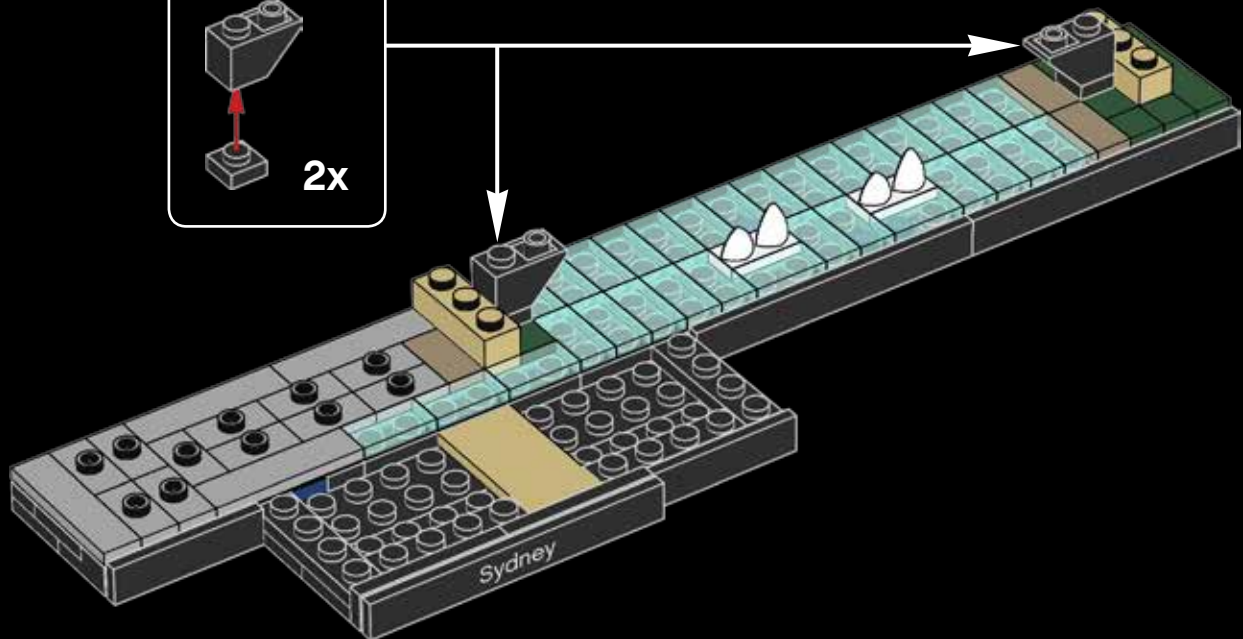


2x

34



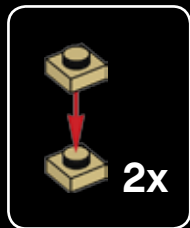
2x



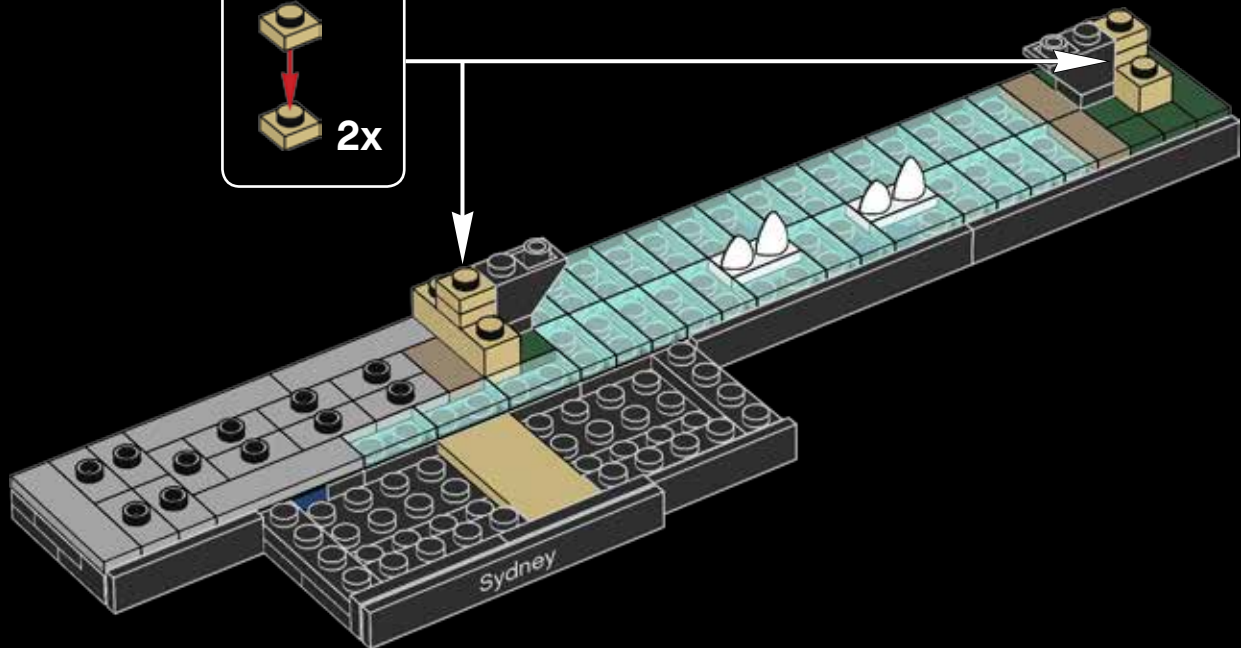


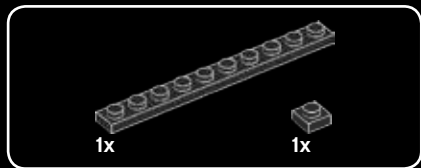
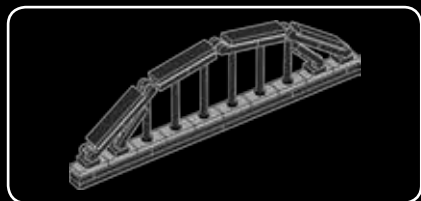
4x

35

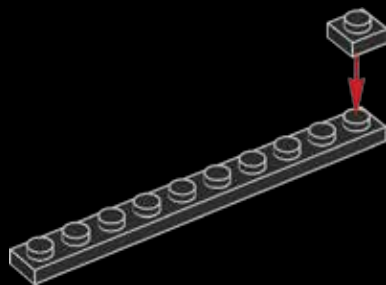


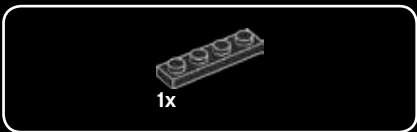
2x



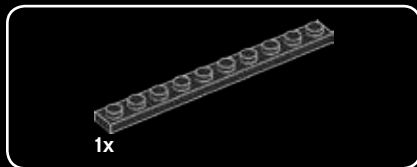
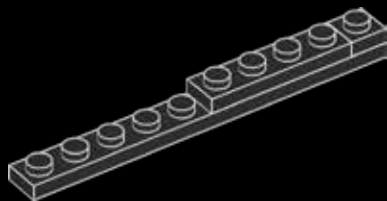


36

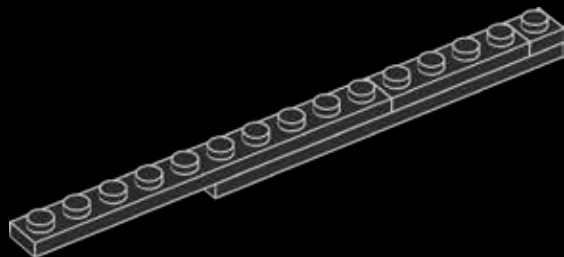


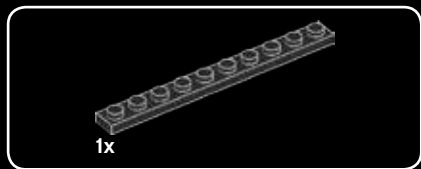


**37**

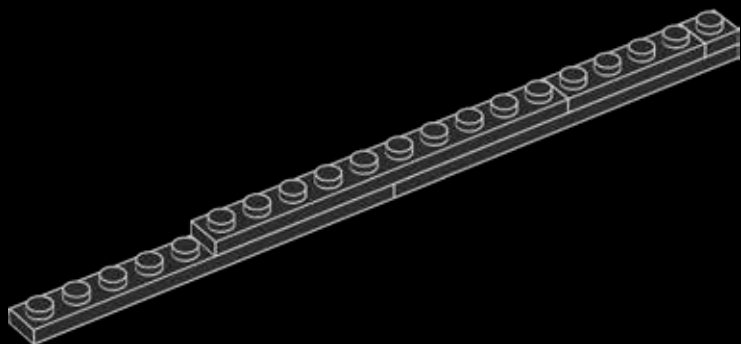


**38**





**39**



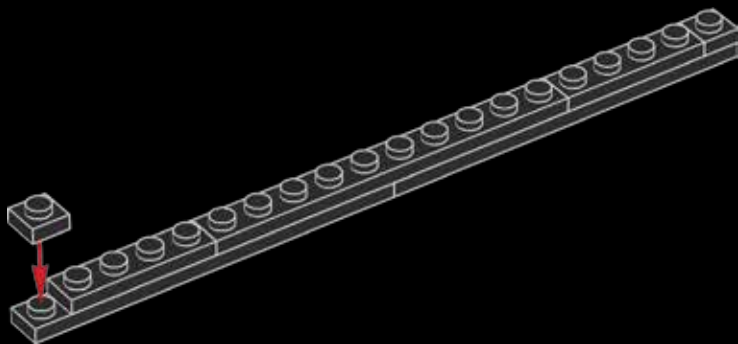


1x



1x

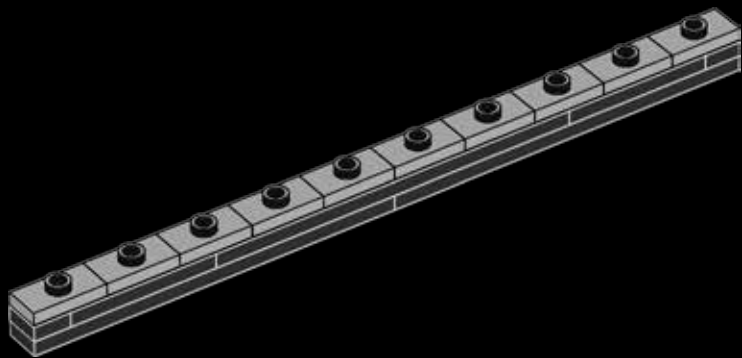
# 40





10x

41

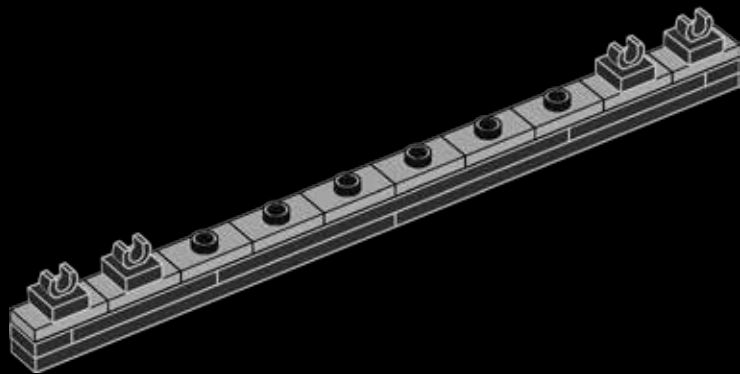


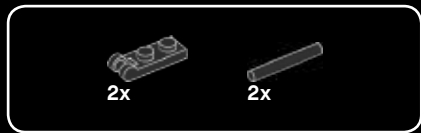




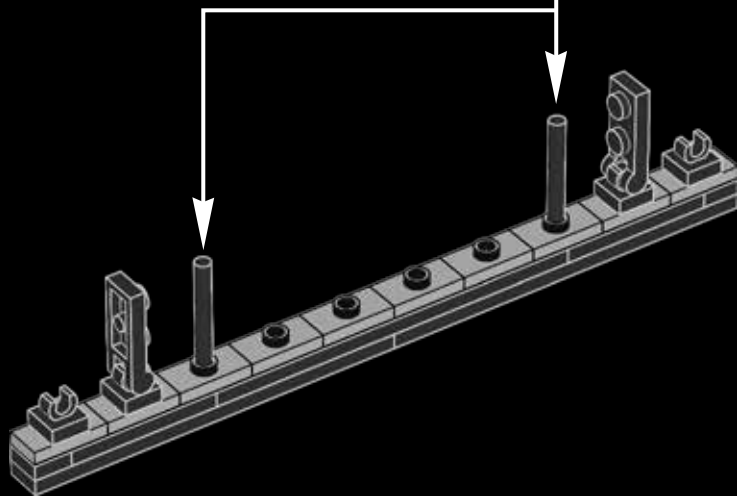
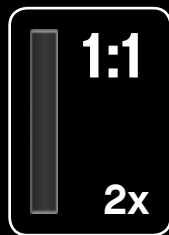
4x

42





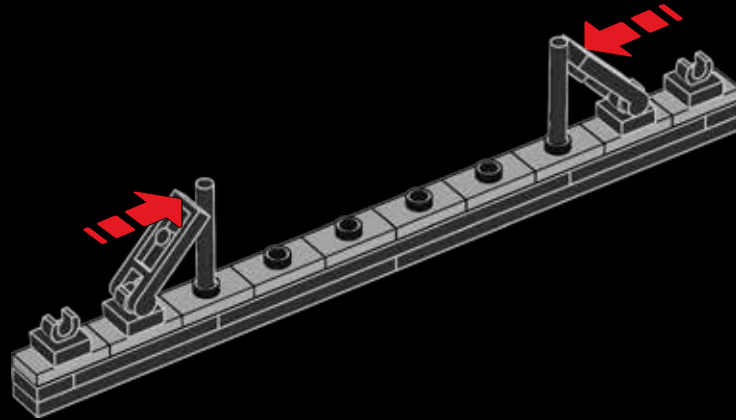
43

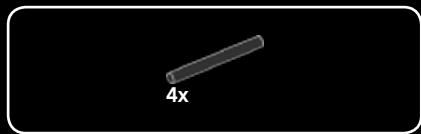


71,862 US Gallons (272,000 liters ) of paint  
were used for the first three coats of the  
bridge.

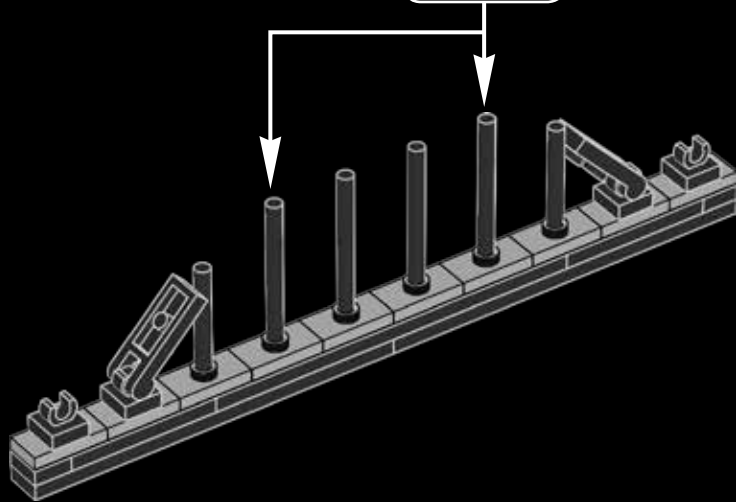
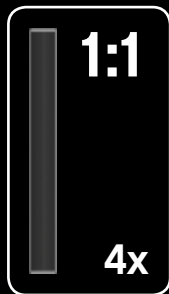


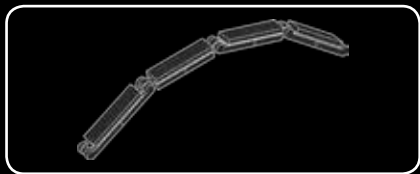
44



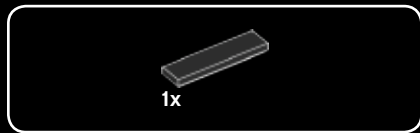


45

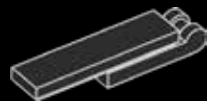




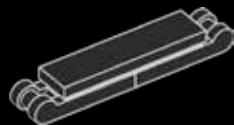
46

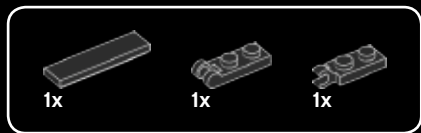


47

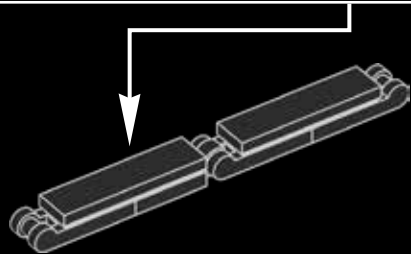
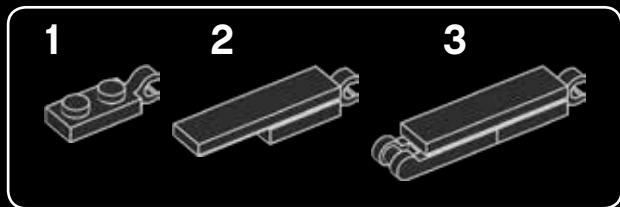


48

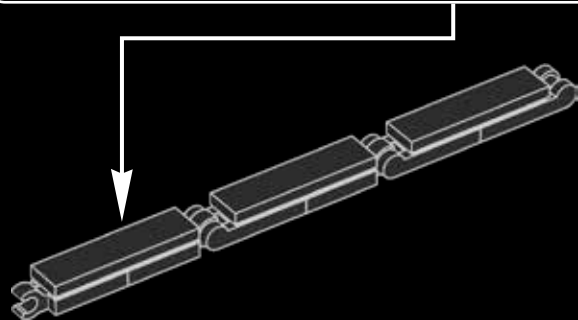
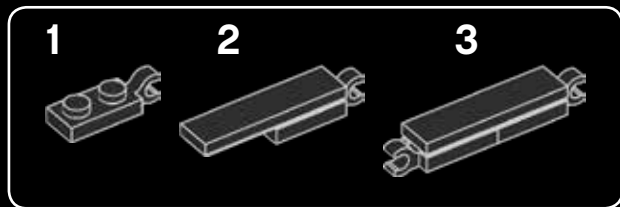




49

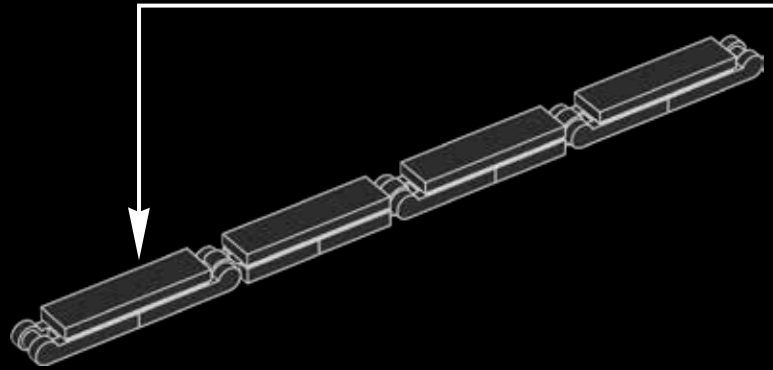
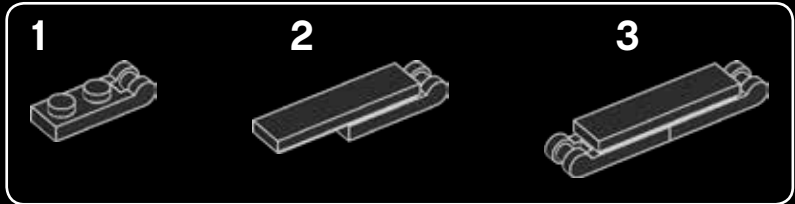


50

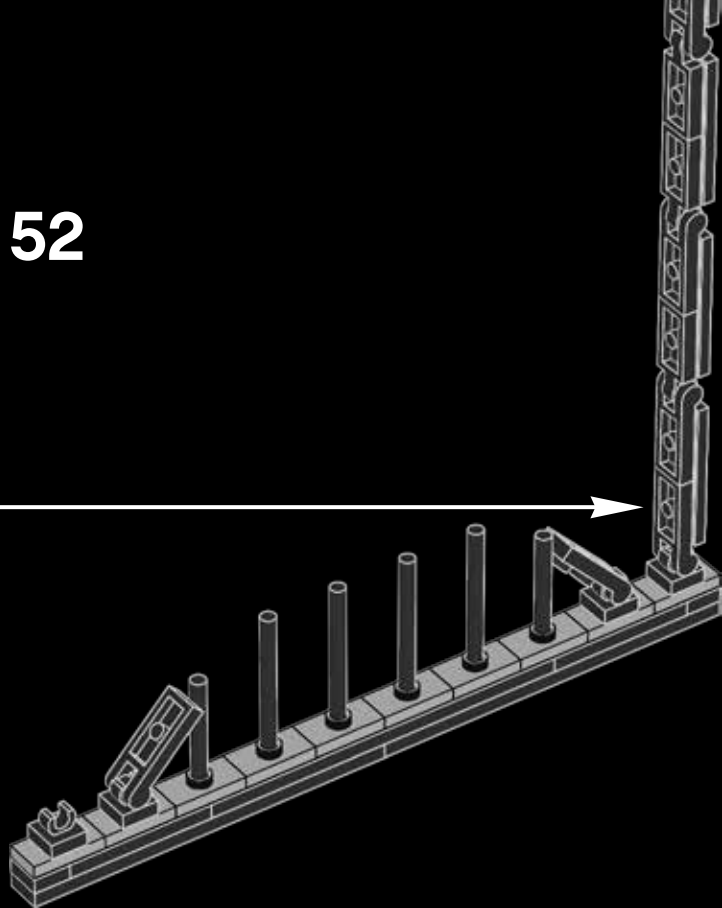




**51**



52

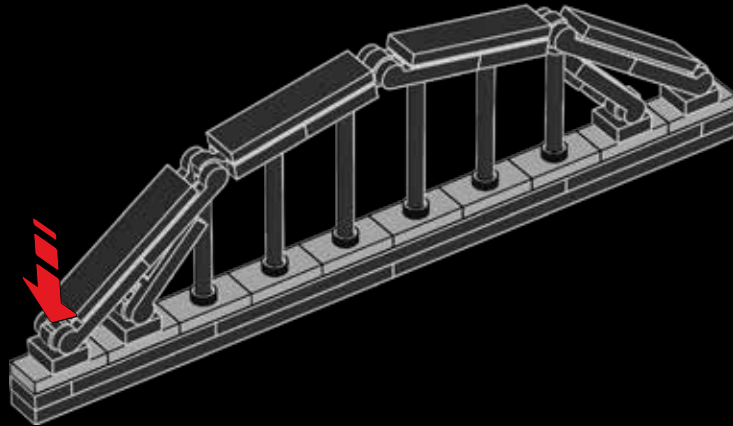




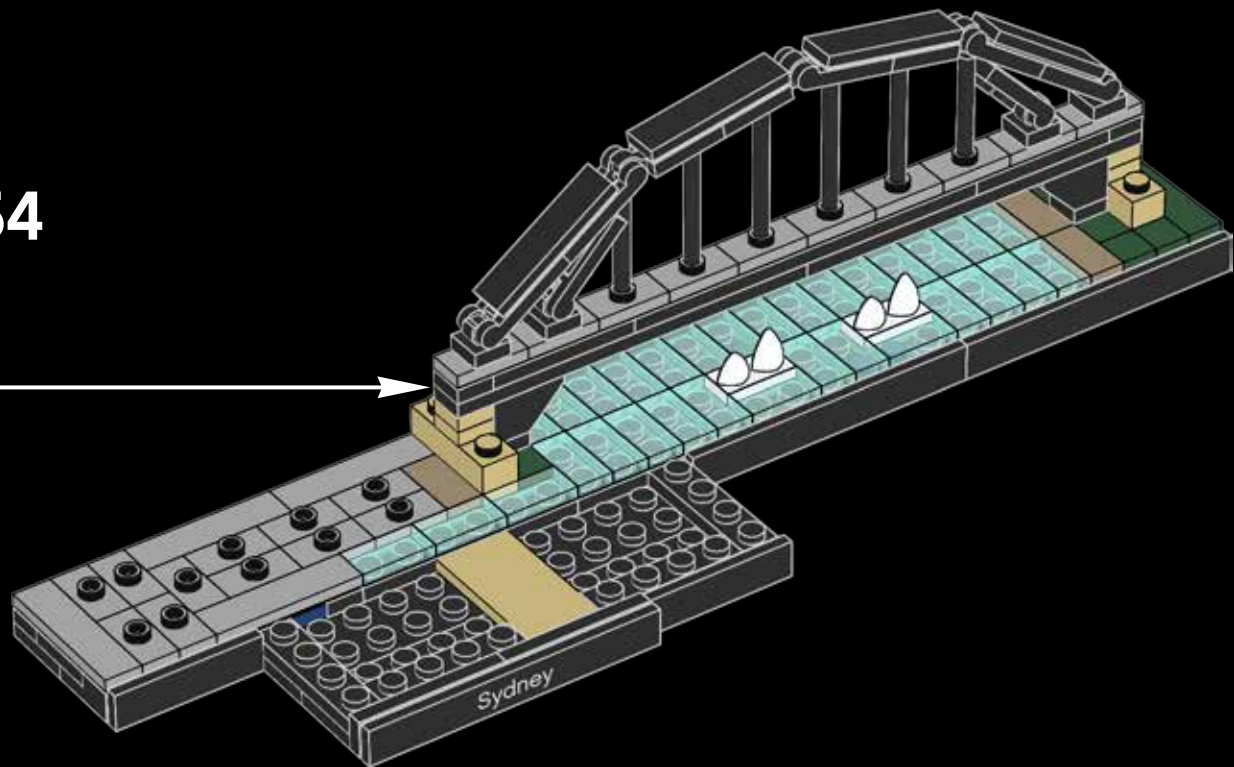
Before the bridge opened,  
96 steam locomotives were  
positioned in various ways to test  
its load capacity.



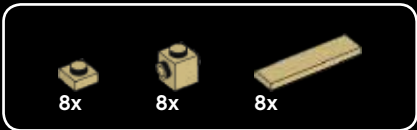
53



54



62



55

1



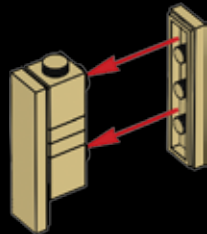
2



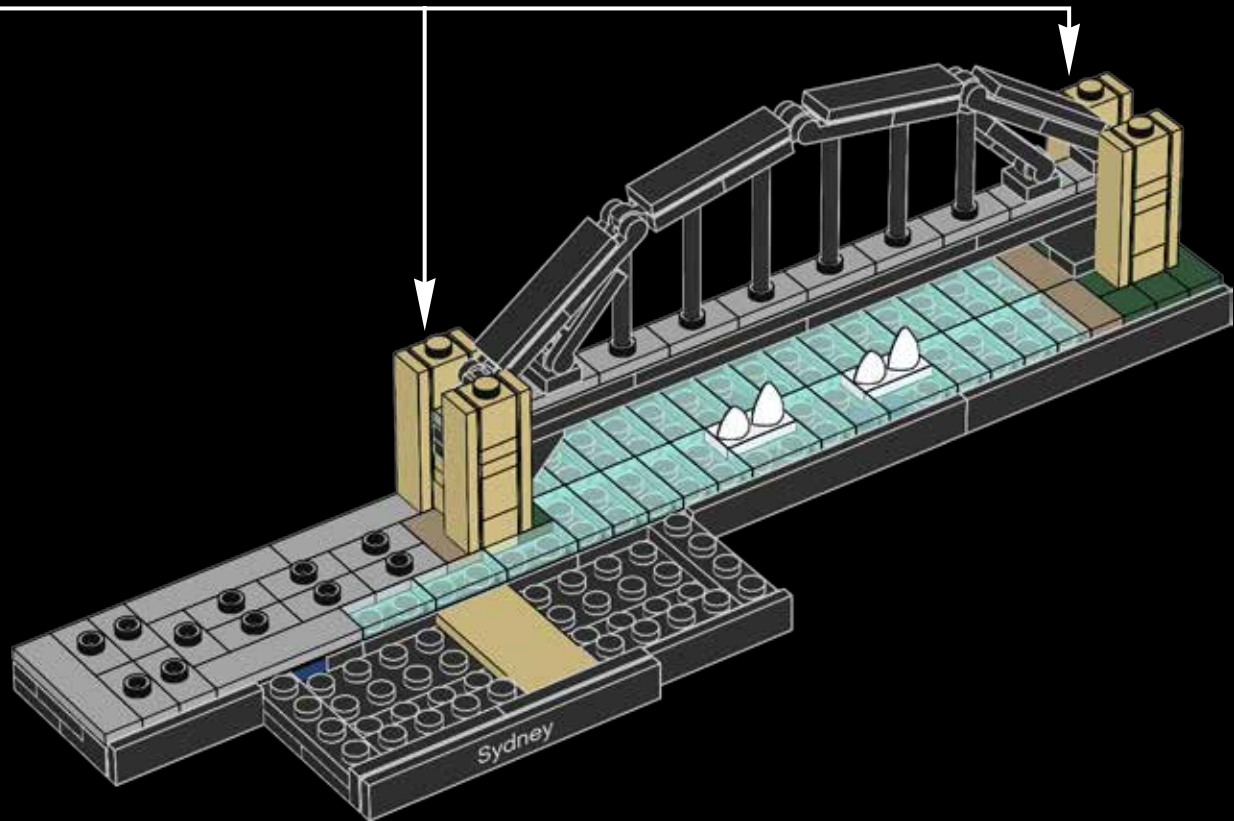
3



4



4x



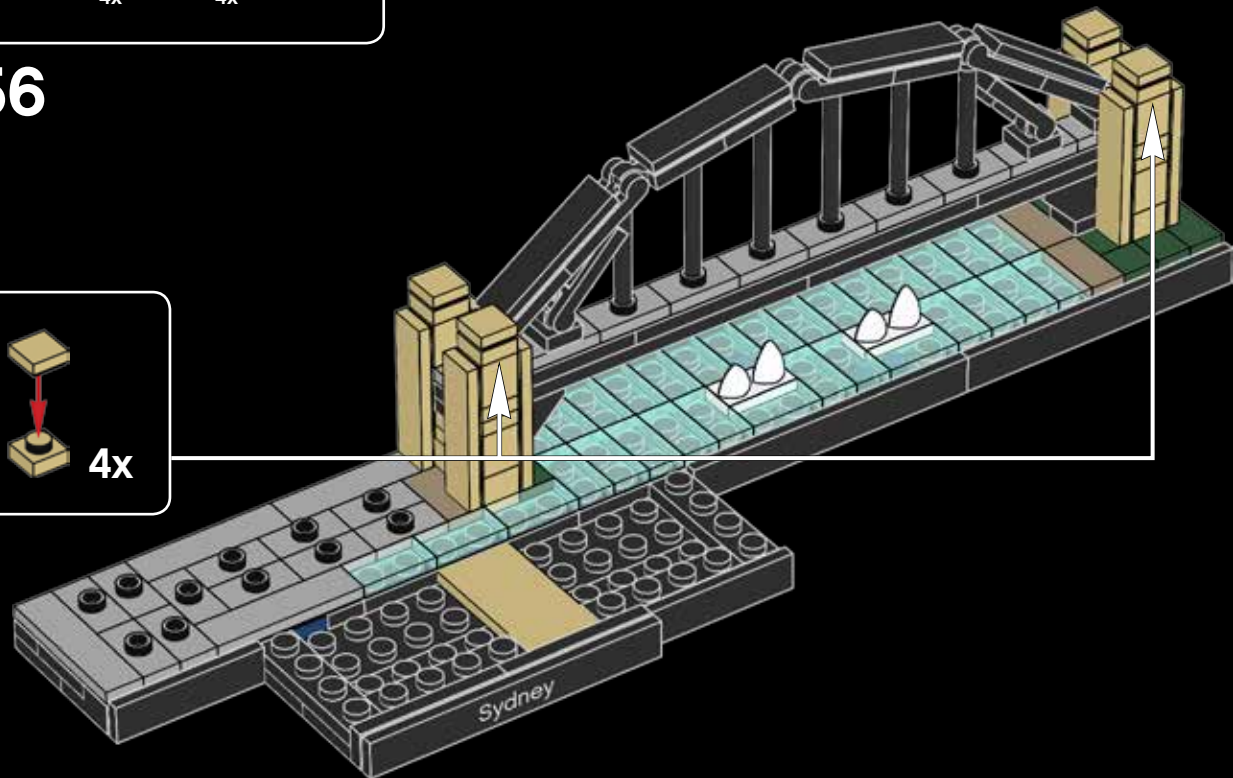


4x

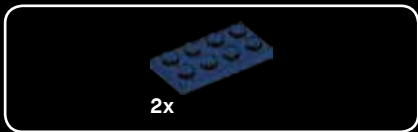
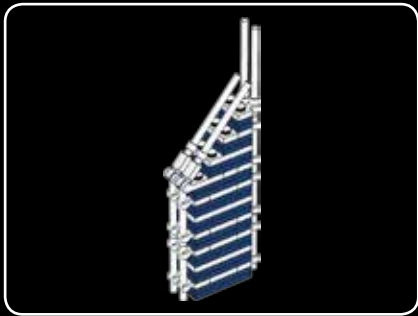


4x

# 56



4x

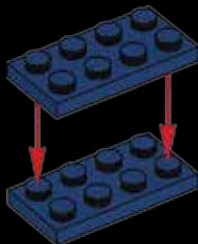


57

The building has a hollow core that provides air and light throughout the building.

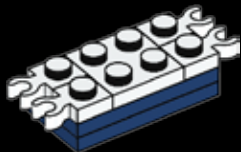


Photo courtesy of Investra

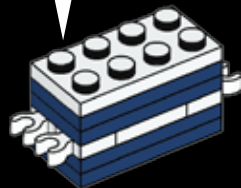
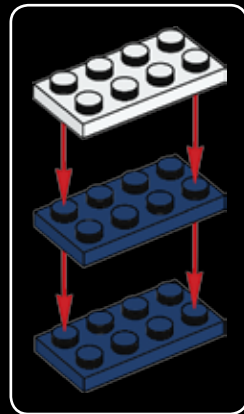




58

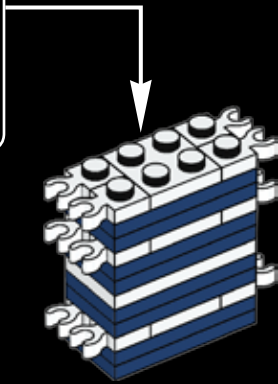
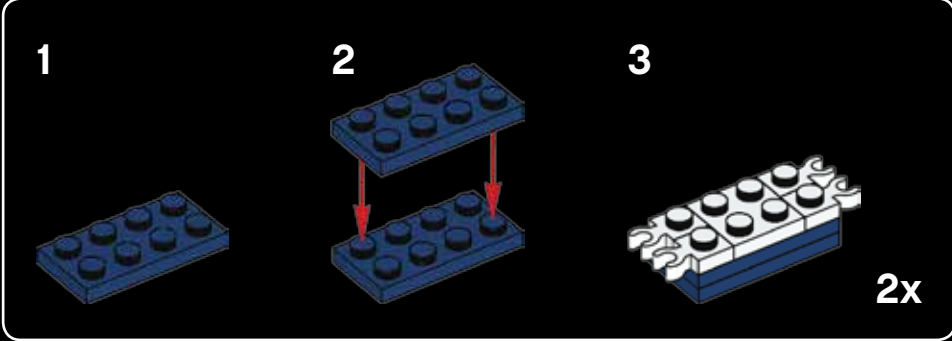


59





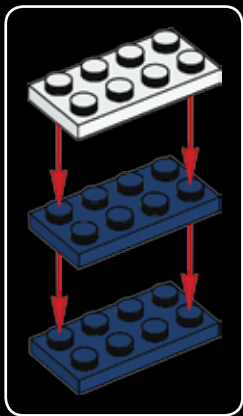
# 60





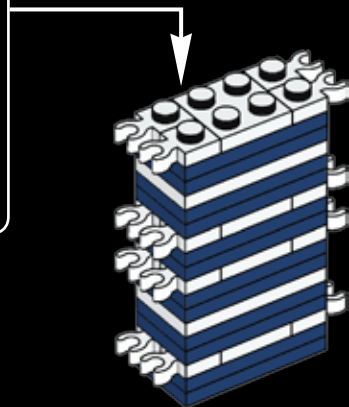
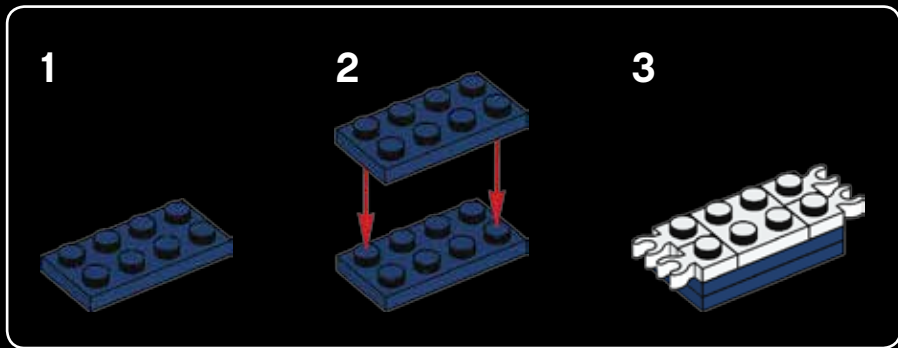


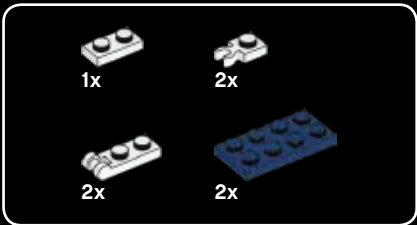
61





62



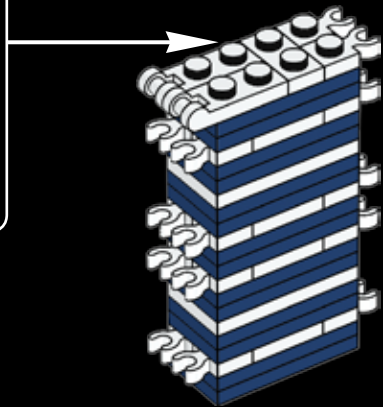
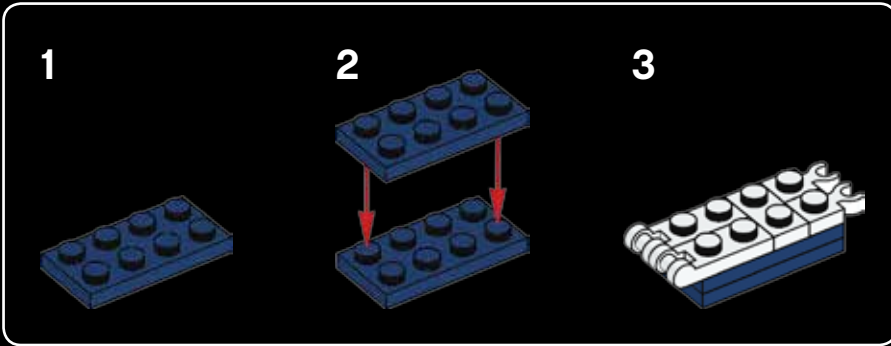


With only 39 floors, Deutsche Bank Place is the second-tallest building in the world with fewer than 40 floors.



Photo courtesy of Investia

# 63



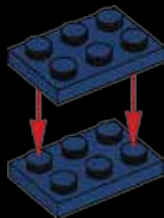


# 64

1



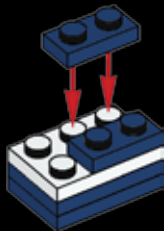
2



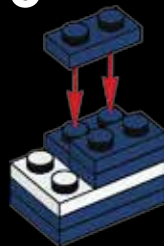
3

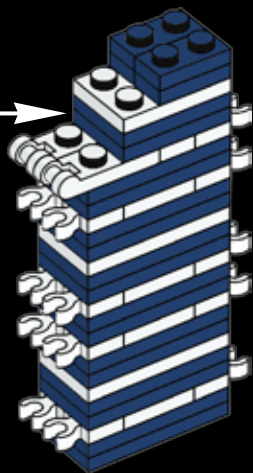


4



5



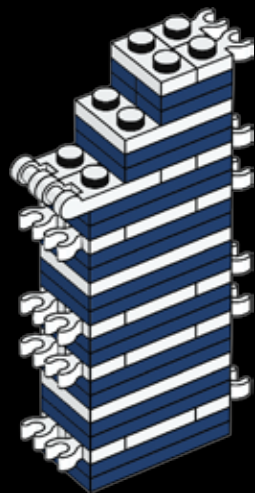


1x



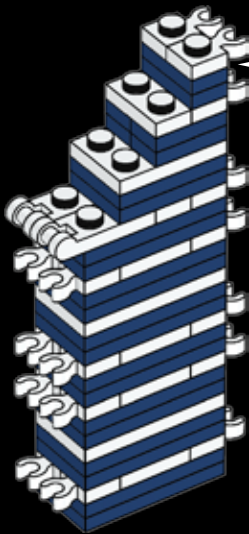
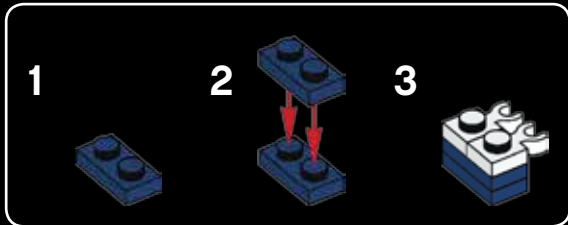
2x

# 65



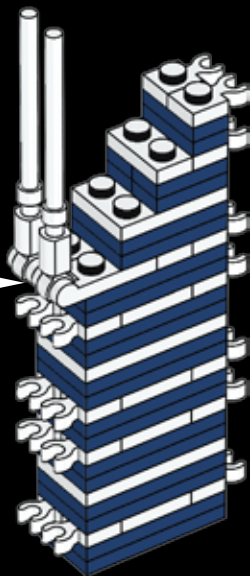
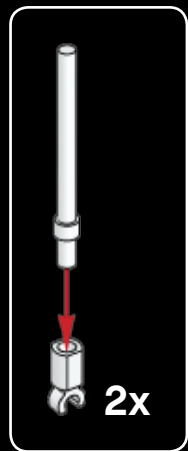


66



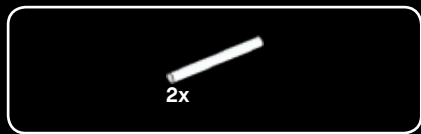


67

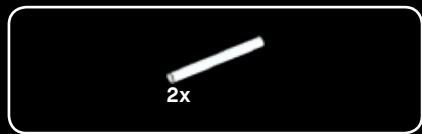
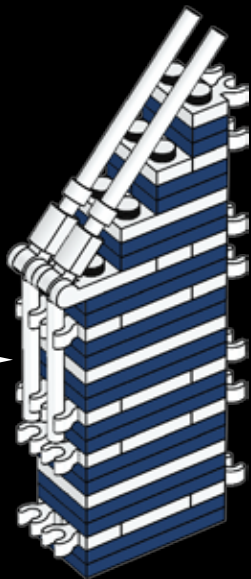
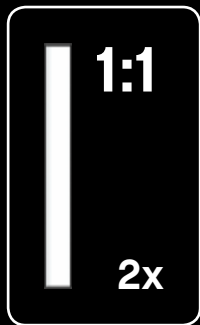


68

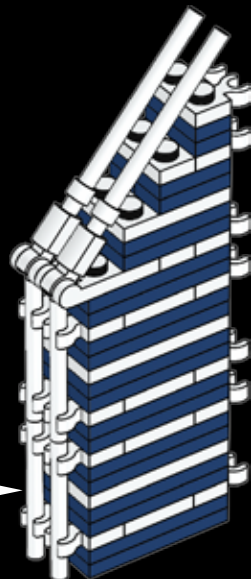
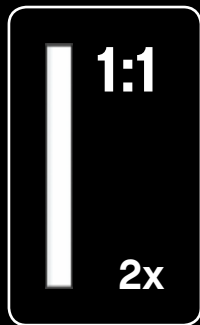




69



70







71



72





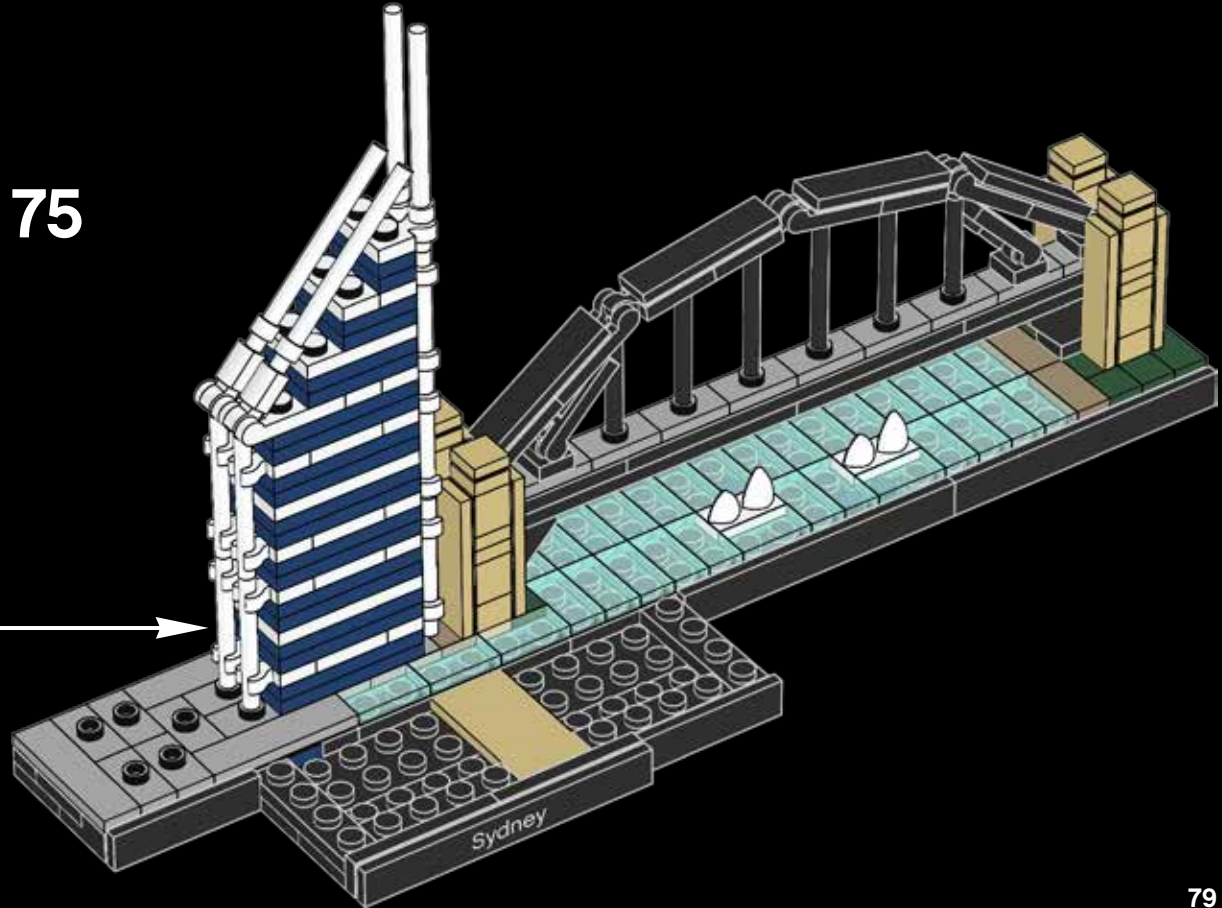
73

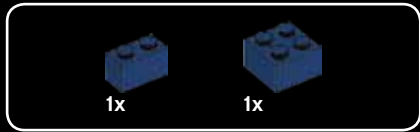


74

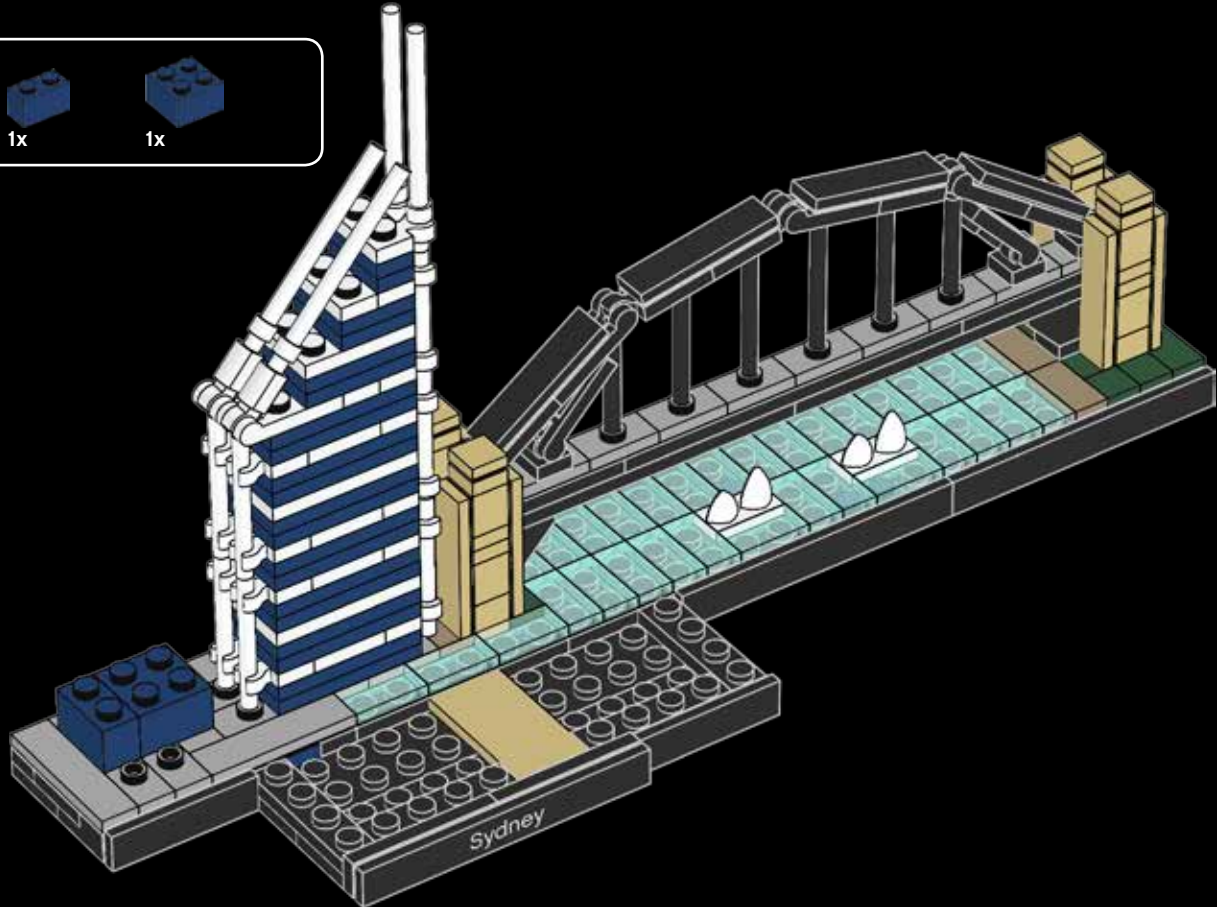


75





76





2x



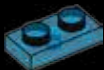
2x



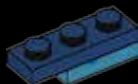
1x

# 77

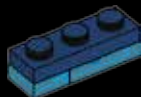
1



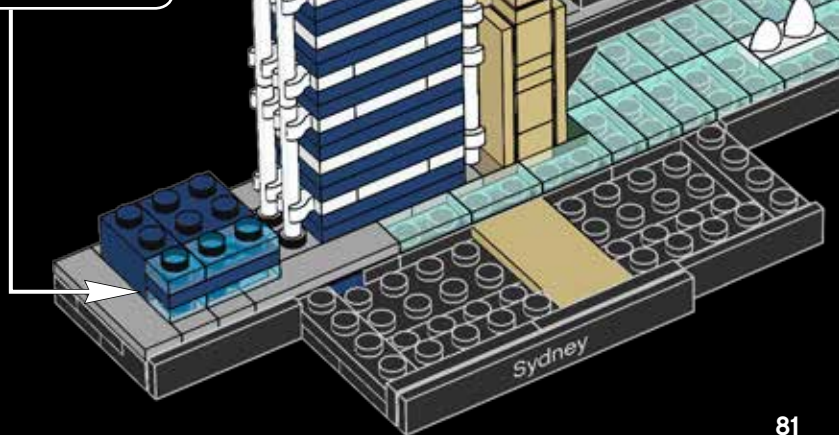
2



3



4

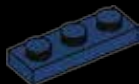




1x

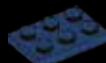


78



1x

79



1x

80





1x



1x



1x

# 81



1x

# 82



1x



1x

# 83



1x



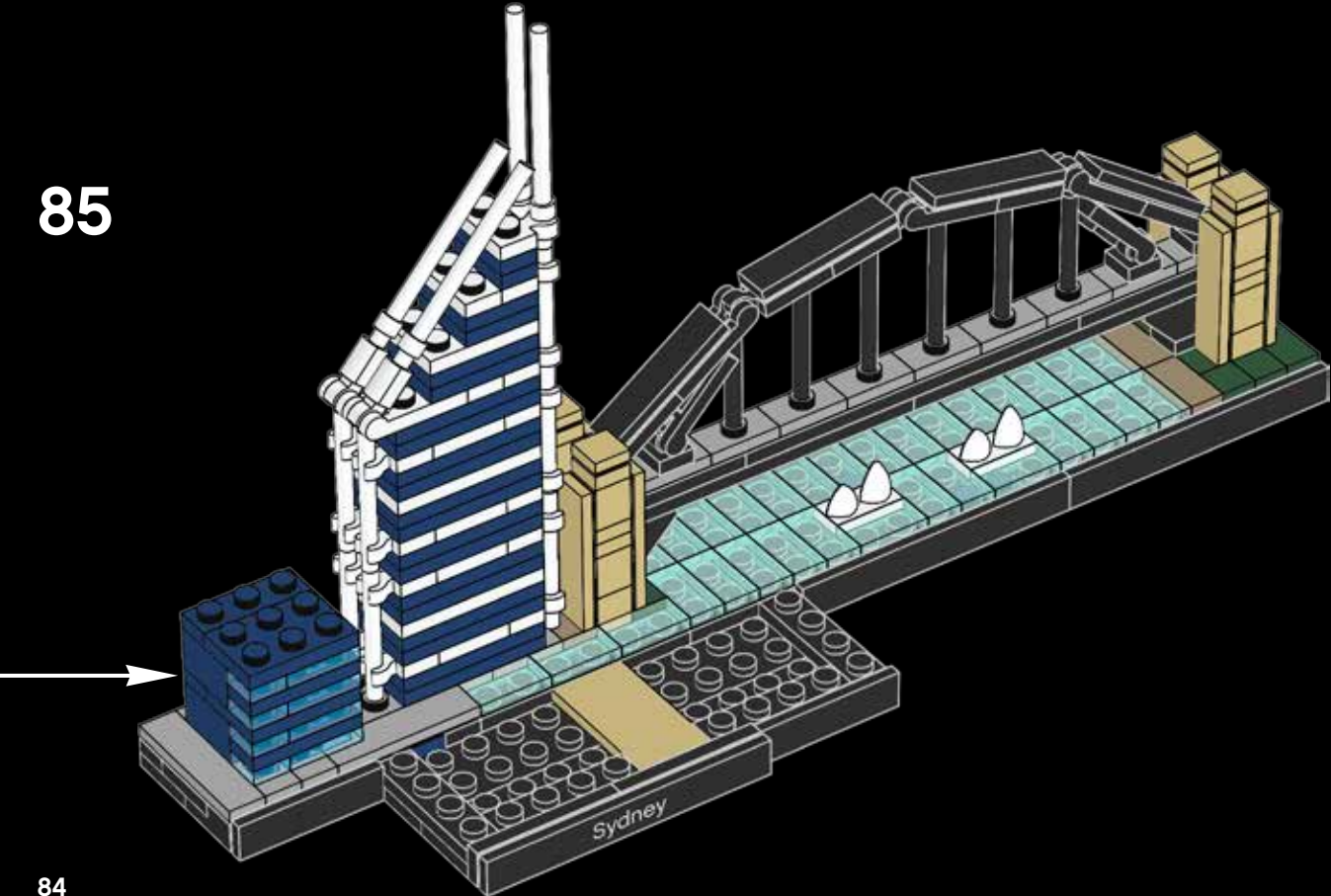
1x

# 84



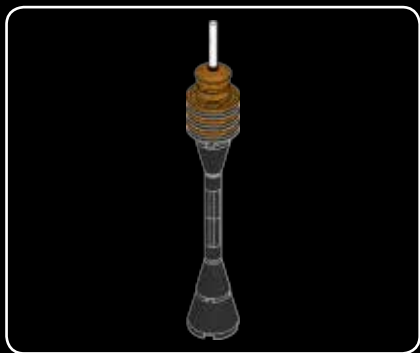


85

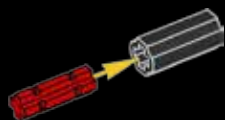


84

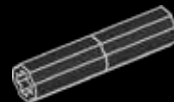




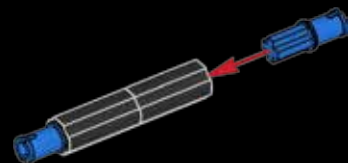
86



87



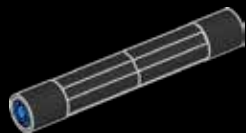
88





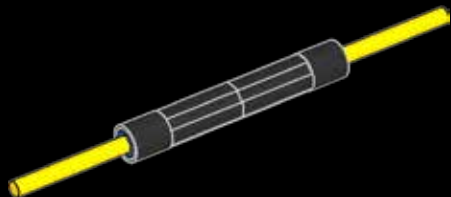
2x

89



2x

90

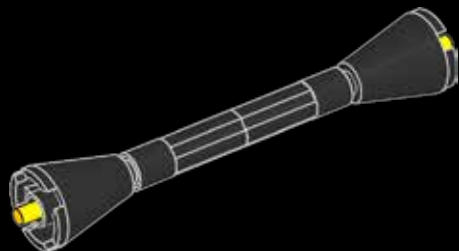


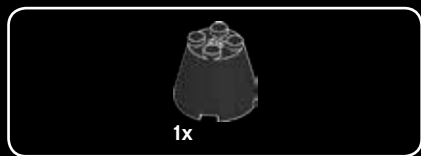
86



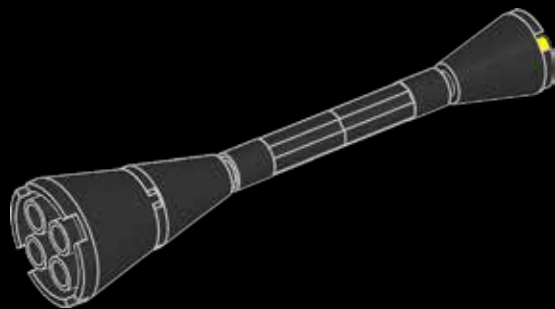
2x

91

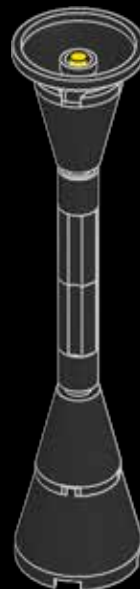




92

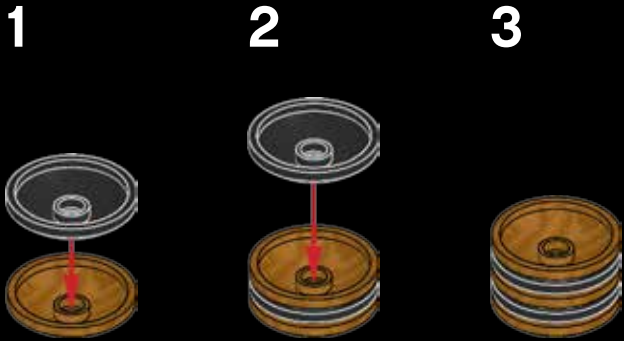


93

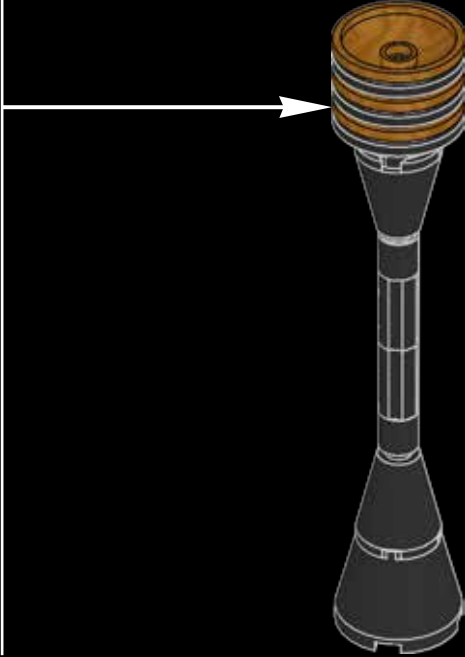




# 94



The spire located above the Tower is used for telecommunications and navigation purposes.





95

1



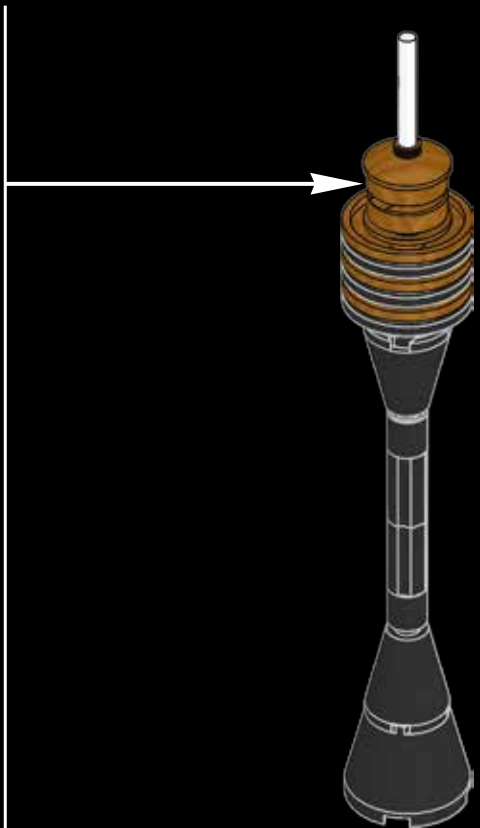
2



3



4

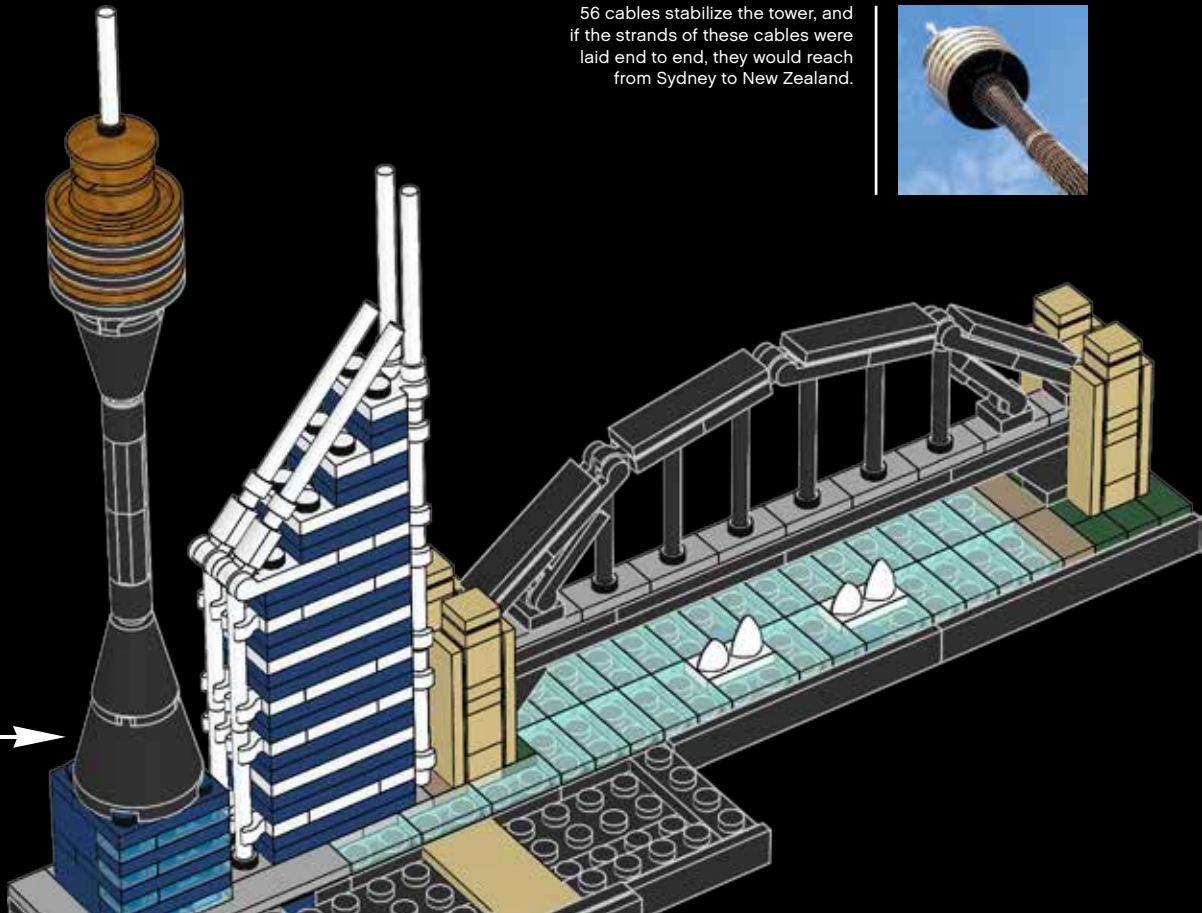


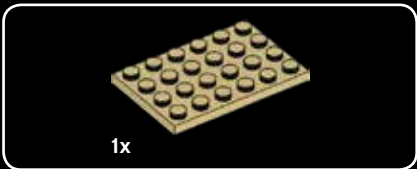
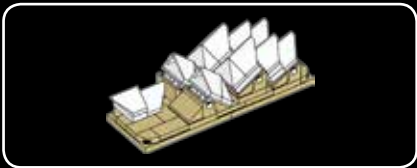
96

56 cables stabilize the tower, and if the strands of these cables were laid end to end, they would reach from Sydney to New Zealand.

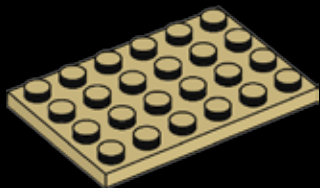


90



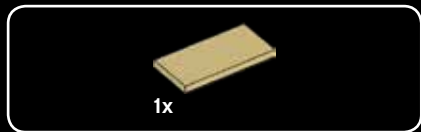


97

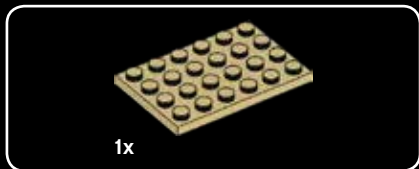


98

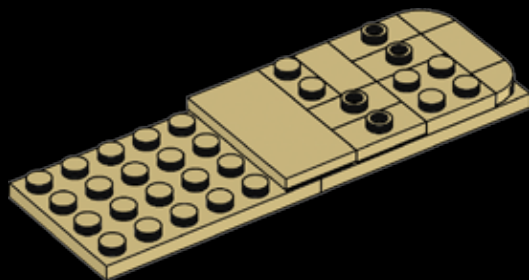




99



100







2x



3x

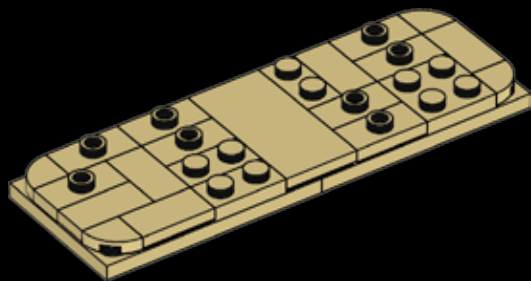


4x



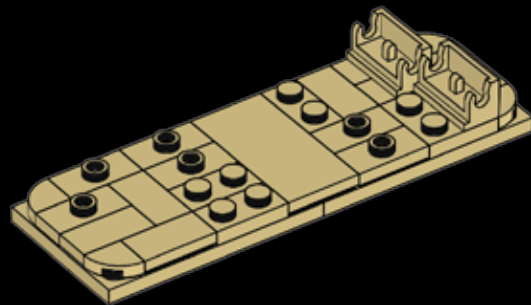
2x

# 101



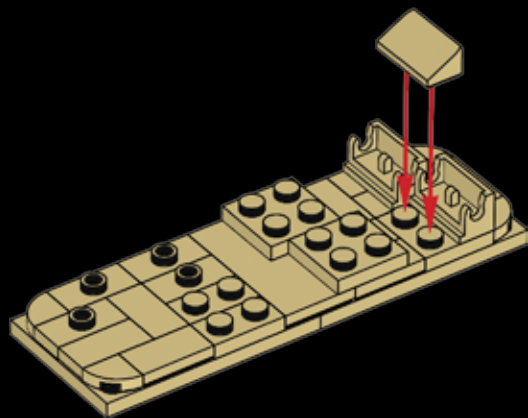
2x

# 102

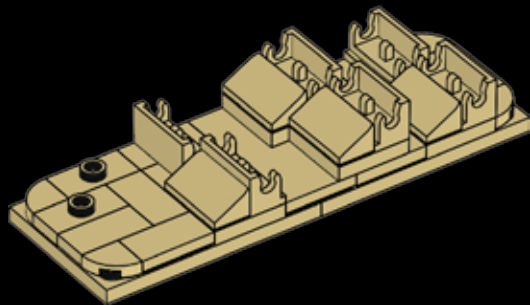




103



104





2x



2x



2x

# 105

1



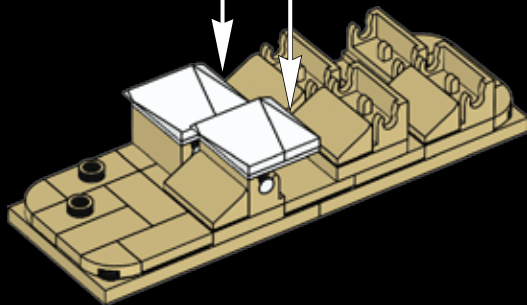
2



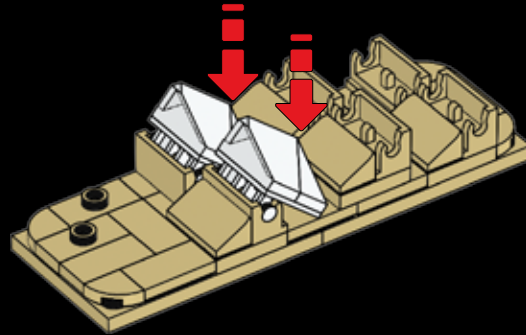
3



2x

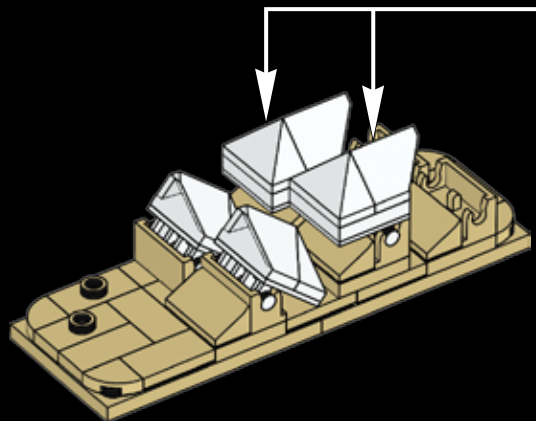
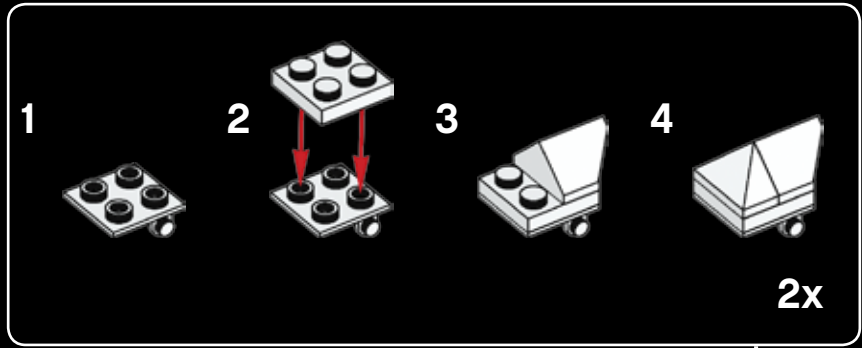


The original Architect, Jørn Utzon, was re-engaged with the project in 1999 and developed a set of design principles that act as a guide for all future development of the building.

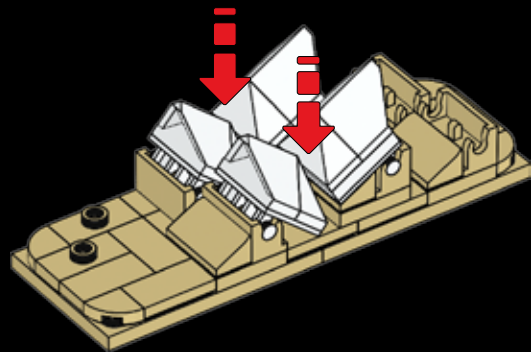




107

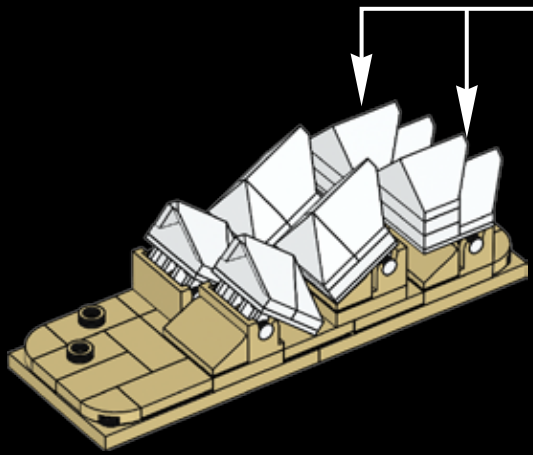
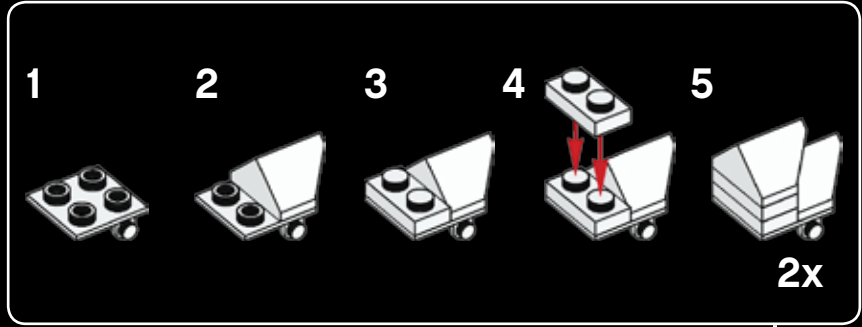


108





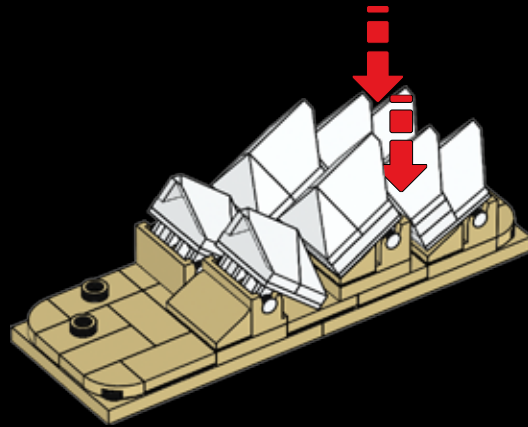
109



In 2007, the Sydney Opera House became the youngest cultural site to ever be included on the World Heritage List and one of only two cultural sites to be listed during the lifetime of its architect, Jørn Utzon (1918-2008).



110





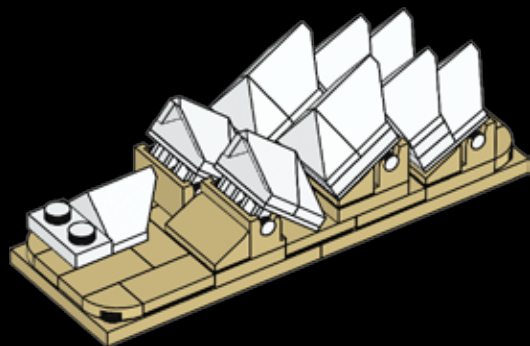


1x



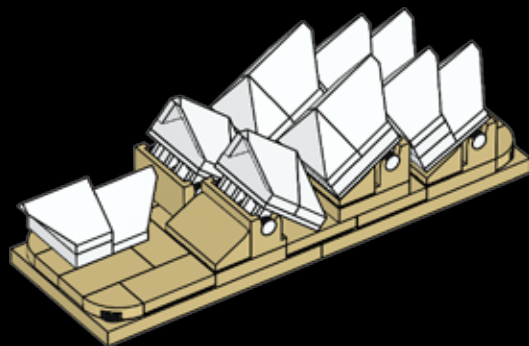
1x

# 111

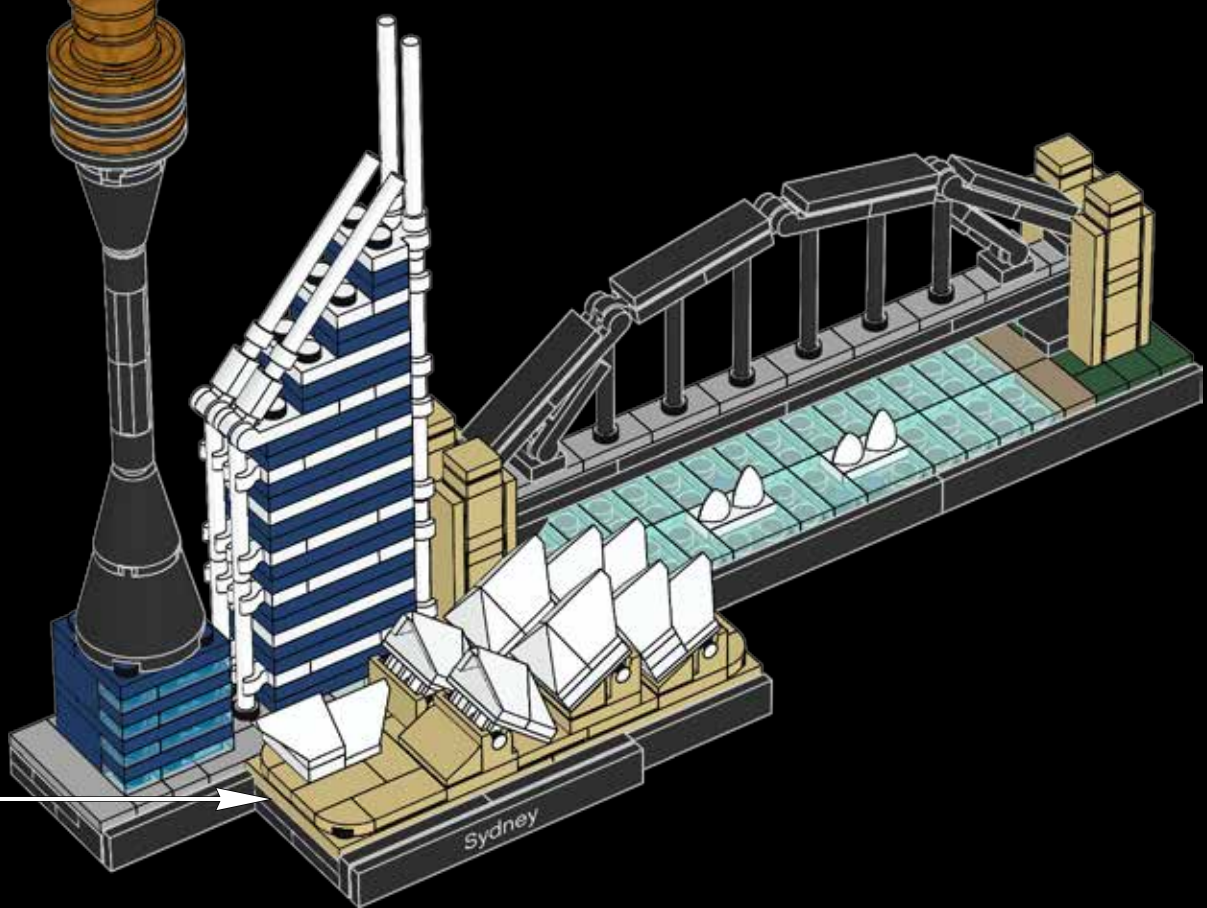


1x

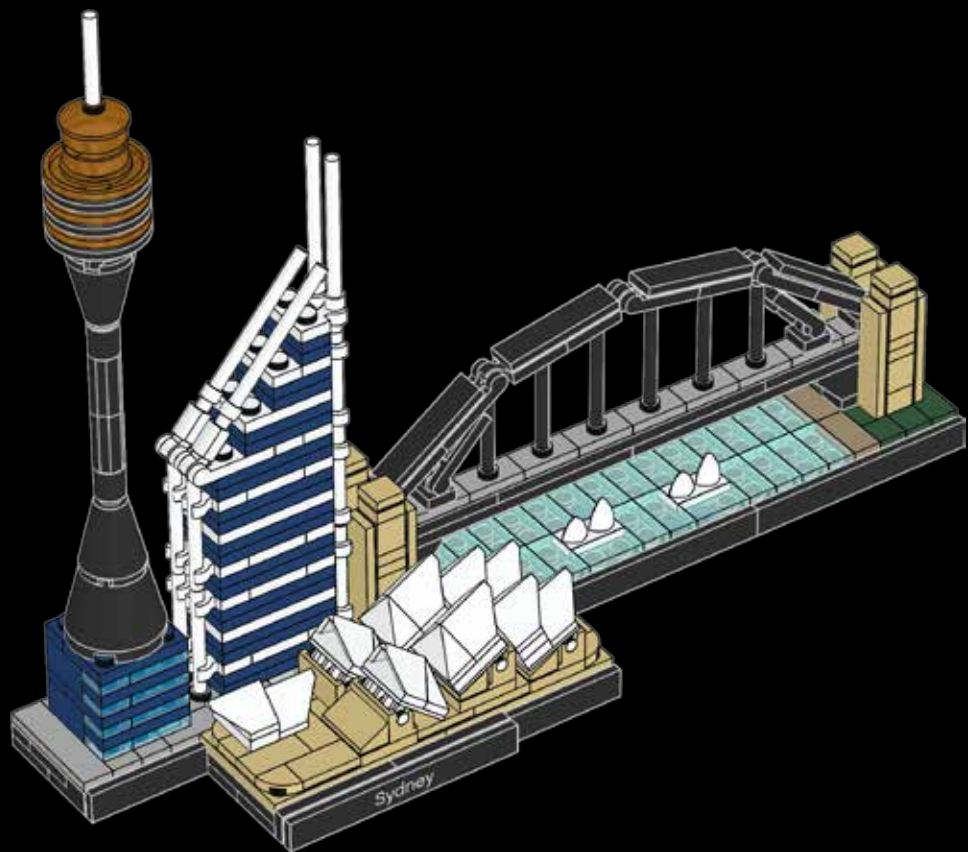
# 112



113



102





# LEGO® Architecture – do you like it?

The LEGO Group would like your opinion on the new product you have just purchased. Your feedback will help shape the future development of this product series. Please visit:

**[LEGO.com/productsurvey](https://www.lego.com/productsurvey)**

By completing our short feedback survey, you will be automatically entered into a draw to win a LEGO® prize.



See website for official rules and details. Open to all countries where not prohibited.

LEGO and the LEGO logo are trademarks of the/sont des marques de commerce du/son marcas registradas de LEGO Group. ©2017 The LEGO Group.

# LEGO® Architecture—then and now

There has always been a natural connection between the LEGO® brick and the world of architecture. Fans who build with LEGO elements instinctively develop an interest in the form and function of the structures they create. At the same time, many architects have discovered that LEGO bricks are the perfect way of physically expressing their creative ideas.

This connection was confirmed in the early 1960s with the launch of the LEGO 'Scale Model' line. It matched the spirit of the age where modern architects were redefining how houses look and people were taking an active interest in the design of their new homes. These sets were designed to be different from the normal, brightly colored LEGO boxes; they also included a book on architecture as a source of inspiration.

Decades later, architect and LEGO fan Adam Reed Tucker, revived the idea of expressing architecture using LEGO bricks and in partnership with the LEGO Group, launched the LEGO Architecture line that we know today.

His first models, and the original sets in the current LEGO Architecture series, were interpretations of famous skyscrapers from his hometown of Chicago. Since then LEGO Architecture has developed and evolved, first with well-known buildings from other cities in the United States, and now with iconic structures from Europe, the Middle East and Asia.

The introduction of our LEGO Architecture Studio set echoes the ambitions of the earlier LEGO 'Scale Model' line and widens the potential of the LEGO Architecture series. Now you can enjoy building and learning about specific landmark buildings, or create exciting architectural models from your own fantasy. An inspiring 270-page book, featuring a number of renowned architects from around the world, guides you through the principles of architecture and encourages you in your own creative building.



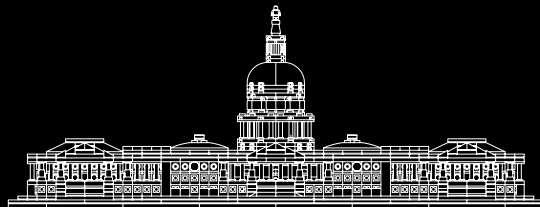


21050  
Studio

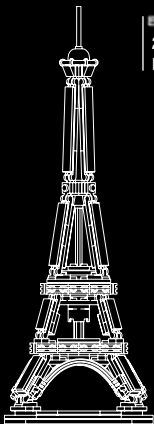
# Celebrate the world of architecture and collect all the models



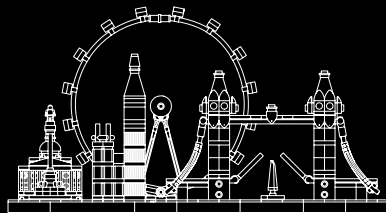
21024  
Louvre



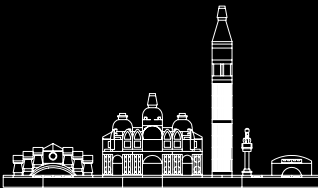
21030  
United States Capitol Building



21019  
The Eiffel Tower

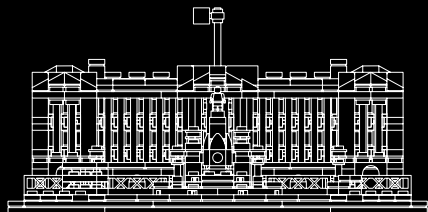


21034  
London

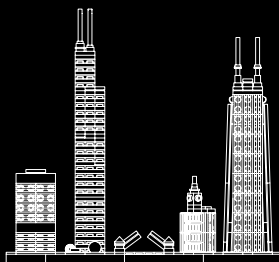


21026  
Venice





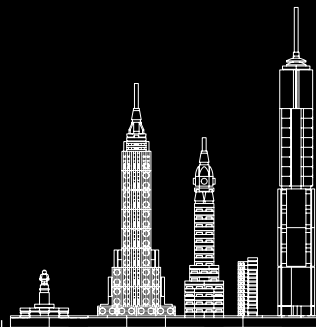
21029  
Buckingham Palace



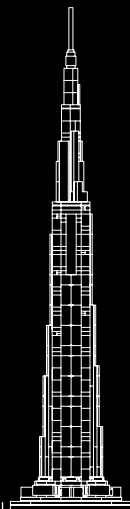
21033  
Chicago



21027  
Berlin



21028  
New York City



21031  
Burj Khalifa

# References

*Pictures -*

© Shutterstock

Michael Moy

Ralph Alphonso

*Text -*

[www.sydneyoperahouse.com](http://www.sydneyoperahouse.com)

[www.sydneyharbourbridge.info](http://www.sydneyharbourbridge.info)

[www.sydneytowereye.com.au](http://www.sydneytowereye.com.au)

[www.fosterandpartners.com](http://www.fosterandpartners.com)

[www.sydneylivingmuseums.com.au](http://www.sydneylivingmuseums.com.au)

Customer Service

Kundenservice



Service Consommateurs














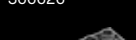







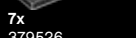



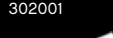











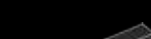







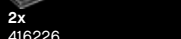











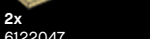
















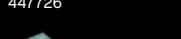

Servicio Al Consumidor

LEGO.com/service or dial



00800 5346 5555 :     

1-800-422-5346 :  

 2x 6052824	 8x 6116602	 5x 4114026	 2x 4206482	 4x 302226	 6x 366626	 4x 4266417	 1x 4543949
 22x 4613256	 1x 302101	 8x 6092587	 2x 6116606	 4x 6052126	 7x 379526	 4x 4260426	 21x 6066097
 4x 6097801	 2x 302001	 3x 4113917	 2x 6121485	 7x 4515368	 4x 4653049	 3x 4496699	 4x 4211356
 10x 6059271	 5x 6081986	 3x 4114084	 4x 6066102	 1x 4500978	 2x 416226	 2x 4249891	 2x 6078236
 2x 6046384	 4x 6145570	 2x 4162465	 6x 302426	 3x 4180087	 2x 416226	 9x 4528981	 1x 6189102
 7x 302301	 18x 4159553	 8x 4550324	 2x 6092664	 1x 6174627	 2x 395826	 2x 4296785	 3x 6189071
 2x 6093526	 4x 4125253	 2x 6122047	 2x 4512363	 4x 6116604	 3x 447726	 4x 4177735	
 6x 302201	 8x 4213568	 2x 4114001	 2x 366526	 6x 243126	 31x 4667222	 4x 4530028	
 6x 4612342	 4x 4624086	 2x 4114001	 3x 4535739	 8x 371026	 3x 447726	 14x 4667595	
 2x 4515364	 6x 6174919	 1x 4142865	 2x 6093525	 8x 371026	 31x 4667222	 6x 6055171	

