



Disney

40307



LEGO.com/disney

1



2



3



4





1



2



1



2



1



2



1



1



1



2



2



2



1



2



1

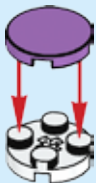

2



1

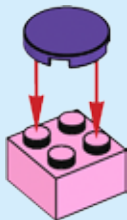

2

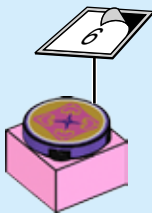

1

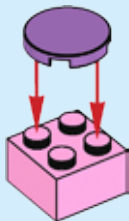

2



1



2





1

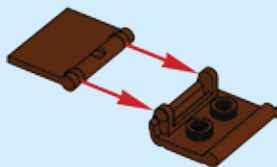

2



3





1



2



3

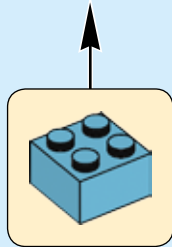



1



2



3



4

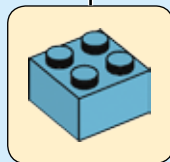

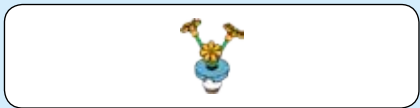

1

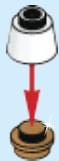

2



3



4





1

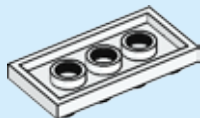

2



3

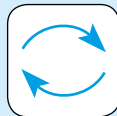

4



5

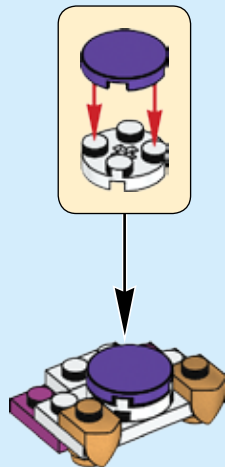

6

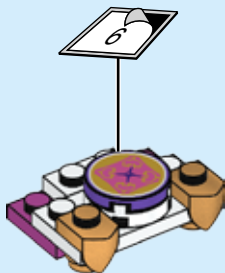

7



8

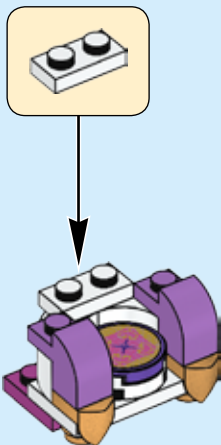

9

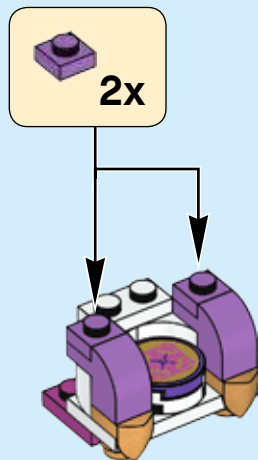

10

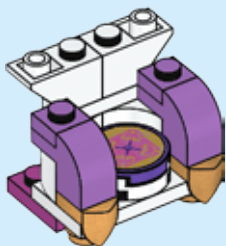

11

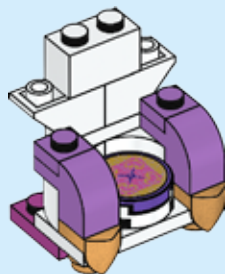

12

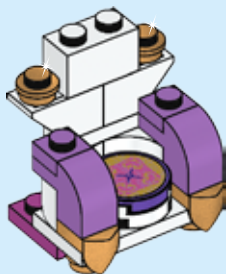

13

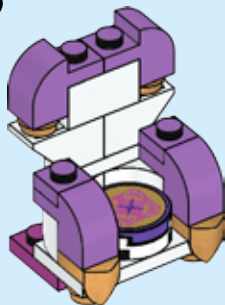

14

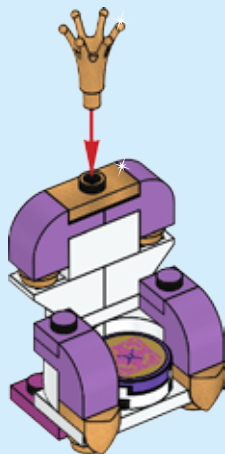

1

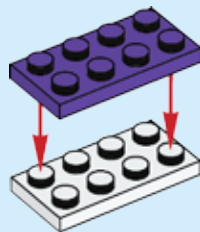

2

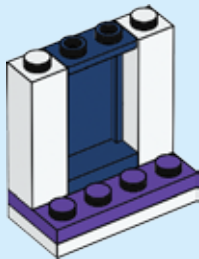

3

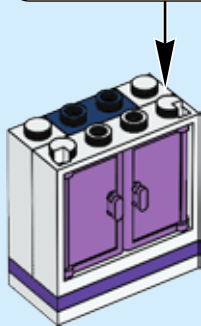
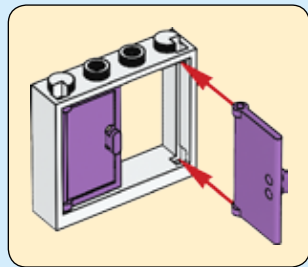

4

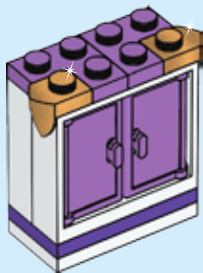

5



6

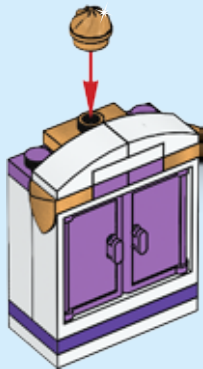

7

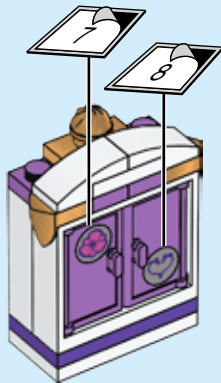

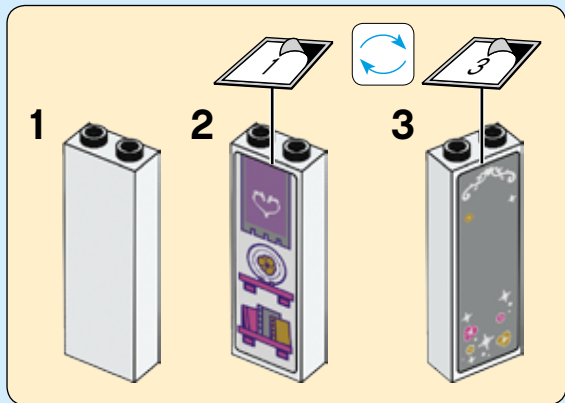

1



2



3



4





1

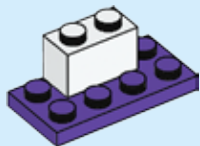

2

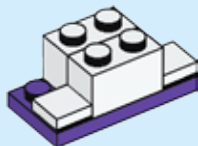

3

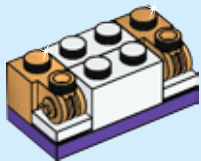

4



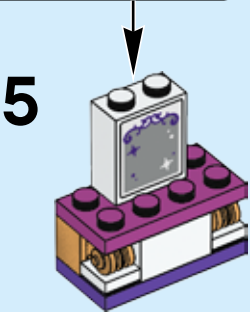
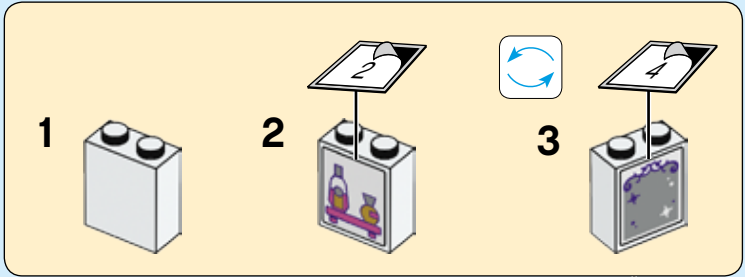

6

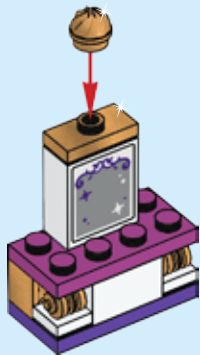

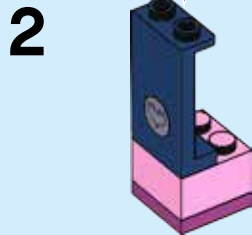
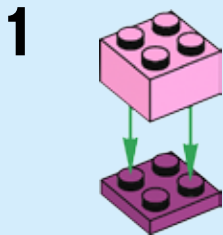
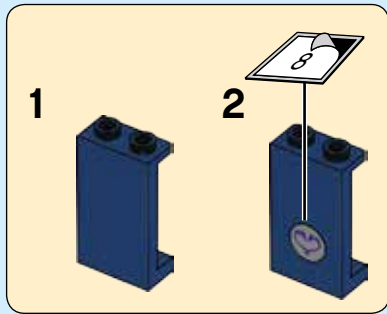

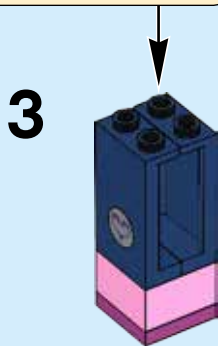
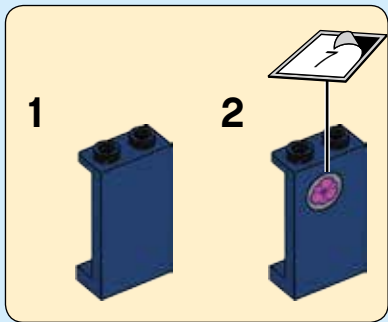

5

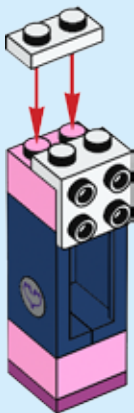

6





A



B



40388



41154



41152



1x 6173141	2x 6034044	2x 4567449	1x 245401	4x 4625616	1x 6136419	3x 4667331	1x 4243920	1x 6100565	1x 4567332
2x 307001	3x 300401	2x 366501	1x 285401	2x 6138507	1x 6133667	1x 4667331	1x 4538126	1x 3006840	1x 4114505
2x 403201	1x 4113261	1x 6117940	2x 302001	2x 6062386	1x 6060795	1x 6134672	2x 6050916	3x 6112751	1x 6058337
1x 4119410	2x 6055541	1x 4530590	1x 6109930	2x 4619517	1x 6096589	1x 6134673	7x 4523159	1x 4119482	1x 6097448
4x 302301			2x 6037658	2x 4619521	4x 4550359	2x 6035291	6x 6083975	1x 6052994	2x 4143404
				2x 4653970	2x 4620318	1x 6157942	2x 6143597	1x 4273743	1x 6023826
					2x 6097501	1x 6135278	1x 6173109		
					1x 6097098	1x 6097098	2x 6112307		
					2x 6030277	3x 6212994	4x 6092594	1x 6218085	
								1x 6218642	



Customer Service

Kundenservice

Service Consommateurs

Servicio Al Consumidor

LEGO.com/service or dial



00800 5346 5555 :



1-800-422-5346 :

