



# BRICK 'HEADZ

41635



THE  
LEGO  
MOVIE

WYLDSTYLE

89





 [LEGO.com/movie2](http://LEGO.com/movie2)



70823    70829    70830    70831



THE LEGO® MOVIE 2™ © & ™, Warner Bros. Entertainment Inc. & The LEGO Group. LEGO, the LEGO logo, DUPLO, the Minifigure and the Brick and Knob configurations are trademarks and/or copyrights of the LEGO Group. ©2019 The LEGO Group. All rights reserved. WB SHIELD: TM & © WBEI. (s19)



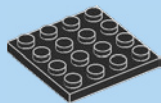

1x

1

REBELLE  
ESTILO-LIBRE

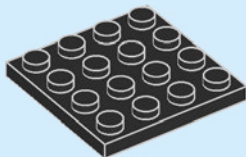

4



2x

2

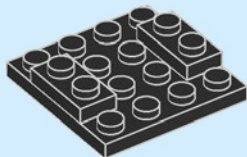



2x

3

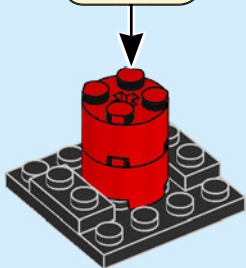
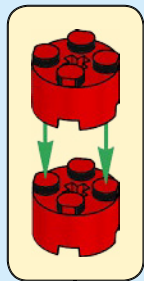

2x

4

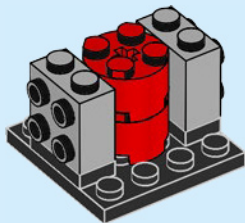

5

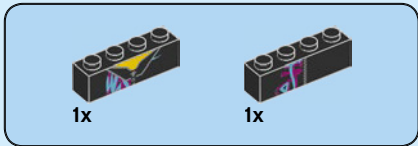

5

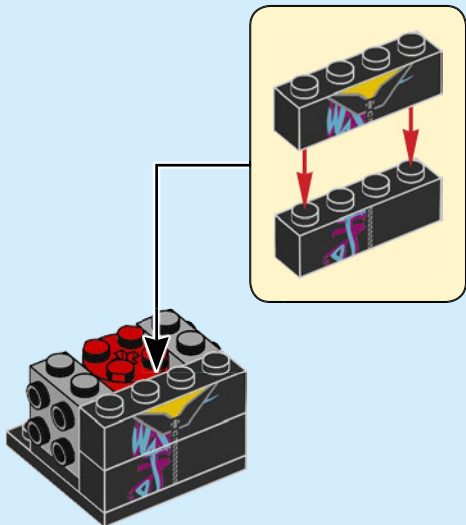

6

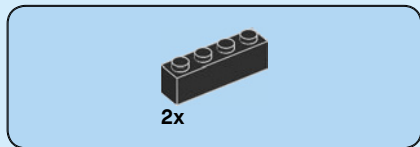

6

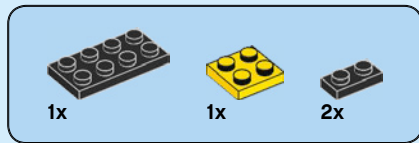
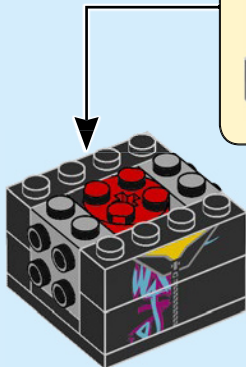
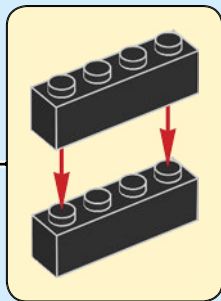

7

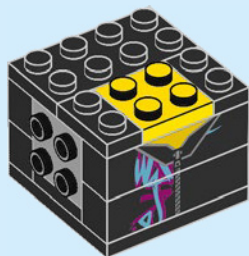



8

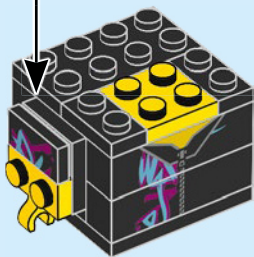

8



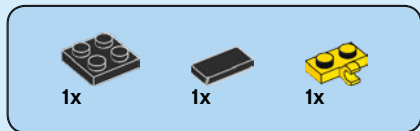

9

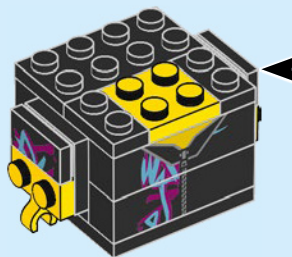
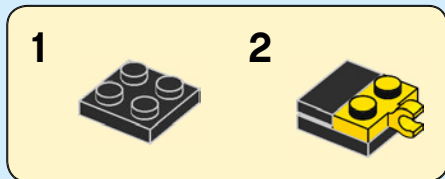



6x

10

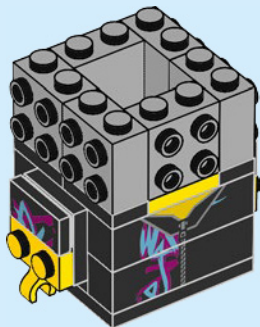

10

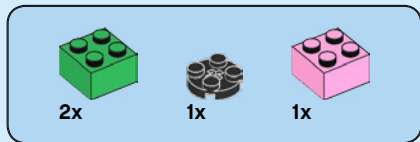

11

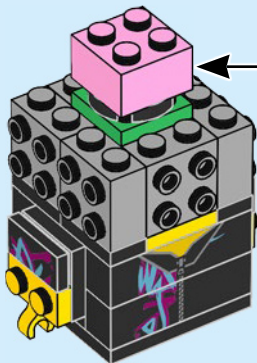
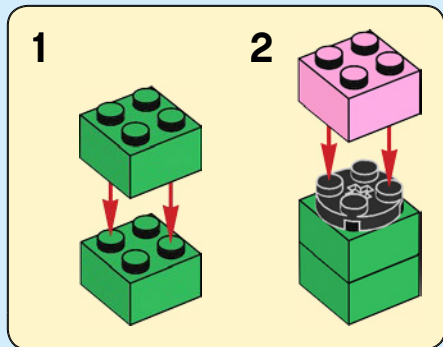



6x

12

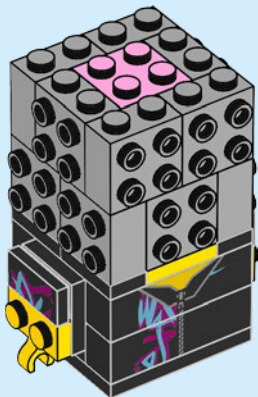

12

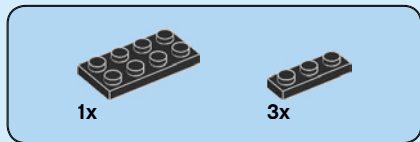

13

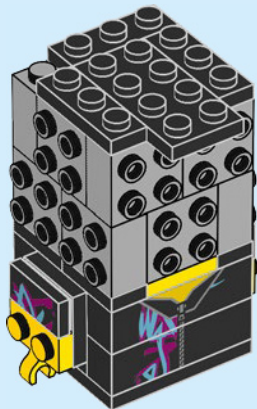

14

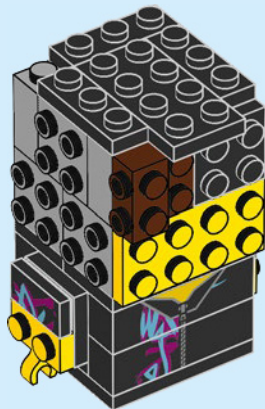

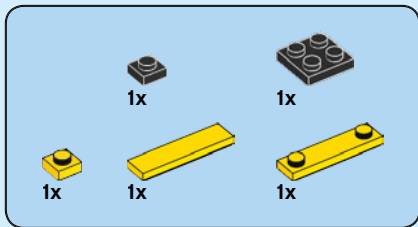

15

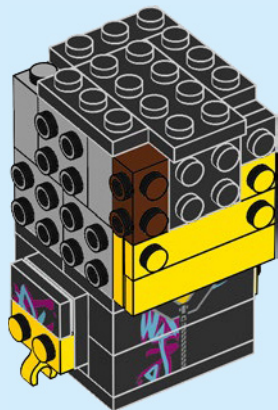

14

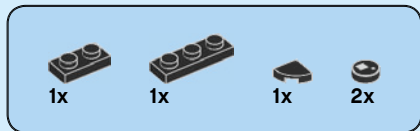

16

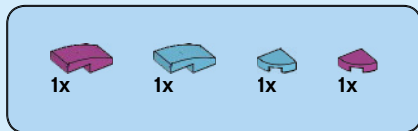
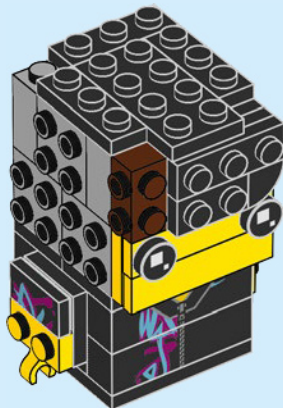

17

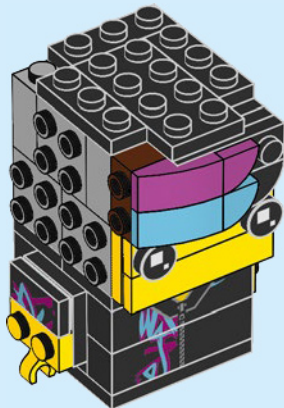

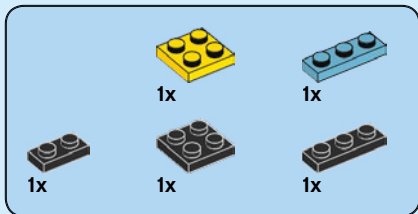

18

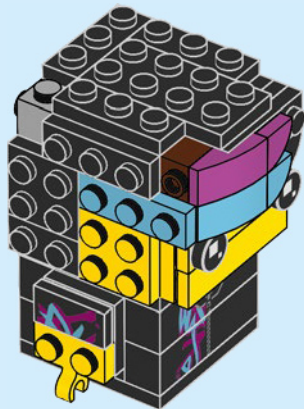





1x



1x



1x

# 19

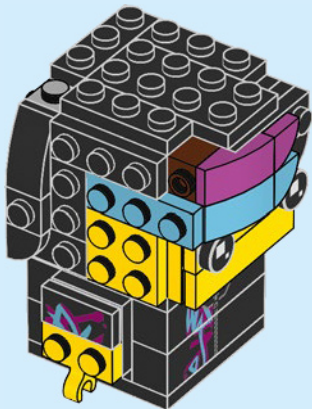

1x



1x



1x



1x

# 20

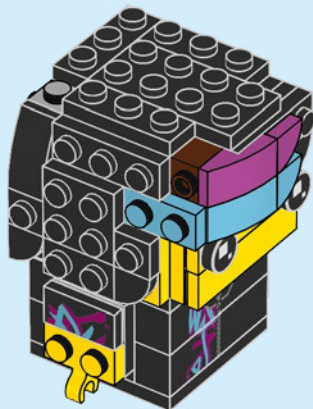



2x



1x



1x

# 21

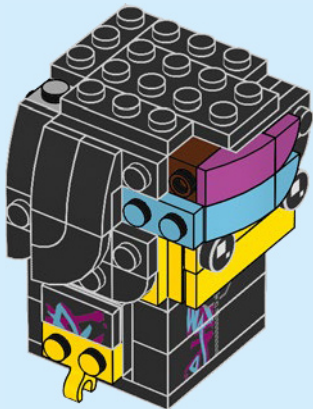



1x



1x



1x

# 22

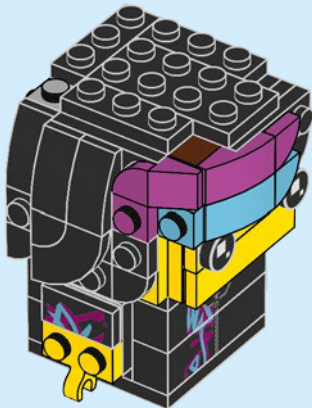

2x



1x

# 23

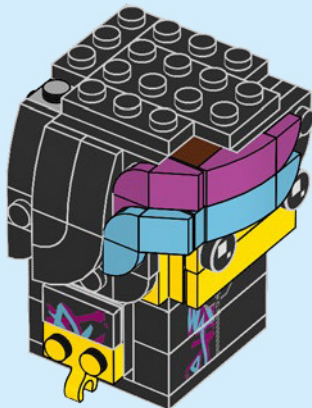



24

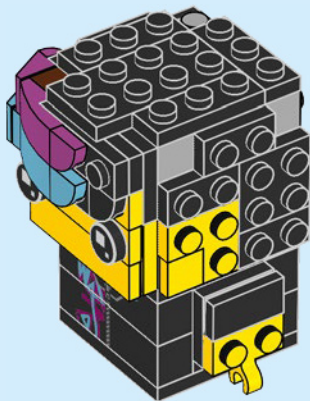
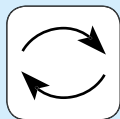



1x



1x



1x

# 25

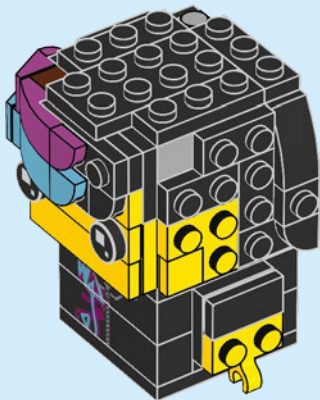

1x



1x



1x



1x

# 26

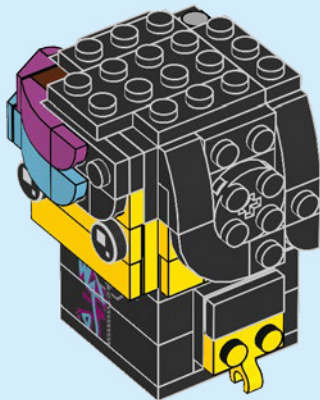



2x



1x



1x

# 27

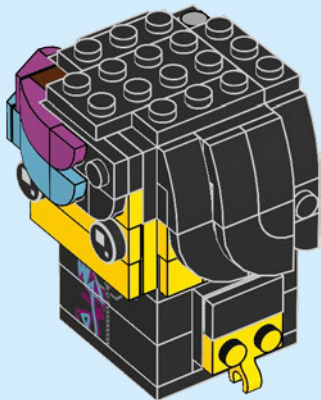

22

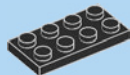

1x



1x

# 28

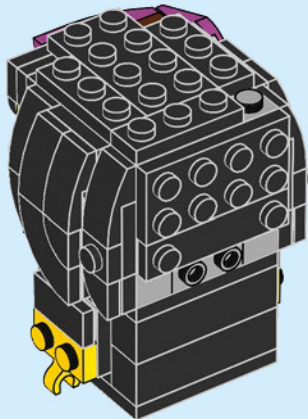

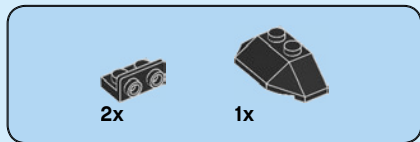

29

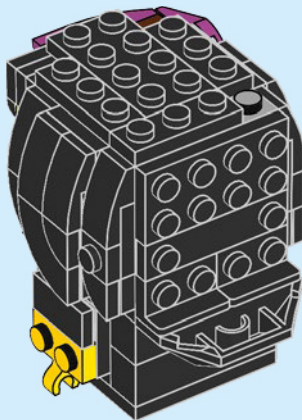
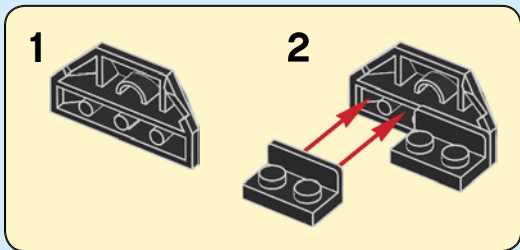

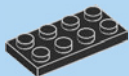

1x

30

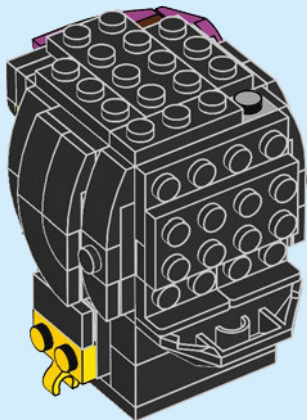

24





31

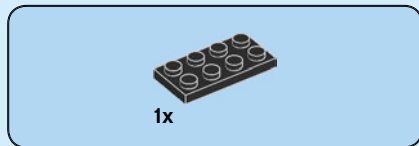
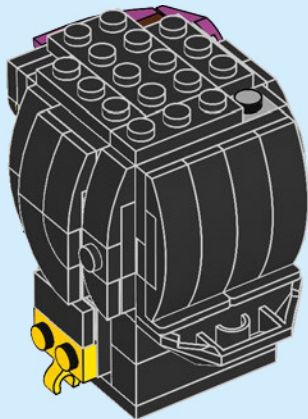

32

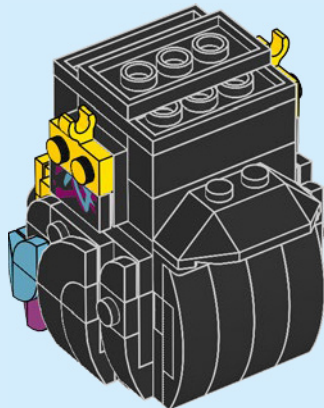
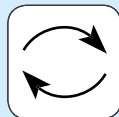



1x



2x

# 33

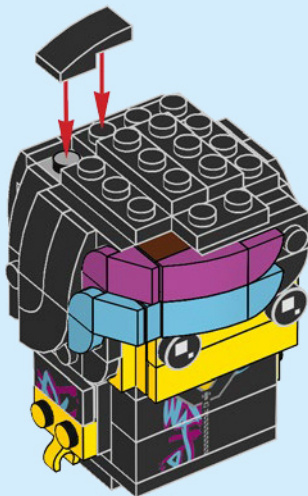
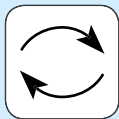



1x



1x

34

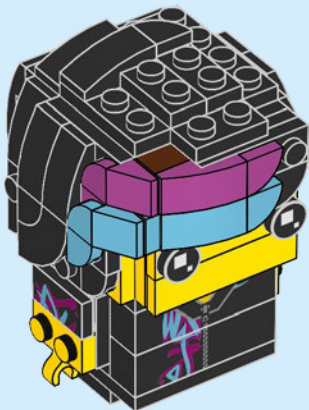

3x

35

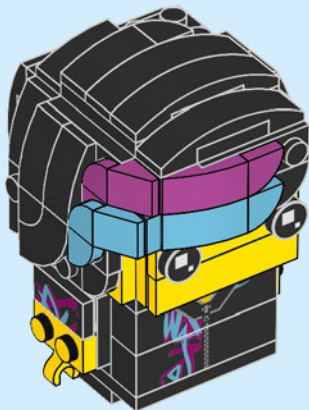



1x

36

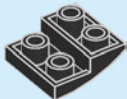

28



1x



1x

37

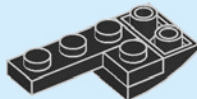



1x



1x

**38**

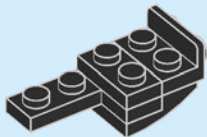

1x



1x

**39**

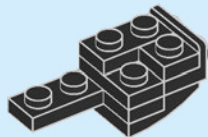



2x

40



30



1x



1x

41





1x

42

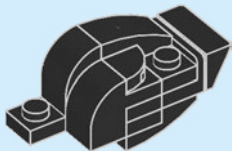

43

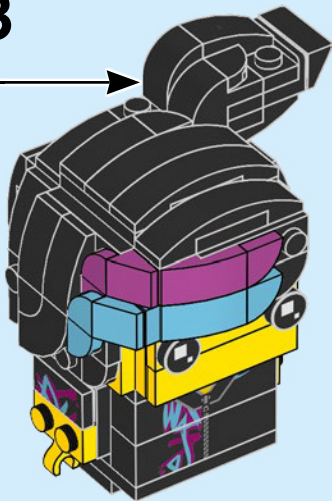



2x

44

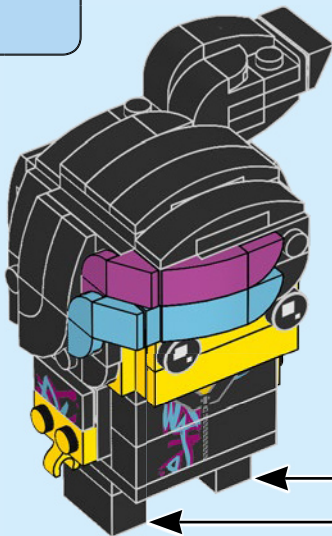

2x



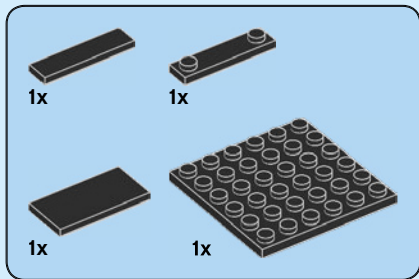

45

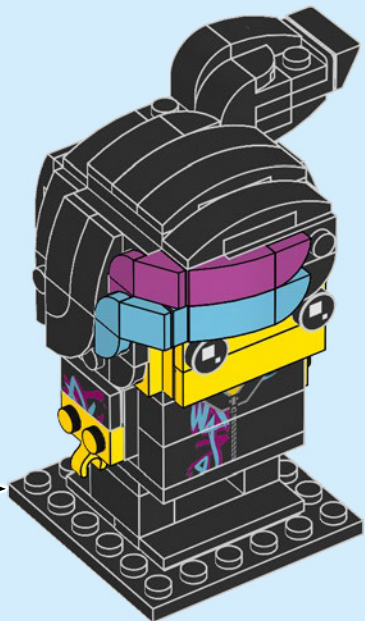
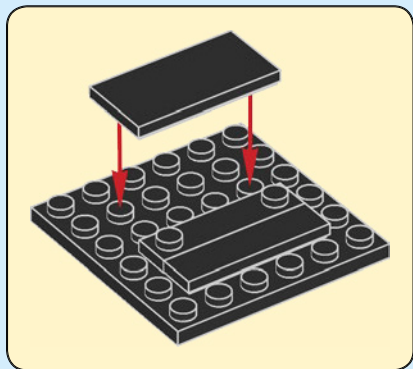

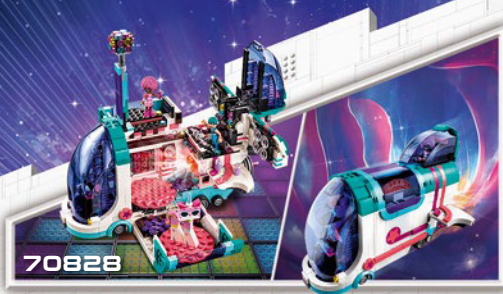

 [LEGO.com/movie2](http://LEGO.com/movie2)



70826

70830

70831

70828

**LEGO**

**THE LEGO MOVIE**

THE LEGO® MOVIE 2™ © & ™, Warner Bros. Entertainment Inc. & The LEGO Group. LEGO, the LEGO logo, DUPLO, the Minifigure and the Brick and Knob configurations are trademarks and/or copyrights of the LEGO Group. ©2019 The LEGO Group. All rights reserved. WB SHIELD: TM & © WBEI. (s19)

**LEGO**





1x  
243126



2x  
6254045



2x  
301026



1x  
4560182



5x  
302026

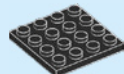

1x  
4243819

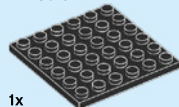

1x  
395826



7x  
302226



1x  
6211476



3x  
6191630



8x  
362326



1x  
6188706



7x  
4613153



1x  
6267096



1x  
6267117



2x  
403226



2x  
300426



10x  
6047276



2x  
6184784



1x  
6267154



1x  
306926



12x  
302326



3x  
6020193



2x  
614321



1x  
4550359



2x  
300328



1x  
4548180



2x  
6178627



7x  
302426



8x  
6172383



1x  
4619520



3x  
6150307



1x  
6071246



1x  
6119107



14x  
6123809



2x  
6199889



1x  
6177349



1x  
6096942



1x  
6070763



1x  
6146301



2x  
302224



1x  
242024



1x  
243124



1x  
6257598



1x  
302024



1x  
307024



1x  
302424



2x  
6179329



**Customer Service**

**Kundenservice**

**Service Consommateurs**

**Servicio Al Consumidor**

**LEGO.com/service or dial**



**: 00800 5346 5555**

**: 1-800-422-5346**

# WIN

GO TO [WWW.LEGO.COM/PRODUCTFEEDBACK](http://WWW.LEGO.COM/PRODUCTFEEDBACK) AND  
GIVE US YOUR SHORT **FEEDBACK** ABOUT THIS  
LEGO® SET FOR A CHANCE TO WIN  
A COOL LEGO PRIZE.

Terms & Conditions apply

## LEGO.com/productfeedback



### GEWINNE

Erzähle uns auf  
[www.LEGO.com/productfeedback](http://www.LEGO.com/productfeedback)

etwas über die Erfahrungen, die du  
mit diesem LEGO® Set gemacht hast,  
und sichere dir die Chance auf einen  
coolen LEGO Preis!

Es gelten die Teilnahmebedingungen

### GAGNE

Rends-toi sur  
[www.LEGO.com/productfeedback](http://www.LEGO.com/productfeedback)

et donne-nous quelques commen-  
taires sur ce produit LEGO® pour  
avoir une chance de gagner un  
prix LEGO !

Voir Conditions Générales

### GANA

Visita  
[www.LEGO.com/productfeedback](http://www.LEGO.com/productfeedback)

y envíanos tu opinión acerca de este  
set LEGO®. ¡Participarás en el sorteo  
de un premio LEGO!

Términos y Condiciones aplicables

### 获取奖品

登录  
[www.LEGO.com/productfeedback](http://www.LEGO.com/productfeedback)

给出关于此乐高®套装的简短反馈，  
就有机会获得炫酷乐高奖品

《条款及条件》适用

THE LEGO® MOVIE 2™ © & TM Warner Bros. Ent. Inc. & The LEGO Group. LEGO, the LEGO logo, DUPLO,  
the Minifigure and the Brick and Knob configurations © & TM The LEGO Group. ©2019 The LEGO Group.  
WB SHIELD: TM & © WBEI. (s19)



6274773