



# BRICK 'HEADZ

40442

Pets



 [LEGO.com/brickheadz](https://www.LEGO.com/brickheadz)

FRY

123

GOLDFISH

122



GOLDFISH  
GOLDFISCH  
LE POISSON ROUGE  
PESCIOLINO ROSSO  
CARPA DORADA  
PEDINHO DOURADO  
ARANYHAL  
ZELTA ŽIVTINAS  
金鱼

FRY  
JUNGFISCH  
LE TÊTARD  
FRY  
ALEVIN  
FRY  
BÉBÉHAL  
MAZULIS  
鱼苗

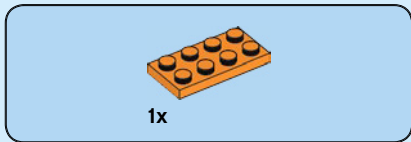

1

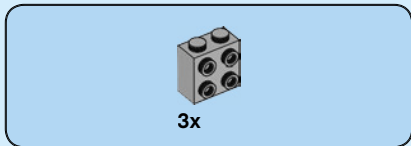
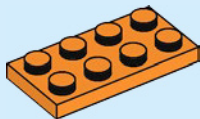

2

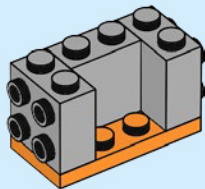

3



2x

3

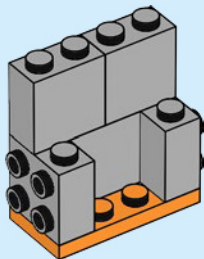

4



4

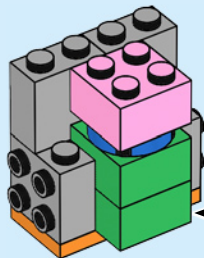
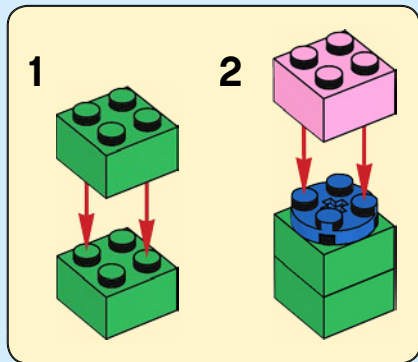

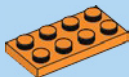

1x

5

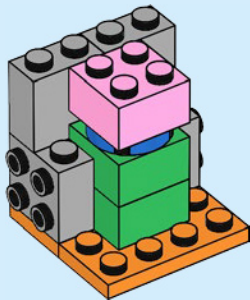

6



3x

6

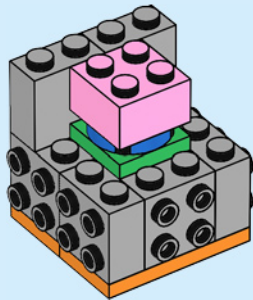



4x

7

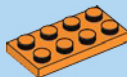
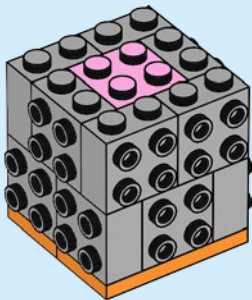

2x

8

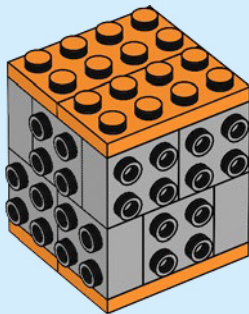



1x



1x

9

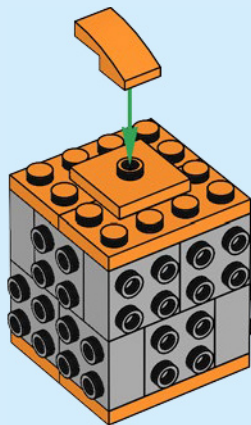

8



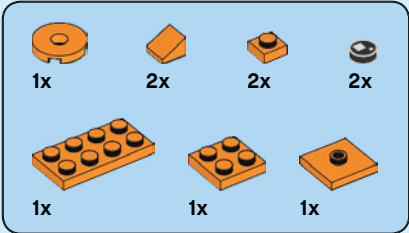

# 10

1

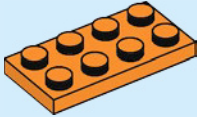

2

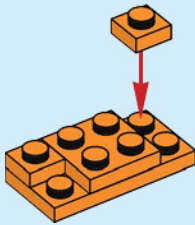

3

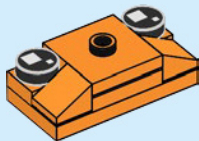

4

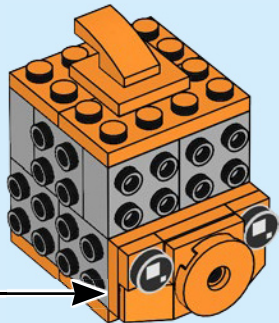
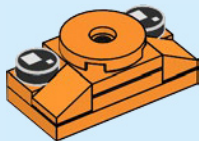

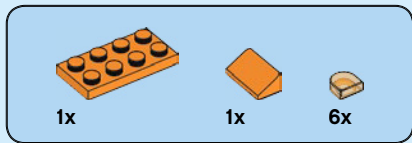

# 11

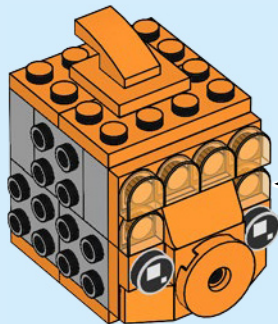
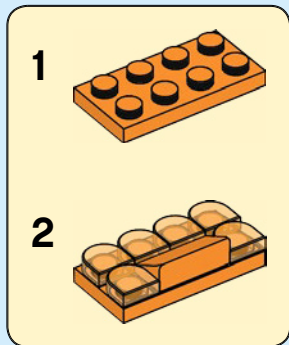

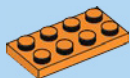

1x



2x

# 12

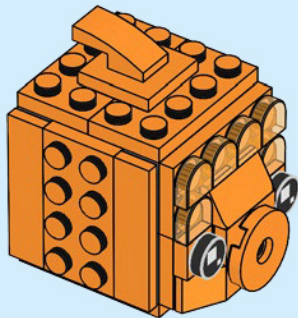

12



1x



6x

# 13

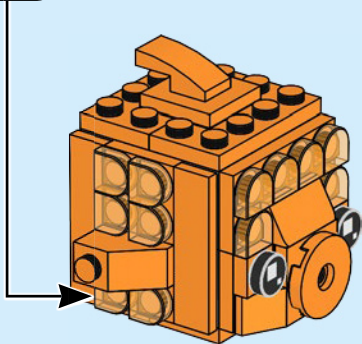



2x

14

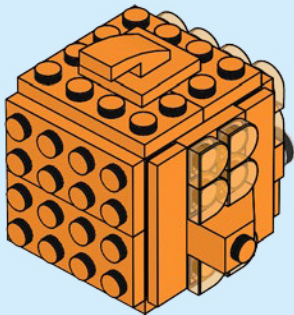

2x

15

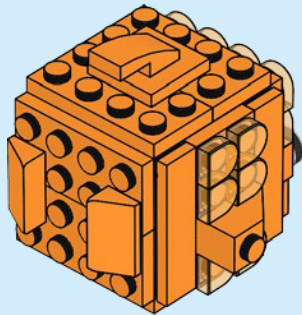



2x



2x

# 16

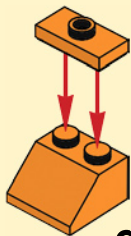

2x

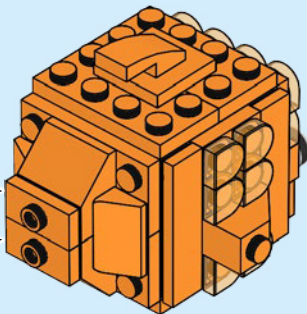
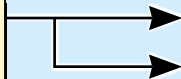

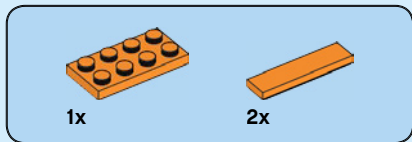

17

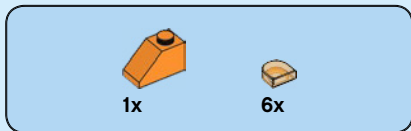
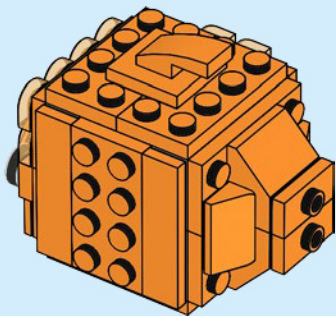

18

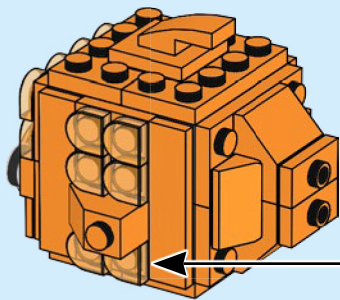

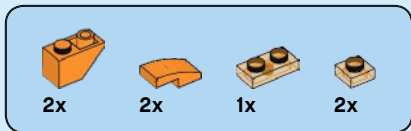

# 19

1



2

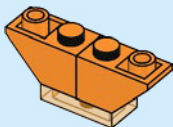

3

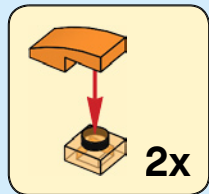
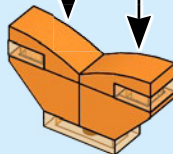



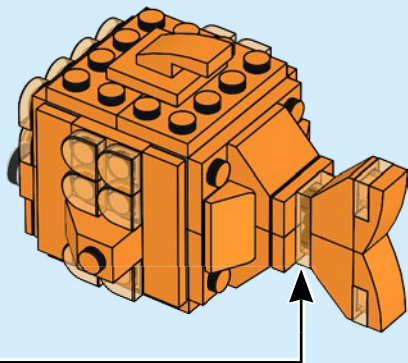

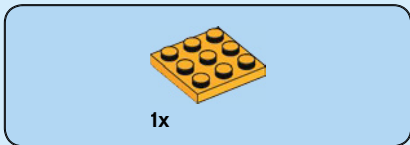

1

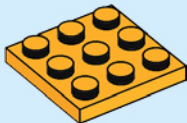

2

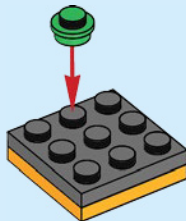



2x

3

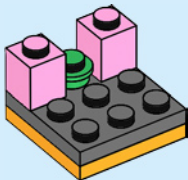

1x



2x

4

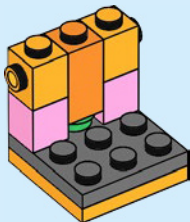



1x

5

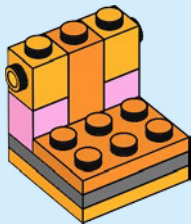

20



1x



2x

6

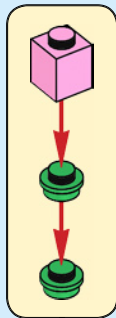
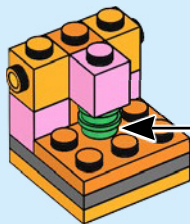



2x



1x

7

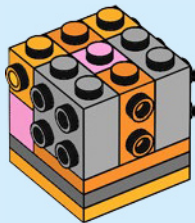

1x



1x

8

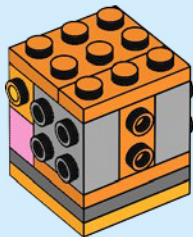



1x

9

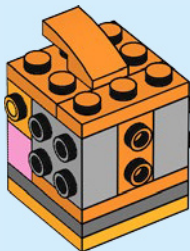



1x



1x



2x



2x



1x



1x



2x



3x

# 10

## 1

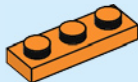

## 2

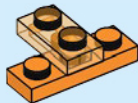

**3**

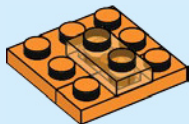

**4**

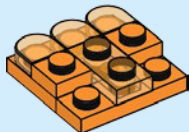

**5**

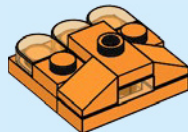



6

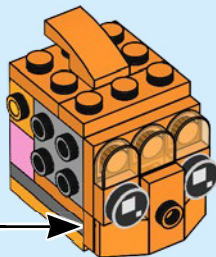
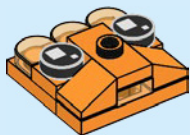



1x



1x

# 11

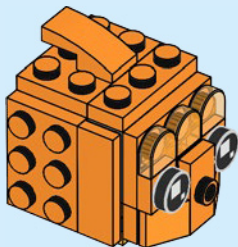



1x



2x

12

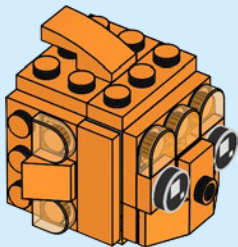

1x



1x

13

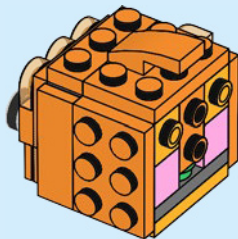



1x



2x

# 14

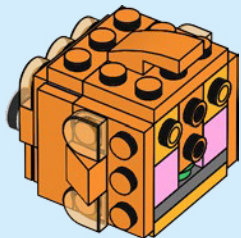

1x

# 15

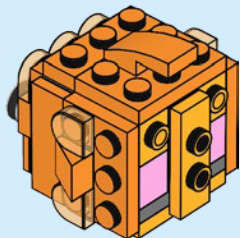

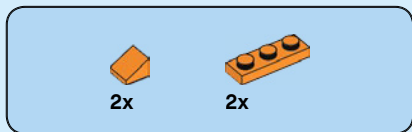

16

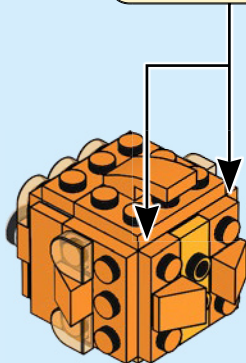
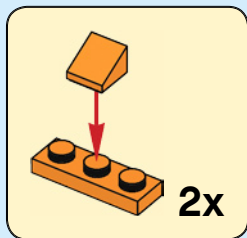

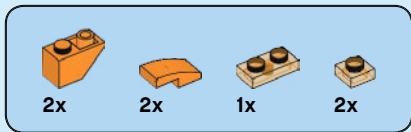

17

1



2

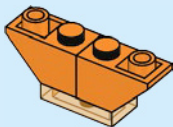

3

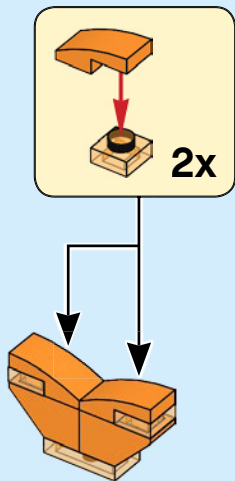

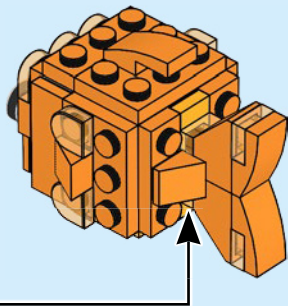

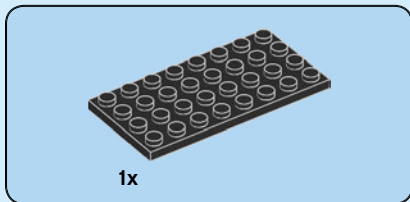
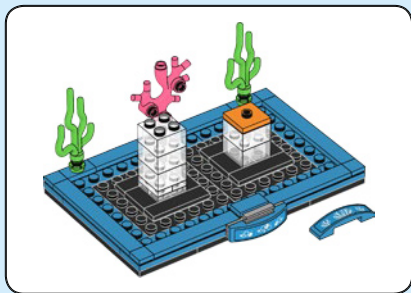

**1**

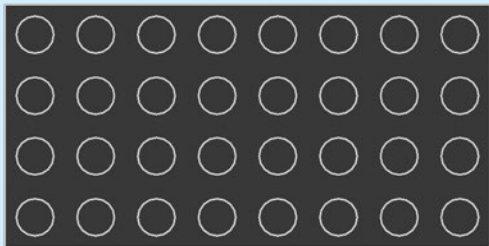

**1:1**



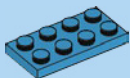

1x

2

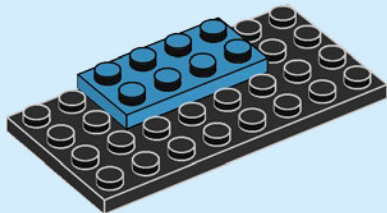

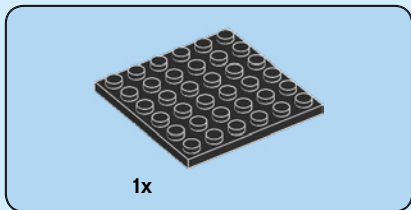

**3**

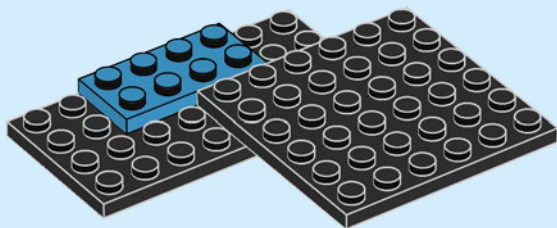

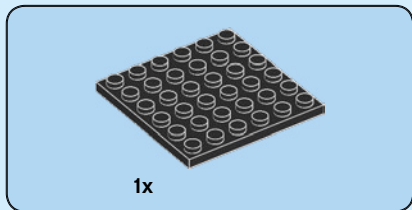

4

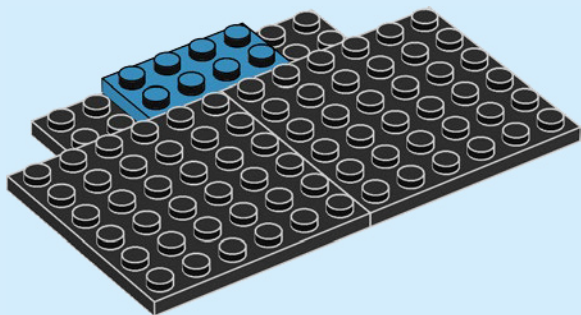

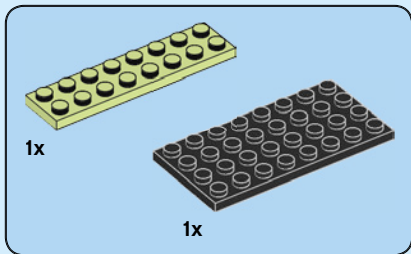

5

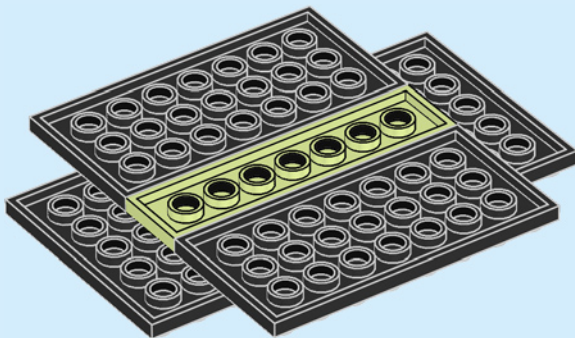

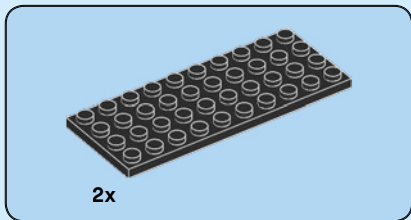

6

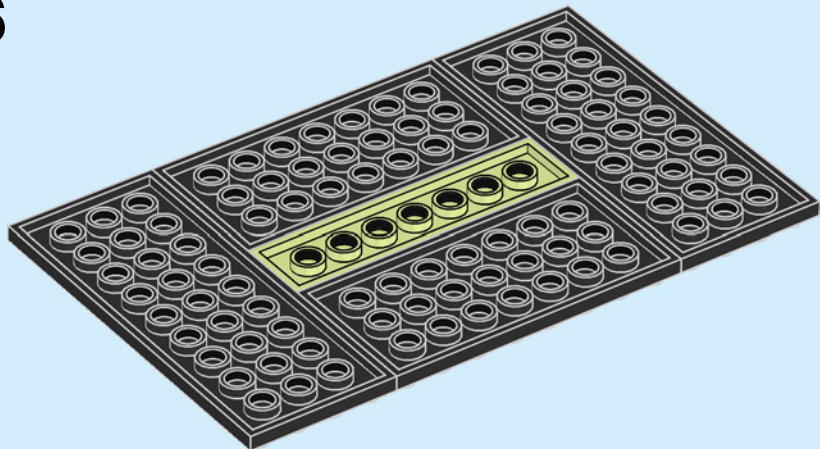

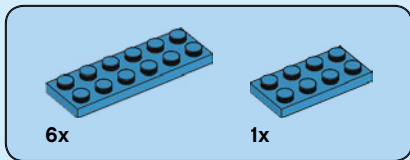

7

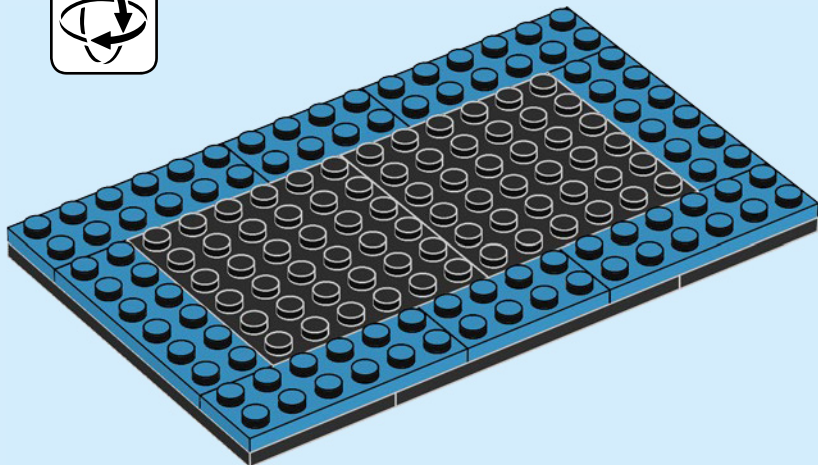

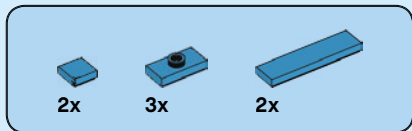

8

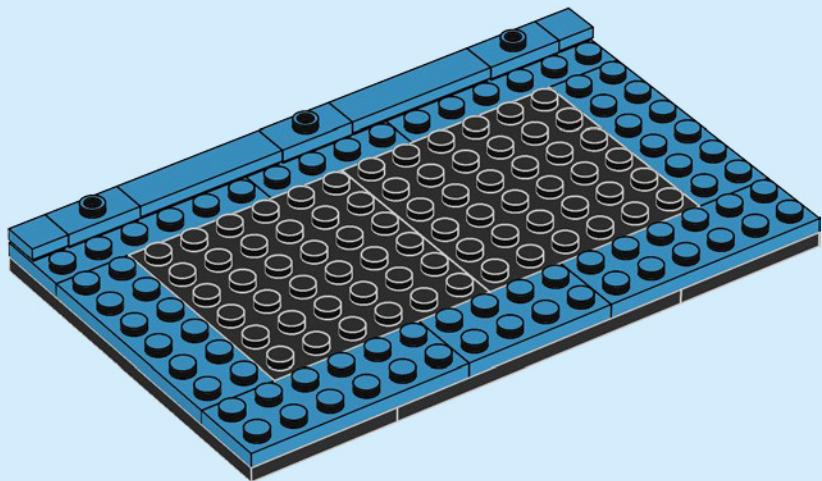

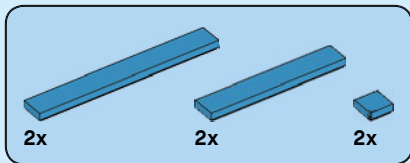

9

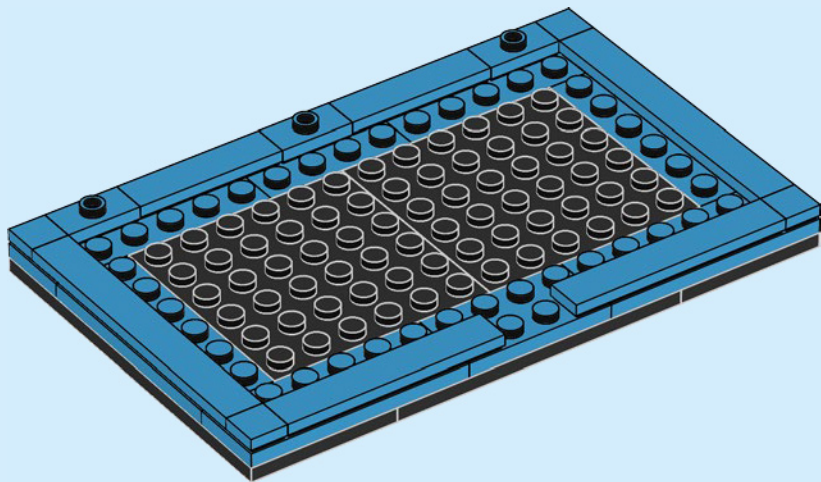





4x



4x

# 10

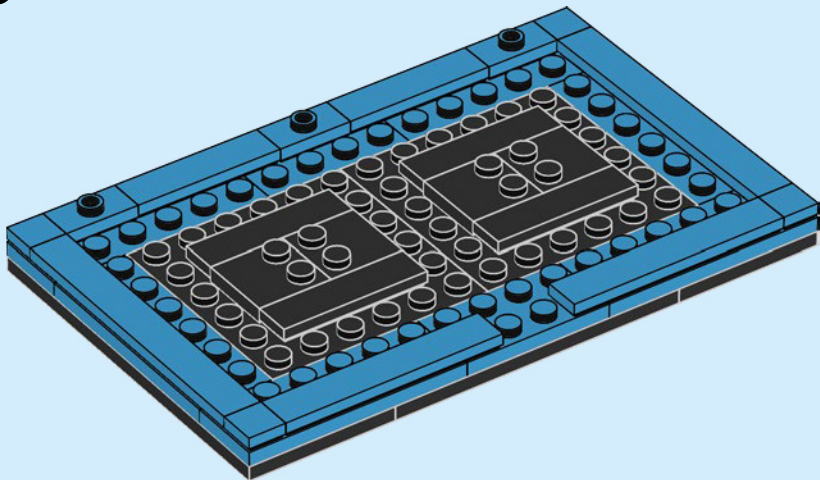

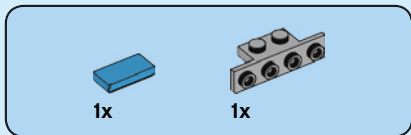

11

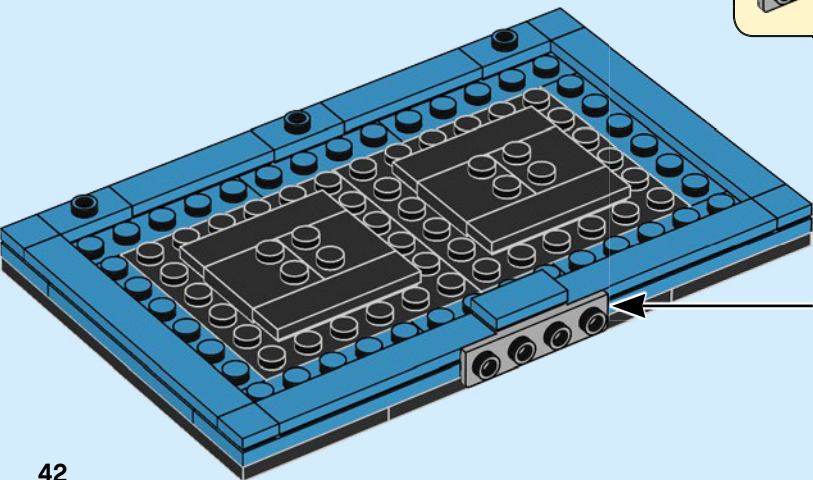
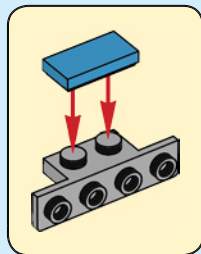



2x



1x

# 12

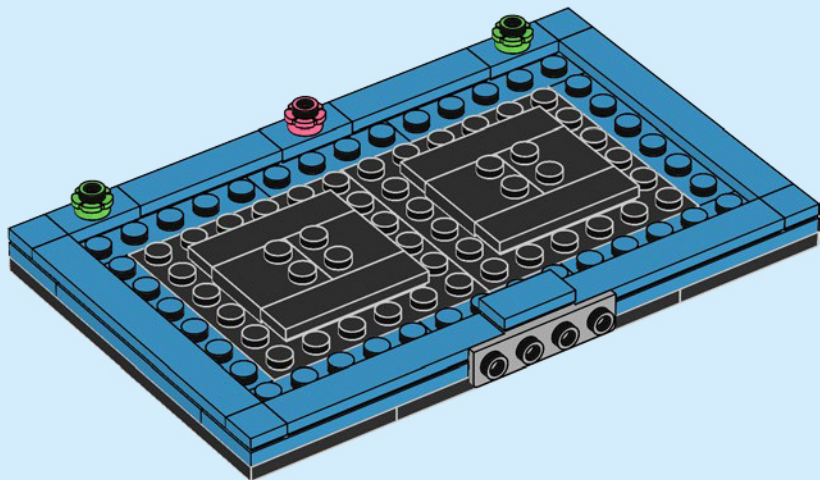



2x



1x

13

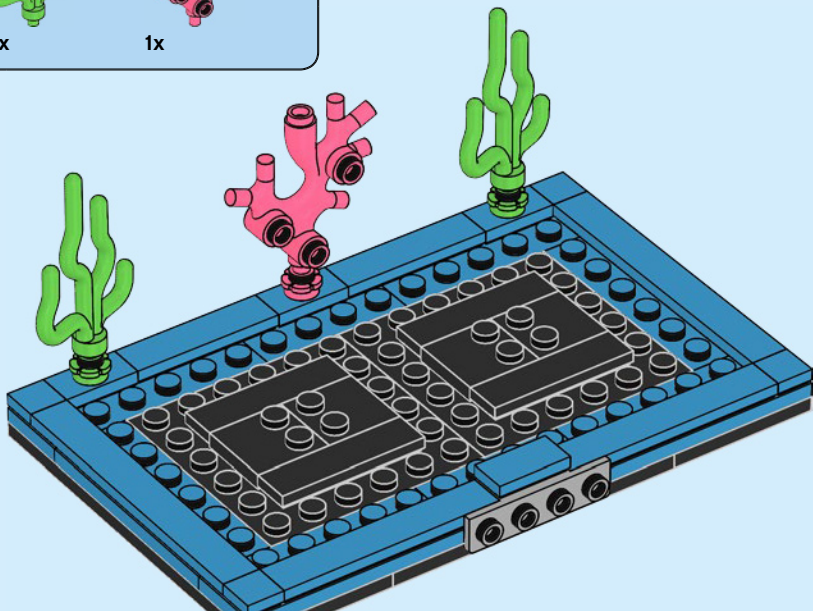

44



1x



2x

# 14

1

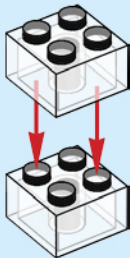

2

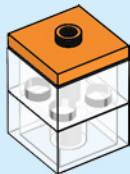

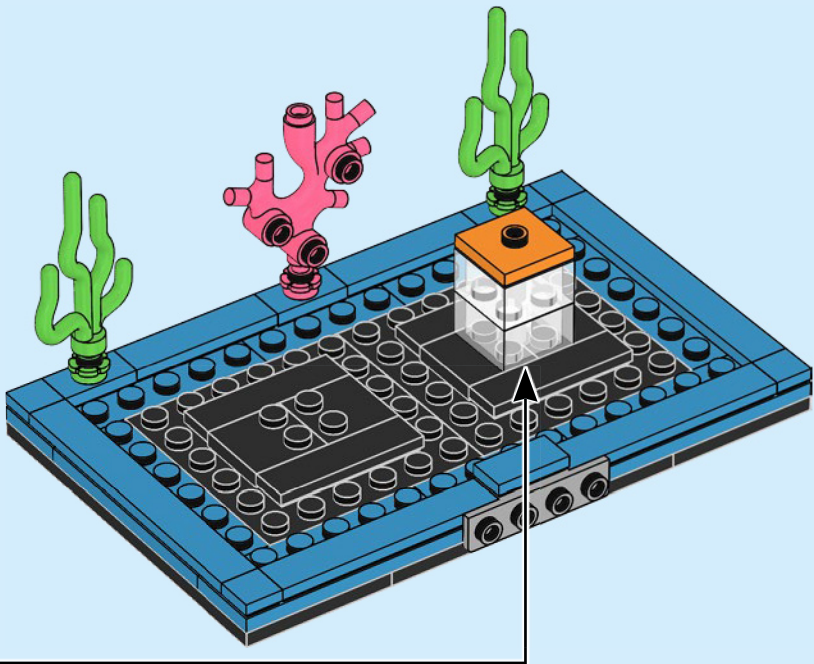



3x



4x

# 15

## 1



## 2

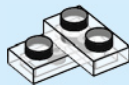

**3**

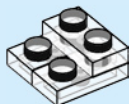

**4**

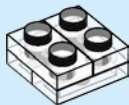

**5**

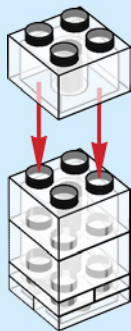



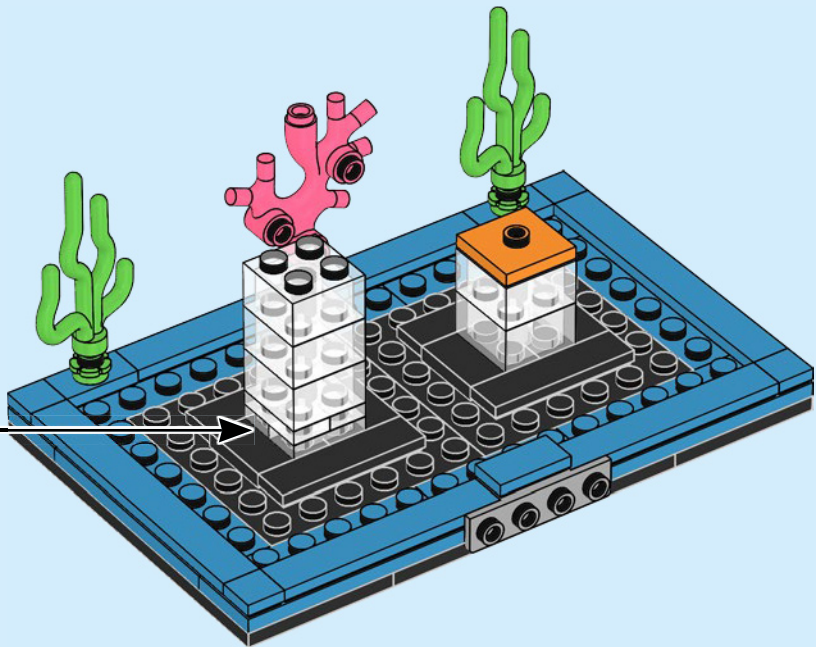



1x



1x

16

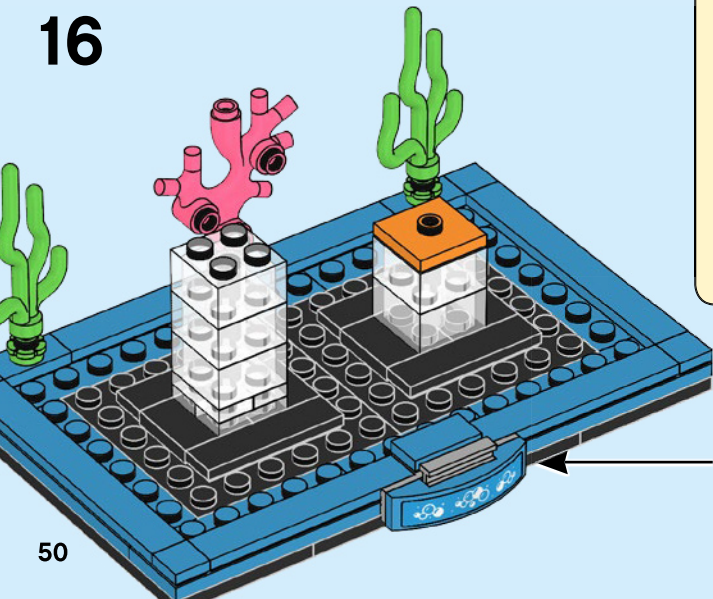

50

1

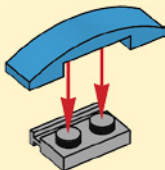

2

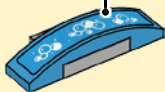

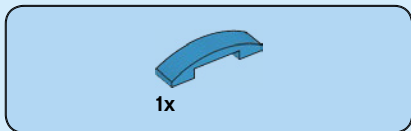

17

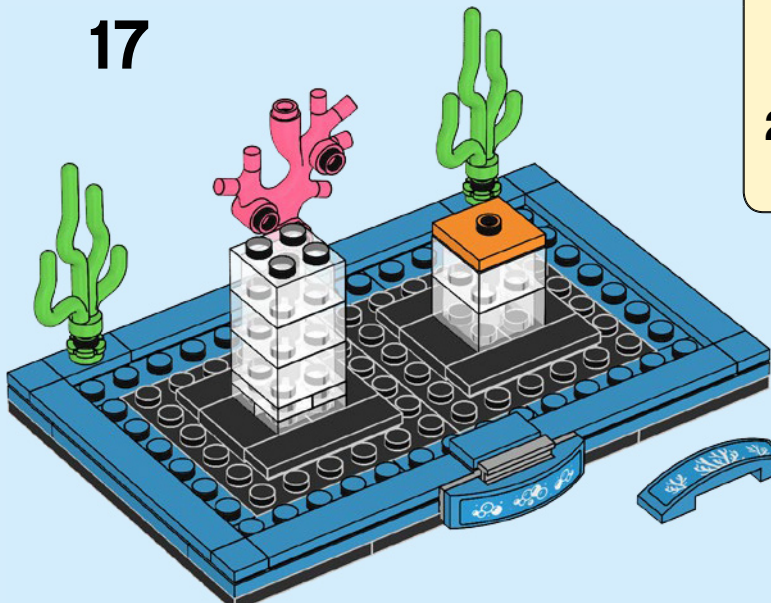
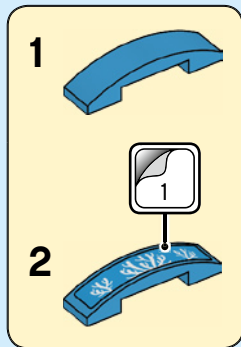

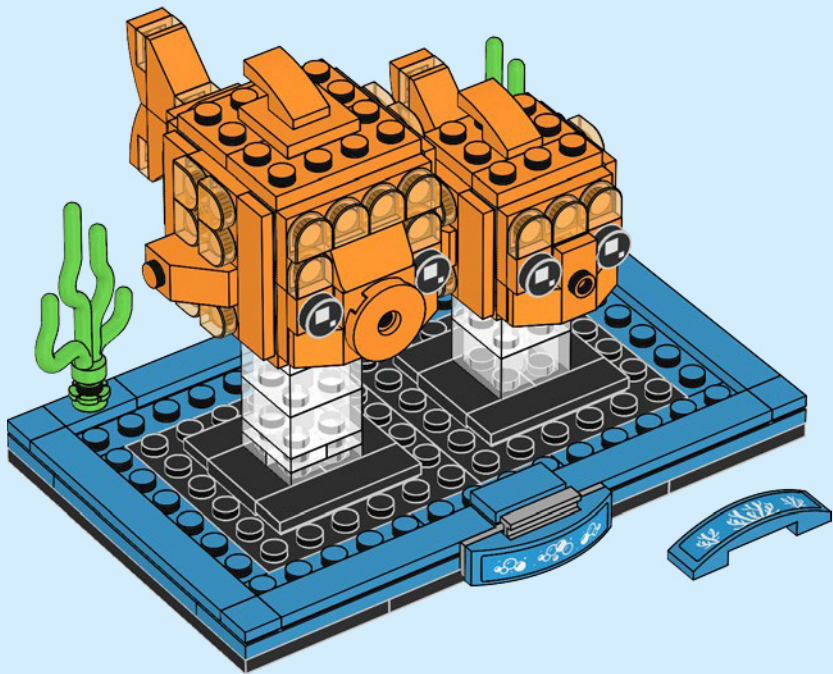



# BRICK 'HEADZ



40440

**119**

**118**

40441

**121**

**120**

40443

**125**

**124**



4x  
6284077



4x  
6192346



4x  
243126

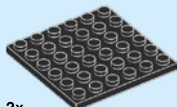

2x  
395826

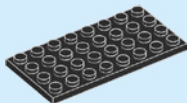

2x  
303526

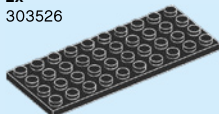

2x  
303026

**54**



3x  
4569058



2x  
300328



2x  
6206150



2x  
6269992



4x  
6240204



5x  
6239418



1x  
403223



4x  
4524929



8x  
4504371



2x  
6261640



3x  
6068996



1x  
6147052



6x  
6055069



3x  
6092599



3x  
6126063



4x  
4616279



2x  
4121967



2x  
4118828



4x  
6147047



2x  
4620693



4x  
4160593



1x  
4159007



5x  
4125278



10x  
4158355



2x  
6292415



1x  
6307254



1x  
6294582



25x  
6249116



4x  
6252040



3x  
6240217



3x  
4286050



1x  
4550359



1x  
6295242



1x  
6292823



14x  
6123809



1x  
4211568



1x  
6168615



1x  
6039176



4x  
6151658



3x  
6151671



2x  
6282122



1x  
6151659



2x  
6205089



2x  
6210675



6x  
4640891

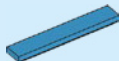

2x  
6164336

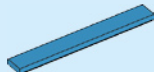

2x  
6213268

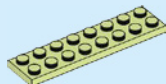

1x  
6216968



**Customer Service**  
**Kundenservice**  
**Service Consommateurs**  
**Servicio Al Consumidor**

**LEGO.com/service or dial**



**: 00800 5346 5555**

**: 1-800-422-5346**



# WIN

GO TO [WWW.LEGO.COM/PRODUCTFEEDBACK](http://WWW.LEGO.COM/PRODUCTFEEDBACK) AND  
GIVE US YOUR SHORT **FEEDBACK** ABOUT THIS  
LEGO® SET FOR A CHANCE TO WIN  
A COOL LEGO PRIZE.

Terms & Conditions apply

## [LEGO.com/productfeedback](http://LEGO.com/productfeedback)



### GEWINNE

Erzähle uns auf  
[www.LEGO.com/productfeedback](http://www.LEGO.com/productfeedback)

etwas über die Erfahrungen, die du  
mit diesem LEGO® Set gemacht hast,  
und sichere dir die Chance auf einen  
coolen LEGO Preis!

Es gelten die Teilnahmebedingungen

### GAGNE

Rends-toi sur  
[www.LEGO.com/productfeedback](http://www.LEGO.com/productfeedback)

et donne-nous quelques commen-  
taires sur ce produit LEGO® pour  
avoir une chance de gagner un  
prix LEGO !

Voir Conditions Générales

### GANAN

Visita  
[www.LEGO.com/productfeedback](http://www.LEGO.com/productfeedback)

y envíanos tu opinión acerca de este  
set LEGO®, ¡Participarás en el sorteo  
de un premio LEGO!

Términos y Condiciones aplicables

### 获取奖品

登录  
[www.LEGO.com/productfeedback](http://www.LEGO.com/productfeedback)

给出关于此乐高®套装的简短反  
馈，就有机会获得炫酷乐高奖品

《条款及条件》适用

LEGO and the LEGO logo are trademarks of the LEGO Group. ©2021 The LEGO Group.

6357923