



40572





Stiamo passando dagli imballaggi di plastica a quelli basati su carta. Ecco perché potrete trovare un mix di carta e di plastica nelle nostre confezioni!

Estamos sustituyendo las bolsas de plástico por bolsas con base de papel. ¡Por eso, puede que encuentres una mezcla de papel y de plástico en nuestras cajas!

Estamos a substituir as nossas embalagens de plástico por embalagens à base de papel. Por isso poderá encontrar um misto de papel e plástico nas nossas caixas!

Átállunk a műanyagról a papír alapú csomagolásra. Ezért előfordulhat, hogy a dobozainkban papír és műanyag zacskót egyaránt találsz!

We're switching from plastic to paper-based packaging. That's why you might find a mix of paper and plastic in our boxes!

Wir stellen von Kunststoffverpackungen auf Verpackungen auf Papierbasis um. Möglicherweise findest du deshalb sowohl Papier als auch Kunststoff in unseren Boxen!

Nous abandonnons progressivement les emballages en plastique au profit d'emballages à base de papier. Il est donc possible que vous trouviez à la fois du papier et du plastique dans nos boîtes !

Mēs pārejam no plastmasas iepakojuma uz iepakojumu, kurā izmantots papīrs. Tāpēc mūsu kārbās var būt gan papīra, gan plastmasas daļas.

Trecem de la ambalajele din material plastic la ambalaje pe bază de hârtie. Iată de ce s-ar putea să găsești un amestec de hârtie și material plastic în cutiile noastre!

我们正在从塑料包装向纸基包装过渡。这就是为什么你可能会发现我们的包装盒中同时出现塑料和纸质材料！

**LEGO.com/sustainable-packaging**

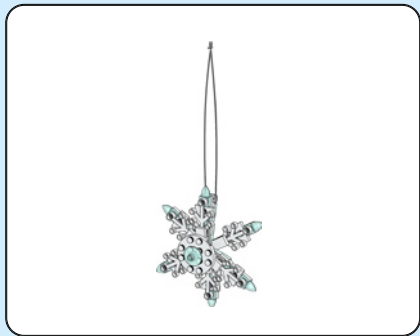



1x



1x

1



1x

2

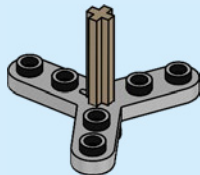



3x



3x

# 3

1



2

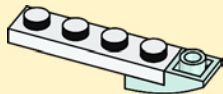

3x

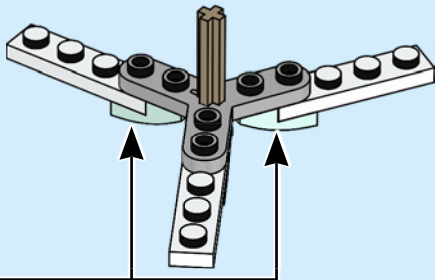



3x



3x



3x

4

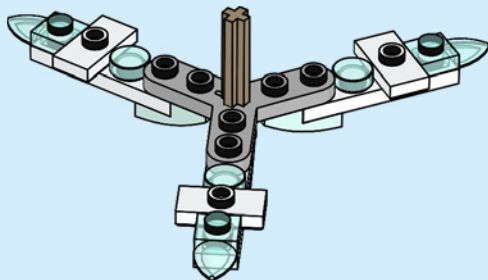



3x

5

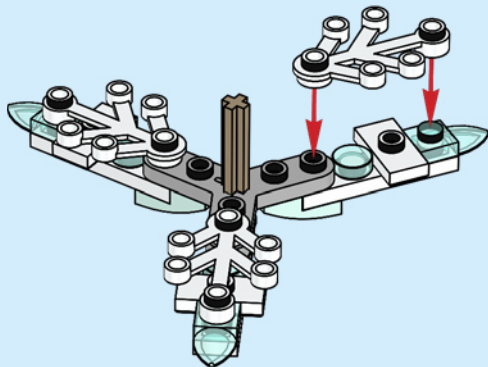



3x



1x

6

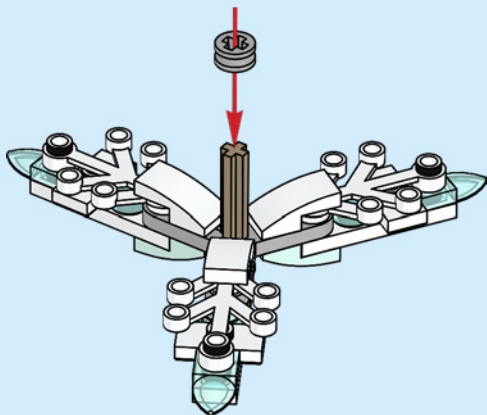



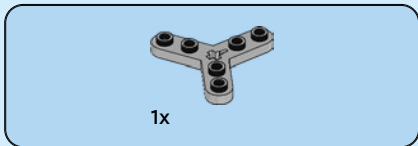
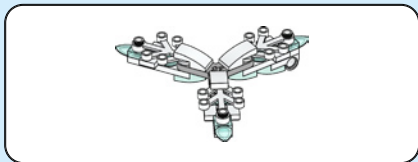

7

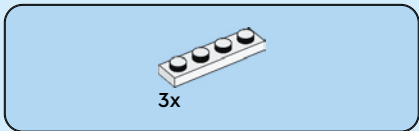
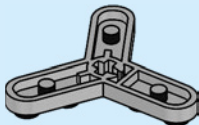

8

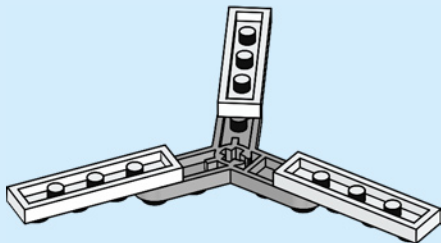



3x

9

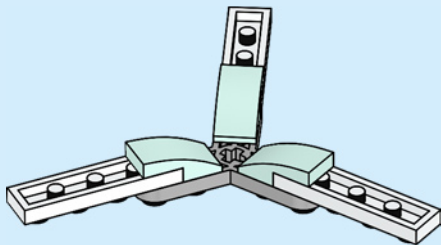



3x



3x



3x

# 10

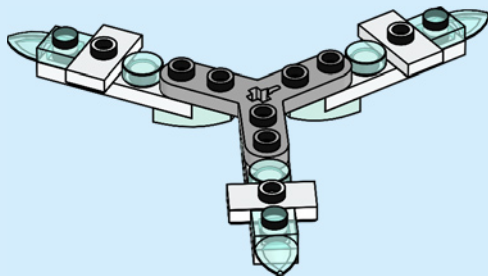



3x

11

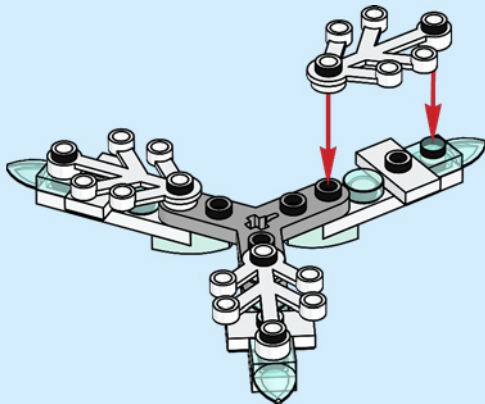



3x

12

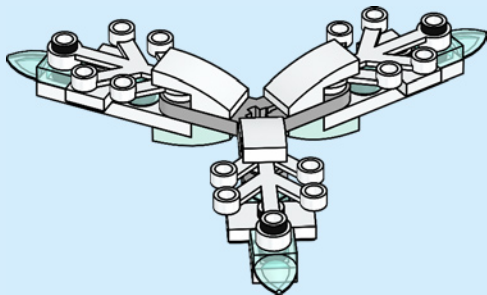



1x

13

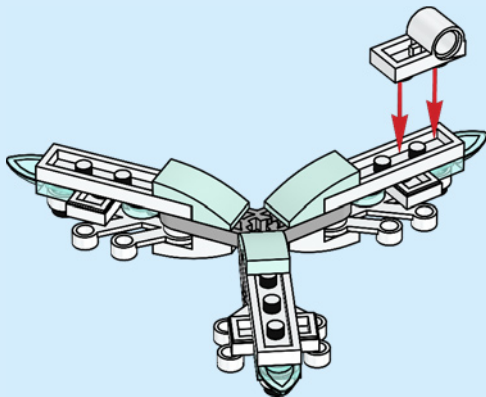



1x

14

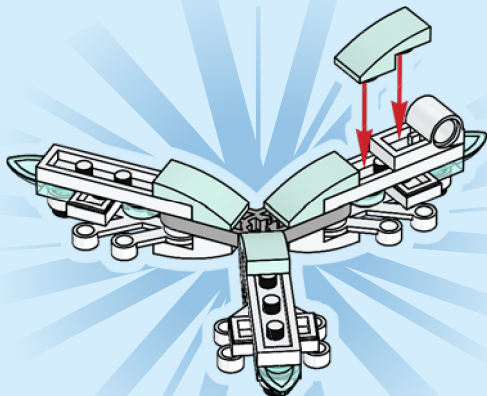

15

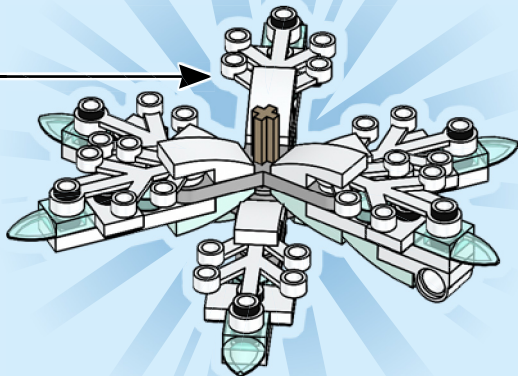



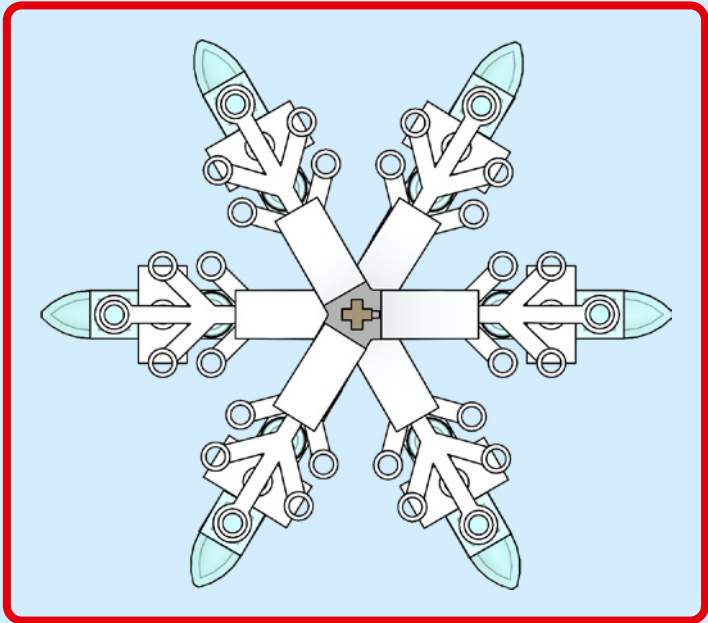



1x

16

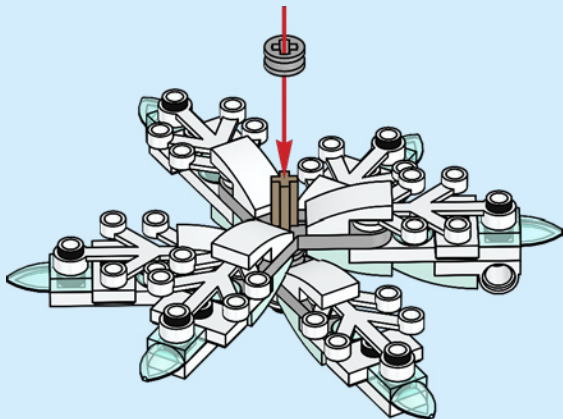

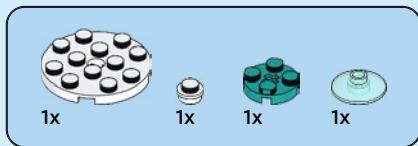

17

1



2

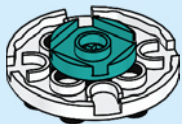

3

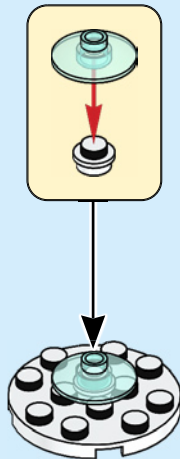

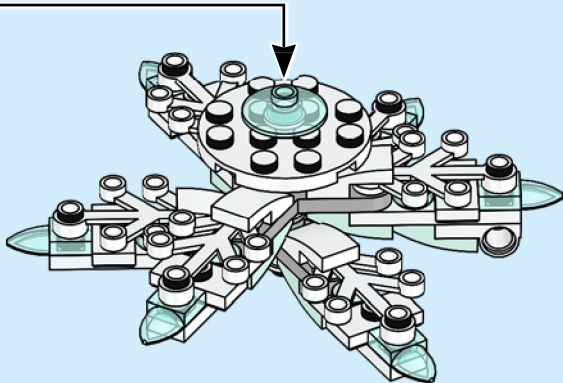

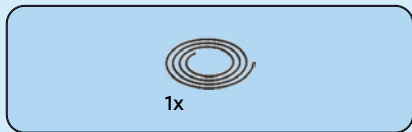

18

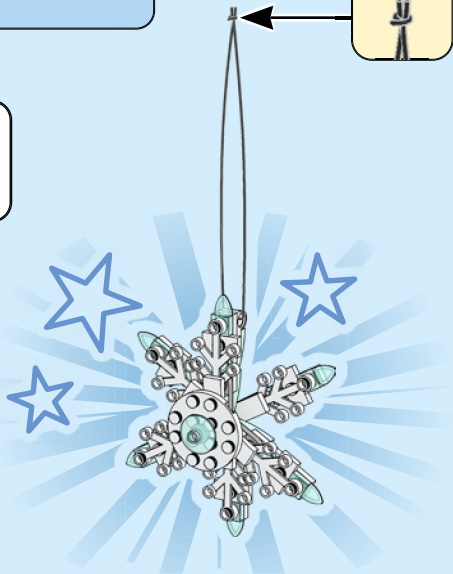

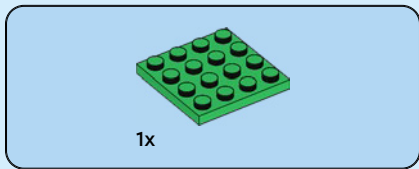
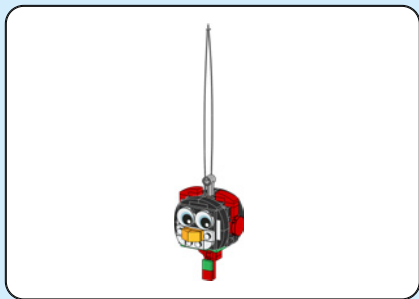

1

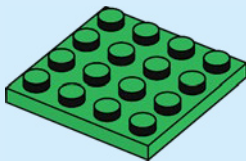

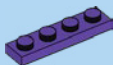

2x

2

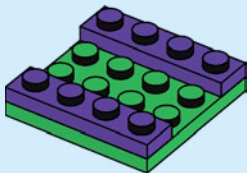

2x

3

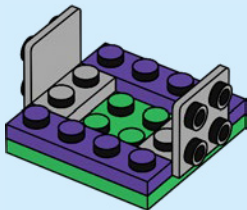

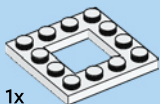

1x

4

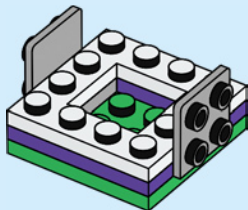

4x

5

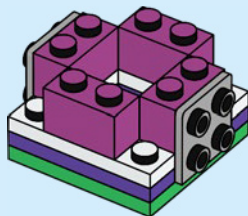





4x

6

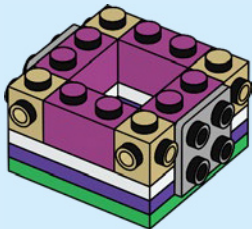

2x

7

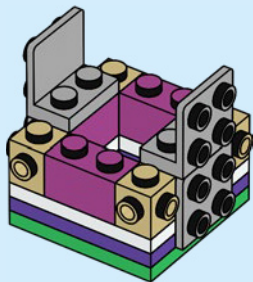



4x

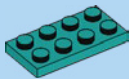

1x

8

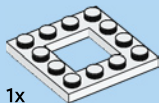
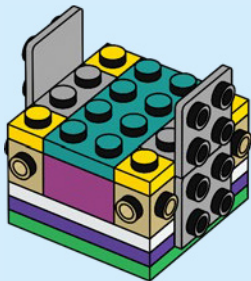

1x

9

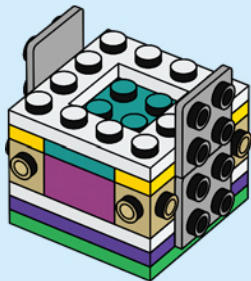

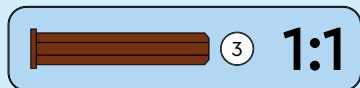
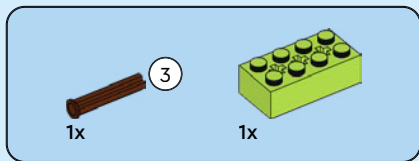

10

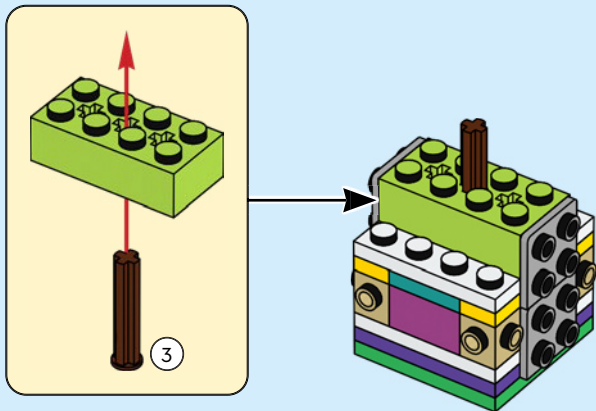



2x

11

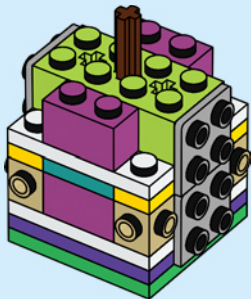

4x

12

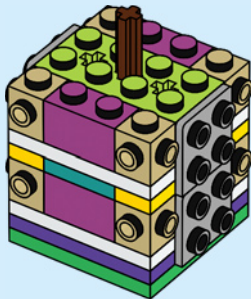



1x



2x



2x



1x

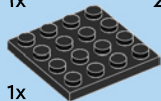

1x



2x



1x

# 13

## 1

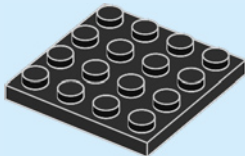

## 2

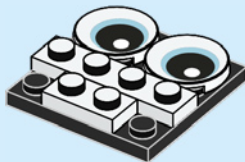

## 3



4



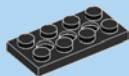

1x



2x

14

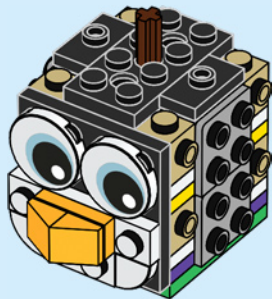

2x



4x

15

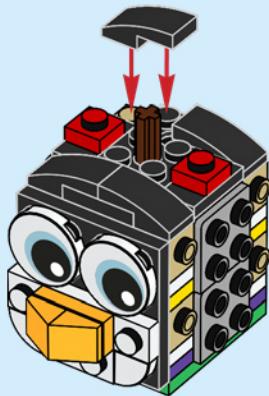

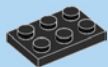

1x



1x

# 16

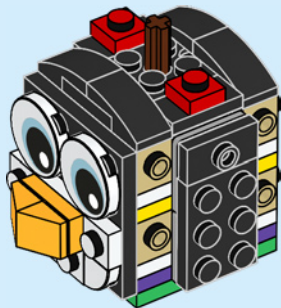





2x



4x

17



1

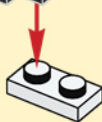

2

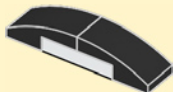

2x

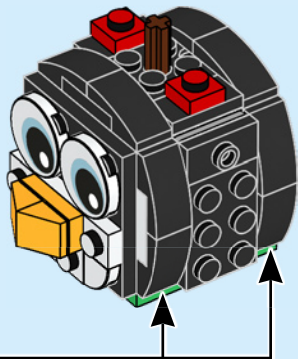



1x



1x



1x

# 18

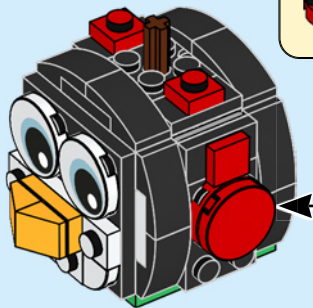
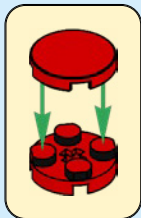

1x



1x

# 19

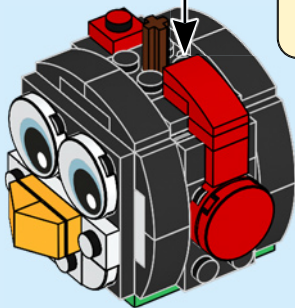
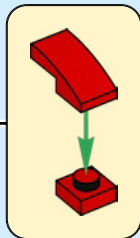

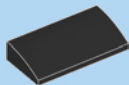

2x



1x

# 20

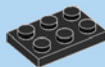
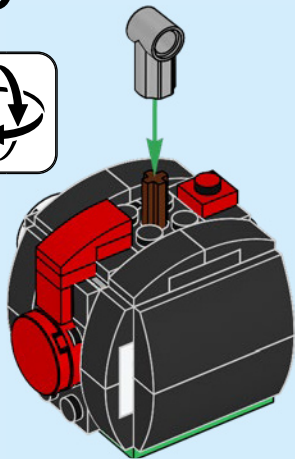
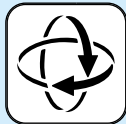

1x



1x

# 21

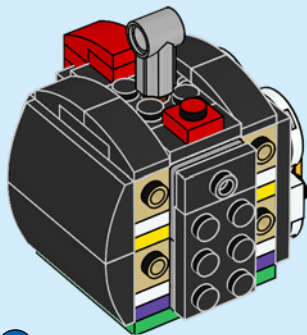



2x



4x

# 22

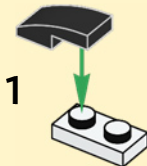

2

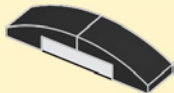

2x

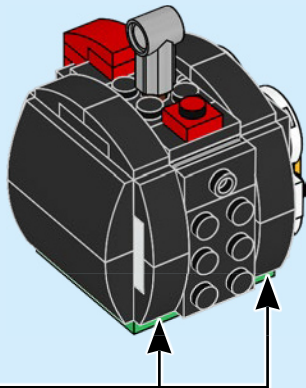

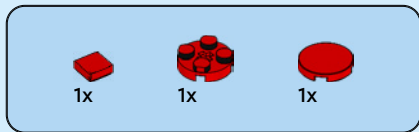

23

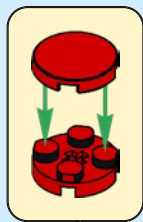
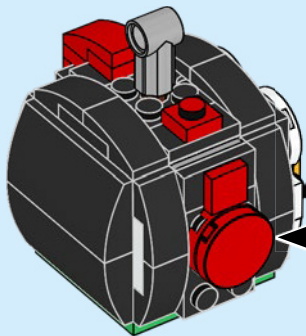



1x



1x

# 24

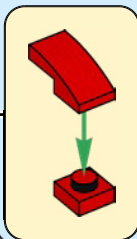
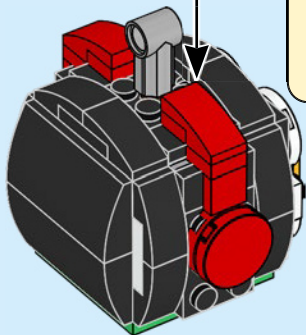

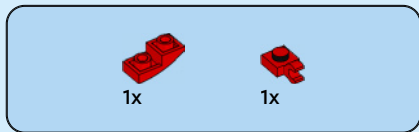

25

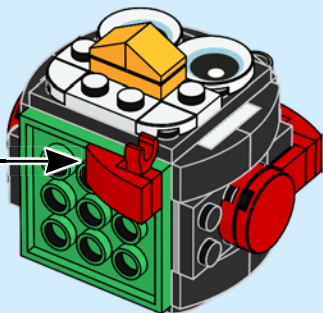
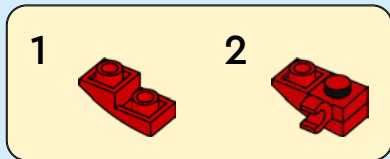
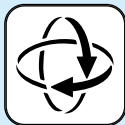



1x



1x



1x

# 26

1



2

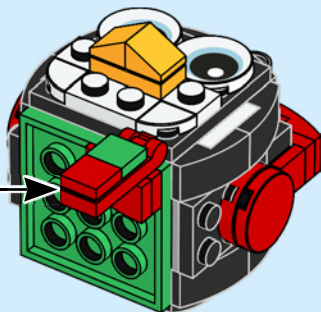
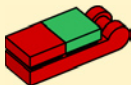



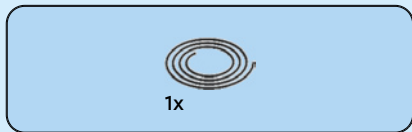

27

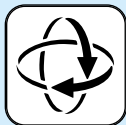



2x  
614101



2x  
6252746



1x  
6232029



2x  
6066342



12x  
6047276



2x  
6172366



6x  
6268821



3x  
307021



2x  
6029946



2x  
302126



5x  
302301



7x  
371001



4x  
302421



1x  
6186398



1x  
370926



6x  
6051511



1x  
4515347



1x  
6335377



1x  
4515365



2x  
4587844



6x  
6034044



2x  
6167450



2x  
403221



4x  
6092585



2x  
6338170

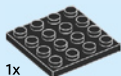

1x  
4243819



6x  
6274739



1x  
6031821



2x  
6023173



2x  
6271165



2x  
6167464



6x  
6292200



1x  
6390840



1x  
6028736



1x  
6296859



1x  
6245307



1x  
4558593



1x  
6135494



4x  
4654580



7x  
6336530



4x  
302424

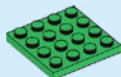

1x  
4243821



8x  
6175968



1x  
6210400



6x  
4519195



1x  
6338181



2x  
6307999

Customer Service  
 Kundenservice  
 Service Client  
 Assistenza clienti  
 Atención al cliente  
 Serviço de Apoio ao Consumidor  
 Ügyfélszolgálat  
 Klientu apkalpošanas dienests  
 Serviciul pentru clienți  
 客户服务  
 コンシューマーサービス  
 고객 서비스

[LEGO.com/service](http://LEGO.com/service)

# WIN

Terms & Conditions apply

Scan this QR code or go to **LEGO.COM/PRODUCTFEEDBACK** and give us your short feedback about this LEGO® set for a chance to win a cool LEGO prize.



## GEWINNE

Scanne diesen QR-Code oder geh auf **LEGO.COM/PRODUCTFEEDBACK**

und gib uns dein kurzes Feedback zu diesem LEGO® Set. Dann hast du die Chance, einen coolen LEGO Preis zu gewinnen.

Es gelten die Teilnahmebedingungen

## GAGNE

Scannez ce code QR ou rendez-vous sur **LEGO.COM/PRODUCTFEEDBACK**

pour donner votre avis sur ce produit LEGO® et avoir une chance de gagner un prix LEGO.

Voir Conditions Générales

## GANA

Escanea este código QR o visita **LEGO.COM/PRODUCTFEEDBACK**

y comparte con nosotros tu opinión sobre este set LEGO® para tener la oportunidad de ganar un fantástico premio LEGO.

Términos y Condiciones aplicables

## 获取奖品

只需扫描此二维码或访问 **LEGO.COM/PRODUCTFEEDBACK**,

就这款乐高®套装提供简短反馈,就有机会赢得很酷的乐高奖品。

《条款及条件》适用