



40565





We're switching from plastic to paper-based packaging. That's why you might find a mix of paper and plastic in our boxes!

Wir stellen von Kunststoffverpackungen auf Verpackungen auf Papierbasis um. Möglicherweise findest du deshalb sowohl Papier als auch Kunststoff in unseren Boxen!

Nous abandonnons progressivement les emballages en plastique au profit d'emballages à base de papier. Il est donc possible que vous trouviez à la fois du papier et du plastique dans nos boîtes !

Stiamo passando dagli imballaggi di plastica a quelli basati su carta. Ecco perché potrete trovare un mix di carta e di plastica nelle nostre confezioni!

Estamos sustituyendo las bolsas de plástico por bolsas con base de papel. ¡Por eso, puede que encuentres una mezcla de papel y de plástico en nuestras cajas!

Estamos a substituir as nossas embalagens de plástico por embalagens à base de papel. Por isso poderá encontrar um misto de papel e plástico nas nossas caixas!

Átállunk a műanyagról a papír alapú csomagolásra. Ezért előfordulhat, hogy a dobozainkban papír és műanyag zacskót egyaránt találás!

Mēs pārejam no plastmasas iepakojuma uz iepakojumu, kurā izmantots papīrs. Tāpēc mūsu kārbās var būt gan papīra, gan plastmasas daļas.

Trecem de la ambalaje din material plastic la ambalaje pe bază de hârtie. Iată de ce s-ar putea să găsești un amestec de hârtie și material plastic în cutiile noastre!

我们正在从塑料包装向纸基包装过渡。这就是为什么你可能会发现我们的包装盒中同时出现塑料和纸质材料！

[LEGO.com/sustainable-packaging](https://www.lego.com/sustainable-packaging)

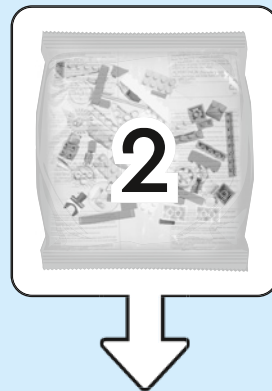

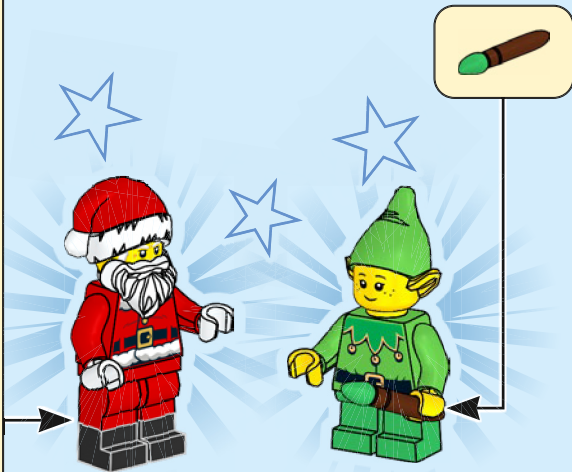
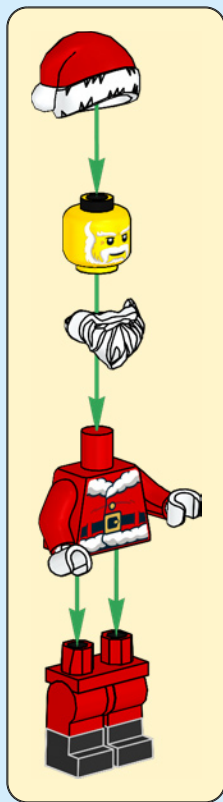

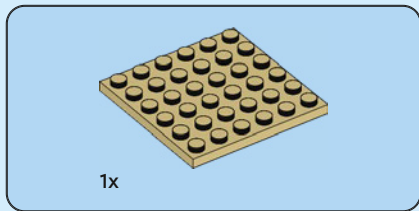

1

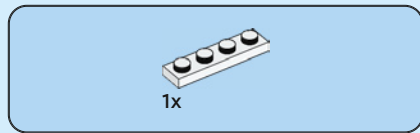
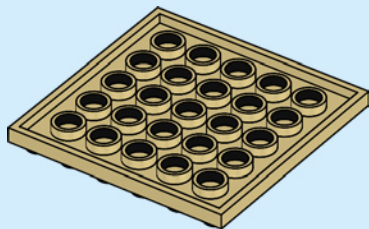

2

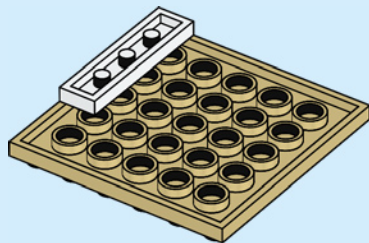

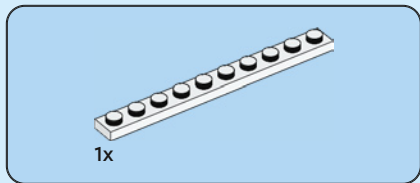

3

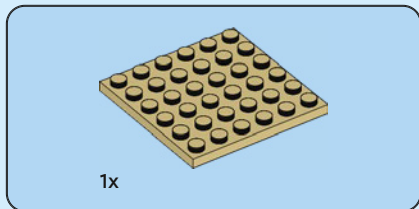
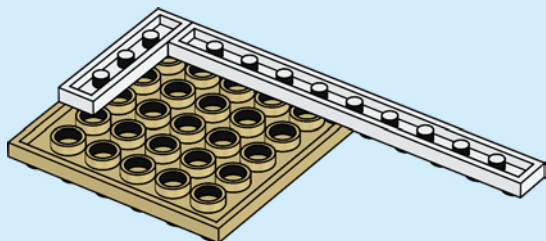

4

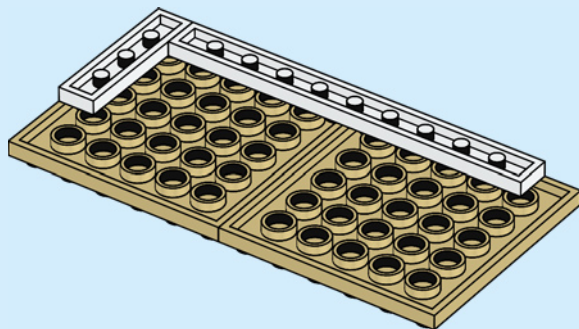

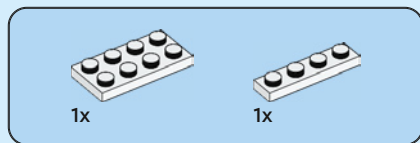

5

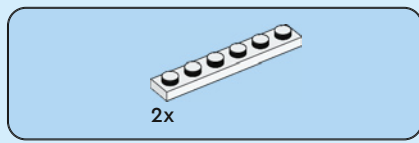
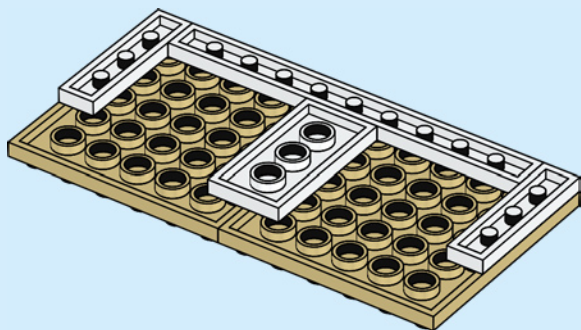

6

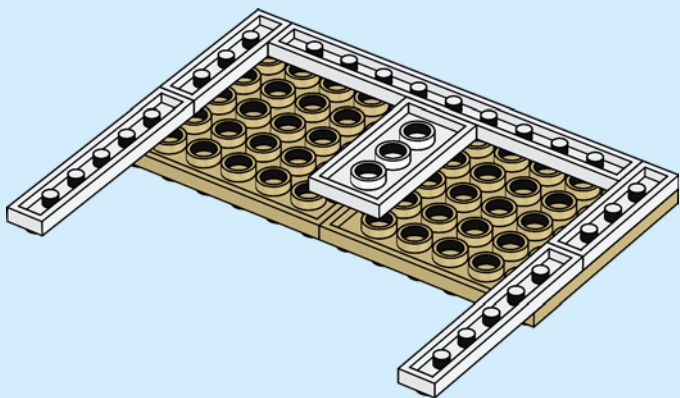

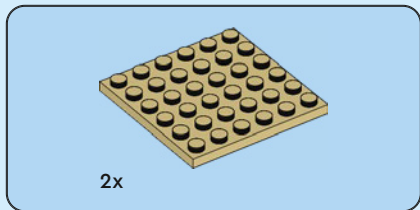

7

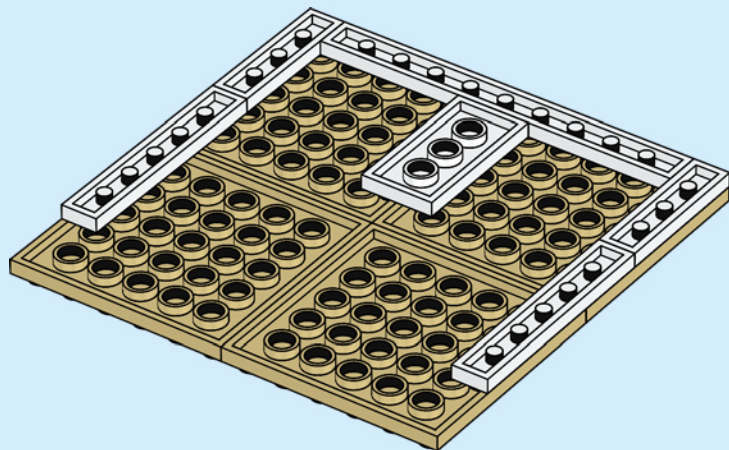

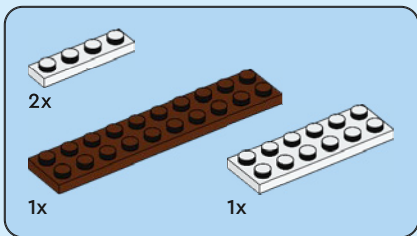

8

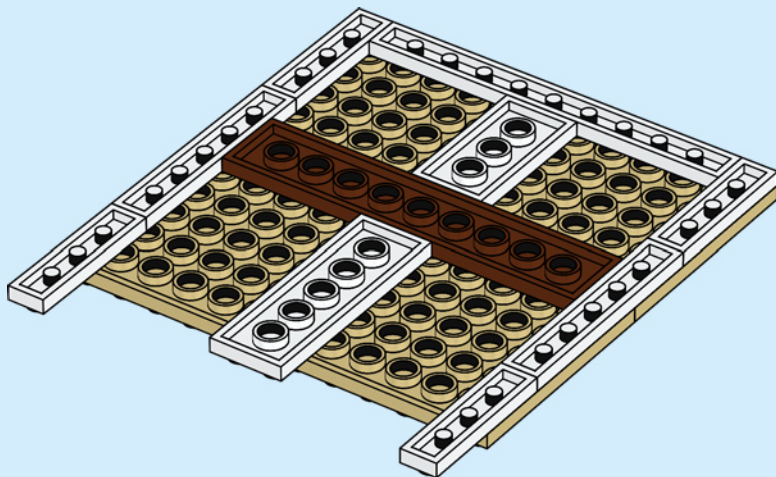



2x

9

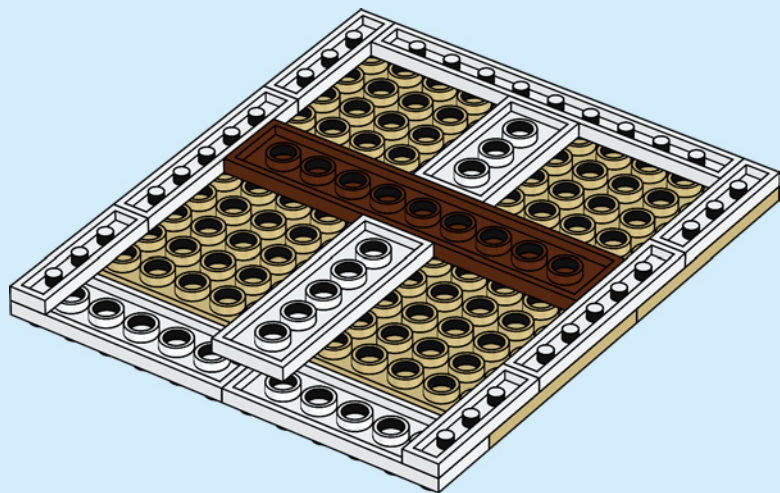

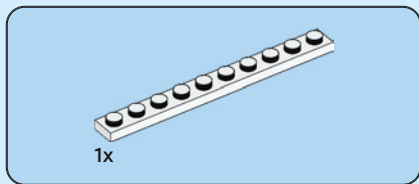

10

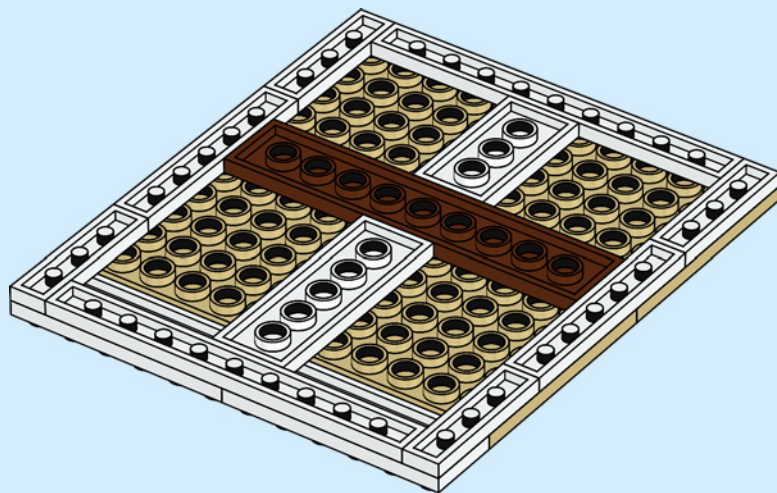

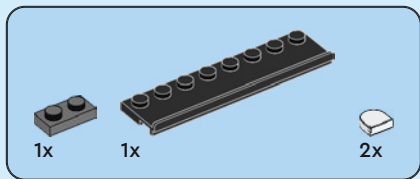

11

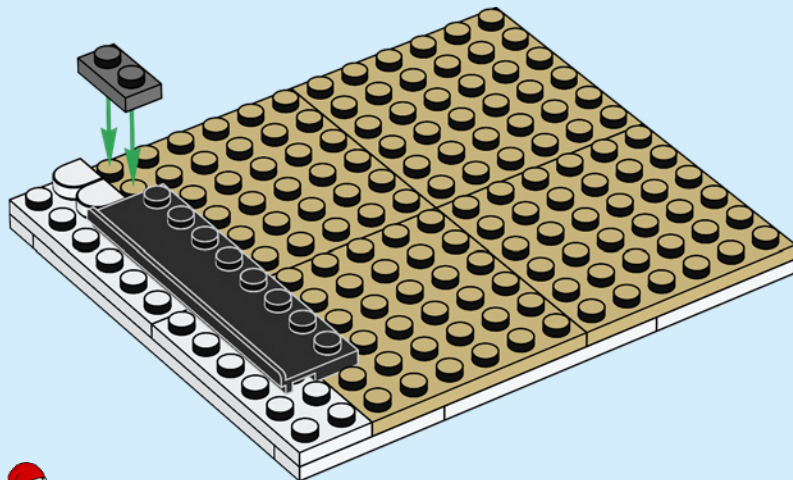



1x



4x



2x

12

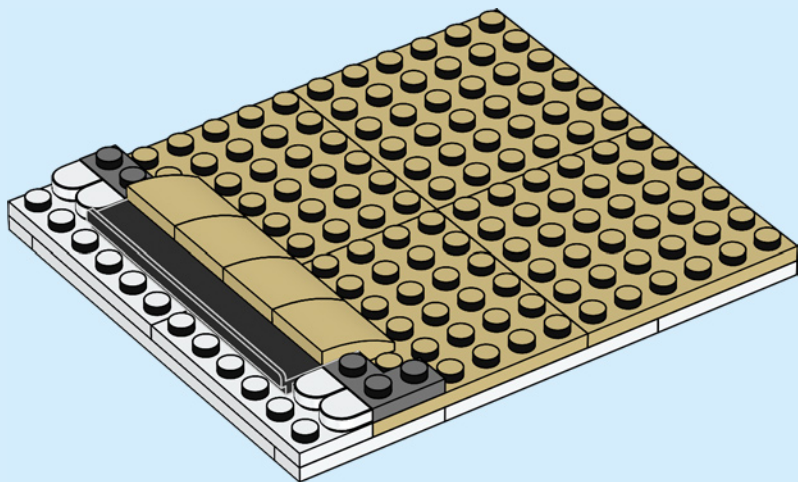

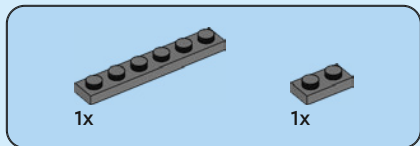

13

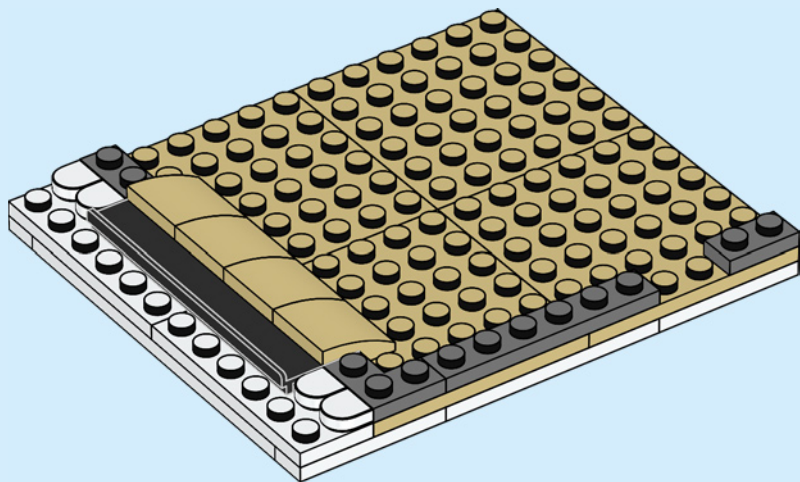

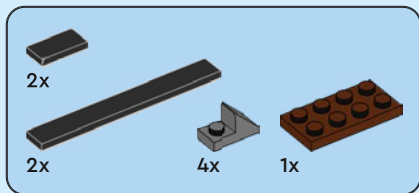

14

1



2



3

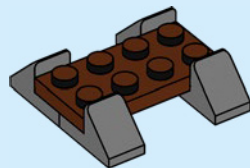

4

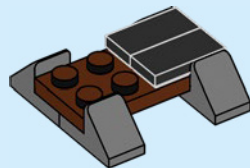

5

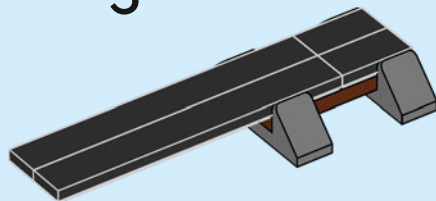

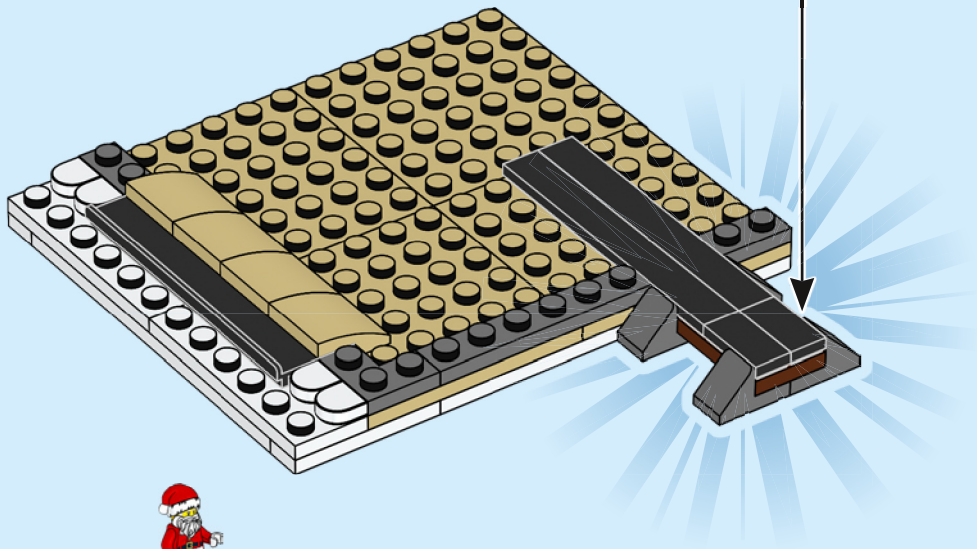

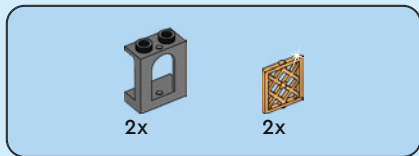

15

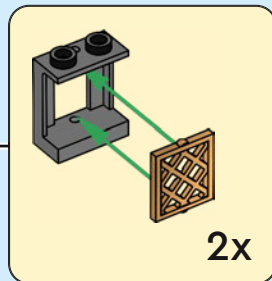
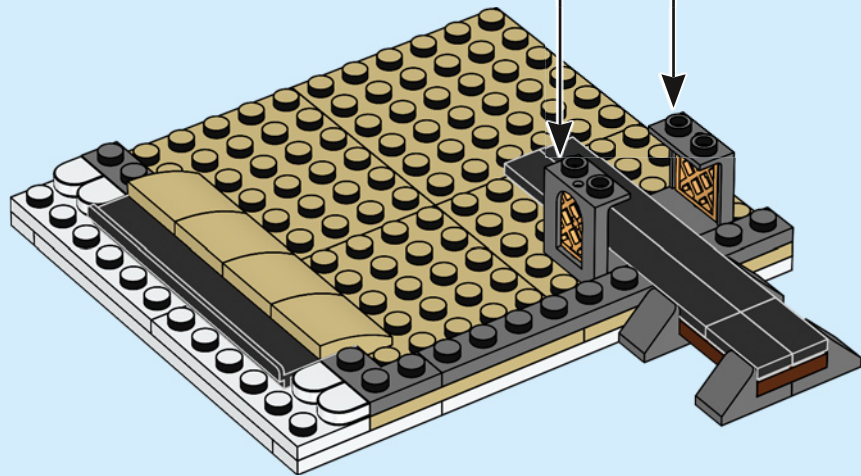



2x

16

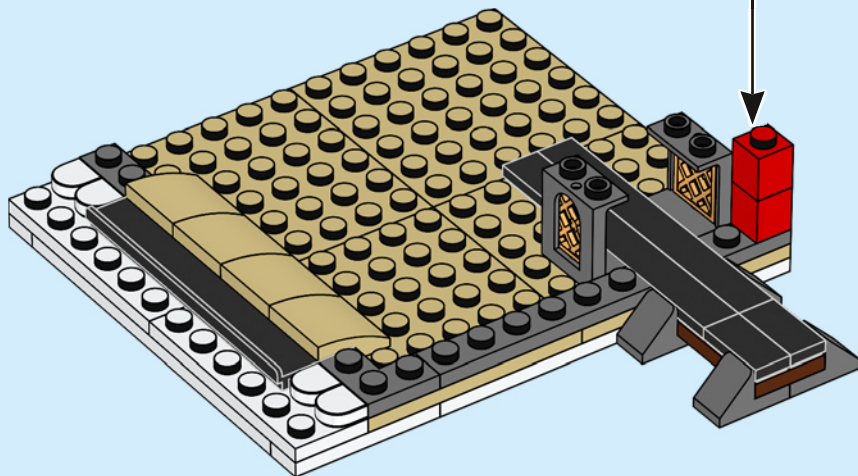
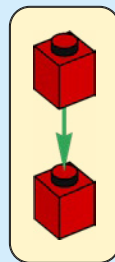

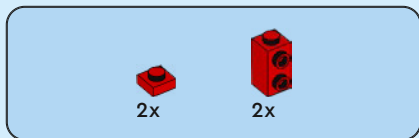

17

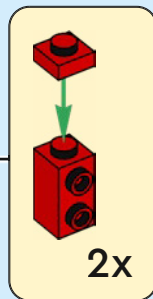
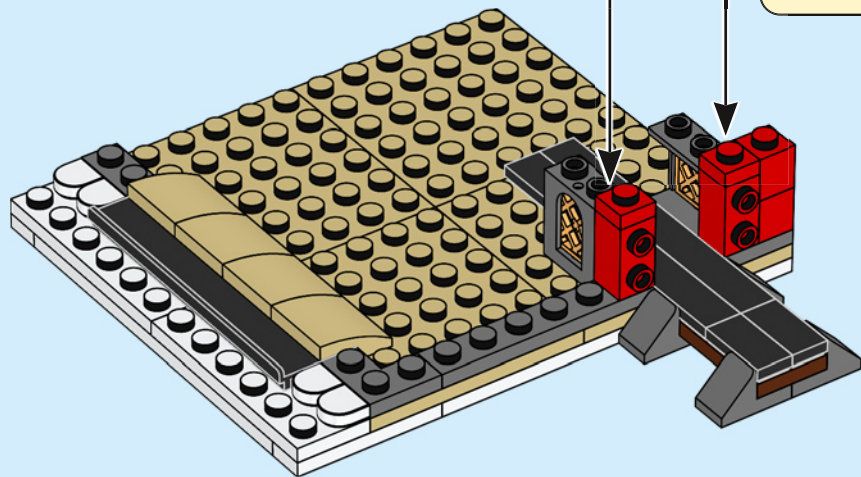

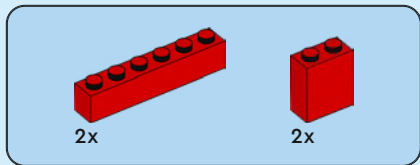

18

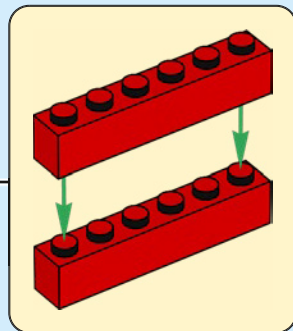
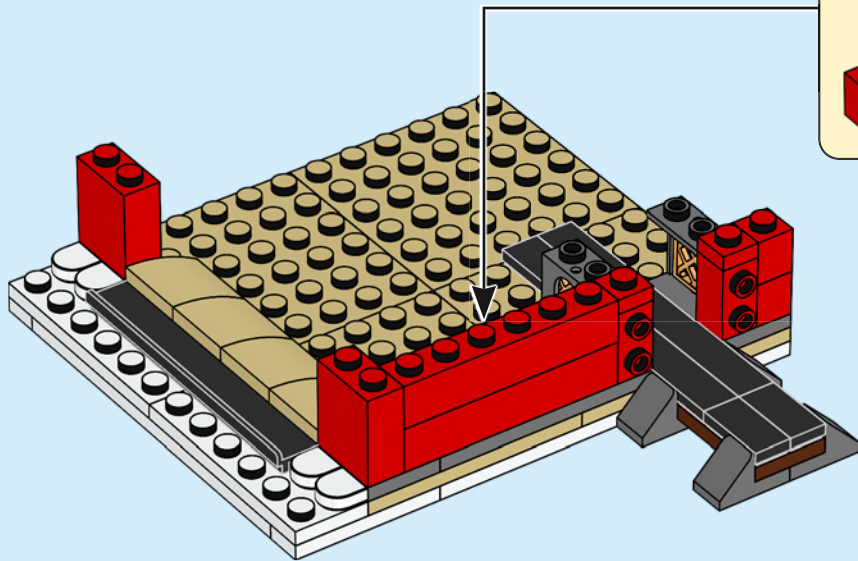



2x



2x

19

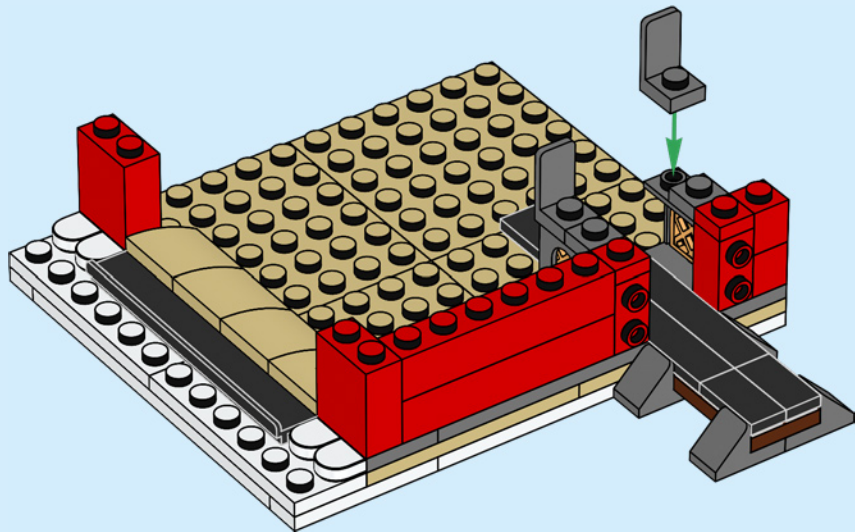

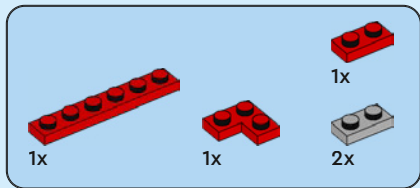

20

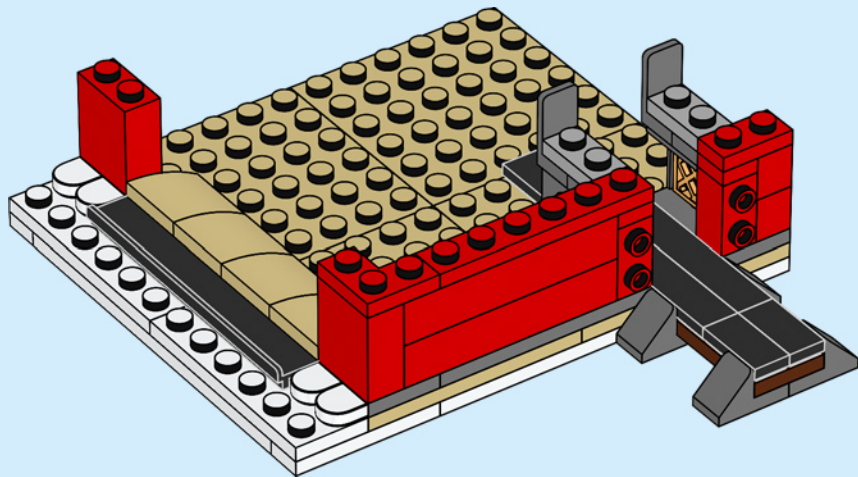

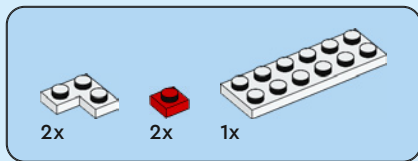

21

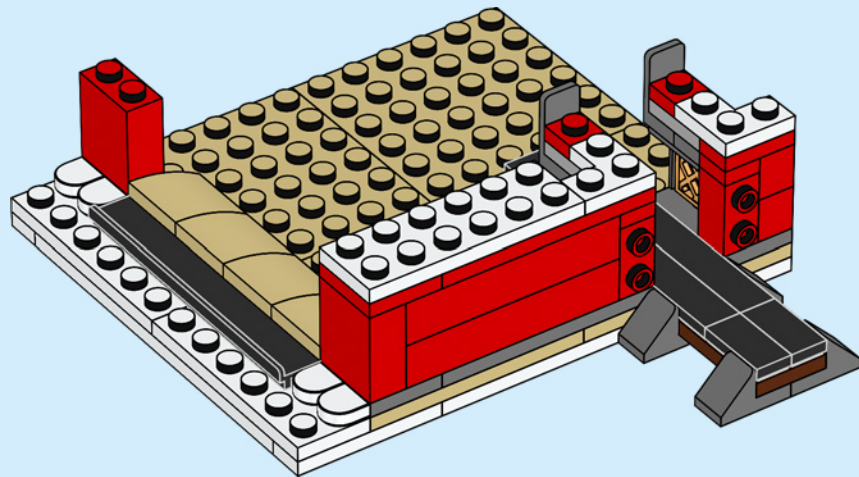



2x



1x



1x

22

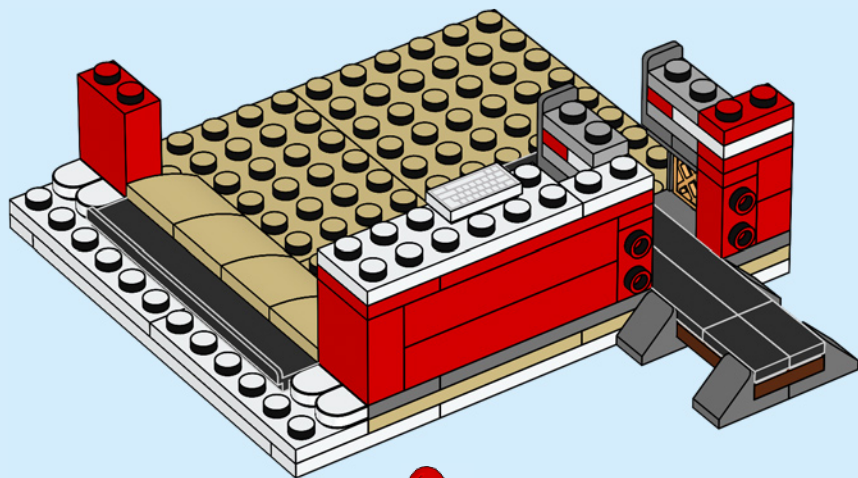

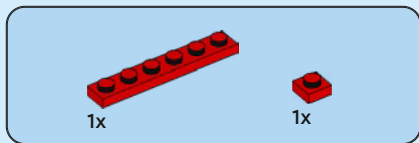

23

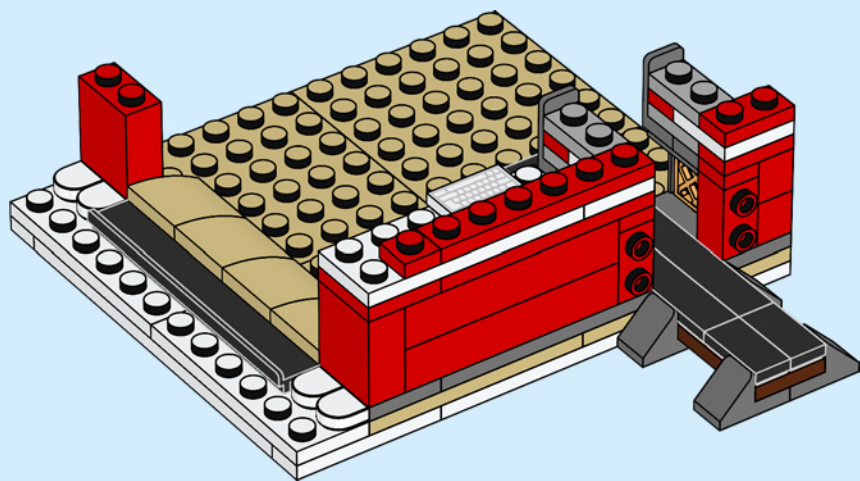

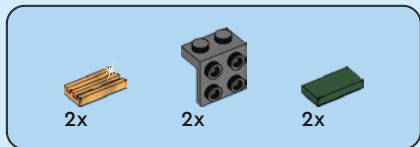

24

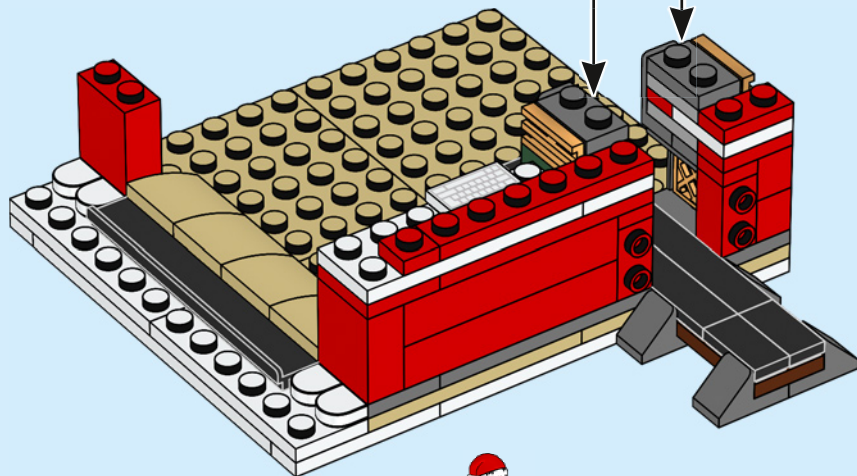
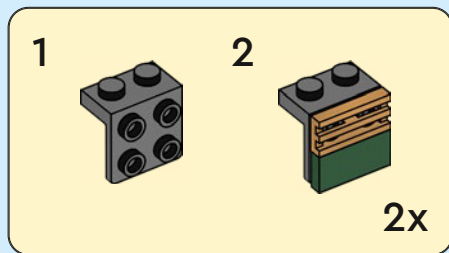

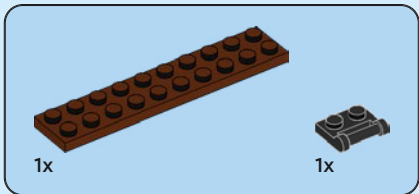
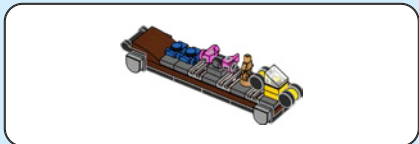

25

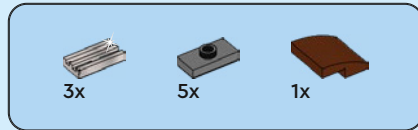
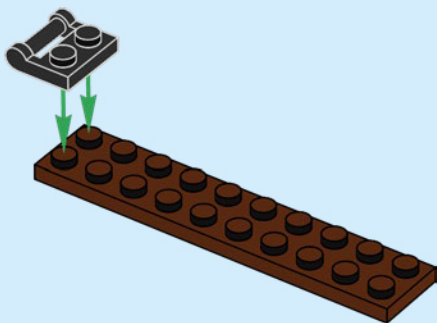

26

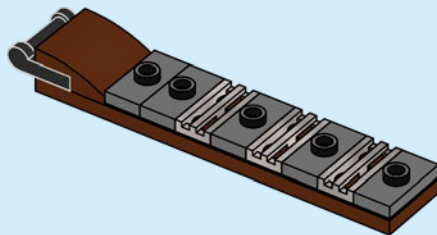



4x



4x

27

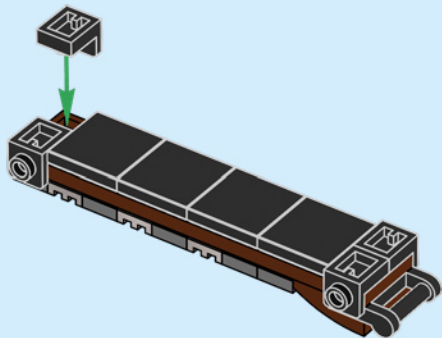

4x

28

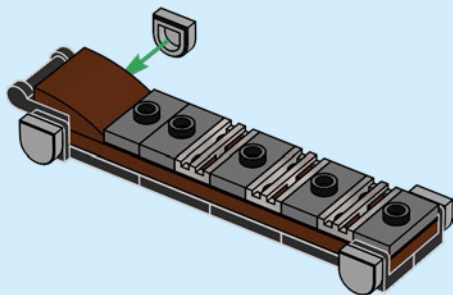



2x



1x



1x



1x

29

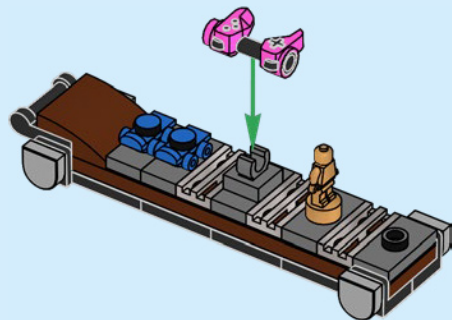

1x



2x



4x

30

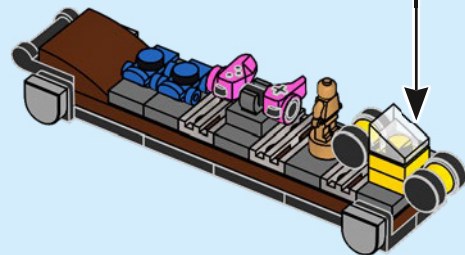
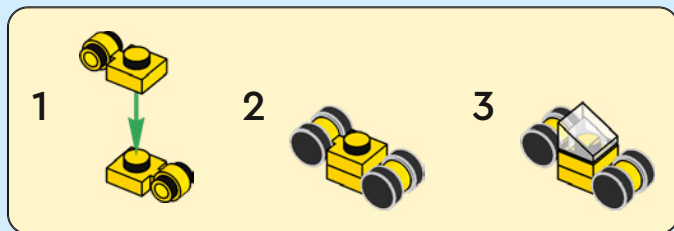

31

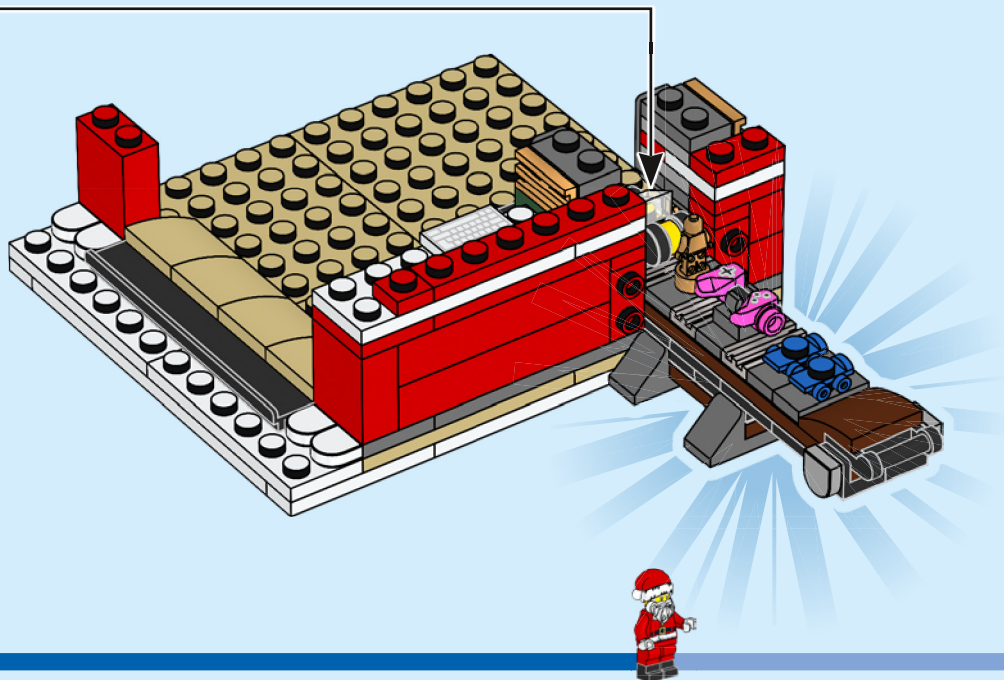

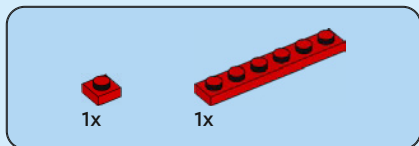

32

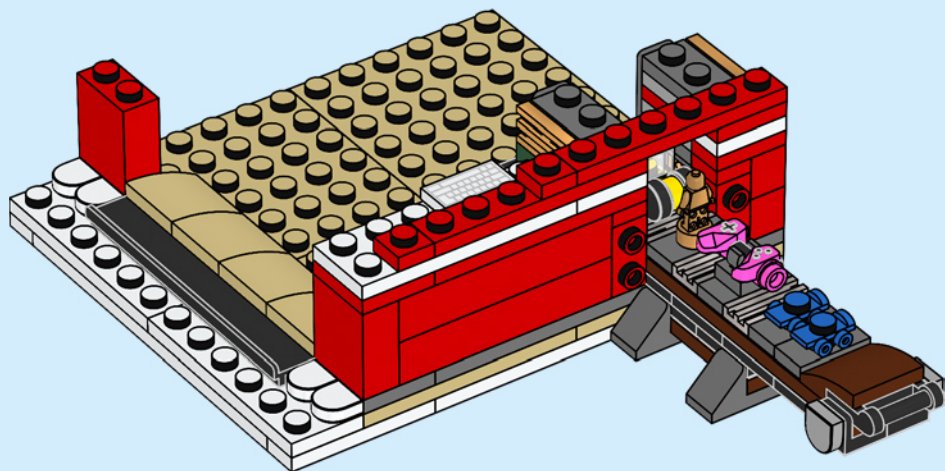



1x



2x

33

1

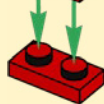
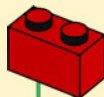

2

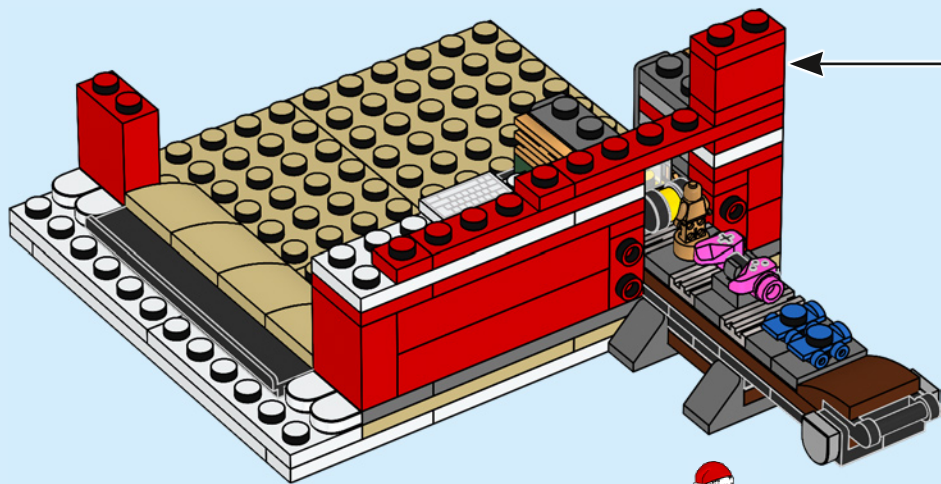
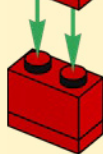



2x

34

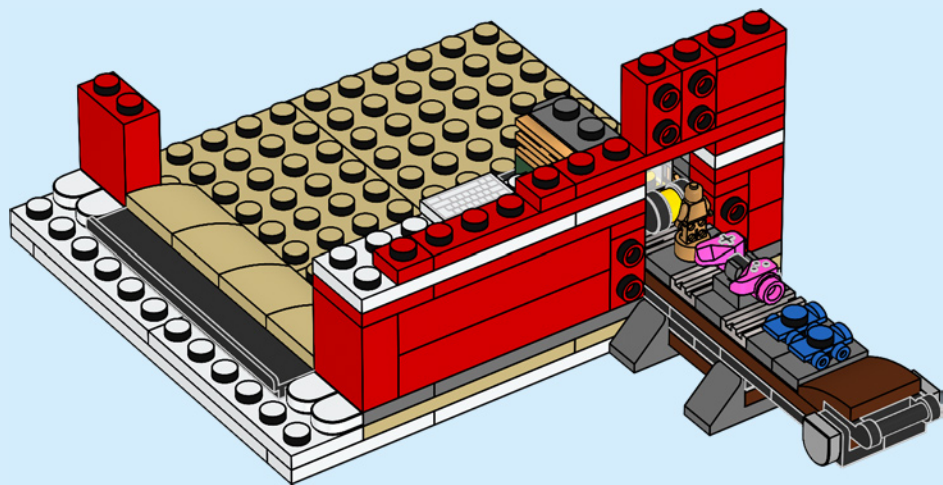

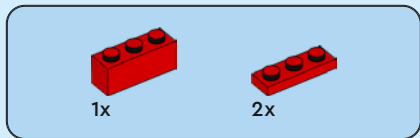

35

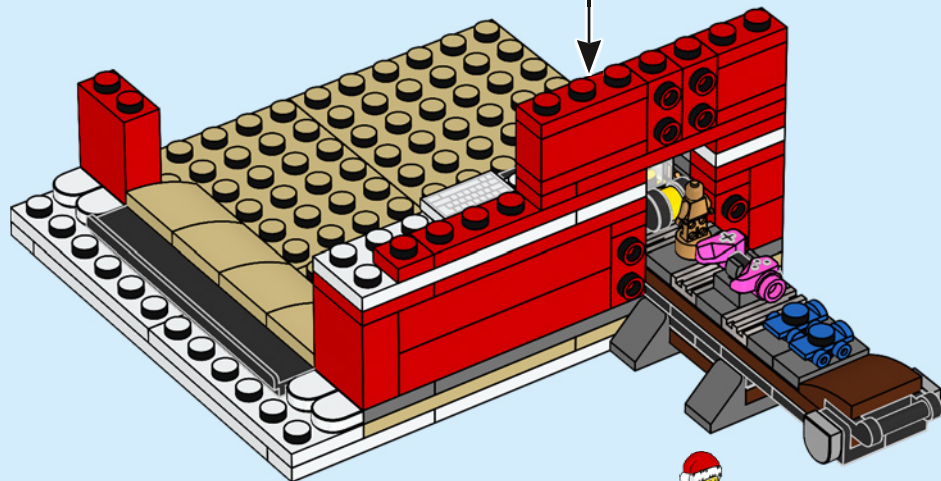
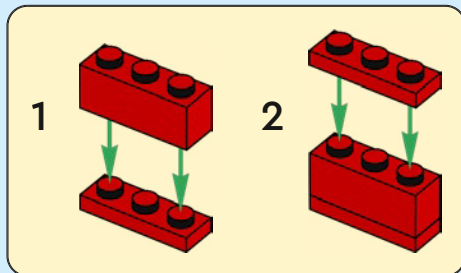

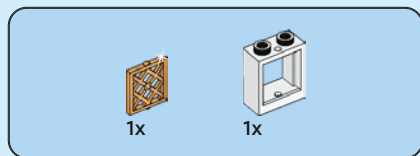

36

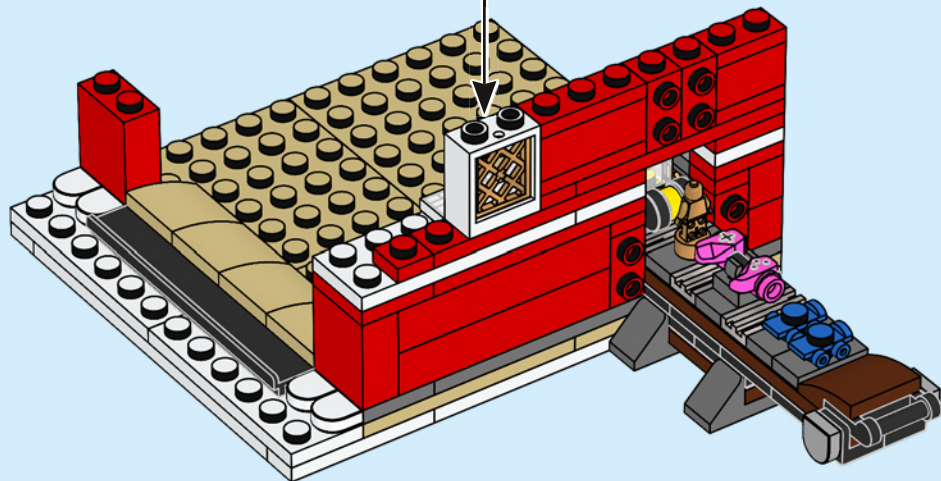
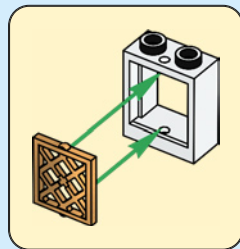

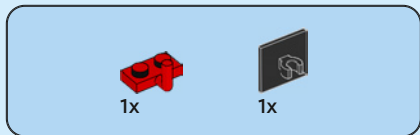

37

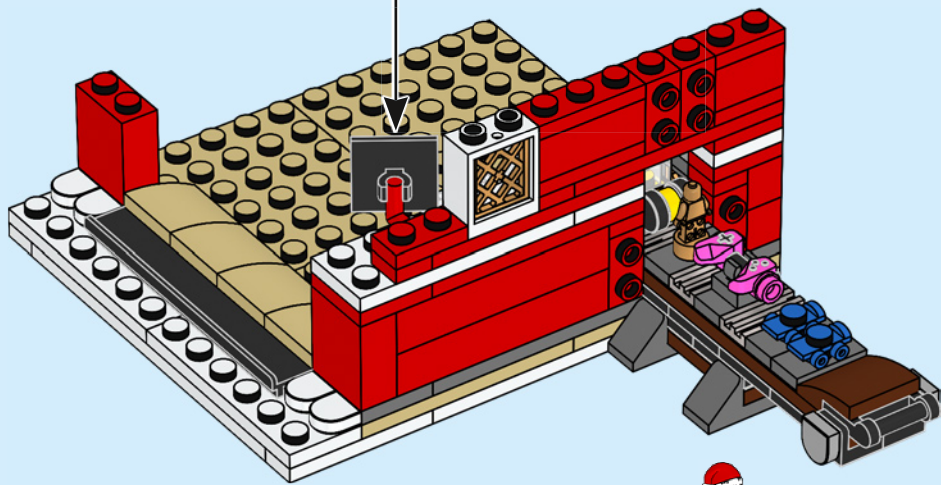

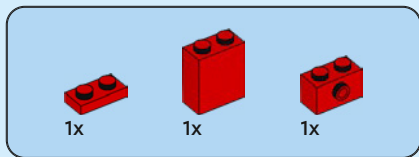

38

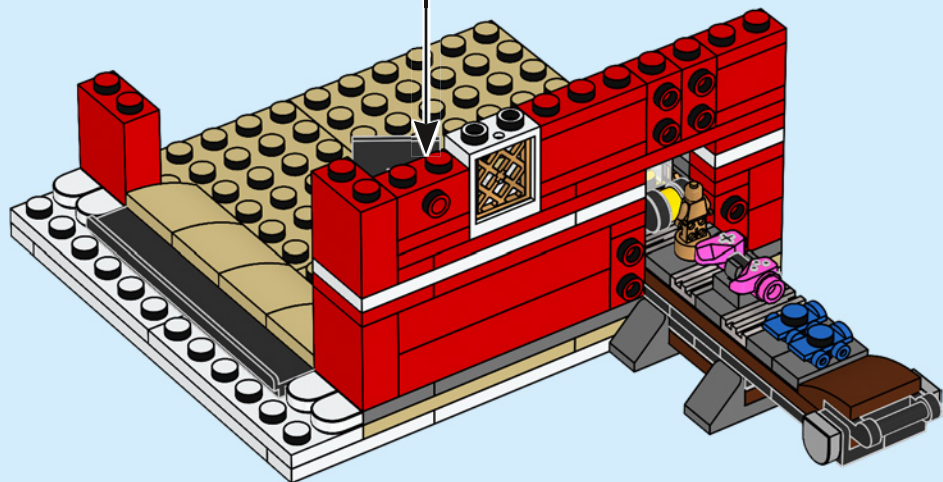
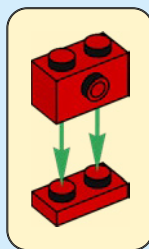



1x



1x

39

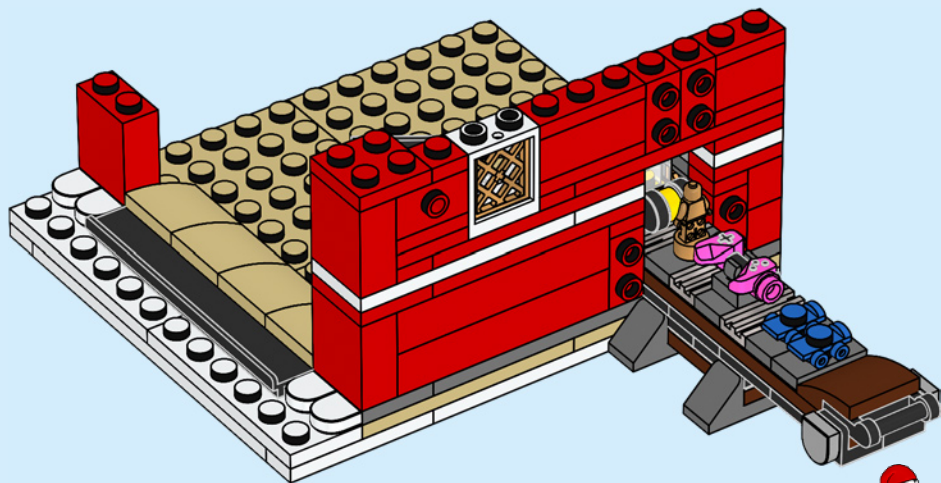

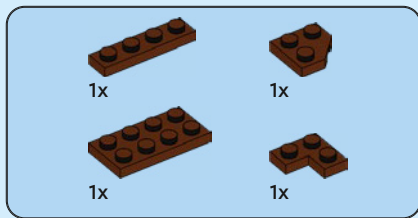

40

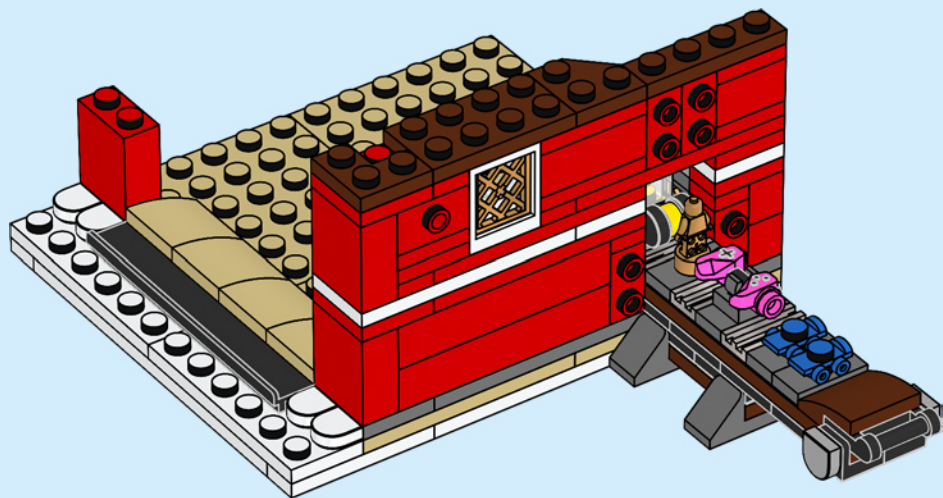



41

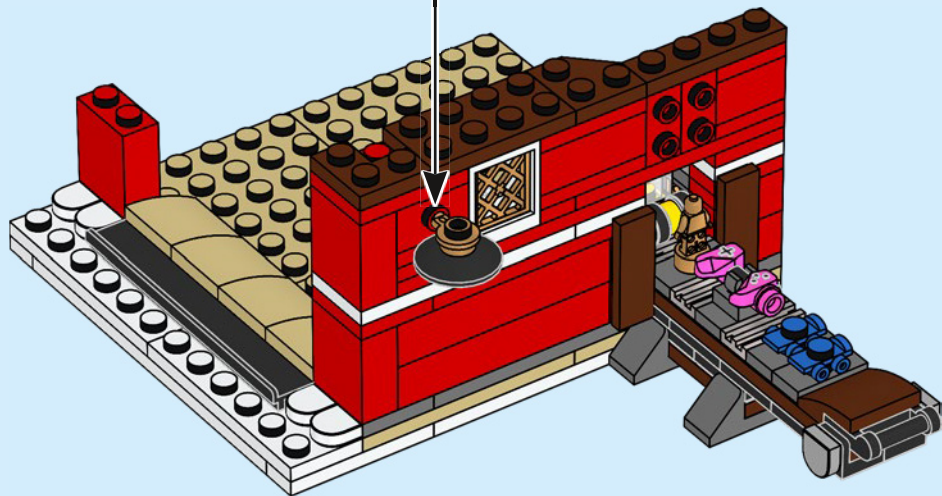

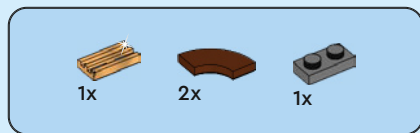

42

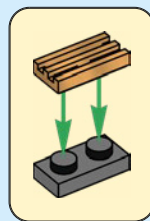

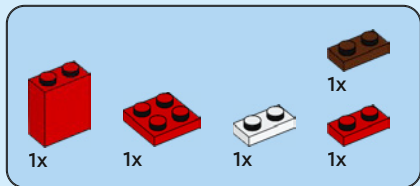

43

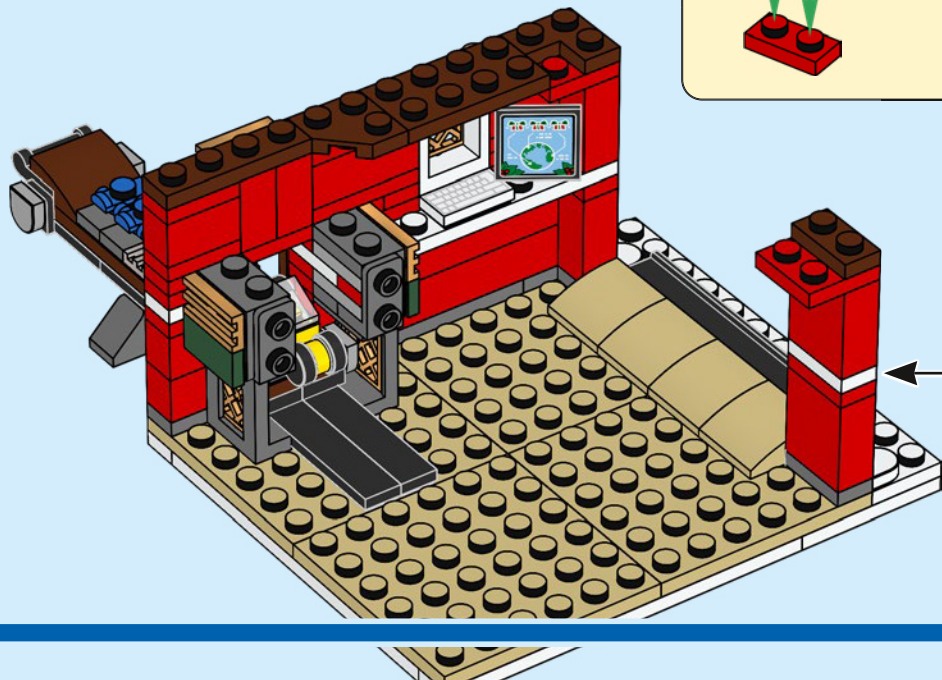
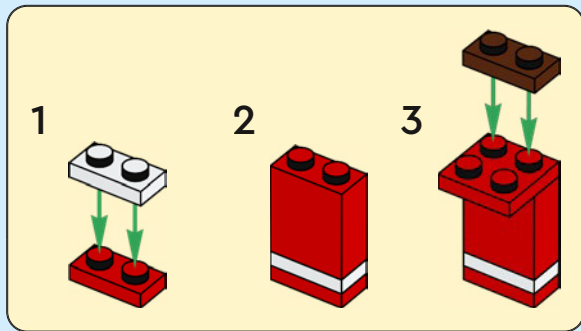

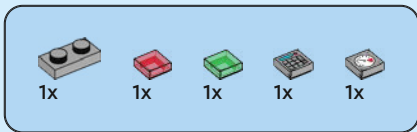

44

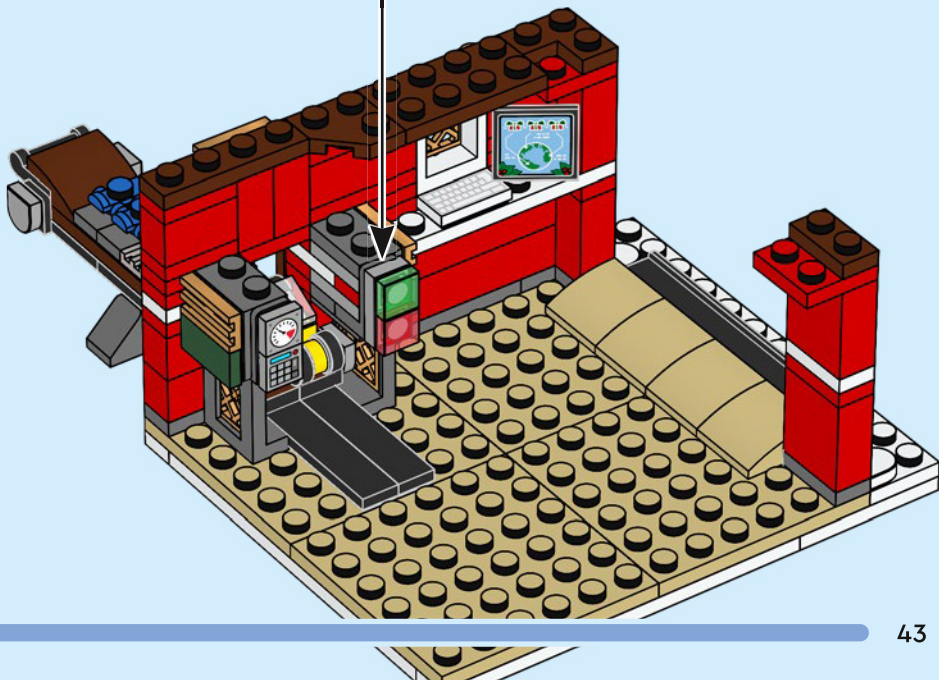
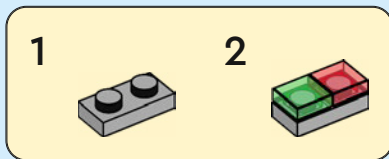

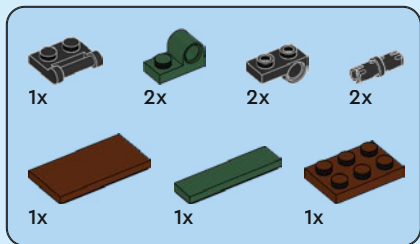

45

1



2

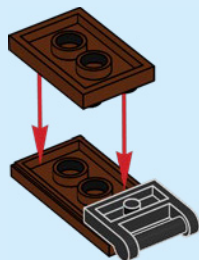

3

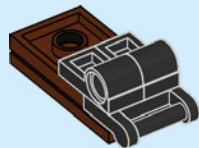

4

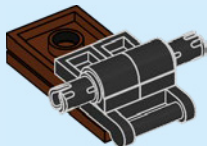

5

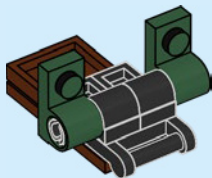

6

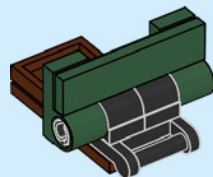

7

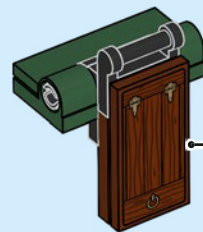

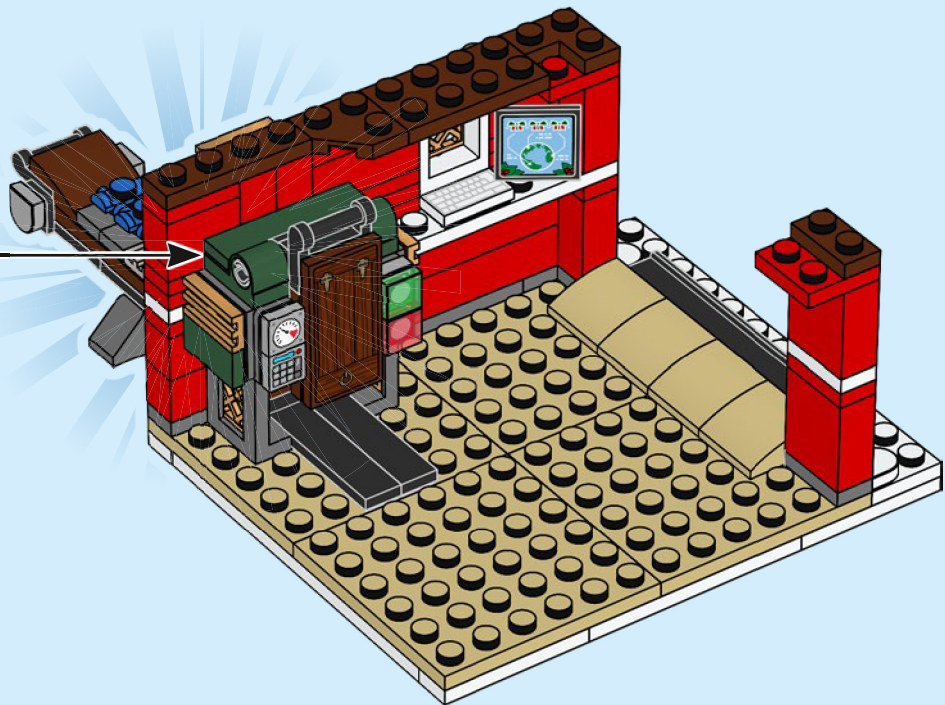

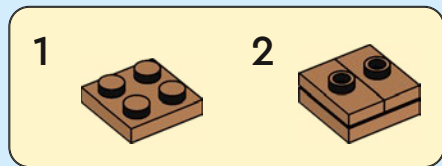
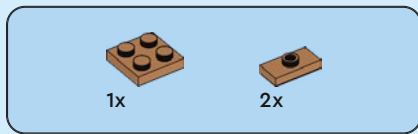

46

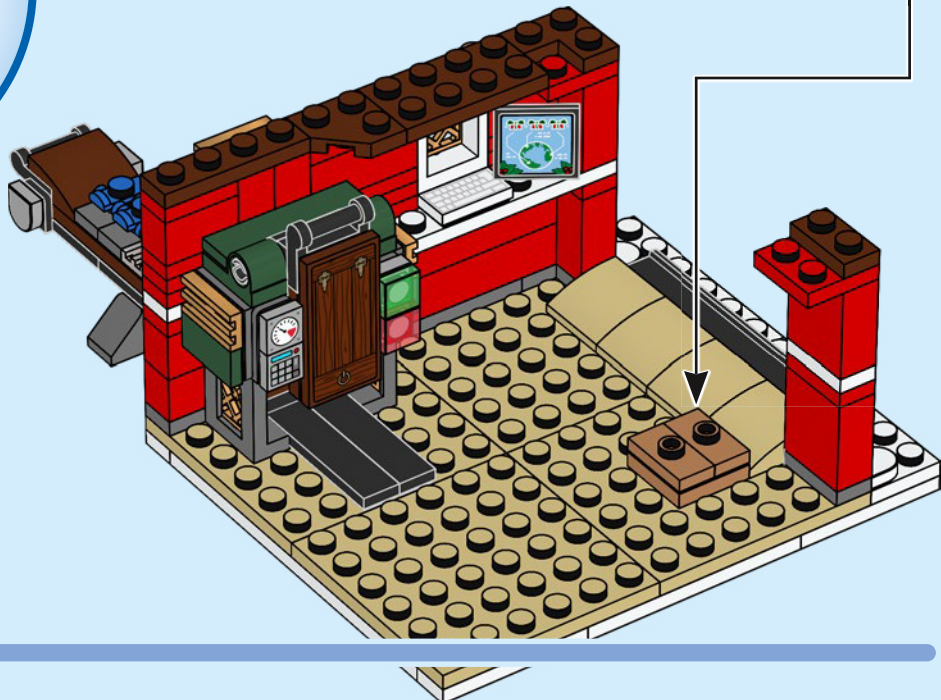



4x

47



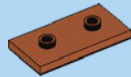

1x

48



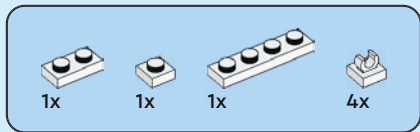

49





2x

50





51





1x

52

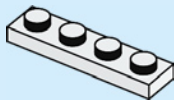

1x



1x

53

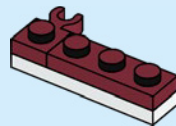



1x



3x

54

1

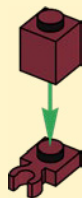

2

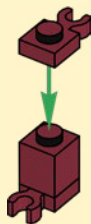

3

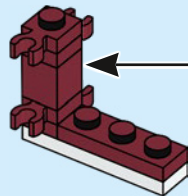

2x



1x

55

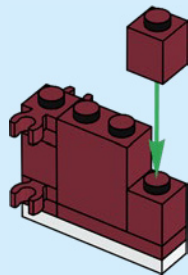



1x

56

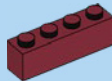
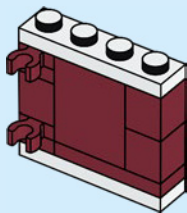

1x



1x

57

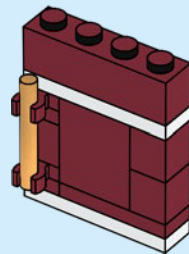



2x



1x

58

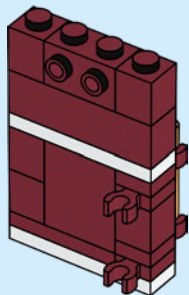

1x

59

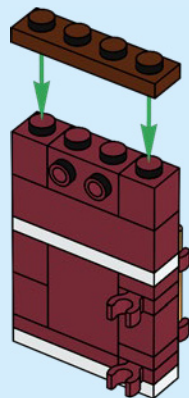



1x



1x

60

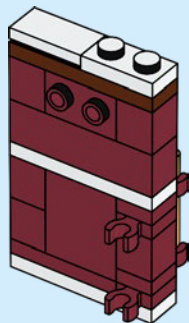

1x



2x



2x

61

1



2

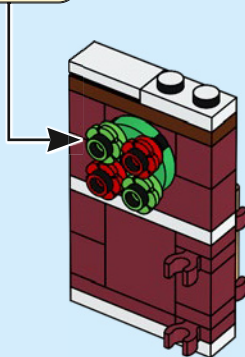



1x

62



63





1x

64

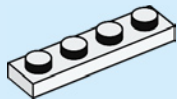

1x



1x

65

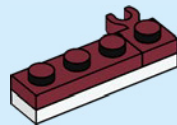



1x



3x

66

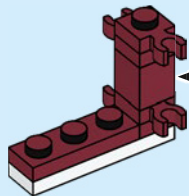
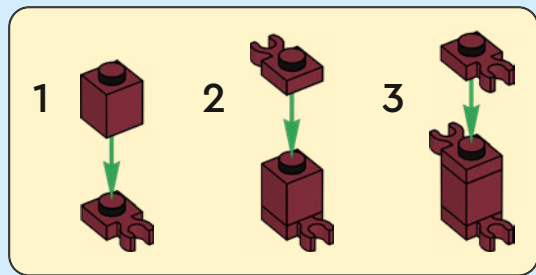

2x



1x

67

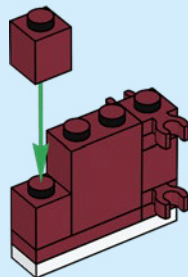

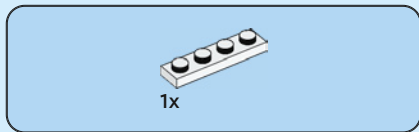

68

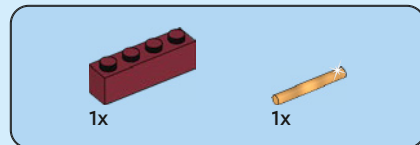
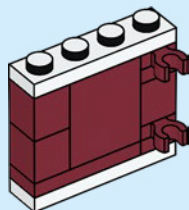

69

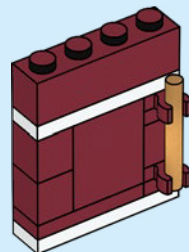



2x



1x

70

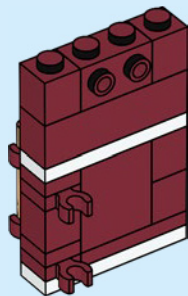

1x

71

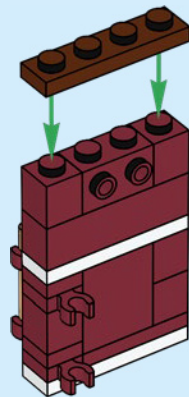



1x



1x

72

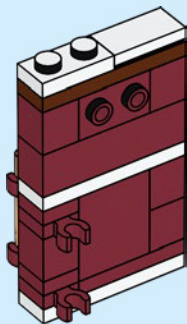

1x



2x



2x

73

1



2

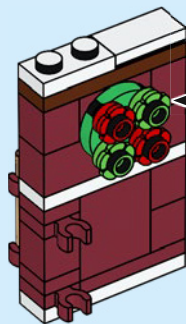



1x

74



75



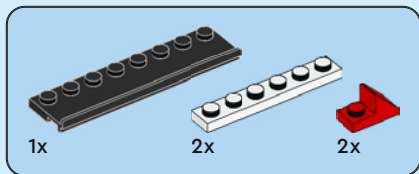

76

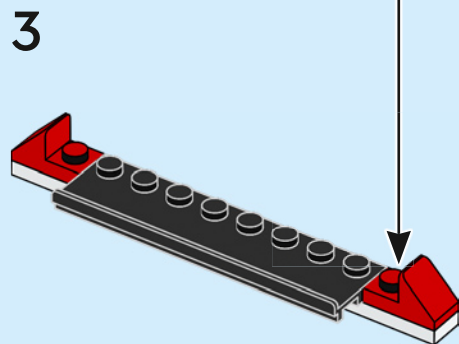
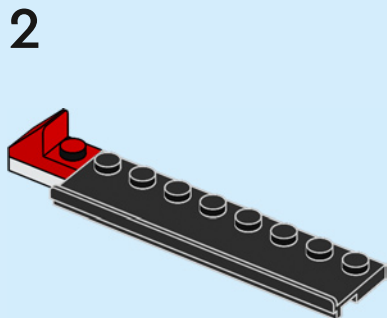
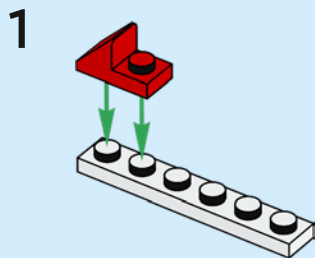





2x



1x

77



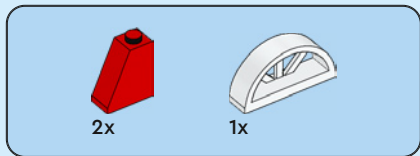

78



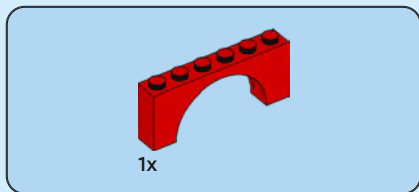

79



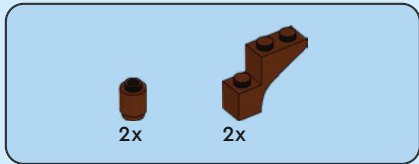

80

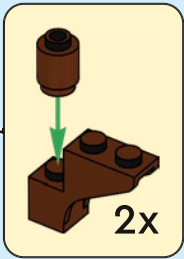



2x

81





1x

82





4x

83

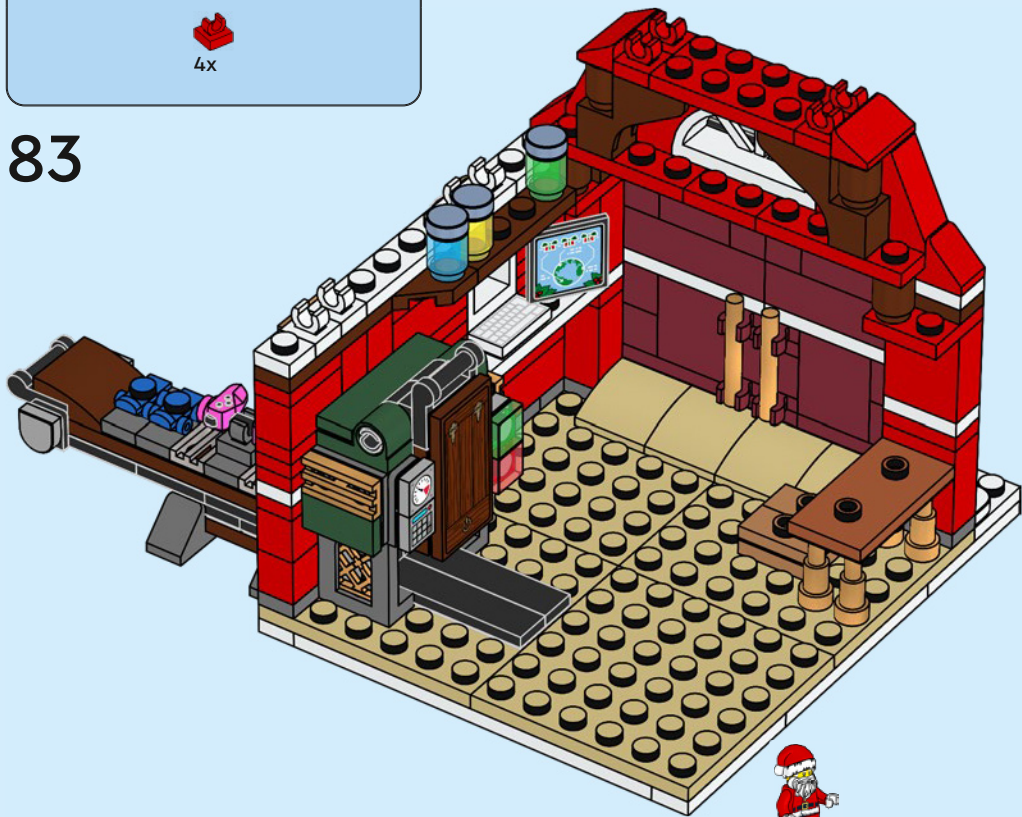



2x

84



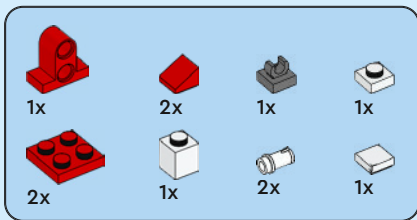

85

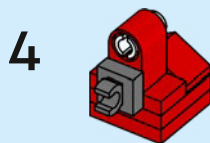
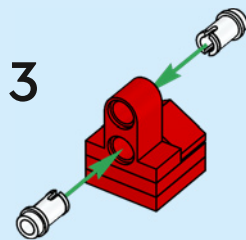
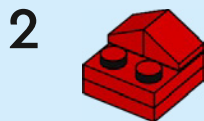
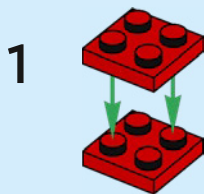

5

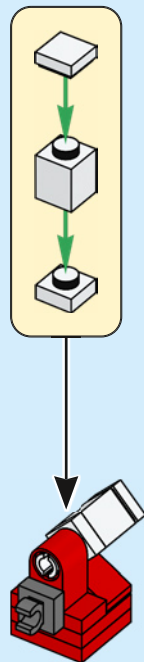

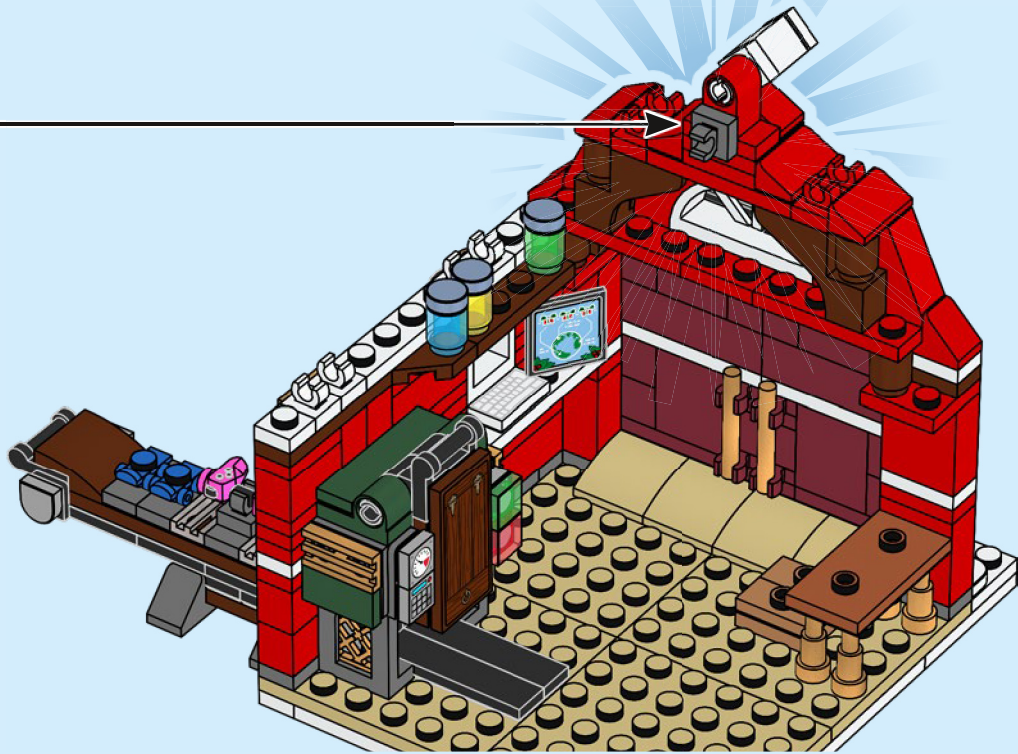

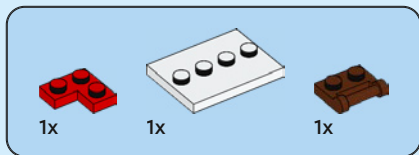

86



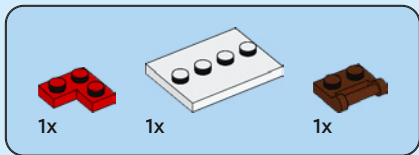

87

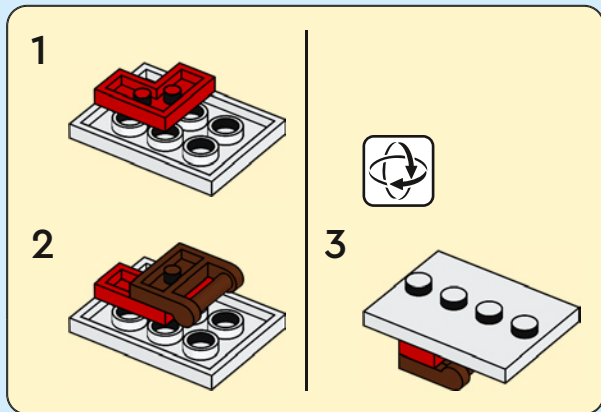

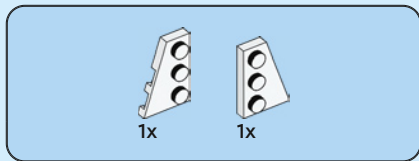

88

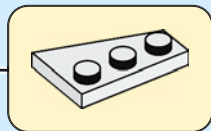

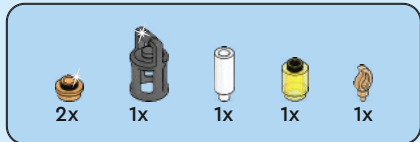

89

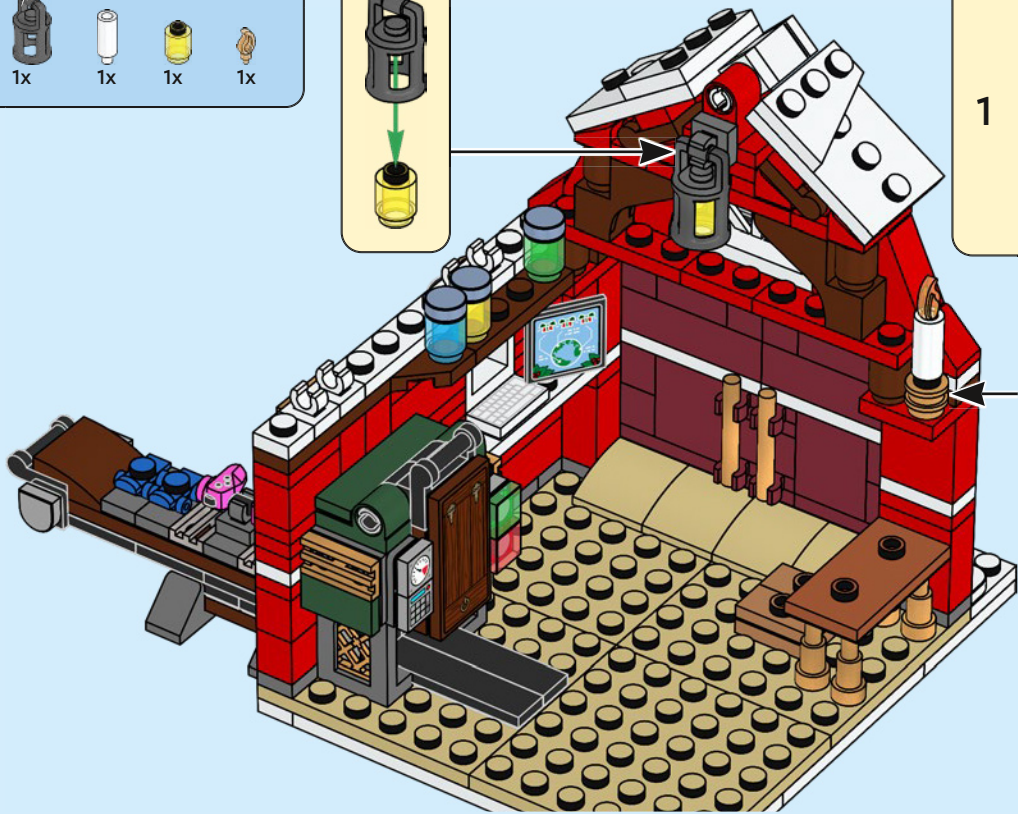
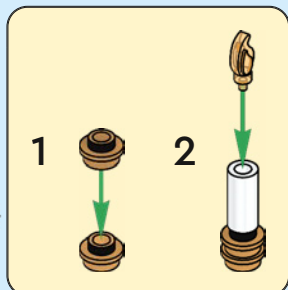
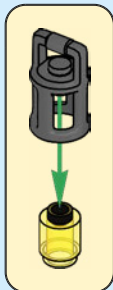

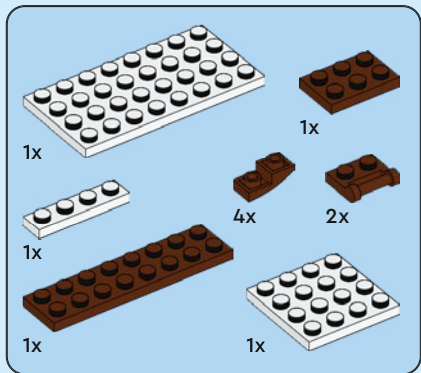

90

1

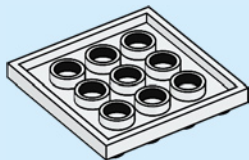

2

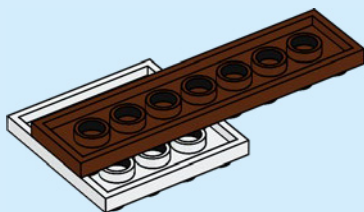

3

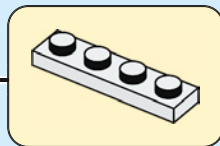
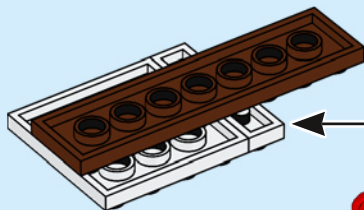

4

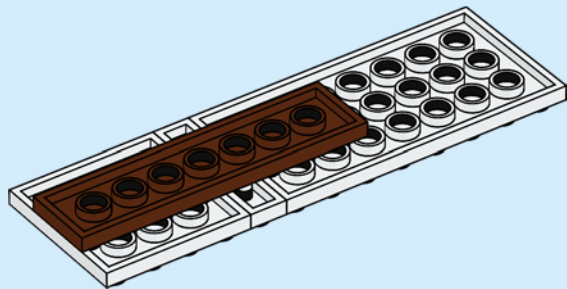

5

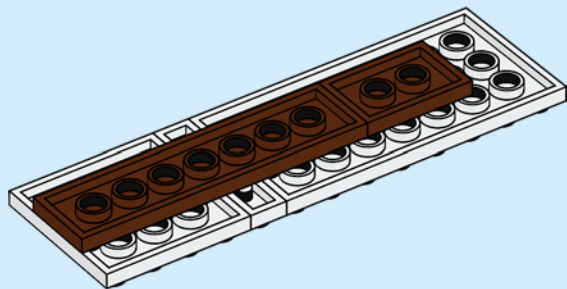

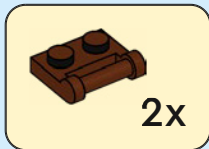

6

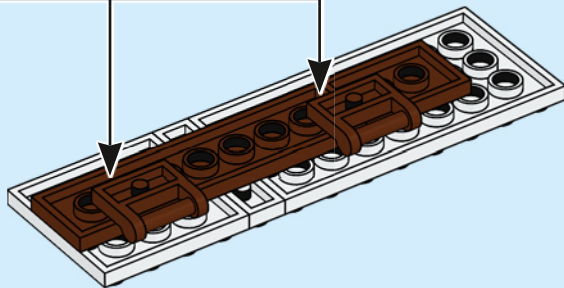

7

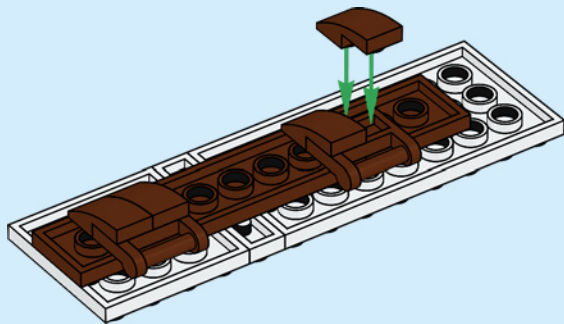

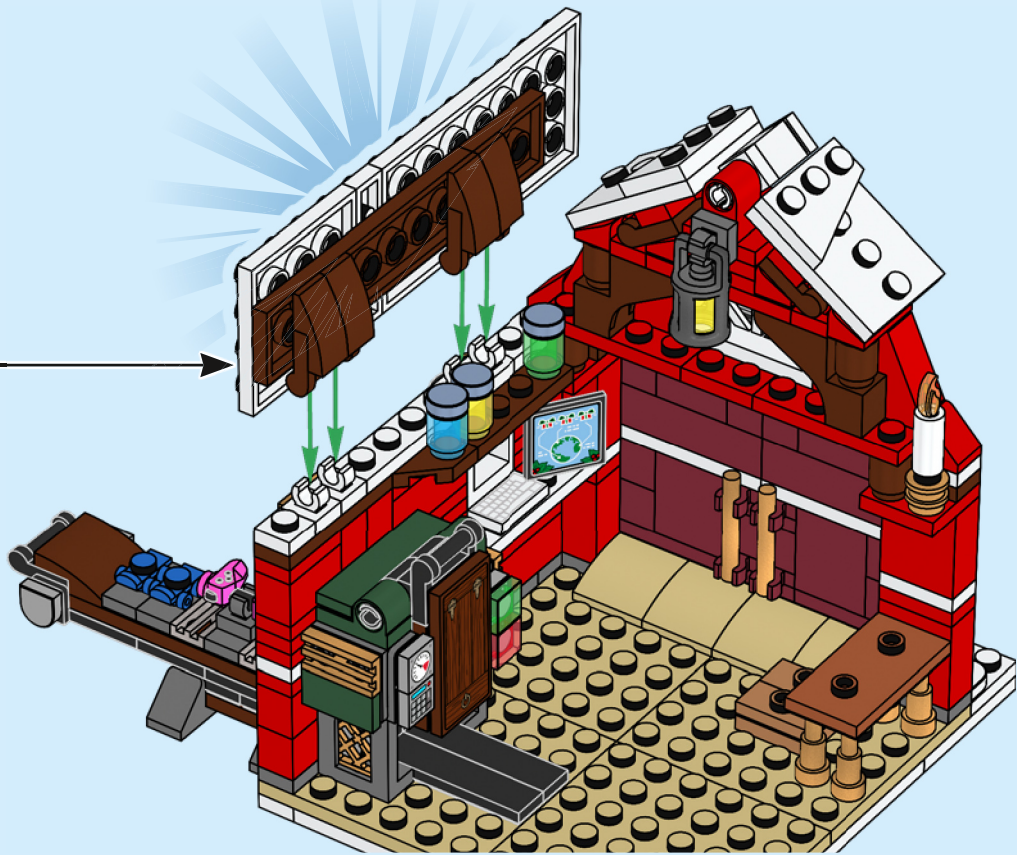

1x	2x	2x	1x	1x	1x

91

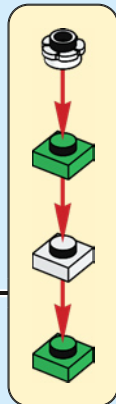
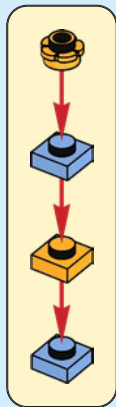

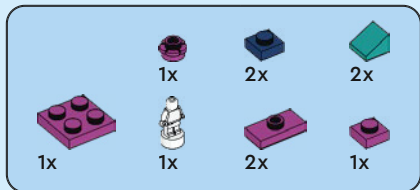

92

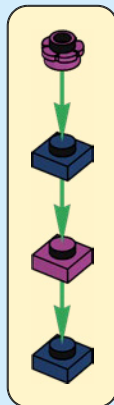
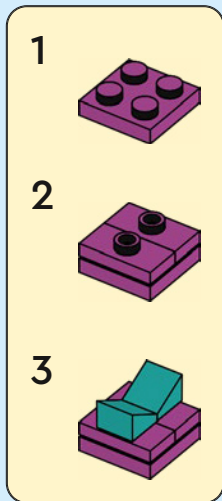

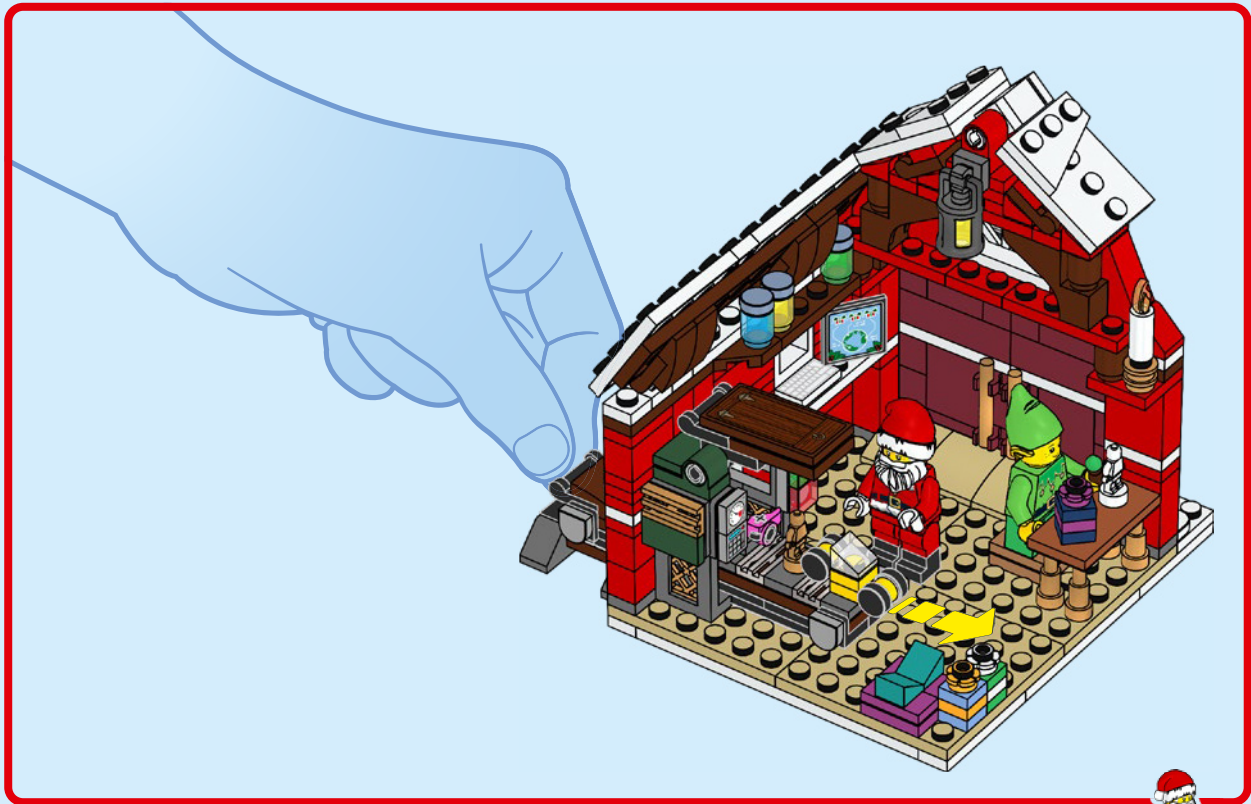





















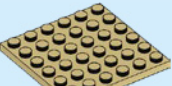





















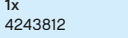















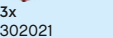



















40565

40564

 1x 6234807	 1x 6055830	 1x 4179875	 1x 4179874	 4x 6046924	 1x 6381759	 3x 242021	 1x 6105708	 4x 6284070
 1x 6299492	 1x 302001	 2x 6132741	 4x 4125217	 1x 6397572	 5x 302221	 1x 6350457	 4x 6234695	
 1x 6206149	 1x 6382045	 4x 366601	 2x 362321	 6x 302321	 1x 6194403	 1x 6056378	 2x 6279875	
 4x 6250591	 1x 6329575	 1x 4243812	 1x 6106184	 1x 6261351	 4x 6206148	 2x 6281992	 2x 474026	
 2x 6388018	 4x 302301	 1x 4243812	 1x 362221	 4x 4143832	 7x 302421	 2x 302428	 2x 306926	
 3x 302401	 2x 306901	 4x 379501	 3x 302021	 1x 300421	 4x 6187620	 2x 403228	 2x 6192309	
 4x 6348055	 2x 242001	 2x 447701	 2x 300921	 2x 6053011	 2x 300521	 1x 6074870	 4x 4225201	
 1x 300501	 10x 371001	 1x 303501	 2x 300921	 2x 4515371	 4x 6348058	 4x 6206150	 2x 6013867	
 1x 307001	 1x 6173064		 3x 366621	 1x 4207715	 2x 4504379	 1x 6308556	 2x 416226	
 1x 4610044					 4x 4651524	 1x 6323189	 2x 6161298	

2x
6326011

2x
6345507

1x
4543949

1x
6238046

1x
6254249

1x
6209682

1x
6096942

2x
6101073

1x
6109930

3x
6322842

2x
4179826

10x
4541376

8x
6359695

2x
6212084

2x
6252545

2x
4539076

2x
6052777

1x
6359662

4x
4211183

1x
6218366

1x
4211150

4x
6172922

4x
6236915

1x
4211257

2x
6342958

1x
6146858

2x
6100769

2x
6186577

2x
4211189

3x
4211190

2x
4211186

1x
4579690

1x
4211211

2x
4211214

1x
4211056

2x
6117972

1x
4210635

2x
4210719

2x
6344022

2x
6336390

3x
4211063

2x
6181291

4x
6069164

5x
6092572

2x
4184108

2x
6278172

1x
6335932

2x
6190252

3x
6295686

1x
6335111

3x
4490599

4x
4538126

1x
6332088

1x
6357747

1x
6209681

1x
6073040

4x
6250597

1x
6329584

1x
6329583

5x
4211398

2x
6267163

4x
6093529

2x
6292154

1x
6056383

3x
4619636

1x
6234116

1x
6288614

1x
6245250

1x
6254248

1x
6238044

1x
6240216

2x
6238674

Customer Service
Kundenservice
Service Client
Asistenza clienti
Atención al cliente
Serviço de Apoio ao Consumidor
Ügyfélszolgálat
Klientu apkalpošanas dienests
Serviciul pentru clienți
客户服务
コンシューマーサービス
고객 서비스

LEGO.com/service

WIN

Terms & Conditions apply

Scan this QR code or go to **LEGO.COM/PRODUCTFEEDBACK** and give us your short feedback about this LEGO® set for a chance to win a cool LEGO prize.



GEWINNE

Scanne diesen QR-Code oder geh auf LEGO.COM/PRODUCTFEEDBACK

und gib uns dein kurzes Feedback zu diesem LEGO® Set. Dann hast du die Chance, einen coolen LEGO Preis zu gewinnen.

Es gelten die Teilnahmebedingungen

GAGNE

Scannez ce code QR ou rendez-vous sur LEGO.COM/PRODUCTFEEDBACK

pour donner votre avis sur ce produit LEGO® et avoir une chance de gagner un prix LEGO.

Voir Conditions Générales

GANAN

Escanea este código QR o visita LEGO.COM/PRODUCTFEEDBACK

y comparte con nosotros tu opinión sobre este set LEGO® para tener la oportunidad de ganar un fantástico premio LEGO.

Términos y Condiciones aplicables

获取奖品

只需扫描此二维码或访问 LEGO.COM/PRODUCTFEEDBACK,

就这款乐高®套装提供简短反馈,就有机会赢得很酷的乐高奖品。

《条款及条件》适用