



AVATAR

75575





 **FR**
DONNEZ
OU
RECYCLEZ

 OU  OU 

ASSOCIATION MAGASIN DÉCHÈTERIE

Adresses sur quefairedemesdechets.fr



LEGO.com/sustainable-packaging

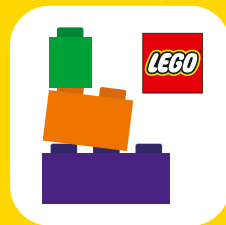

BUILDER



Apple and the Apple logo are trademarks of Apple Inc., registered in the U.S. and other countries and regions. App Store is a service mark of Apple Inc. Google Play and the Google Play logo are trademarks of Google LLC. Tencent and the Tencent logo are trademarks of Tencent Inc.

EN Ask parents' permission before going online | **DE** Eltern um Erlaubnis bitten, bevor du online gehst | **FR** Demande l'autorisation d'un parent avant d'aller en ligne | **IT** Chiedi il permesso ai tuoi genitori prima di andare online | **ES** Pídeles permiso a tus papás antes de conectarte a Internet | **PT** Pede autorização aos pais antes de acederes online | **JA** オンラインになる前に ほか者の方のきよかをもらおう | **ZH** 上网前应先征得父母的同意 | **KO** 온라인 접속 전에 보호자 동의가 필요합니다 | **RU** Спроси разрешения у родителей, прежде чем заходить в интернет | **PL** Poproś rodziców o zgodę, zanim wejdiesz do Internetu | **CS** Než půjdeš na internet, požádej rodiče o svolení | **SK** Skôr než pôjdeš na internet, vypýtaj si povolenie od rodičov | **HU** Kérj szülői engedélyt, mielőtt online csatlakoznál! | **RO** Cere permisiunea părinților înainte de a te conecta online | **BG** Поискайте разрешение от родител, преди да влезете онлайн | **LV** Pirms došanās tiešsaistē palūdz atļauju vecākiem | **ET** Enne Interneti kasutamist küsi vanematelt luba | **LT** Prieš prisijungdami prie interneto, atsklauskite tėvų

Q [LEGO.com/devicecheck](https://www.lego.com/devicecheck)

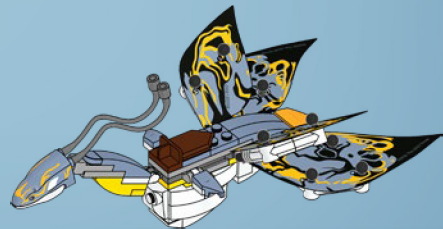
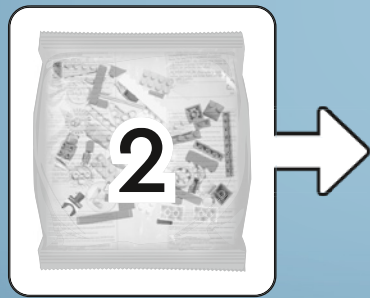
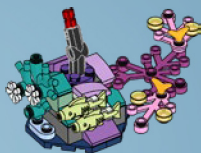



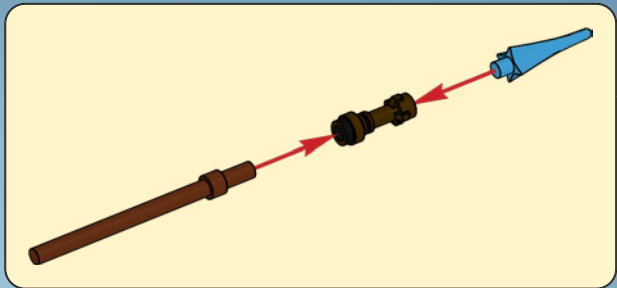

1

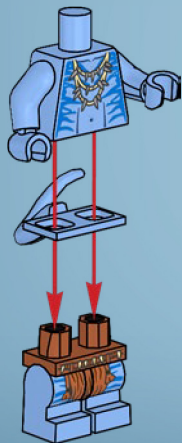

2

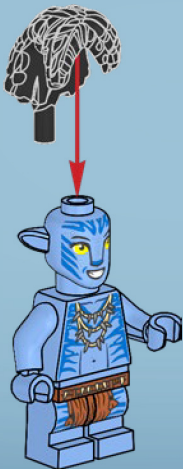

3





2x

1

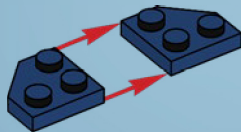

1x

2

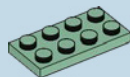
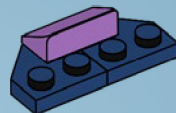

1x

3

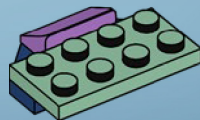



2x

4

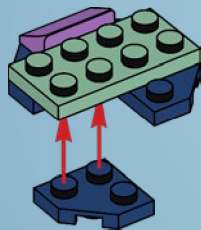

2x

5

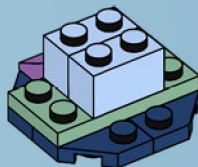



1x



1x



1x

6

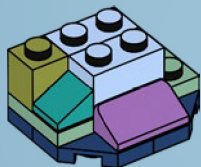

1x



1x



1x

7

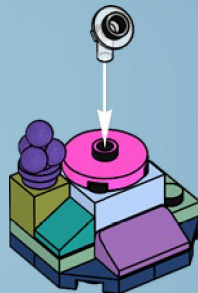

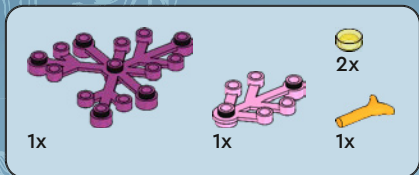

8

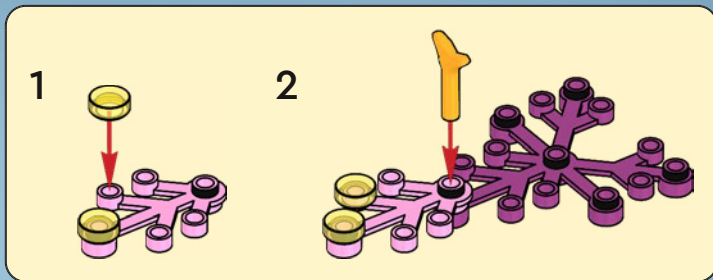



1x

9







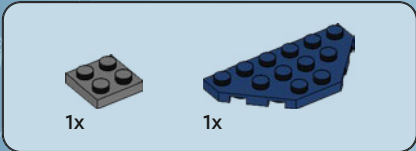
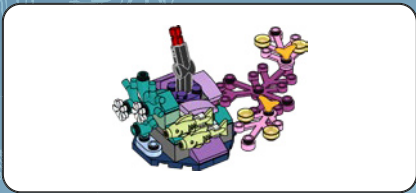

1x

1x

1

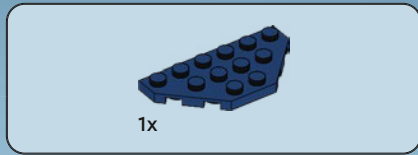
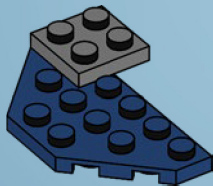

1x

2

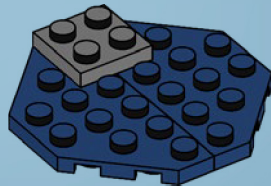



2x

3

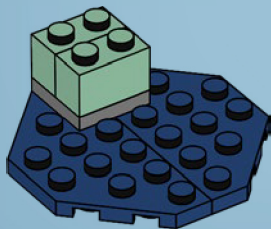

1x



1x

4

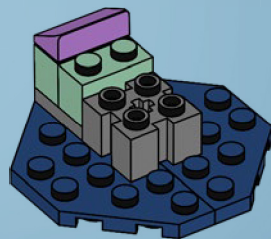

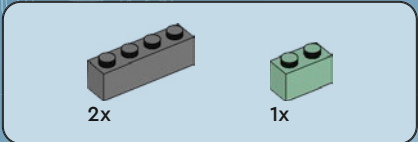

5

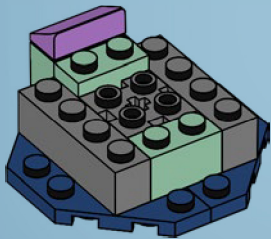

6

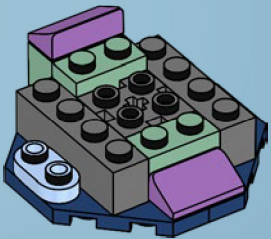

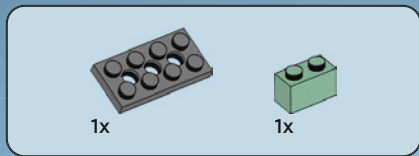

7

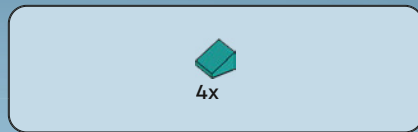
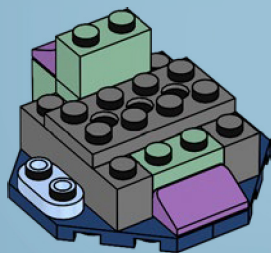

8

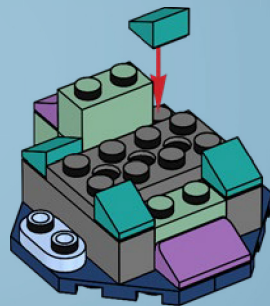



1x



1x

9

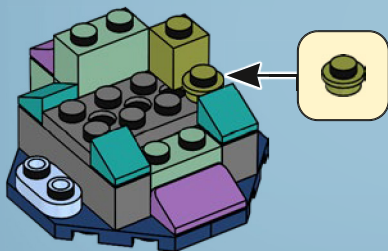

1x



1x

10

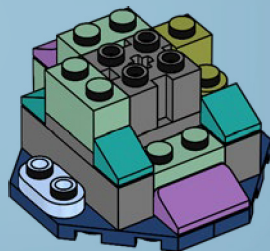



1x



1x

11

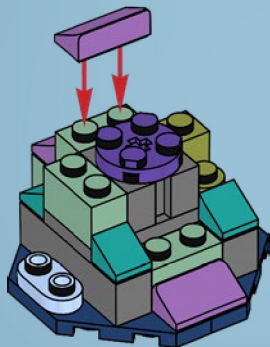

2x



1x

12

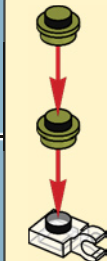
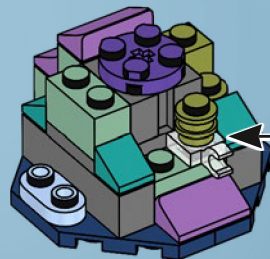



1x



1x

13

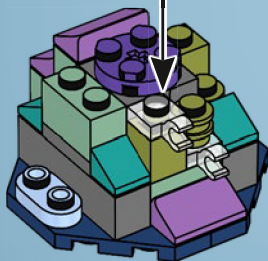
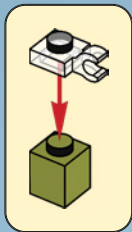

1x



2x

14

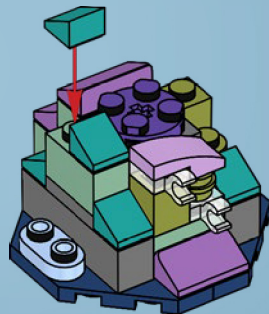



1x



2x

15

1



2

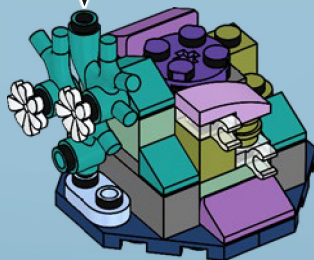
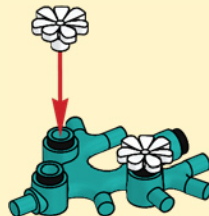



2x

16

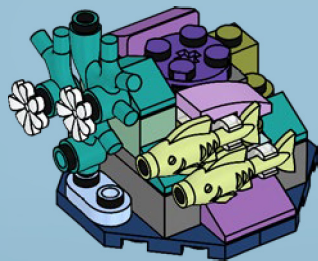

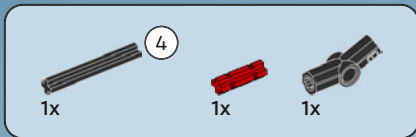

17

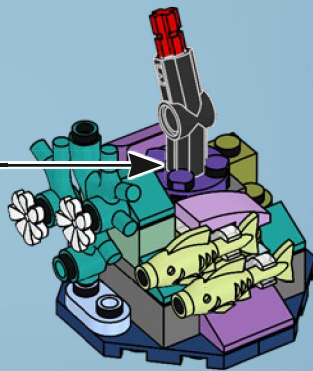
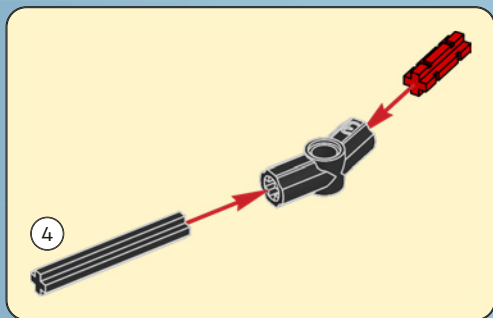



1x

18

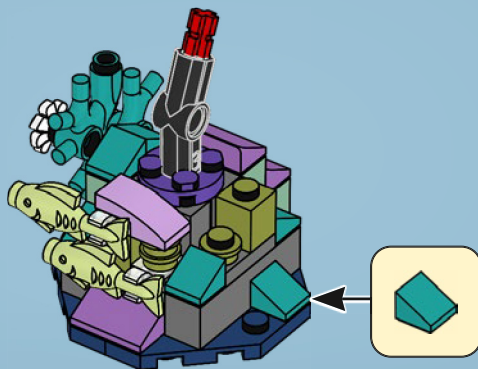

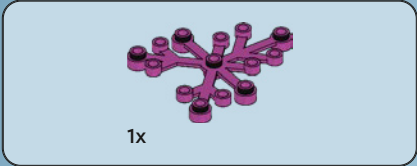

19

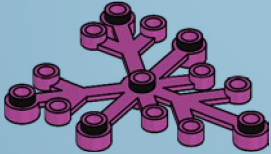

20

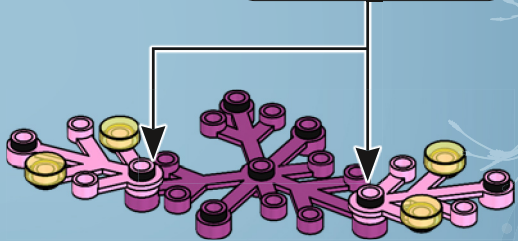
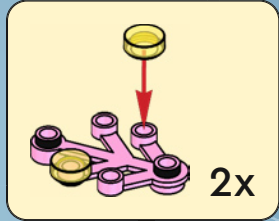



2x

21

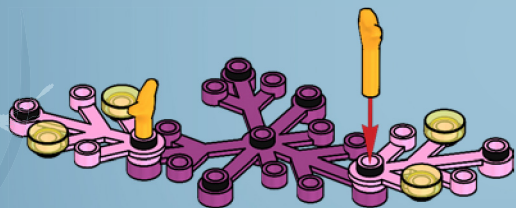

22

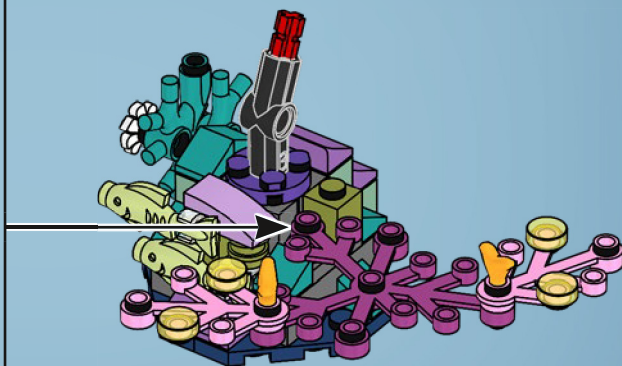



1x

23

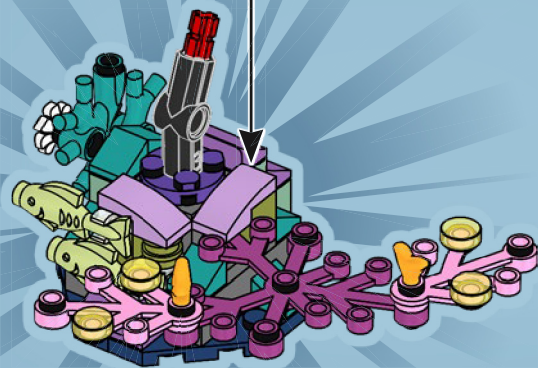







1

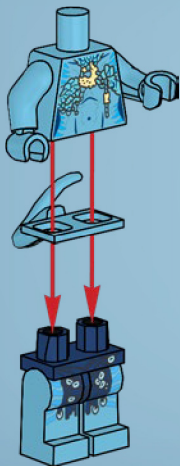

2

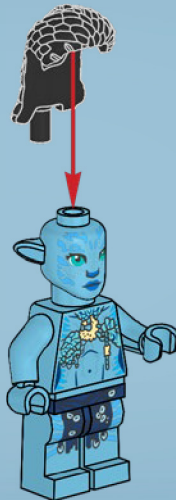

3



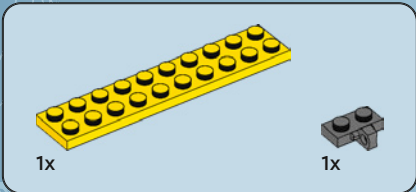
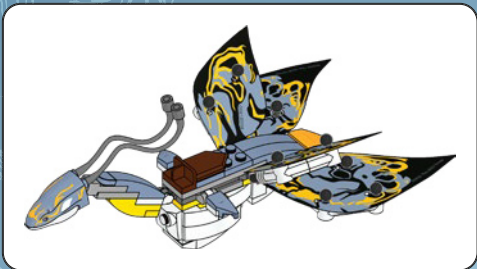

1

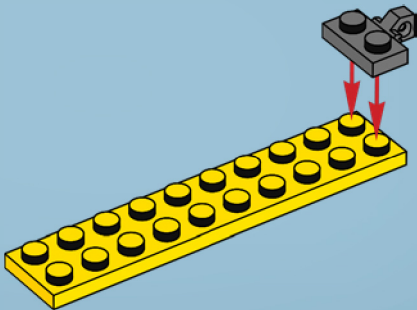

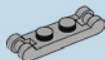

1x

2

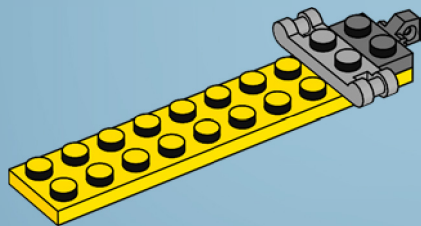

2x

3

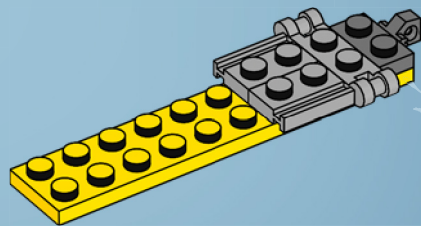



2x

4

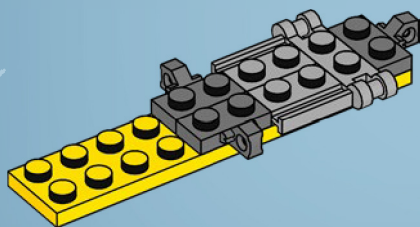

1x

5

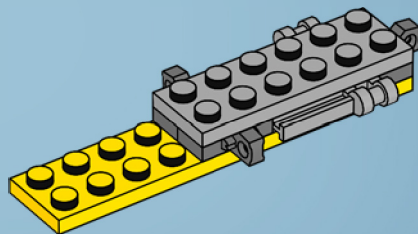



2x



1x

6

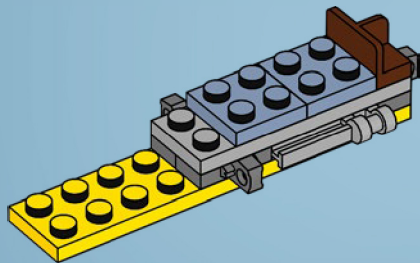

1x

7

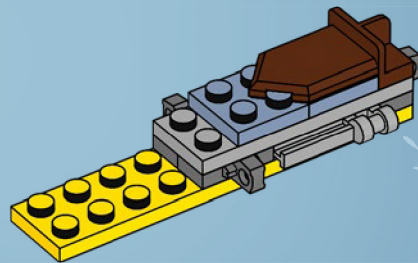



1x

8

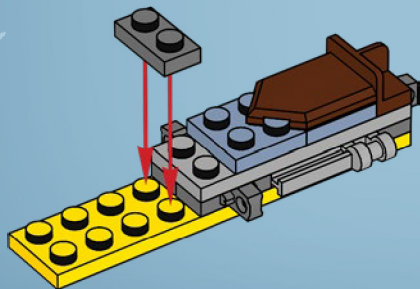

1x



2x

9

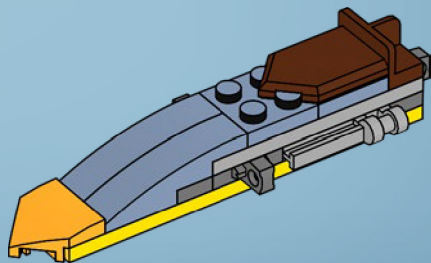

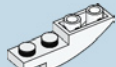

1x



1x

10

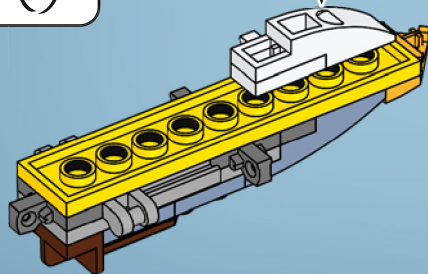
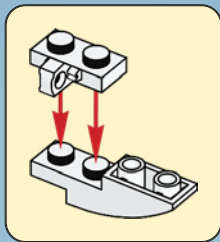

1x



1x

11

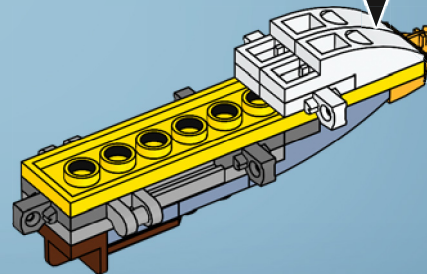
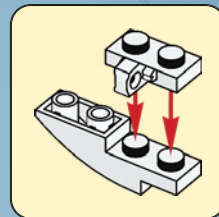



1x

12

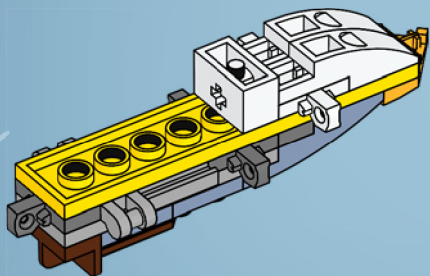

1x

13

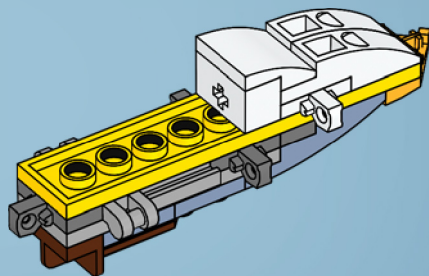



1x

14

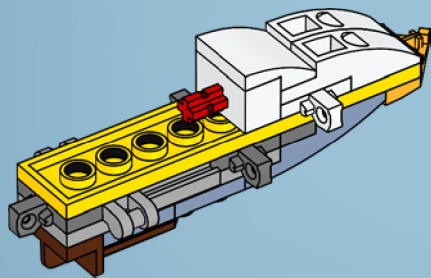

1x

15

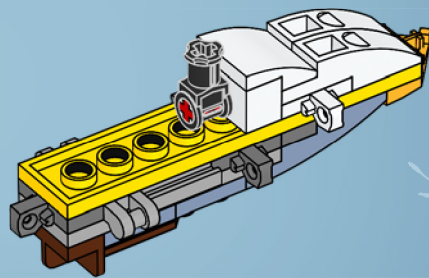



2x

16

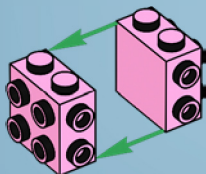

1x

17

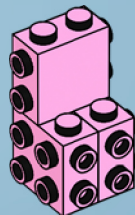



1x

18

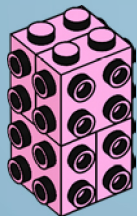

1x

19





1x



1x



1x

20

1

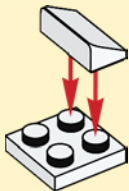

2

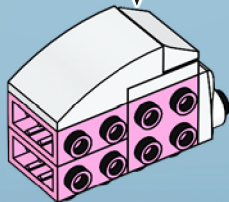
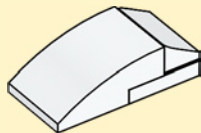

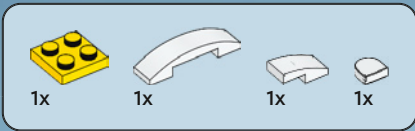

21

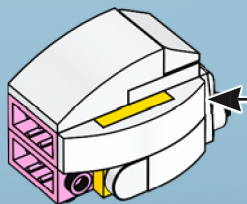
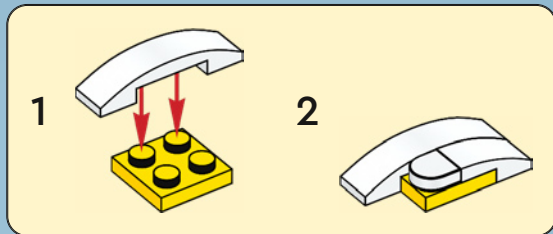



1x

22

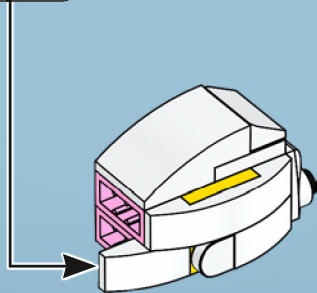

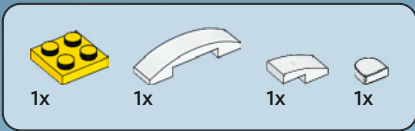

23

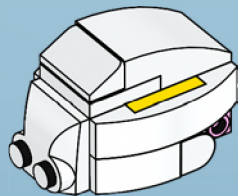
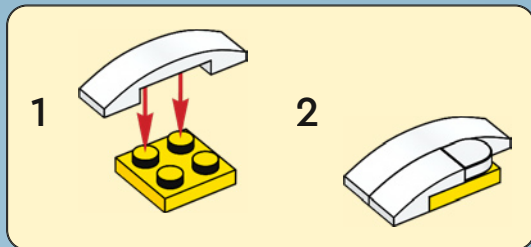



1x

24

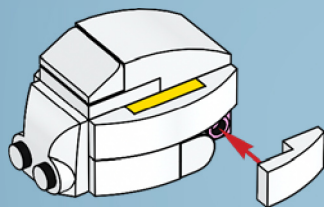

25

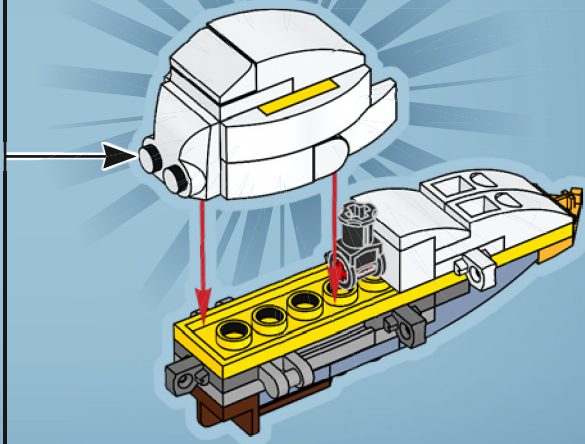



1x



1x



2x

26

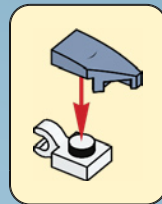
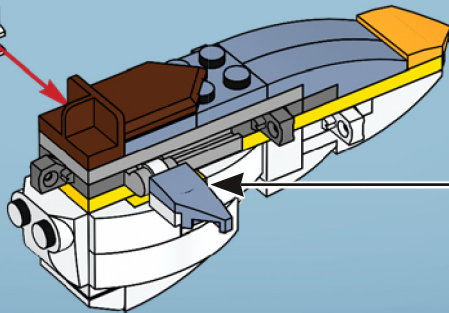
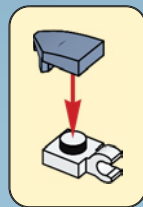



2x



2x



2x



4x



2x



4x



2x

27

1

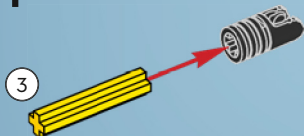

2

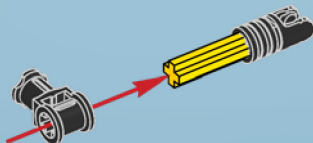

3



3

1:1

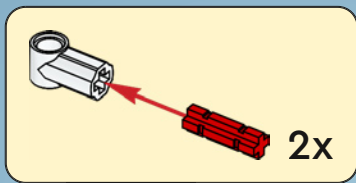

4

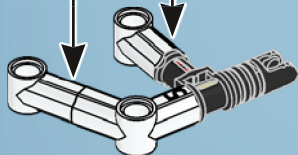

2x

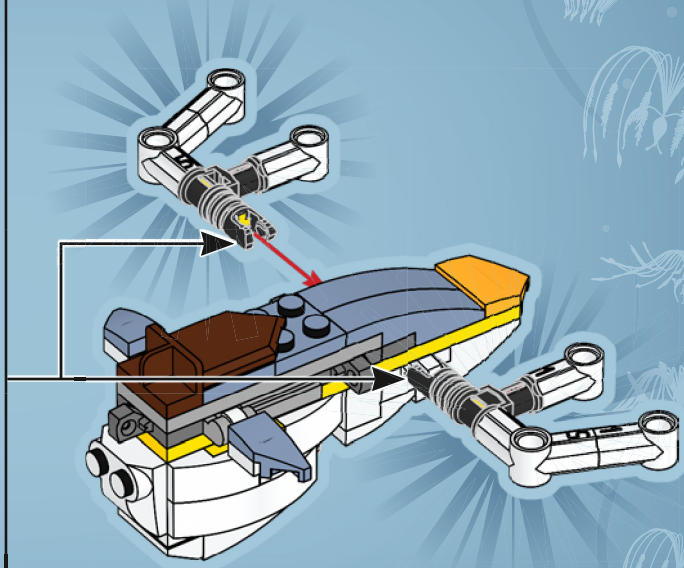



6x

28

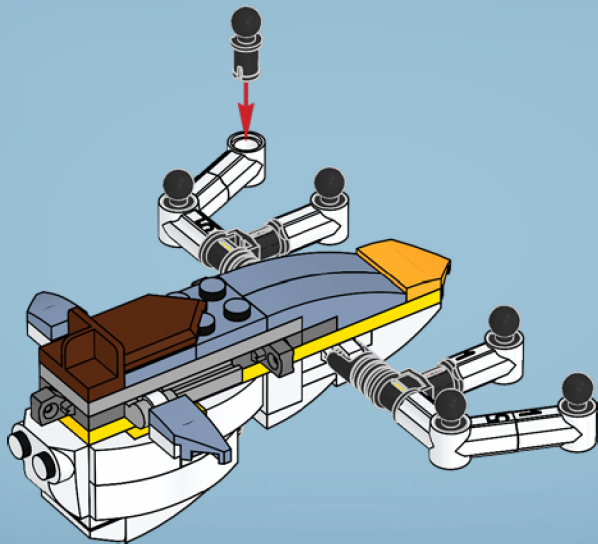

29

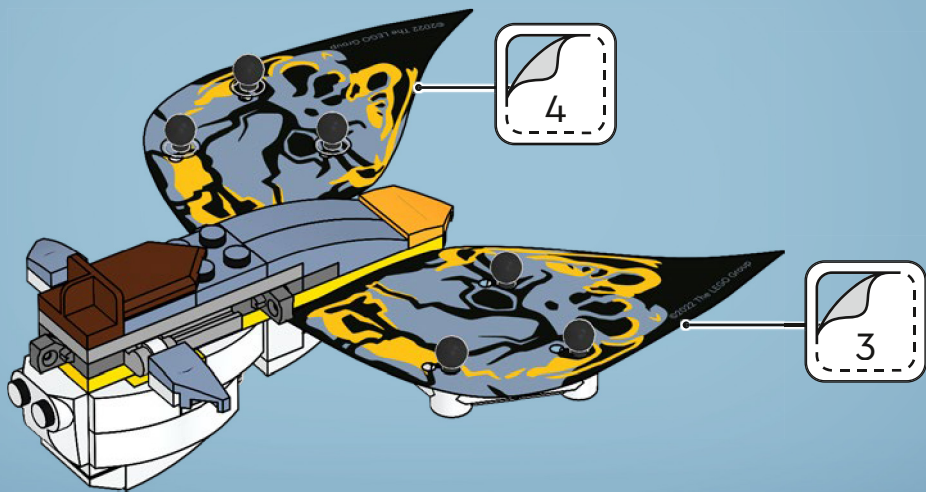
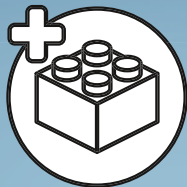

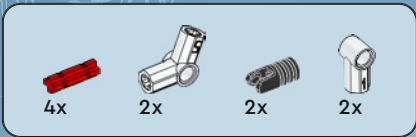

30

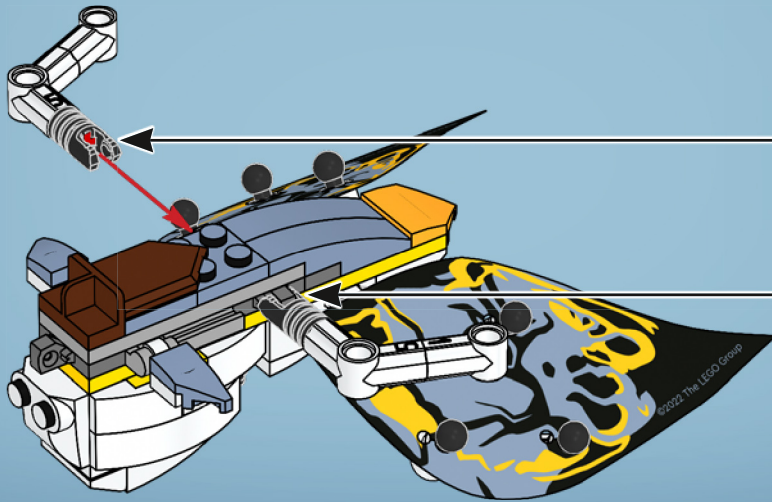
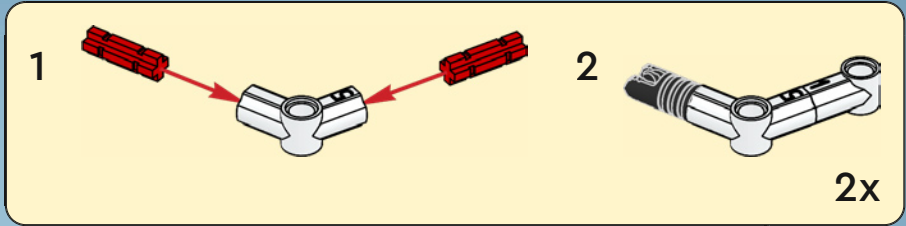



4x

31

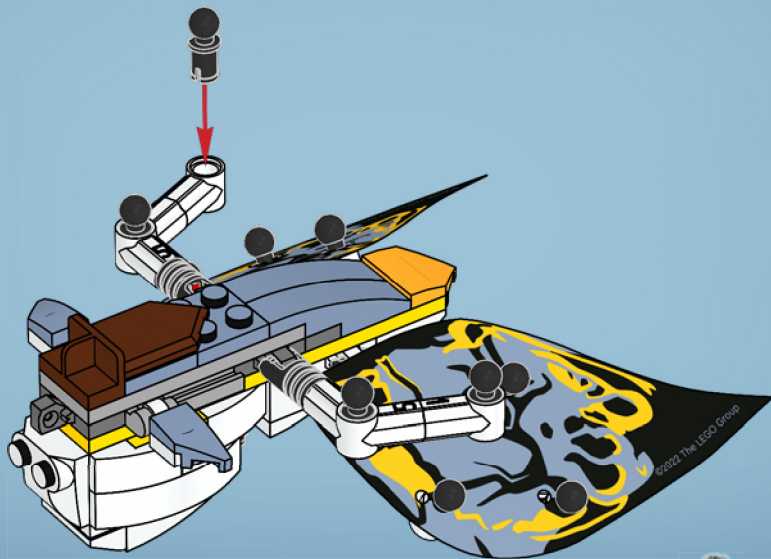

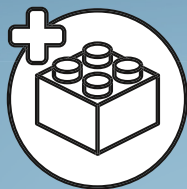

32

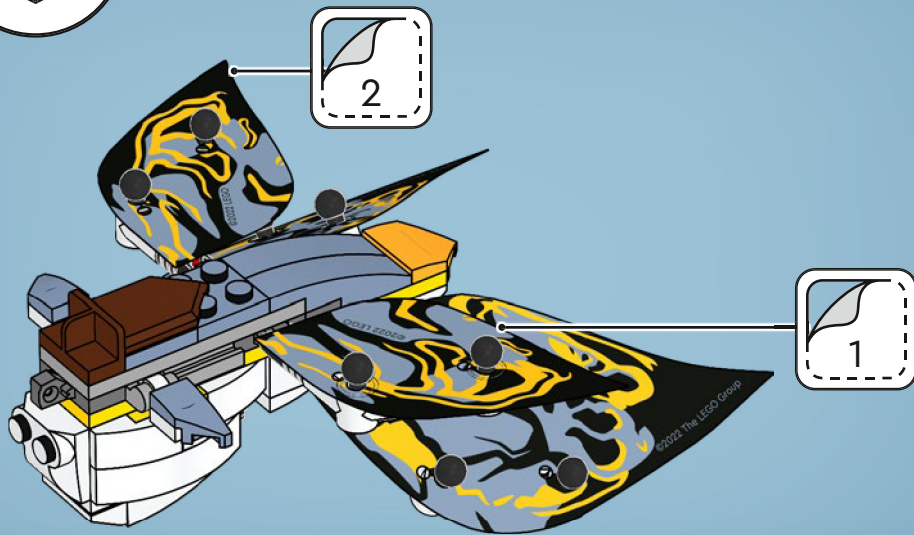

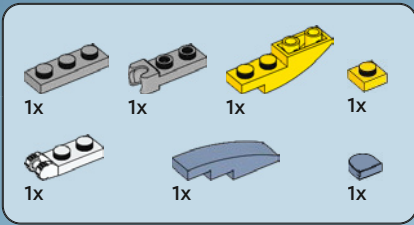

33

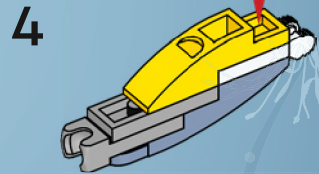
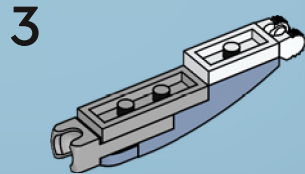
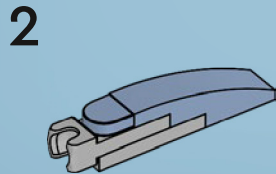
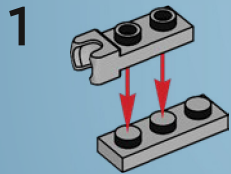

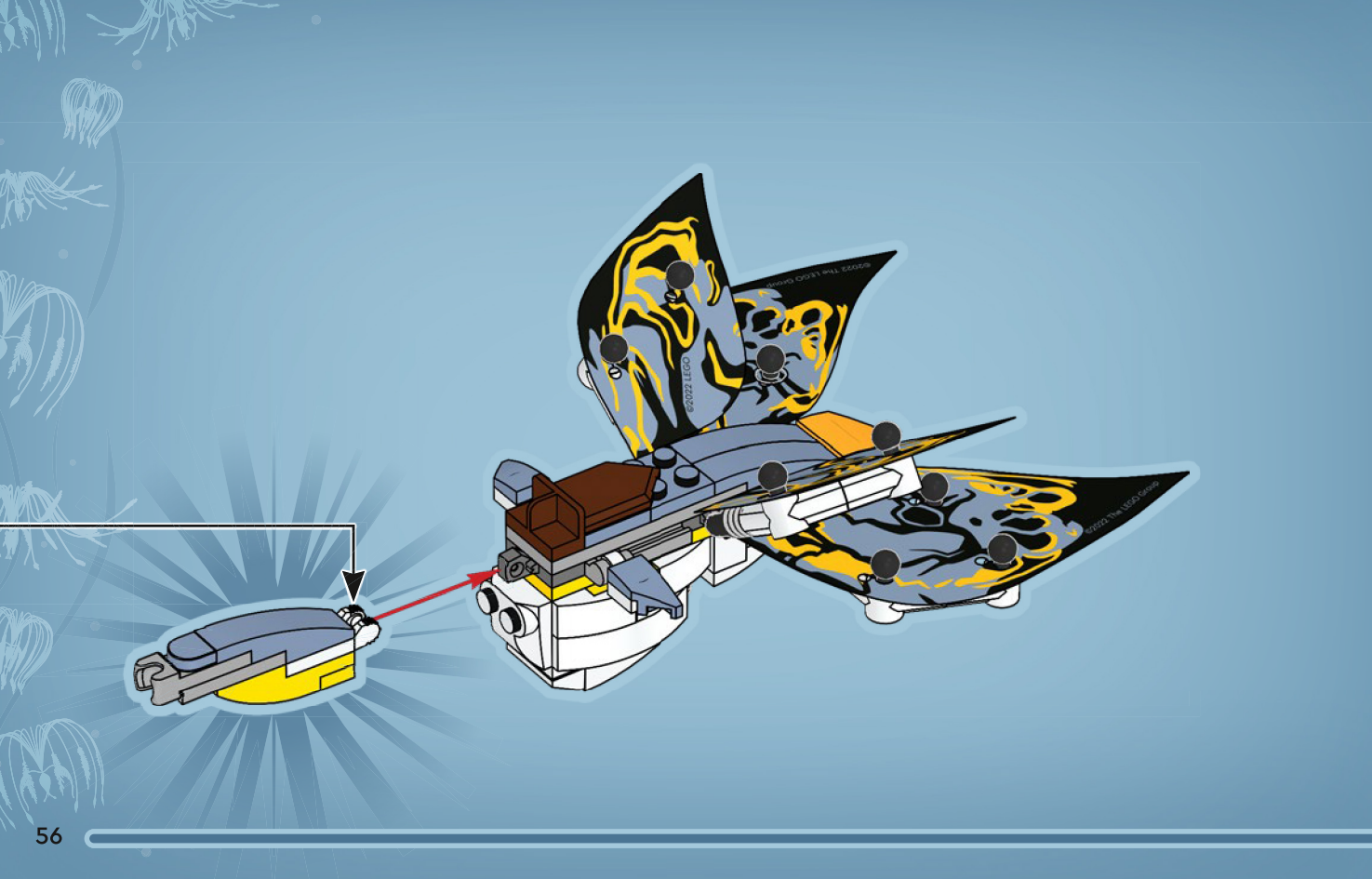

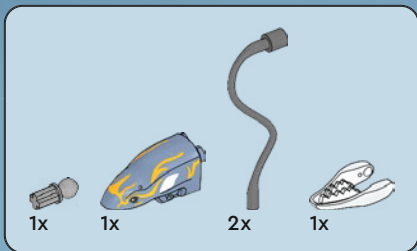

34

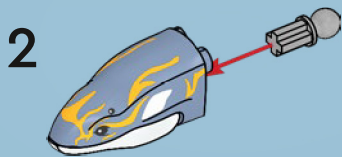
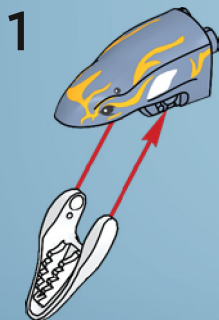

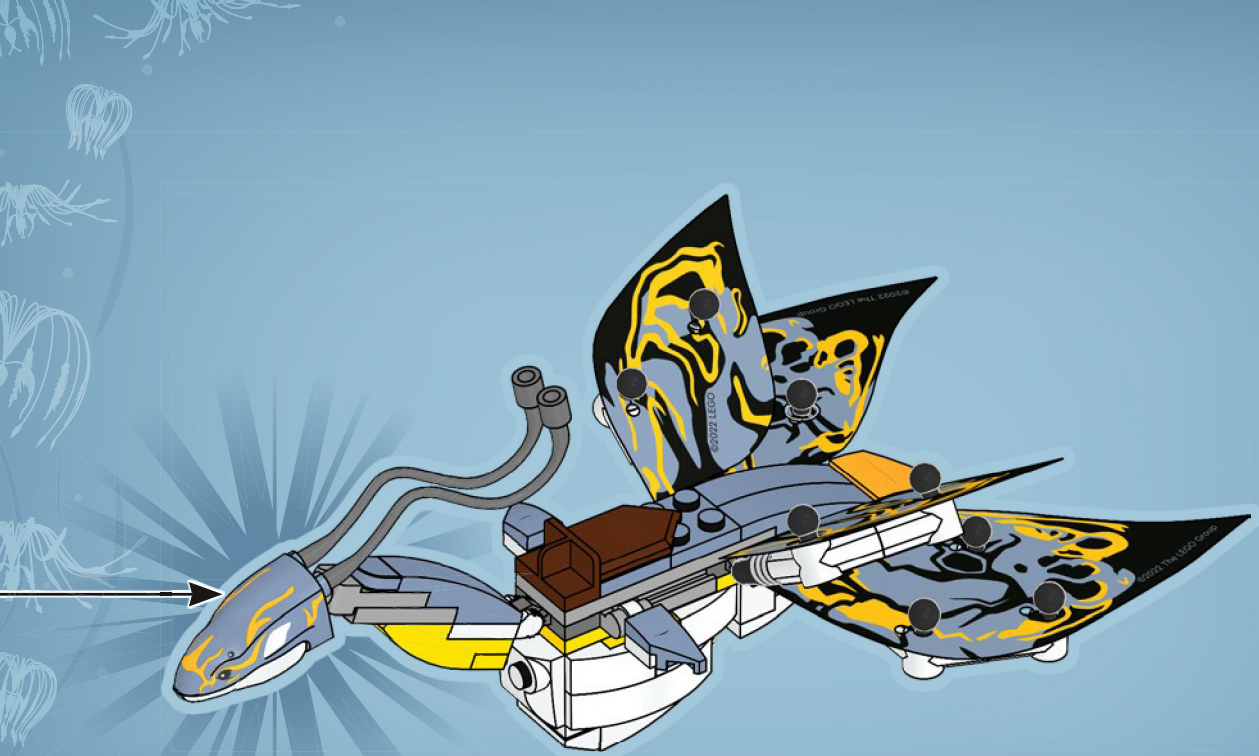



LEGO

AVATAR



75571



75572



75573



75574



75575



75576



75577



75578



75579





2x
6250591



2x
6338913



6x
6332573



2x
6347293



1x
4547489



1x
6178921



2x
6266253



4x
6034044



4x
6271349



1x
6210385



1x
302201



1x
4494474



1x
6267044



1x
6429607



1x
6132212



2x
6034675



2x
6023806



10x
6344752



1x
6388512



4x
6271535



3x
6331716



1x
6412296



1x
6261386

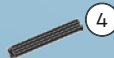

1x
370526



3x
6096682



1x
6339302



1x
6285587



2x
6429708



6x
6274740



1x
6421764



1x
6385602



1x
6430040



8x
6278172



1x
6262134



1x
6430055



1x
6429608



1x
6257109



1x
6257108



2x
6062089



1x
6421683



3x
6431757



1x
6421763



4x
6164071



2x
6127326



5x
4616581



1x
6249817



1x
4211375



2x
4211568



1x
6043639



1x
4211429



1x
6093058



1x
4211452

1x
6133860

1x
6245259

1x
6170468

2x
6425976

3x
6266248

1x
4211063

2x
6236949

1x
4211094

2x
4211103

1x
4227398

1x
6372122

2x
6100322

1x
6432085

1x
6421761

1x
6420861

1x
6430009

1x
6133832

2x
6291414

3x
6258990

3x
6058242

5x
6335182

3x
6097647

4x
6345505

3x
6329957

10x
4142865

1x
6223767

1x
6278447

1x
6030534

2x
6266974

1x
302424

2x
302224

2x
6130007

1x
6146298



1x
383224



1x
6427947



 [LEGO.com/service](https://www.LEGO.com/service)

YOU COULD **WIN**



Scan this QR code or go to **LEGO.COM/PRODUCTFEEDBACK** and give us your short feedback about this LEGO® set for a chance to win a cool LEGO prize.

Terms and Conditions apply*



DE: Du könntest GEWINNEN. Es gelten die Teilnahmebedingungen* **FR: Tu pourrais GAGNER.** Des conditions s'appliquent* **IT: Potresti VINCERE tu.** Termini e condizioni sono applicabili* **ES: Puedes GANAR.** Aplican términos y condiciones* **PT: Poderá GANHAR.** Aplicam-se termos e condições* **JA: プレゼント付き! 利用規約が適用されます*** **ZH: 轻松获奖. 条款和条件适用*** **KO: 상품의 주인이 되어보세요. 소정의 약관이 적용됩니다*** **RU: Вы можете ВЫИГРАТЬ.** Действуют положения и условия* **PL: Szansa na WYGRANĄ.** Obowiązują warunki korzystania* **CS: Máte šanci VYHRÁT.** Platí všeobecné smluvní podmínky* **SK: Máte šancu VYHRAŤ.** Platia všeobecné zmluvné podmienky* **HU: TE IS NYERHETSZ.** Felhasználási feltételek érvényesek* **RO: Ai putea CÂȘTIGA.** Se aplică termenii și condițiile* **BG: Можете да СПЕЧЕЛИТЕ.** Има определени правила и условия* **LV: Tu vari LAIMĒT.** Ir spēkā noteikumi un nosacījumi.* **ET: Sul on võimalus VÕITA.** Kehtivad tingimused* **LT: Jūs galite LAIMĖTI.** Taikomos sąlygos*

*[LEGO.com/productfeedback/terms](https://www.lego.com/productfeedback/terms)

LEGO and the LEGO logo are trademarks of the LEGO Group. ©2023 The LEGO Group.

TM & © 20th Century Studios

6491756