



NINJAGO

71782





 **FR**
DONNEZ
OU
RECYCLEZ

 OU  OU 

ASSOCIATION MAGASIN DÉCHÈTERIE

Adresses sur quefairedemesdechets.fr



LEGO.com/sustainable-packaging

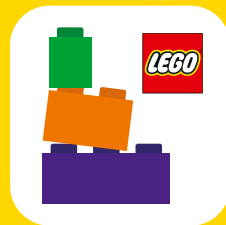

BUILDER



Apple and the Apple logo are trademarks of Apple Inc., registered in the U.S. and other countries and regions. App Store is a service mark of Apple Inc. Google Play and the Google Play logo are trademarks of Google LLC. Tencent and the Tencent logo are trademarks of Tencent Inc.

[LEGO.com/devicecheck](https://www.lego.com/devicecheck)

EN Ask parents' permission before going online | **DE** Eltern um Erlaubnis bitten, bevor du online gehst | **FR** Demande l'autorisation d'un parent avant d'aller en ligne | **IT** Chiedi il permesso ai tuoi genitori prima di andare online | **ES** Pídeles permiso a tus papás antes de conectarte a Internet | **PT** Pede autorização aos pais antes de acederes online | **JA** オンラインになる前に ほか者の方のきよかをもらおう | **ZH** 上网前应先征得父母的同意 | **KO** 온라인 접속 전에 보호자 동의가 필요합니다 | **RU** Спроси разрешения у родителей, прежде чем заходить в интернет | **PL** Poproś rodziców o zgodę, zanim wejdziesz do Internetu | **CS** Než půjdeš na internet, požádej rodiče o svolení | **SK** Skôr než pôjdeš na internet, vypýtaj si povolenie od rodičov | **HU** Kérj szülői engedélyt, mielőtt online csatlakoznál! | **RO** Cere permisiunea părinților înainte de a te conecta online | **BG** Поискайте разрешение от родител, преди да влезете онлайн | **LV** Pirms došanās tiešsaistē palūdz atļauju vecākiem | **ET** Enne Interneti kasutamist küsi vanematelt luba | **LT** Prieš prisijungdami prie interneto, atsklauskite tėvų

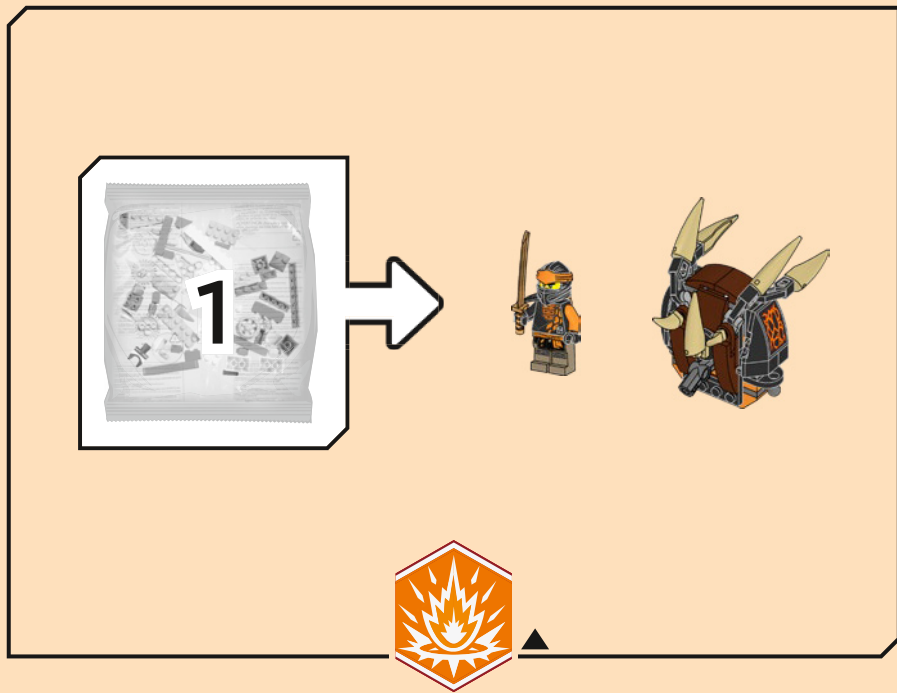

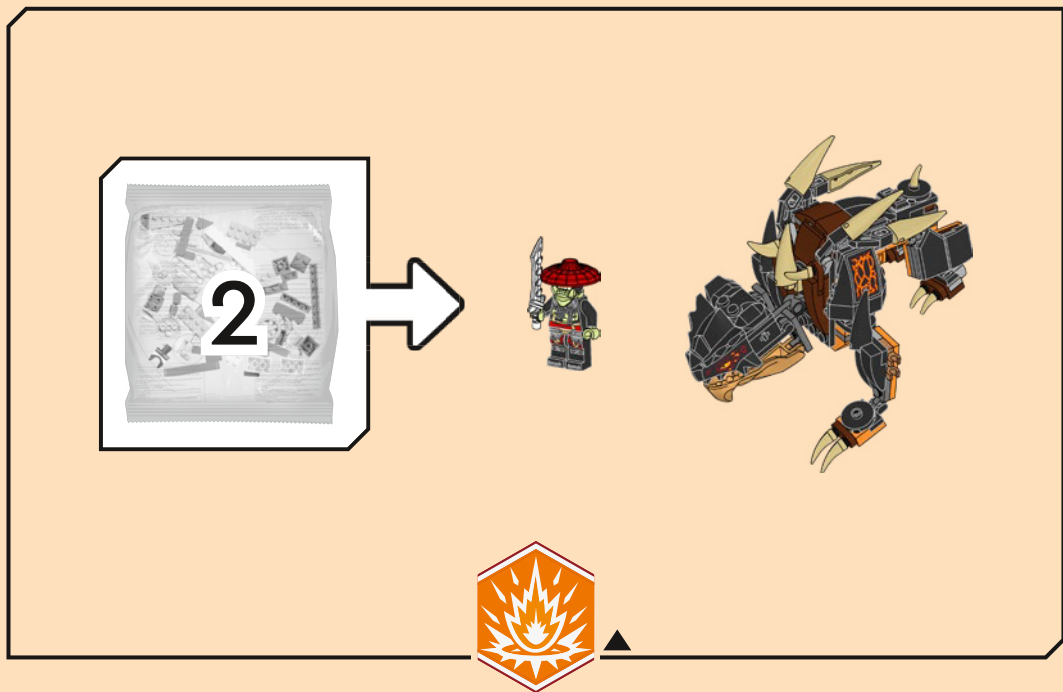

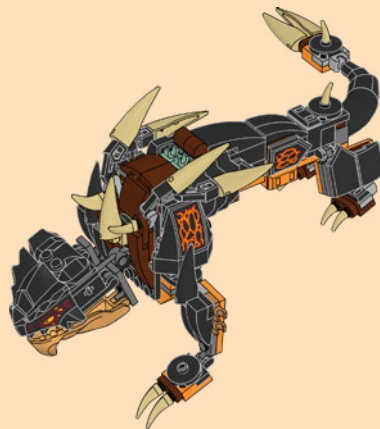
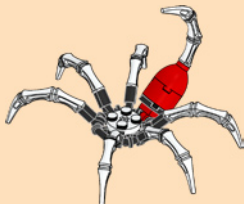
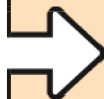

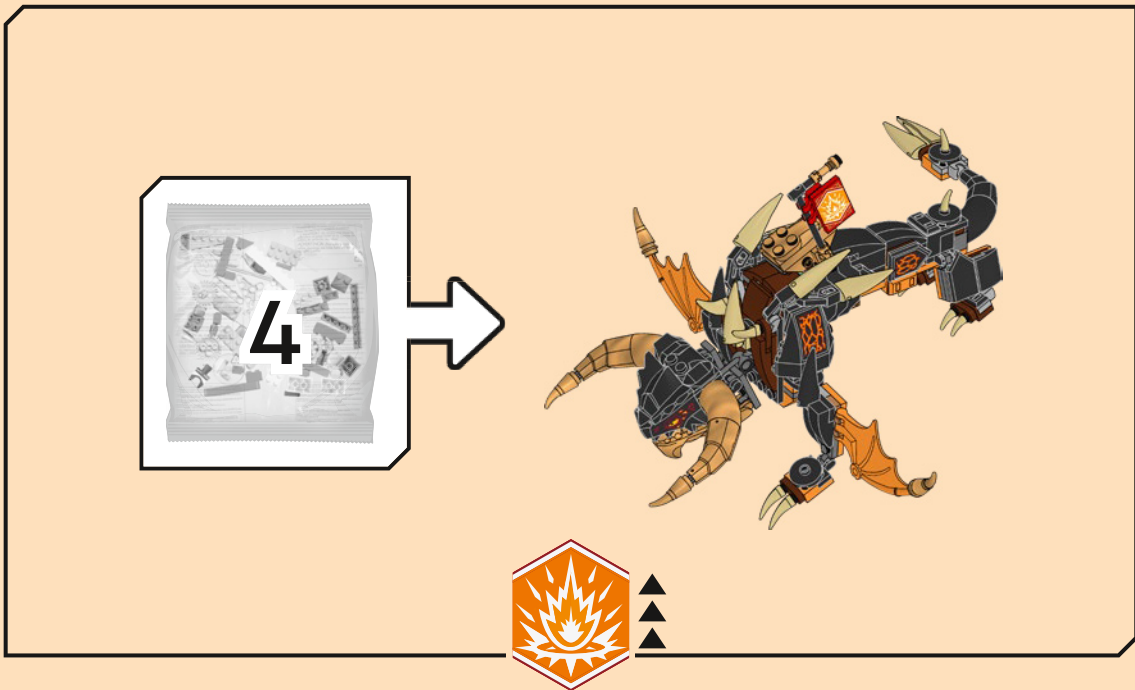

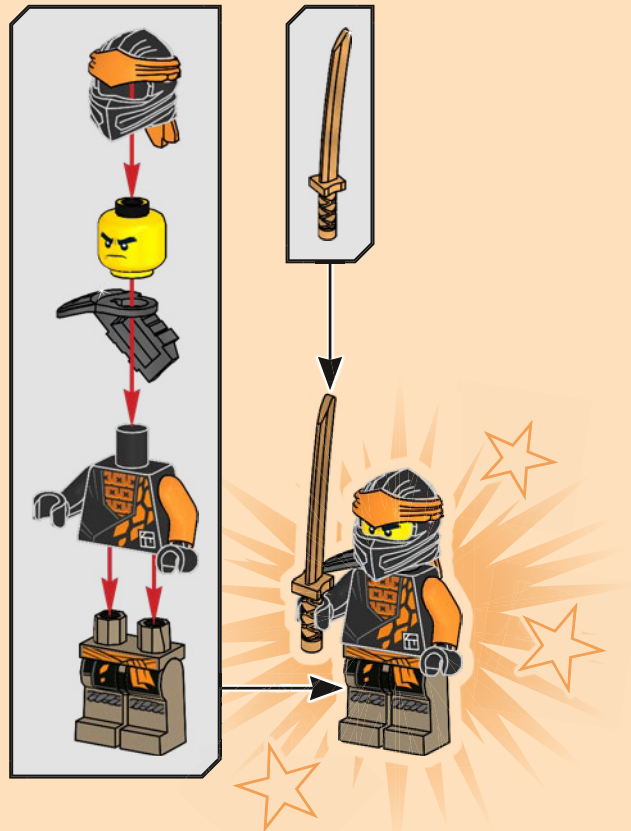





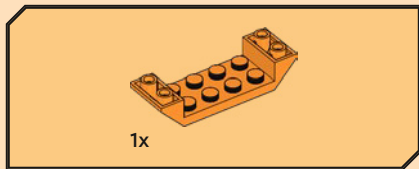

1

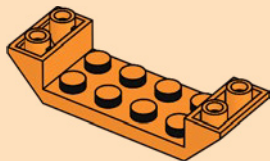

2

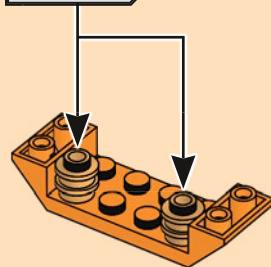
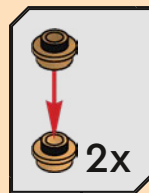

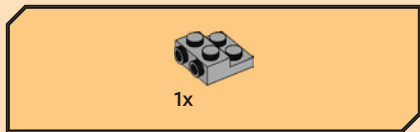

3

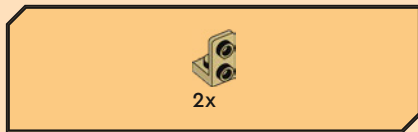
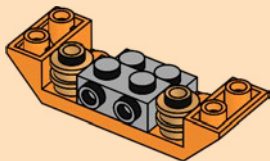

4

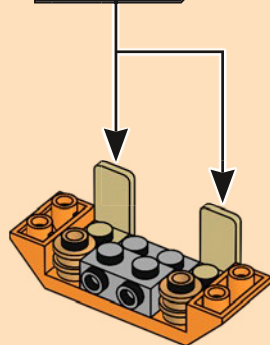

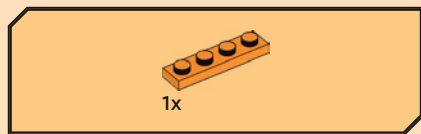

5

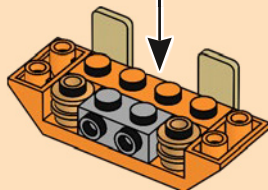
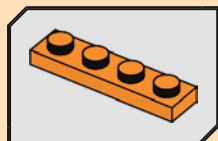

6

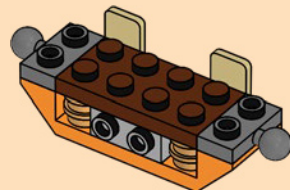

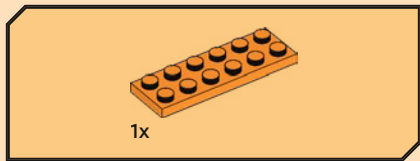

7

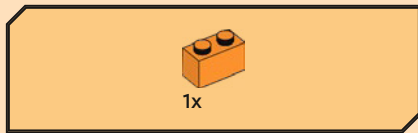
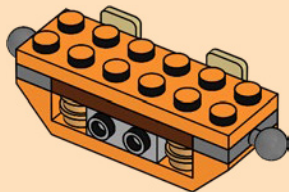

8

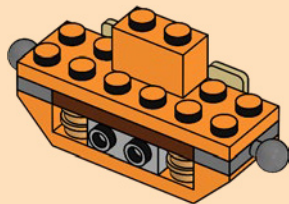

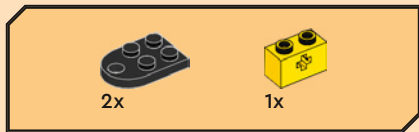

9

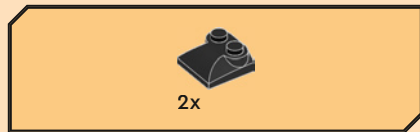
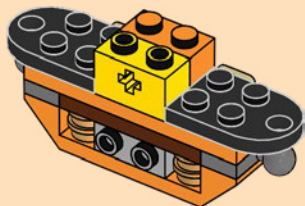

10

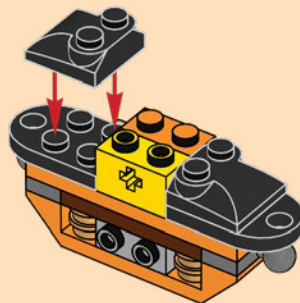

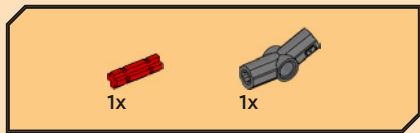

11

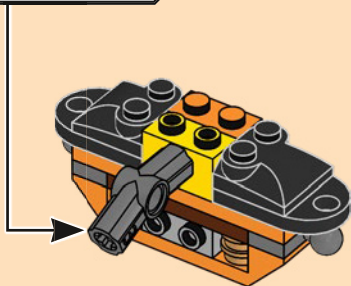
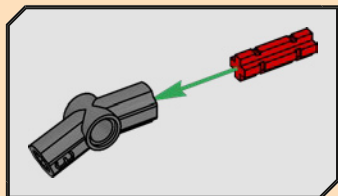

12

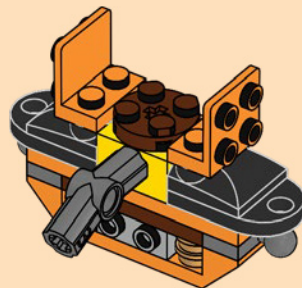



13

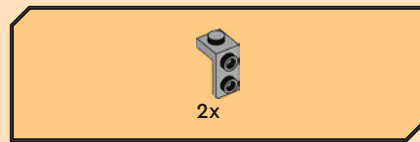
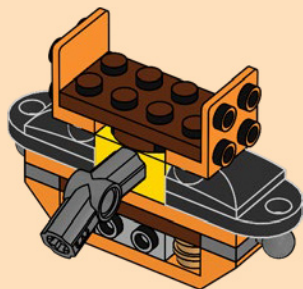

14

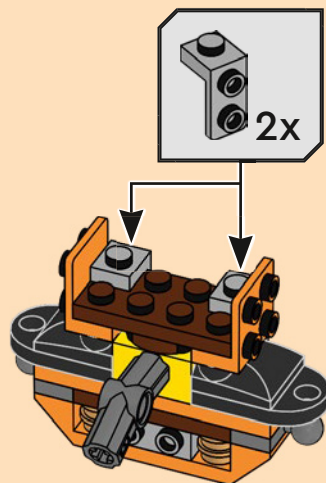

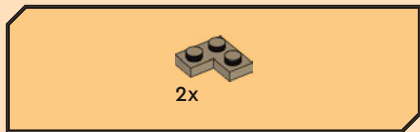

15

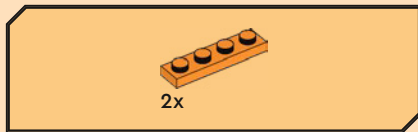
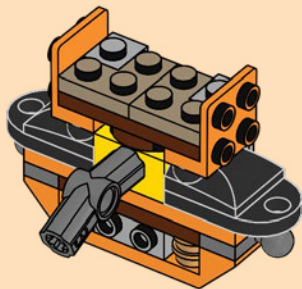

16

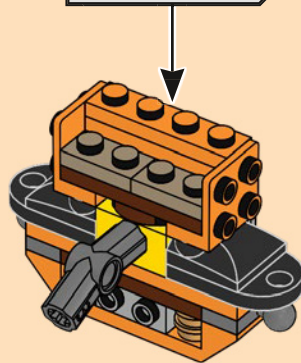
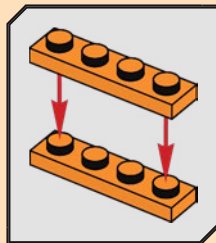

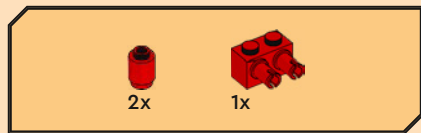

17

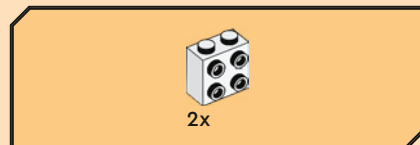
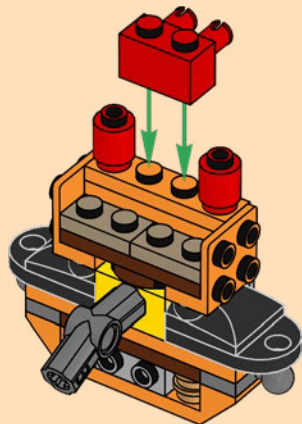

18



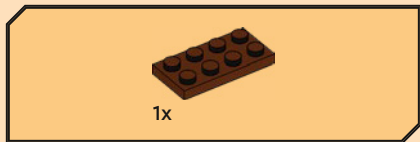

19

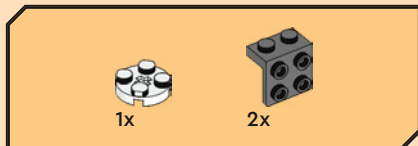

20

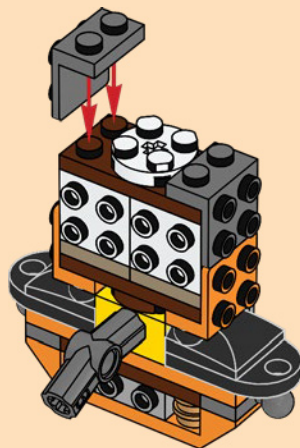



21

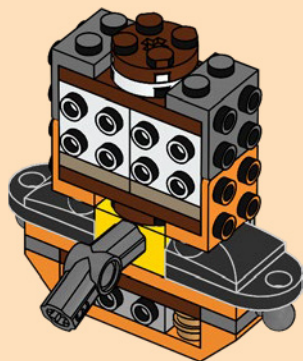

22

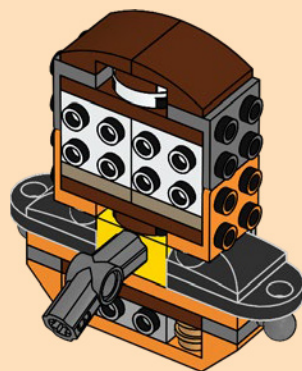

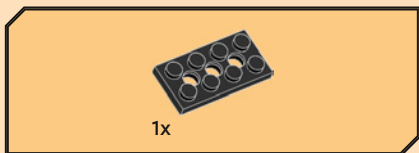

23



22

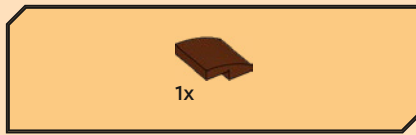

24

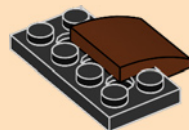



25

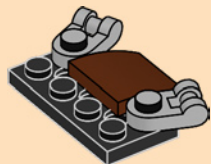

26



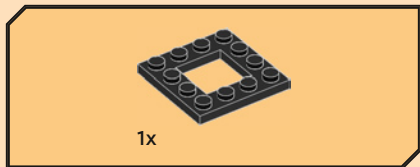

27

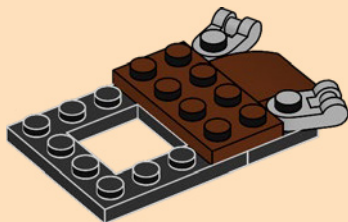

24

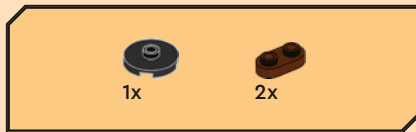

28

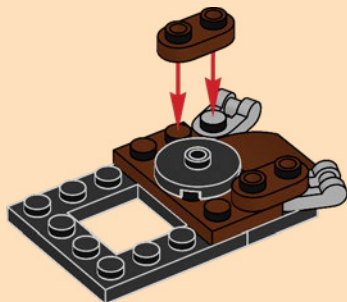



29

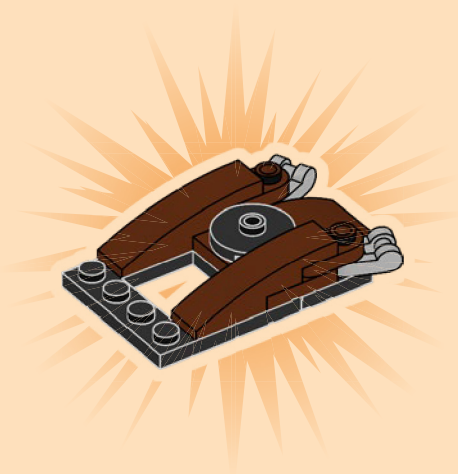

30

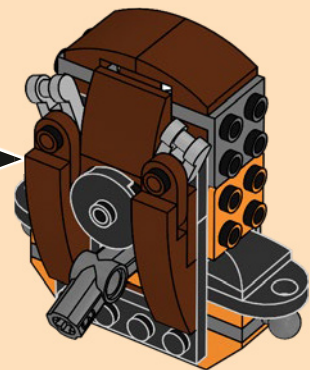

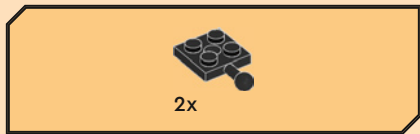

31

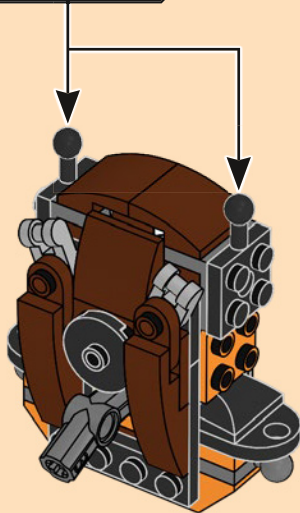



32

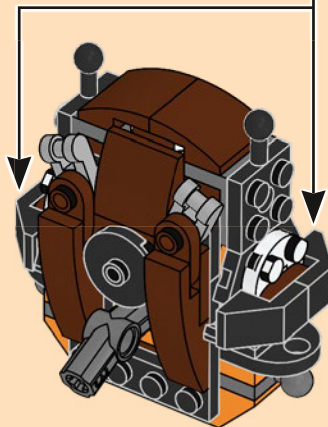
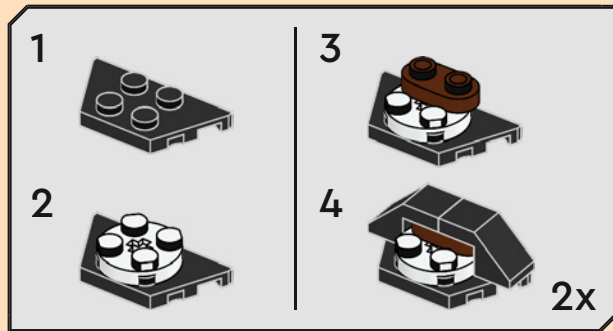



33

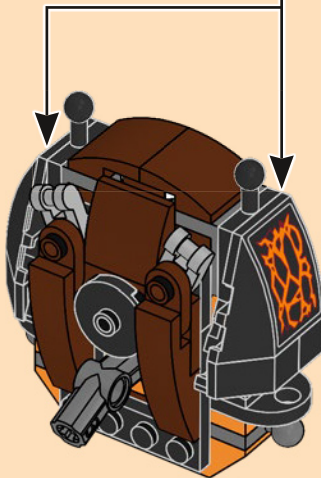
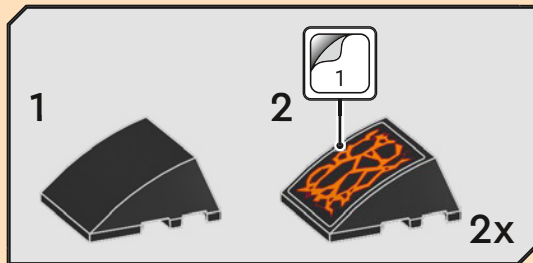

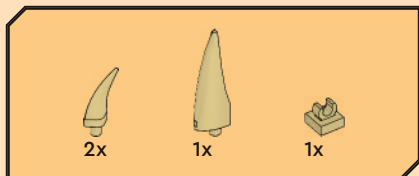

34

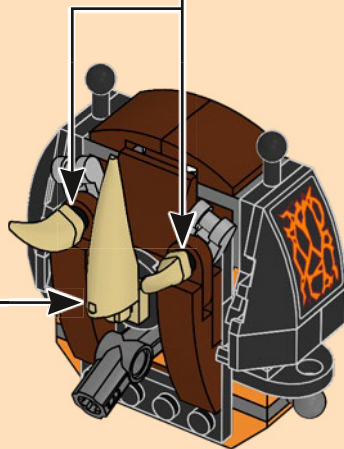
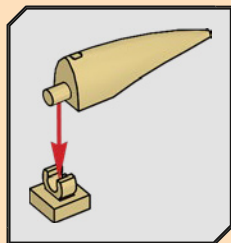



35

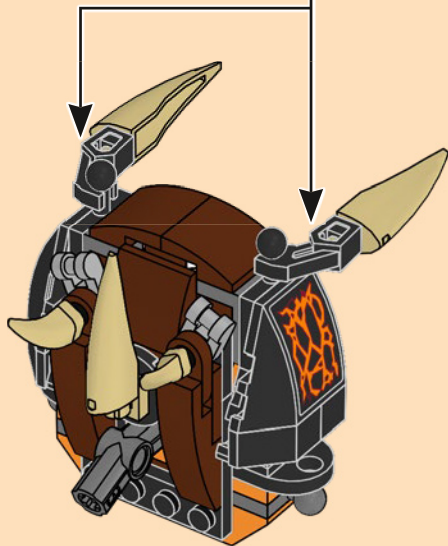
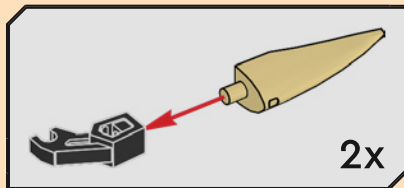



36

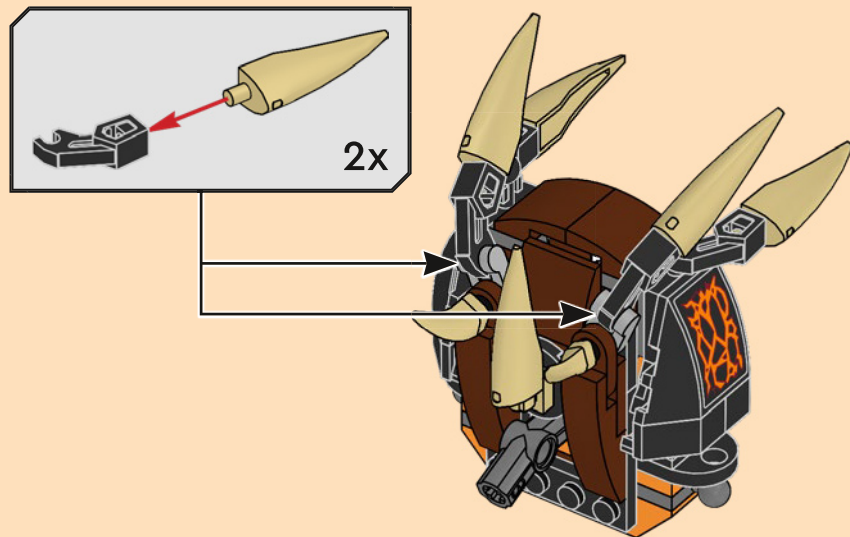



37

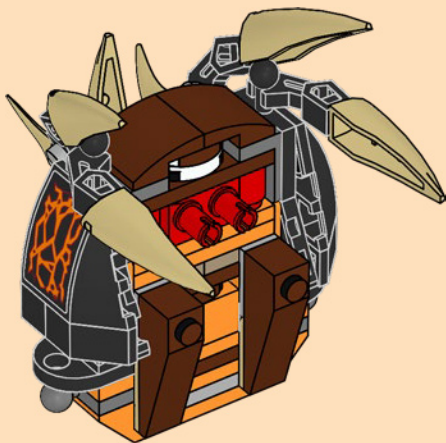
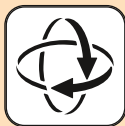

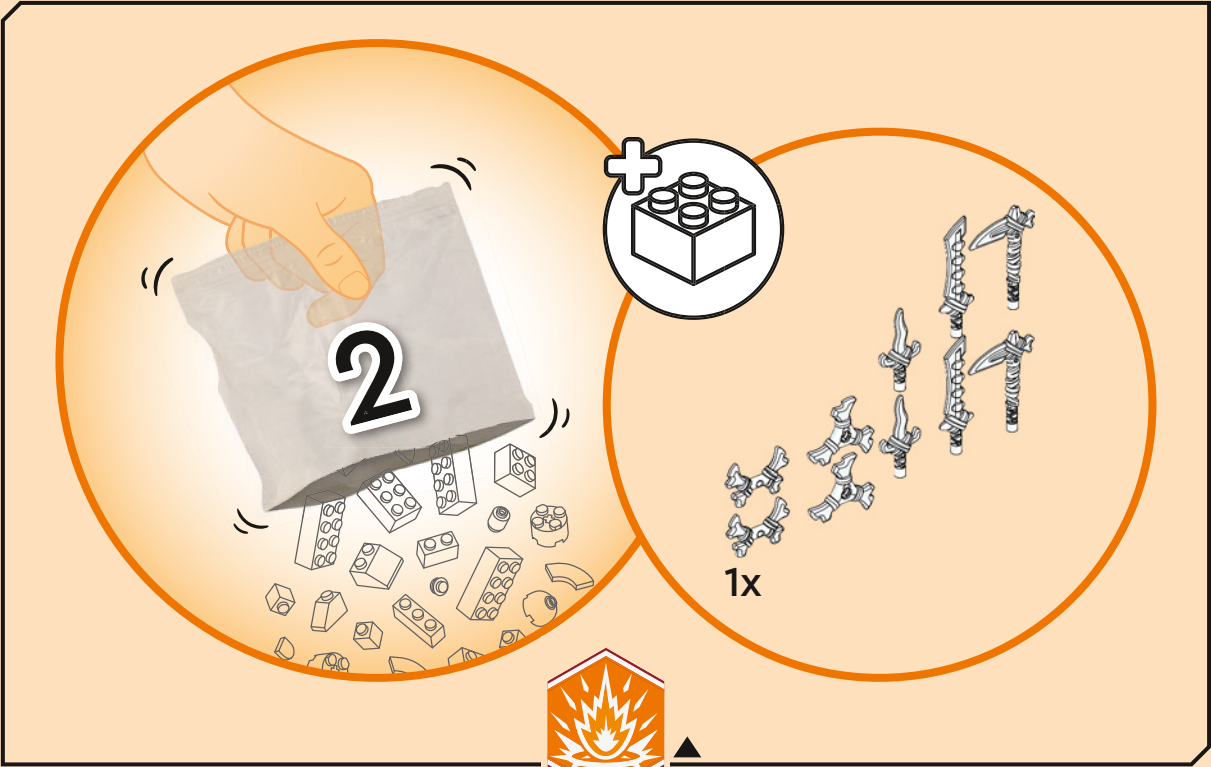

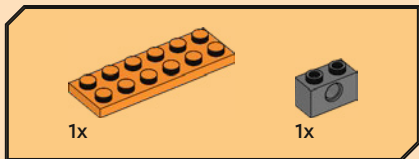

38

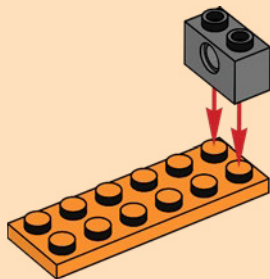



39

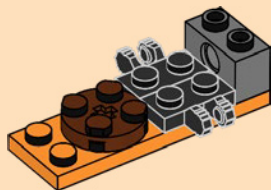

40

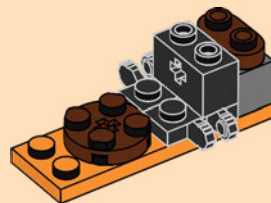

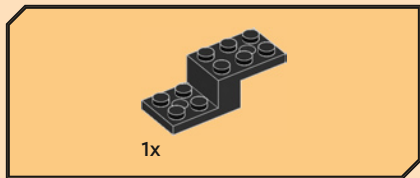

41

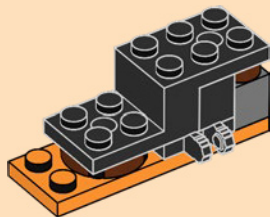



42

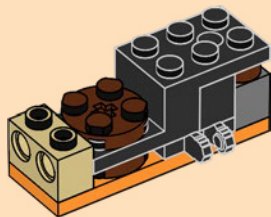

43

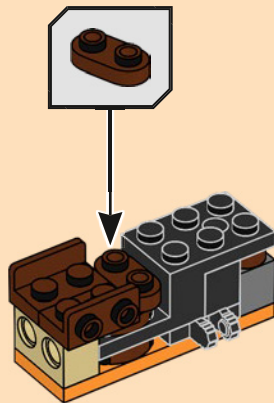



44

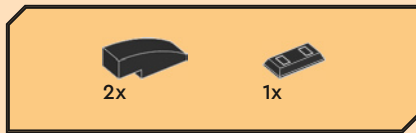
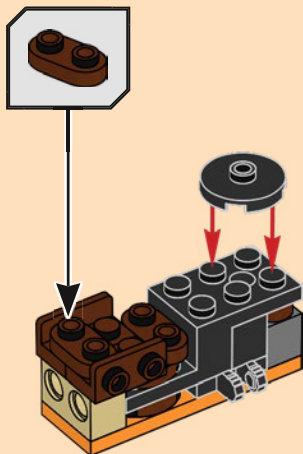

45

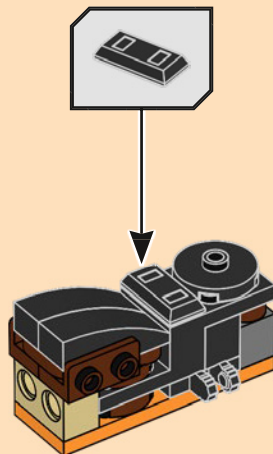



46

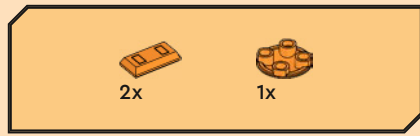
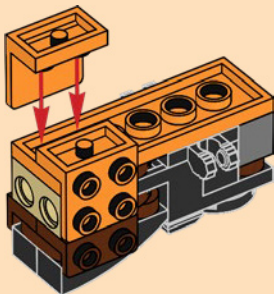

47

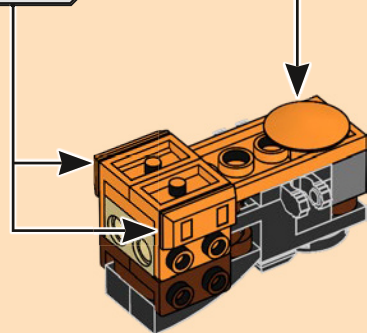



48

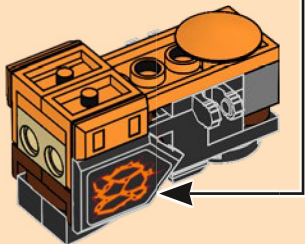
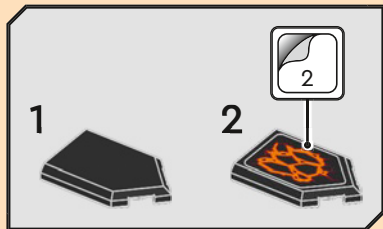

49

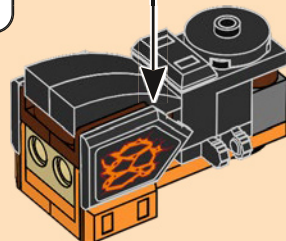

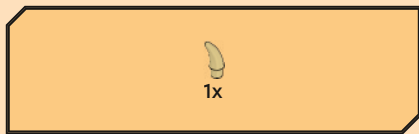

50



51

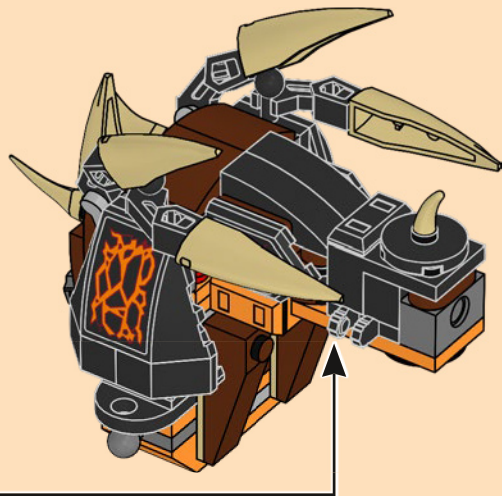

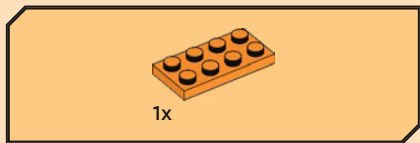

52

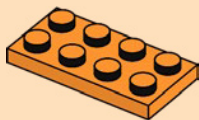

53

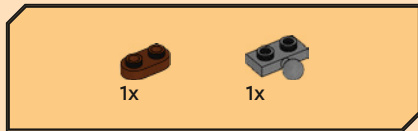
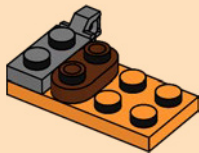

54

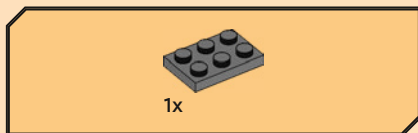
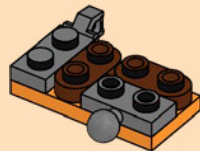

55

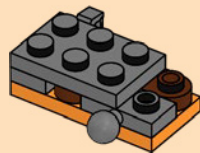

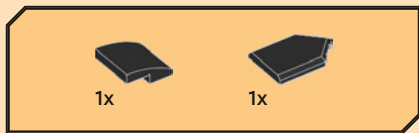

56

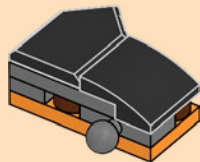

57

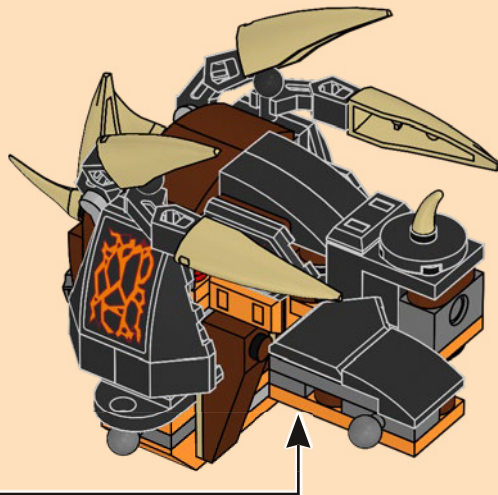

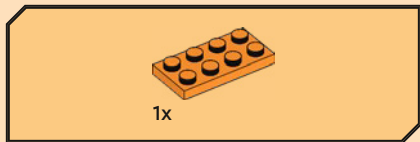

58

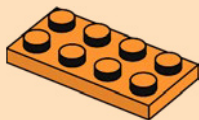

59

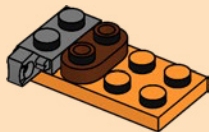

60

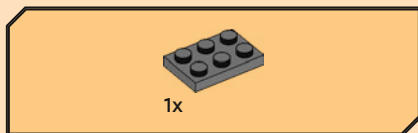
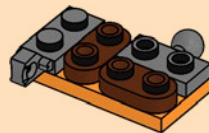

61

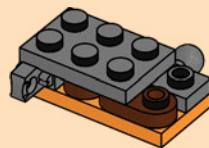

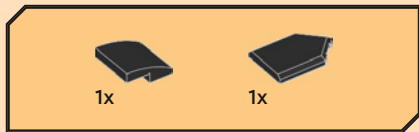

62

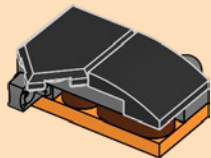

63

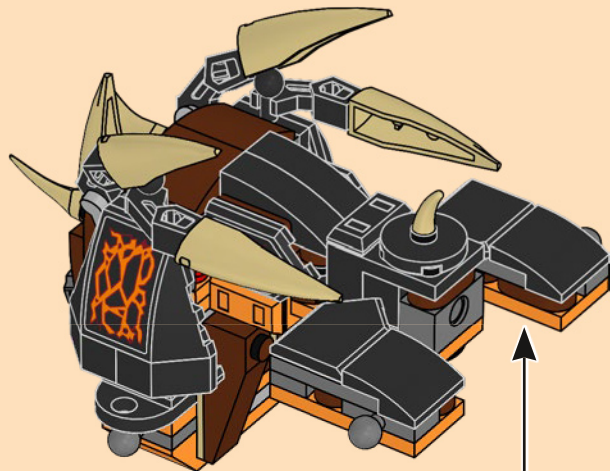



64

1

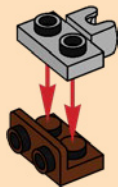

2



3

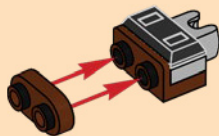

4

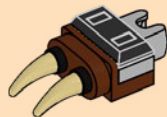

2x

65

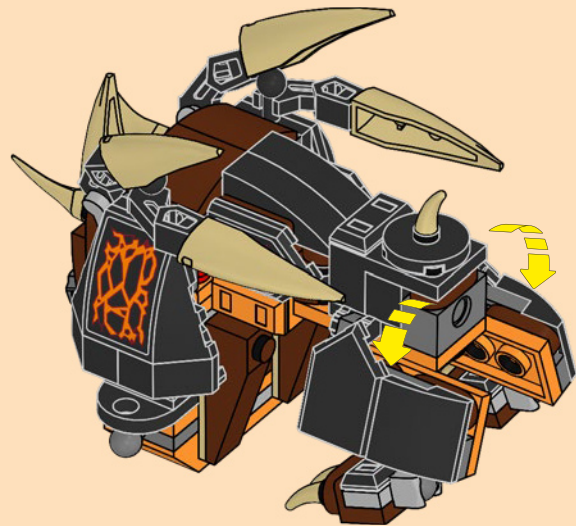
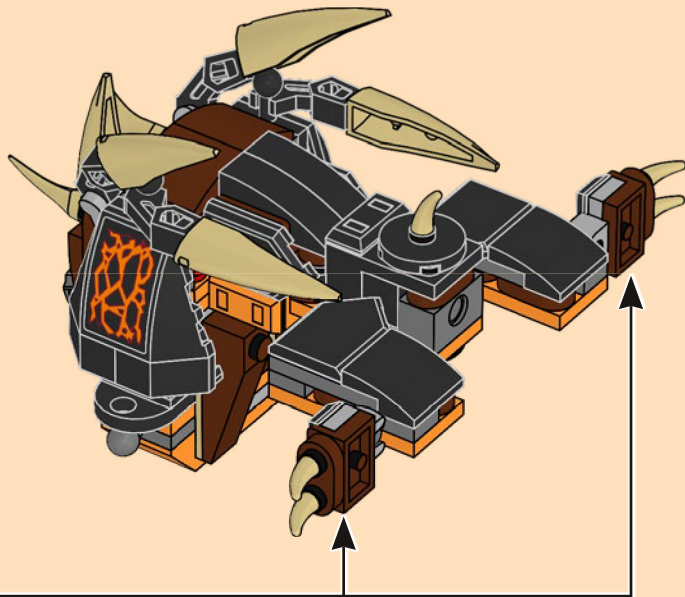

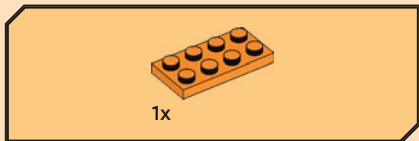

66

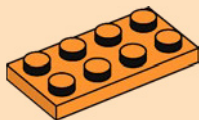

67

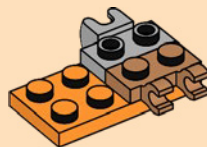

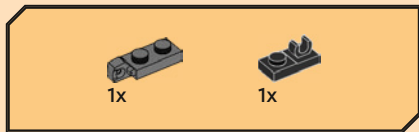

68

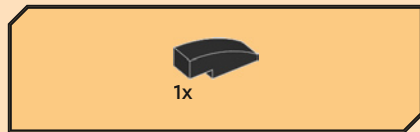
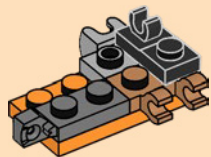

69

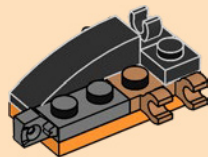

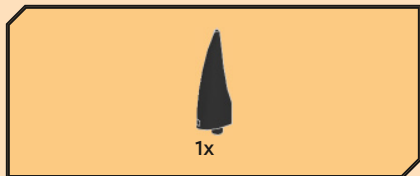

70

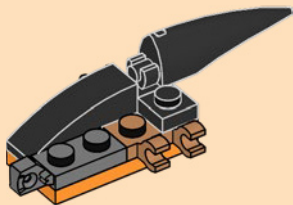

71

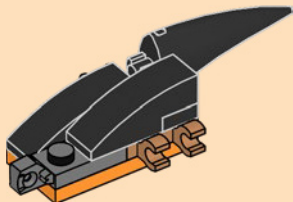

50

72

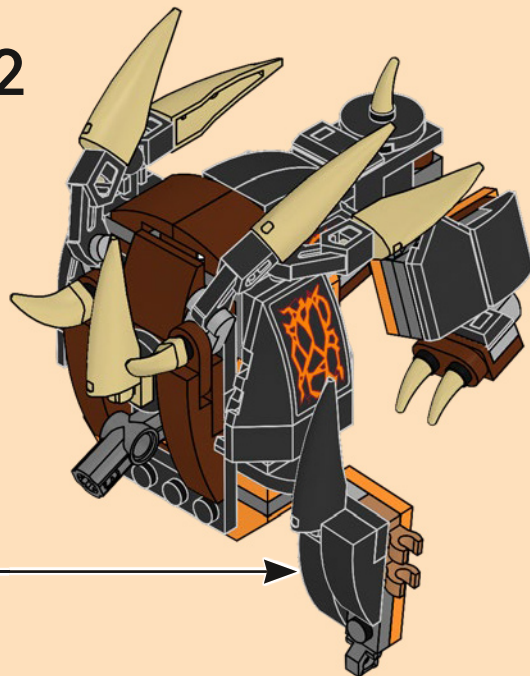

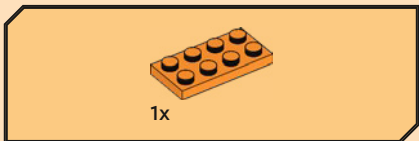

1x

73

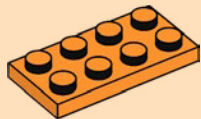

1x

1x

74

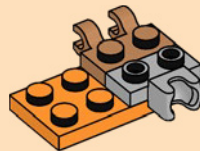



75

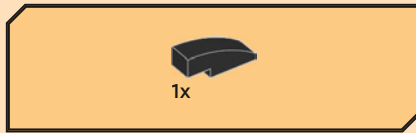
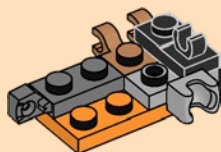

76

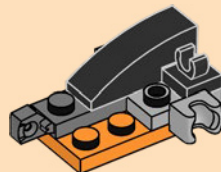

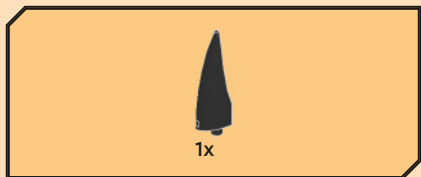

77

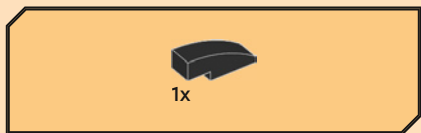
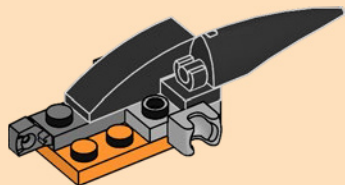

78

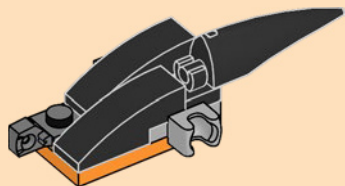

79

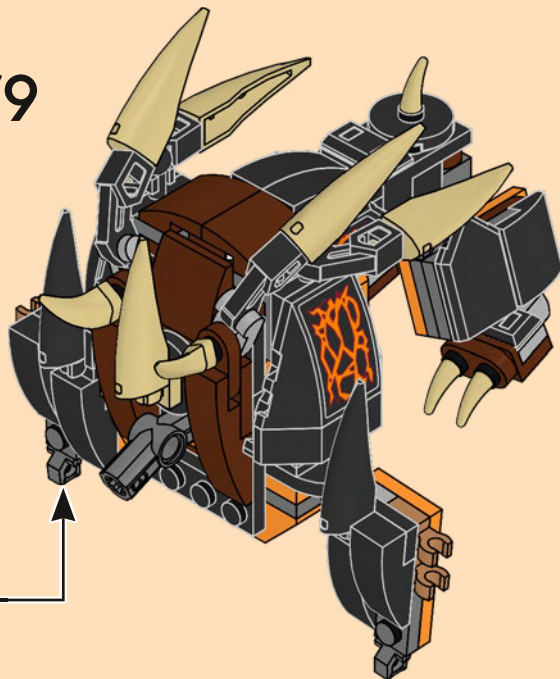



80

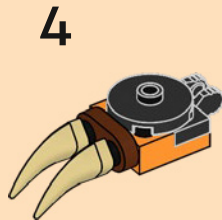
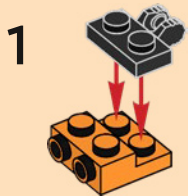

2x

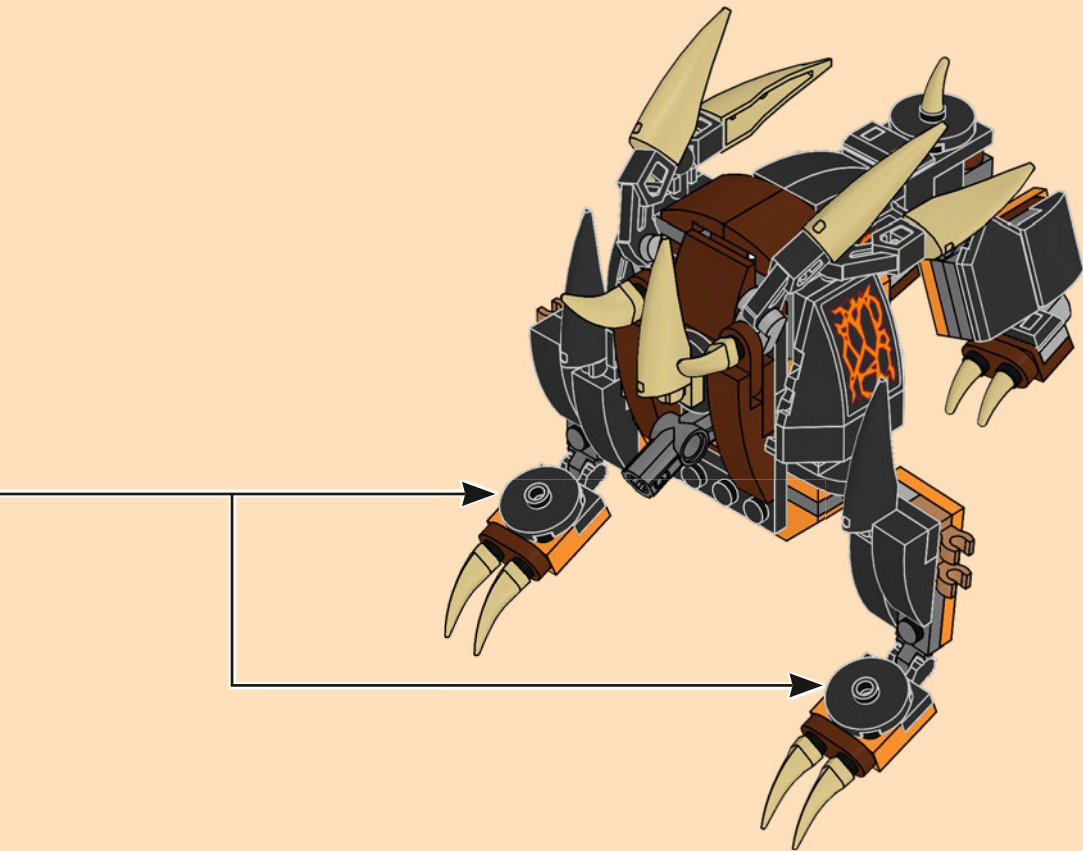



81

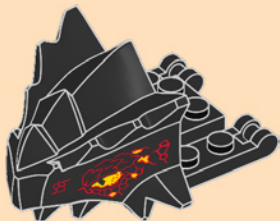

82





83

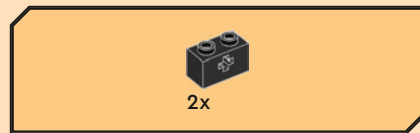

84





1x

85

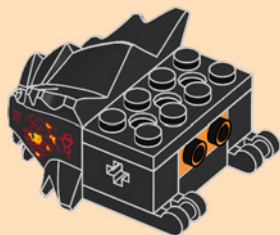

58



1x

86

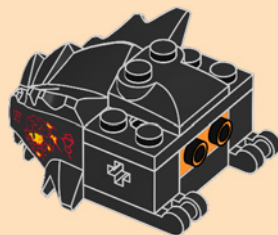



2x

87

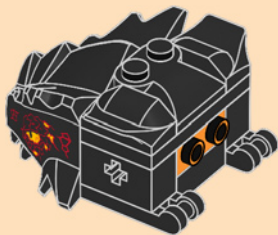

1x



1x

88

1



2

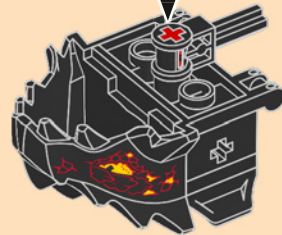



2x

89

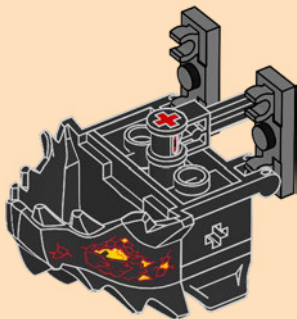

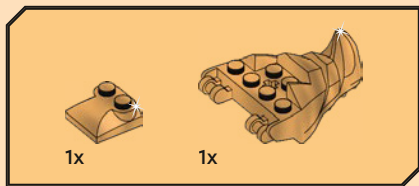

90

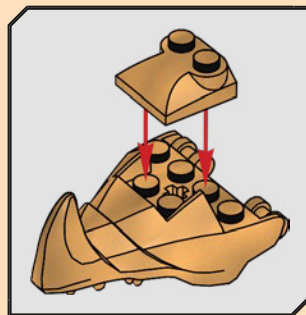

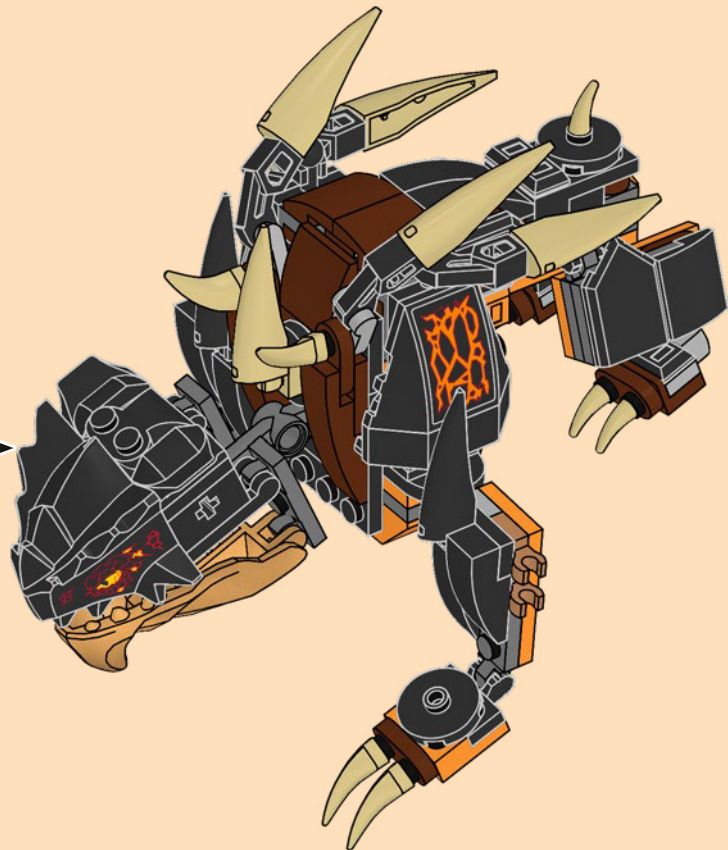



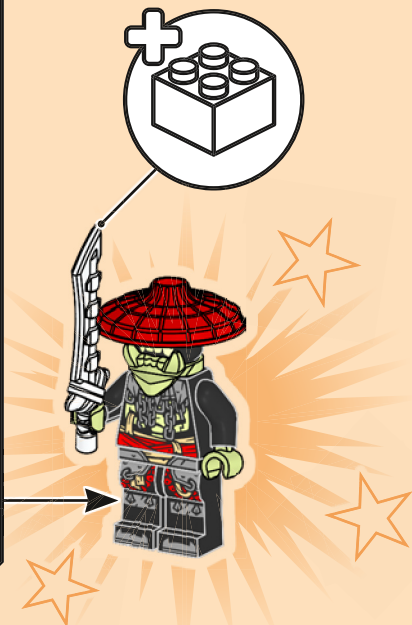
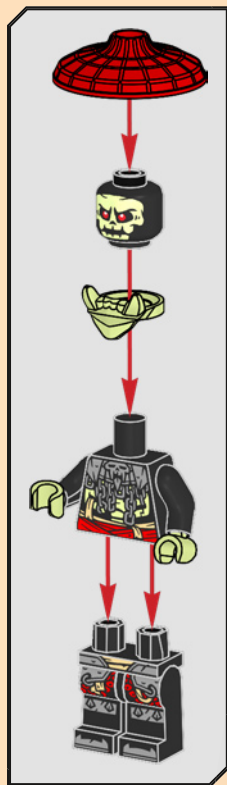





92

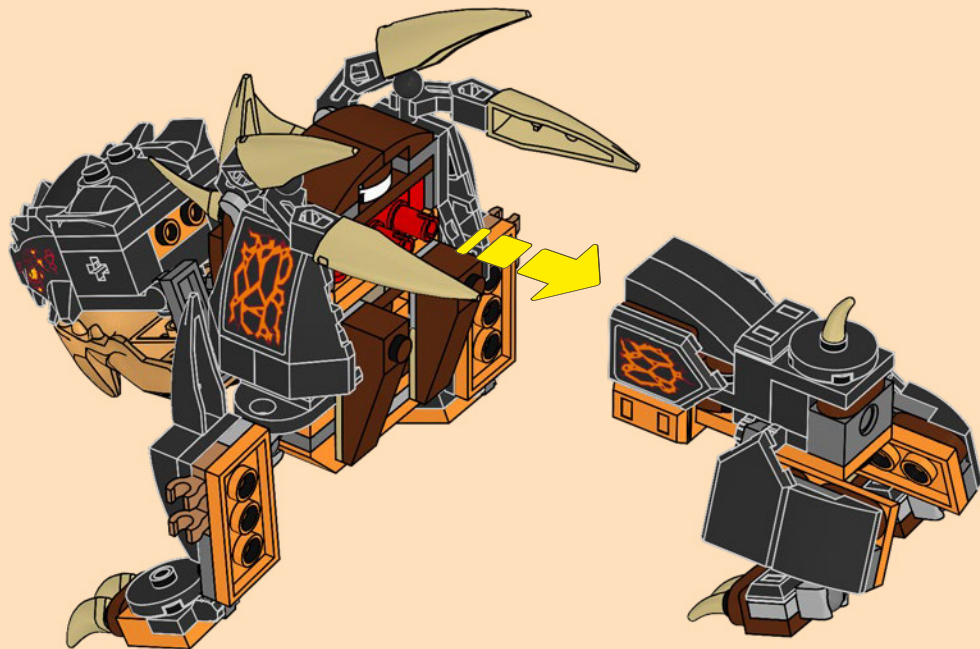

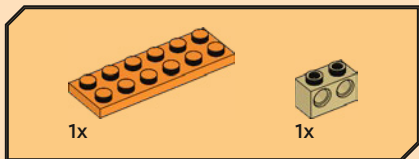
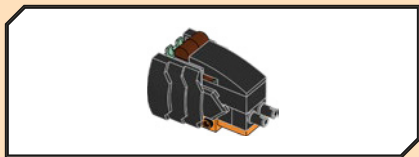

93

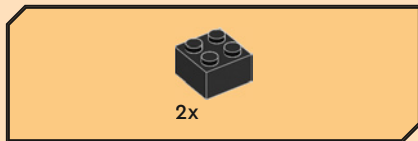
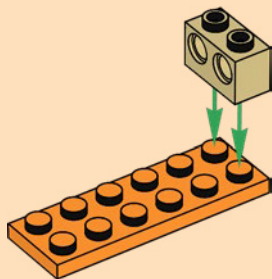

94

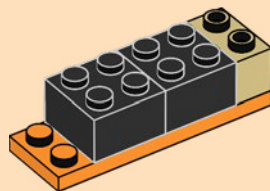

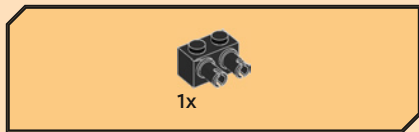

95

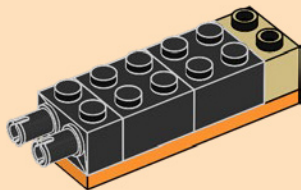

96

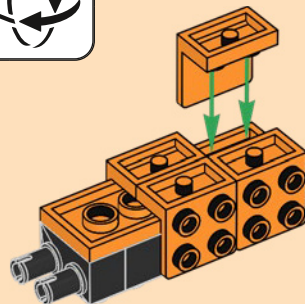

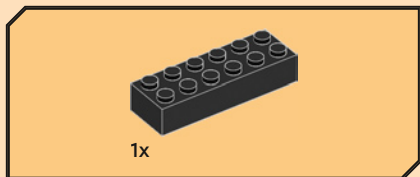

97

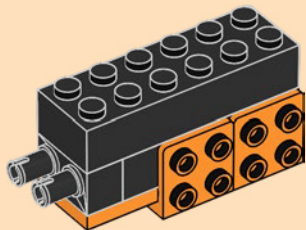

70



98

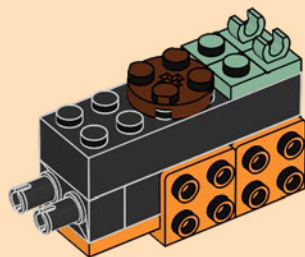

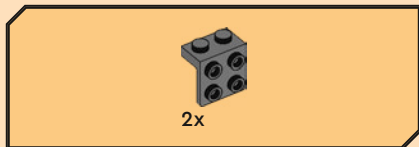

99

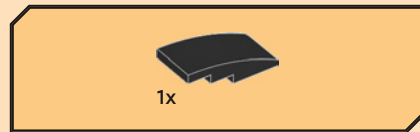
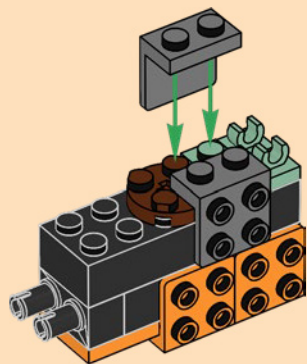

100

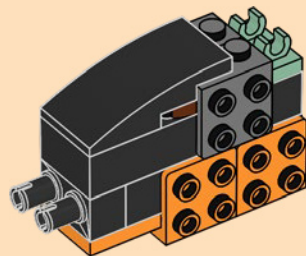



101

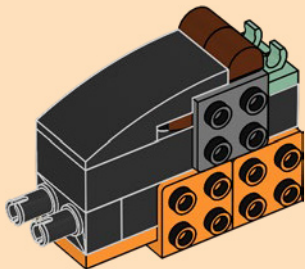

102

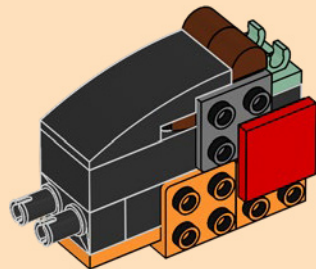



103

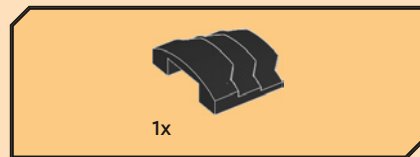
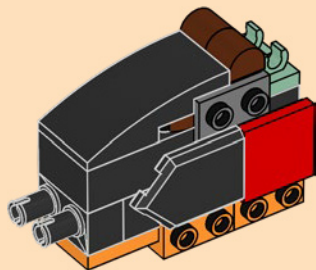

104

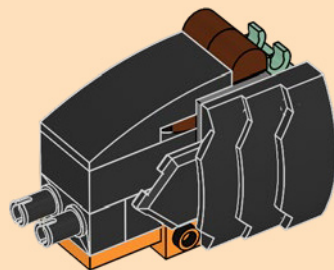



105

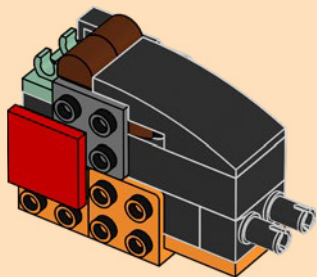

106

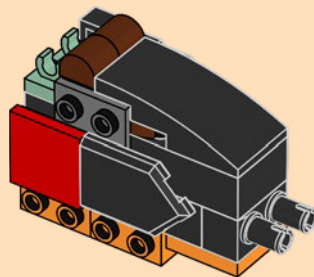

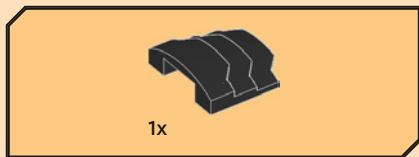

107

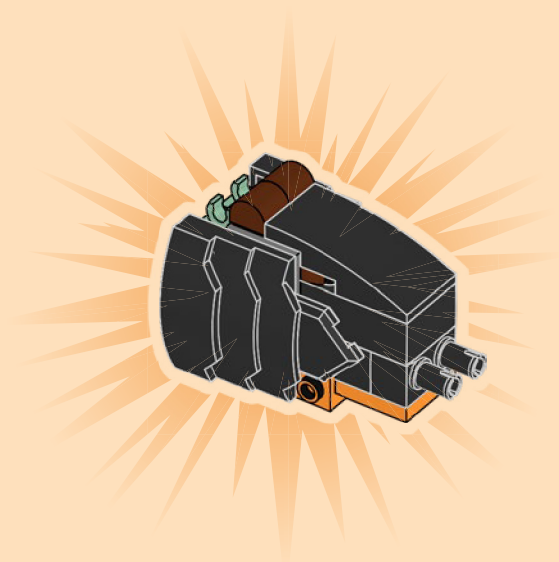

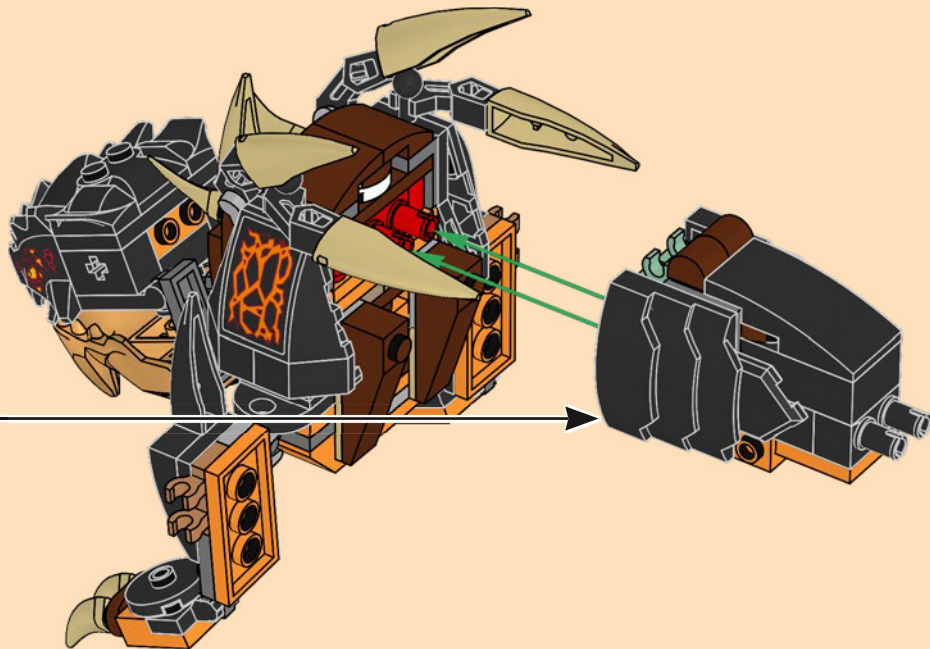

109

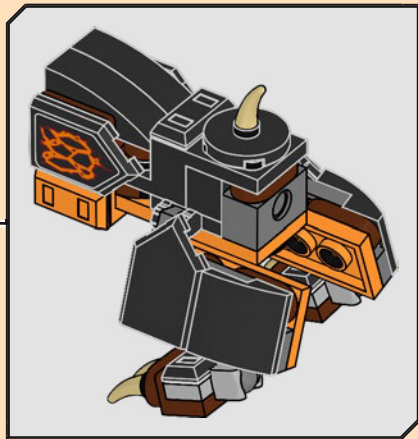
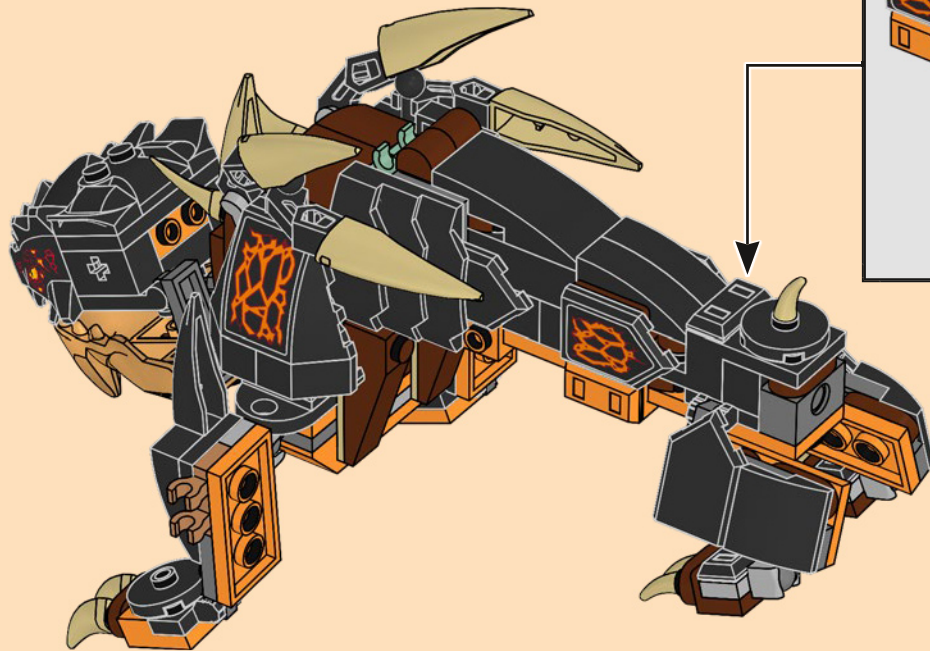

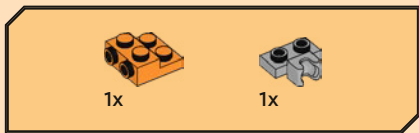
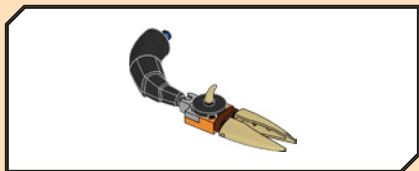

110

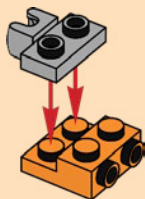

111

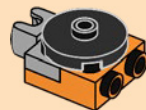



112

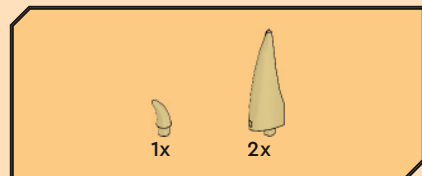
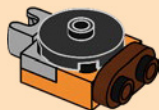

113

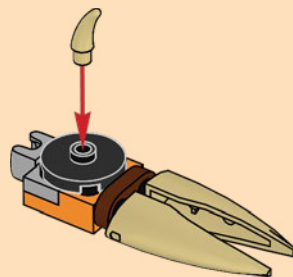

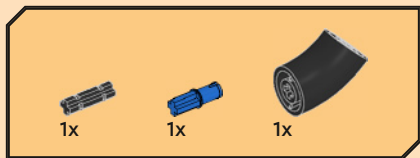

114



115

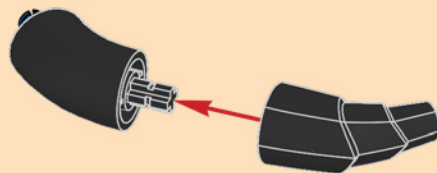

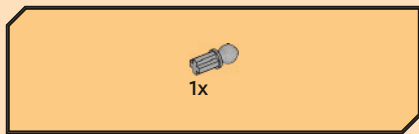

116

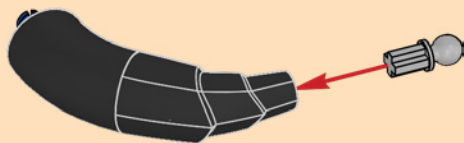

117

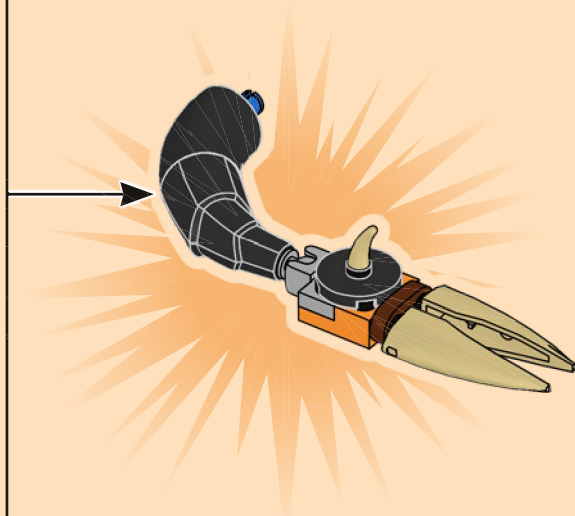

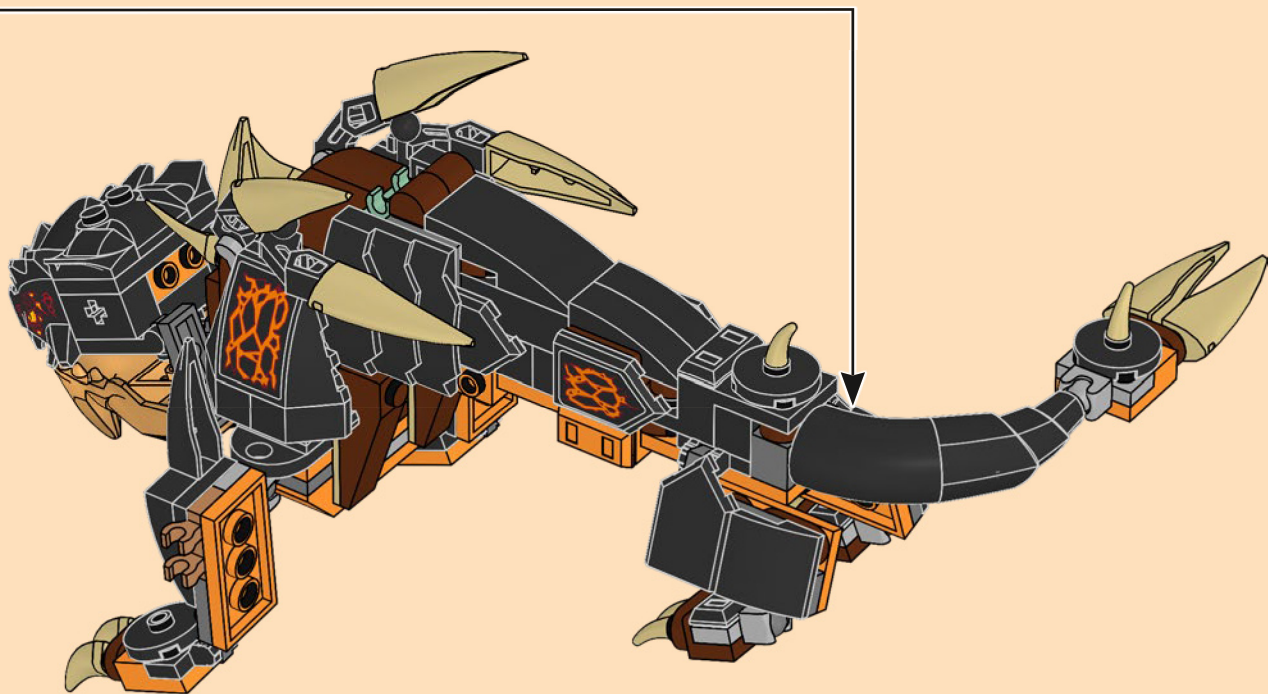

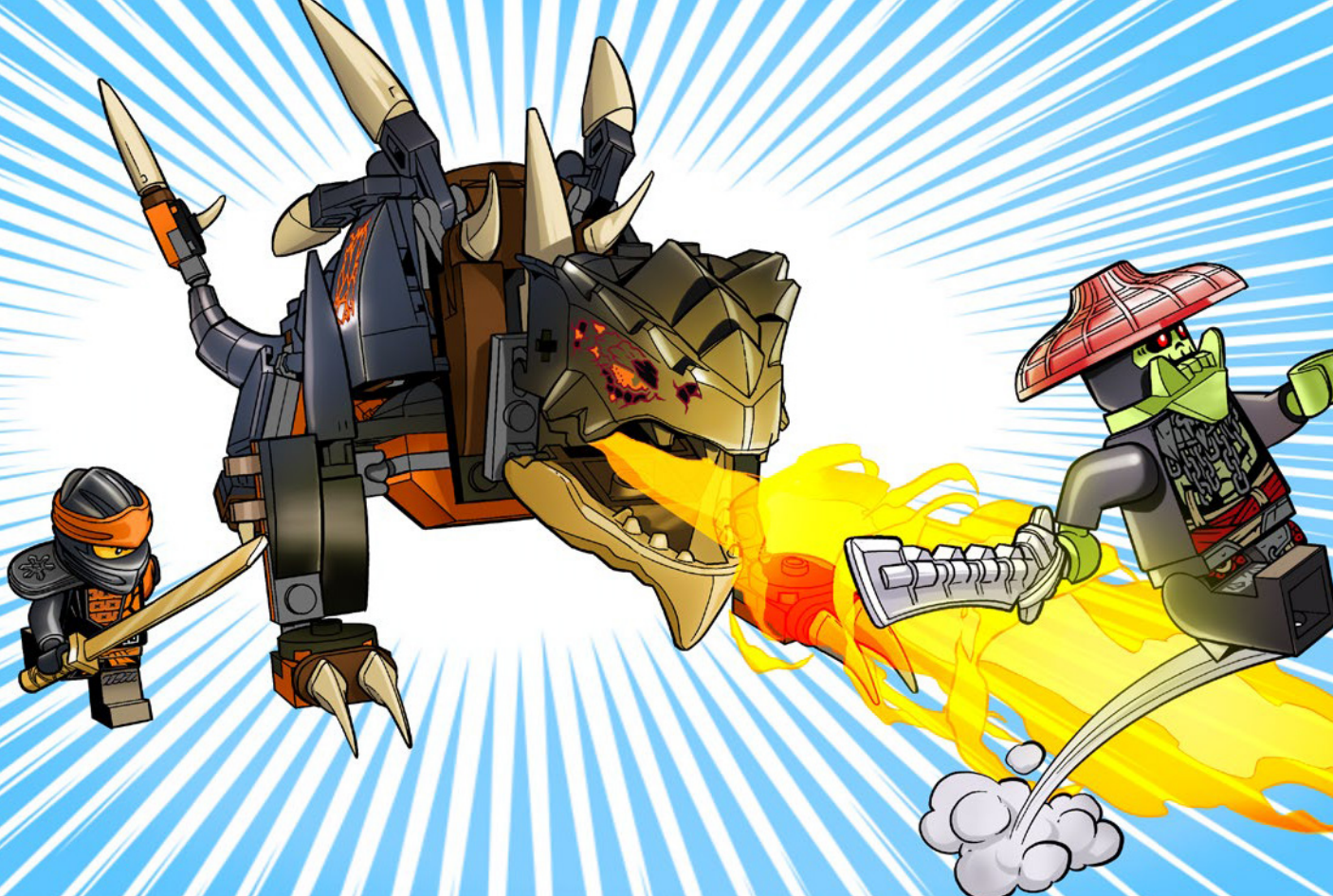

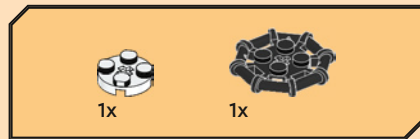

119

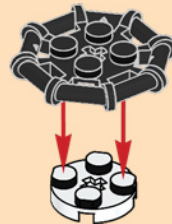

120

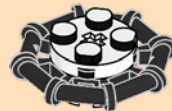

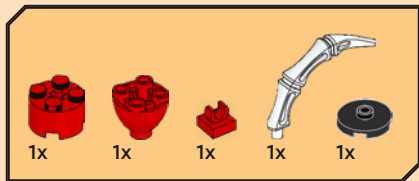

121

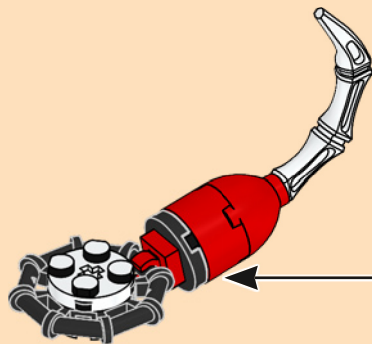
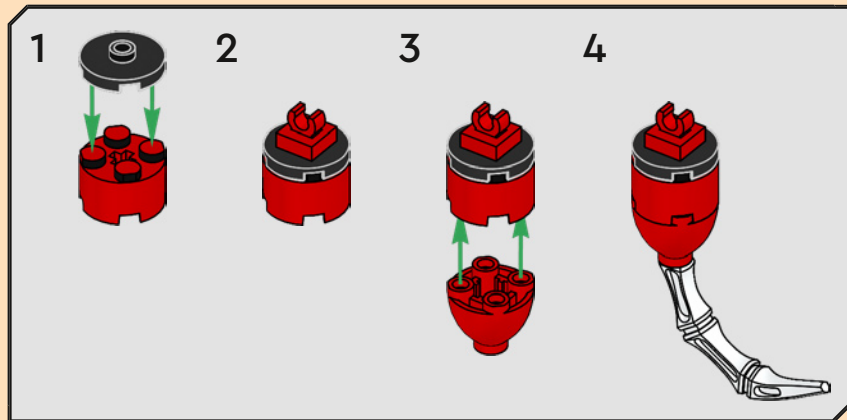

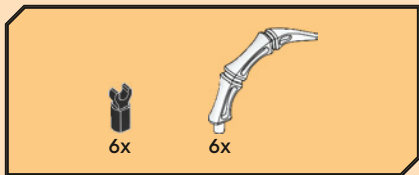

122

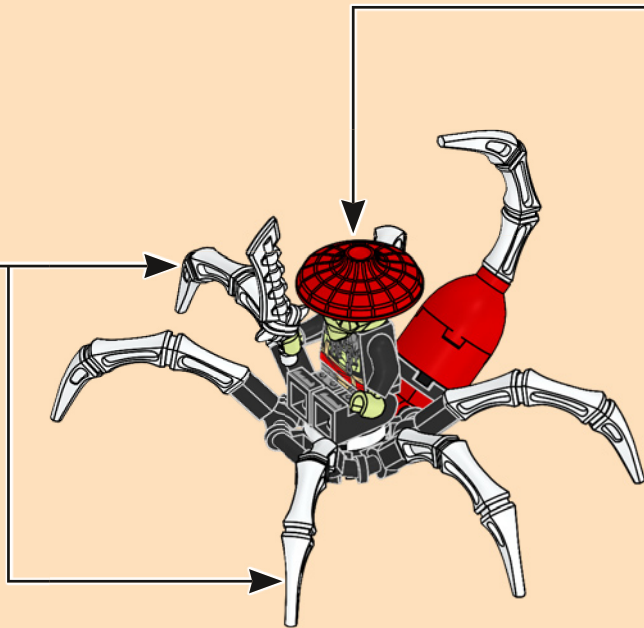
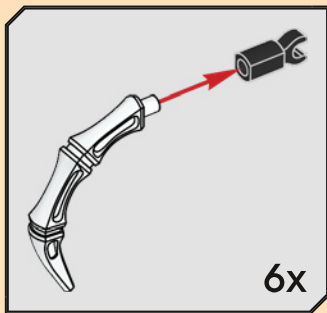



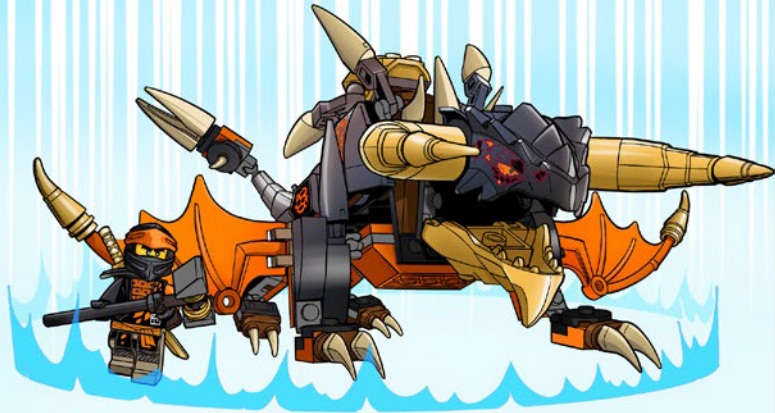

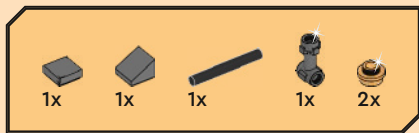

123

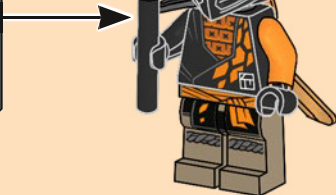
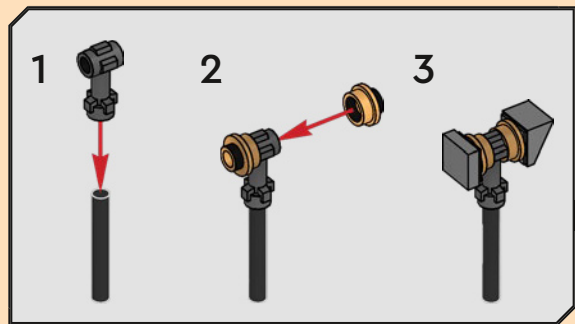



124

1



2



3

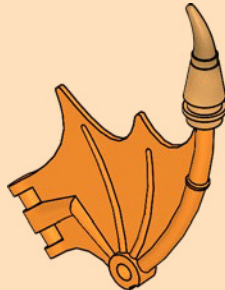

2x

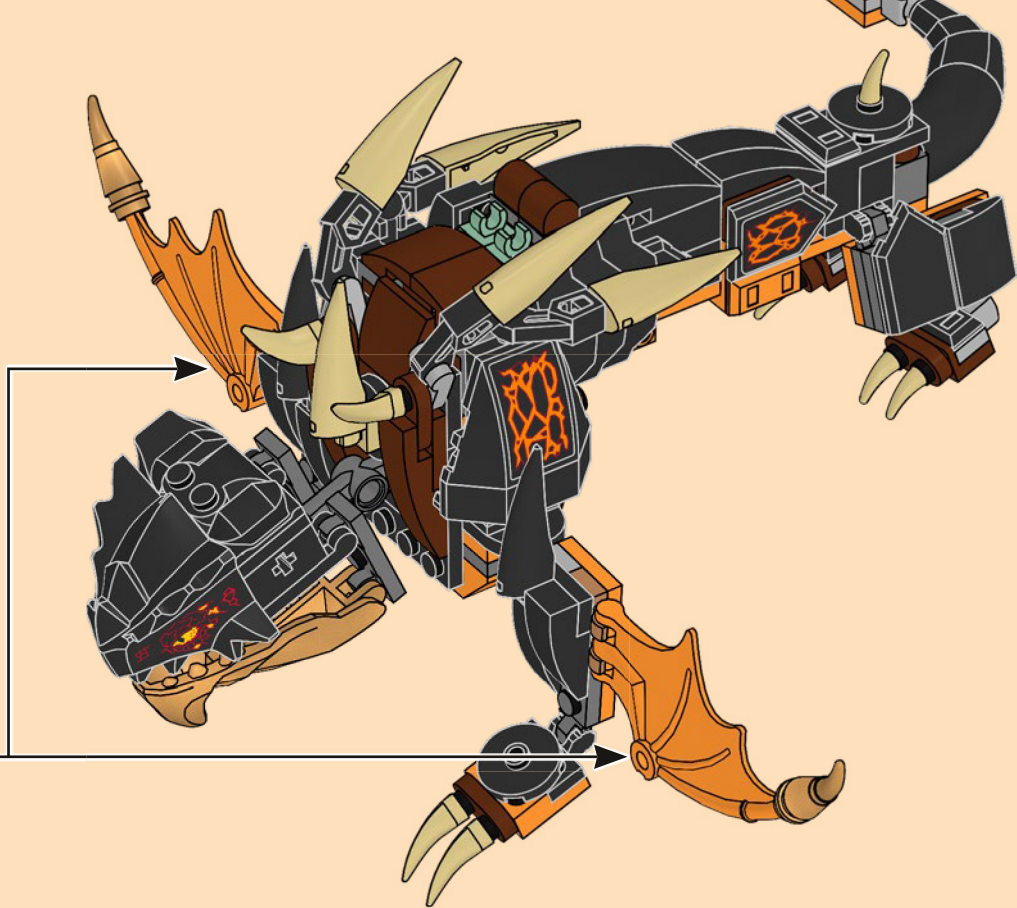

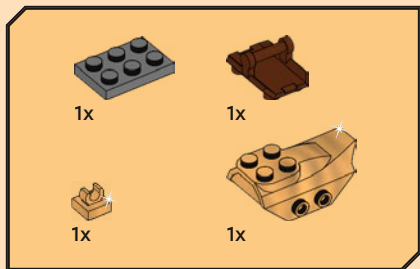

125

1



2



3



4

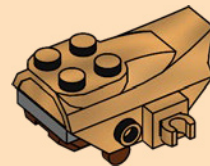

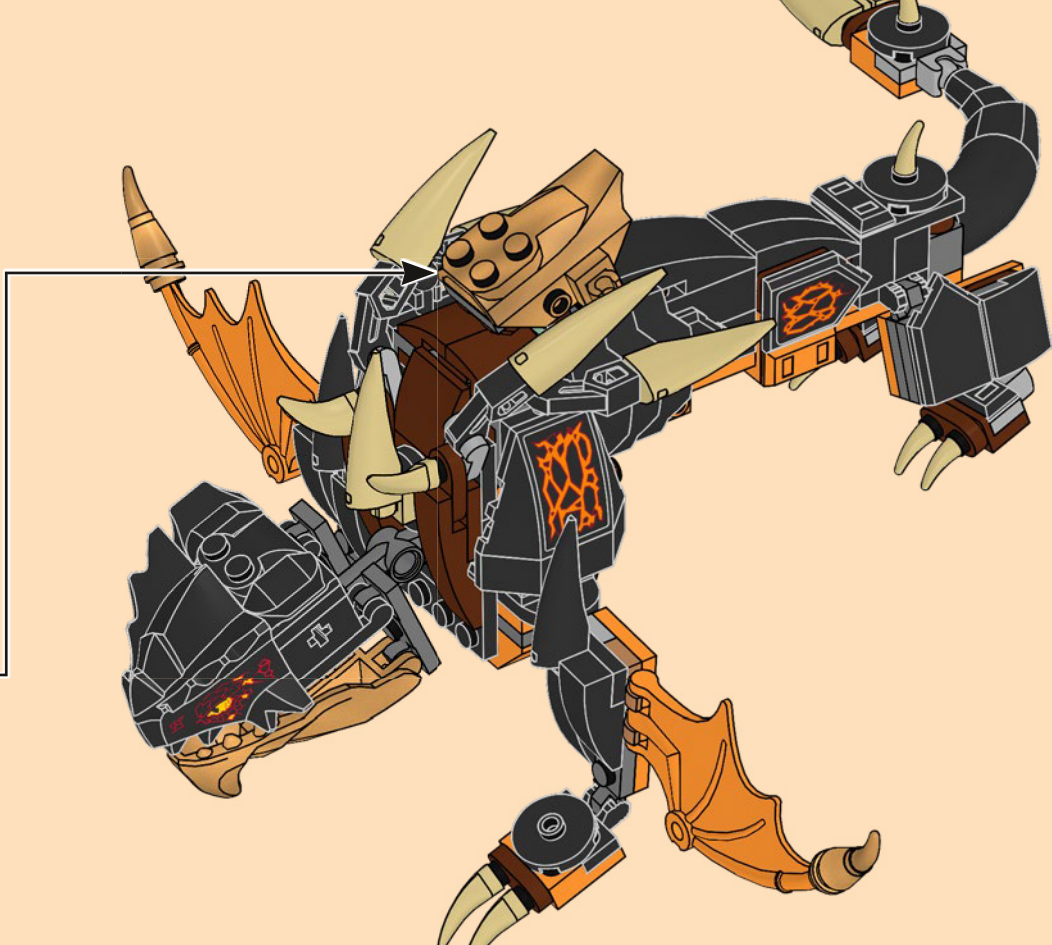

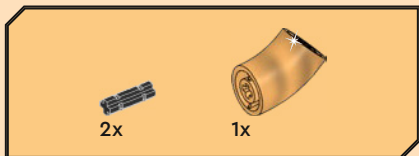
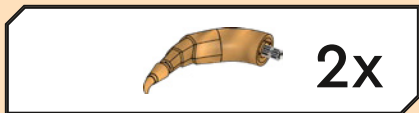

126

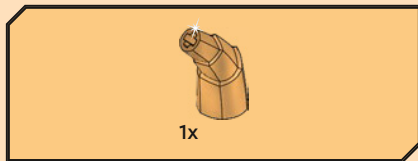
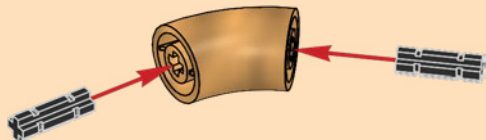

127

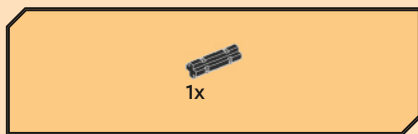
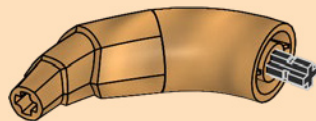

128

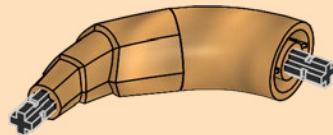



1x

129

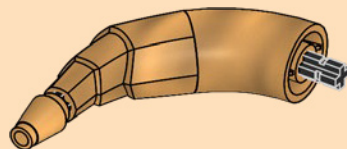

1x

130

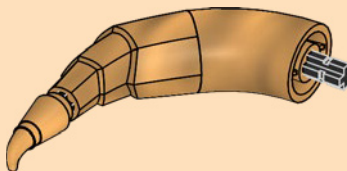

2x

131

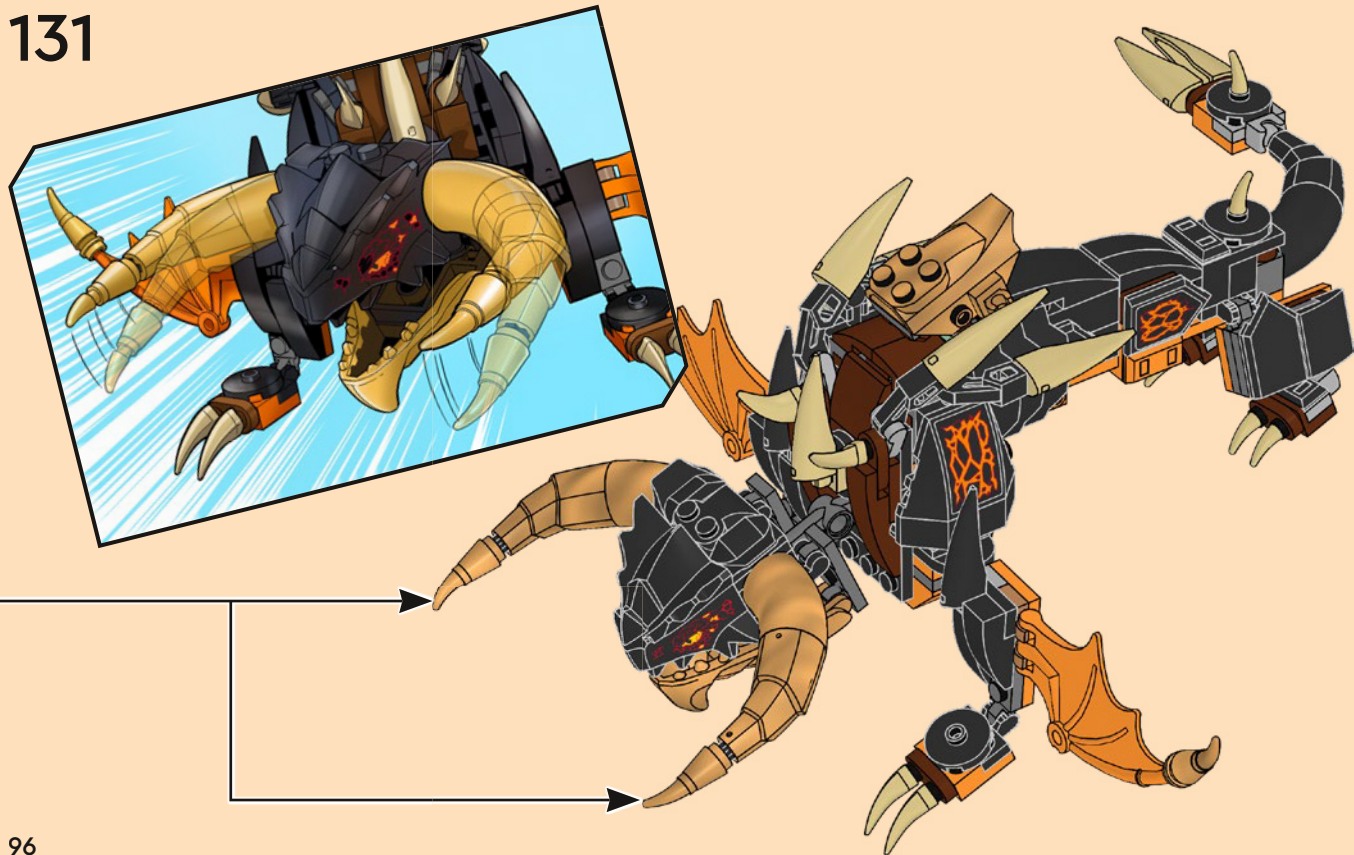



132

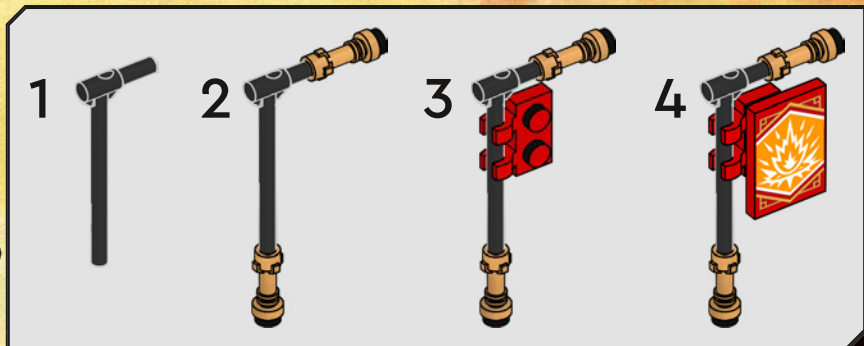





LEGO

NINJAGO



71785



71786



71787



71781



71782



71780



71784



71783

EXPLORE MORE!

Explore more / Mehr entdecken / En savoir plus / Esplora di più /
Explora más / Explora mais / 探索更多 / Узнайте больше /
Zobacz więcej / Objev více / Objav viac / Tudj meg többet! /
Descoperă mai multe / Разгледайте още / Uzzini vairāk /
Uuri lähemalt / Atrask daugiau



Blue-Ocean-AG.com/LEGONinjagoMagazine

Flag Illustrations: stockdevil - stock.adobe.com

Flag Illustrations / Abgebildete Flaggen / Illustrations de drapeaux / Illustrazioni delle bandiere /
Ilustraciones de banderas / Ilustrações de bandeiras / 旗帜插图 / Иллюстрации флагов /
Ilustracje — flagi / Obrázky vlajek / Obrázky vlajok / Zászló illusztrációk / Ilustrații cu steaguri /
Иллюстрации на знамена / Karogu attēli / Lippude pildid / Vėliavų iliustracijos





 [LEGO.com/service](https://www.lego.com/service)



YOU COULD **WIN**



Scan this QR code or go to **LEGO.COM/PRODUCTFEEDBACK** and give us your short feedback about this LEGO® set for a chance to win a cool LEGO prize.

Terms and Conditions apply*



DE: Du könntest GEWINNEN. Es gelten die Teilnahmebedingungen* **FR: Tu pourrais GAGNER.** Des conditions s'appliquent* **IT: Potresti VINCERE tu.** Termini e condizioni sono applicabili* **ES: Puedes GANAR.** Aplican términos y condiciones* **PT: Poderá GANHAR.** Aplicam-se termos e condições* **JA: プレゼント付き! 利用規約が適用されます*** **ZH: 轻松获奖. 条款和条件适用*** **KO: 상품의 주인이 되어보세요. 소정의 약관이 적용됩니다*** **RU: Вы можете ВЫИГРАТЬ.** Действуют положения и условия* **PL: Szansa na WYGRANĄ.** Obowiązują warunki korzystania* **CS: Máte šanci VYHRÁT.** Platí všeobecné smluvní podmínky* **SK: Máte šancu VYHRAŤ.** Platia všeobecné zmluvné podmienky* **HU: TE IS NYERHETSZ.** Felhasználási feltételek érvényesek* **RO: Ai putea CÂȘTIGA.** Se aplică termeni și condiții* **BG: Можете да СПЕЧЕЛИТЕ.** Има определени правила и условия* **LV: Tu vari LAIMĒT.** Ir spēkā noteikumi un nosacījumi.* **ET: Sul on võimalus VÕITA.** Kehtivad tingimused* **LT: Jūs galite LAIMĖTI.** Taikomos sąlygos*
*LEGO.com/productfeedback-terms