



**BRICK
HEADZ**

40632



[LEGO.com/brickheadz](https://www.LEGO.com/brickheadz)



 **FR**
DONNEZ
OU
RECYCLEZ

 OU  OU 

ASSOCIATION MAGASIN DÉCHÈTERIE

Adresses sur quefairedemesdechets.fr



LEGO.com/sustainable-packaging



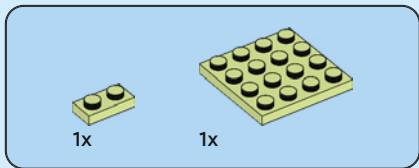

1

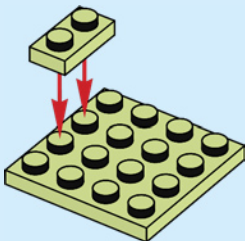



1x

2

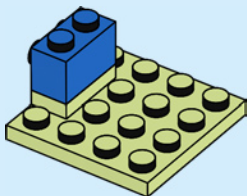

4x

3

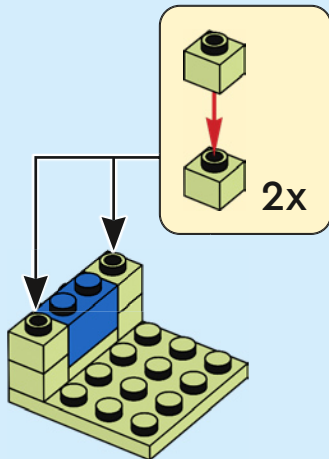

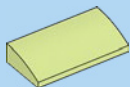

1x

4

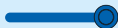
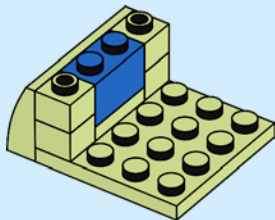



2x



2x

5

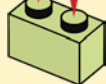
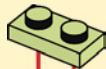

2x

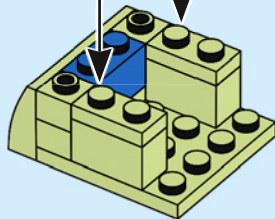

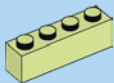

1x

6

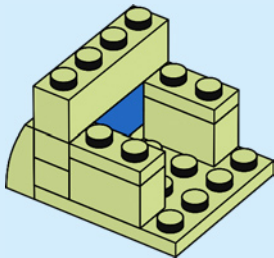

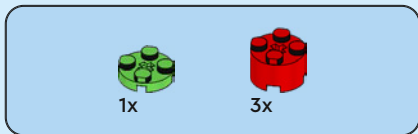

7

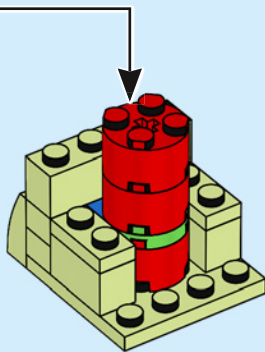
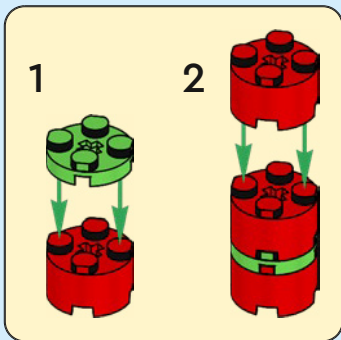

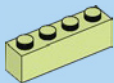

1x

8

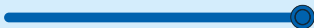
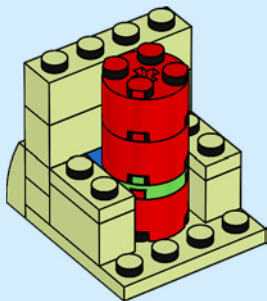



2x



2x

9



2x

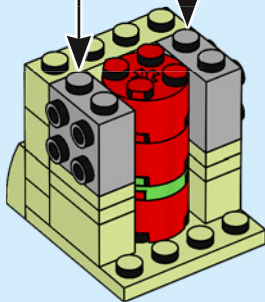

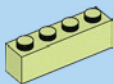

2x

10

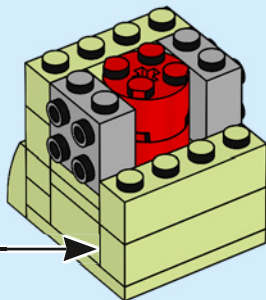
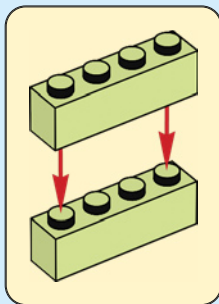

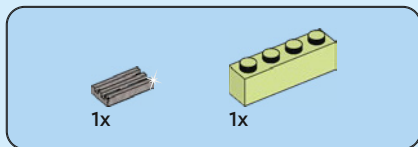

11

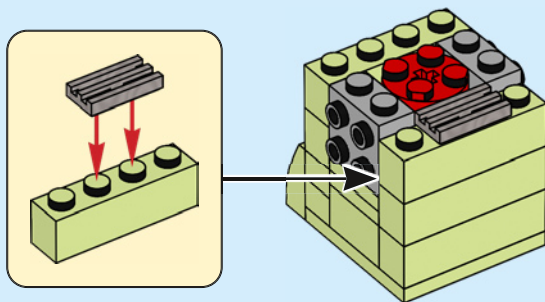



1x



2x

12

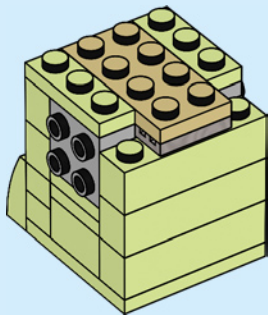



13

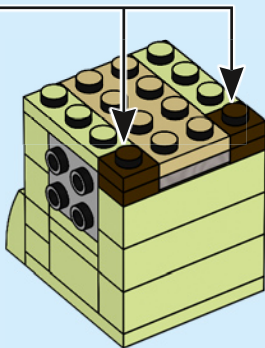
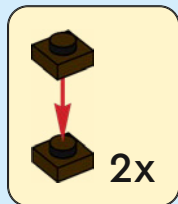



4x



2x



4x

14

1

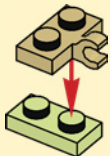

2



3

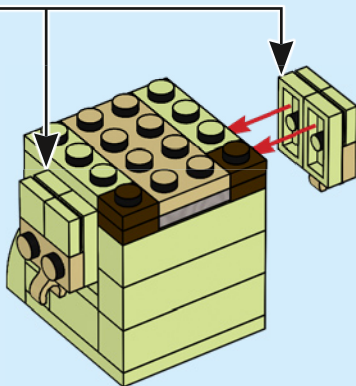
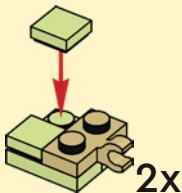



6x

15

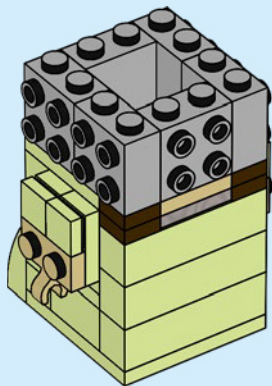

2x

16

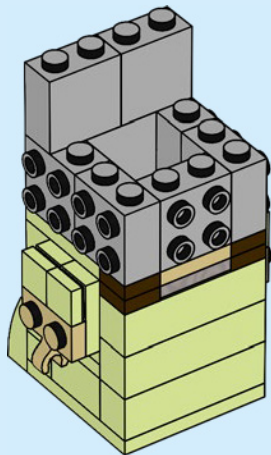



1x



1x



2x

17

1

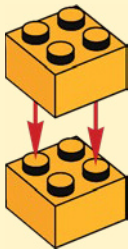

2

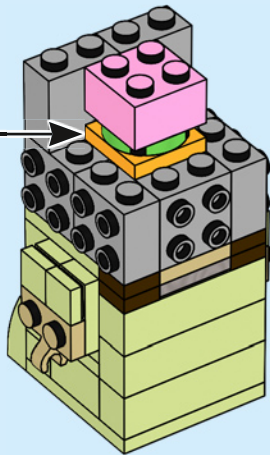
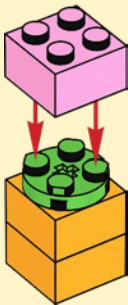



4x

18

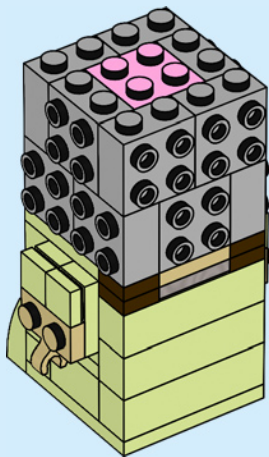

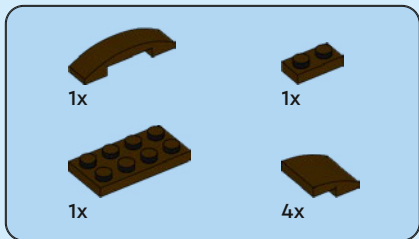

19



2



3

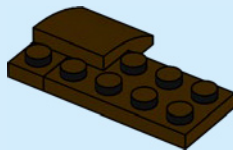

4



5

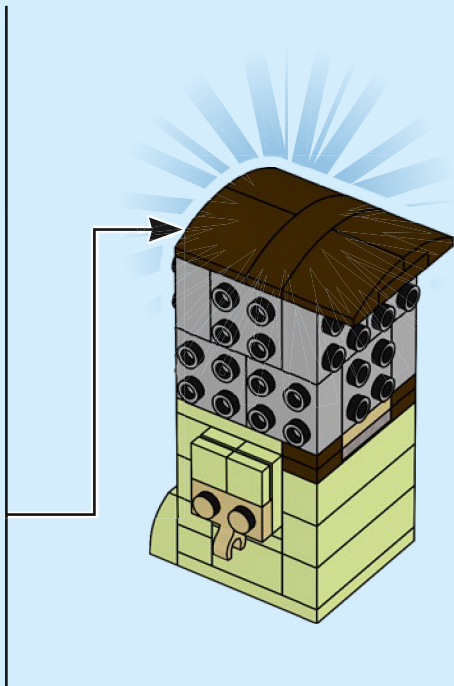
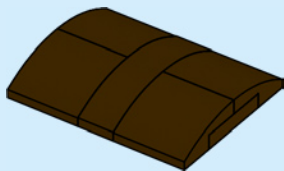

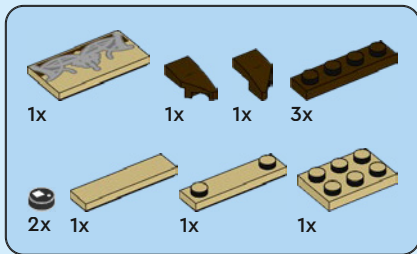

20

1

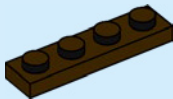

2



3



4

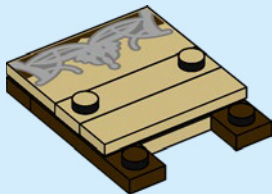

5

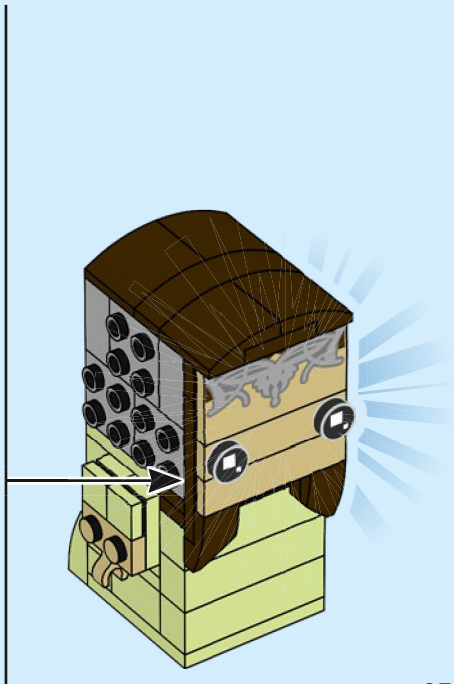
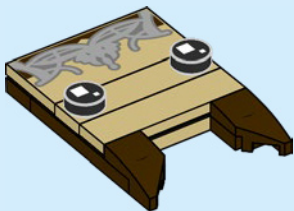



1x



2x



1x

21

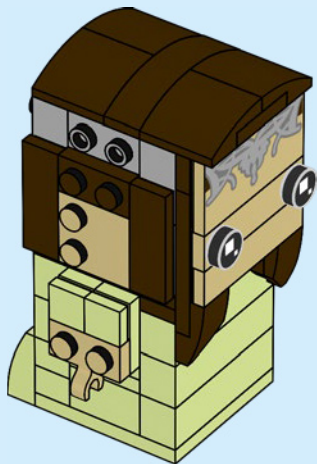



1x

22

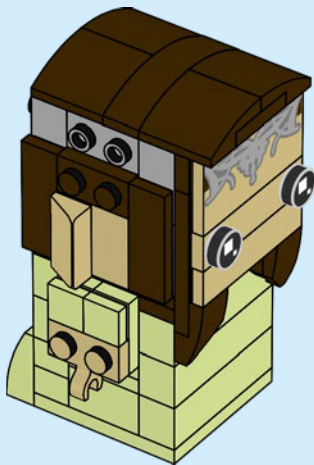



2x

23

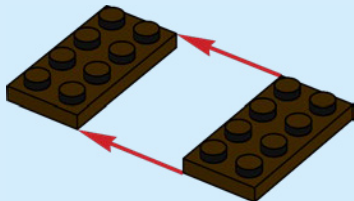



1x

24

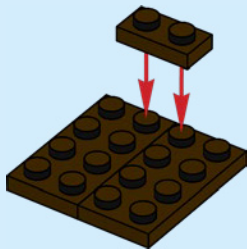

1x



1x

25

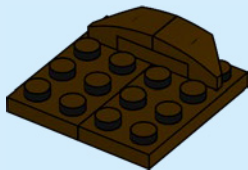

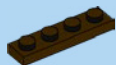

1x



2x

26

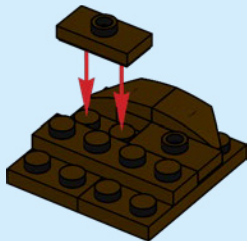



2x



1x

27

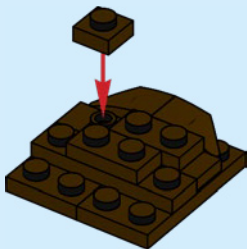

1x



1x



1x

28

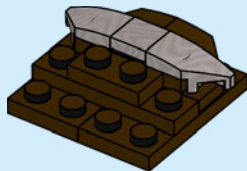



2x

29

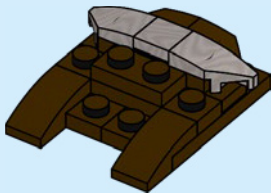

2x

30

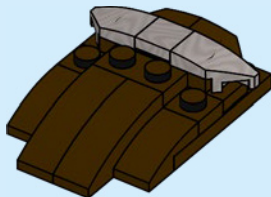

31

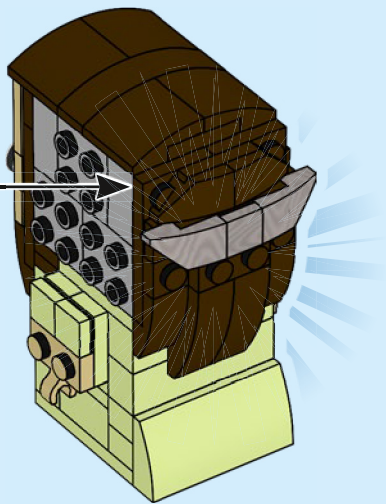



1x



2x



1x

32

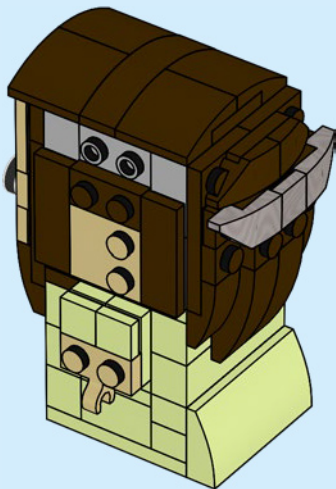



1x

33

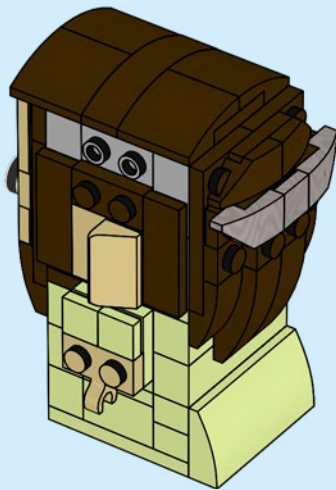



1x



1x



2x

34

1

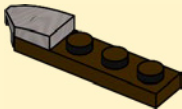

2

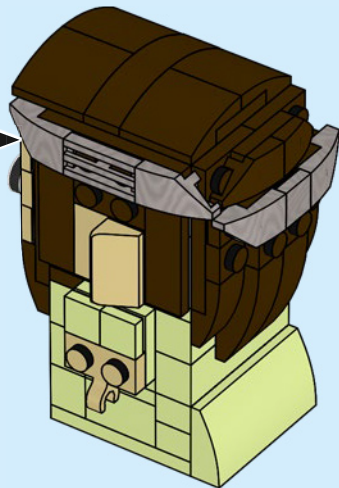
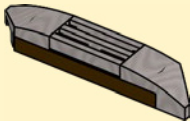

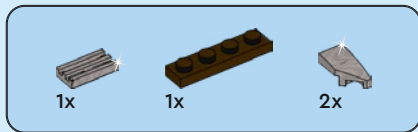

35

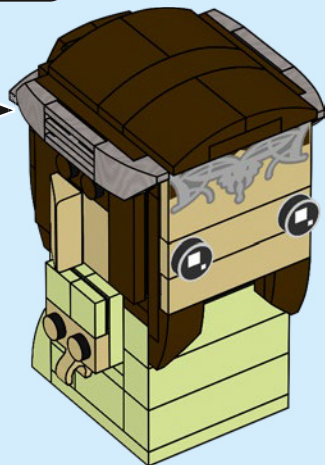
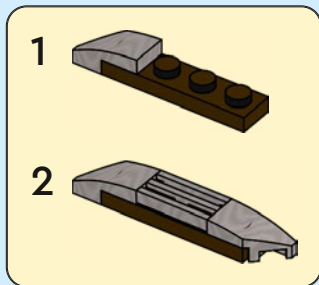

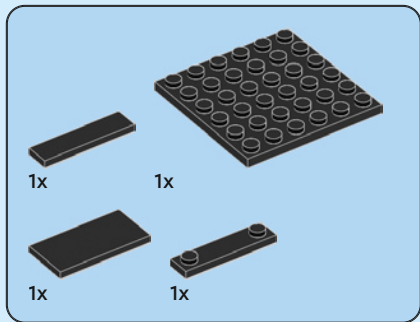

36

1

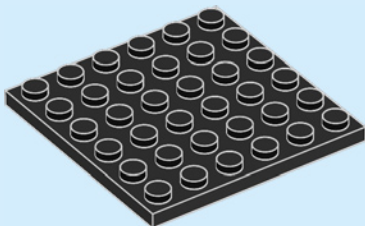

2

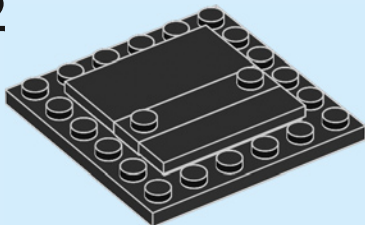

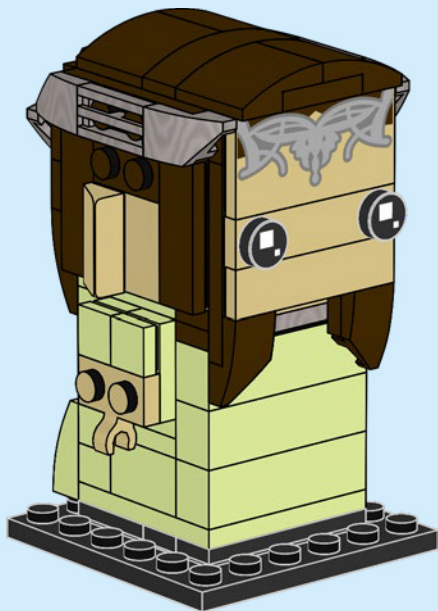

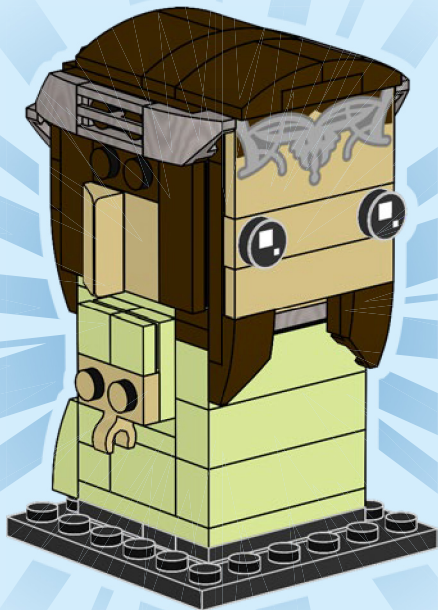



Rebuild
the
world™



YOU COULD
WIN



Scan this QR code or go to
LEGO.COM/PRODUCTFEEDBACK and give us
your short feedback about this LEGO® set
for a chance to win a cool LEGO prize.

Terms and Conditions apply*

DE: Du könntest GEWINNEN. Es gelten die Teilnahmebedingungen* **FR: Tu pourrais GAGNER.** Des conditions s'appliquent* **IT: Potresti VINCERE tu.** Termini e condizioni sono applicabili* **ES: Puedes GANAR.** Aplican términos y condiciones* **PT: Poderá GANHAR.** Aplicam-se termos e condições* **JA: プレゼント付き! 利用規約が適用されます*** **ZH: 轻松获奖. 条款和条件适用*** **KO: 상품의 주인이 되어보세요. 소정의 약관이 적용됩니다*** **RU: Вы можете ВЫИГРАТЬ.** Действуют положения и условия* **PL: Szansa na WYGRANĄ.** Obowiązują warunki korzystania* **CS: Máte šanci VYHRÁT.** Platí všeobecné smluvní podmínky* **SK: Máte šancu VYHRATĚ.** Platia všeobecné zmluvné podmienky* **HU: TE IS NYERHETSZ.** Felhasználási feltételek érvényesek* **RO: Ai putea CĂȘTIGA.** Se aplică termenii și condiții* **BG: Можете да СПЕЧЕЛИТЕ.** Има определени правила и условия* **LV: Tu vari LAIMĒT.** Ir spēkā noteikumi un nosacījumi.* **ET: Sul on võimalus VÕITA.** Kehtivad tingimused* **LT: Jūs galite LAIMĖTI.** Taikomos sąlygos*

*[LEGO.com/productfeedback-terms](https://www.lego.com/productfeedback-terms)

LEGO and the LEGO logo are trademarks of the LEGO Group. ©2023 The LEGO Group.

©NLP TM Middle-earth Ent. Lic. to NLP.

6505937



**BRICK
HEADZ**

40632



[LEGO.com/brickheadz](https://www.LEGO.com/brickheadz)

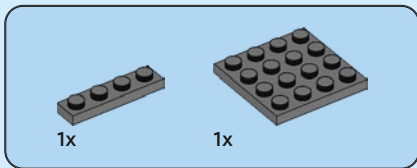

1

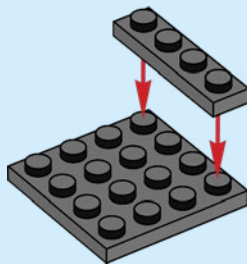

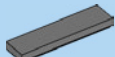

1x



1x

2

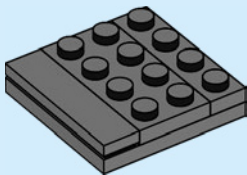

1x

3

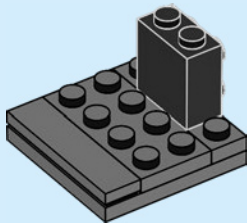



1x



1x

4

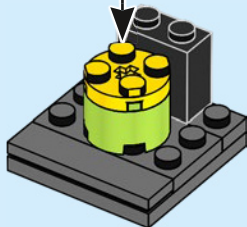
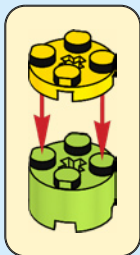



2x



2x

5

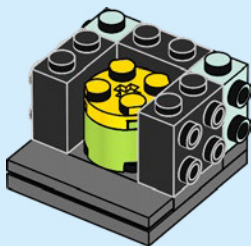

1x



1x

6

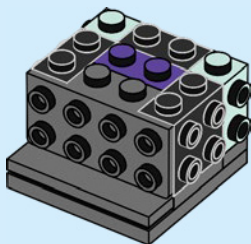

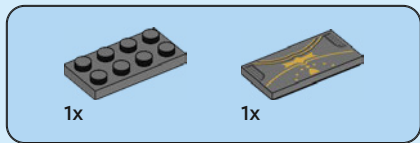

7

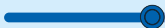
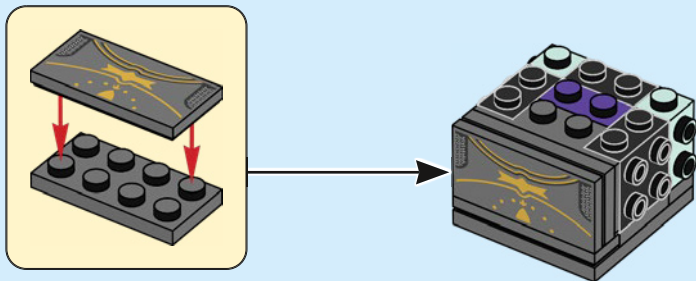



1x



1x



2x

8

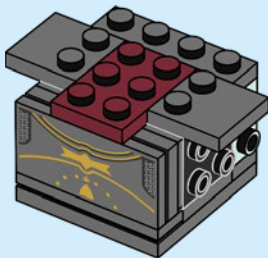

4x

9

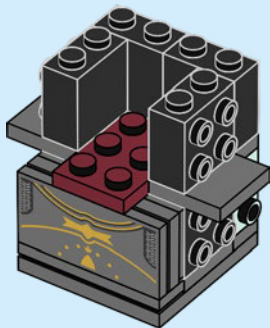



3x



2x

10

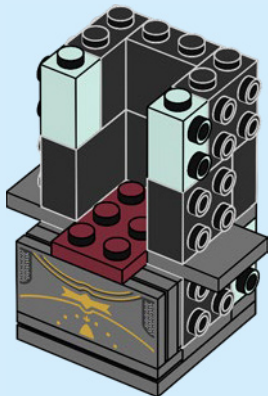

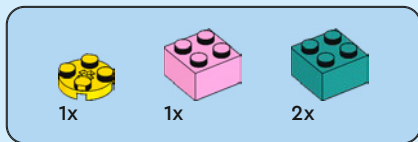

11

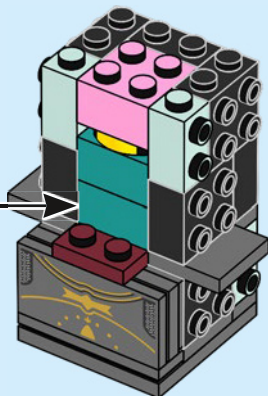
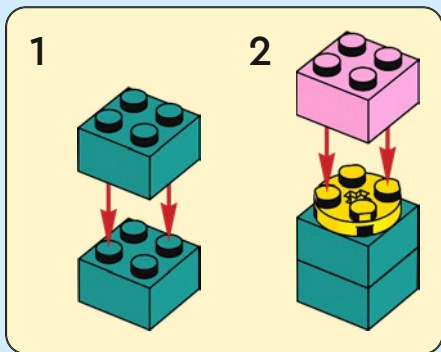

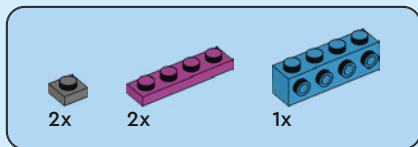

12

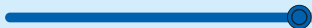
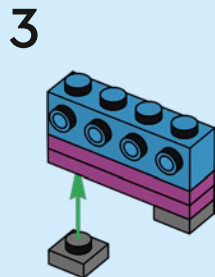
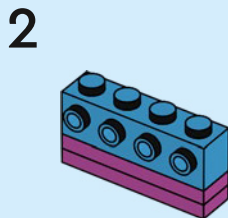
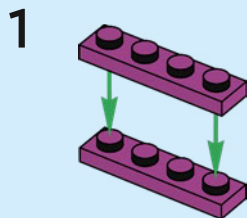

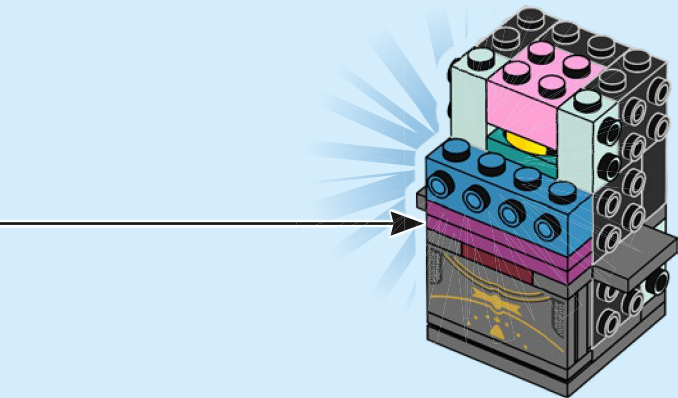



2x

13

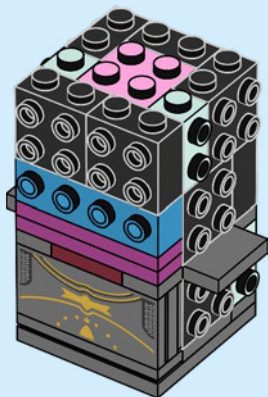

12





1x

14

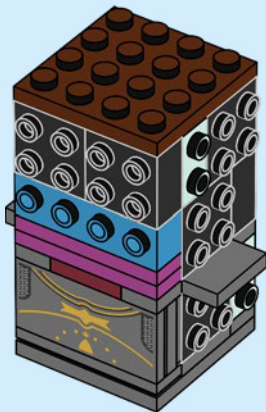

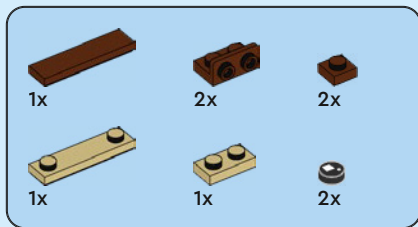

15

1

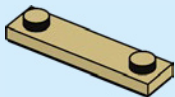

2

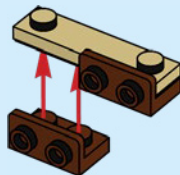

3

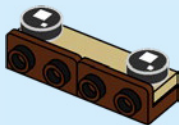

4

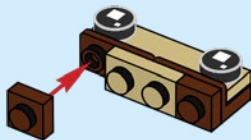

5

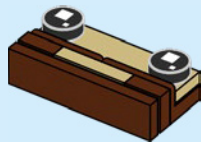

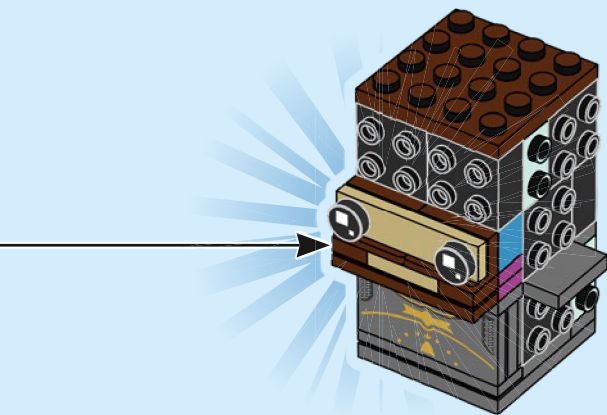

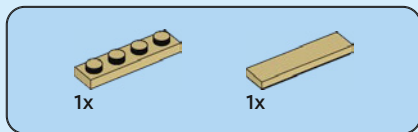

16

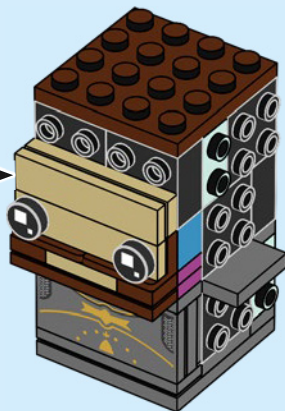
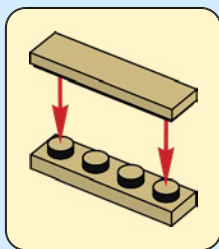



2x



2x



2x

17

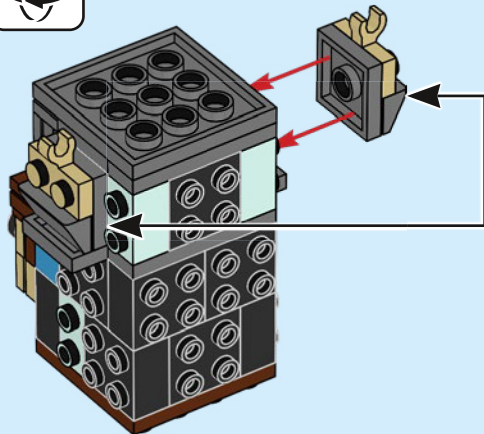

1

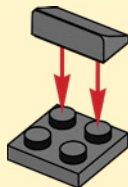

2

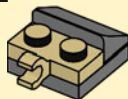

2x



1x



2x

18

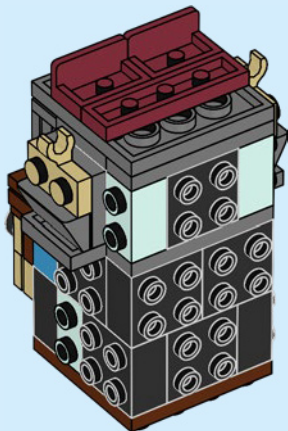

2x

19

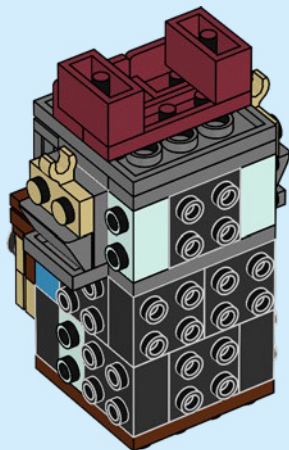



1x



1x



1x



2x

20

1



2



3

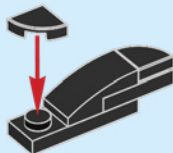

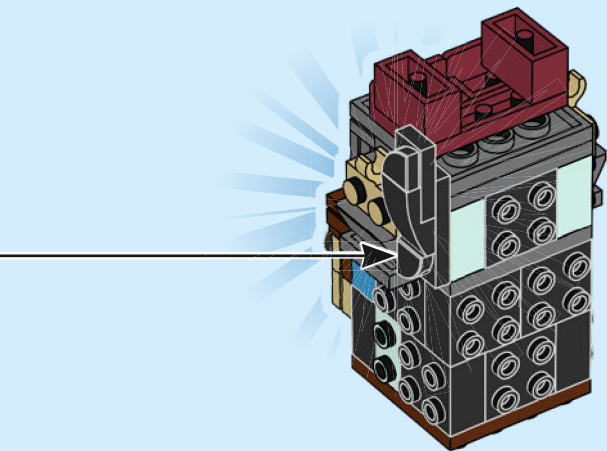

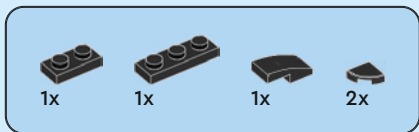

21

1



2



3

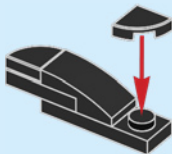

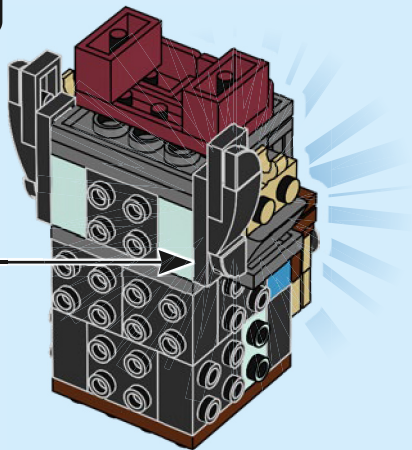

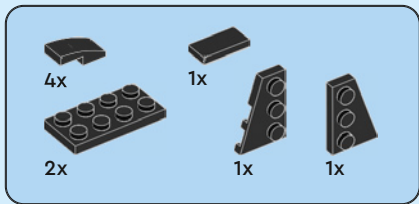

22

1

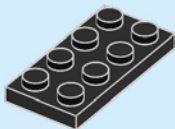

2

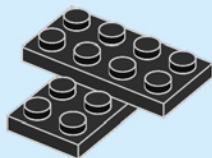

3

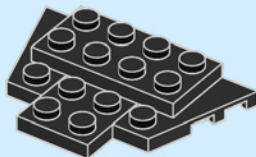

4

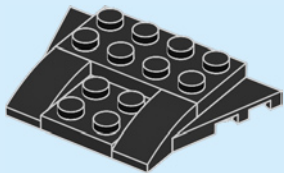

5

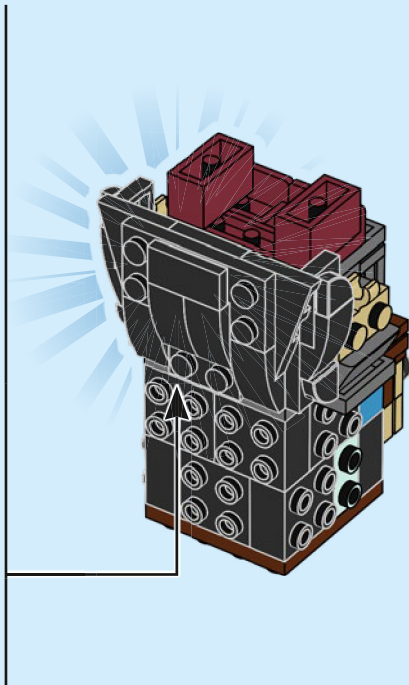
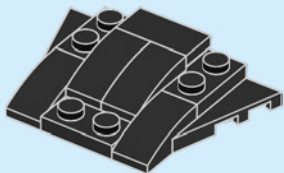

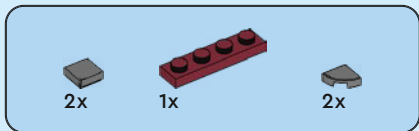

23

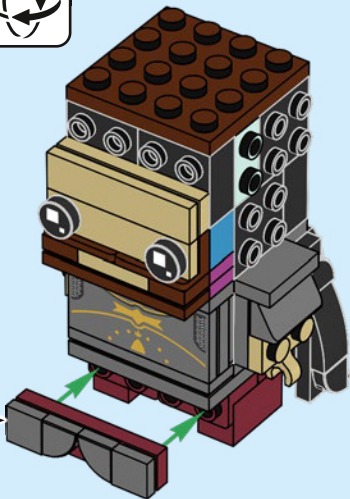
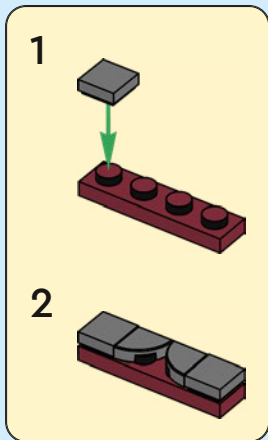



1x



1x

24

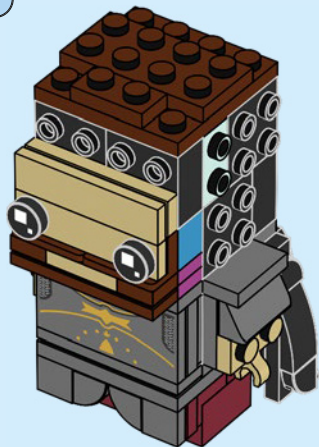

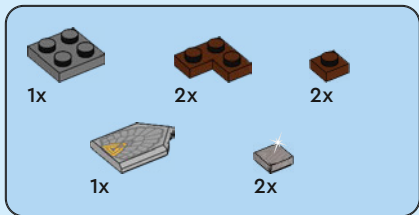

25

1



2

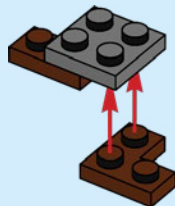

3

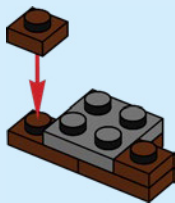

4

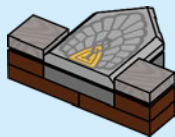

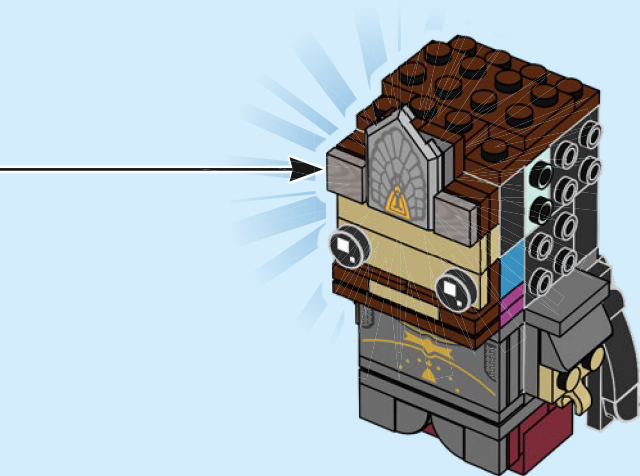



1x



1x

26

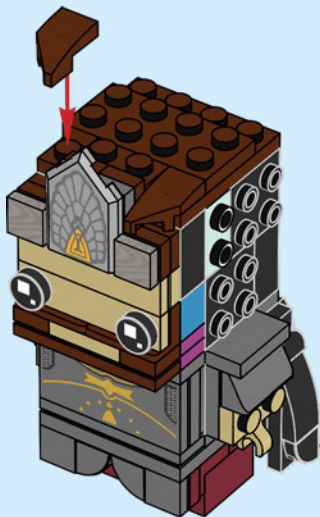



1x

27

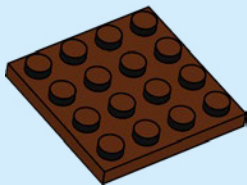

1x



1x

28

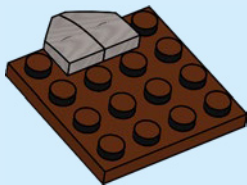



1x

29



1x



1x



1x

30

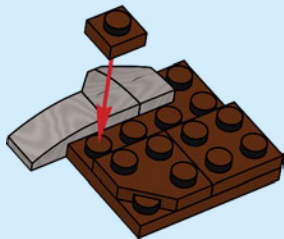



1x



2x

31

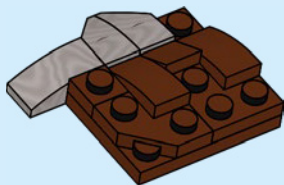

3x

32

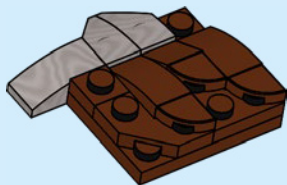

33

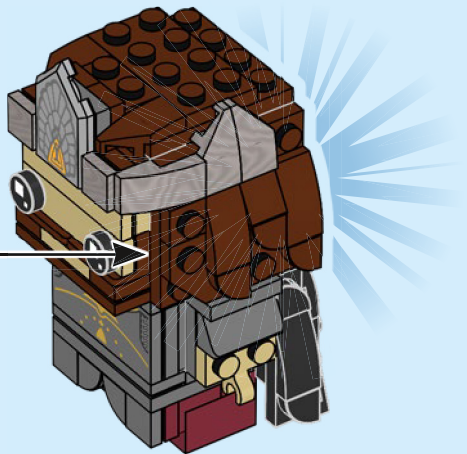



1x

34

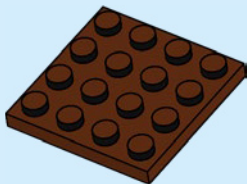

1x



1x

35





1x

36



1x



1x



1x

37

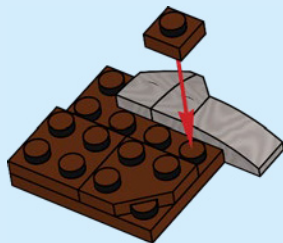



1x



2x

38

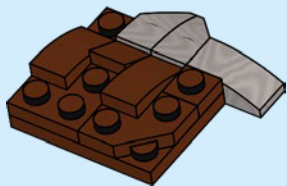

3x

39

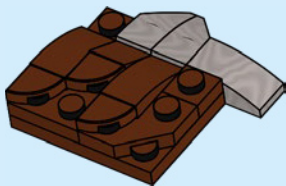

40

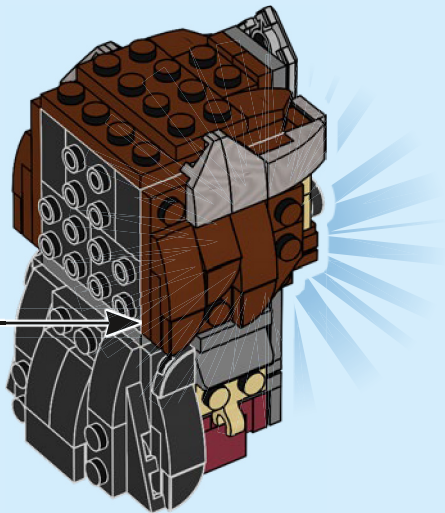

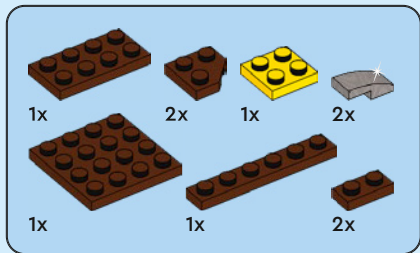

41

1



2

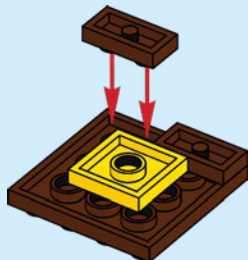

3

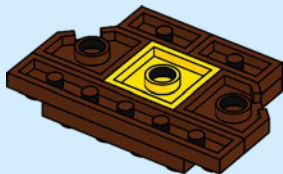

4

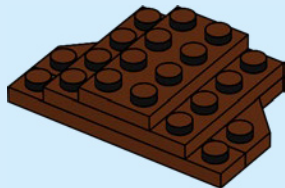

5

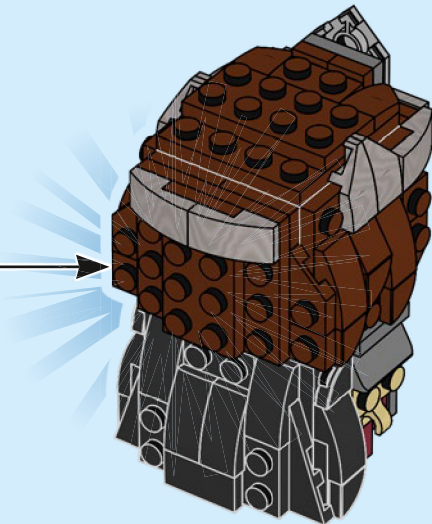
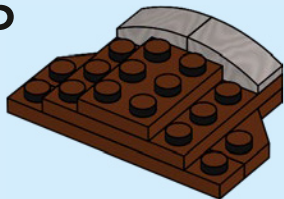



2x

42

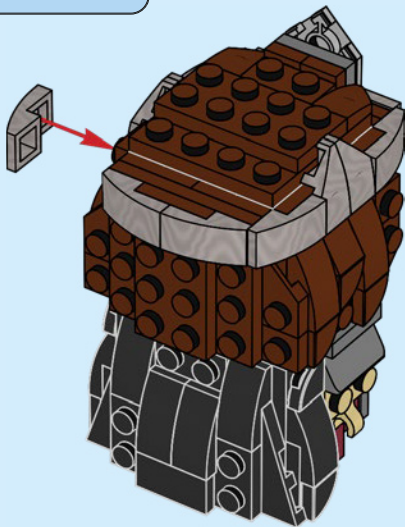



1x



1x



1x

43

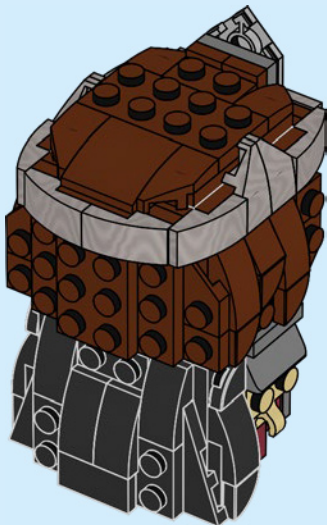



1x

44

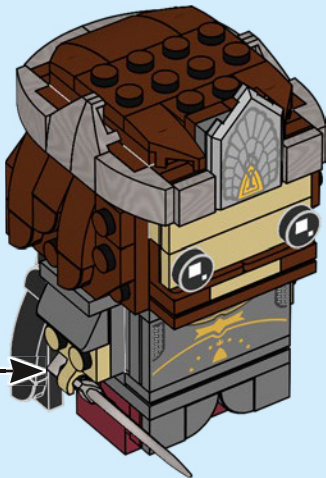
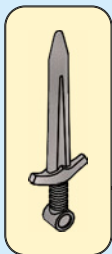

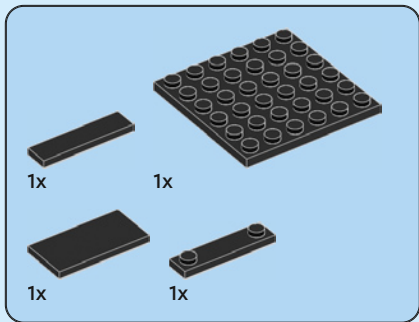

45

1

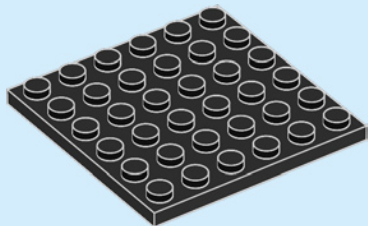

2

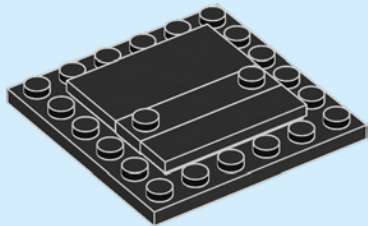

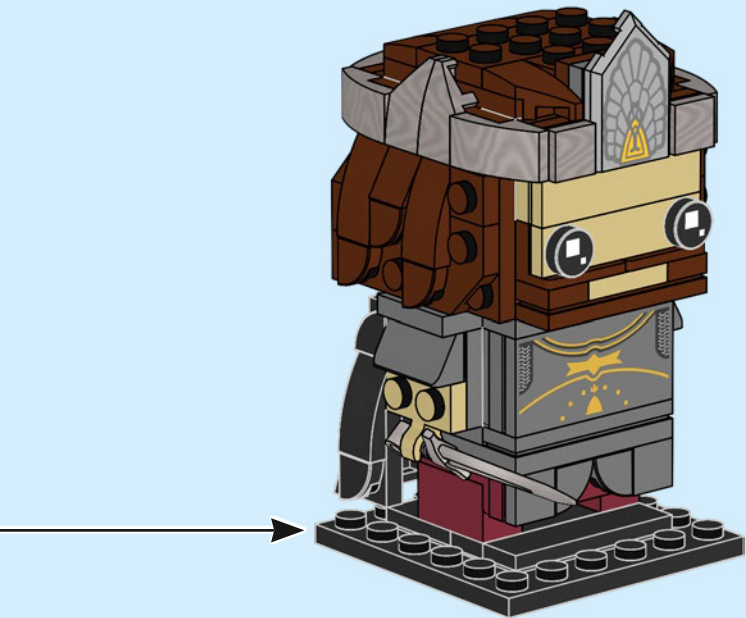

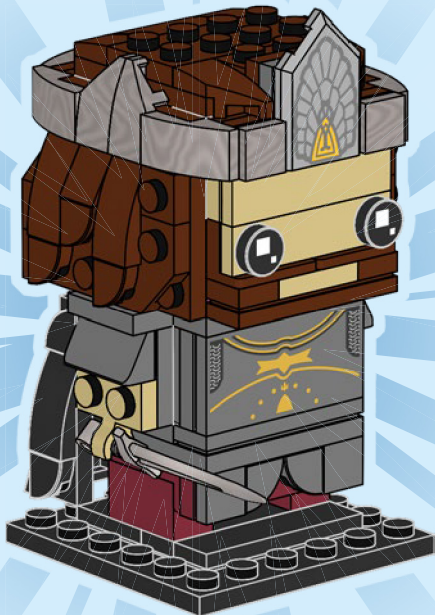



2x
6314091



1x
4527943



2x
6037652



2x
4539102



2x
6264026



1x
6264030



2x
4539061



2x
4624086



4x
6313119



1x
4113917



2x
6221467



1x
4118790



1x
4113233



2x
4550324



2x
6257600



1x
6430718



1x
4114309



3x
614321



1x
6189191



2x
403224



1x
302224



4x
6284077



4x
6172383



1x
4180536



1x
4180508



12x
6275806



1x
306926



6x
6047276



2x
302326



2x
362326



2x
6254045



2x
243126



2x
302026



2x
4560182

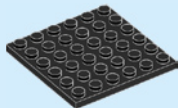

2x
395826



2x
6138624



2x
6295078



6x
4221744



2x
4504376



2x
6290397



6x
6149677



2x
6290396



4x
6218366



3x
4211150



4x
6069984



2x
6174856



2x
4216695



2x
4211257



1x
6146858



1x
4211194



2x
4211186



1x
4221590



4x
4243838



14x
6123809



1x
6430719



2x
4210848



2x
4210719



2x
6199549



2x
4567887



2x
6309059



1x
4243831



1x
6118832



1x
4211053



2x
4211001



2x
4211065



1x
6430720



3x
4211094



2x
4550359



1x
4655695



5x
6194729



2x
6258952



2x
6258950



2x
6404033



6x
6058221



2x
6046943



4x
6047037



4x
6167928



2x
6022199



6x
6252667



1x
6135005



3x
6226792



1x
6295400



1x
6250001



4x
6356101



4x
6304896



4x
6382547



9x
6424046



2x
6104578



2x
6069258



5x
6382110



1x
6424045

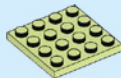

1x
6431433



3x
6237120



3x
6051422



5x
6385511



5x
6385509



6x
6066028



[LEGO.com/service](https://www.LEGO.com/service)



BRICK 'H'HEADZ

THE
LORD
OF THE
RINGS

40632



GOLLUM™ 40630 **183** FRODO™ 40630 **184** GANDALF THE GREY™ 40631 **185** BALROG™ 40631 **186**

LEGO and the LEGO logo are trademarks of the LEGO Group. ©2023 The LEGO Group.
©NLP™ Middle-earth Ent. Lic. to NLP.

6449480