



# BRICK HEADZ

40622



Booklet available in English on  
Heft in deutscher Sprache erhältlich auf  
Livret disponible en français sur  
Libretto disponibile in italiano su  
Folleto en español disponible en  
如需中文版手册, 请访问:

[LEGO.com/service/buildinginstructions](https://www.lego.com/service/buildinginstructions)



[LEGO.com/brickheadz](https://www.lego.com/brickheadz)



[LEGO.com/sustainable-packaging](https://LEGO.com/sustainable-packaging)



Disney  
100

*For a century, Disney movie magic has captured generations of fans worldwide. Join us in celebrating four trail-blazing, animated heroes who each made Disney™ history.*

## **OSWALD THE LUCKY RABBIT**

This peppy little prankster's talent for thinking on his (lucky) feet always gets him out of comical predicaments. Oswald tackles every tricky situation with (sometimes unwarranted) confidence and a savvy sense of humour. Oswald first debuted in *Trolley Troubles* in 1927 and was featured in 25 theatrical cartoons. In 1928, rights were acquired by Universal Studios and Walt Disney was forced to explore new directions.



*"Oswald will not only be able to hold his own with competition but will set a pace that will make the others hustle."*

*- Walt Disney*



Disney  
100



## MICKEY MOUSE

After all these years, Mickey Mouse remains as plucky and joyfully mischievous as ever. A loyal and caring friend and leader, he relies on his generous heart, humour and keen wit to solve every problem, and his curiosity and passion for exploring new things take him on incredible adventures with his friends. Mickey Mouse starred in Disney's first cartoon with synchronised sound; *Steamboat Willie* (1928), which led to the successful growth of the Walt Disney Studios. In celebration of his 50<sup>th</sup> anniversary on 13 November 1978, Mickey became the first cartoon character ever to receive a star on the Hollywood Walk of Fame.

*"When people laugh at Mickey Mouse it's because he's so human, and that is the secret of his popularity"*

*- Walt Disney*





Disney  
100

## SNOW WHITE

Born a princess, yet treated poorly by her wicked stepmother, Snow White takes her trials in stride. She finds a new, loving home with the Seven Dwarfs in their humble yet cosy cottage. With her mild, joyful manners and caring nature, she wins the trust and devotion not only of the Dwarfs, but of all animals and creatures she encounters. *Snow White and the Seven Dwarfs* (1937) was Walt Disney's first full-length animated film. Critics believed nobody would pay to watch a full-length cartoon movie, yet Disney believed in the story and, over time, the movie has become the highest-grossing animated film.



*"I dream, I test my dreams against my beliefs, I dare to take risks and I execute my vision to make those dreams come true."*

- Walt Disney



Disney  
100

## TINKERBELL

Tinkerbell's delicate figure holds a strong, bubbly personality: She is feisty and sassy with friends and adversaries alike. She can mend everything from pots and pans to intricate, mechanical contraptions, and help others fly with a sprinkle of her pixie dust on her adventures in Neverland and beyond. From the popular side character in the *Peter Pan* movie (1953), Tinkerbell became the first mascot for the *Walt Disney's Disneyland* TV show (1954). She is still an unofficial mascot for Disney Parks around the world and on our screens, where her pixie dust fireworks whisk us into magic realms. Since 2005, she has been the central figure in the Disney Fairies franchise, and in 2010, she received her star on the Hollywood Walk of Fame.



*"Laughter is timeless,  
imagination has no age.  
And dreams are forever."*

*- Walt Disney*

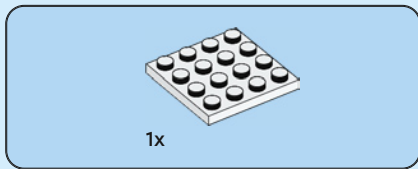

1

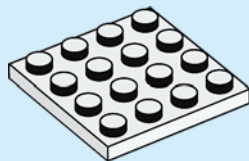



2x



1x

2

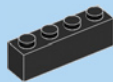
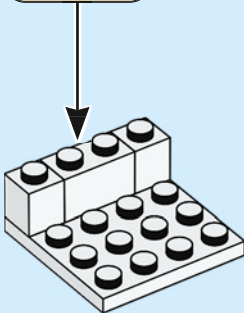
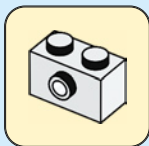

1x

3

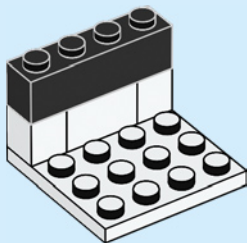



2x



1x



2x

4

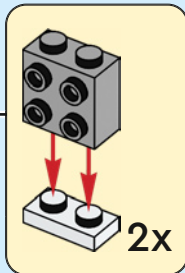
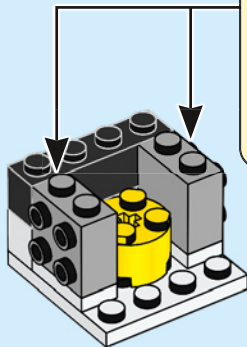

2x



1x



2x

5

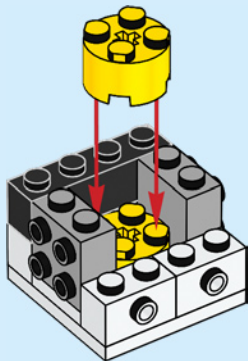



2x

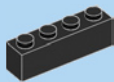

1x

6

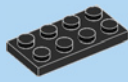
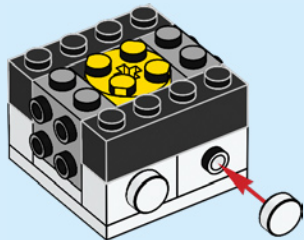

1x



2x

7

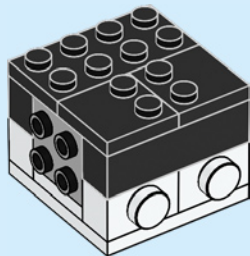



2x

8

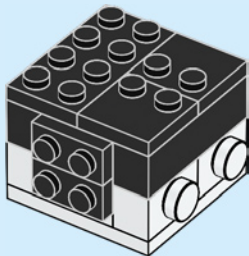

1x



1x

9

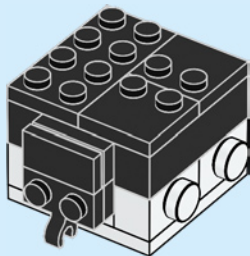



2x

10

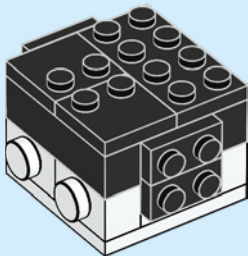

1x



1x

11

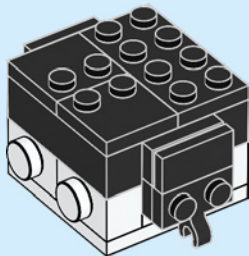





3x

12

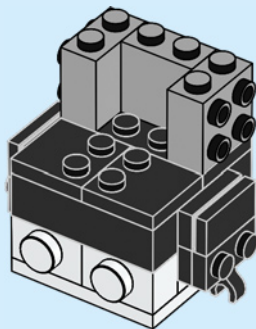



2x



1x

# 13

1

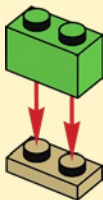

2

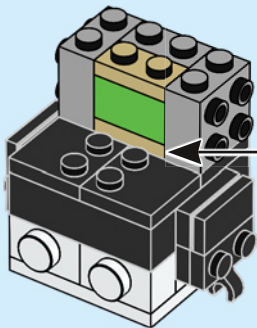
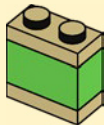



2x

14

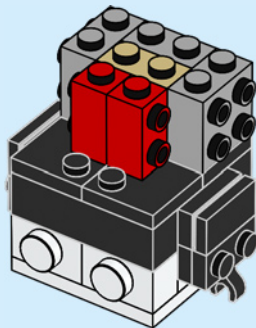

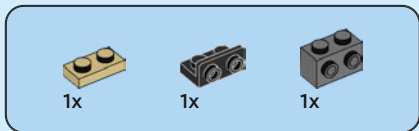

# 15

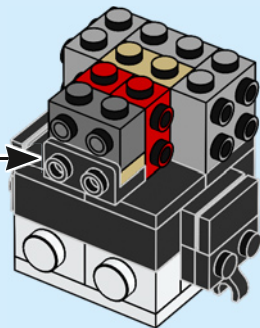
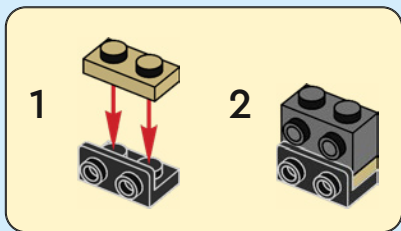



2x



2x

16

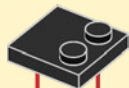
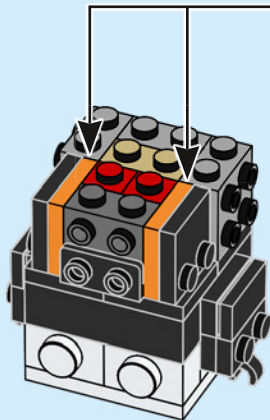

2x



2x

17

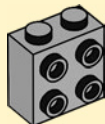

2x

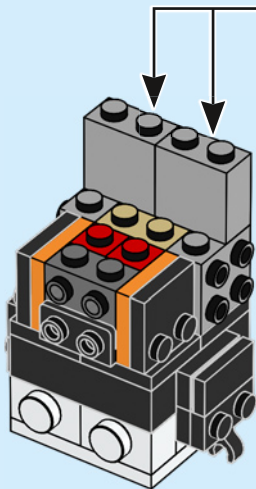



2x

18

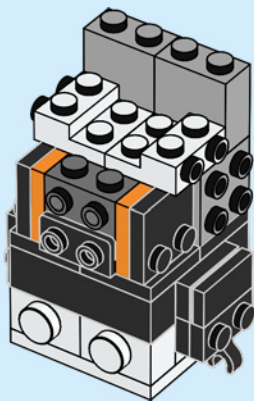



1x



2x

# 19

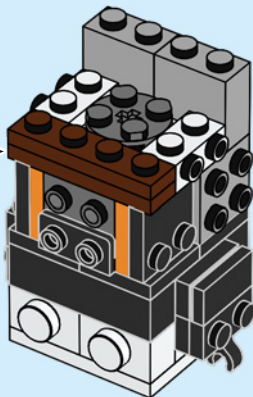
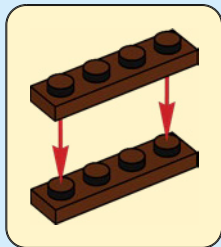





2x



1x

20

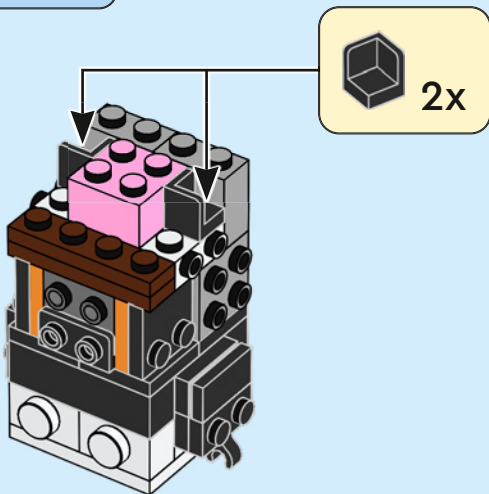



3x

21

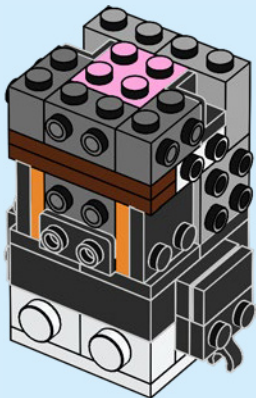



1x



1x



1x

# 22



1



2

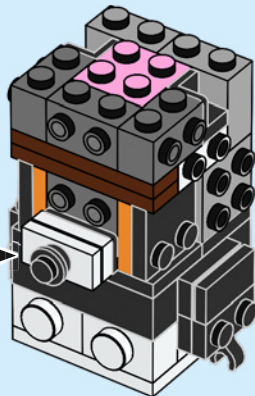

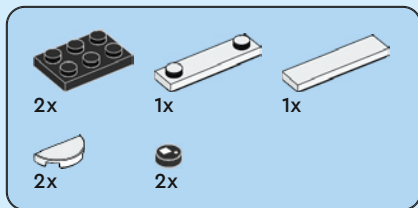

# 23

1

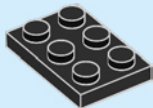

2

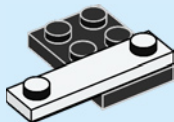

3

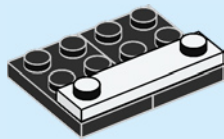

4

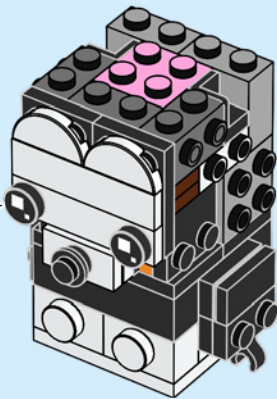
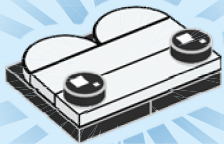

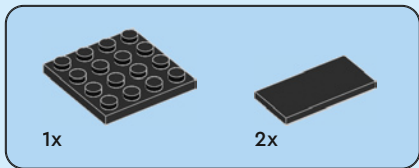

# 24

1

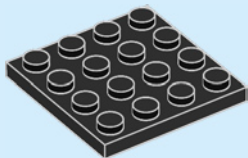

2

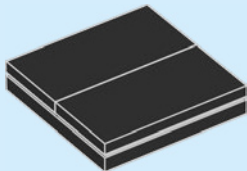

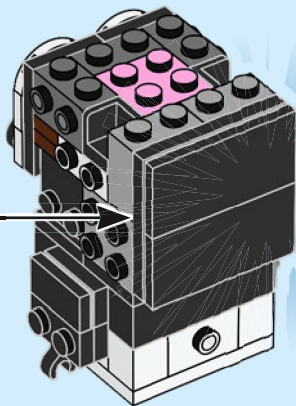



1x



1x

# 25

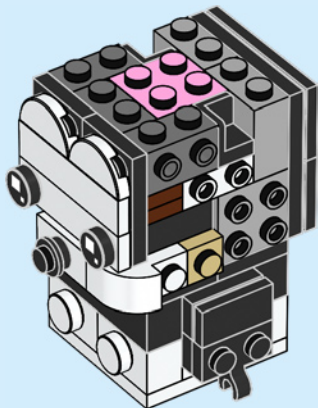



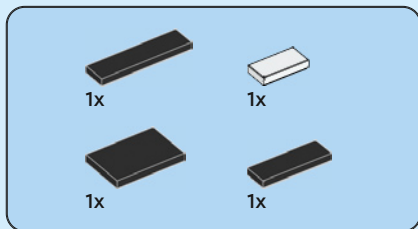

26

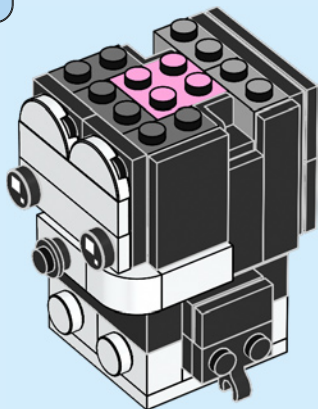



1x



1x

# 27

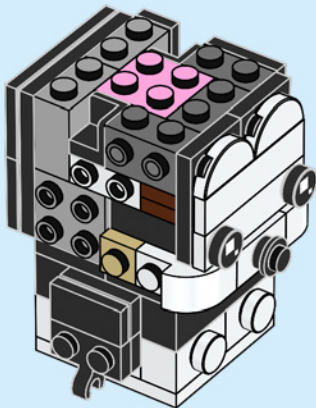

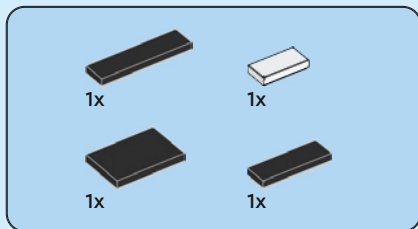

28

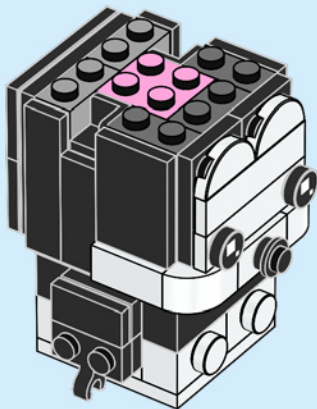



2x

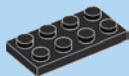

1x

29

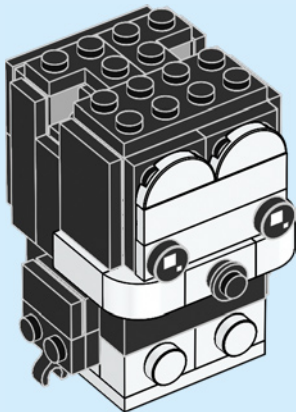



1x



2x



2x

30

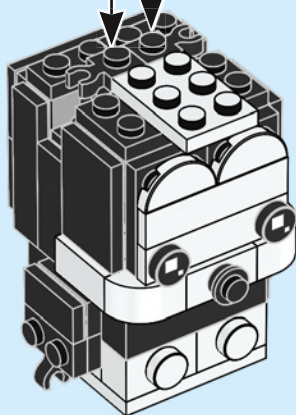

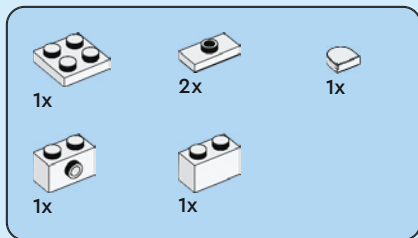

# 31

1



2

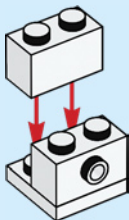

3

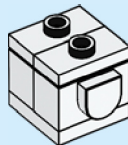

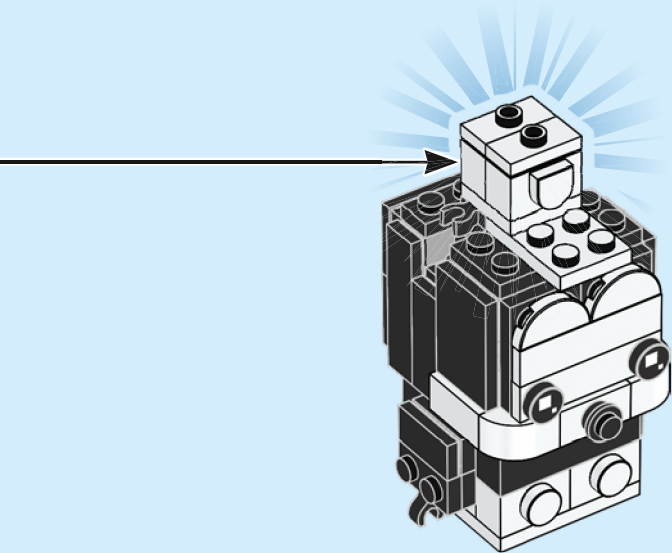

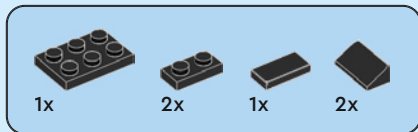

32

1

2

3

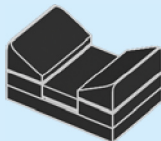
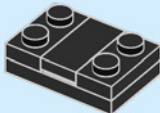



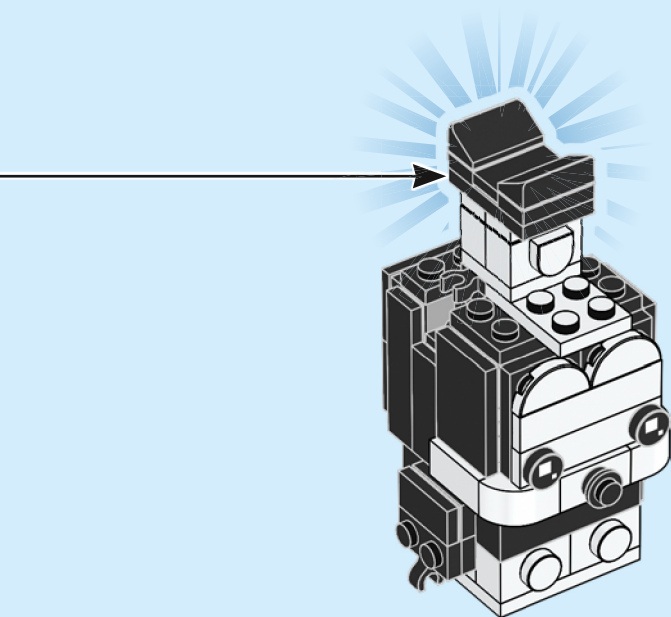



2x

33

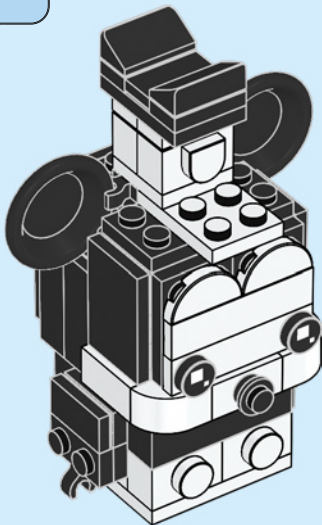

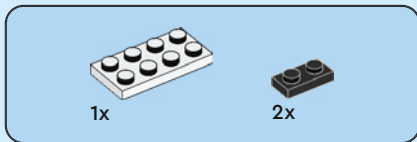

34

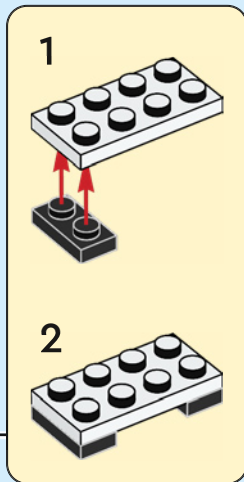
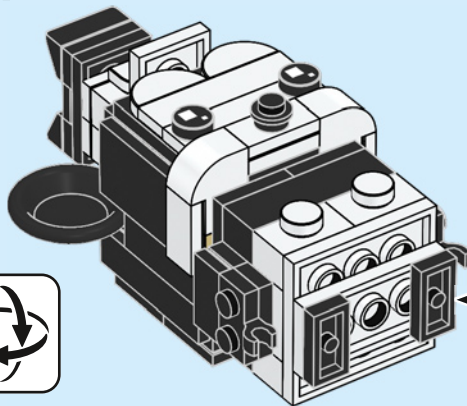



2x



2x



4x

# 35

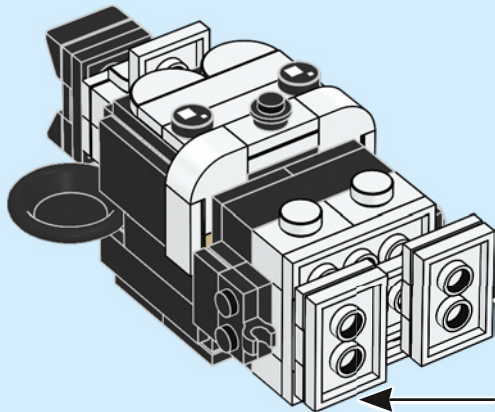

1

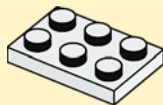

2

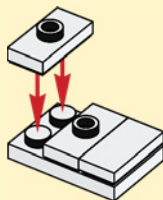

2x



1x

36

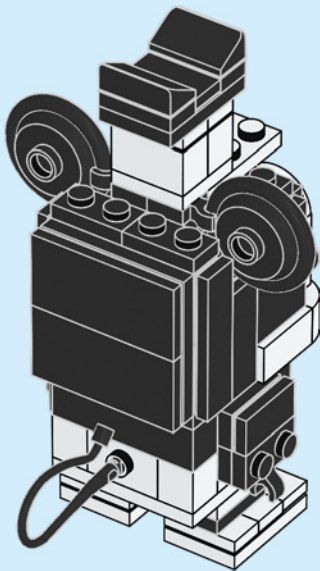

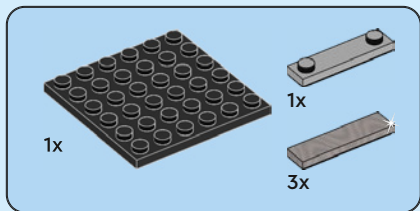

37

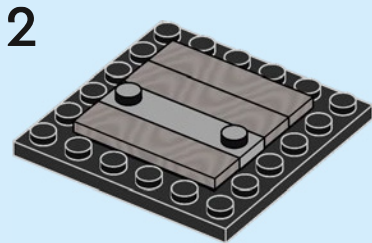
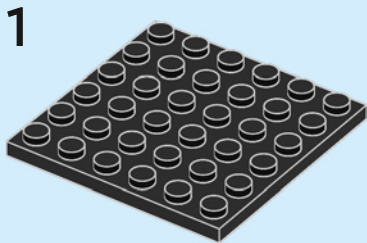

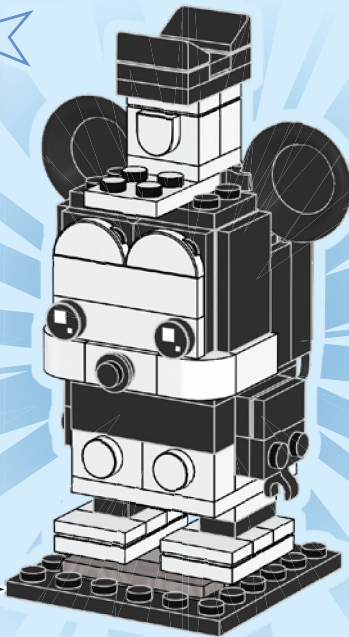

  
4x  
6284572

  
1x  
6250591

  
2x  
300501

  
2x  
302401

  
2x  
6172366

  
1x  
6132203

  
4x  
6400114

  
1x  
6132204

  
2x  
6174937

44

  
1x  
614301

  
4x  
6383982

  
7x  
6051511

  
5x  
302301

  
1x  
300401

  
4x  
306901

  
2x  
6285777

  
4x  
302201

  
1x  
6126046

  
2x  
6046979

  
3x  
302101

  
1x  
6249091

  
2x  
243101

  
1x  
302001

  
1x  
4243812

  
6x  
4159553

  
2x  
4624086

  
11x  
4113917

  
4x  
4114026

  
4x  
6313119

  
2x  
6173057

  
5x  
4114084

  
4x  
4118790

  
4x  
4550324

  
2x  
6257600

  
1x  
4243824

  
2x  
6187620

  
4x  
4504379

  
4x  
403221

  
1x  
302321

  
2x  
300321

  
1x  
371021

  
4x  
300523

  
1x  
6430680

  
2x  
301023

  
1x  
302023

  
2x  
614324





6x  
6248833



8x  
6284077



2x  
614126



1x  
4290713



2x  
4106347



6x  
302426



6x  
307026



6x  
4504382



2x  
6181720



4x  
6172383



4x  
6228987



2x  
6330189



2x  
6181713



2x  
4548180



8x  
306926



2x  
242026



16x  
302326



4x  
6313116



8x  
6047276



2x  
6347310



4x  
6184784



3x  
6020193



2x  
4107761



4x  
6192346



5x  
6053077



5x  
302226



2x  
4515368



2x  
6433560



2x  
4558170



2x  
362326



2x  
6162892



8x  
302126



2x  
6147790



2x  
243126



4x  
301026



1x  
6019726



3x  
371026



2x  
6037746



2x  
302026



8x  
4560182



2x  
6350415



1x  
4647553



2x  
6252043



2x  
4159007



2x  
4621557



1x  
4500125



2x  
4220634



2x  
6365620



2x  
6258408



2x  
6247210



1x  
6314224



4x  
6310279



2x  
4537937



4x  
6433213



3x  
4187743



1x  
4164021



2x  
4537936



2x  
6375006



1x  
6385485



2x  
6295078



2x  
4211190



46x  
6123809



2x  
6126082



2x  
6118827



3x  
6257593



2x  
4211636



1x  
4211042



4x  
6230233



2x  
6336860



1x  
4654128



3x  
4550359



2x  
6096589



6x  
6058014



4x  
6228969



2x  
6296498



6x  
6275877



4x  
6296494



2x  
6201647



2x  
6022083



2x  
6296519



1x  
6316265



12x  
6296487



1x  
6424475



2x  
6296492



4x  
6344840



4x  
6248756



2x  
6147726



5x  
6296524



2x  
4622176



1x  
6296849



1x  
6167643



2x  
6345712



2x  
6225538



4x  
4653988



2x  
6430724



1x  
6151671



1x  
6213272



3x  
6210675



2x  
6099349



11x  
6409129



2x  
6258091



4x  
6339228

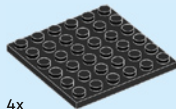

4x  
395826



1x  
6359865

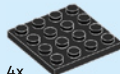

4x  
4243819



[LEGO.com/service](https://www.lego.com/service)

YOU COULD

WIN



Scan this QR code or go to  
**LEGO.COM/PRODUCTFEEDBACK** and give us  
your short feedback about this LEGO® set  
for a chance to win a cool LEGO prize.

Terms and Conditions apply\*

**DE: Du könntest GEWINNEN.** Es gelten die Teilnahmebedingungen\* **FR: Tu pourrais GAGNER.** Des conditions s'appliquent\* **IT: Potresti VINCERE tu.** Termini e condizioni sono applicabili\* **ES: Puedes GANAR.** Aplican términos y condiciones\* **PT: Poderá GANHAR.** Aplicam-se termos e condições\* **JA: プレゼント付き! 利用規約が適用されます\*** **ZH: 轻松获奖. 条款和条件适用\*** **KO: 상품의 주인이 되어보세요. 소정의 약관이 적용됩니다\*** **RU: Вы можете ВЫИГРАТЬ.** Действуют положения и условия\* **PL: Szansa na WYGRANĄ.** Obowiązują warunki korzystania\* **CS: Máte šanci VYHRÁT.** Platí všeobecné smluvní podmínky\* **SK: Máte šancu VYHRATĚ.** Platia všeobecné zmluvné podmienky\* **HU: TE IS NYERHETSZ.** Felhasználási feltételek érvényesek\* **RO: Ai putea CĂȘTIGA.** Se aplică termenii și condiții\* **BG: Можете да СПЕЧЕЛИТЕ.** Има определени правила и условия\* **LV: Tu vari LAIMĒT.** Ir spēkā noteikumi un nosacījumi.\* **ET: Sul on võimalus VÕITA.** Kehtivad tingimused\* **LT: Jūs galite LAIMĖTI.** Taikomos sąlygos\*

\*[LEGO.com/productfeedback-terms](https://www.lego.com/productfeedback-terms)

LEGO and the LEGO logo are trademarks of the LEGO Group. ©2023 The LEGO Group.  
©Disney

6467951



**BRICK  
HEADZ**

40622



[LEGO.com/brickheadz](https://www.LEGO.com/brickheadz)





1x

1

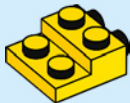

1x

2





1x

3

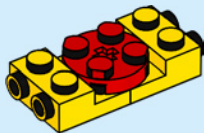

4

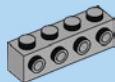

2x

4

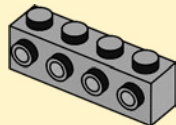

2x

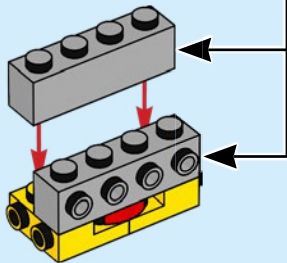





2x



4x

5

1



2



3



2x

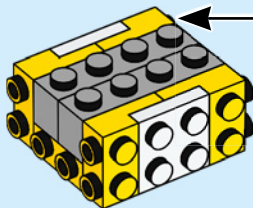



4x



8x

6

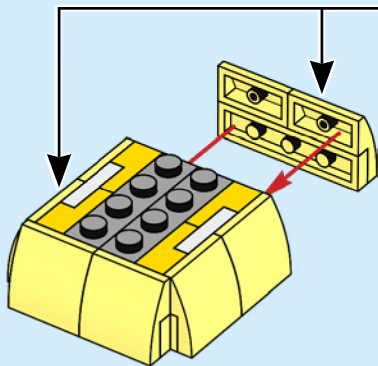

1

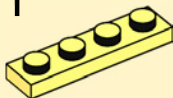

2

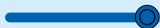
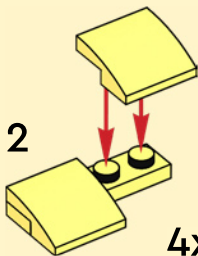

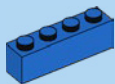

2x

7

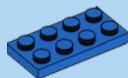
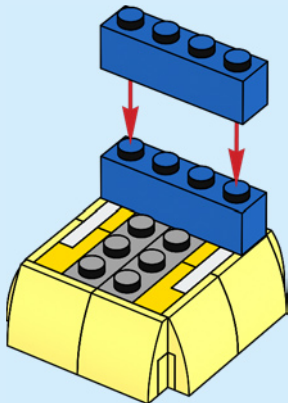

1x

8

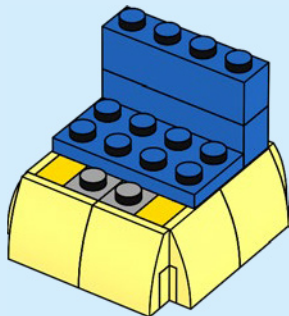



2x



1x

9

1

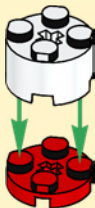

2

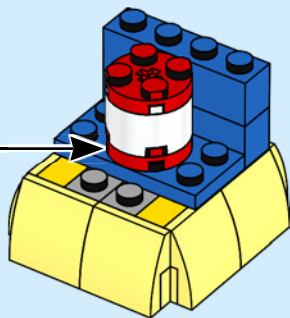



2x

10

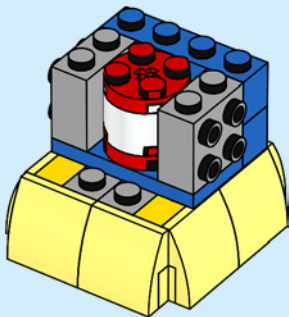

1x

11

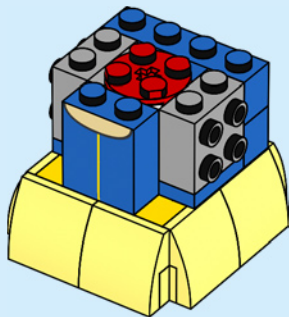



1x



1x

# 12

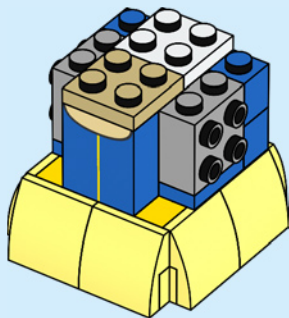

1x



1x

# 13

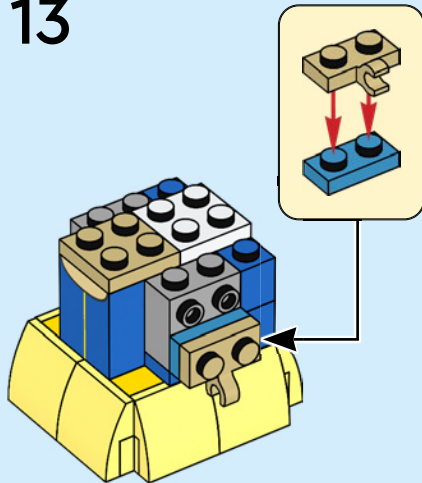



1x

14

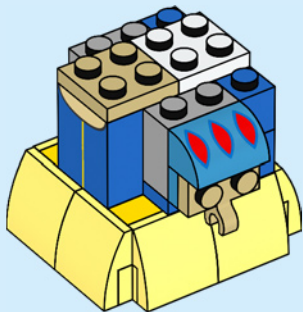

1x



1x

15

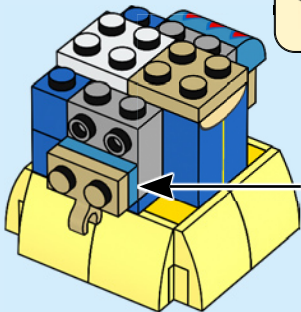
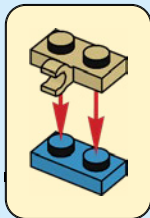



1x

16

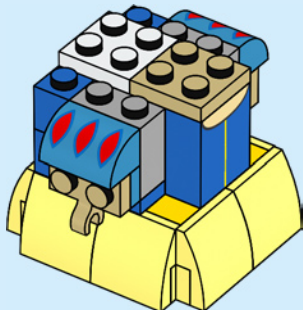

1x



1x

17

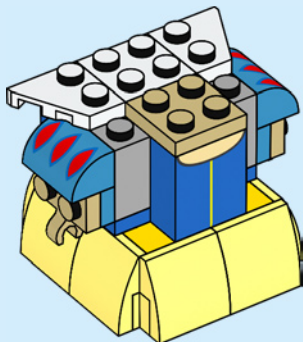





4x



2x

# 18

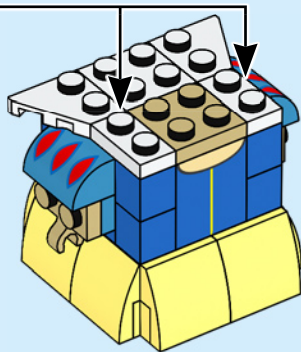
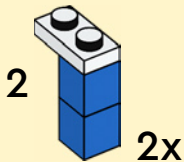
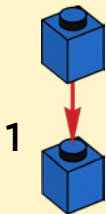



3x

19

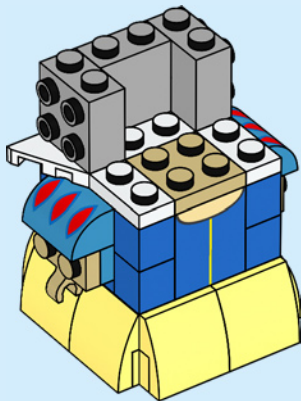

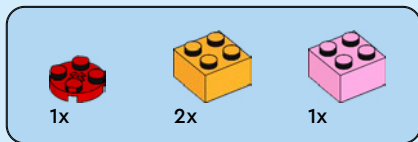

20

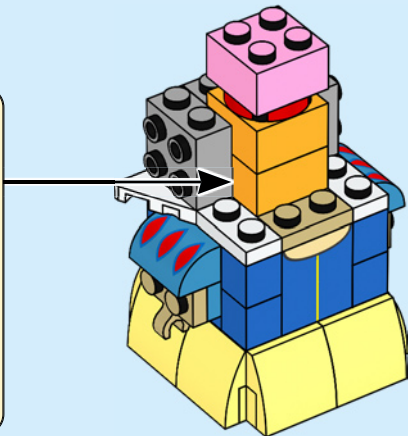
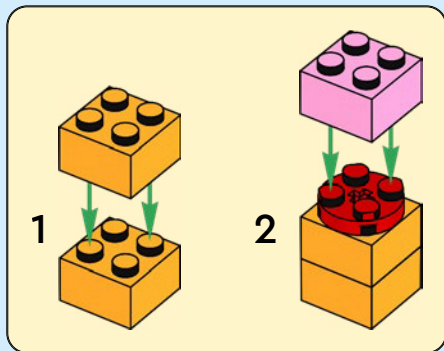



3x

# 21

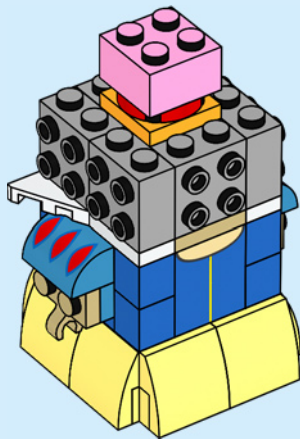



6x

22

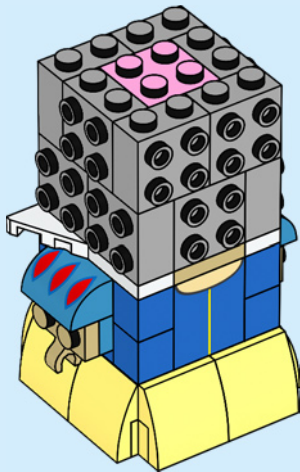



1x



2x



2x



2x

# 23

## 1

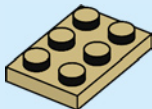

## 2

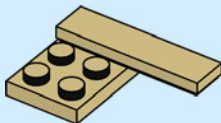

3

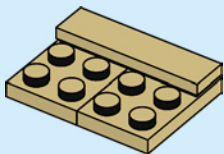

4

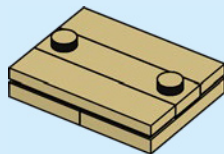

5

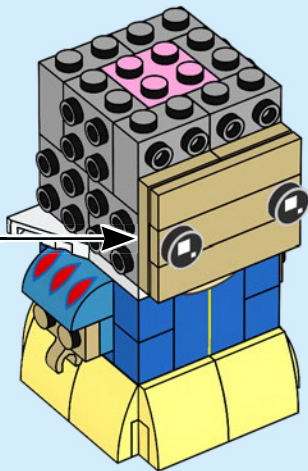
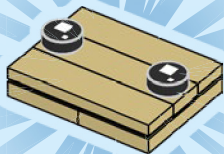





2x



1x



2x



2x



2x

# 24

## 1

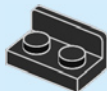

## 2



## 3

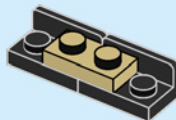

4

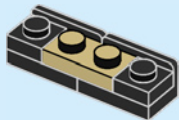

5

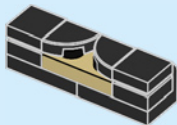

6

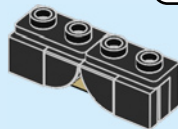

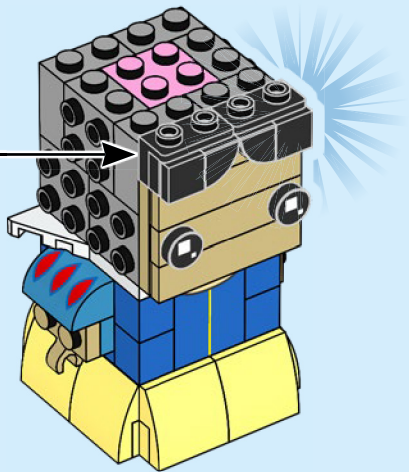



1x



1x

# 25

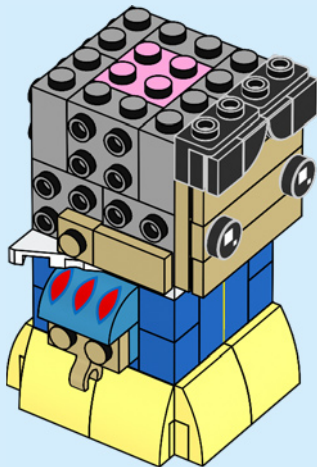



1x



1x



1x

# 26

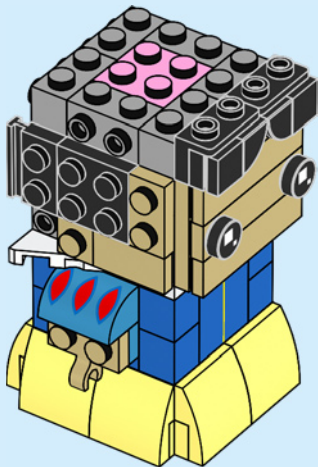



1x

27

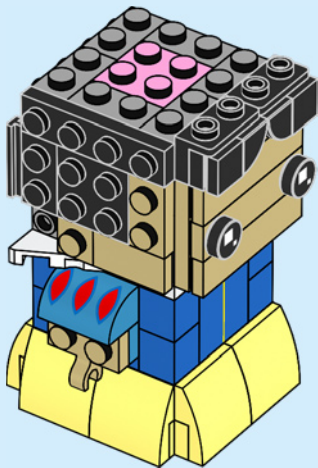

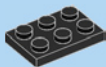

1x



1x

# 28

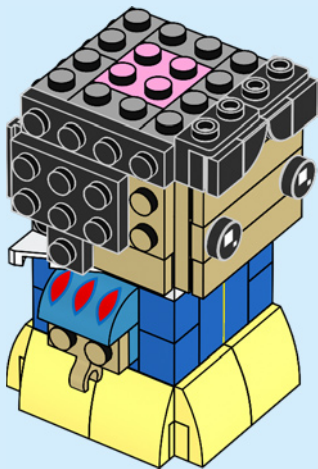



1x

29

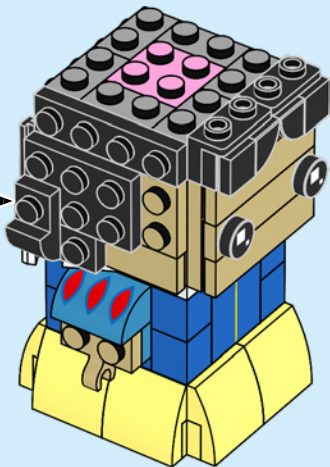





1x



1x

30

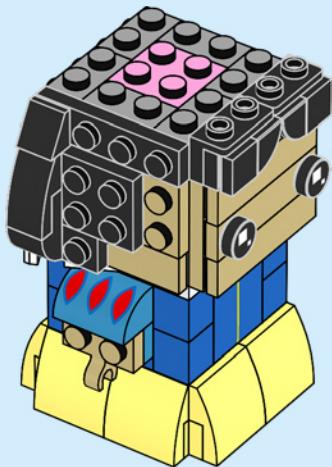



1x



2x

31

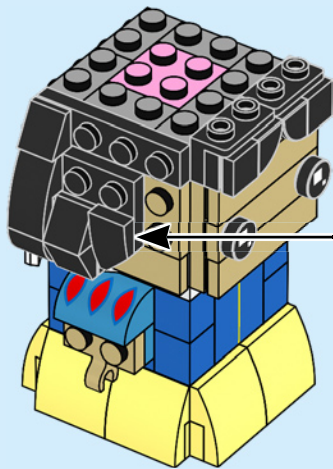



1x

32

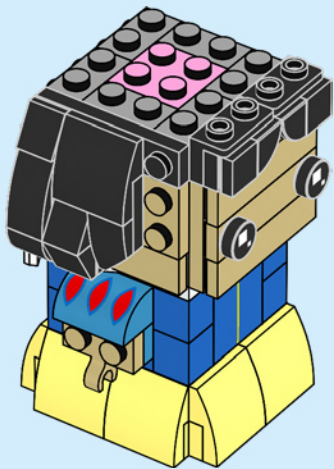



1x



1x



1x

# 33

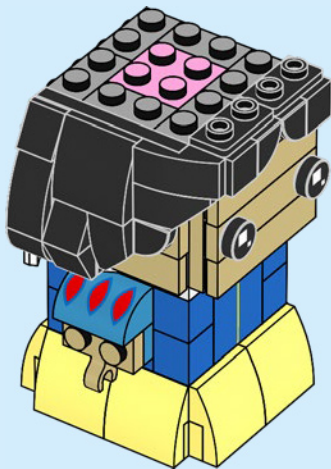

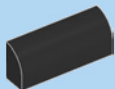

1x

34

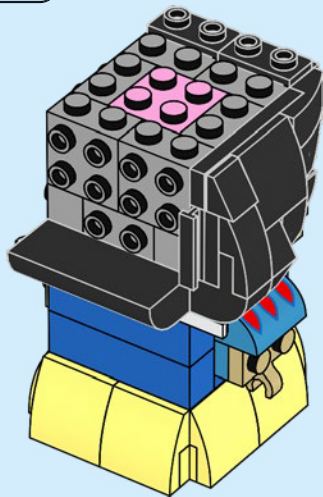
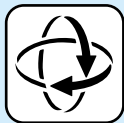

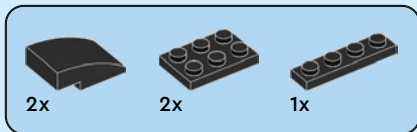

# 35

1

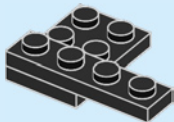

2

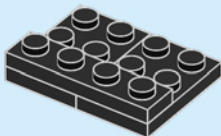

3

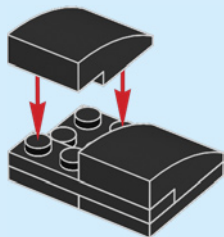

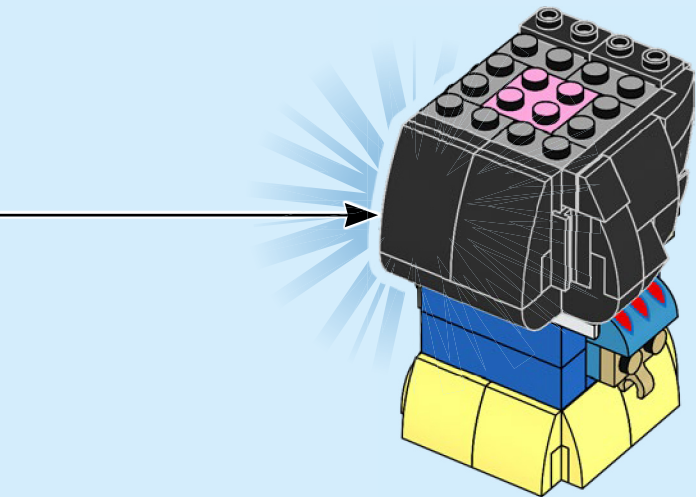



1x



1x

# 36

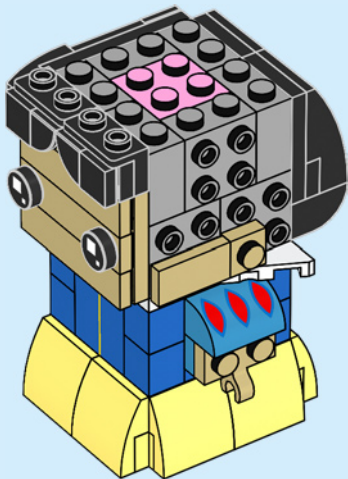





1x



1x



1x

# 37

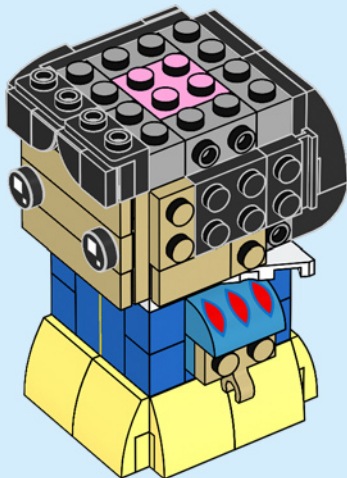



1x

38

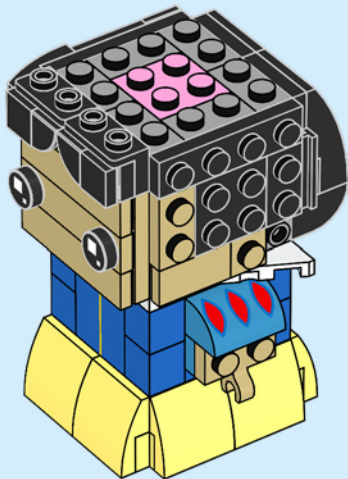

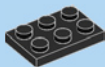

1x



1x

# 39

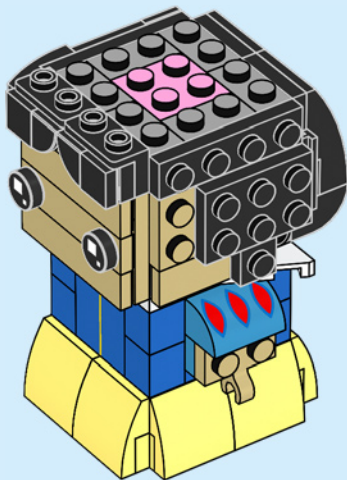



1x

40

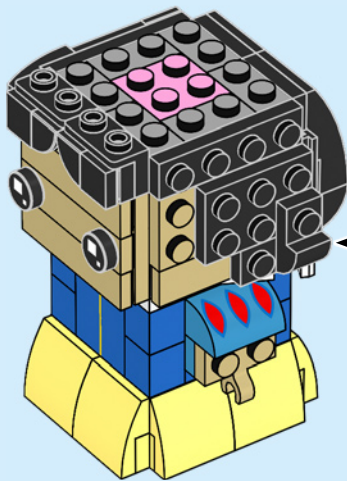



1x



1x

41

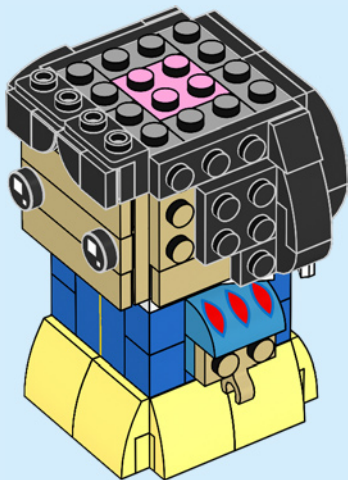



1x



2x

# 42

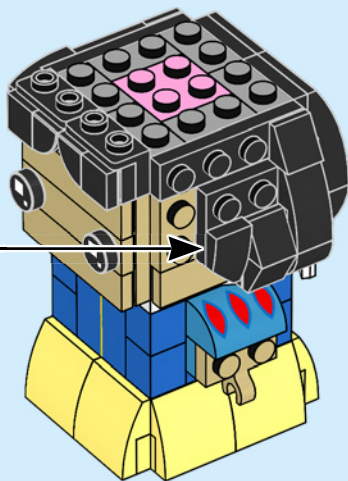



1x

43

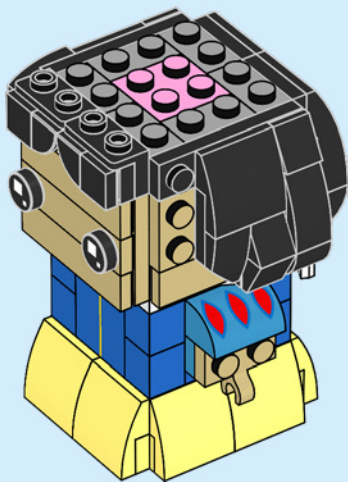



1x



1x



1x

44

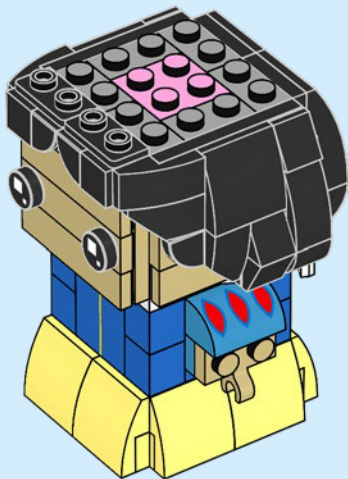



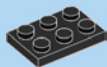

1x

45

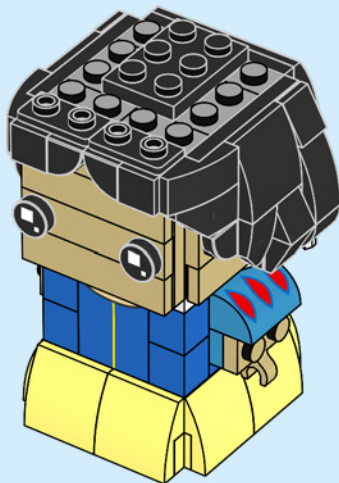



2x



2x

# 46

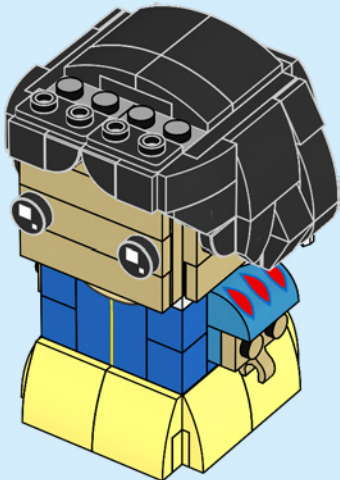



4x



1x



1x

# 47

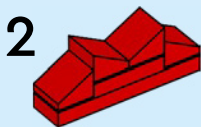
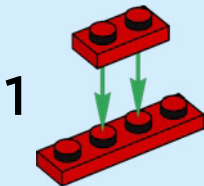

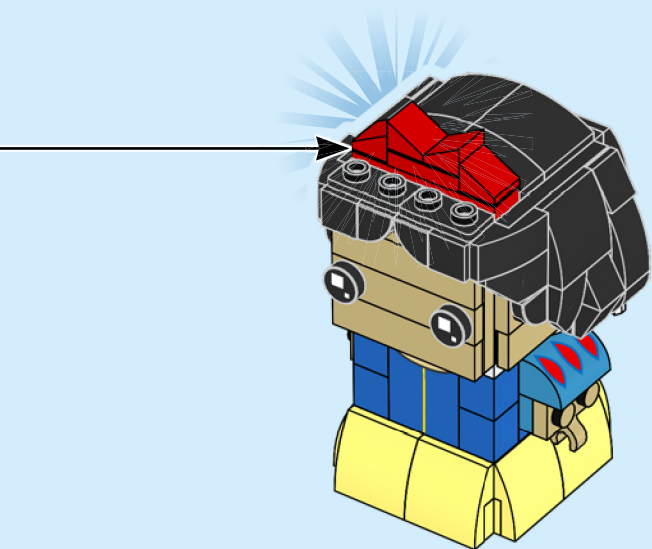



2x



2x



2x

48

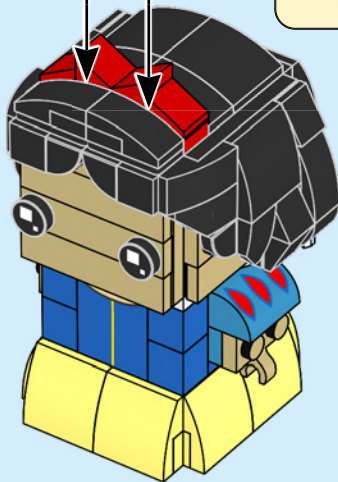

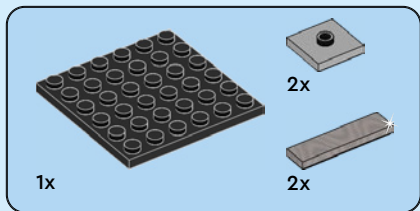

49

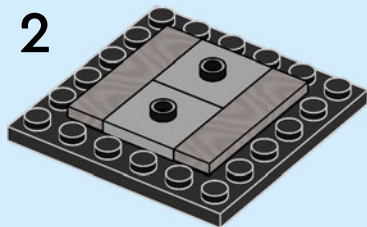
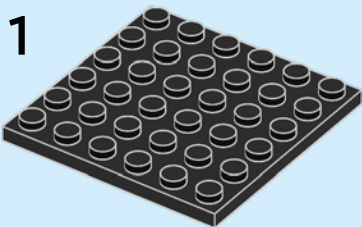

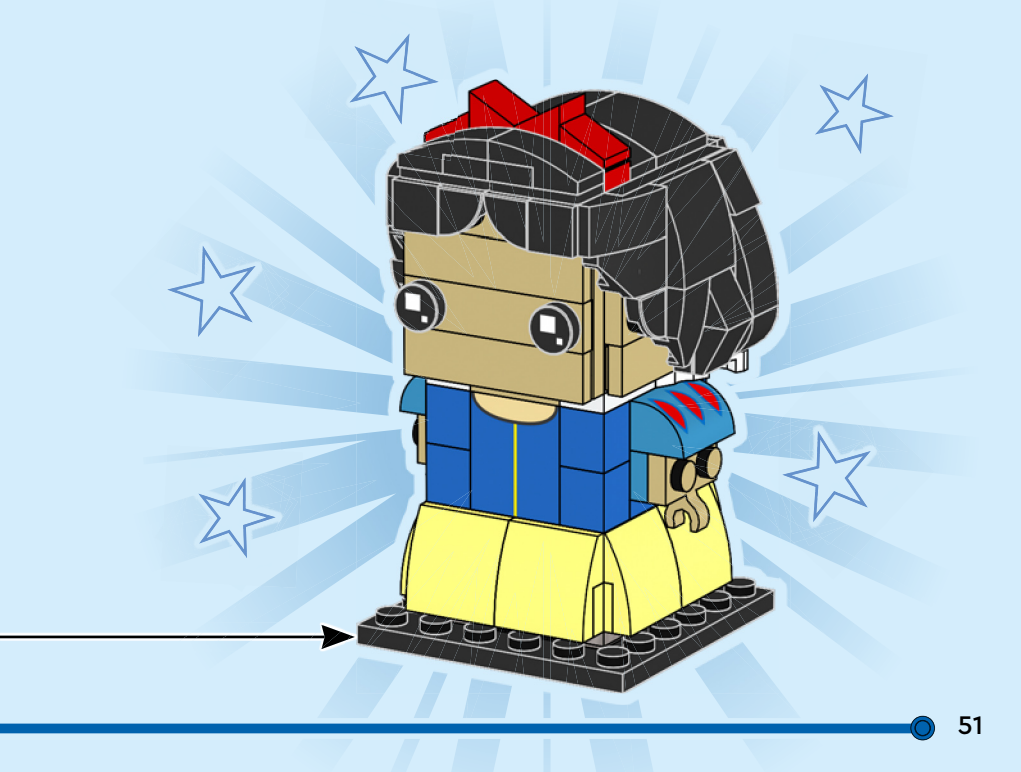







 **BRICK  
HEADZ**

40622



[LEGO.com/brickheadz](https://www.LEGO.com/brickheadz)



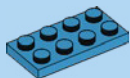

1x

1

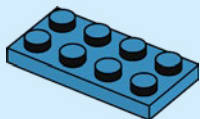

2x



2x

2

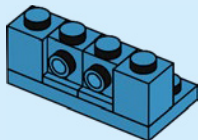

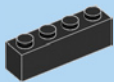

1x

3

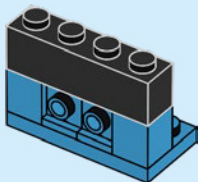

1x

4

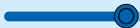
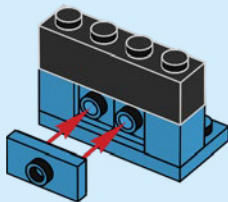



2x

5

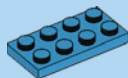
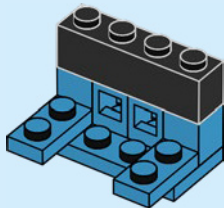

1x

6

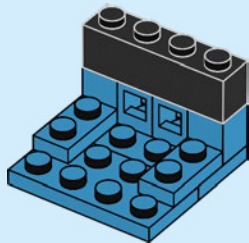



2x

7

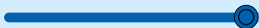
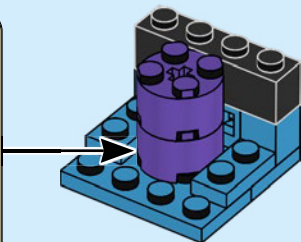
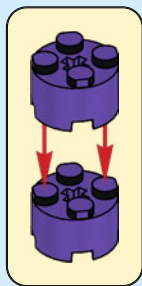



2x

8

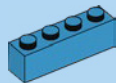
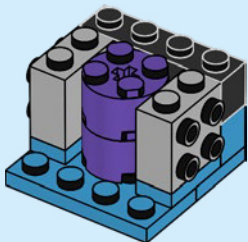

1x

9

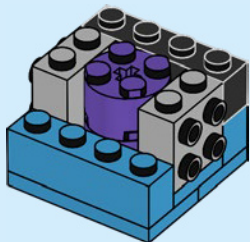

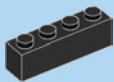

1x

10

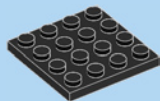
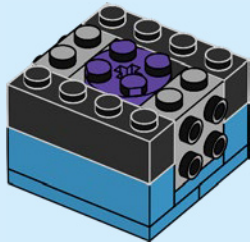

1x

11

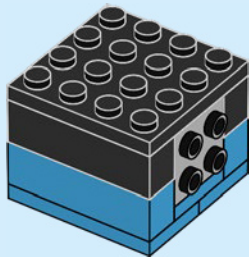





2x



2x



2x

# 12

1

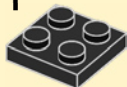

2

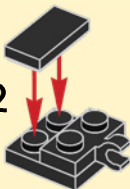

2x

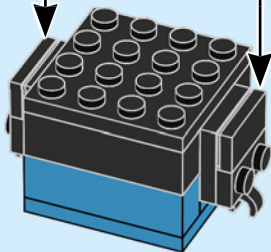



3x

13

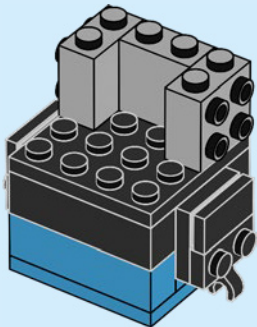



2x



1x

# 14

1

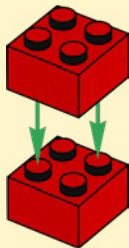

2

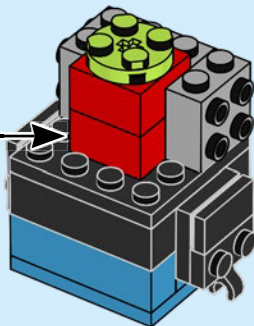



3x

15

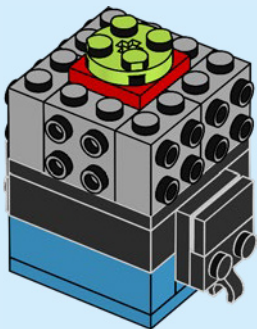

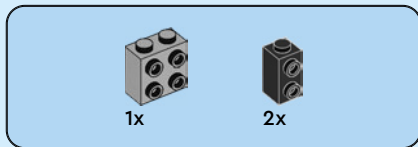

16

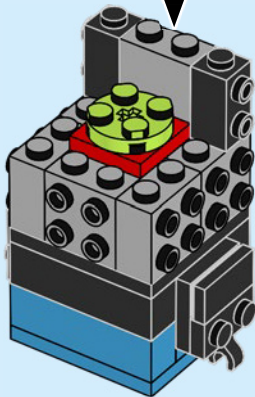
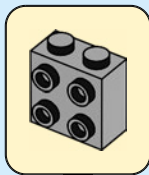



2x



2x

17

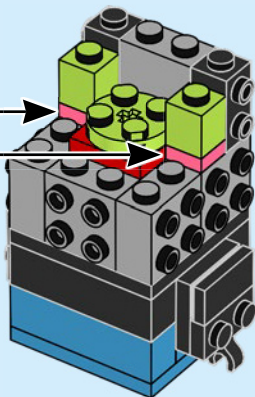
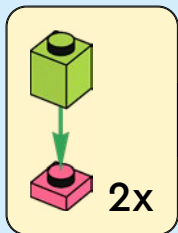



2x

18

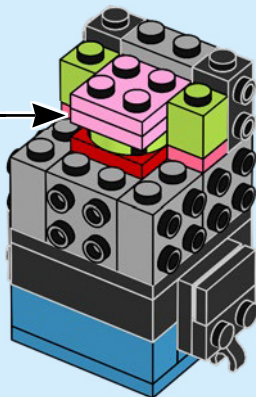
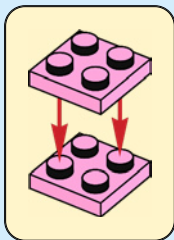



1x



2x

# 19

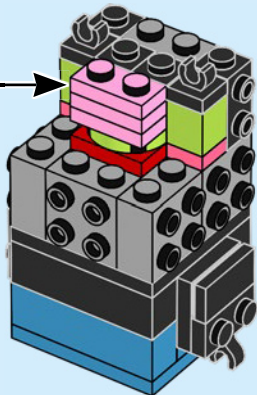





2x

20

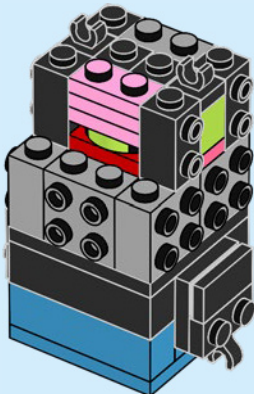

2x

21

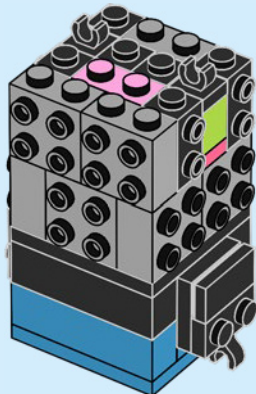

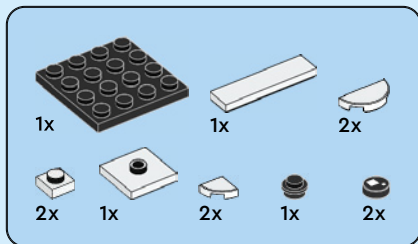

# 22

## 1

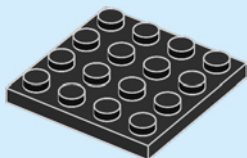

## 2

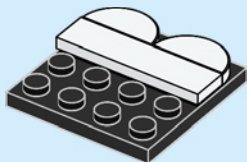

## 3

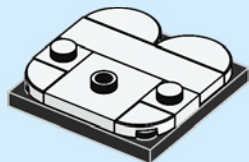

4

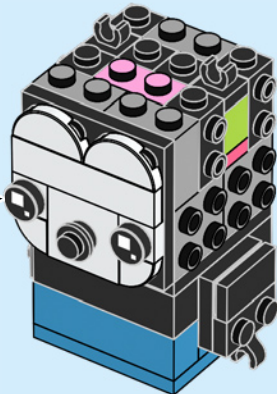
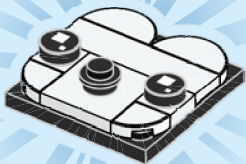

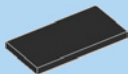

2x

23

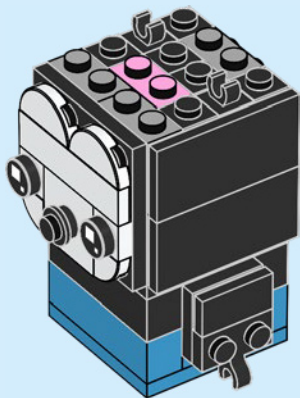

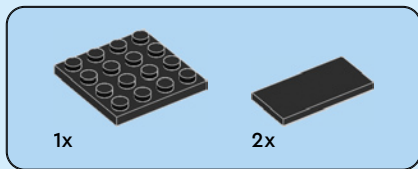

# 24

1

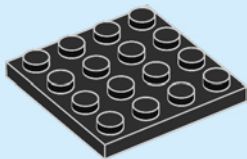

2

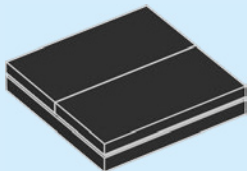

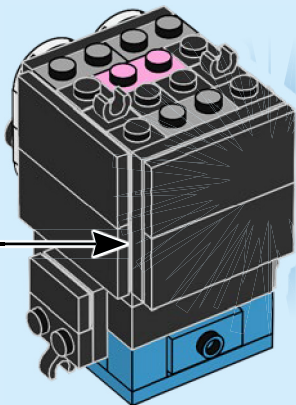

22

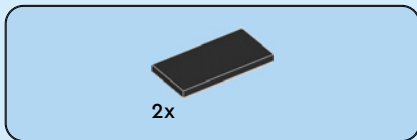

25

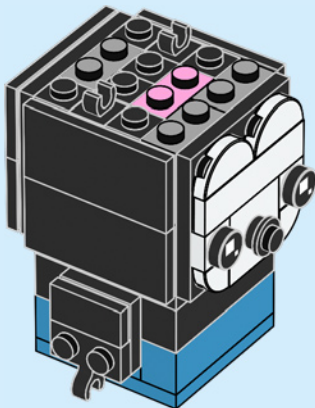



1x



2x

# 26

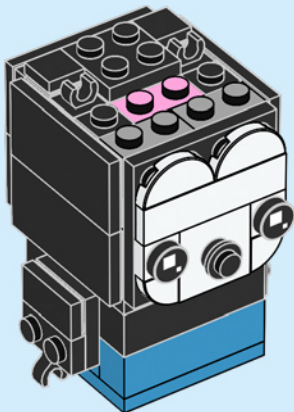

1x



3x

# 27

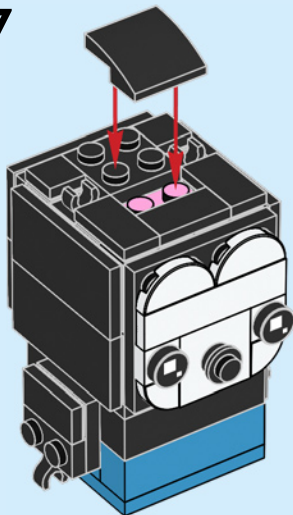



2x



2x



2x

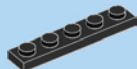

2x



4x



2x

28

1

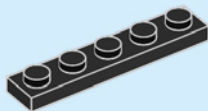

2

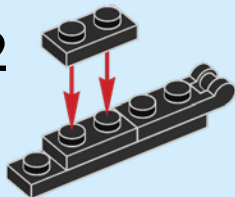



3

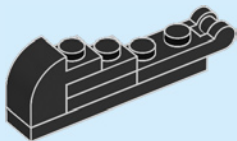

4

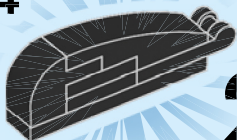

2x

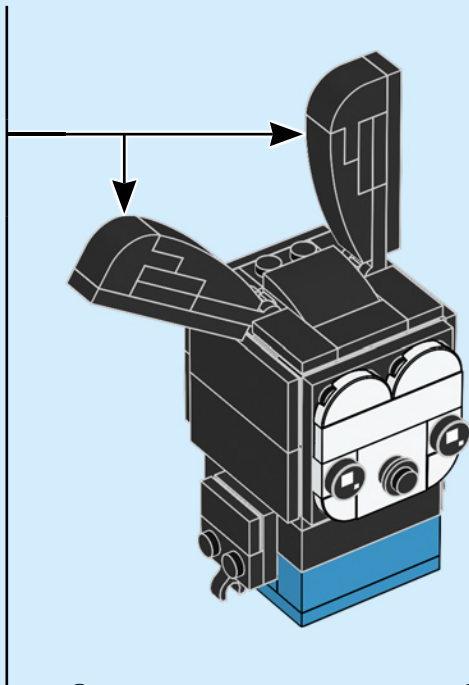



1x

# 29

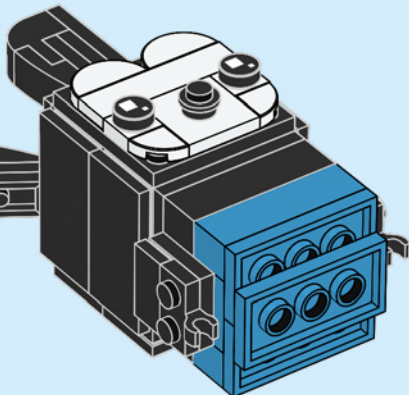



2x



4x



2x



2x

30

1

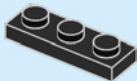

2

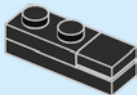

3



2x

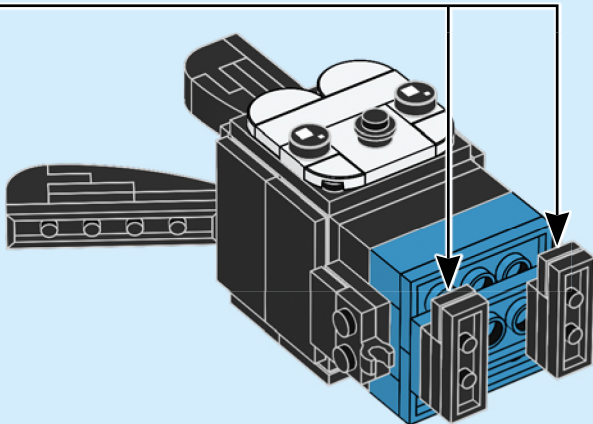



1x

31

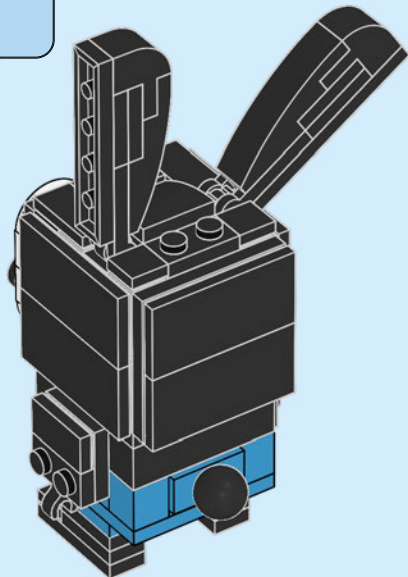
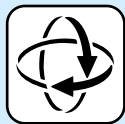

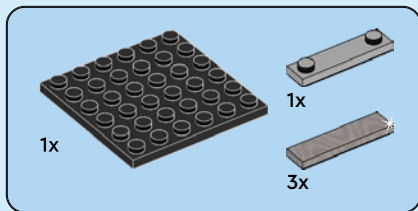

# 32

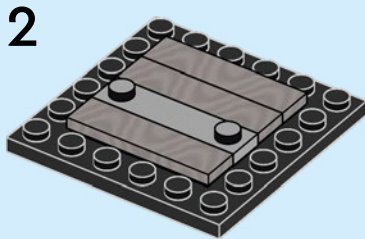
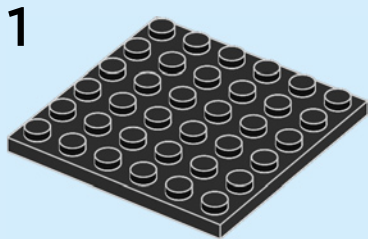

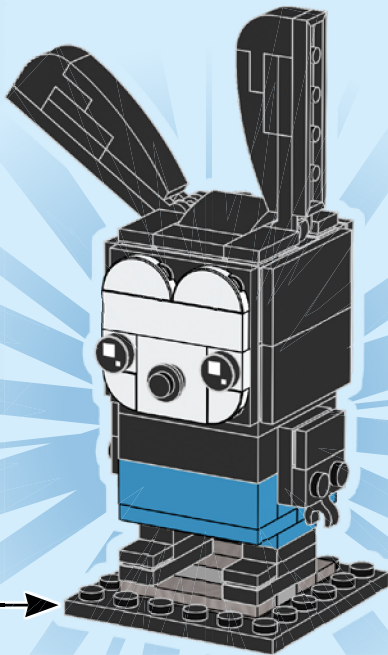







**BRICK  
HEADZ**

40622



[LEGO.com/brickheadz](https://www.LEGO.com/brickheadz)

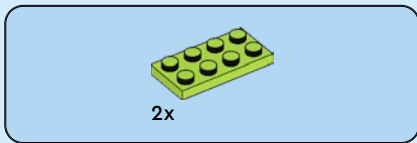

1

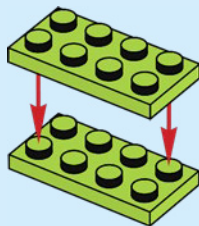



4x

2

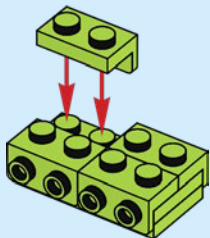

1x



1x

3

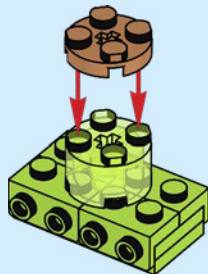



2x

4

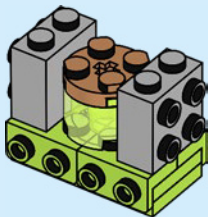

4

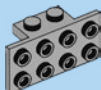

2x

5

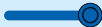
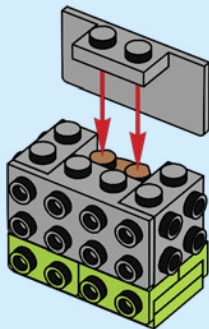

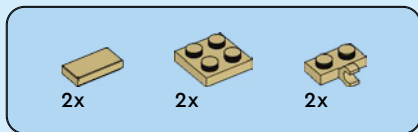

6

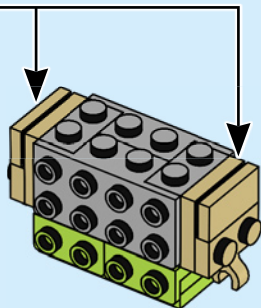
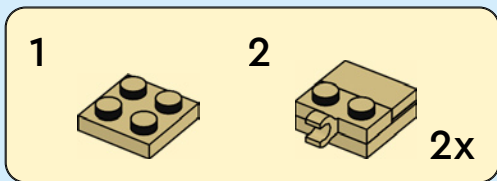



2x



2x



4x



2x



2x

7

1



2



3



4

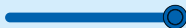
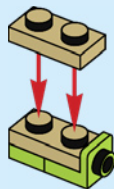

5

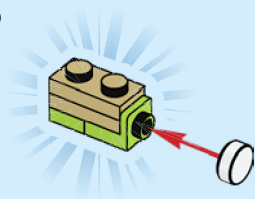

2x

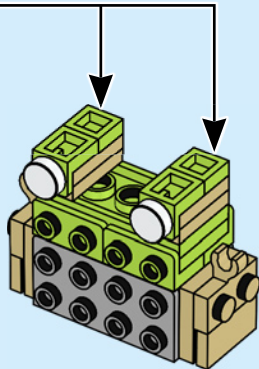
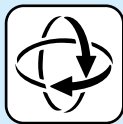



1x



1x



1x

8

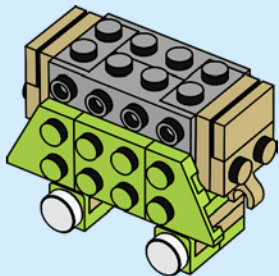

9



2x

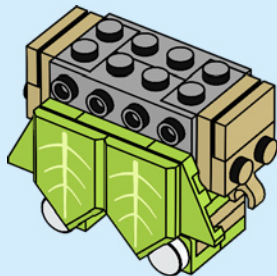



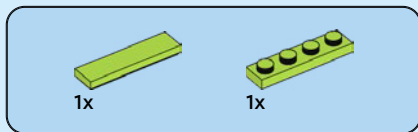

10

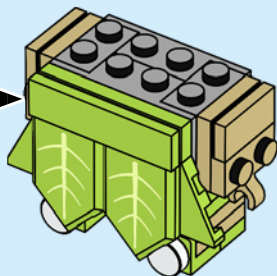
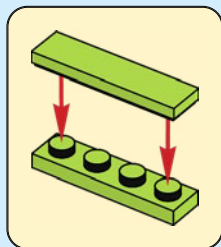



1x



1x



1x

11

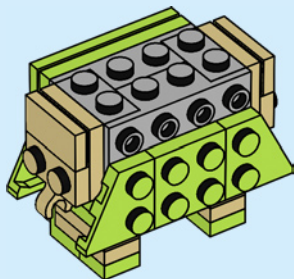

2x

12

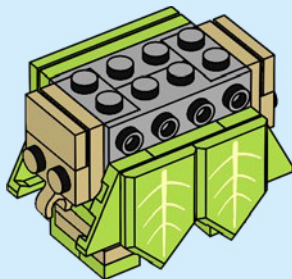



2x

13

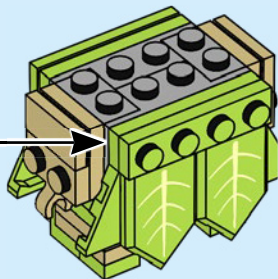
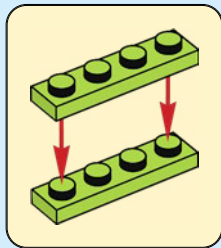

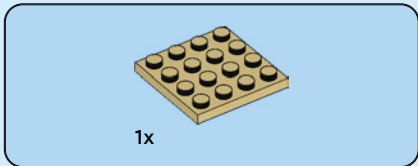
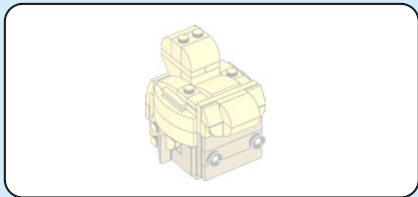

14

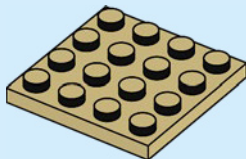



3x

15

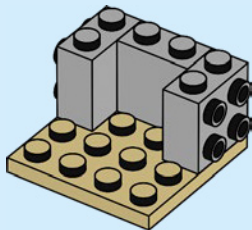



1x



2x



1x

# 16

1

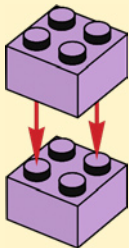

2

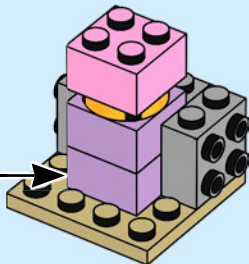
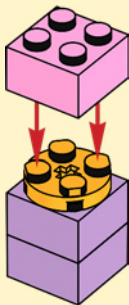



3x

17

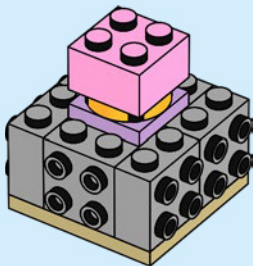

6x

18

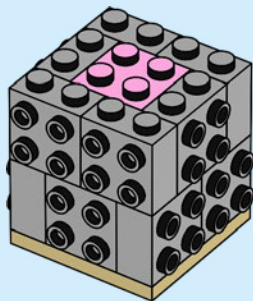



2x



2x

19



2x

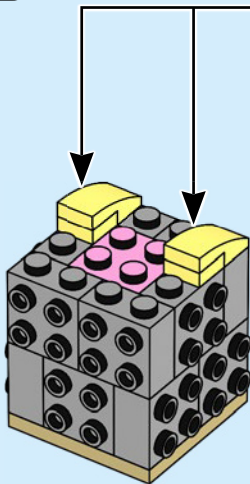



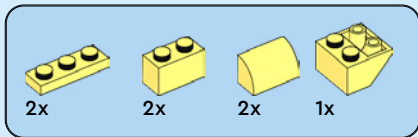
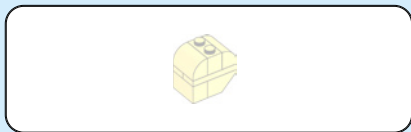

20

1

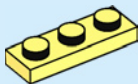

2

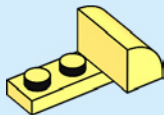

3

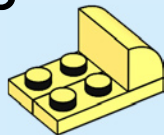

4

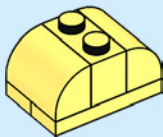

5

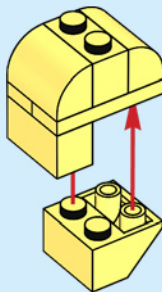

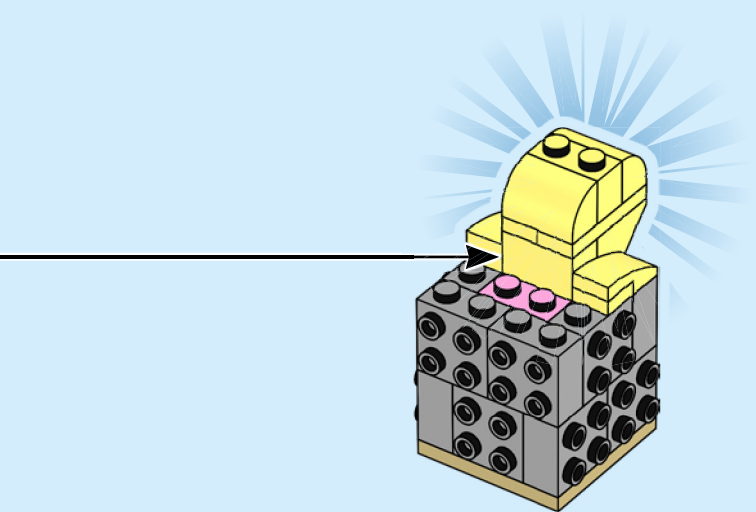

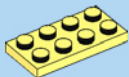

1x

21

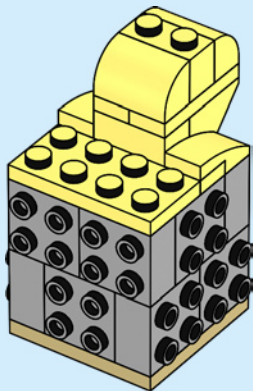

2x



2x

22

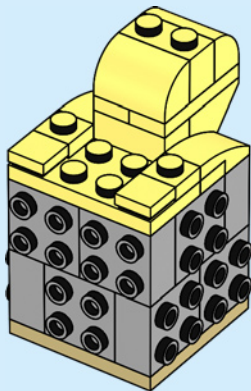



1x



1x

# 23

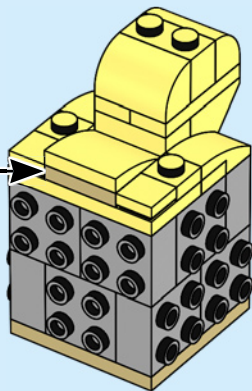
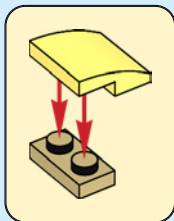

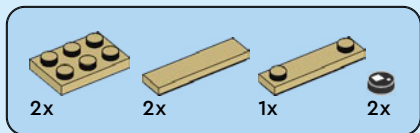

# 24

1

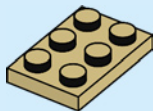

2

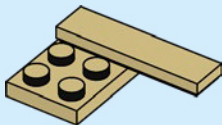

3

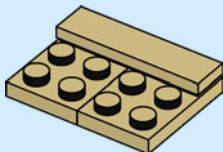

4

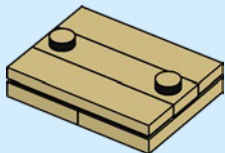

5

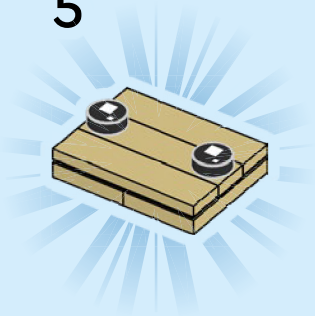

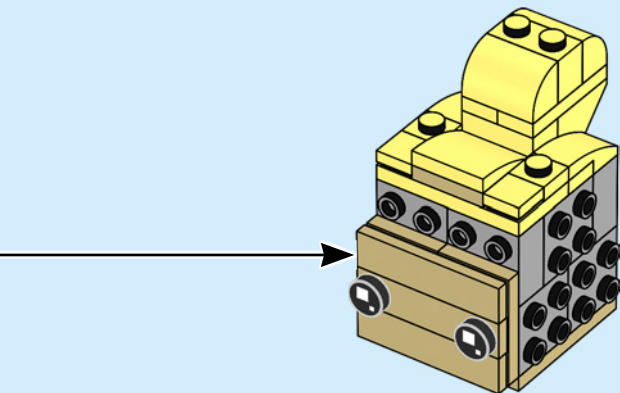



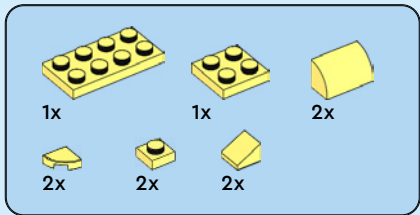

25

1

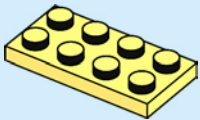

2

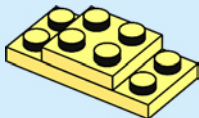

3

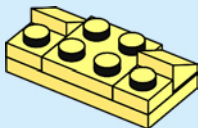

4

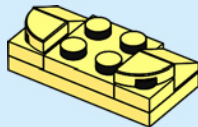

5

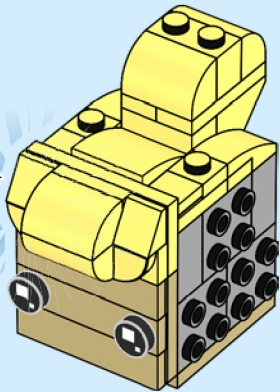
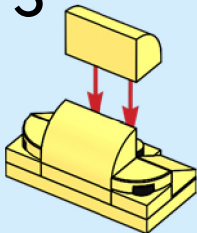



1x



1x



1x

# 26

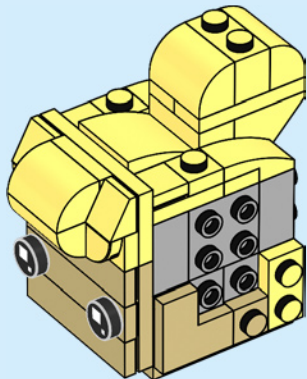

1x



1x

# 27

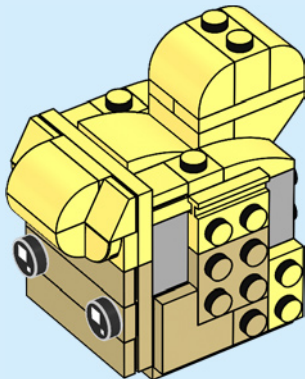



1x



1x

# 28

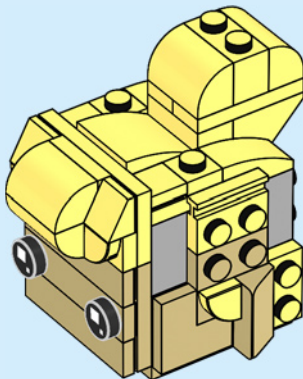

2x

# 29

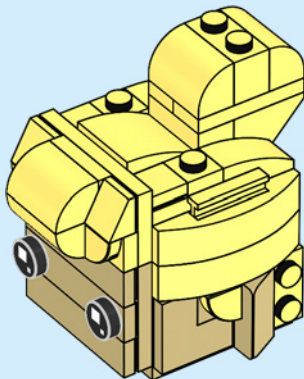

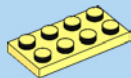

3x



3x



4x

# 30

## 1

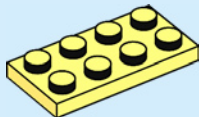

## 2

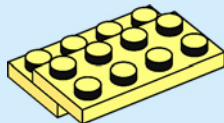

## 3

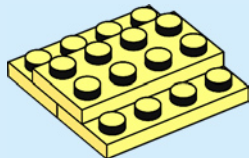

4

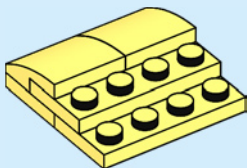

5

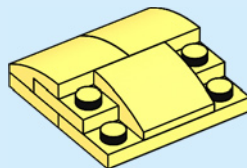

6

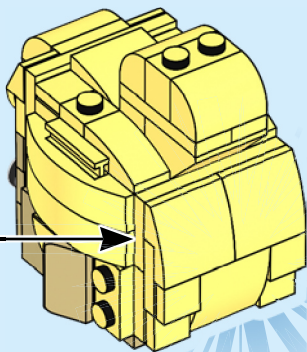
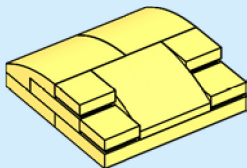





1x



1x



1x

# 31

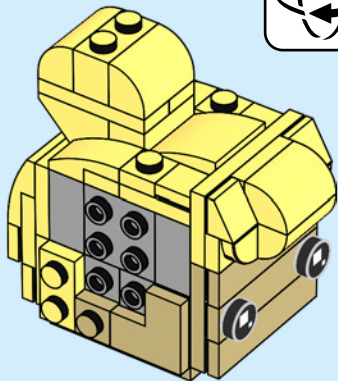
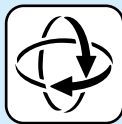

1x



1x

# 32

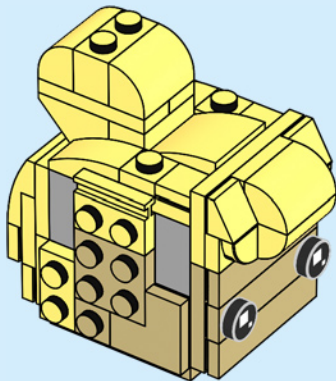



1x



1x

# 33

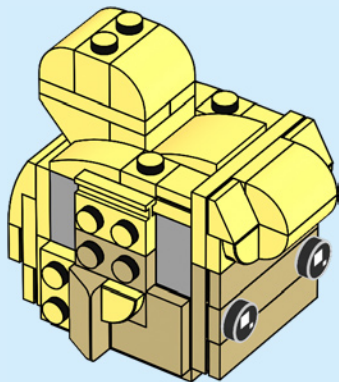

2x

# 34

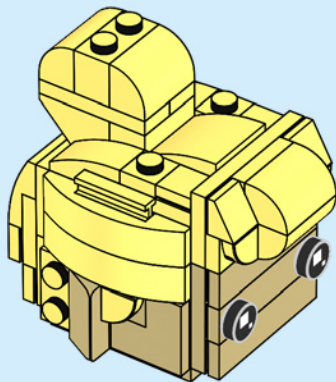

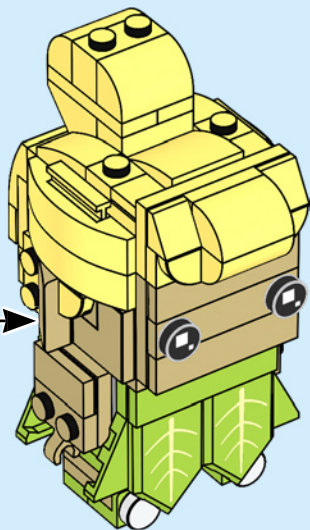



1x



2x

# 35

1

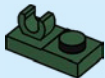

2

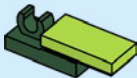

3

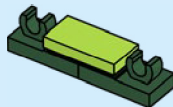

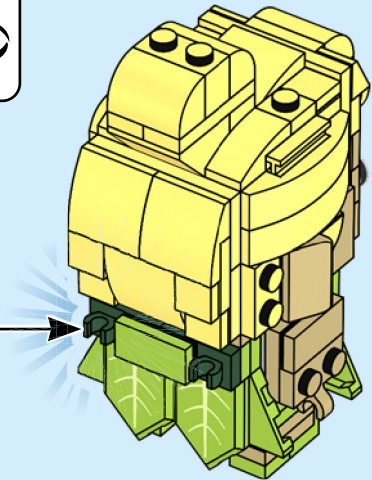
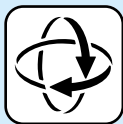

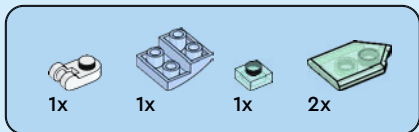

# 36

1

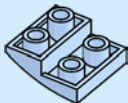

2

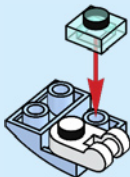

3



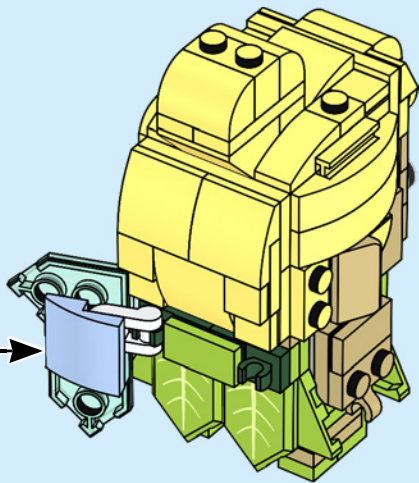

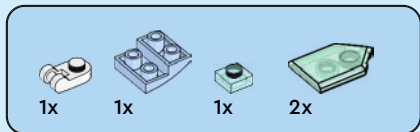

# 37

1

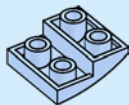

2

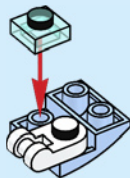

3

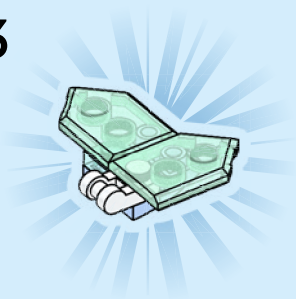



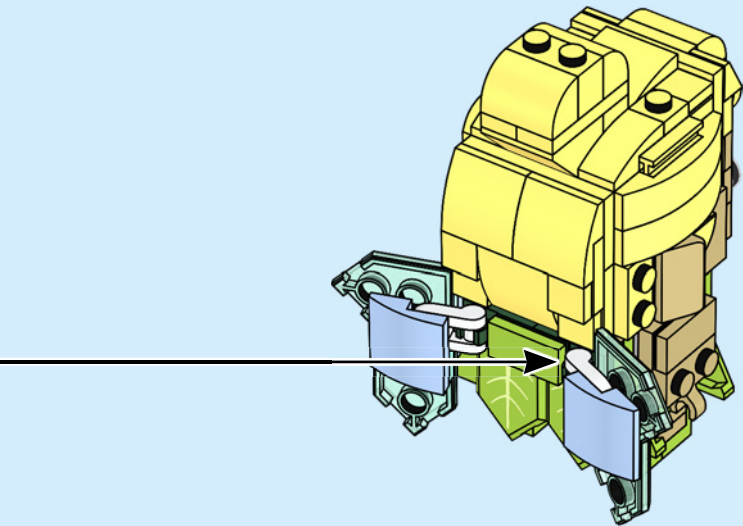

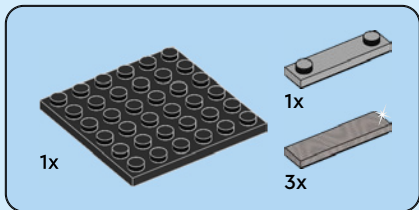

# 38

1

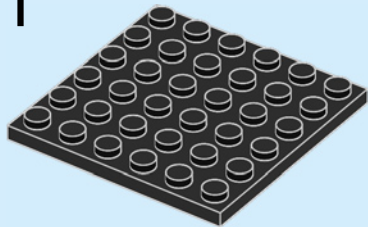

2

