



# STAR WARS™

75368





 **FR**  
**DONNEZ**  
OU  
**RECYCLEZ**

 OU  OU 

ASSOCIATION MAGASIN DÉCHÈTERIE

Adresses sur [quefairedemesdechets.fr](http://quefairedemesdechets.fr)



[LEGO.com/sustainable-packaging](https://LEGO.com/sustainable-packaging)



# BUILDER



Apple and the Apple logo are trademarks of Apple Inc., registered in the U.S. and other countries and regions. App Store is a service mark of Apple Inc. Google Play and the Google Play logo are trademarks of Google LLC. Tencent and the Tencent logo are trademarks of Tencent Inc.

 [LEGO.com/devicecheck](https://LEGO.com/devicecheck)

**EN** Ask parents' permission before going online | **DE** Eltern um Erlaubnis bitten, bevor du online gehst | **FR** Demande l'autorisation d'un parent avant d'aller en ligne | **IT** Chiedi il permesso ai tuoi genitori prima di andare online | **ES** Pídeles permiso a tus papás antes de conectarte a Internet | **PT** Peça autorização aos pais antes de acederes online | **ZH** 上网前应先征得父母的同意 | **PL** Poproś rodziców o zgodę, zanim wejdiesz do Internetu | **CS** Než půjdeš na internet, požádej rodiče o svolení | **SK** Skôr než pôjdeš na internet, vypýtaj si povolenie od rodičov | **HU** Kérj szülői engedélyt, mielőtt online csatlakoznál! | **RO** Cere permisiunea părinților înainte de a te conecta online | **BG** Поискайте разрешение от родител, преди да влезете онлайн | **LV** Pirms došanās tiešsaistē palūdz atļauju vecākiem | **ET** Enne Interneti kasutamist küsi vanematelt luba | **LT** Prieš prisijungdami prie interneto, atsiklauskite tėvų



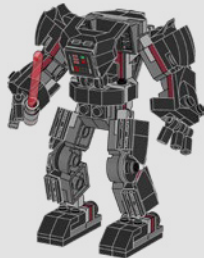
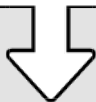
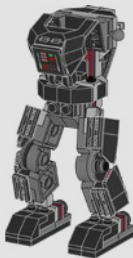
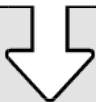
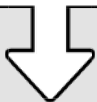





1

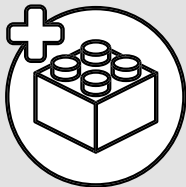
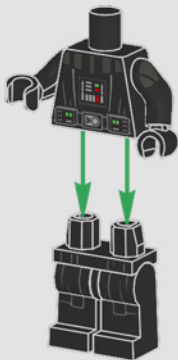

2



3

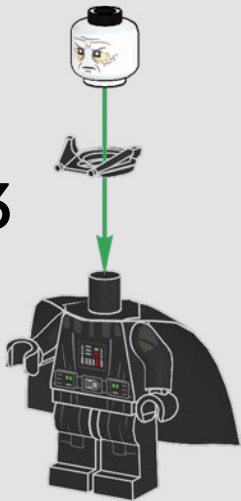

4

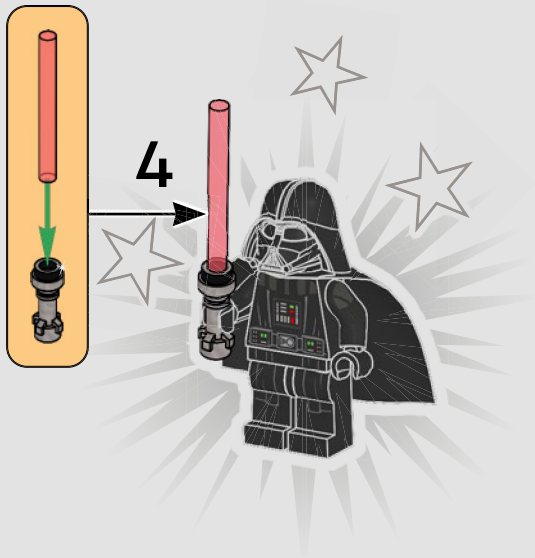

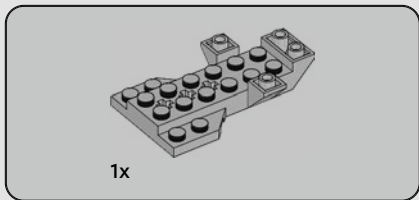

1

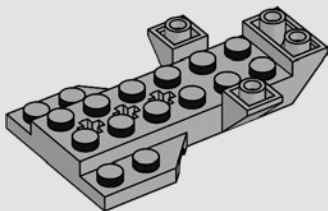



1x

2

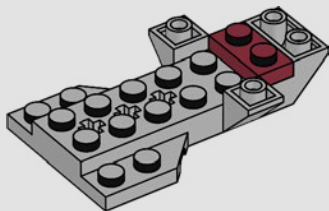

1x

3

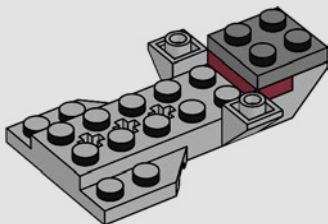



2x

4

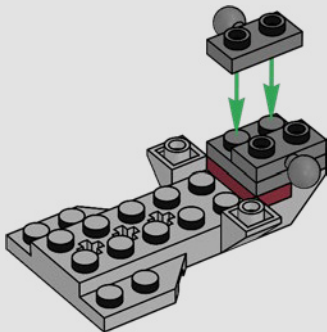

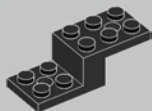

1x

5

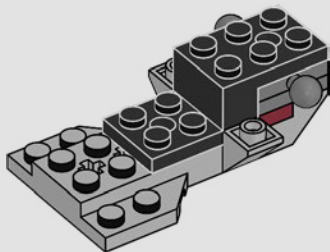

1x

6

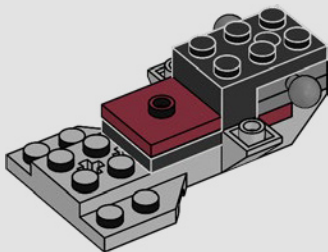



2x

7

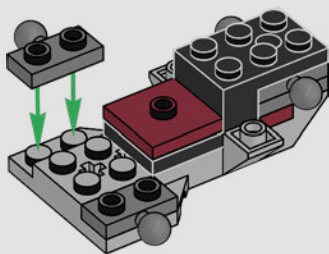



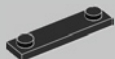

2x

8

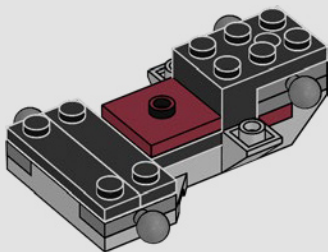

2x

9

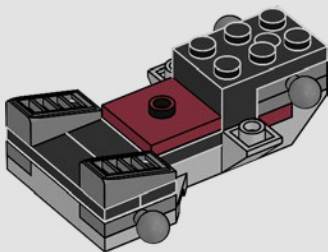



2x

10

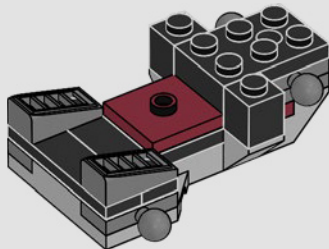



2x

11

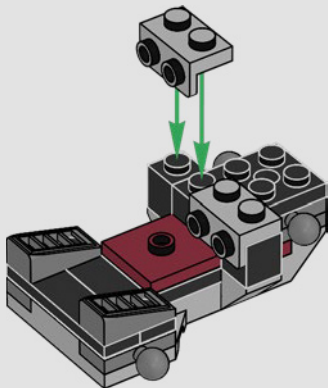

1x

12

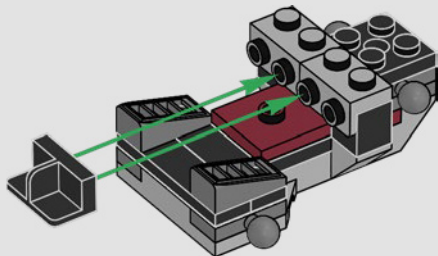



2x

13

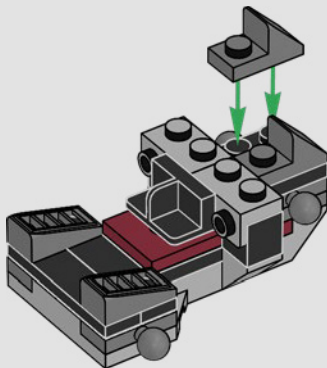

16





1x

14

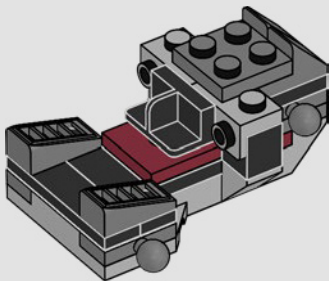

2x

15

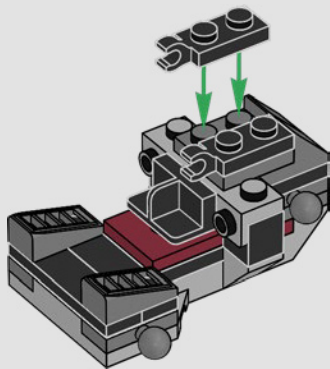



2x

16

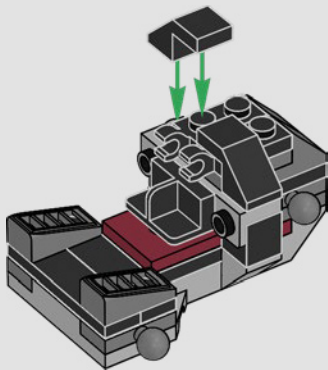

18

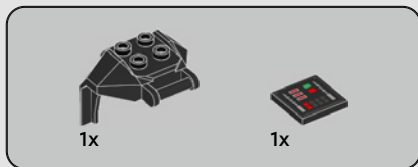

17

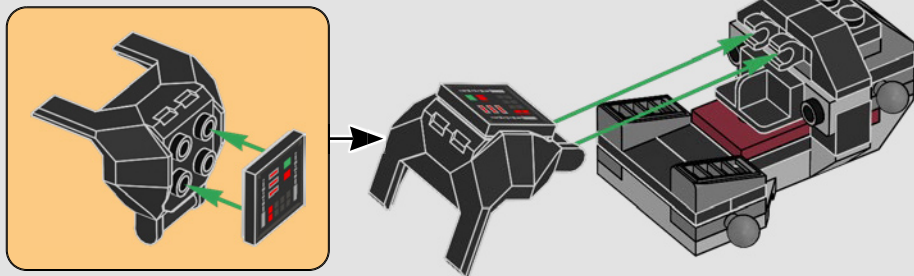



2x

18

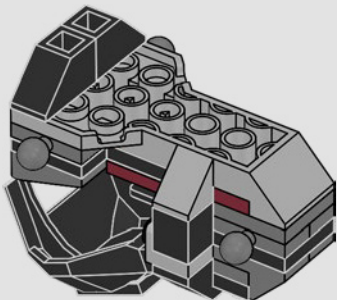



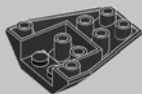

1x

19

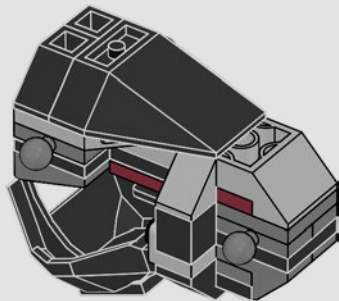

2x

20



2x

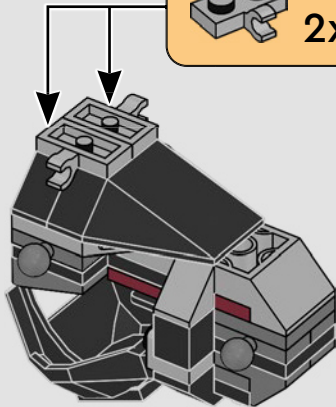



1x

21

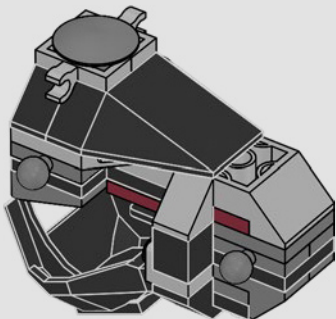

22







1x

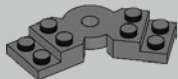

1x

# 22

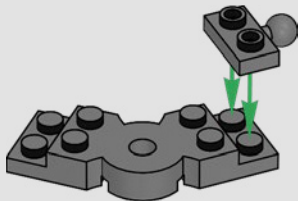



1x

23

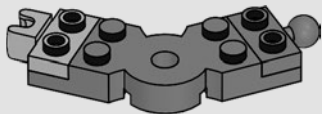

2x

24

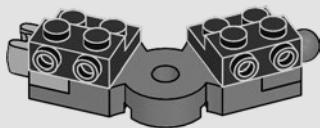



2x

25

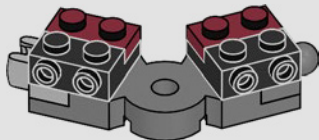

26





2x

26

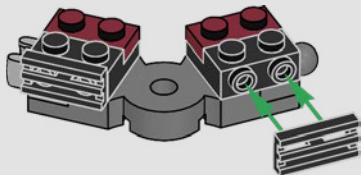

1x

27

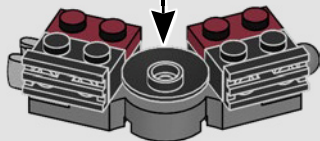



1x

# 28

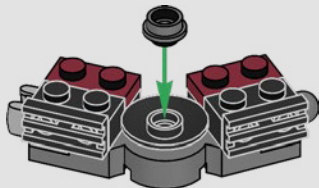



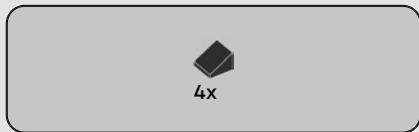

29

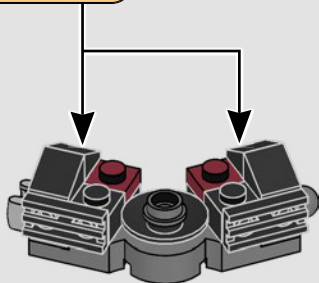
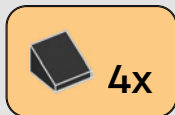



2x

# 30

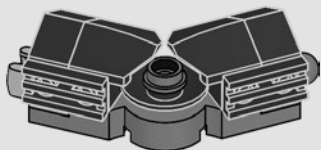

30



31

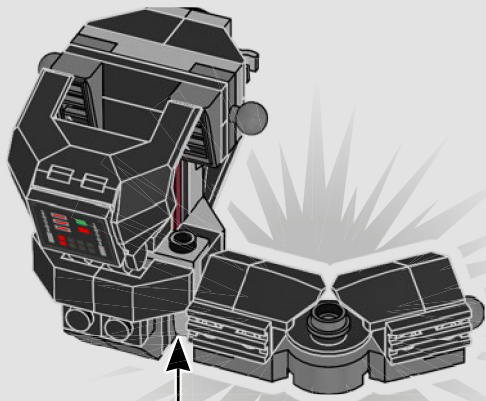



1x



1x

# 32

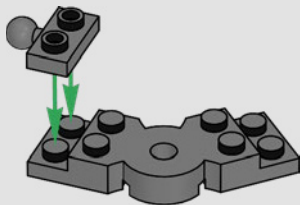



1x

33

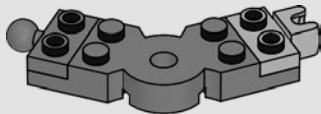

2x

34

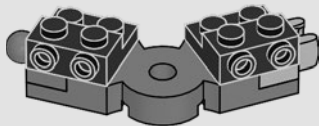



2x

35

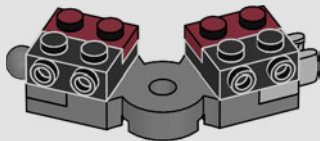



2x

36

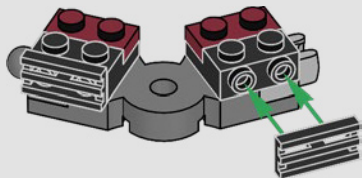

1x

37

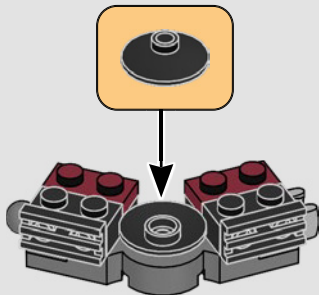



1x

# 38

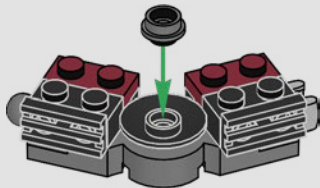



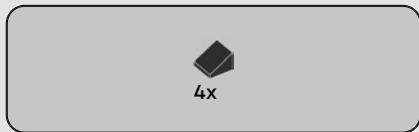

39

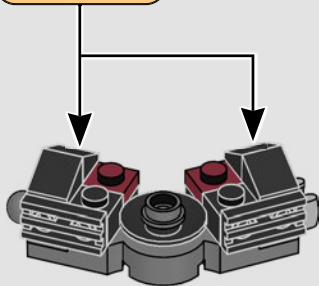
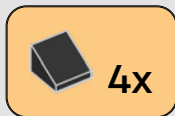



2x

40

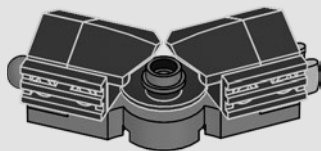

41

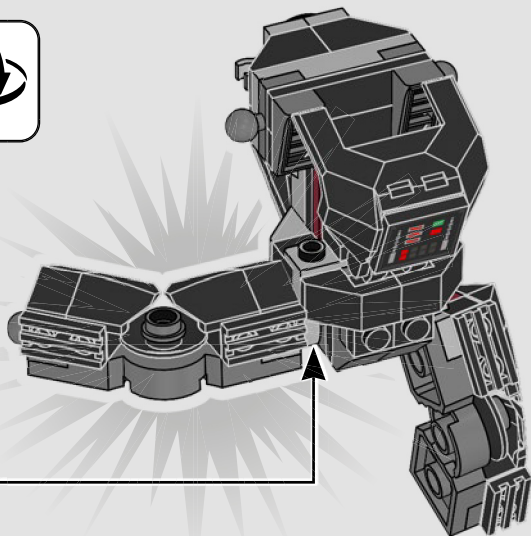



1x



1x

# 42

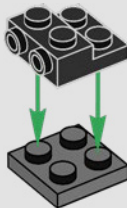



1x

43

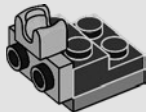

1x

44

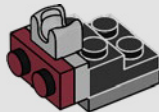



1x

# 45

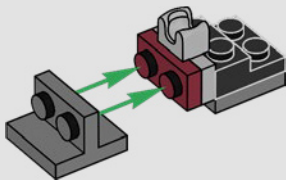



2x

46

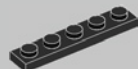
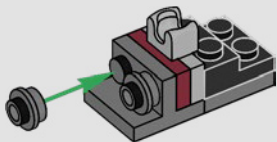

2x

47

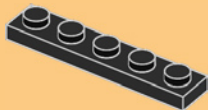
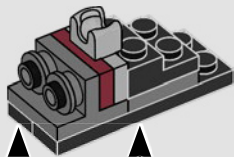

2x



2x

48

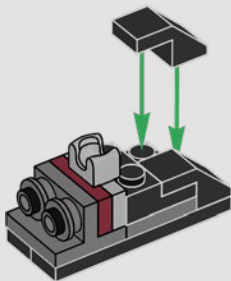

2x



49

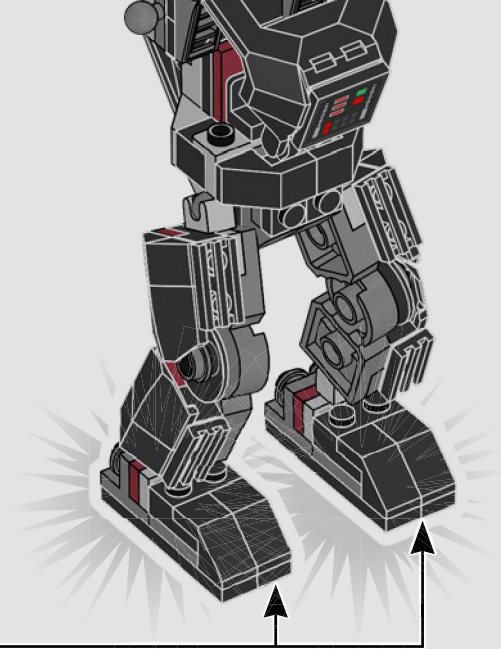

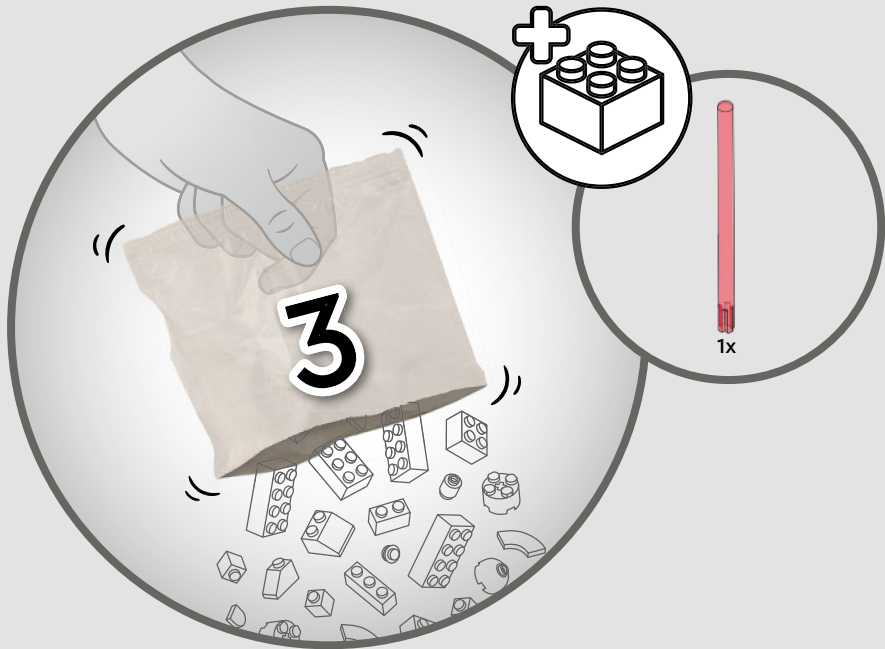

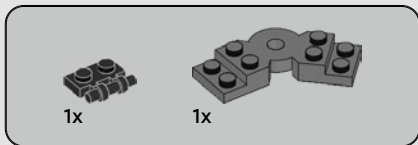
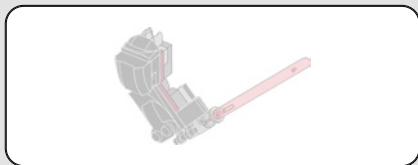

50

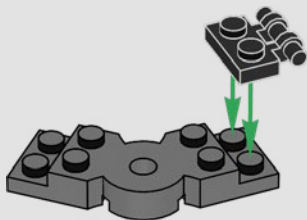



1x

# 51

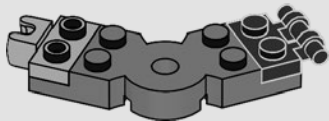



1x

52

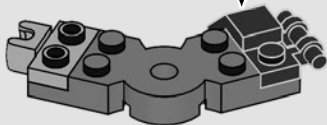

2x

53

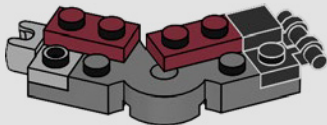



2x

# 54

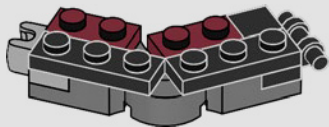



1x



1x

55

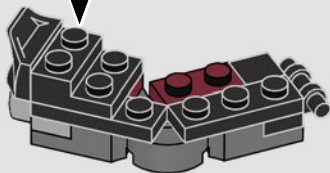
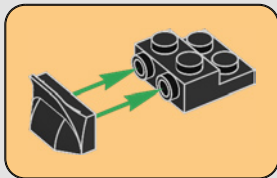



3x

56

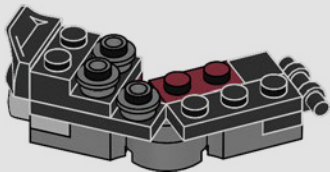



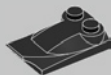

1x

57

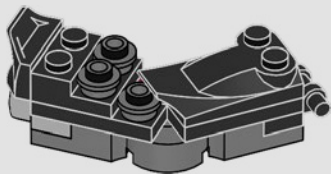

1x

58

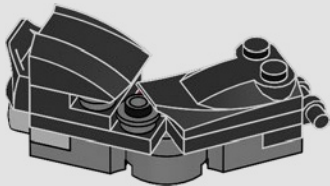



1x

59

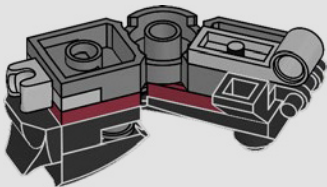
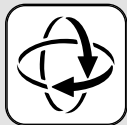



1x

60

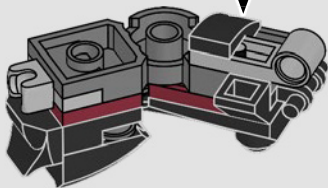
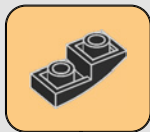

1x

61

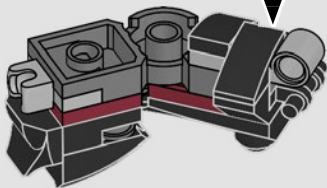
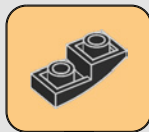

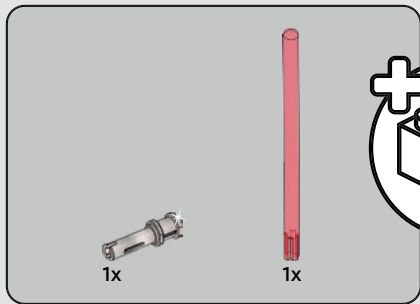

62

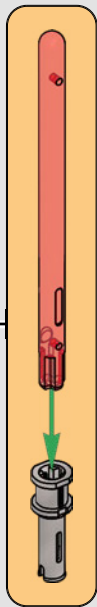
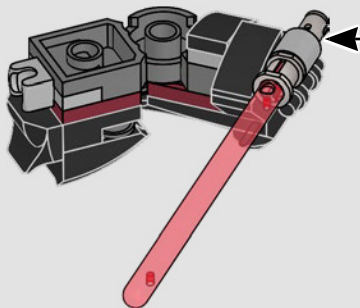



1x

63

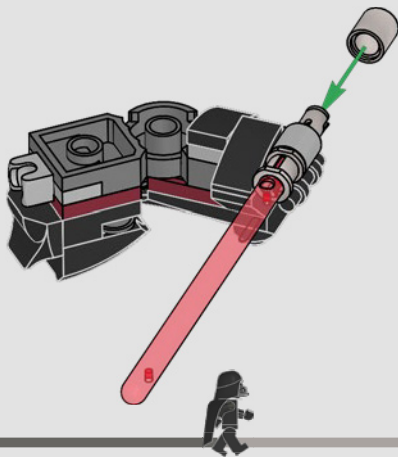



3x

64

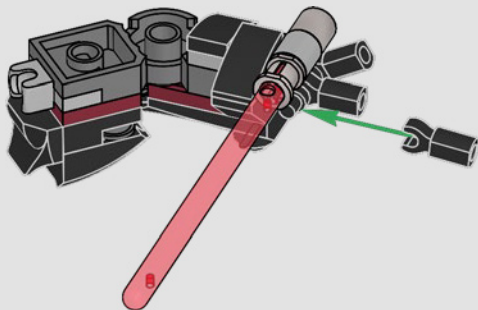

65

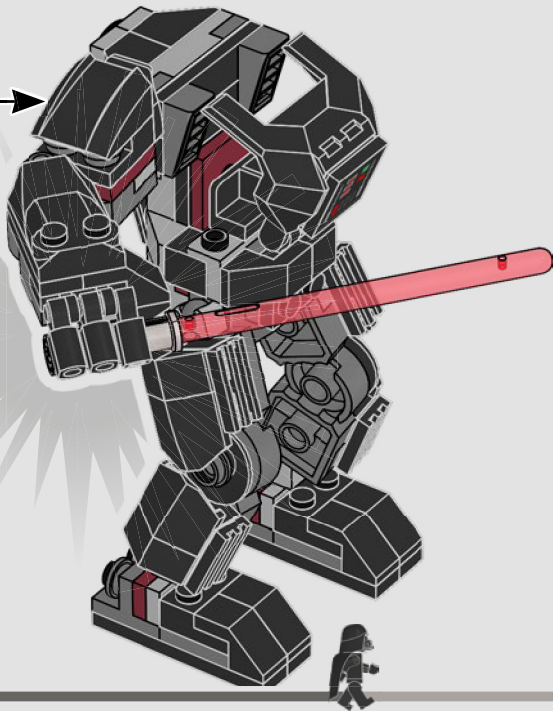



1x



1x

66

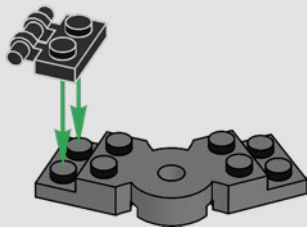





1x

67

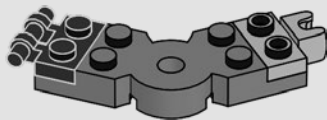



1x

68

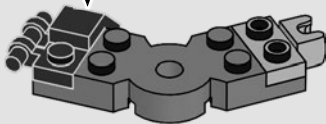



2x

69

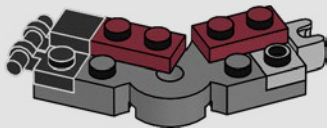

2x

70

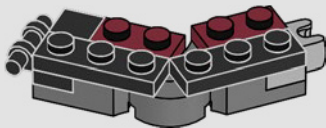



1x



1x

71

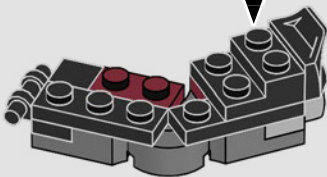
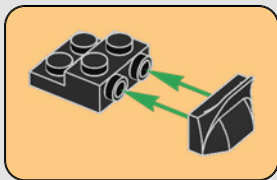



3x

72

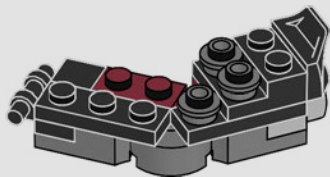

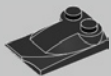

1x

# 73

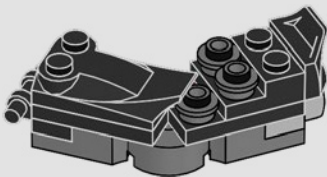



1x

74

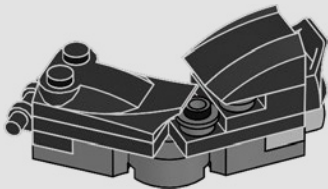



3x

# 75

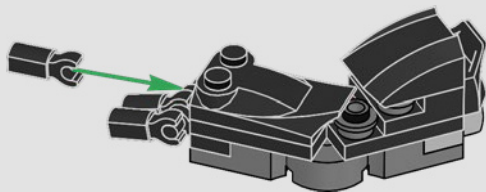



76

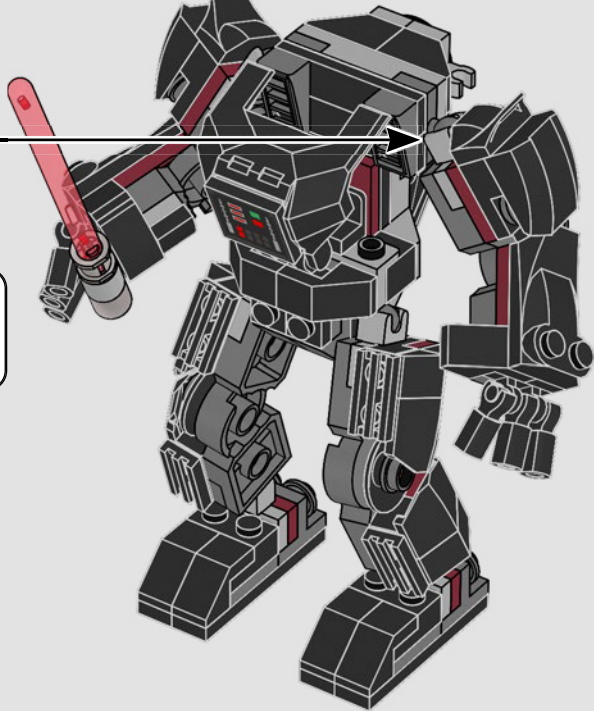







# STAR WARS



**75368**



**75369**



**75370**



# STAR WARS



75365



75360



75359



75361



1x  
6405191



2x  
6147050



8x  
6469445



6x  
6315887



4x  
6350415



2x  
300526



4x  
241226



2x  
474026



1x  
6360031



1x  
6039194



8x  
4504382



1x  
6444188



1x  
6115086



2x  
6375706

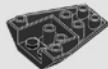

1x  
6092952



2x  
366526



4x  
362326



1x  
6112160



4x  
6452332



8x  
6267487



2x  
6254045



1x  
6310813



2x  
4143875



1x  
6288460



2x  
6336989



2x  
4140588



1x  
6308178



2x  
4285883



1x  
6335646



1x  
6435314



1x  
6167284



11x  
4539097



1x  
4613761



6x  
6043656



2x  
6313114



2x  
4654582



1x  
6438836

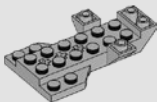

1x  
6452334



4x  
6395097



12x  
6231765



4x  
4211094



6x  
6039479



2x  
6250018



1x  
4278274



2x  
6069164



2x  
4540386



1x  
6051389



1x  
6161155



1x  
6287673



[LEGO.com/service](https://www.LEGO.com/service)

YOU COULD

WIN

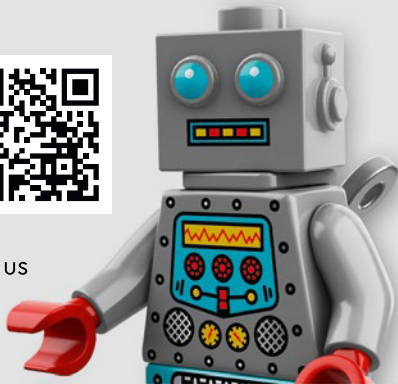

Scan this QR code or go to  
**LEGO.COM/PRODUCTFEEDBACK** and give us  
your short feedback about this LEGO® set  
for a chance to win a cool LEGO prize.

Terms and Conditions apply\*

**EN: YOU COULD WIN.** Terms and Conditions apply\* **DE: Du könntest GEWINNEN.** Es gelten die Teilnahmebedingungen\* **FR: Tu pourrais GAGNER.** Des conditions s'appliquent\* **IT: Potresti VINCERE tu.** Termini e condizioni sono applicabili\* **ES: Puedes GANAR.** Aplican términos y condiciones\* **PT: Poderá GANHAR.** Aplicam-se termos e condições\* **ZH: 轻松获奖.** 条款和条件适用\* **PL: Szansa na WYGRANĄ.** Obowiązują warunki korzystania\* **CS: Máte šanci VYHRÁT.** Platí všeobecné smluvní podmínky\* **SK: Máte šancu VYHRÁT.** Platia všeobecné zmluvné podmienky\* **HU: TE IS NYERHETSZ.** Felhasználási feltételek érvényesek\* **RO: Ai putea CÂȘTIGA.** Se aplică termenii și condiții\* **BG: Можете да СПЕЧЕЛИТЕ.** Има определени правила и условия\* **LV: Tu vari LAIMĒT.** Ir spēkā noteikumi un nosacījumi.\* **ET: Sul on võimalus VÕITA.** Kehtivad tingimused\* **LT: Jūs galite LAIMĖTI.** Taikomos sąlygos\*

\*[LEGO.com/productfeedback-terms](https://www.lego.com/productfeedback-terms)

LEGO and the LEGO logo are trademarks of the LEGO Group. ©2023 The LEGO Group.

© & ™ Lucasfilm Ltd.

6490643