

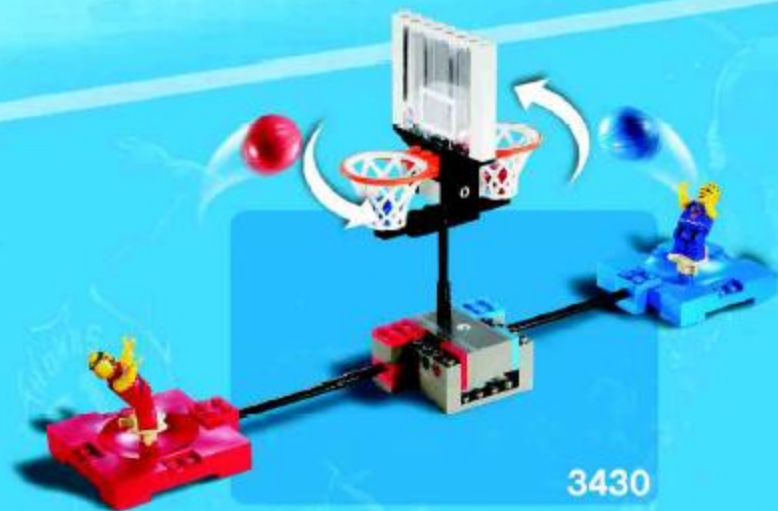

SPORTS

3432







3428



3433



3560



3561



3562



3563



3564



3565



3566



3567



1

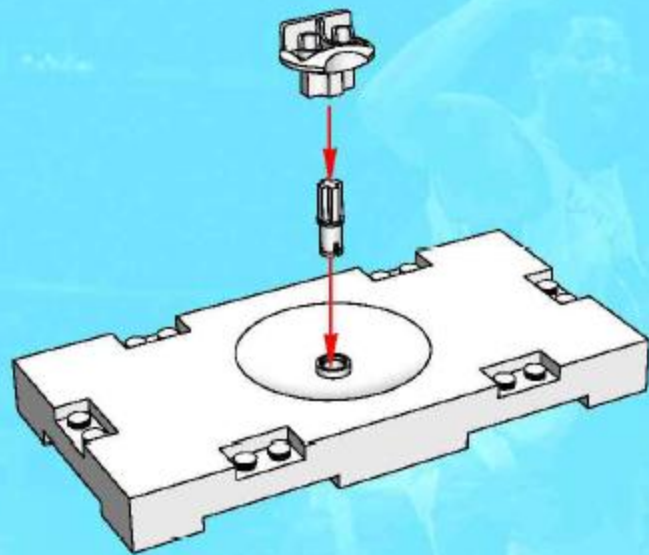

2

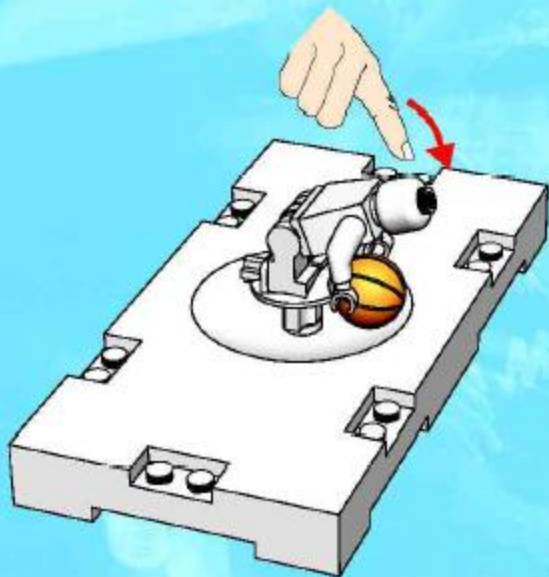

3

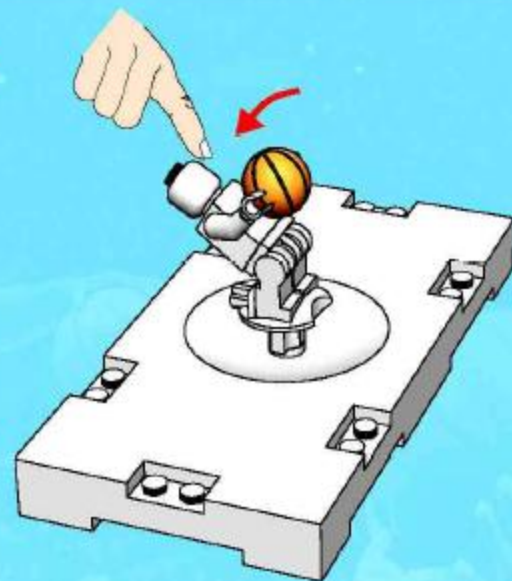

4

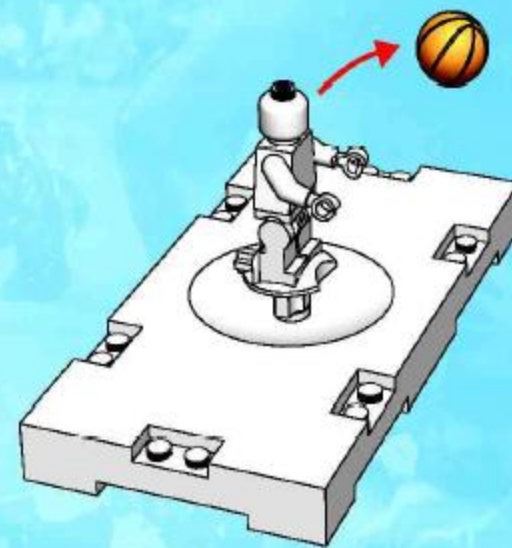



1

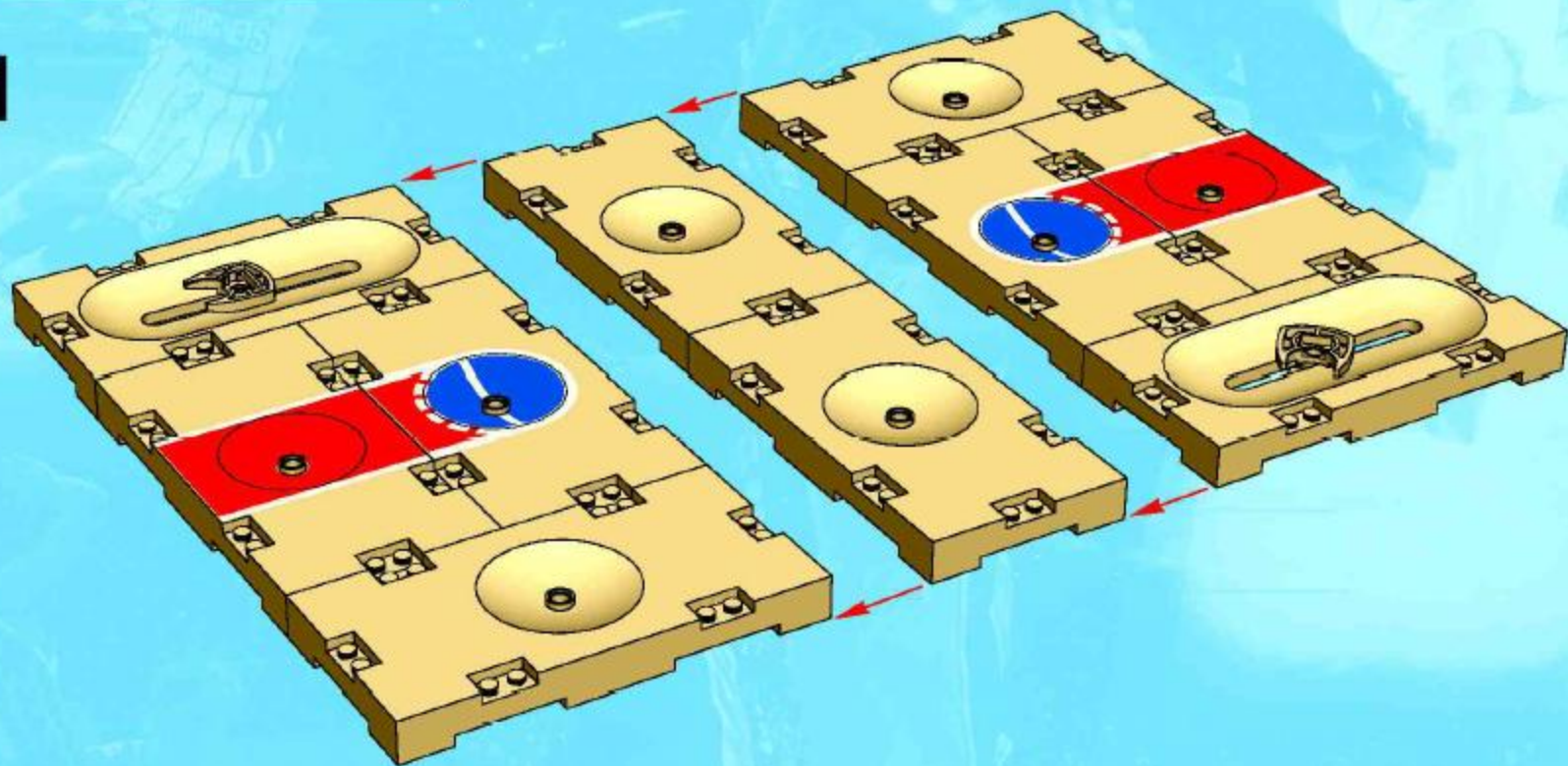

2

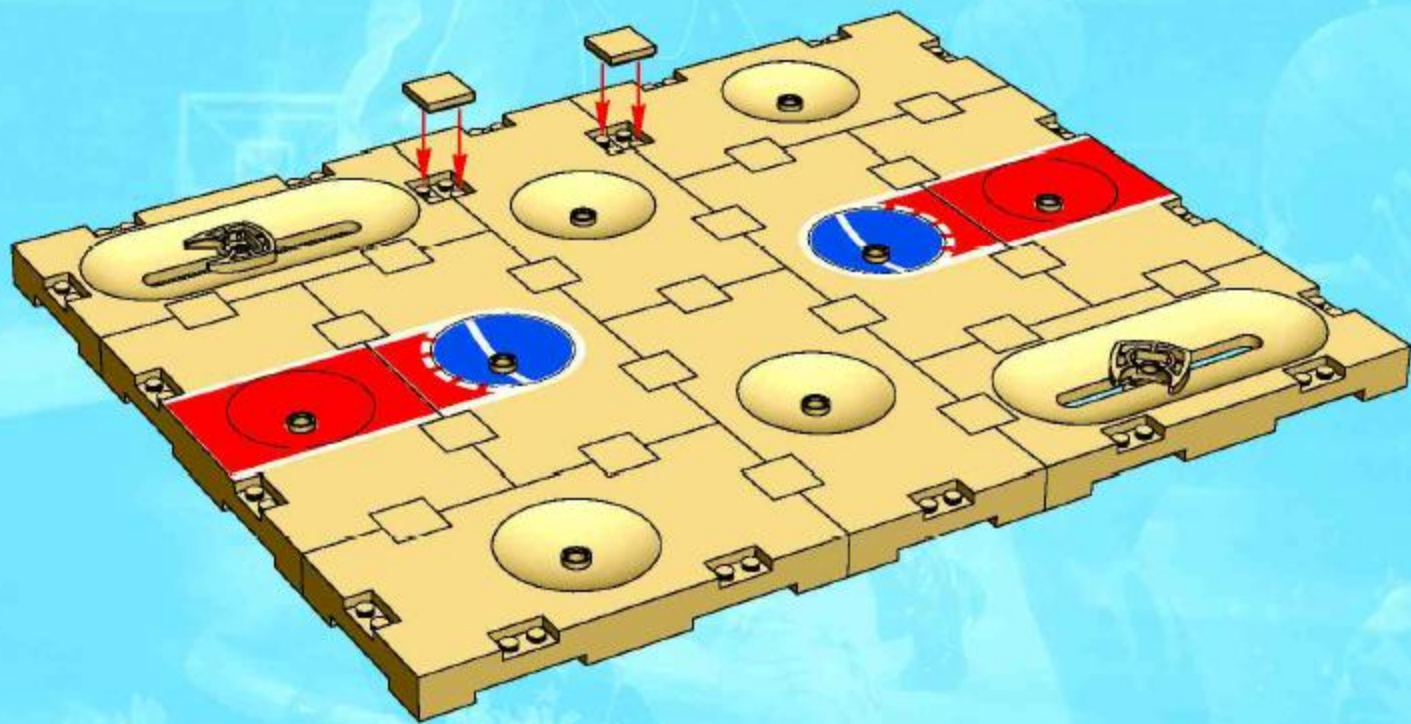

3

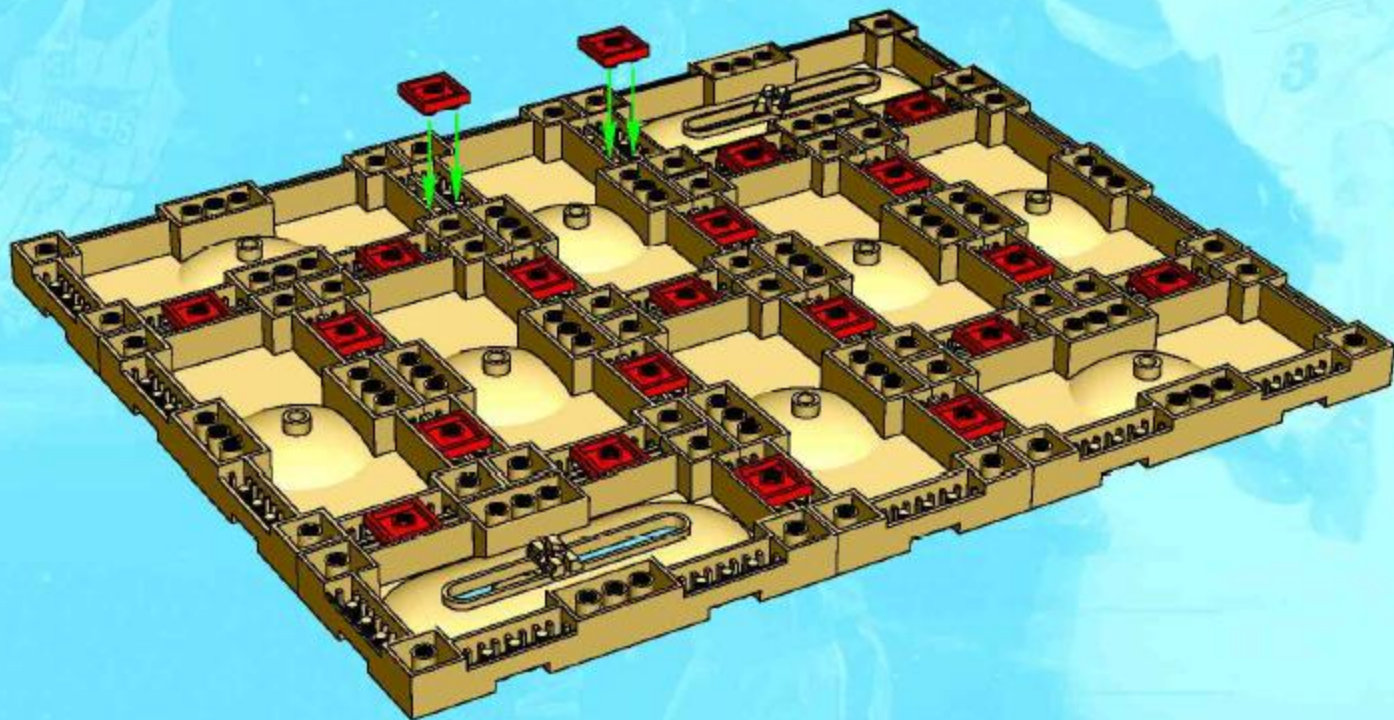

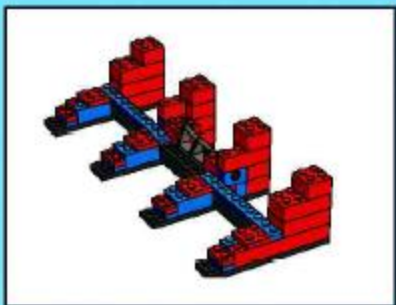

1



2

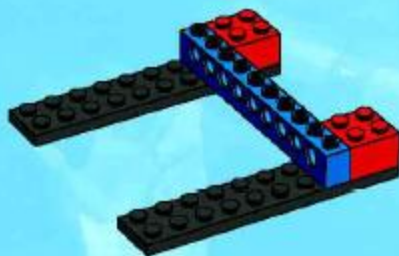

3

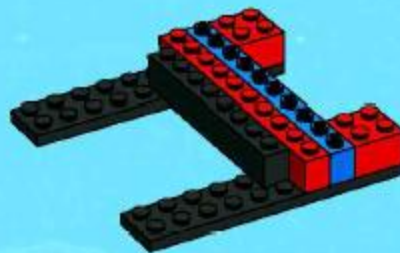

4

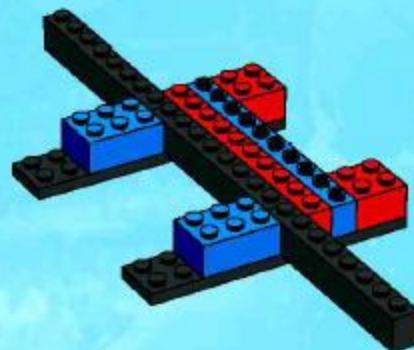

5

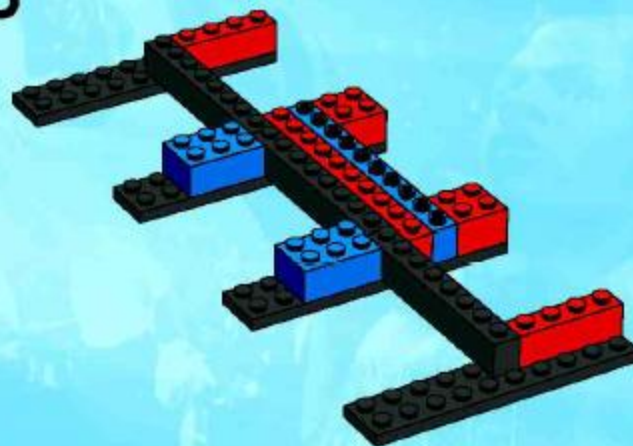



6

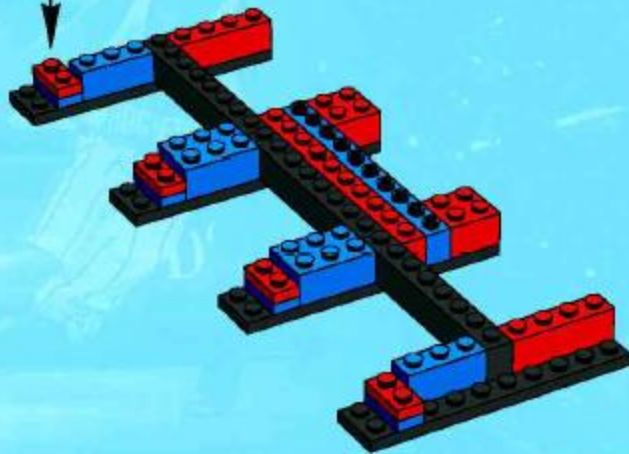

7

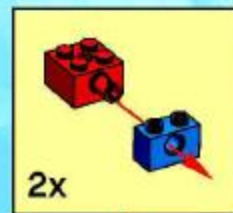
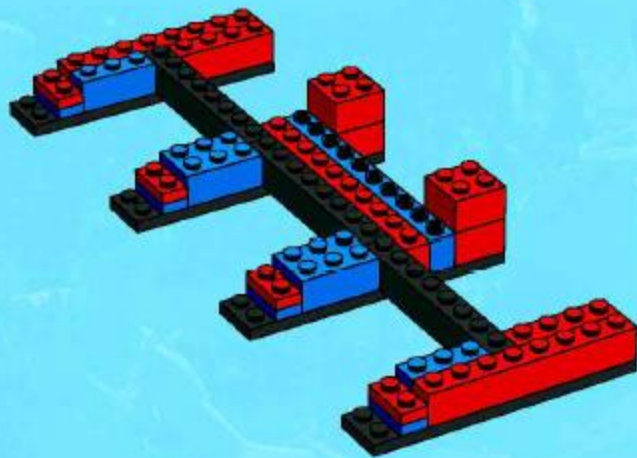

8

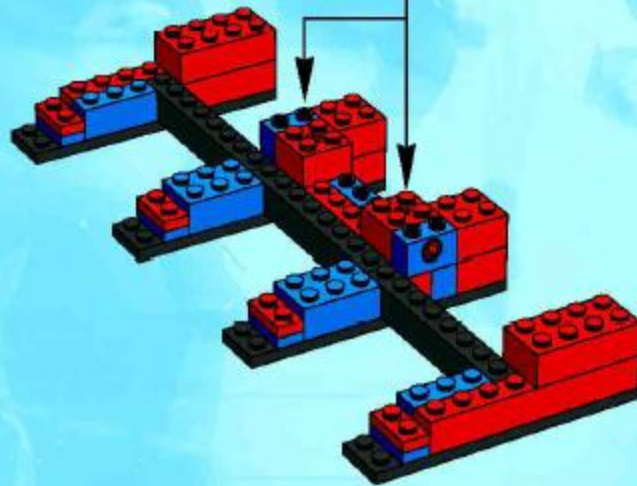

9

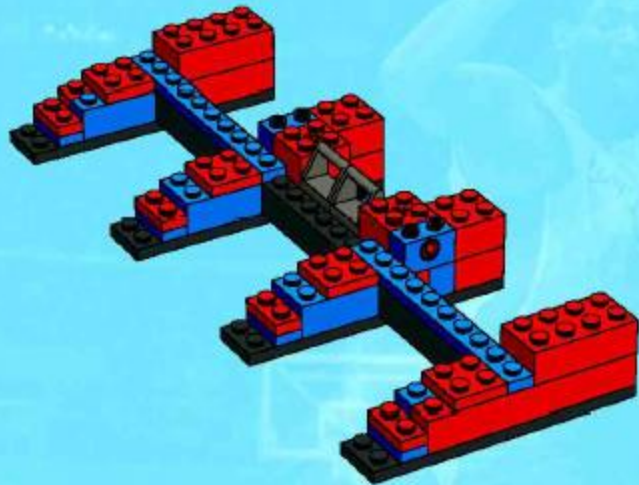

10

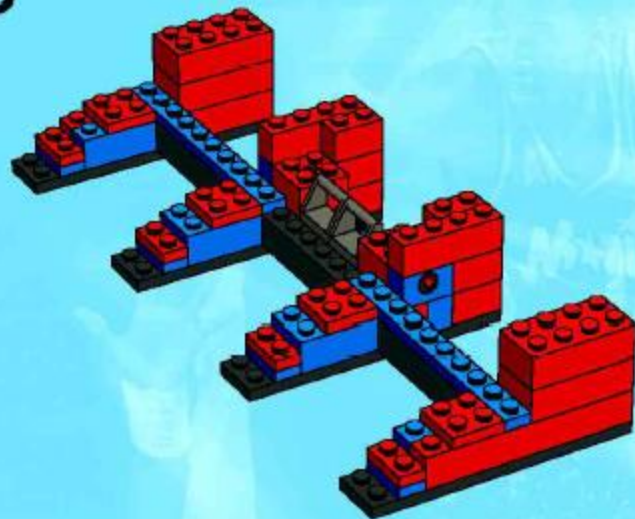

11

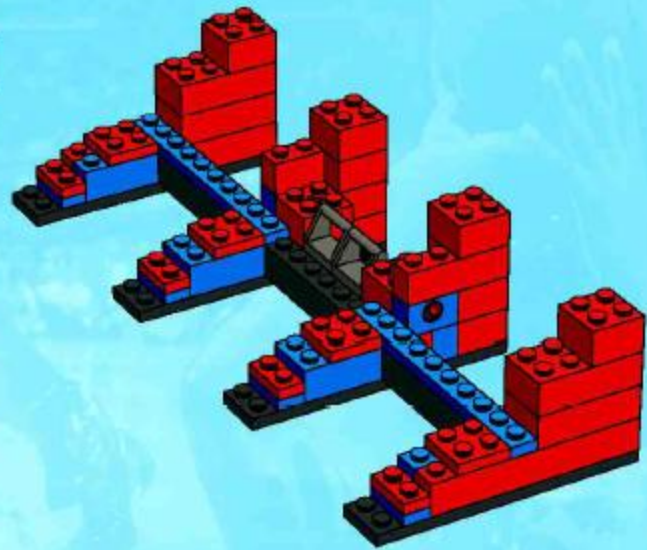

2x

4

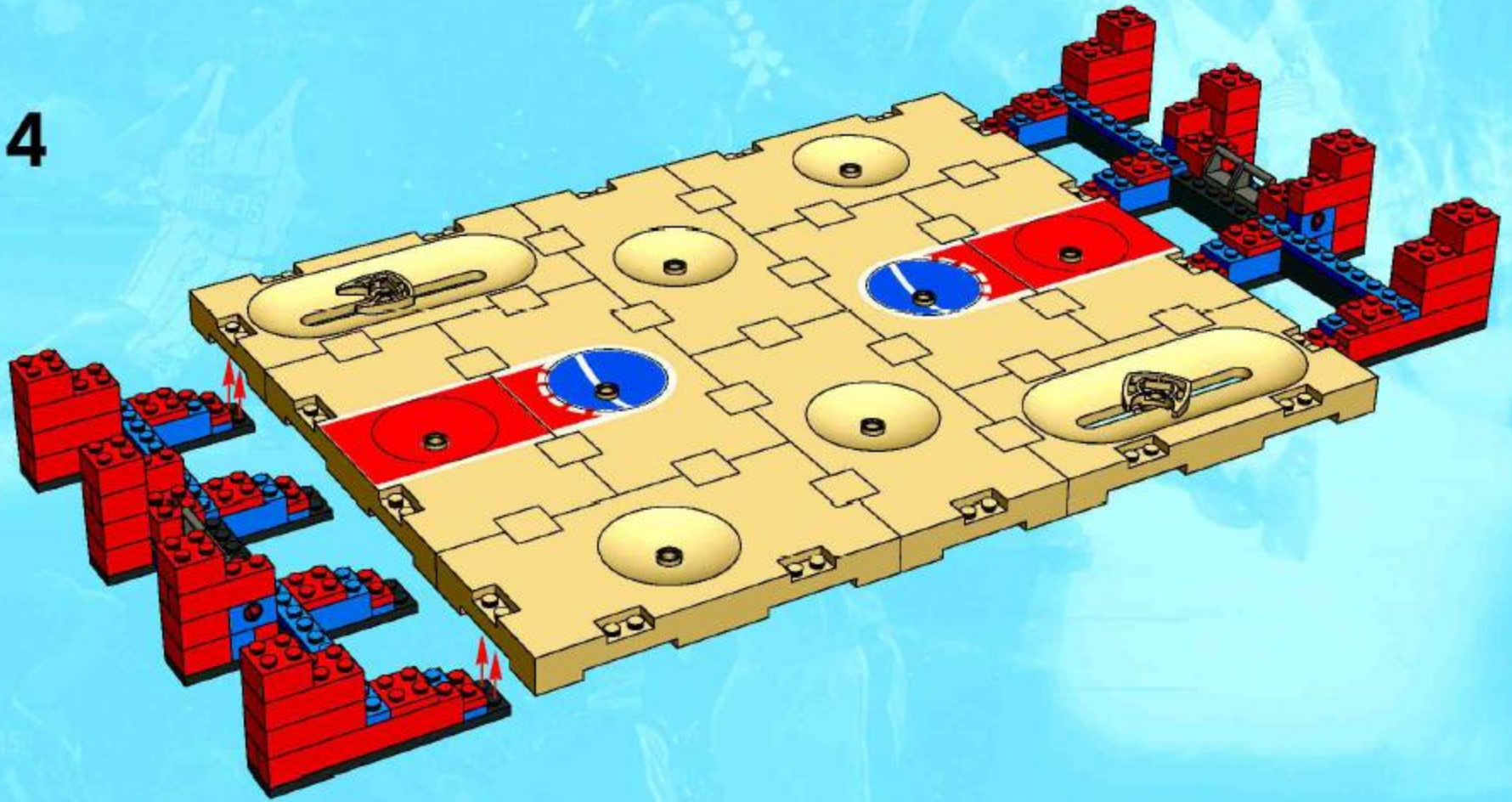

5

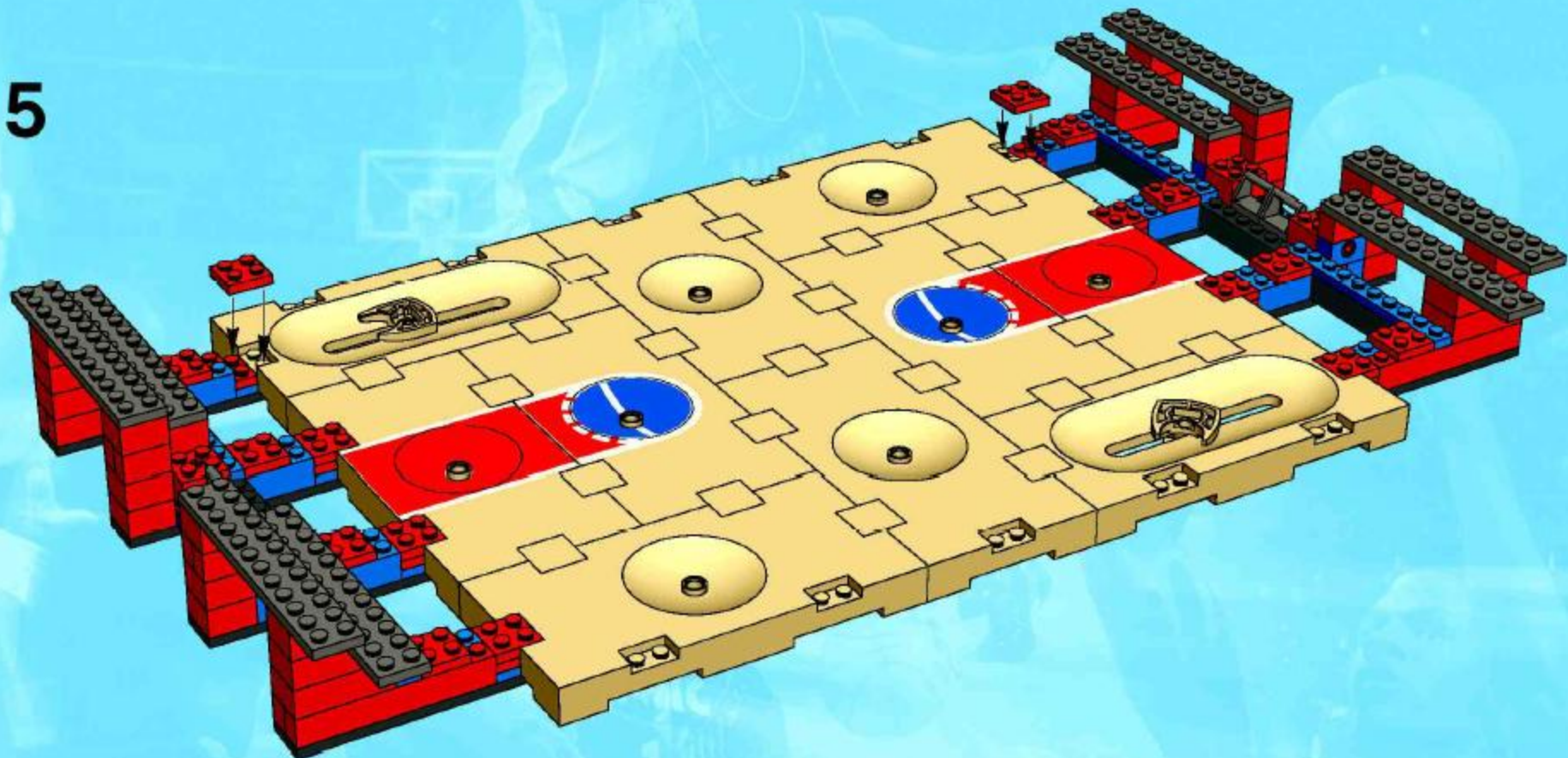

6

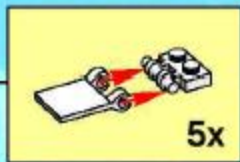
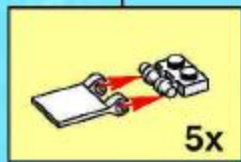
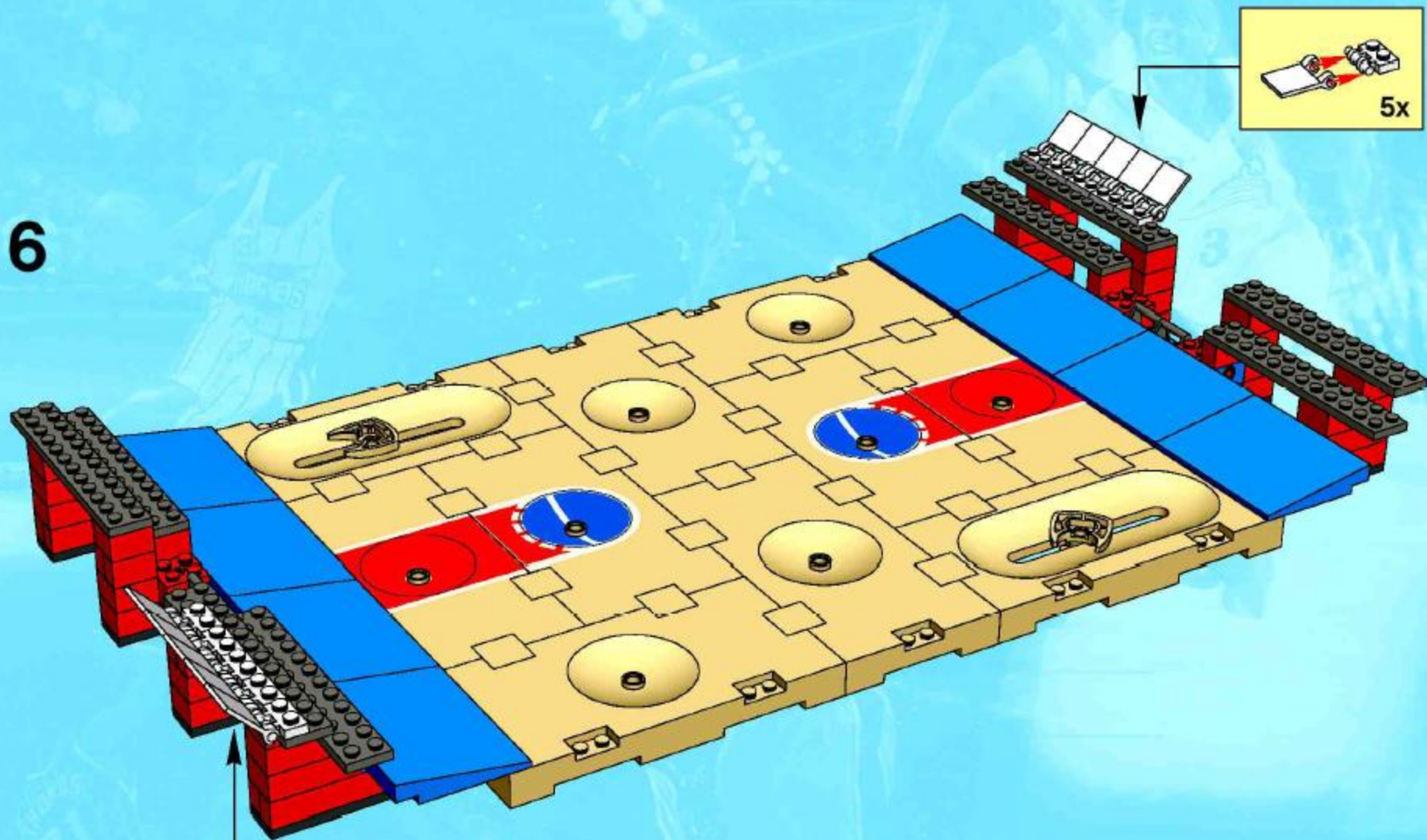



1

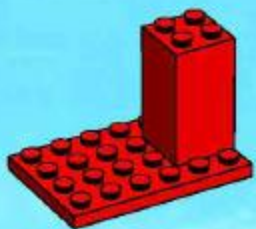

2

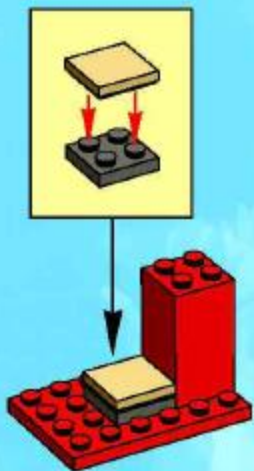

3



4



5

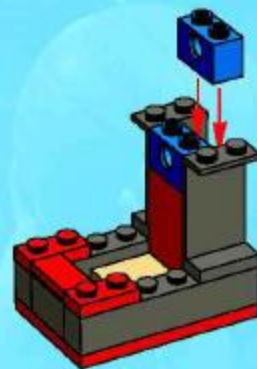

6



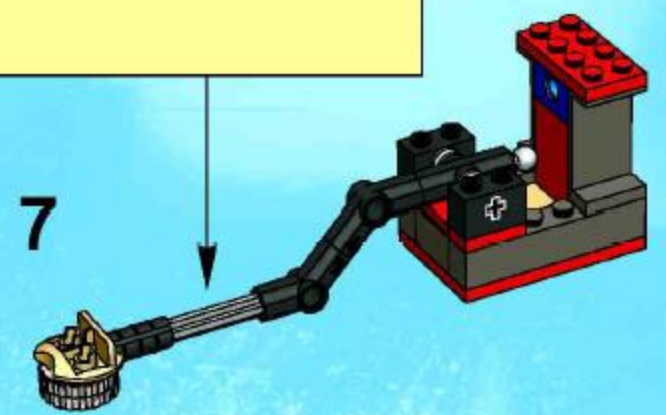
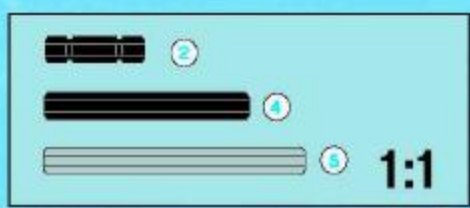
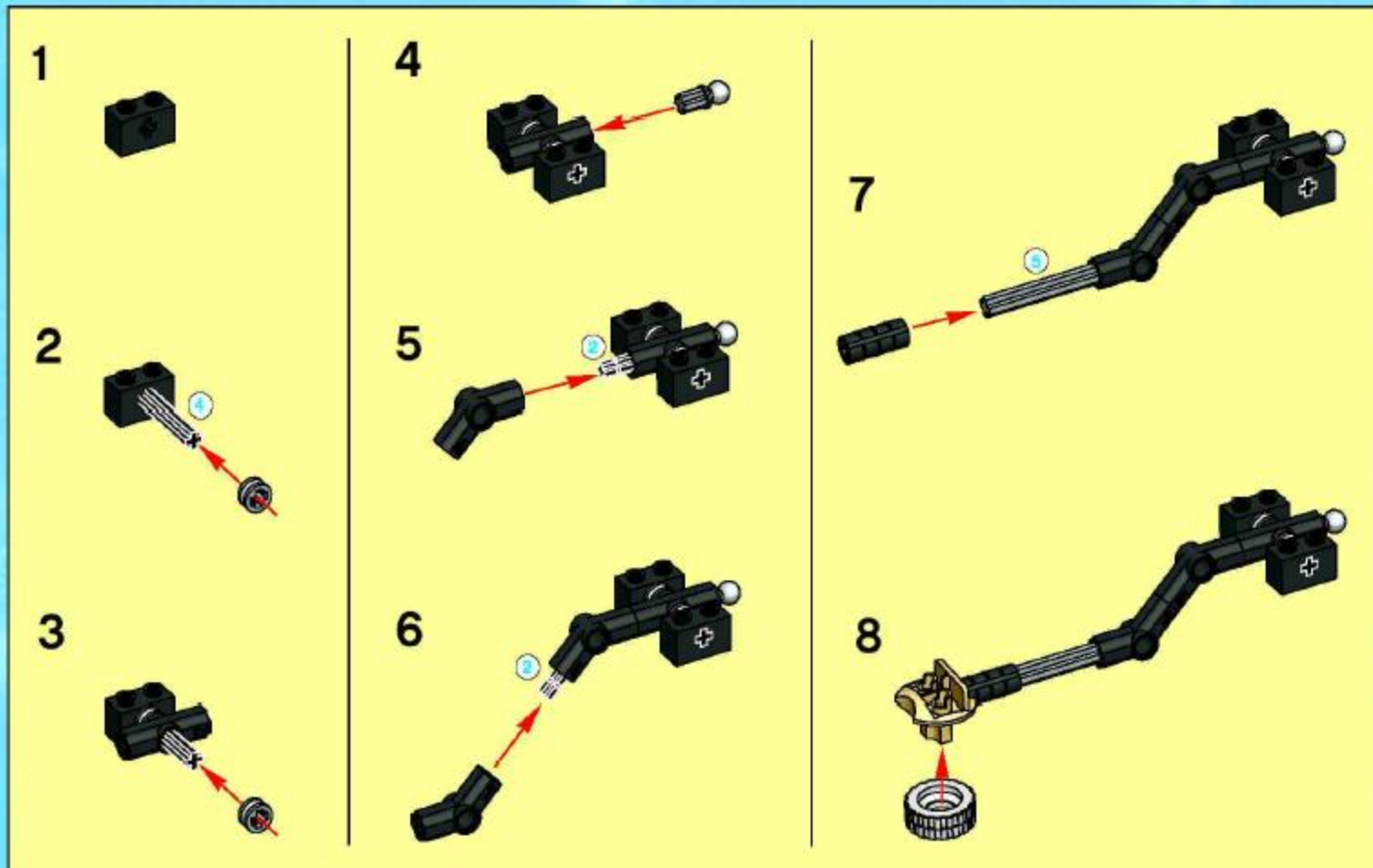

8

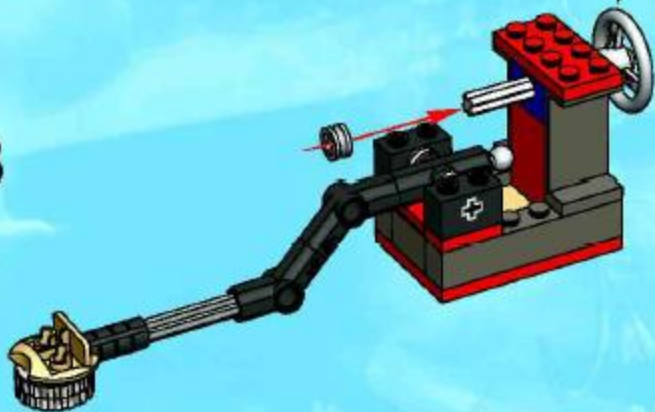
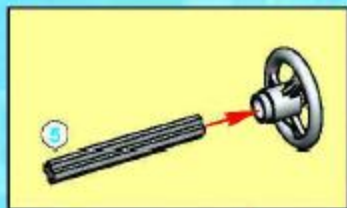

9



10



1



2



3

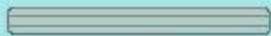

5

1:1

7

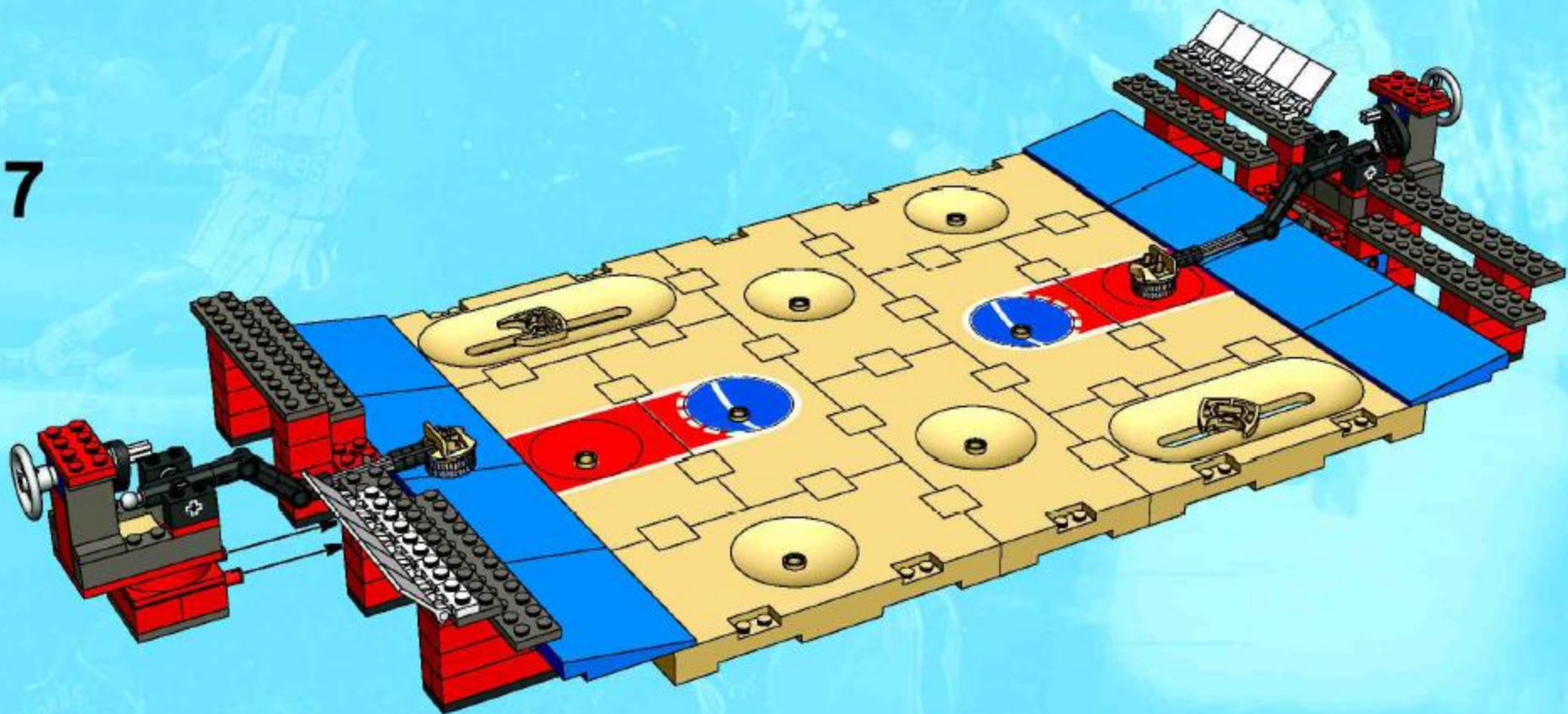

8

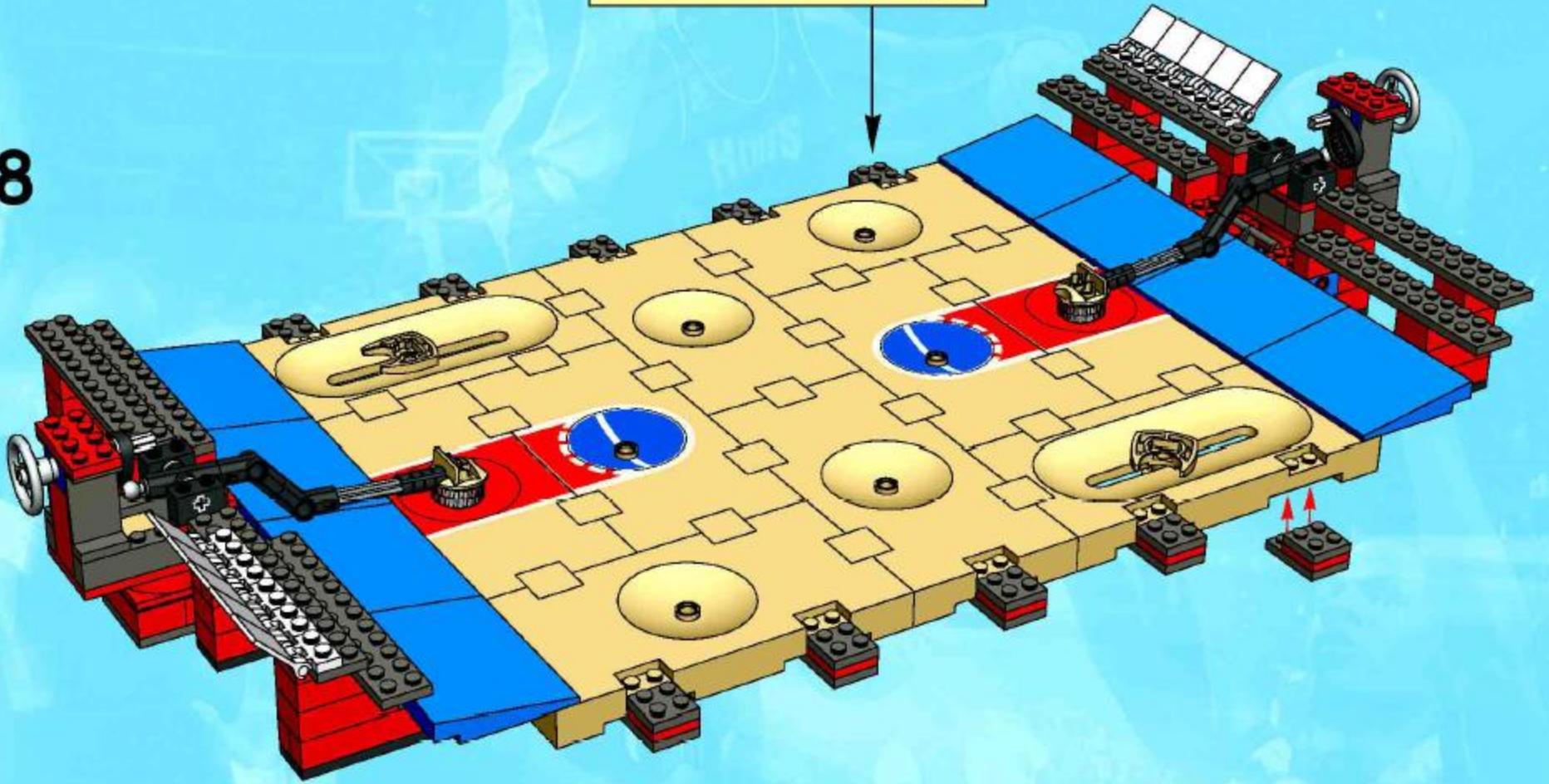
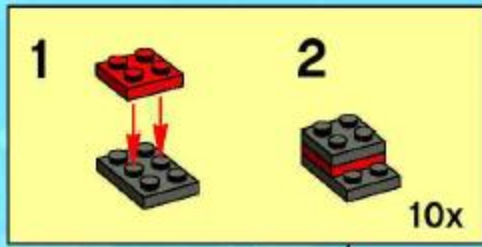

9



10

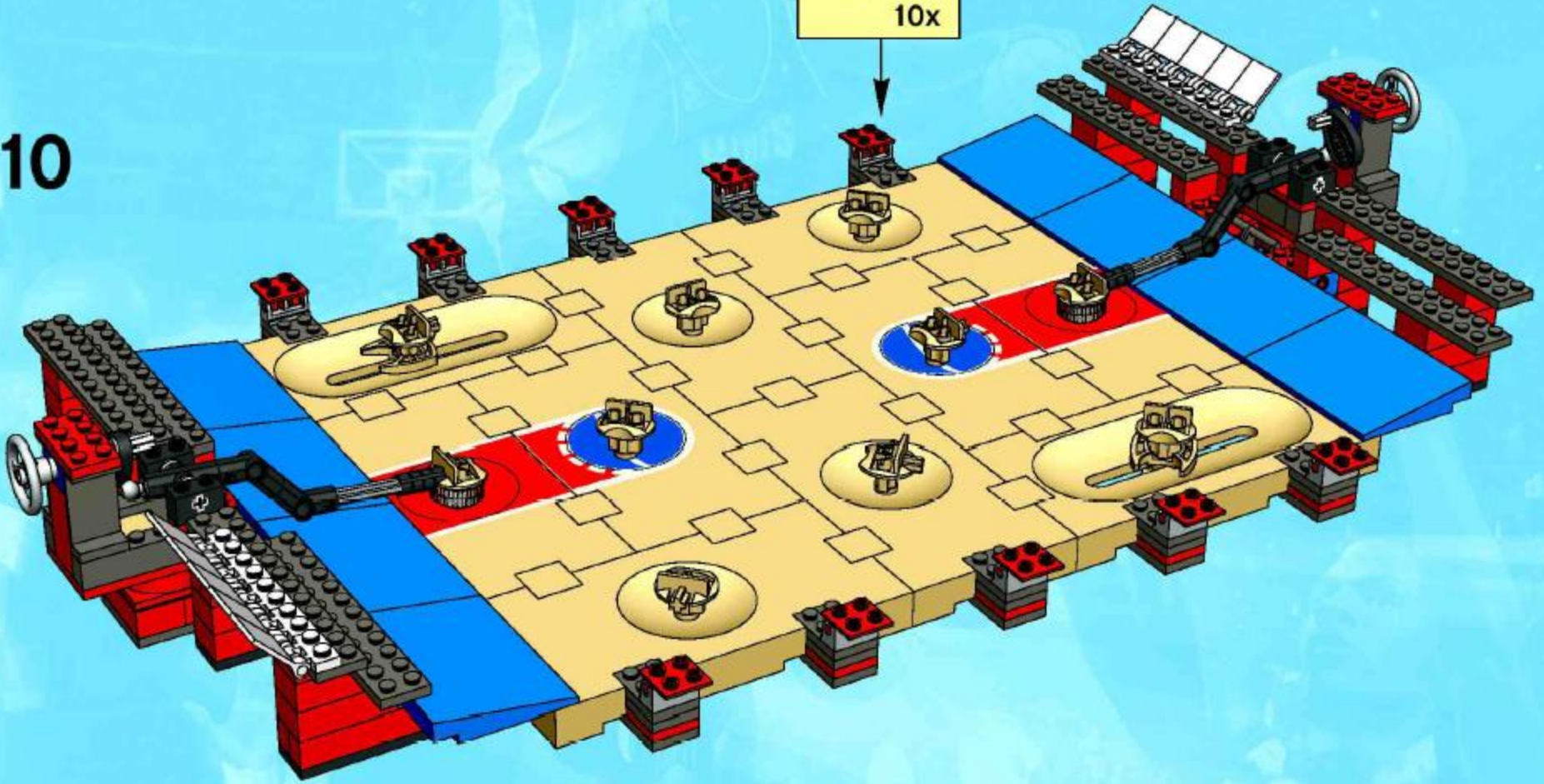

11

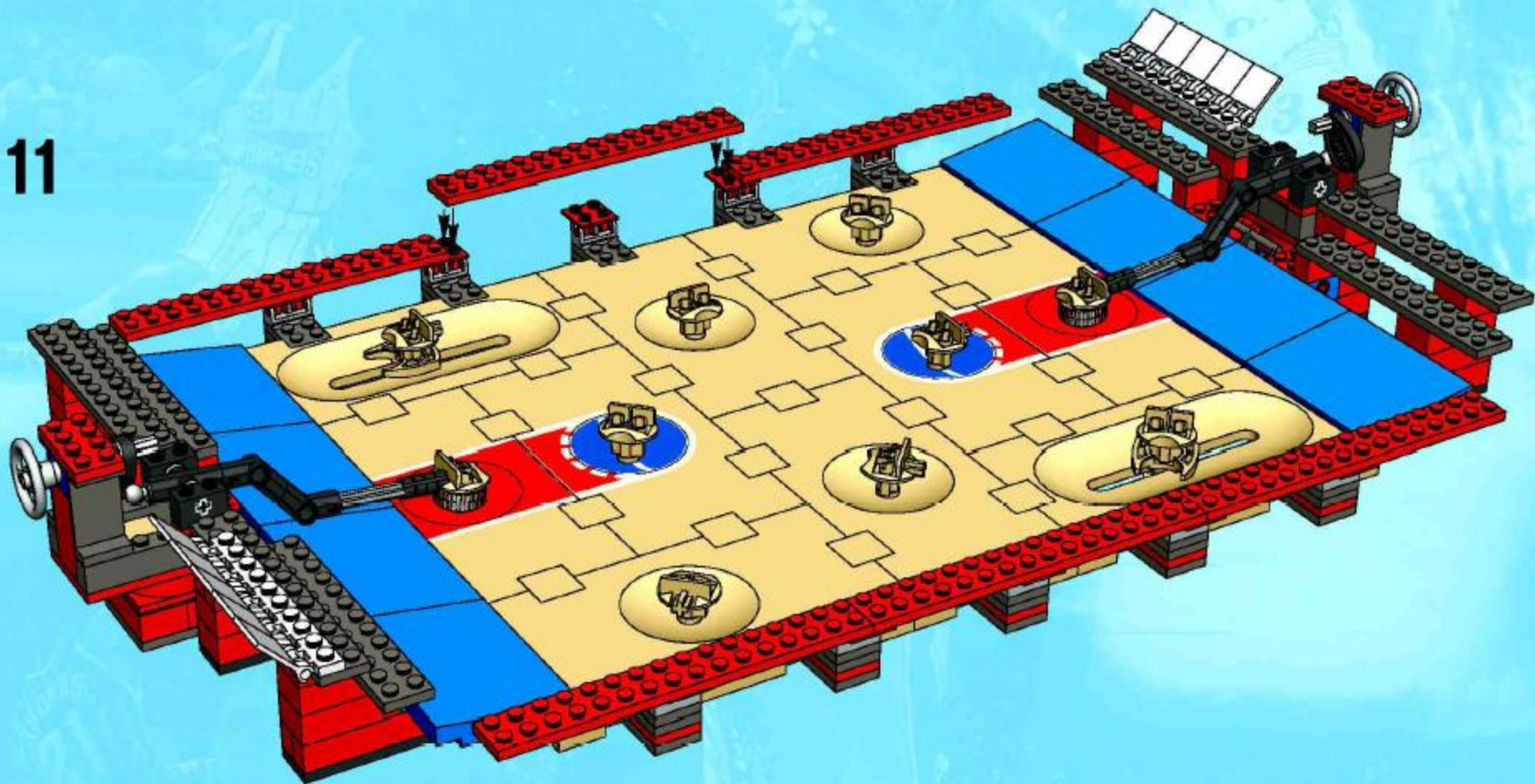

12

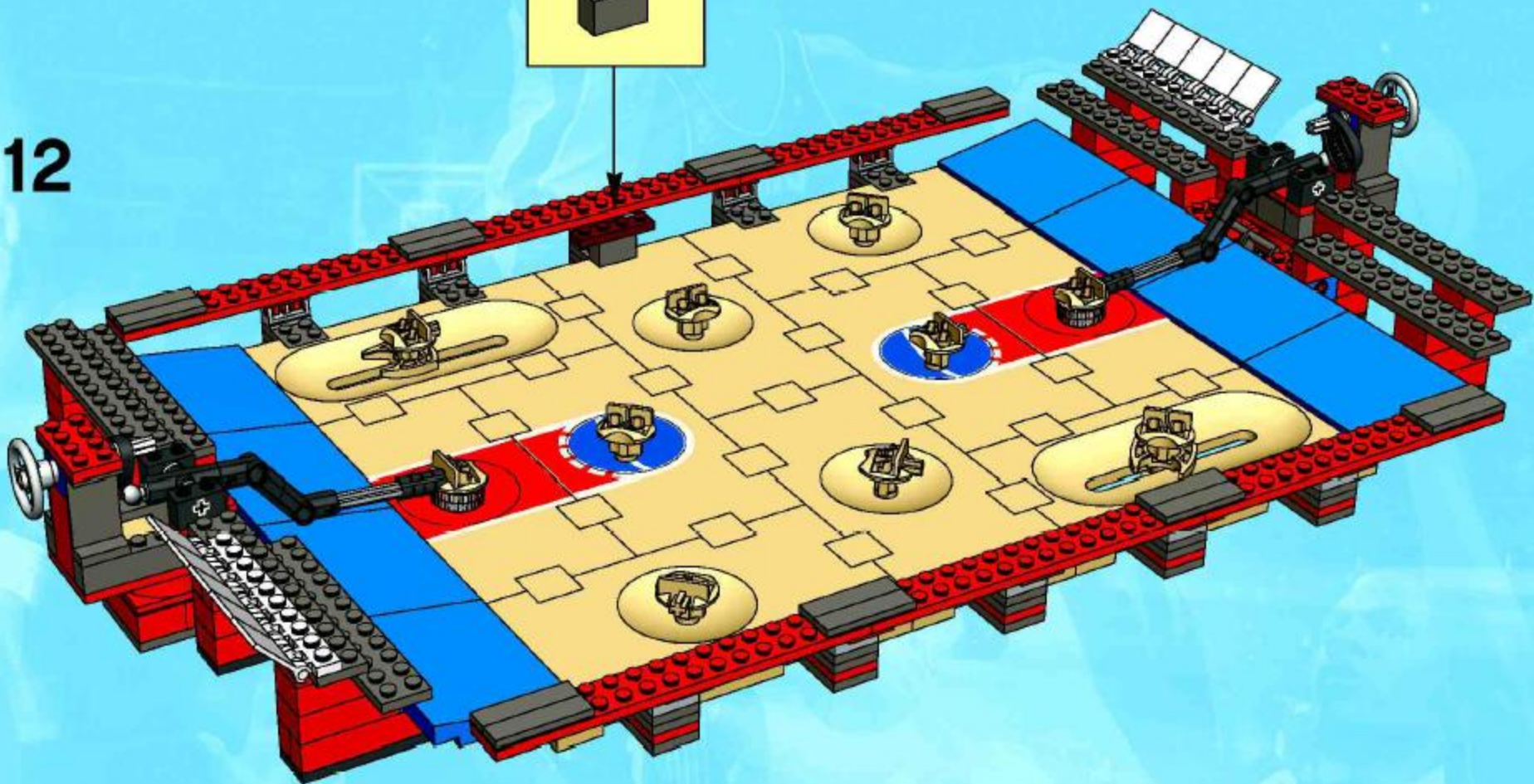
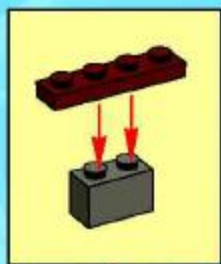

1



2



3



4



5



6

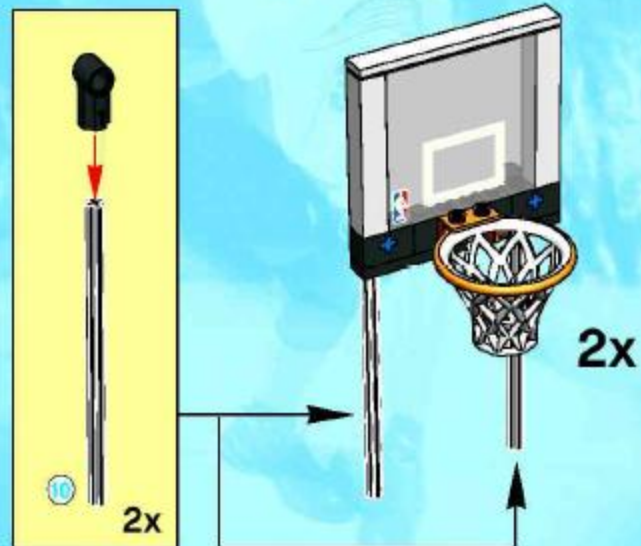

13



14





 www.LEGO.com

NBA  **.COM**



 **NBA**





#3428

#3428



#3427 + #3428





3427 + 3432

1



2

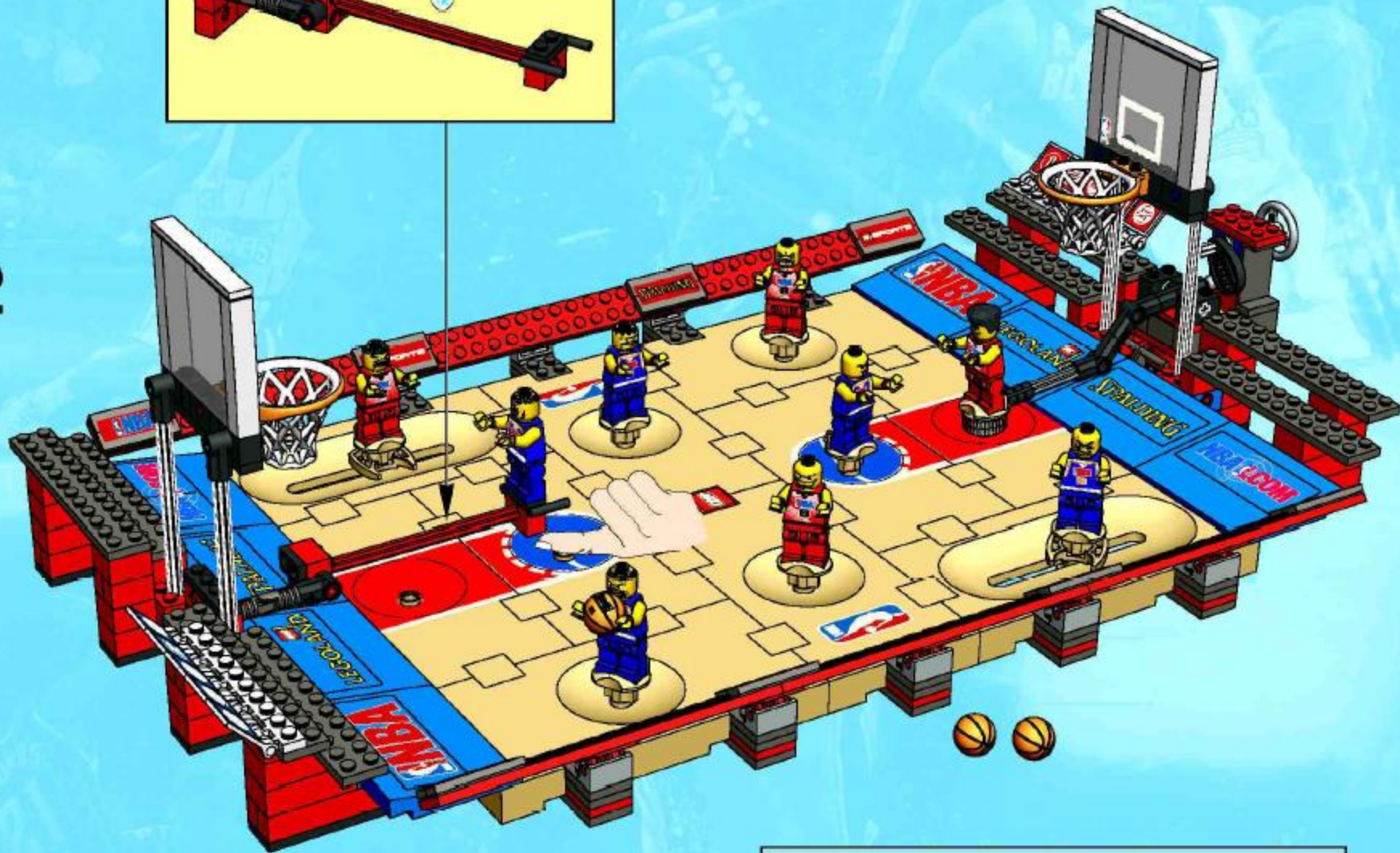
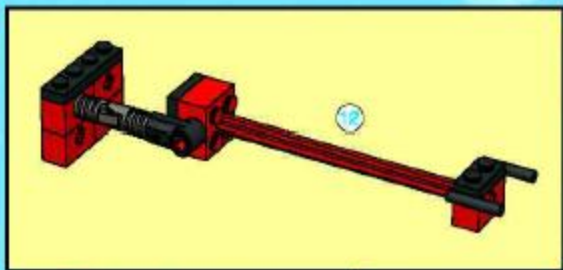

3429 + 3432

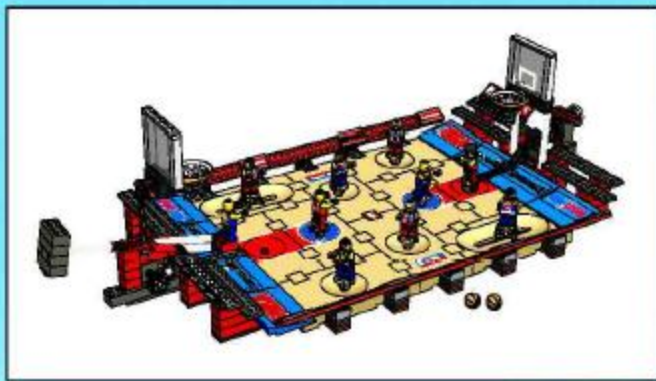

1

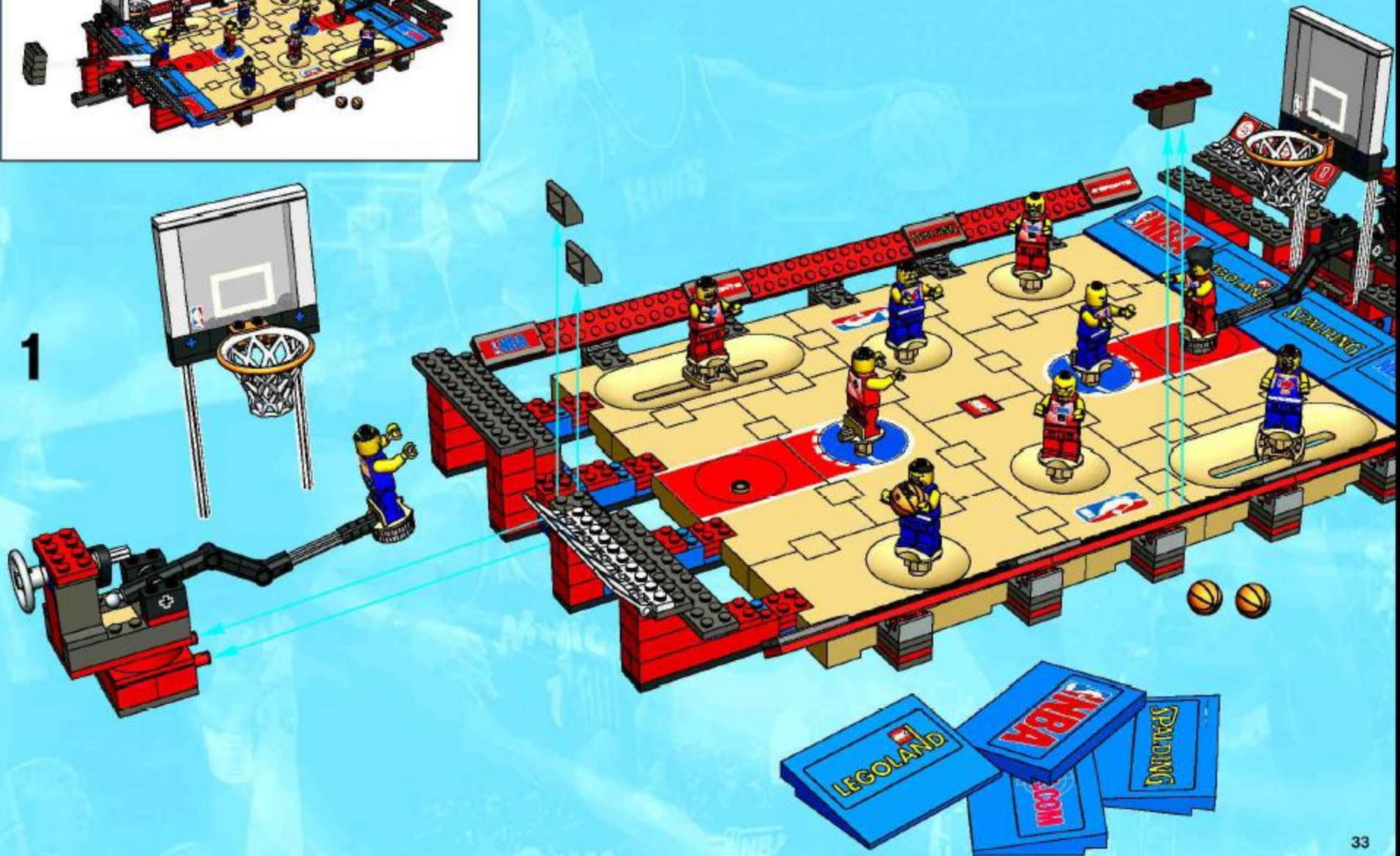

1



2

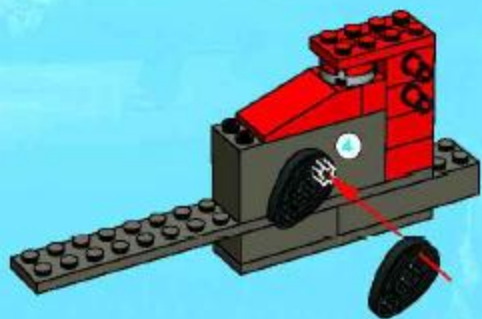

3

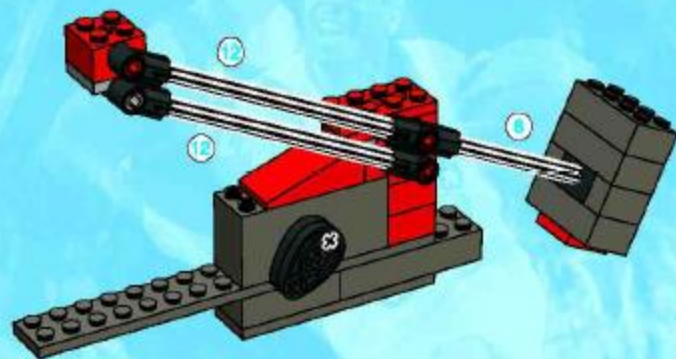

4

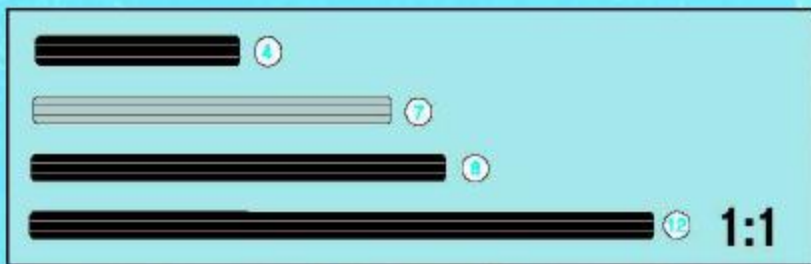
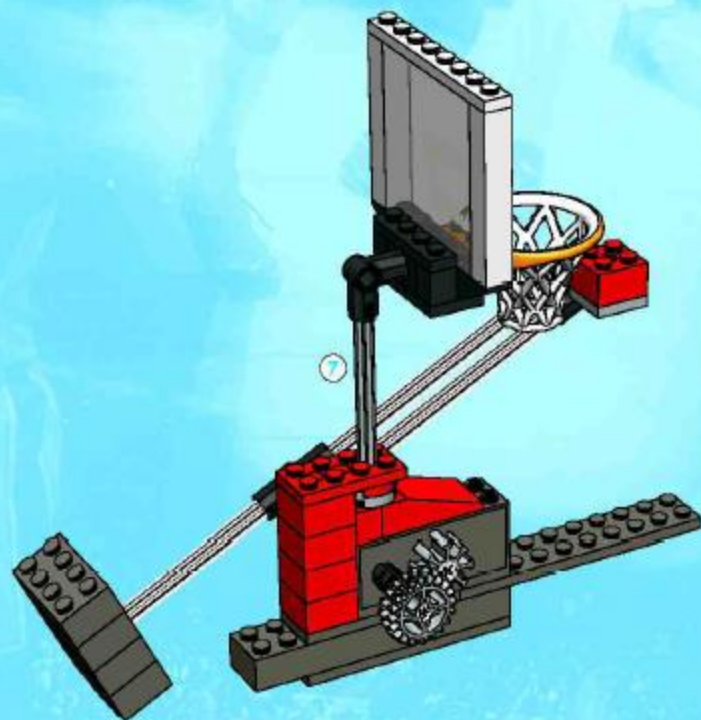

2



LEGO SPORTS

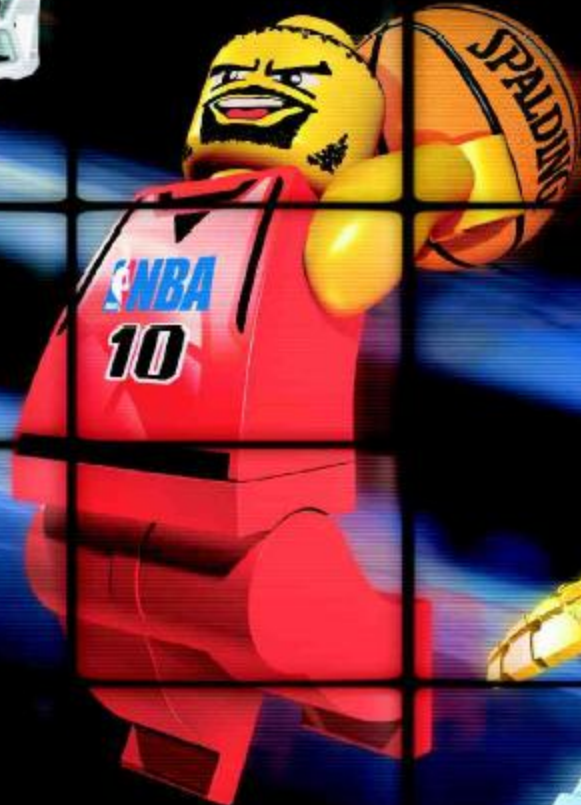

 www.LEGO.com

SPALDING is a trademark of Spalding Sports Worldwide, Inc. or Liaco Sports, Inc., a Spalding affiliate. © Spalding Sports Worldwide, Inc. 2002

adidas, the adidas logo and the three stripe trademark are registered trademarks of the adidas-Salomon group, used with permission. Fevernova and the Trigon logo are trademarks of the adidas-Salomon group, used with permission.

LEGO and the LEGO logo are trademarks of the LEGO Group. ©2002 The LEGO Group.

NBA identifications depicted are the exclusive property of NBA Properties, Inc. and/or the NBA Member Teams, and are used with permission.