

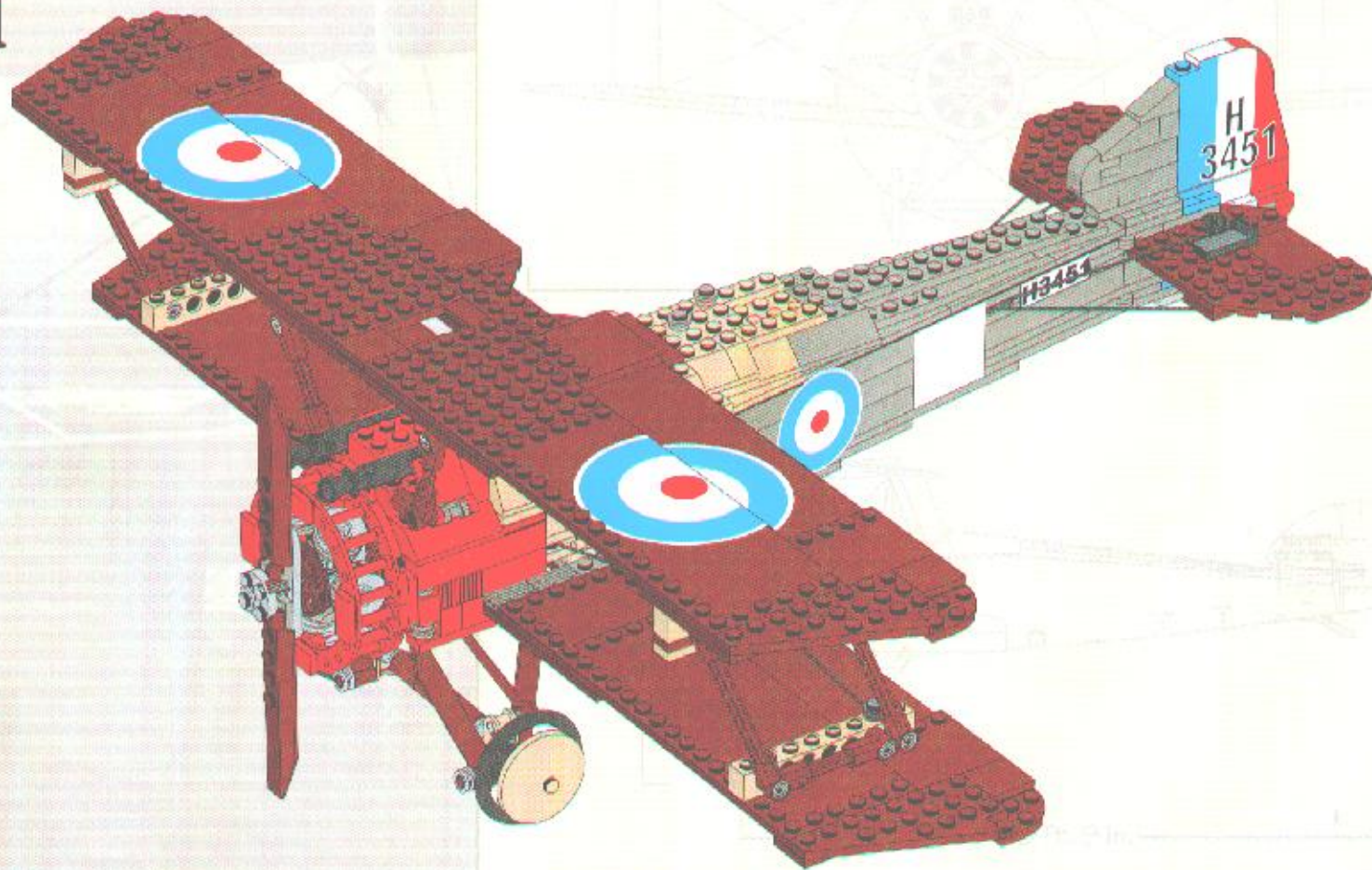

SOPWITH CAMEL

3451

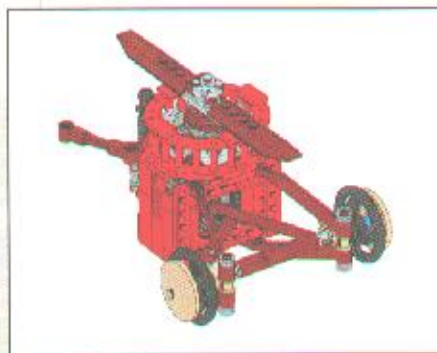



1

Engine power: 150 hp
Maximum speed: 115 mph at 6,500 ft.
Service ceiling: 19,000 ft.
Endurance: 2 hours 30 minutes

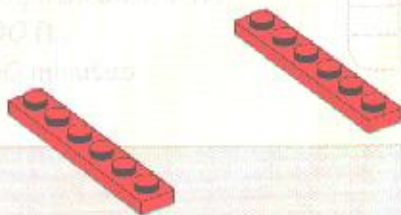

2

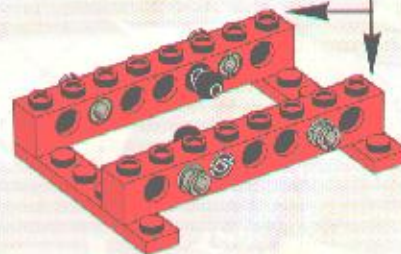
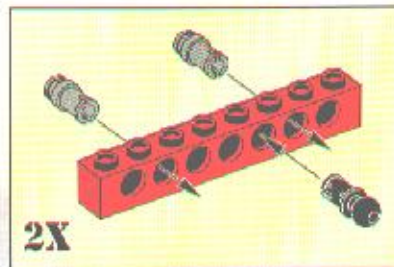

3

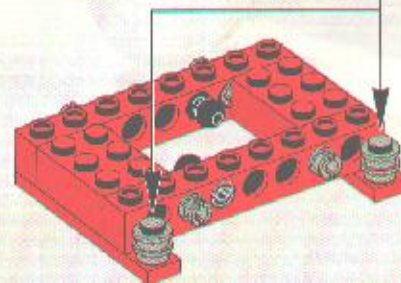

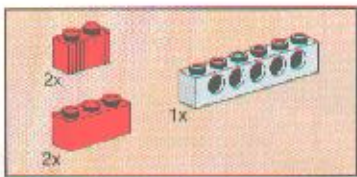

4

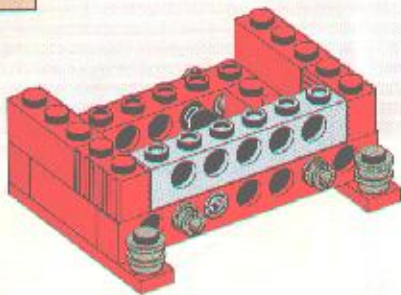

5

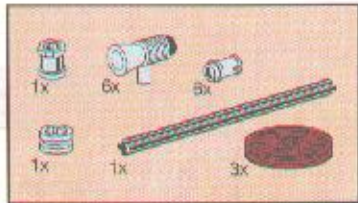
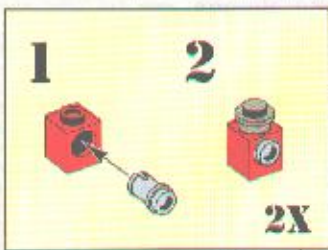
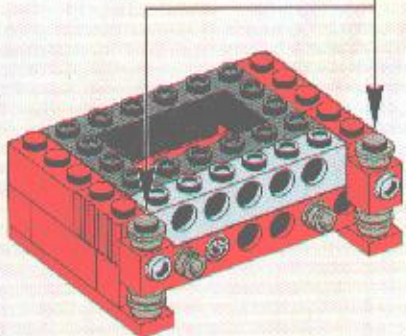

6

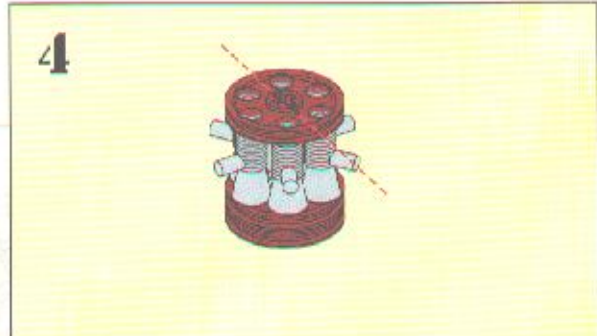
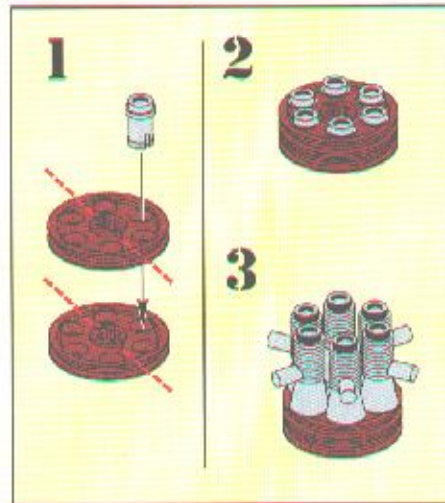

4



5

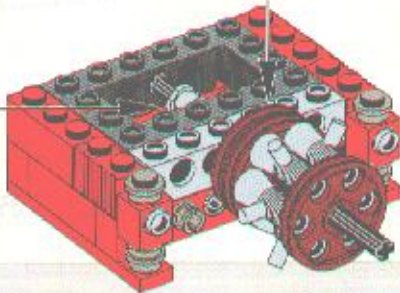
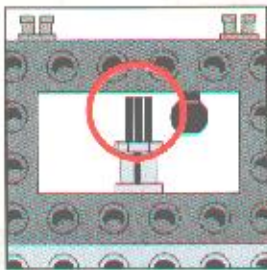
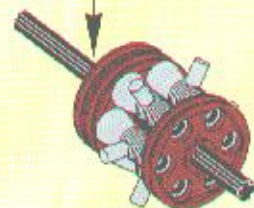

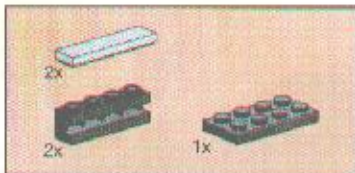

7

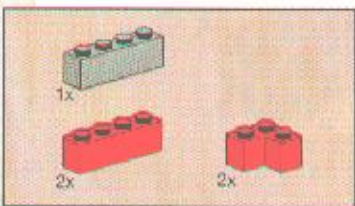
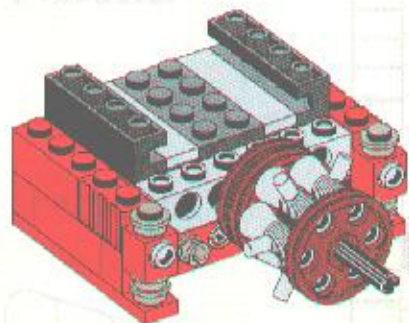

8

Max weight: 1.455 lbs
 Engine power: 130 hp
 Maximum speed: 117
 Service ceiling: 10,000
 Endurance: 2 hours

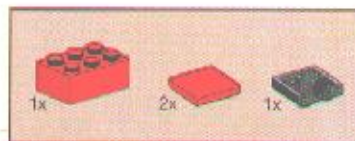
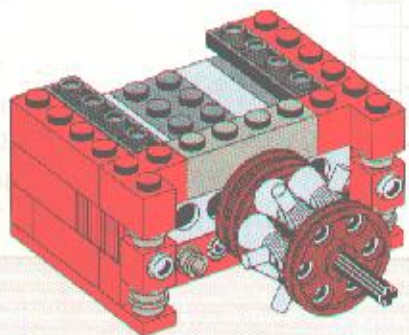

9

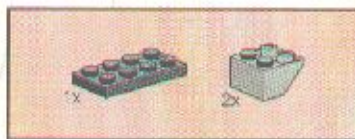
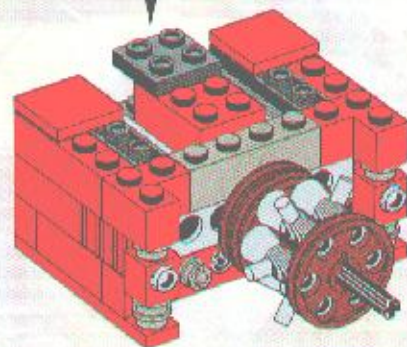
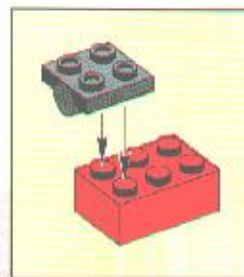

10

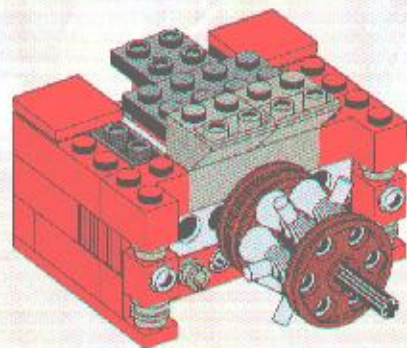



11

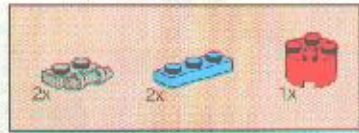
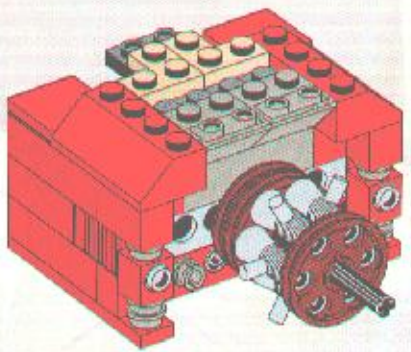

12

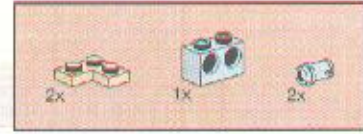
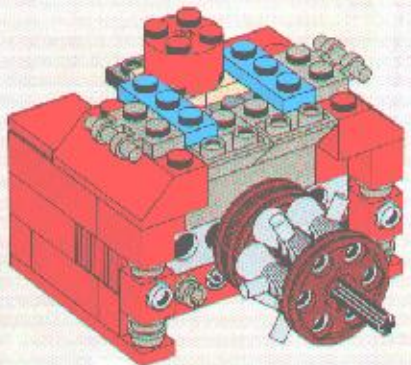

13

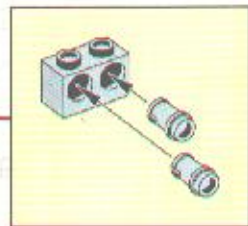
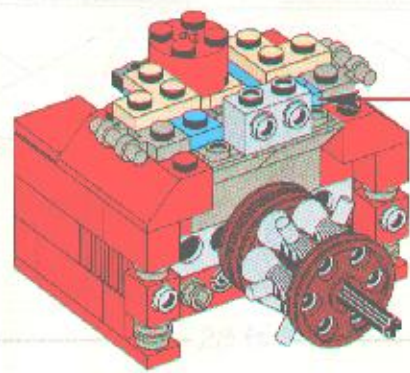

14

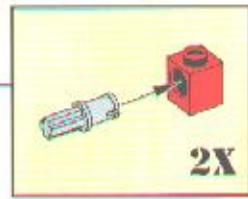
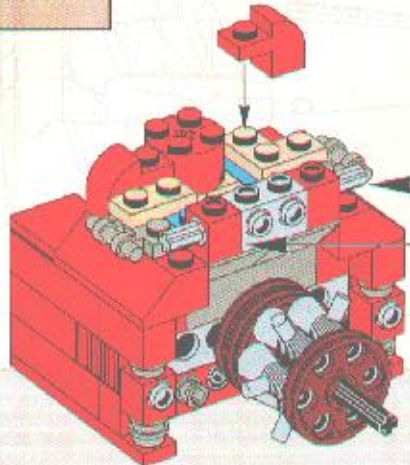

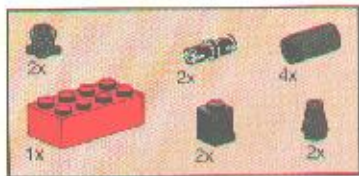

15

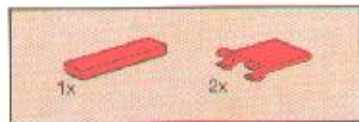
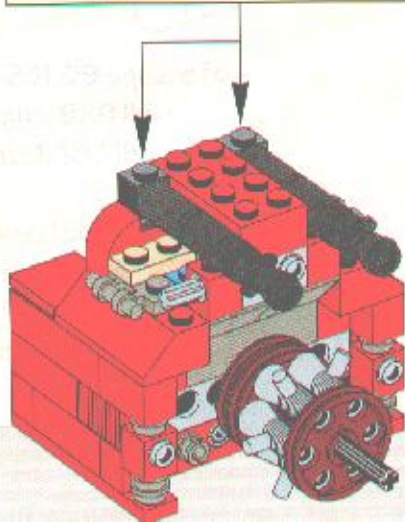
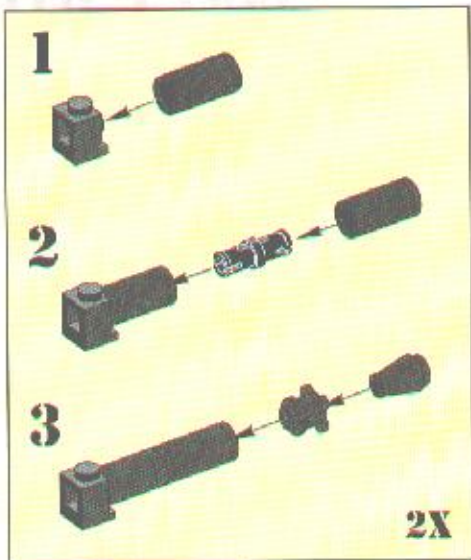

16

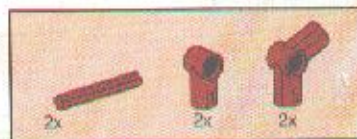
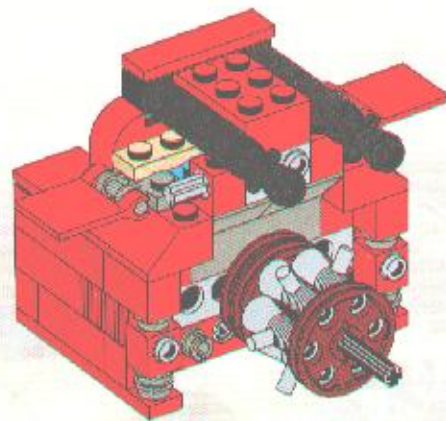

17

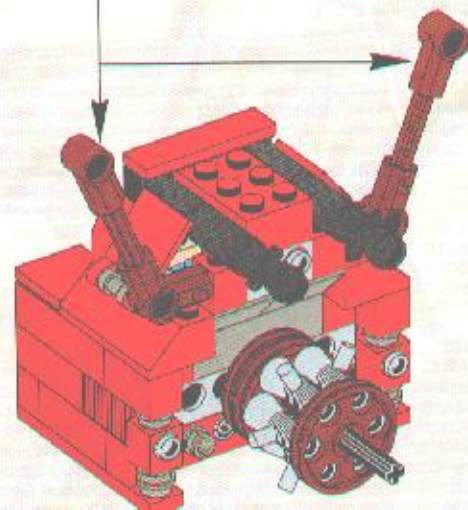
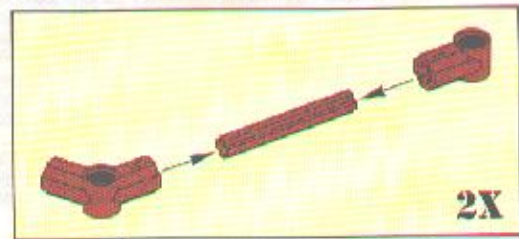

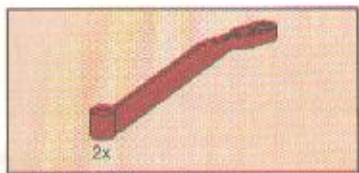

18

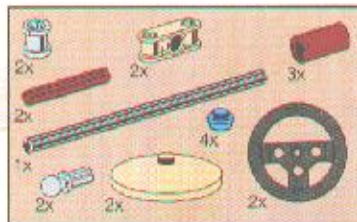
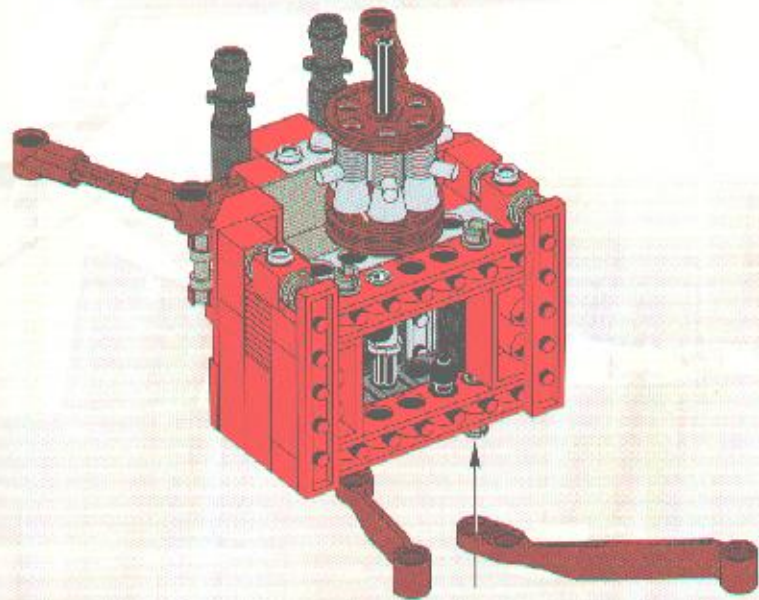

19

1

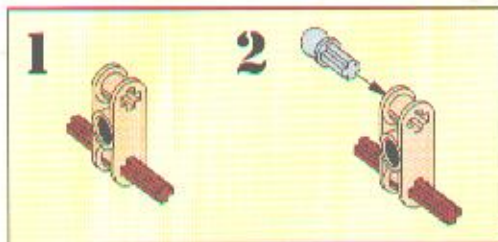
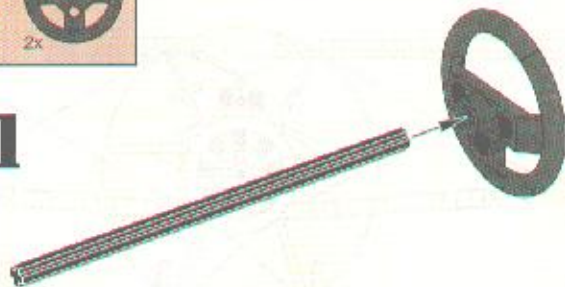

2

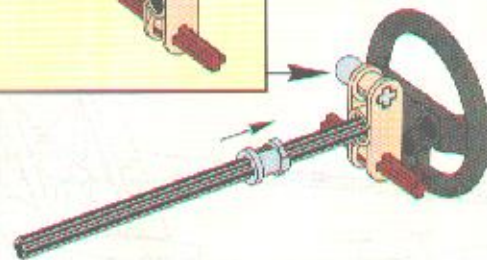

3

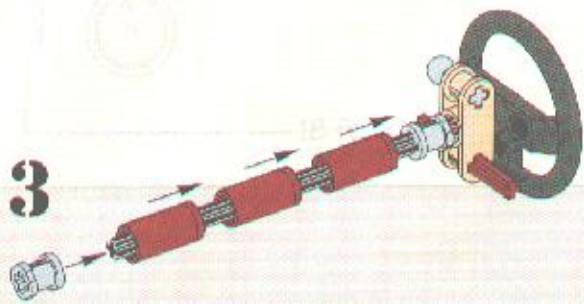

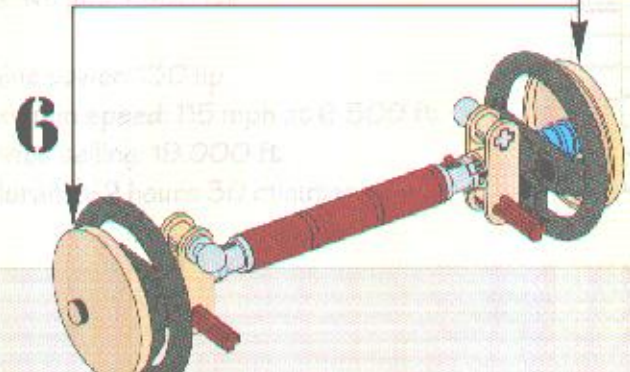
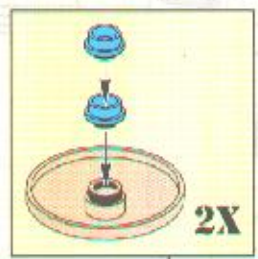
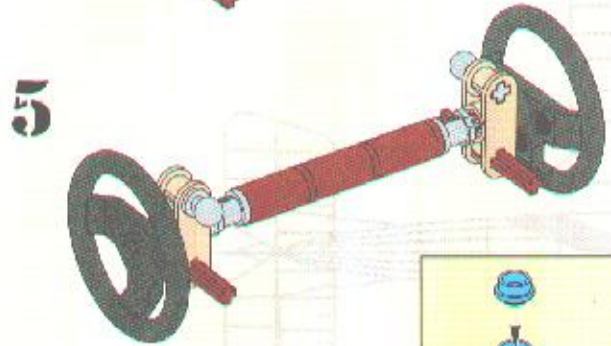
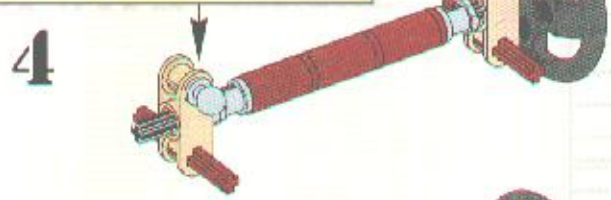
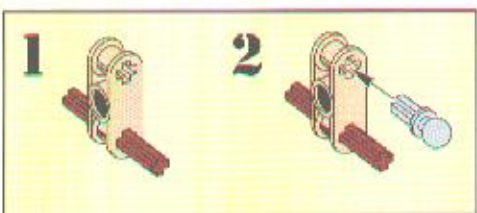

Wing area 251.09 square ft
 Empty weight 120 lb
 Max. weight 1,320 lb

Engine power 30 hp
 Max. speed 115 mph at 6,500 ft
 Cruise speed 100 mph
 Endurance 1 hour 30 min

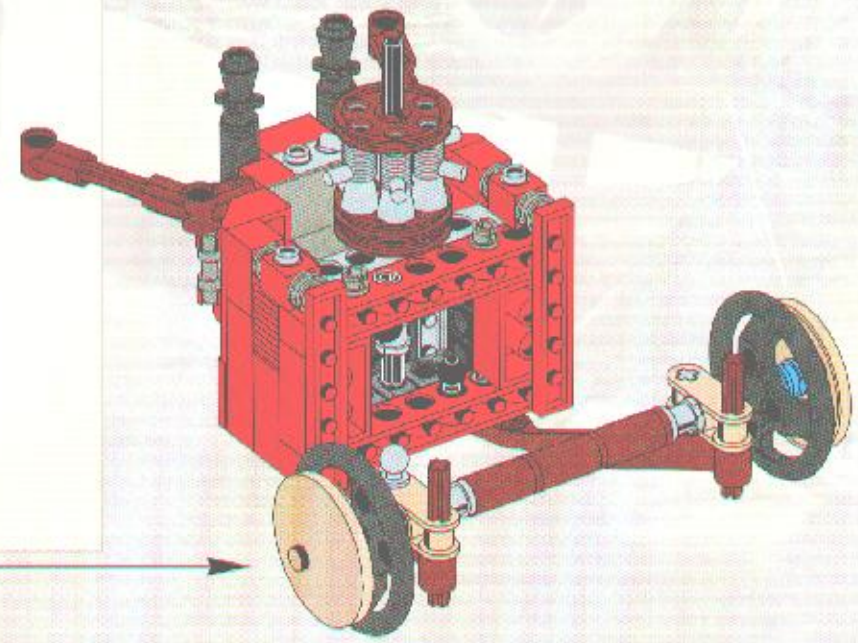



20

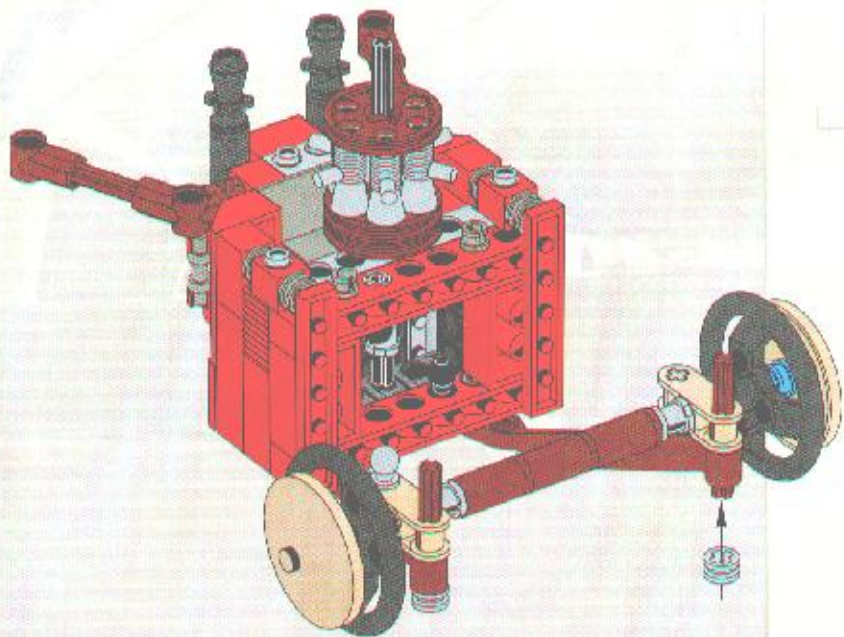

21

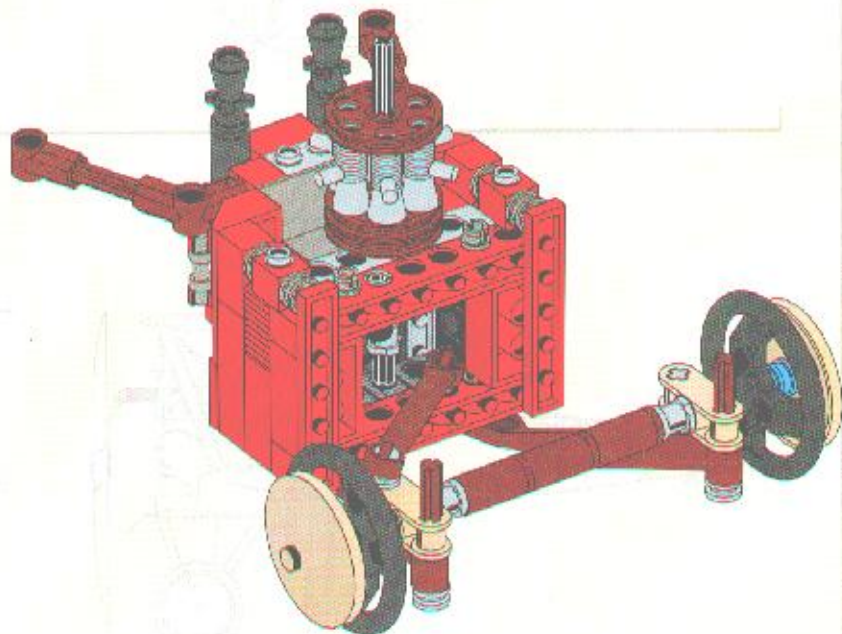



22

OPWIJD "CAMEL"

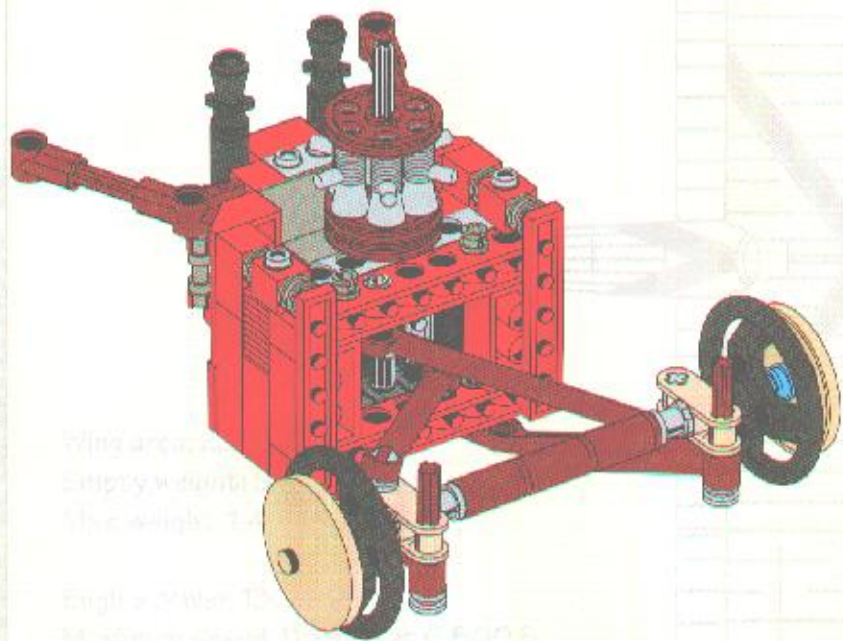

Wing area: 1.2 m²
 Empty weight: 1.2 kg
 Max. weight: 1.5 kg

Engin: 2 Watt T
 Maximum wind: 10 m/s (0.500 Pa)
 Speed: 0.1 m/s (1.000 Pa)
 Efficiency: 2 x 30 = 60 minutes



23

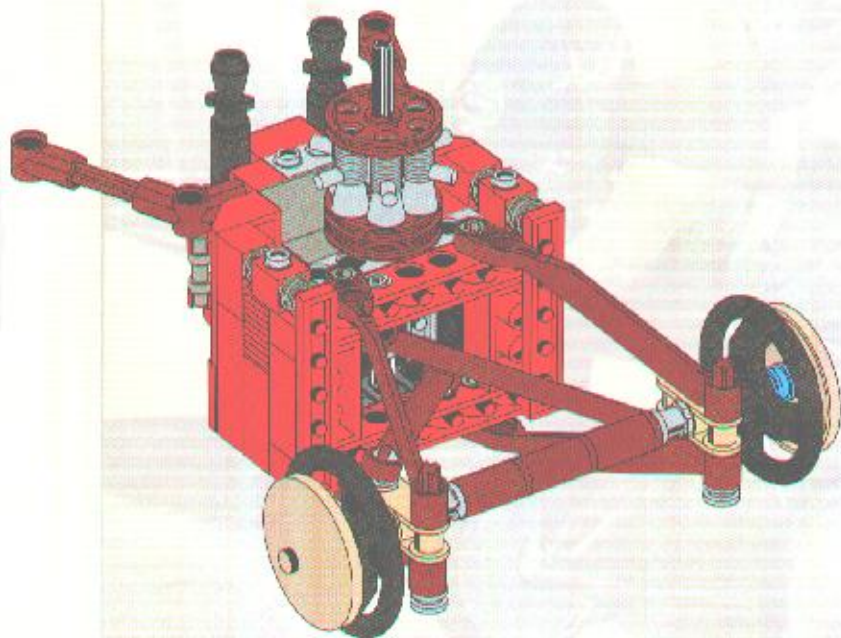



24

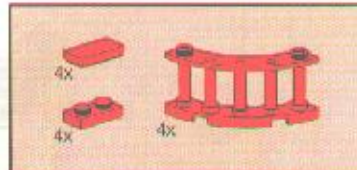
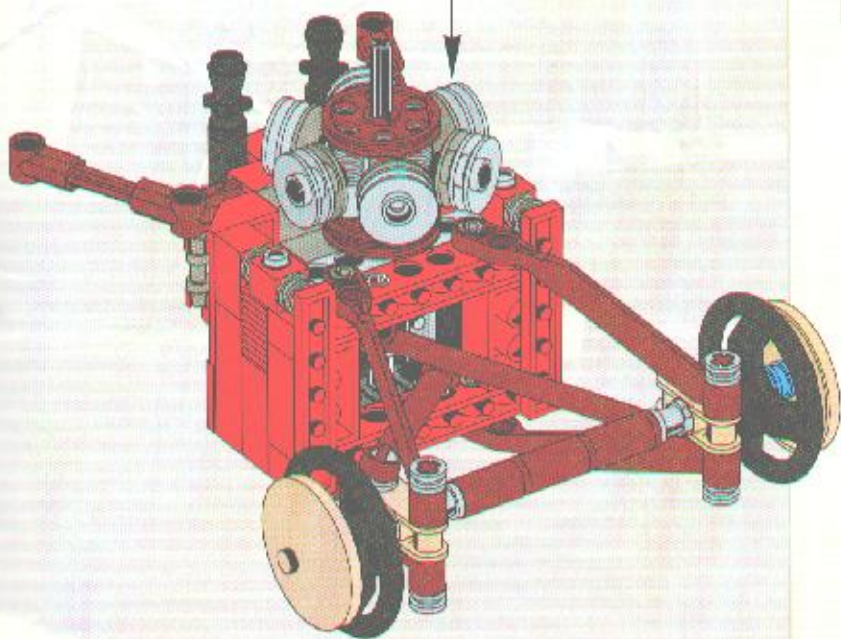
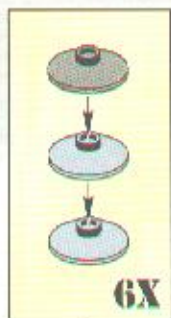

25

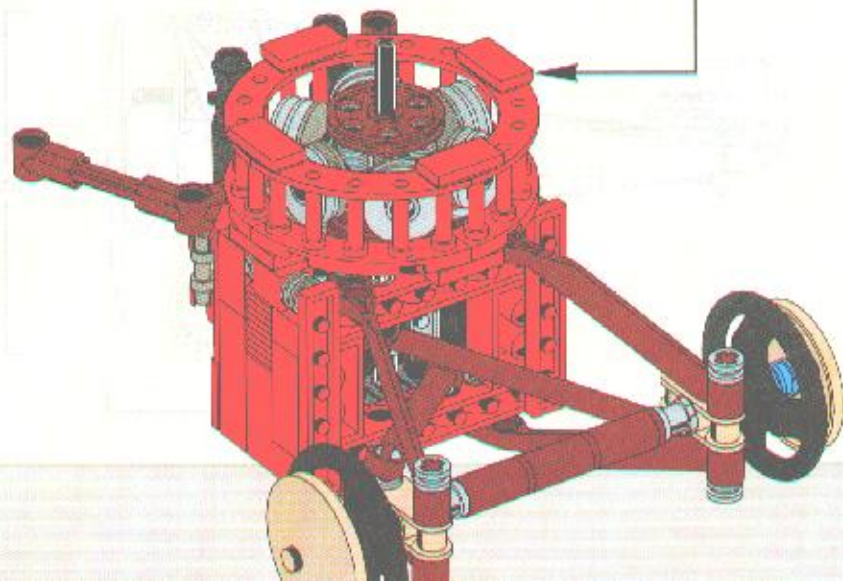
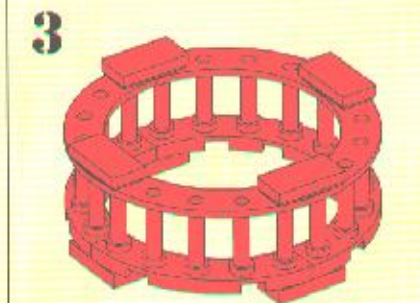
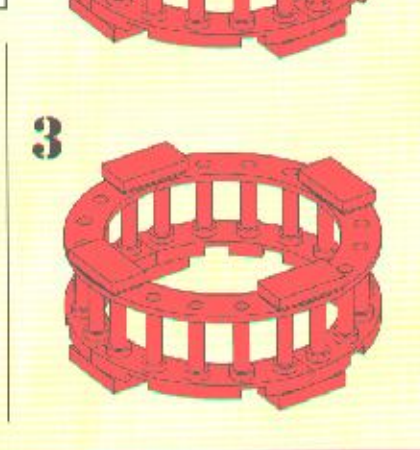
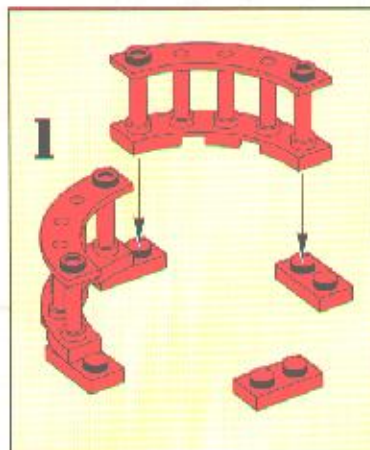

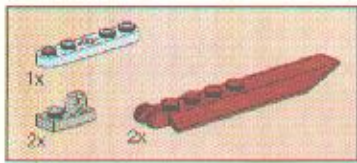

26

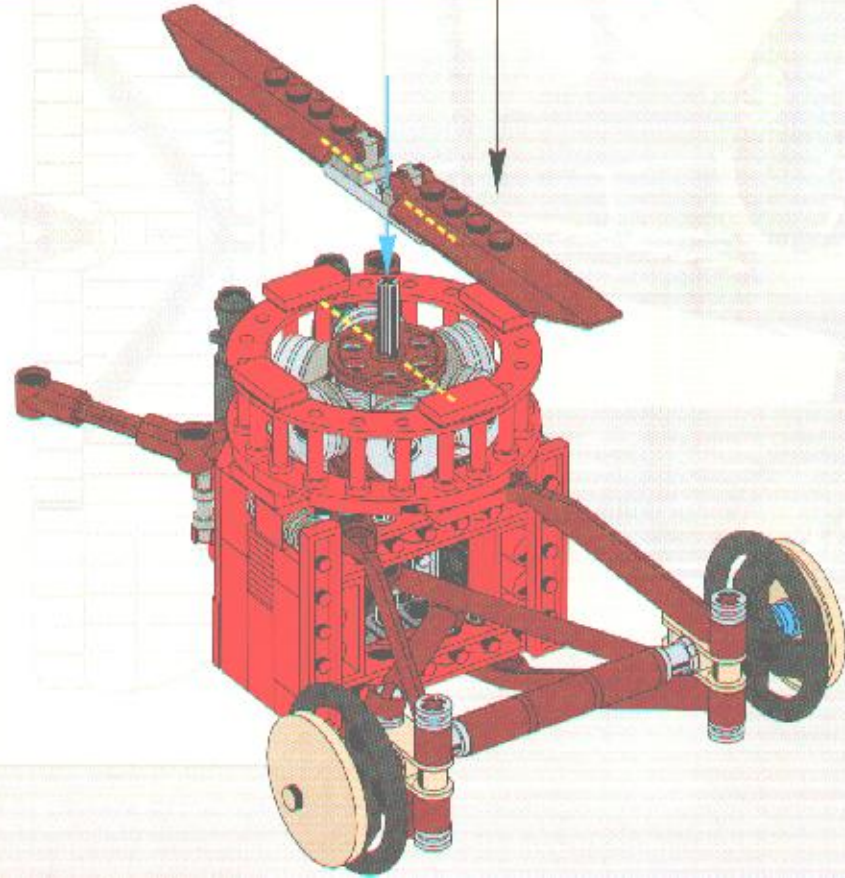
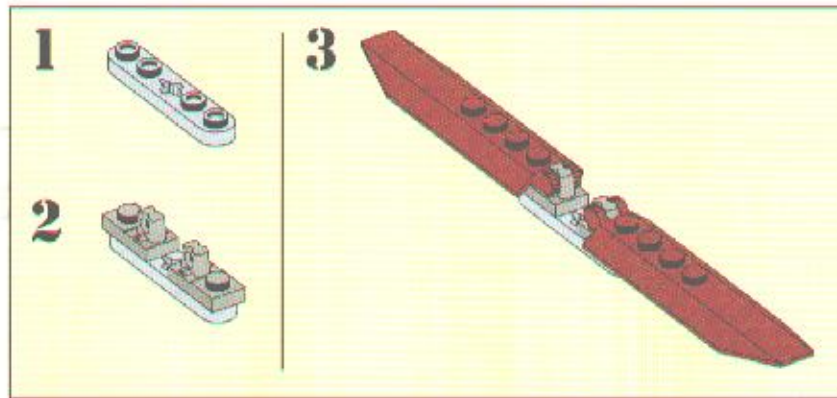

Motor: 3.3" square
 motor: 12V
 Motor: 1.5A

Motor: 12V
 Motor: 1.5A
 Motor: 1.5A
 Motor: 1.5A



27

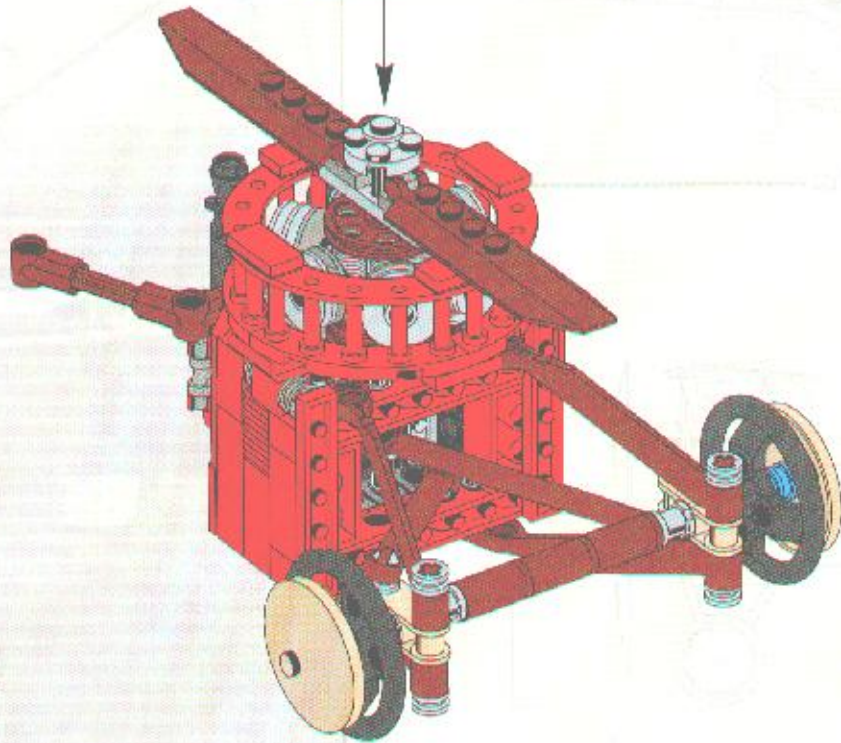

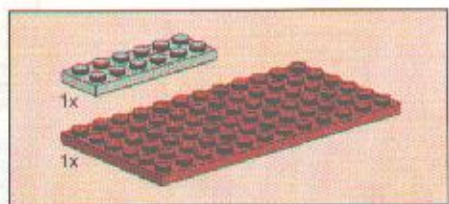
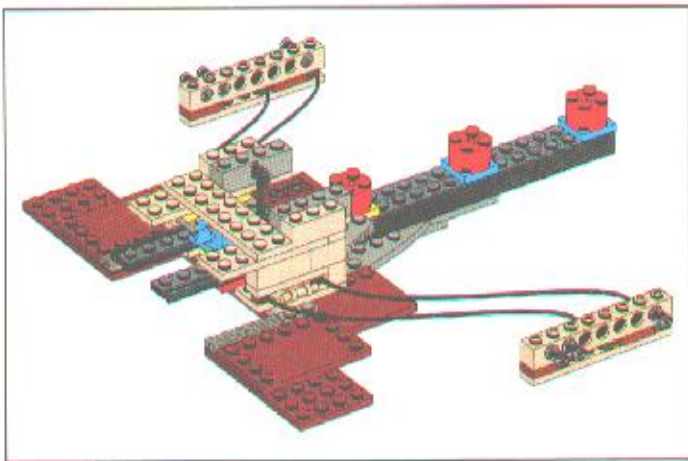

1

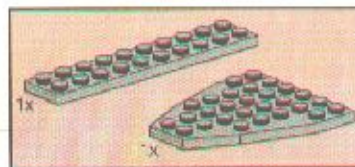

2

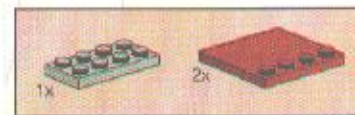
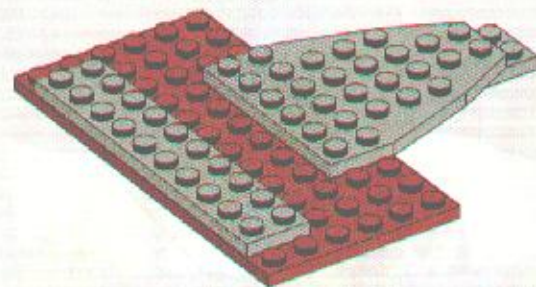

3

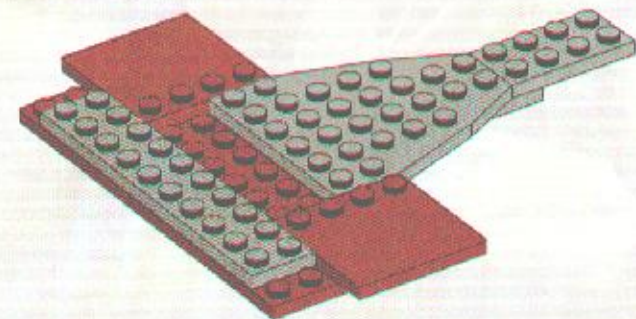

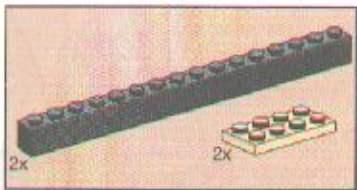

4

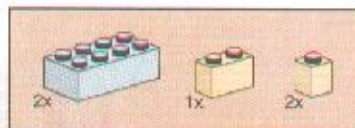
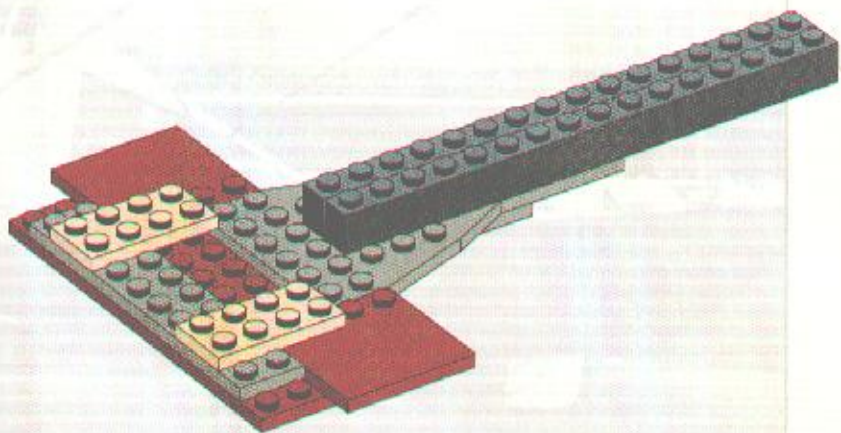

5

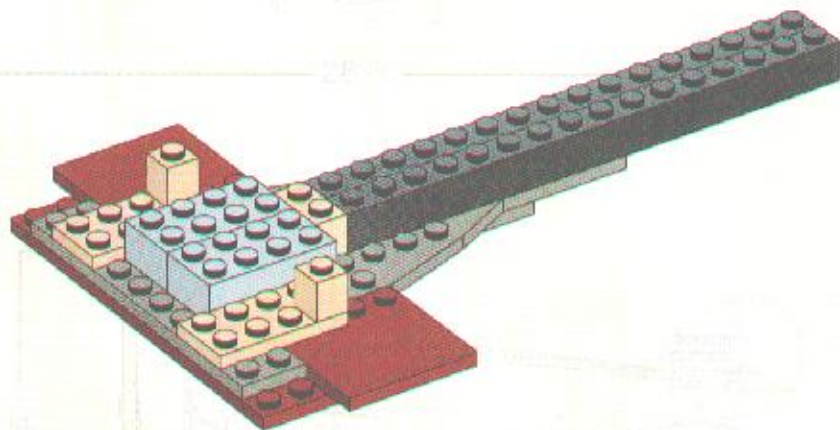

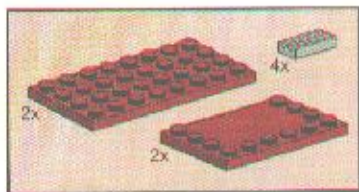

6

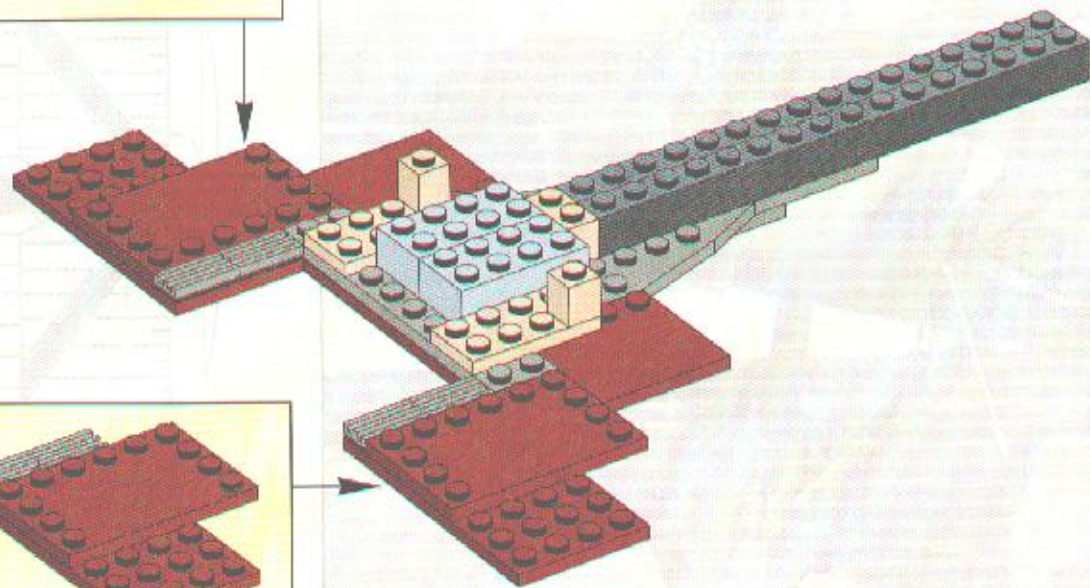
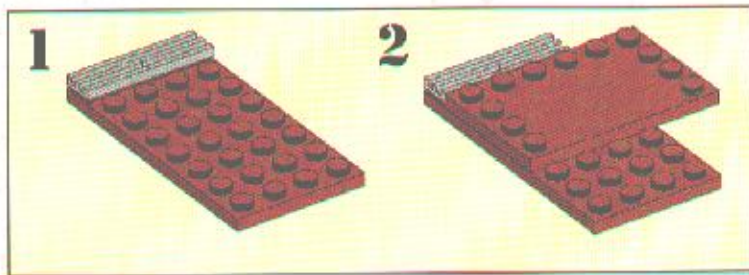
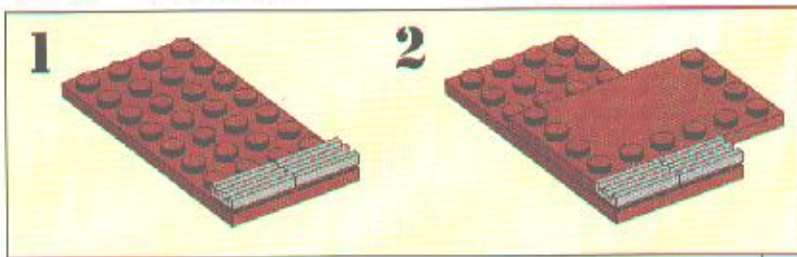

Wing area: 23.50 square ft.
Empty weight:
Wing weight: 1
Empty weight:
Wing weight: 1
Service ceiling:
Maximum speed:



7

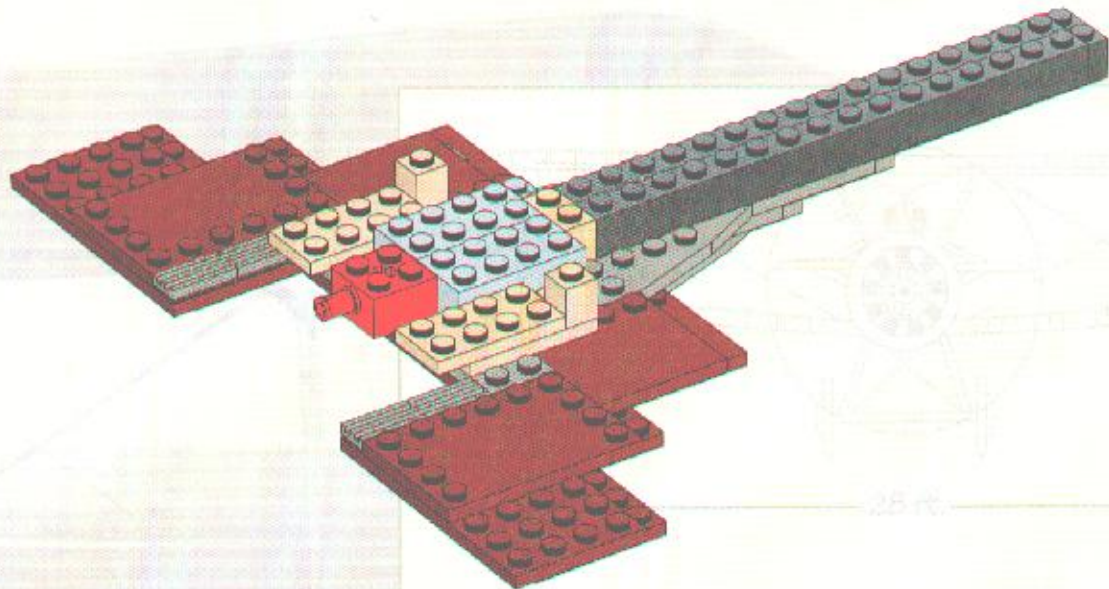

8

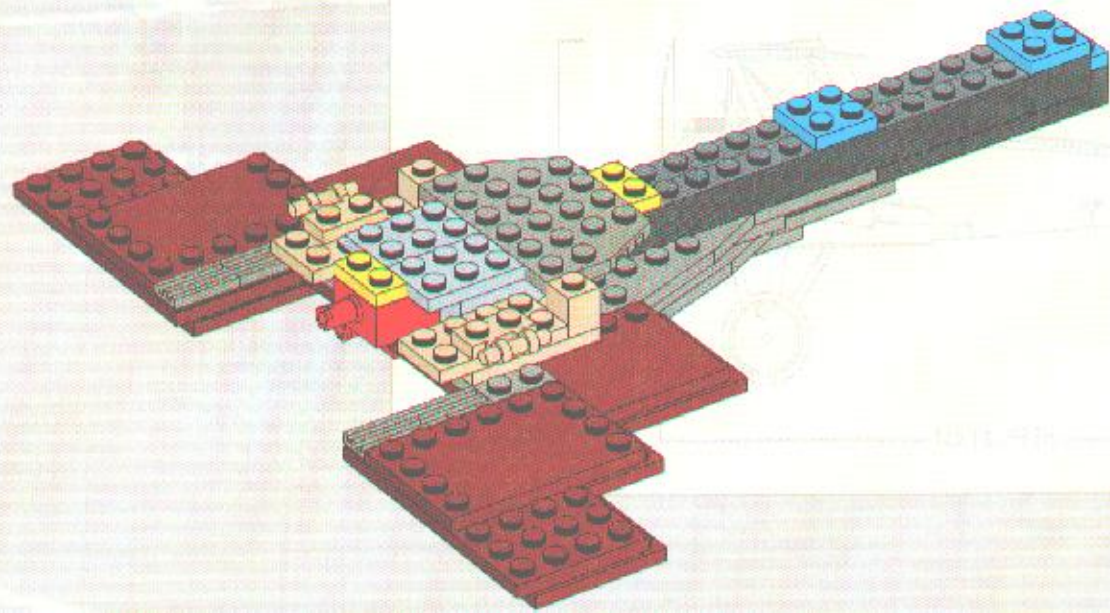

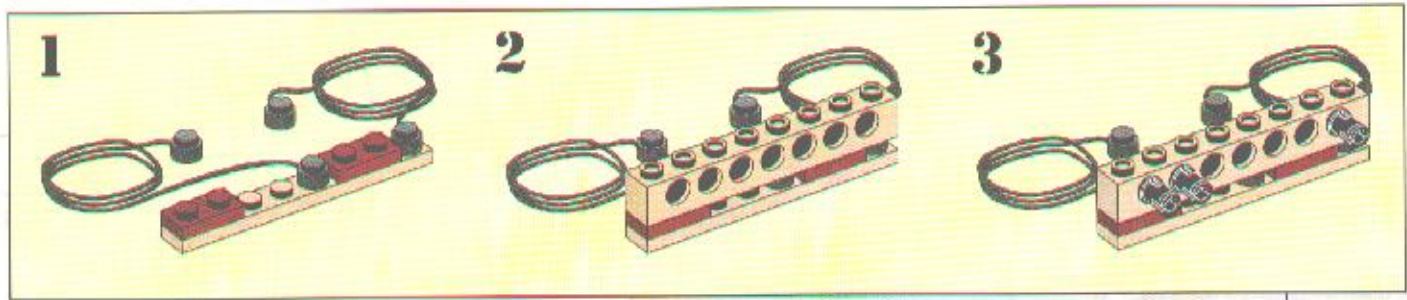
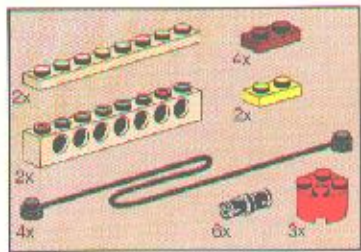

9

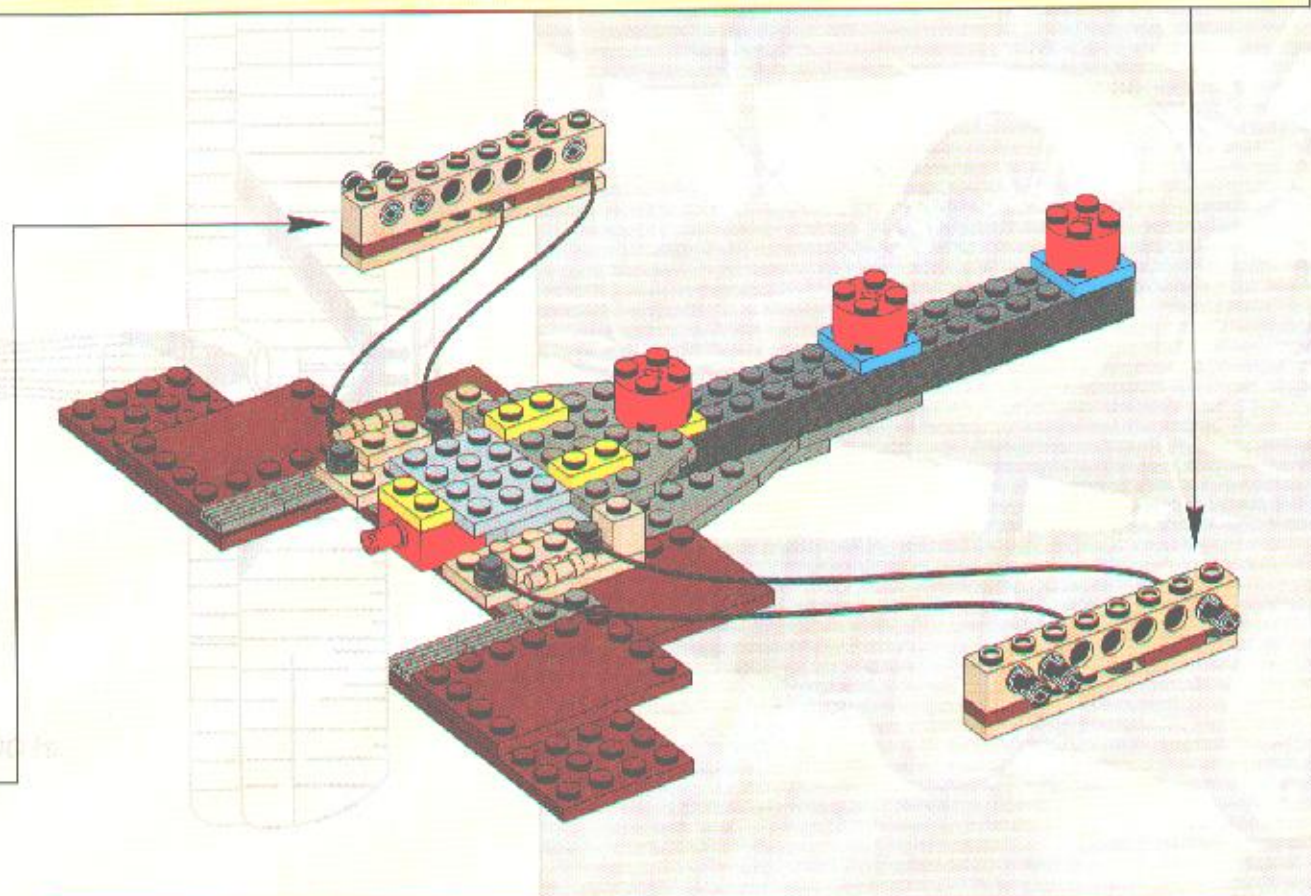
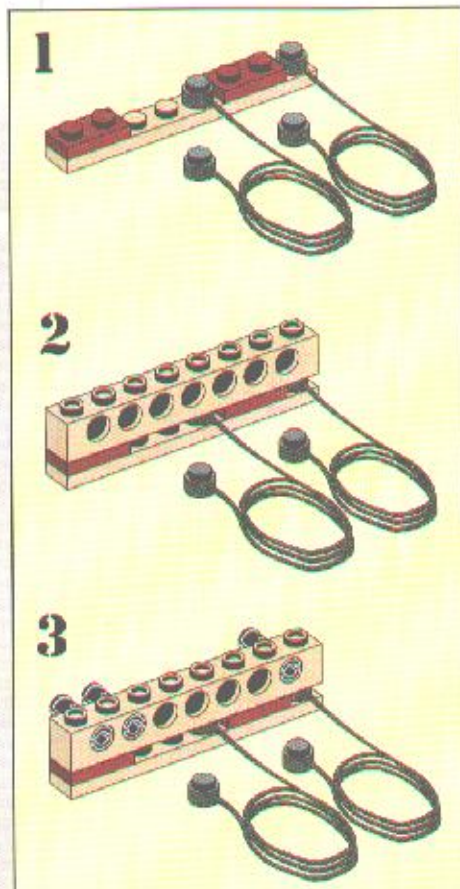

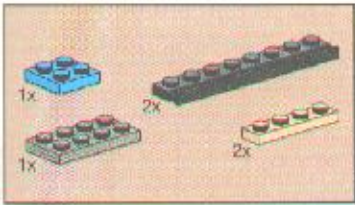

10

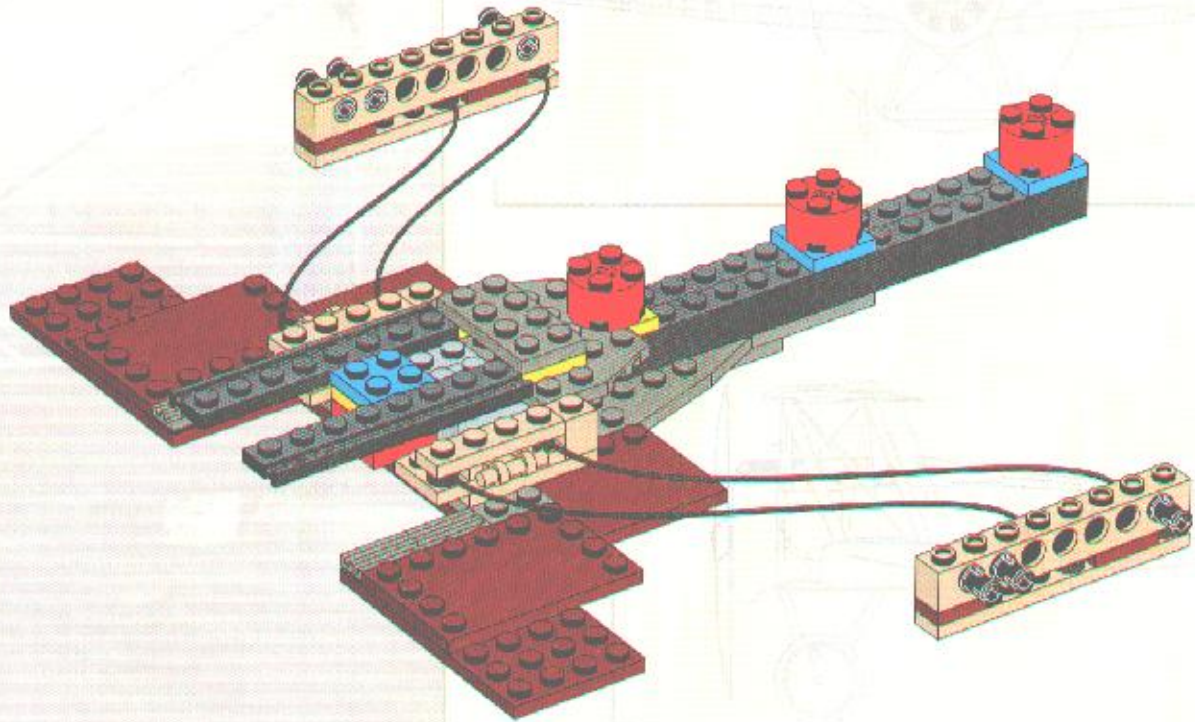

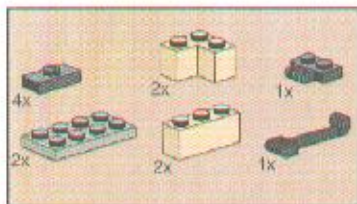

11

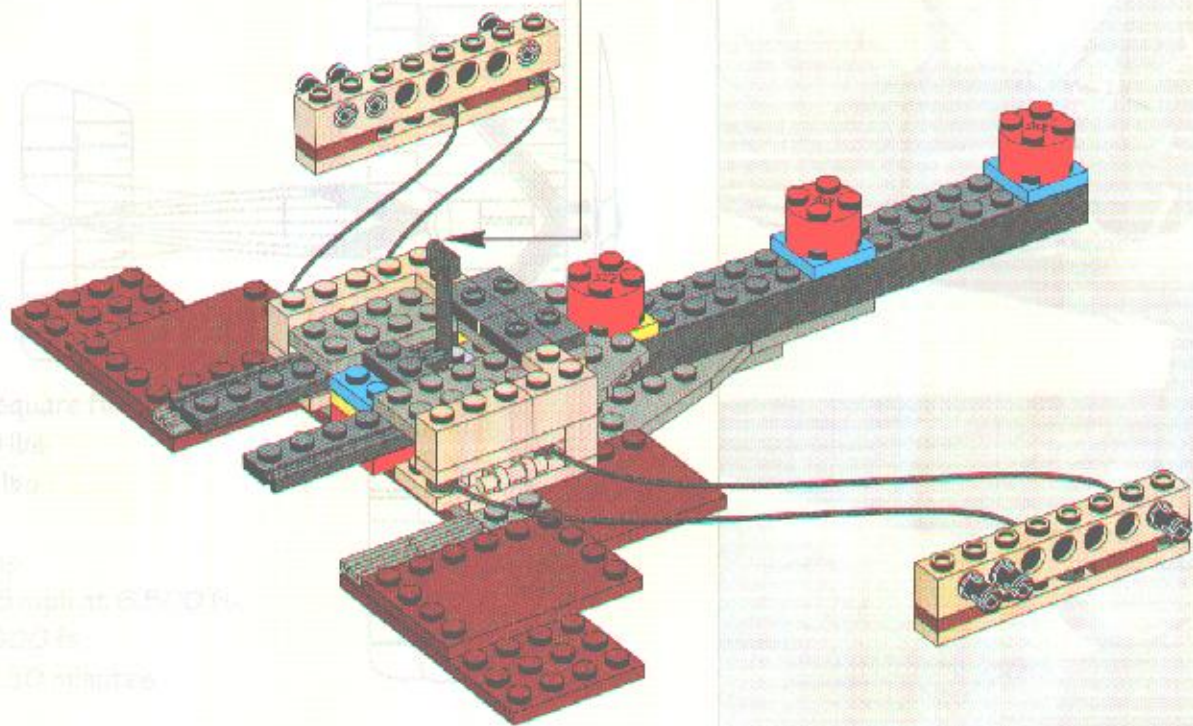
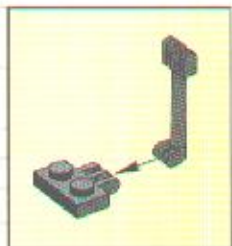

Wing area: 251.00 square ft
 Empty weight: 923 lbs
 Max weight: 1,452 lbs

Engine power: 130 hp
 Revolution speed: 15 rpm at 65% RPM
 Service ceiling: 19,000 ft
 Endurance: 2 hours 30 minutes

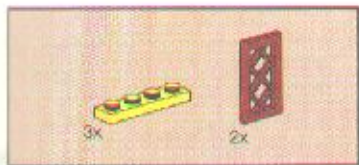

12

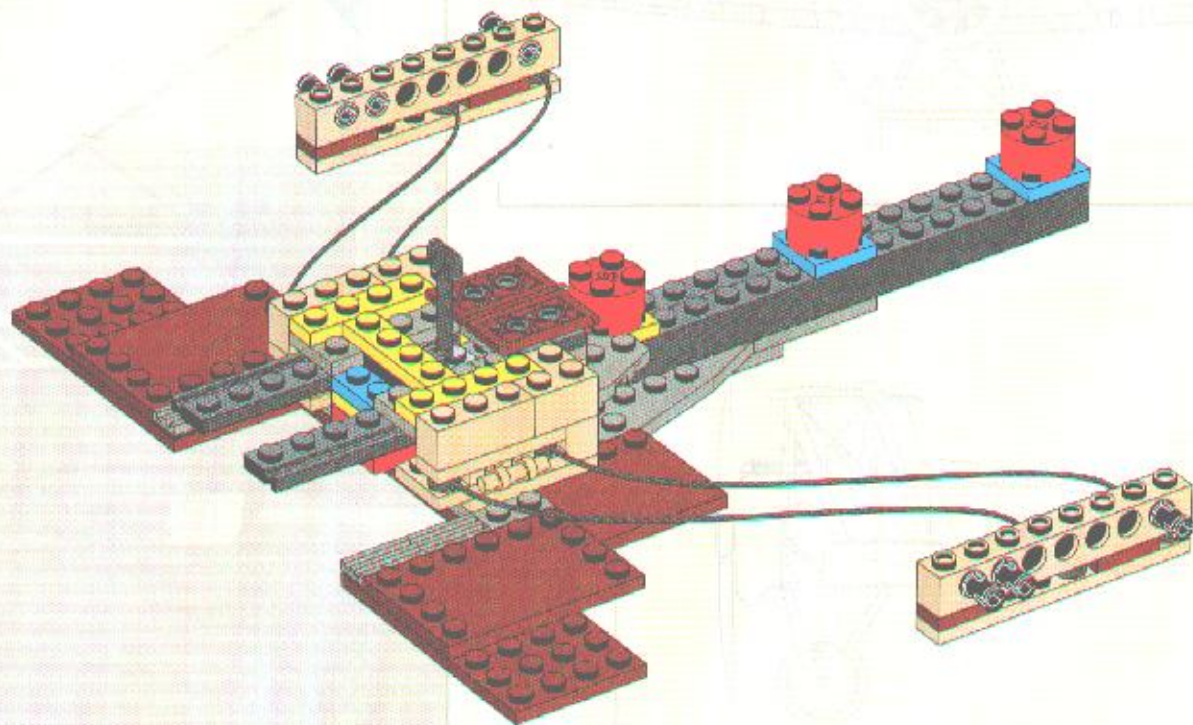

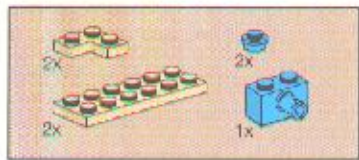

13

TOP WITH "CAMEL"

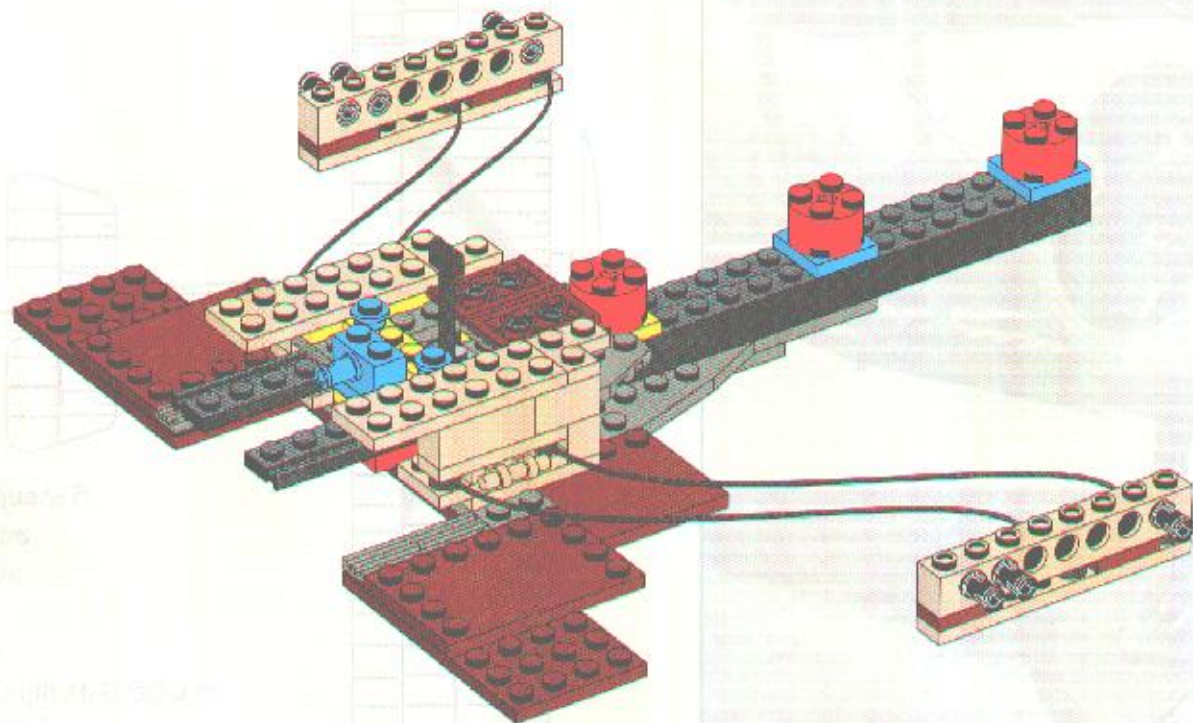

With one 3.0 square P
 empty wire 679 lbs
 Motor with 1403 lbs

1 light power 3.0 sec
 1x1 motor speed 45 with 6.5 502 lbs
 Motor rating 18 600 lbs
 Exclusion: 2 hours 30 minutes

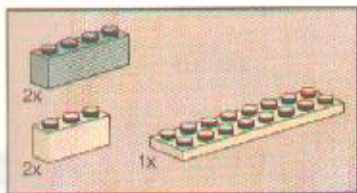

14

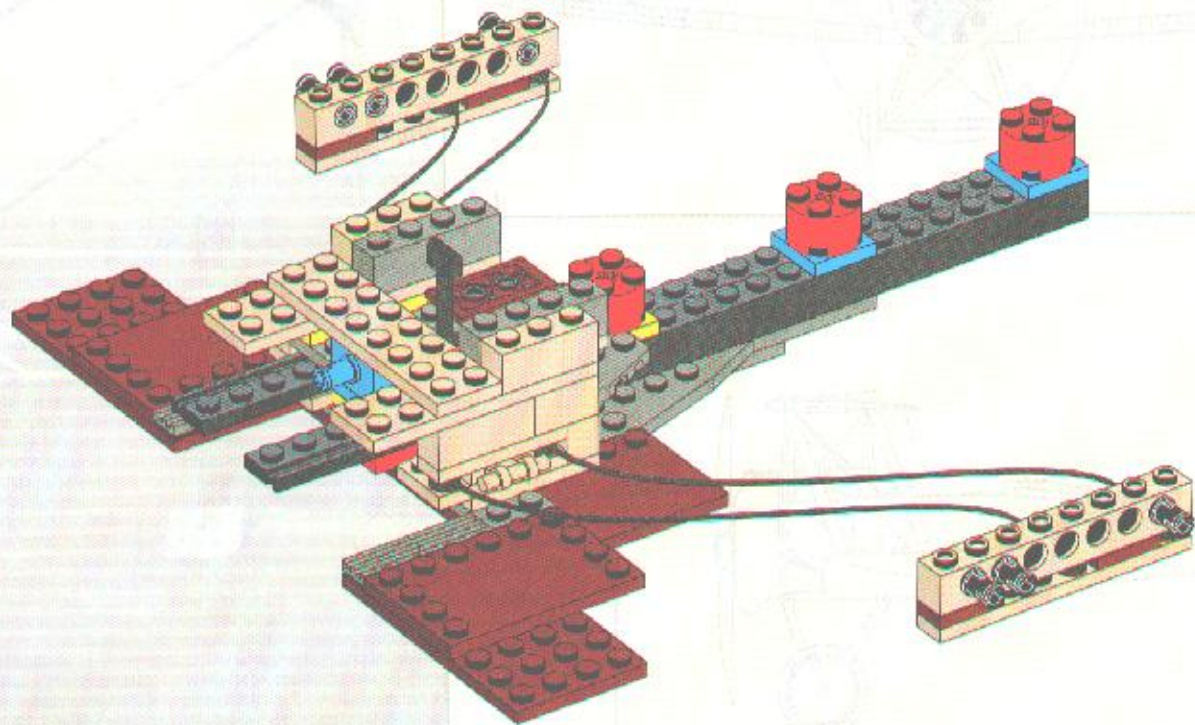

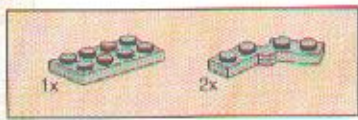
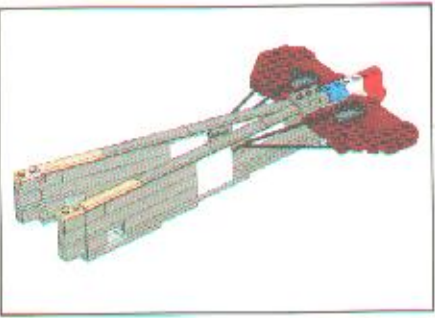

1

1x grey 1x6 Technic brick with hole
2x grey 1x3 Technic brick with hole

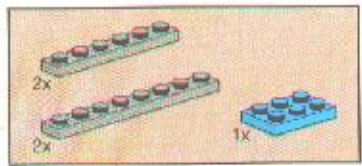
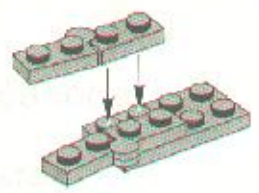

2

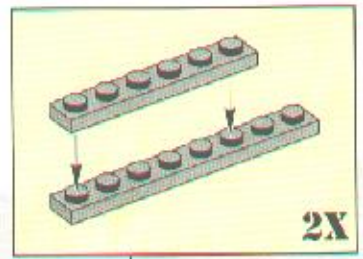

2X

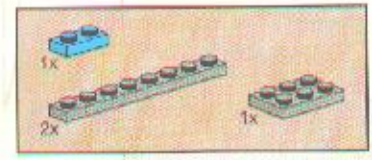

3

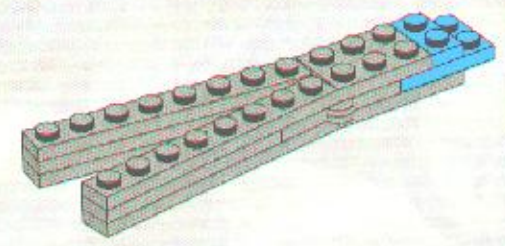
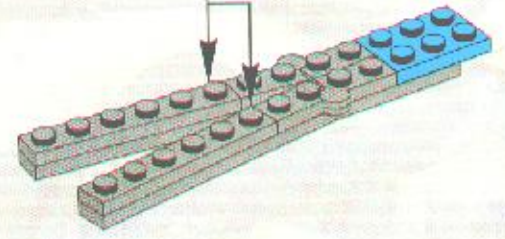

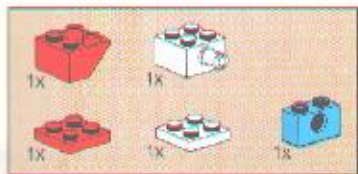

4

1

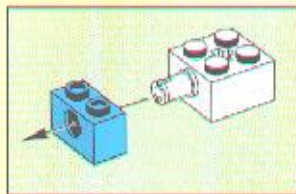
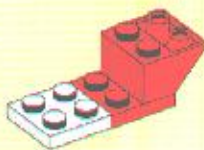

2

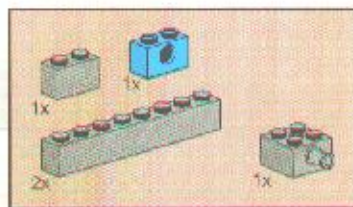
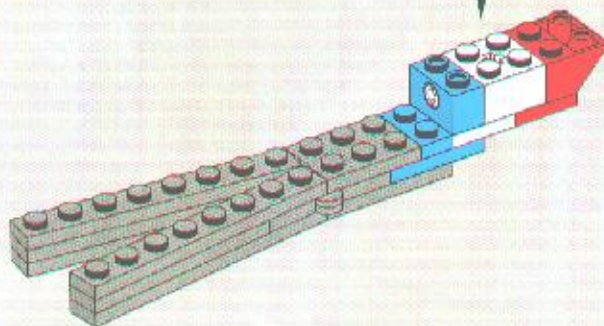

5

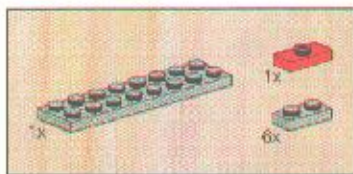
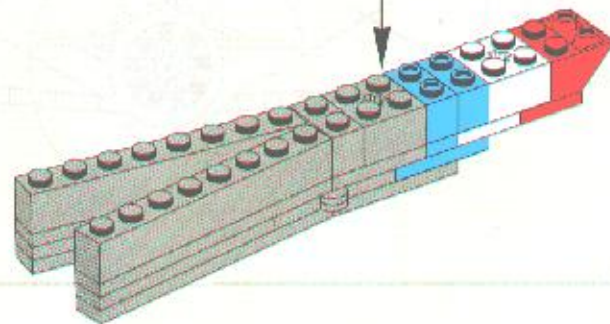
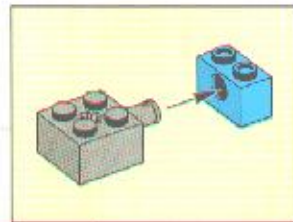

6

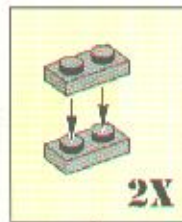

2X

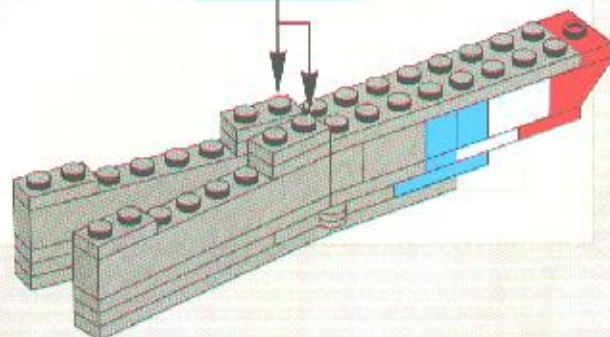

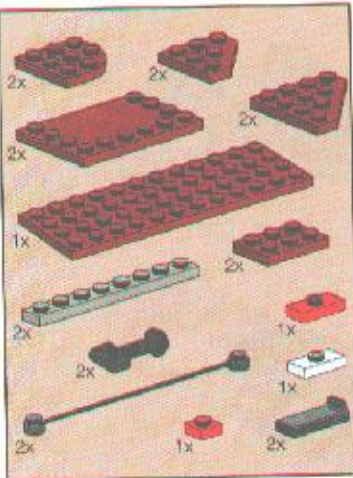

7

1

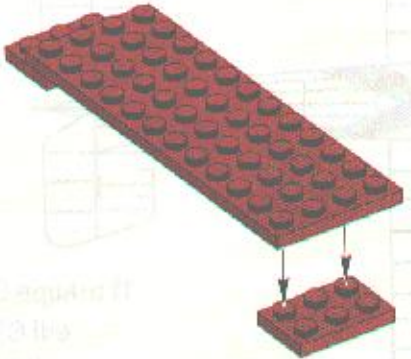

2

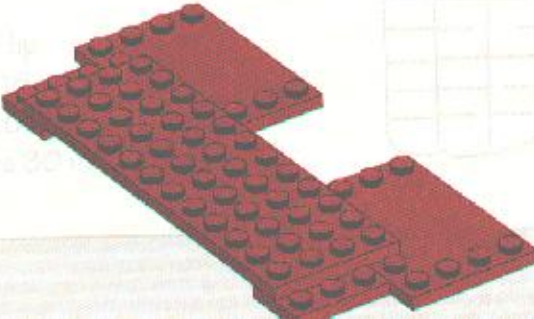

Wing area: 251,00 square ft
 Empty weight: 473 lbs
 Max. weight: 1,475 lbs

Engines power: 2 hp
 Maximum speed: 100 mph
 Service ceiling: 10,000 ft
 Endurance: 2 hours 30 min

3

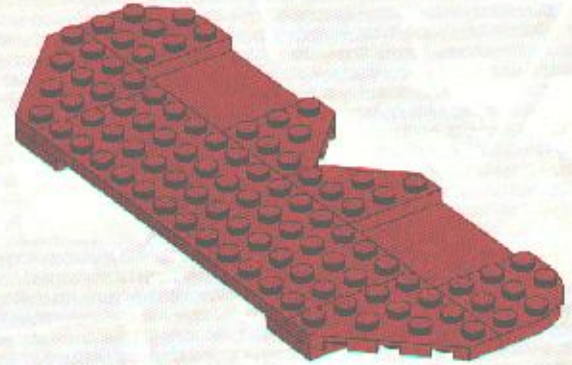

4

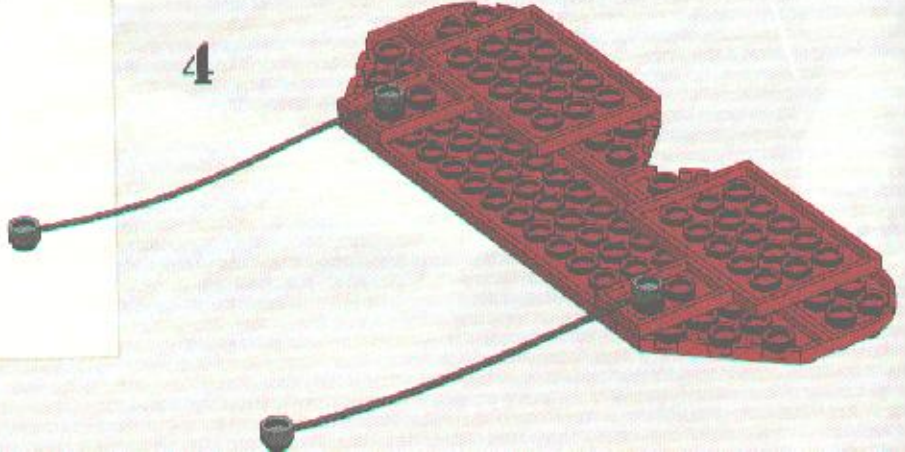

5

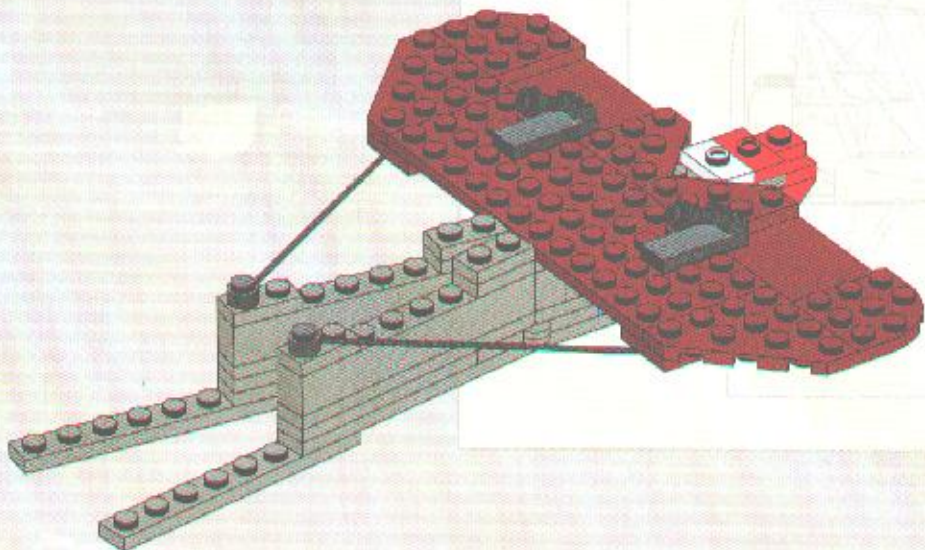
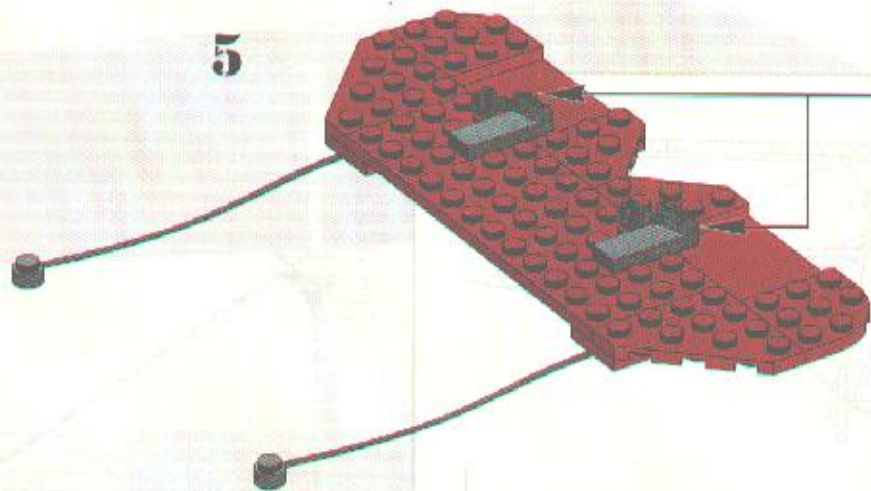

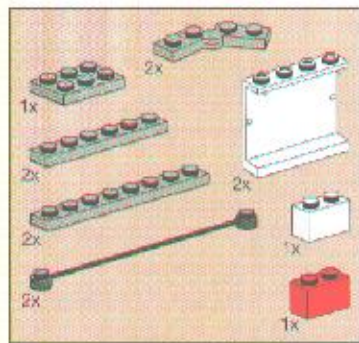

8

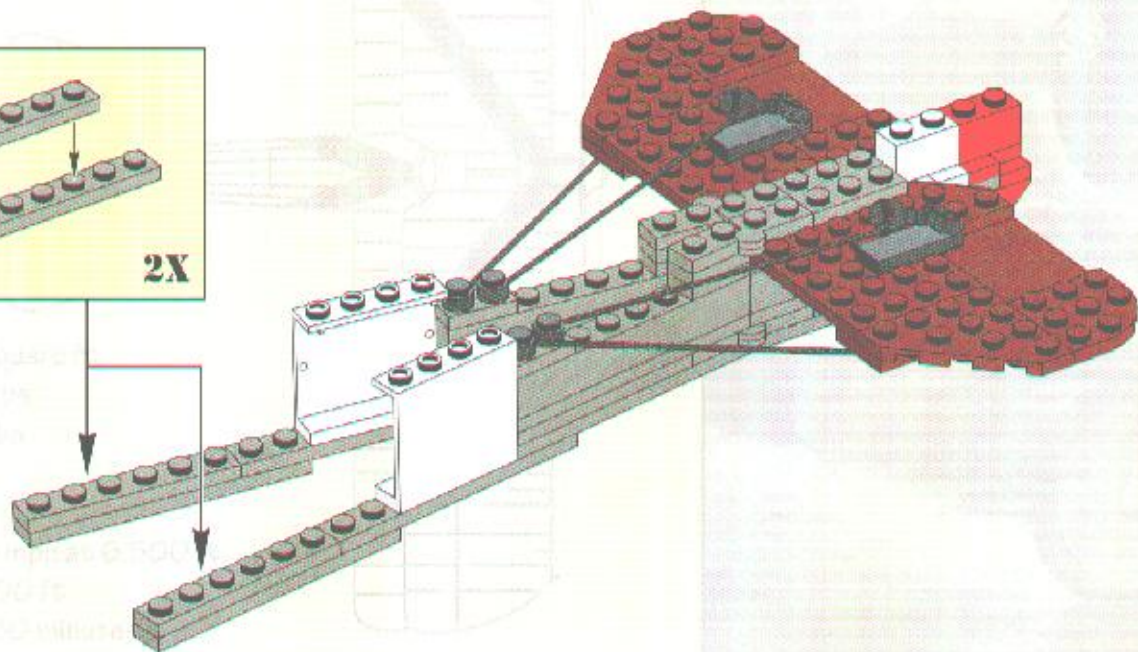
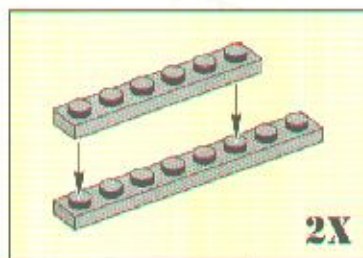

Wing area 251.00 sqm
 Empty weight 245 lbs
 Max. weight 423 lbs

Engine power 100 hp
 Maximum speed 130 mph @ 6500
 Climb rate 1000 ft
 Cruise rate 2 Hours 30 minutes

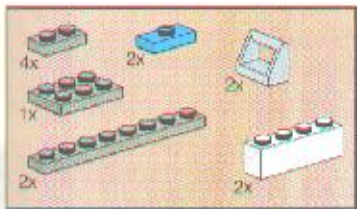

9

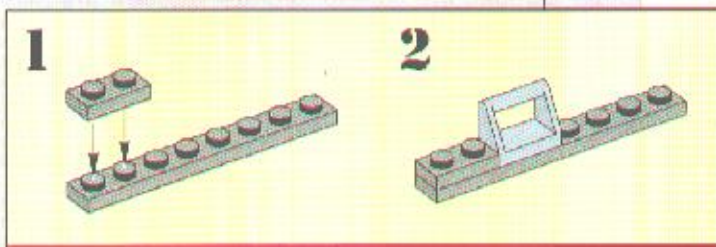
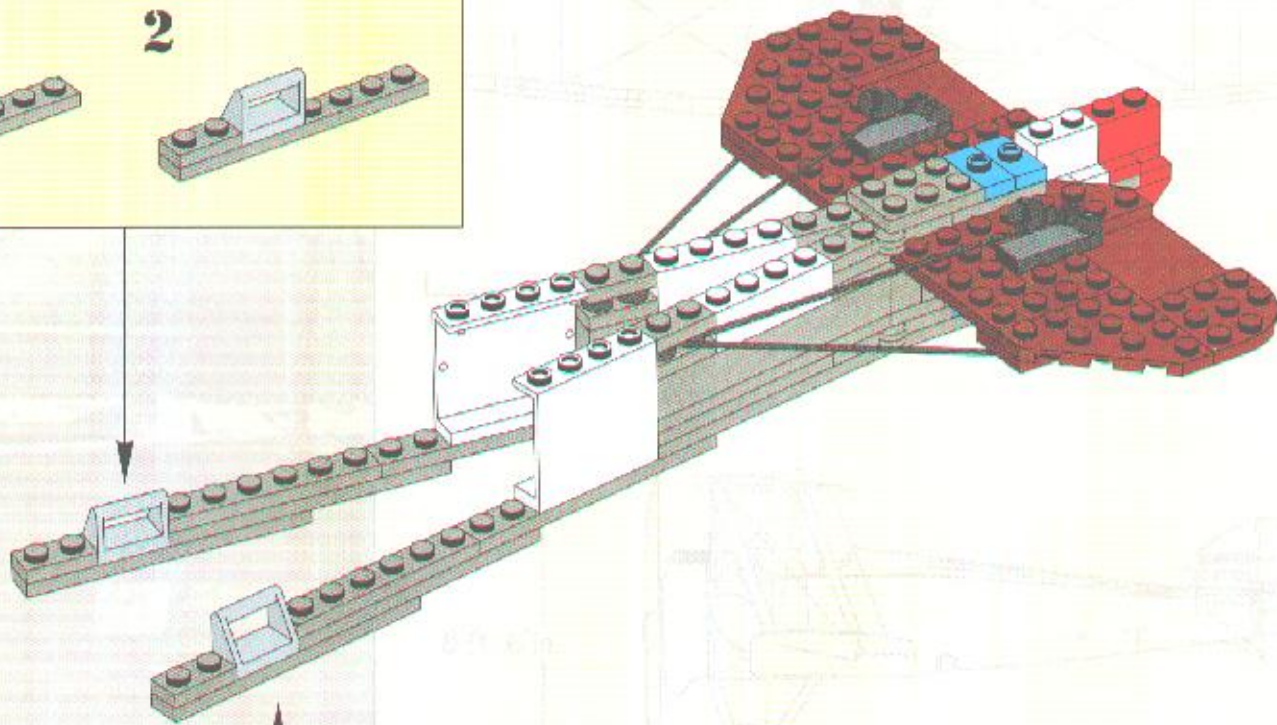
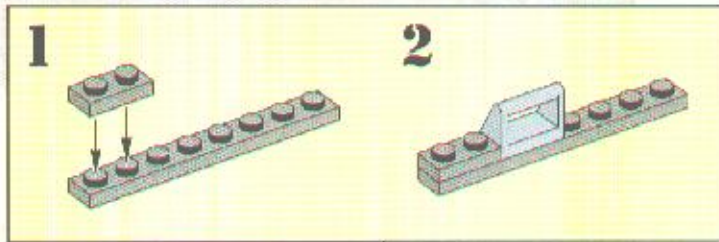

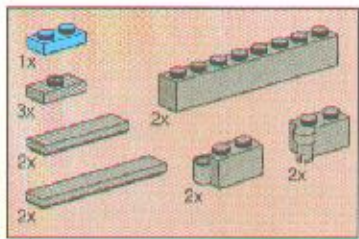

10

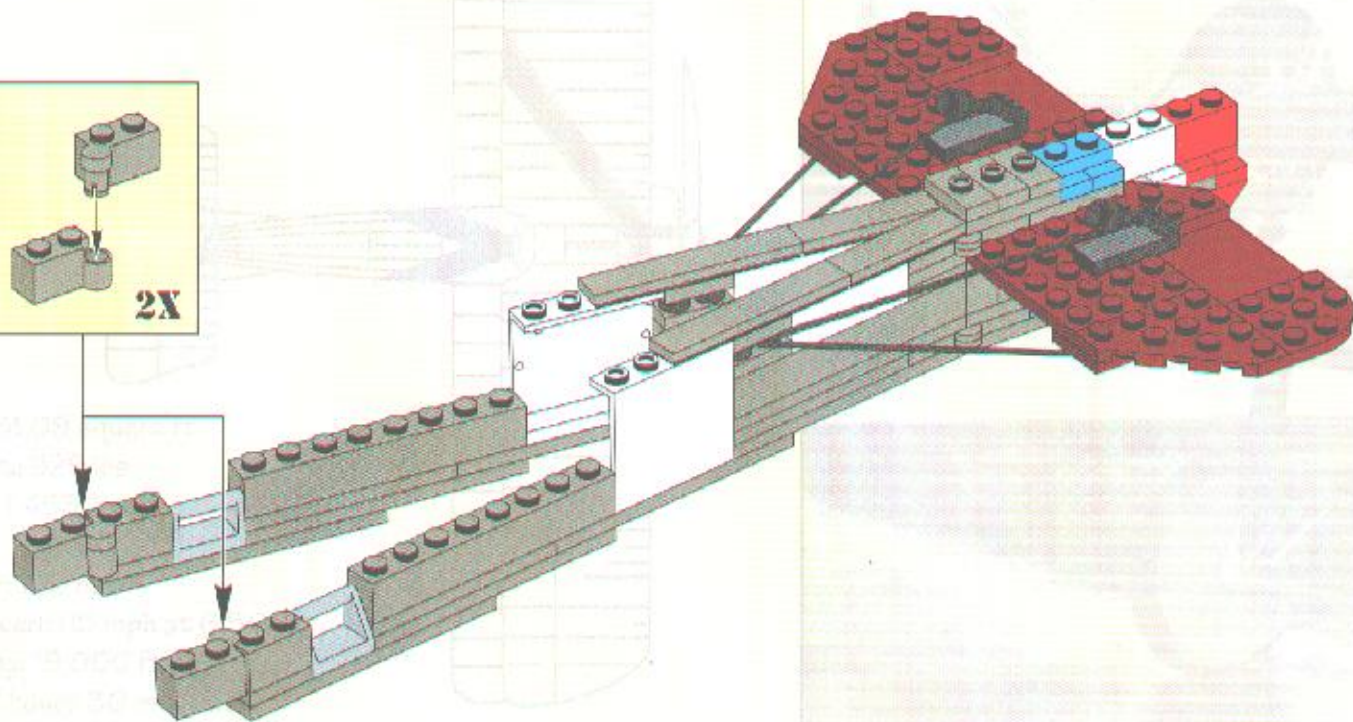
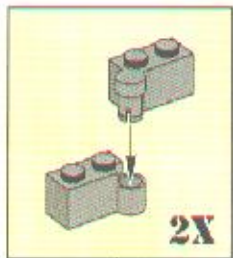

Wing area: 205 cm²
 Empty weight: 37 g
 Max. weight: 100 g
 Fuel to power: 100 g
 Minimum speed: 10 m/s
 Speed ceiling: 1500 g
 Engine range: 2 hours 30 min



11

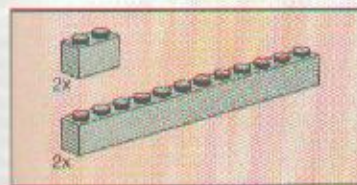
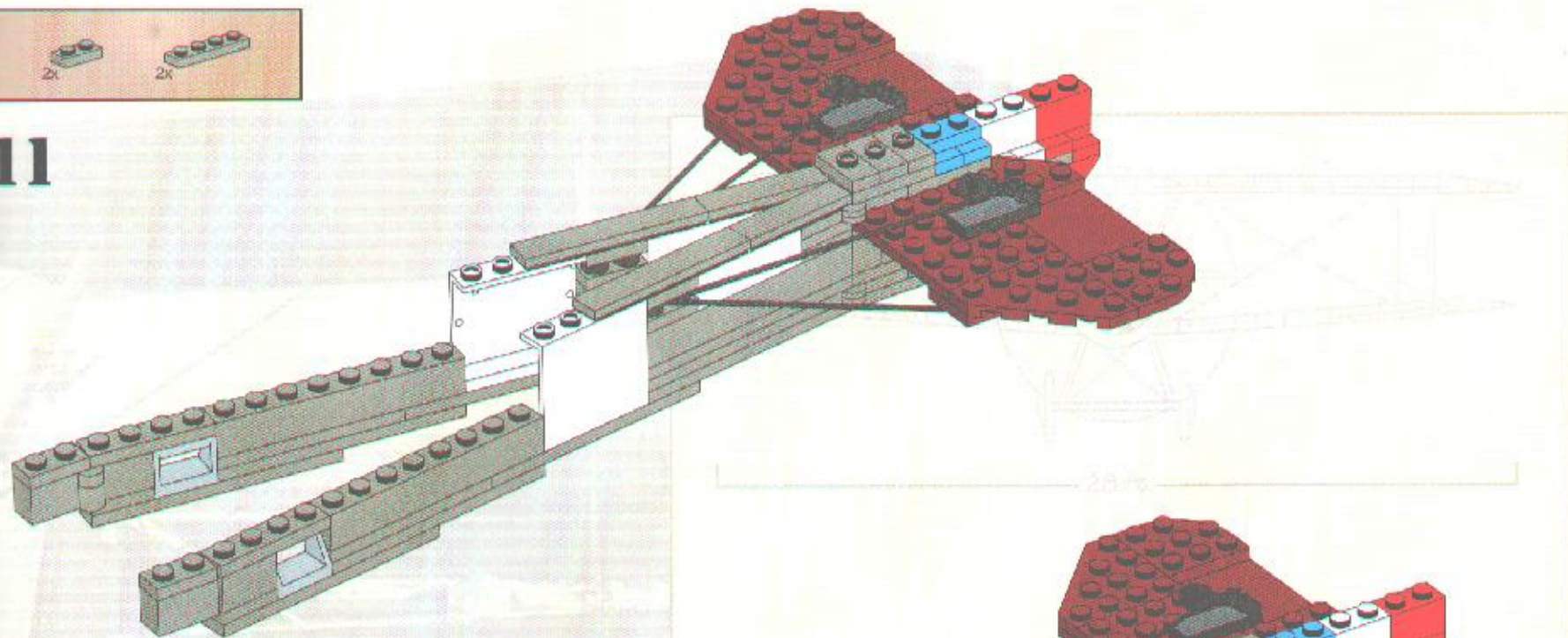

12

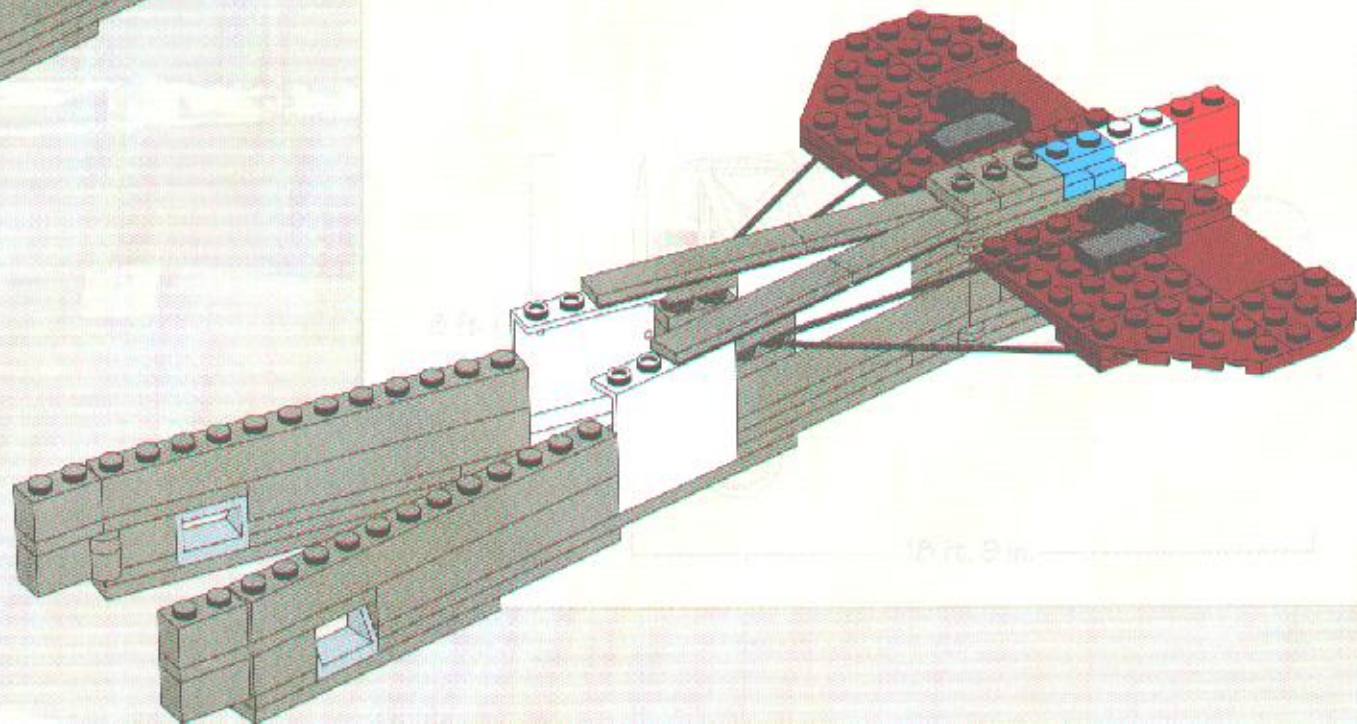

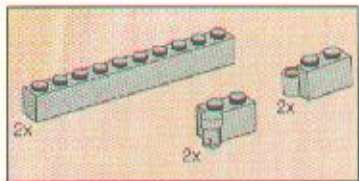

13

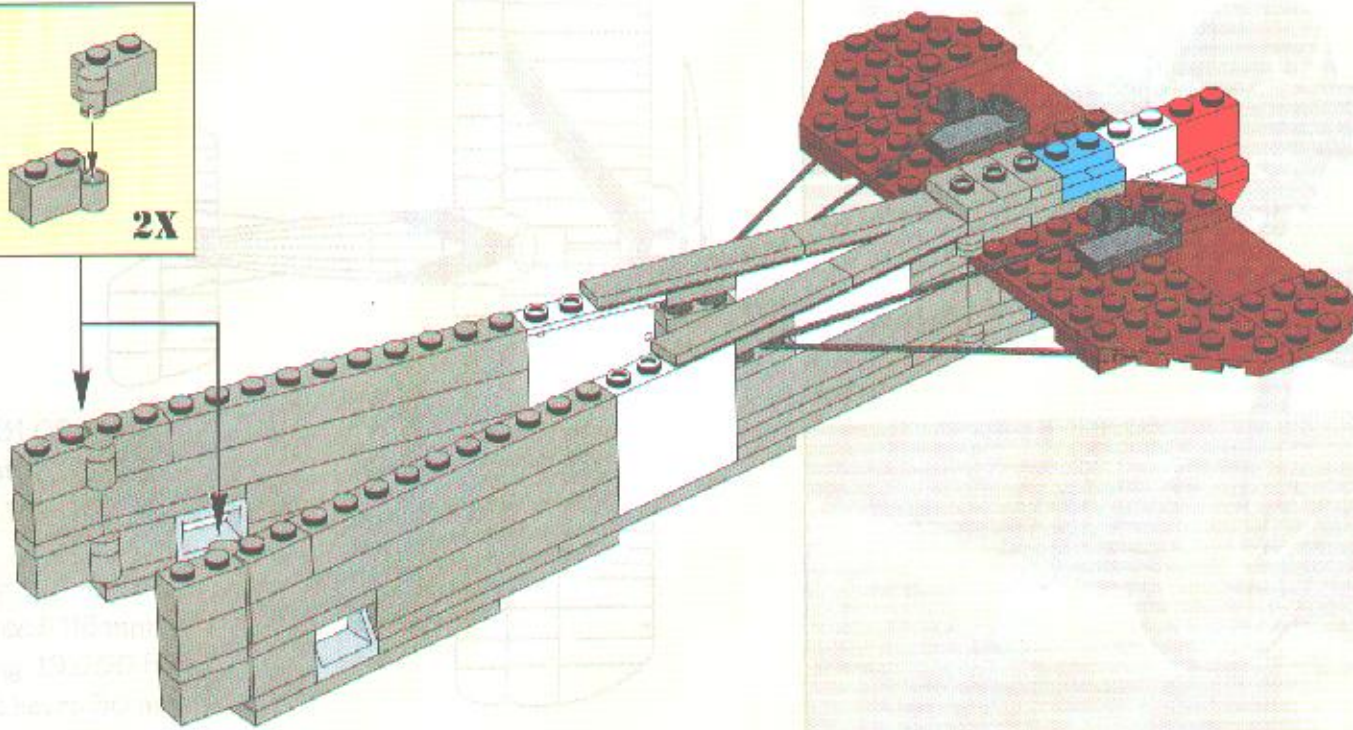
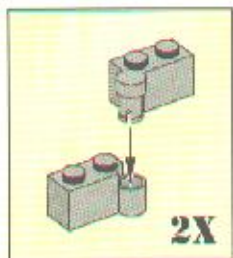

Qty: 2x
Empty weight:
Max weight:
Empty price:
Maximum speed: 10mm
Maximum length: 130mm
Lifetime: 2 hours

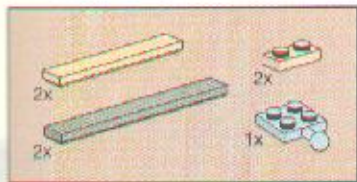

14

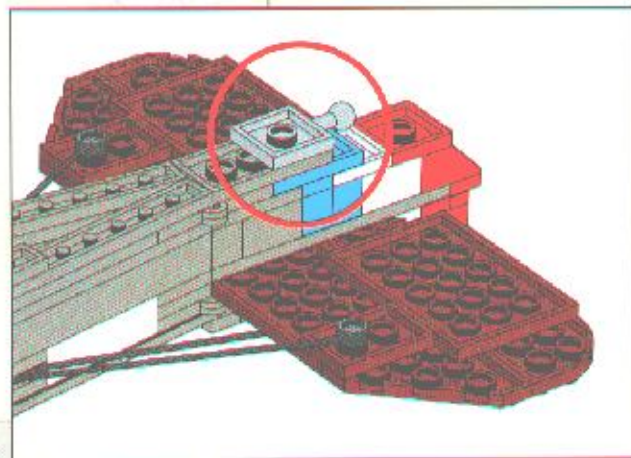
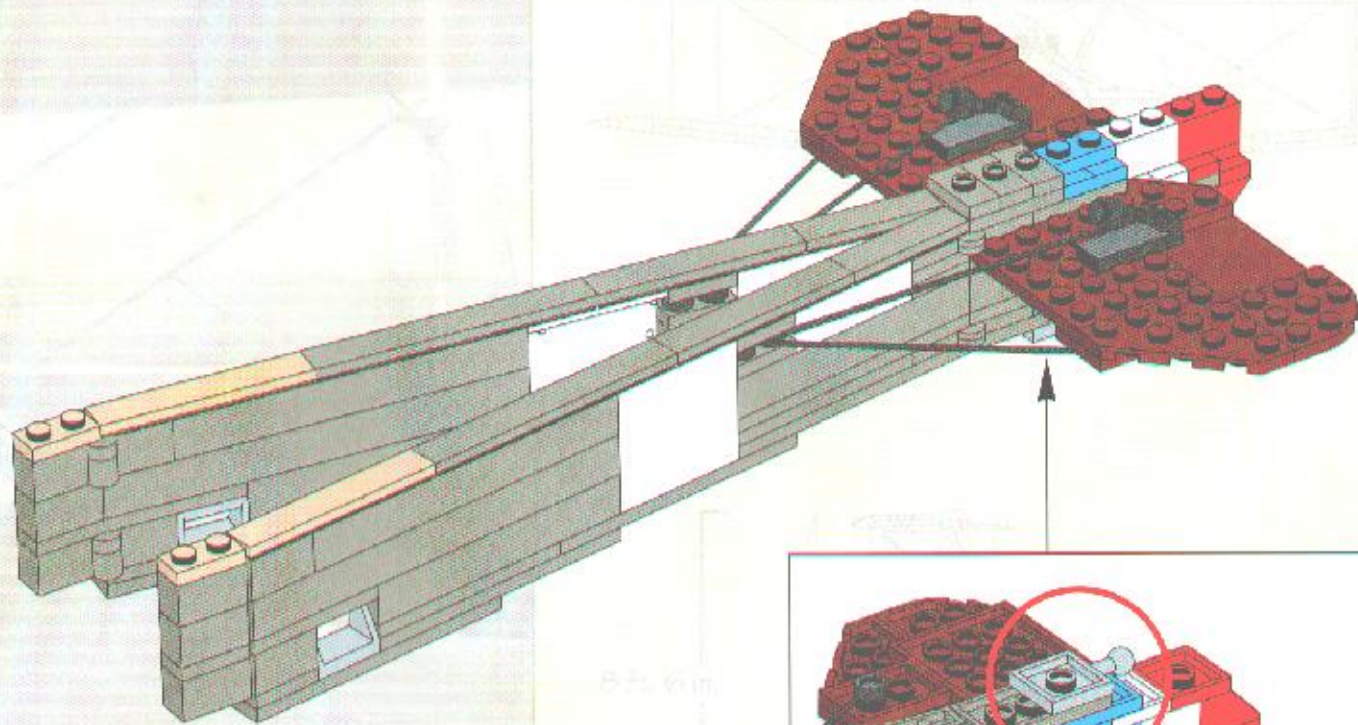

SOPWITH "CAMEL"

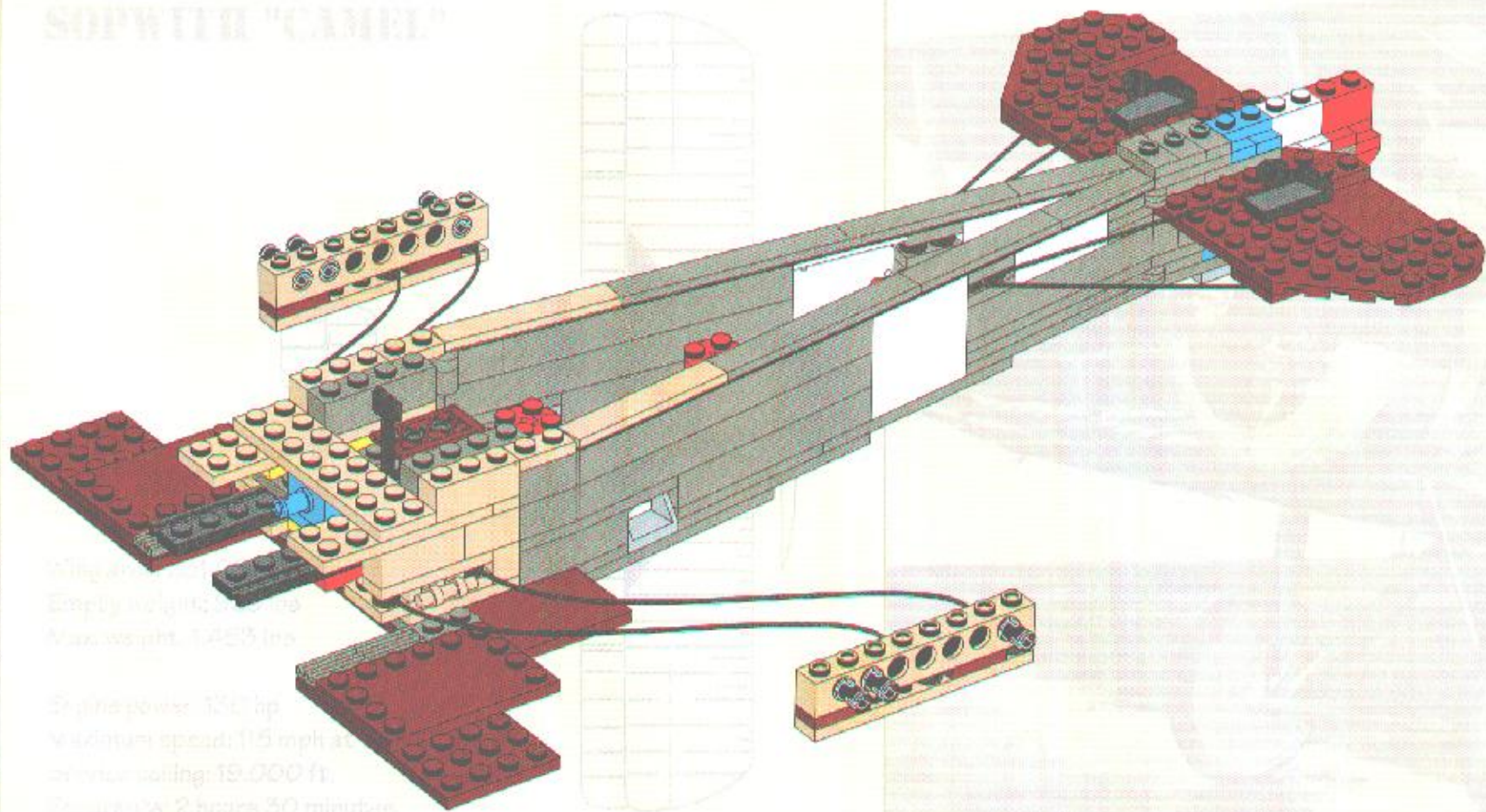

Wing area: 1,200 sq ft
 Empty weight: 1,450 lbs
 Max weight: 1,453 lbs

Engine power: 130 hp
 Maximum speed: 115 mph at
 altitude of 19,000 ft.
 Climb rate: 2 hours 30 minutes

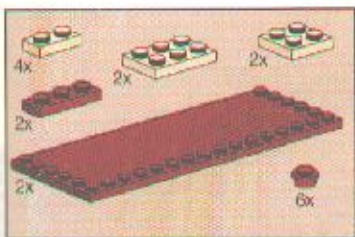

16

1

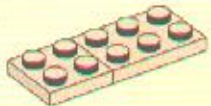

3



2

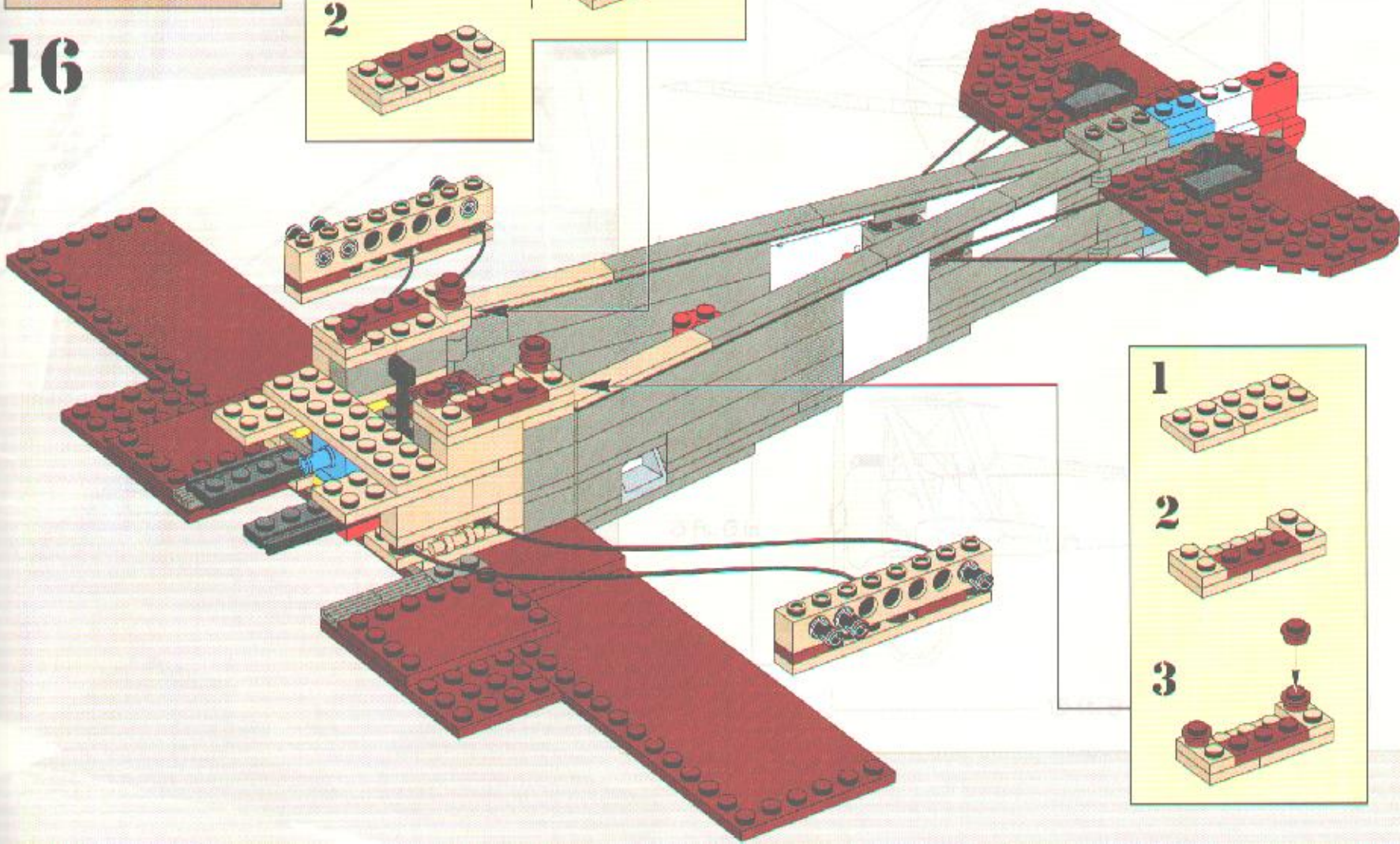
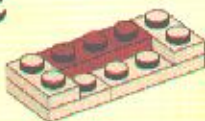

1

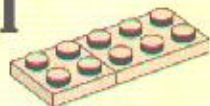

2

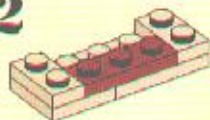

3

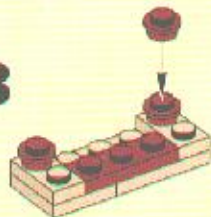

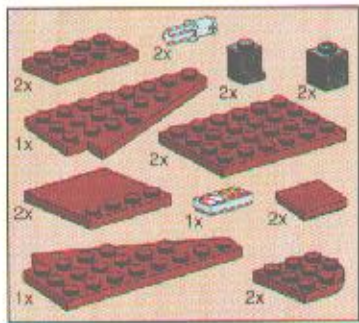

17

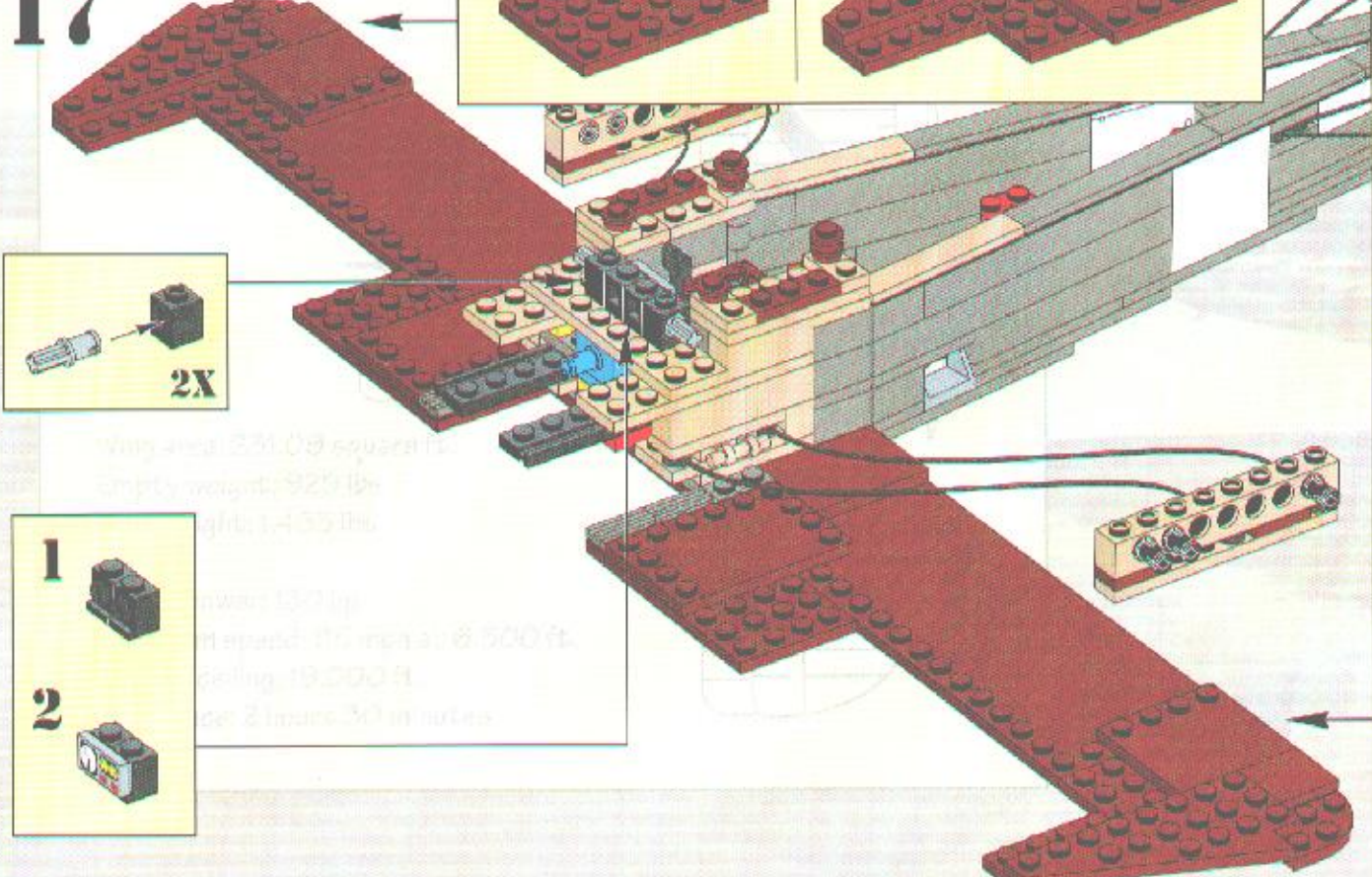
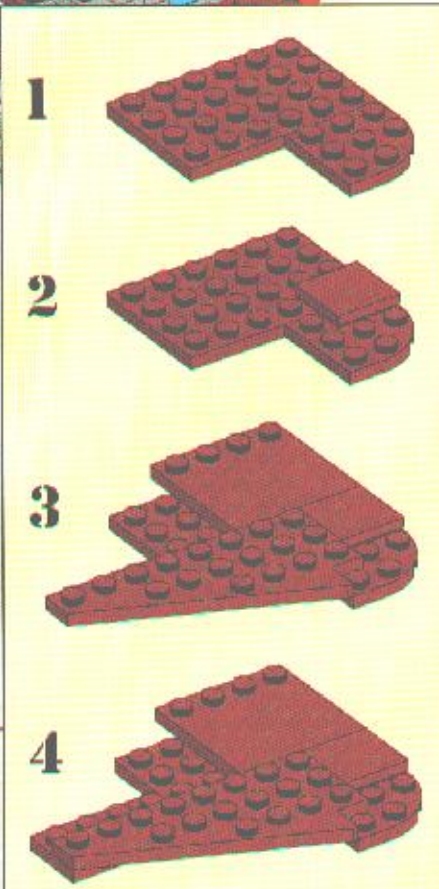
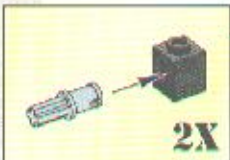
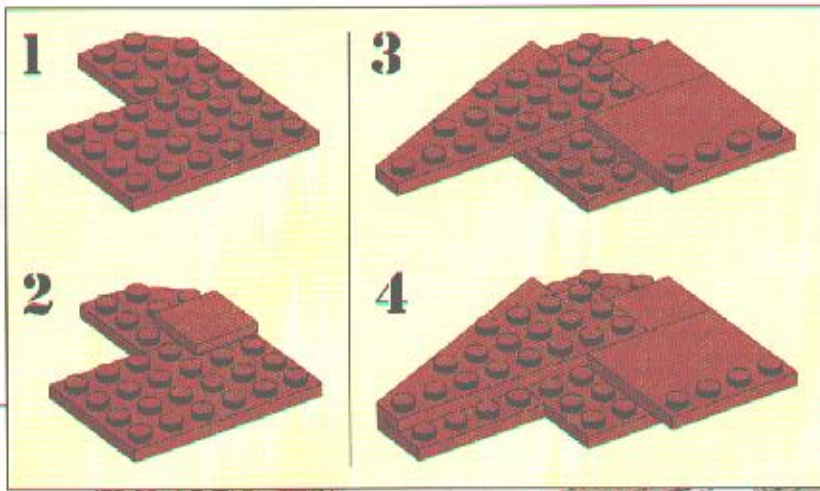

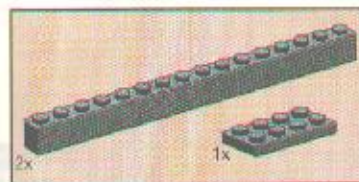
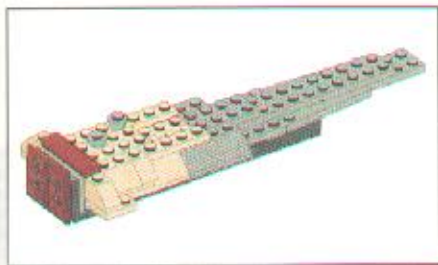

1

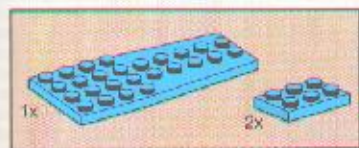
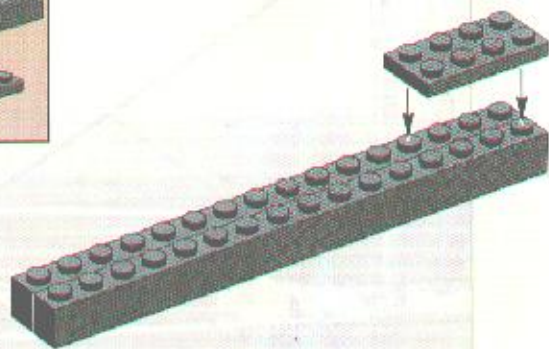

2

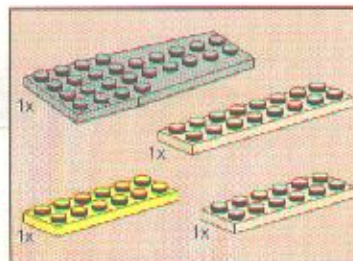
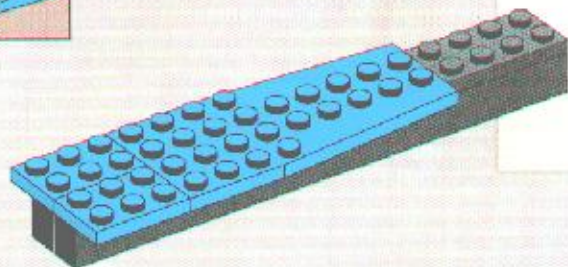

3

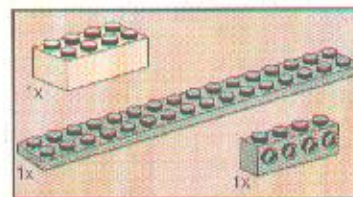
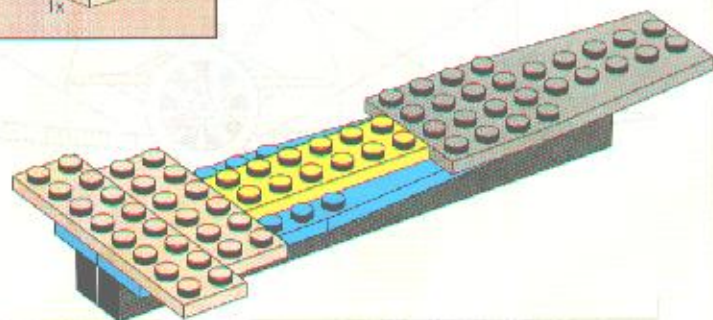

4

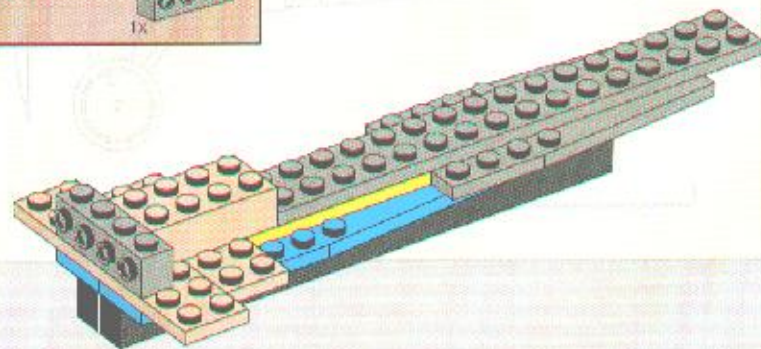

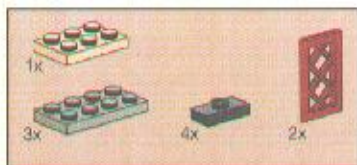

5

SOP WITH "CAMEL"

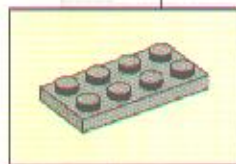
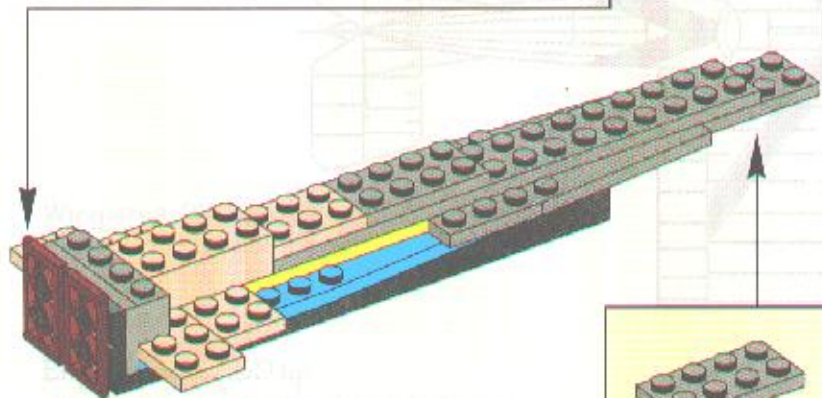
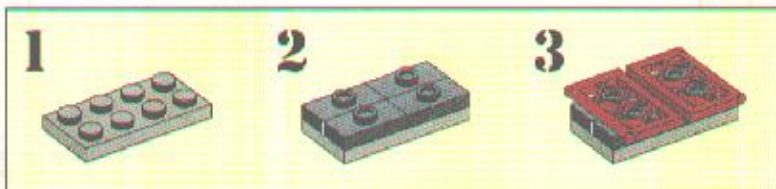

Maximum speed: 115 mph at 6,000 F
 Service ceiling: 18,000 ft.
 Altitude: 2 hours 30 minutes.



6

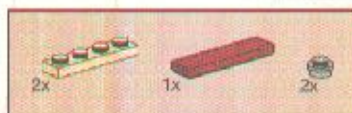
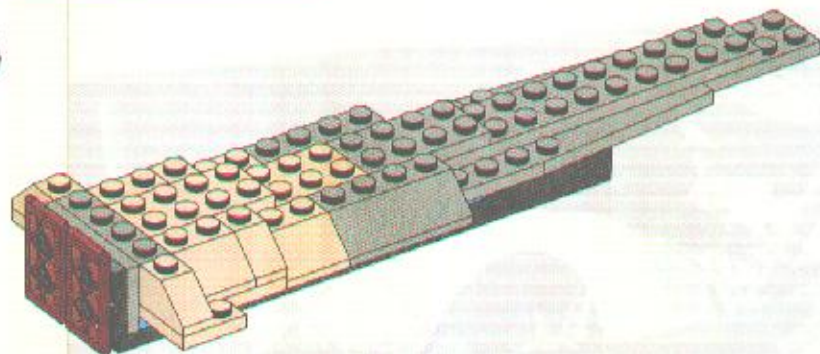

7

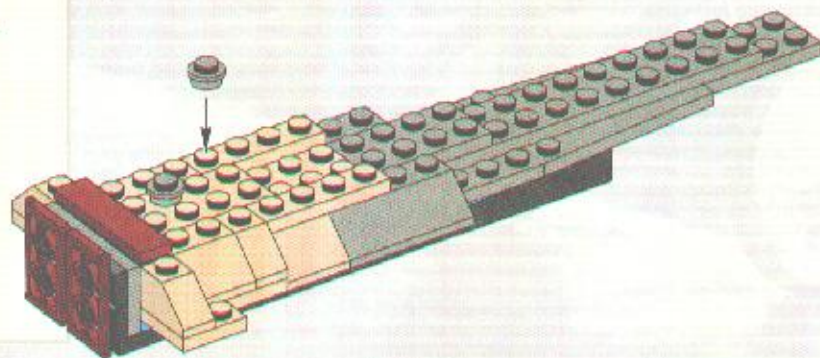

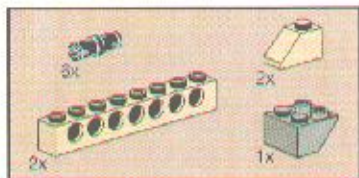

19

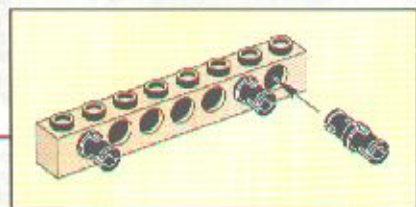
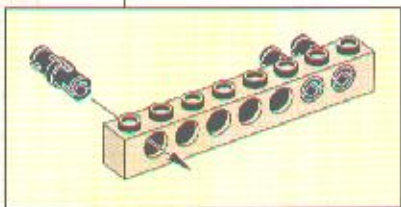
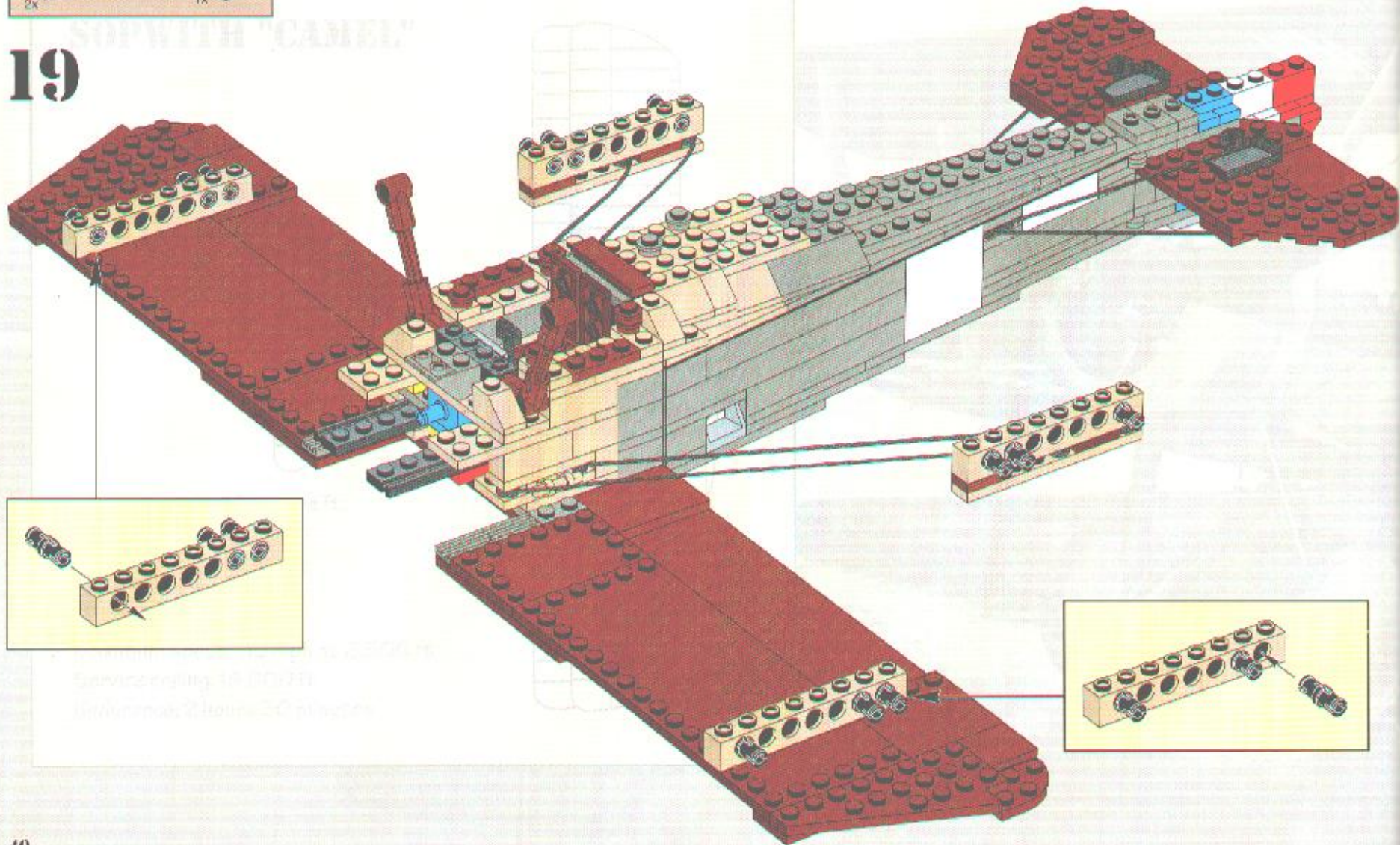

Save the right 18 DO 211
 and the 2 holes 20 and 21

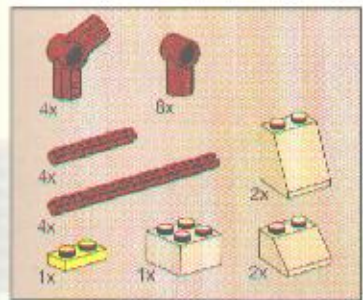

20

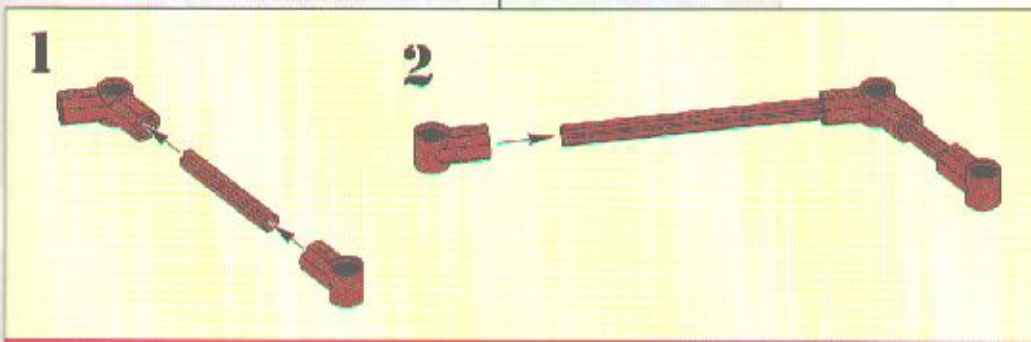
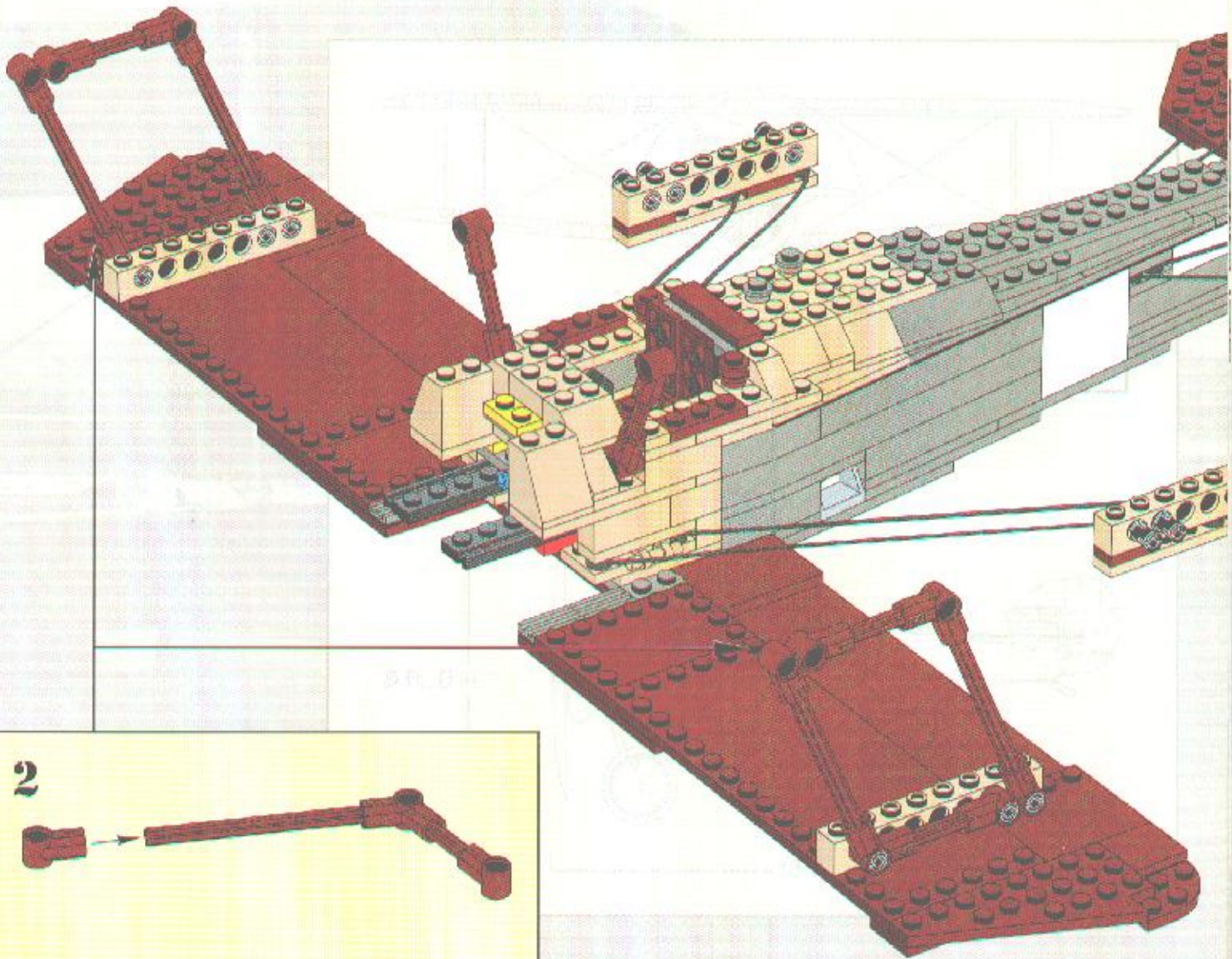



21

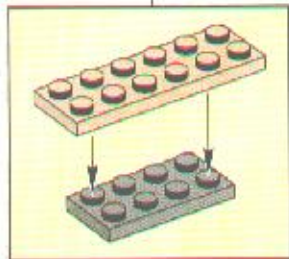
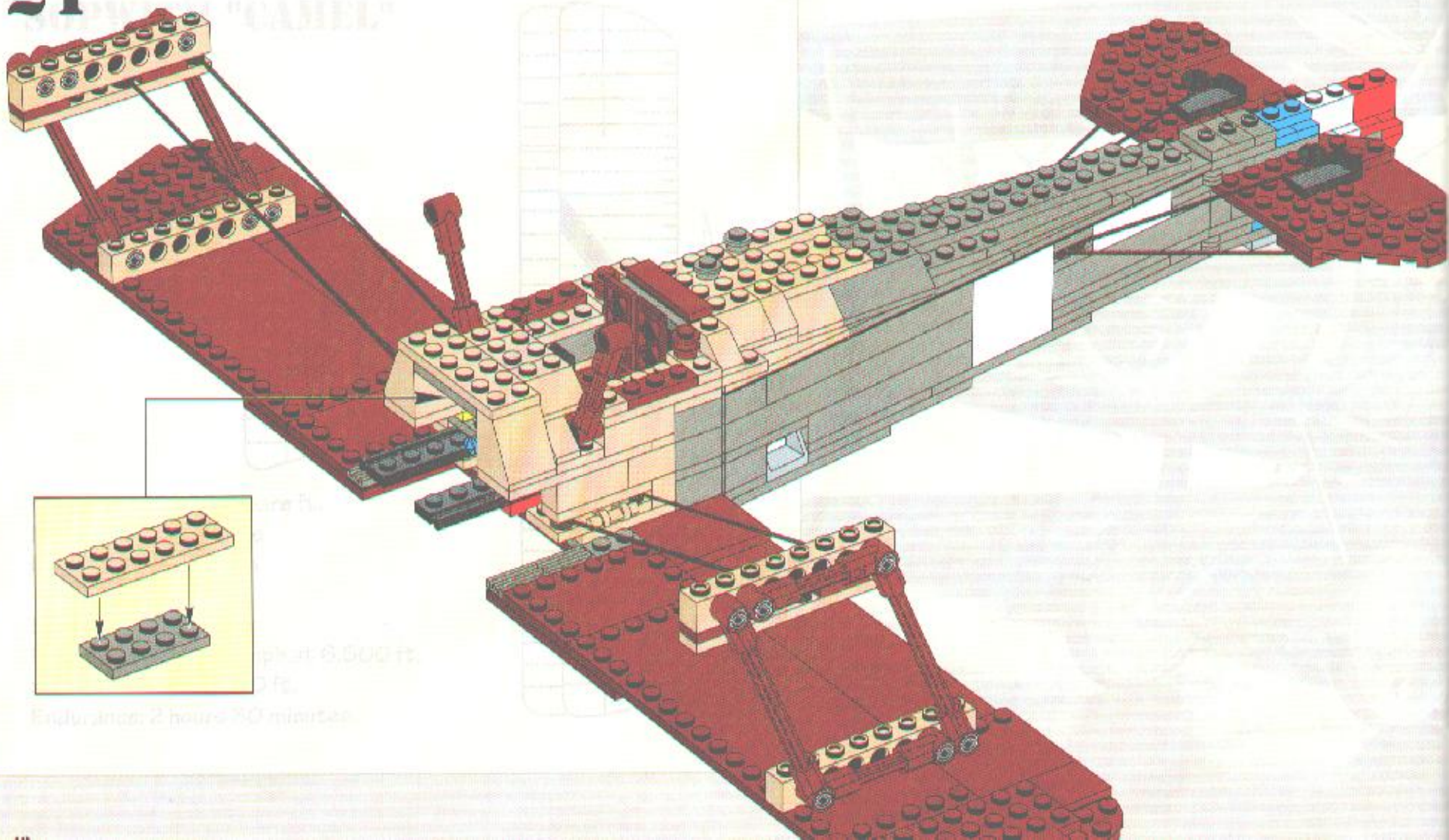

Estimated time: 2 hours 30 minutes

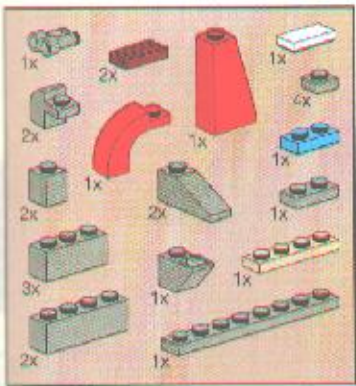

22

1



2

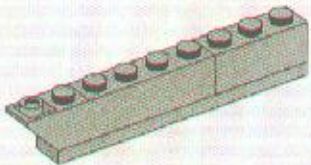

3

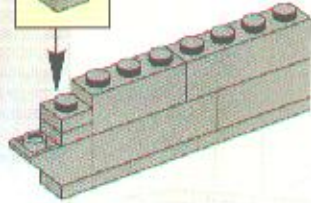
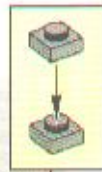

4

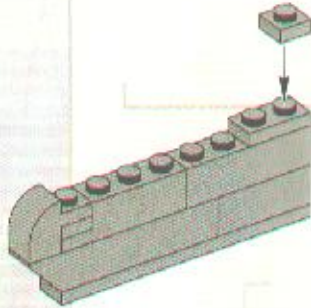

5

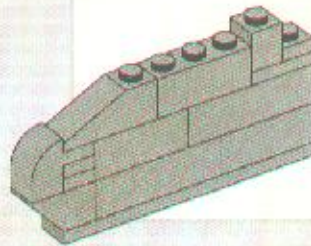

6

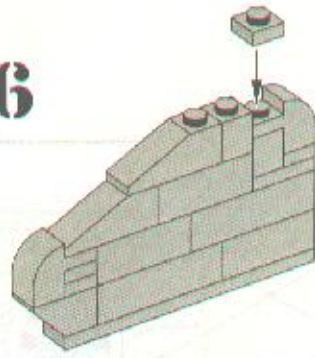

7

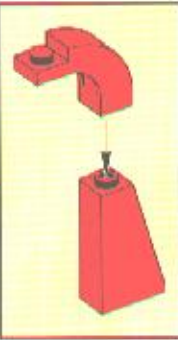
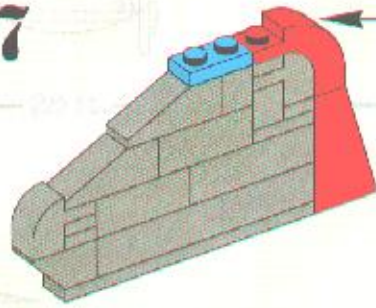

8

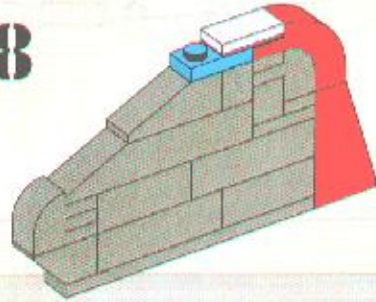

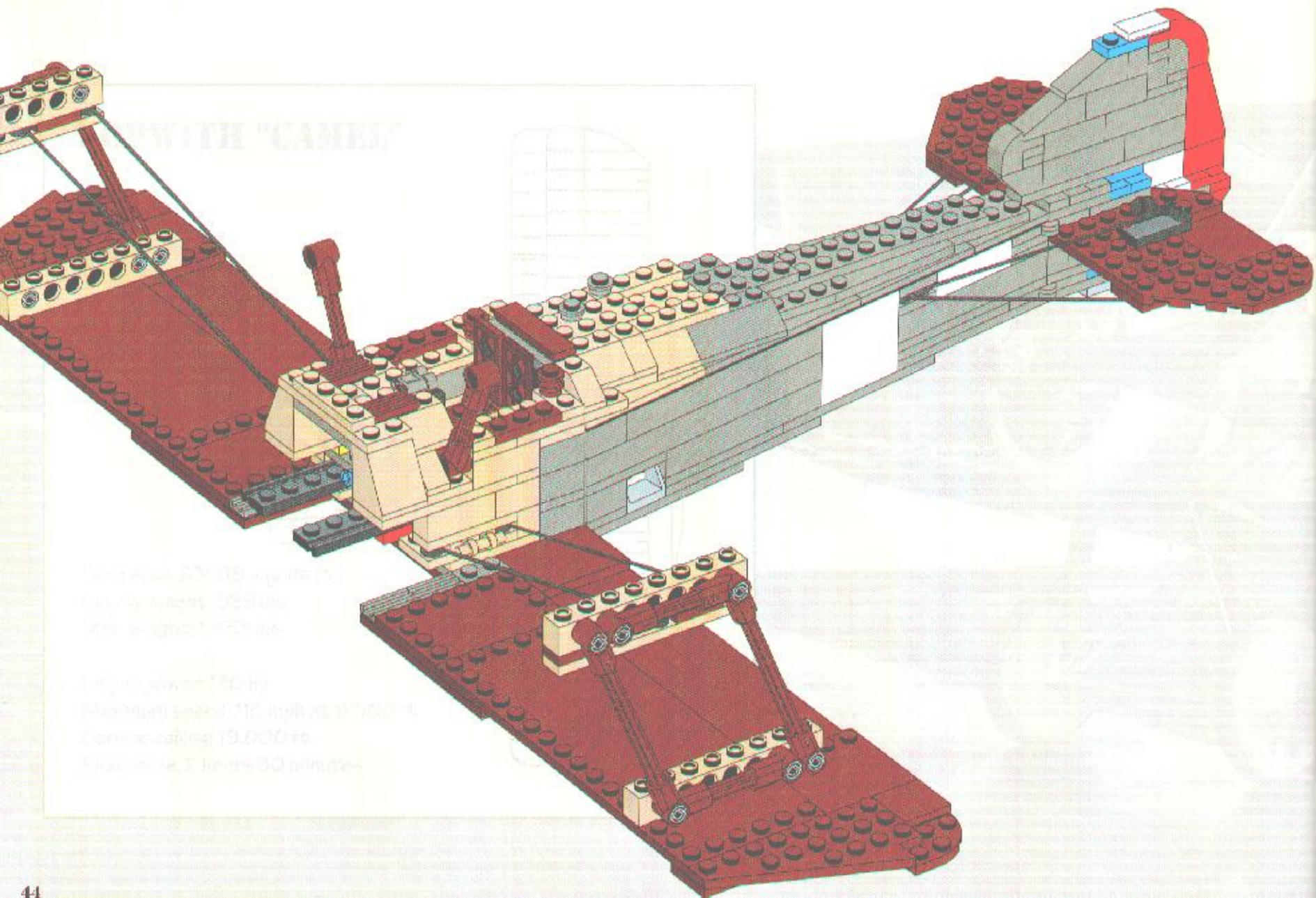

WITH "CAMEL"

1.5 m x 2.5 m x 1.5 m
Capacity: 225 kg
Max. weight: 1.250 kg

1.5 m power 150 hp
Maximum speed: 12 km/h
Cable length: 18,000 m
Disassembly: 2 hours 30 minutes

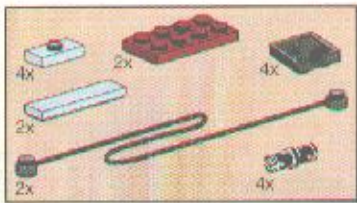

23

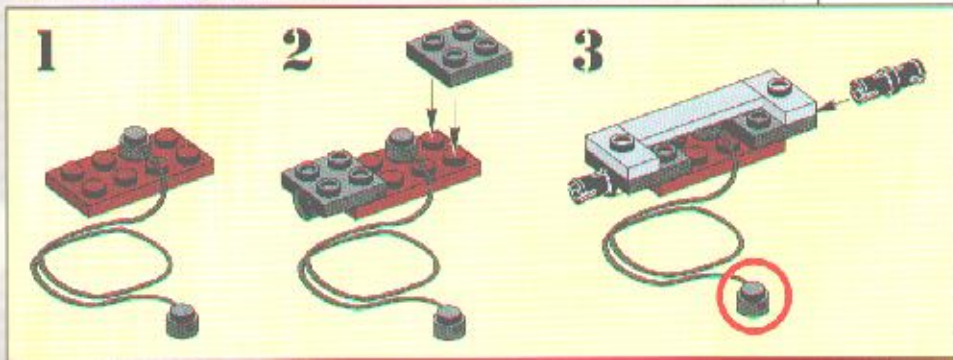
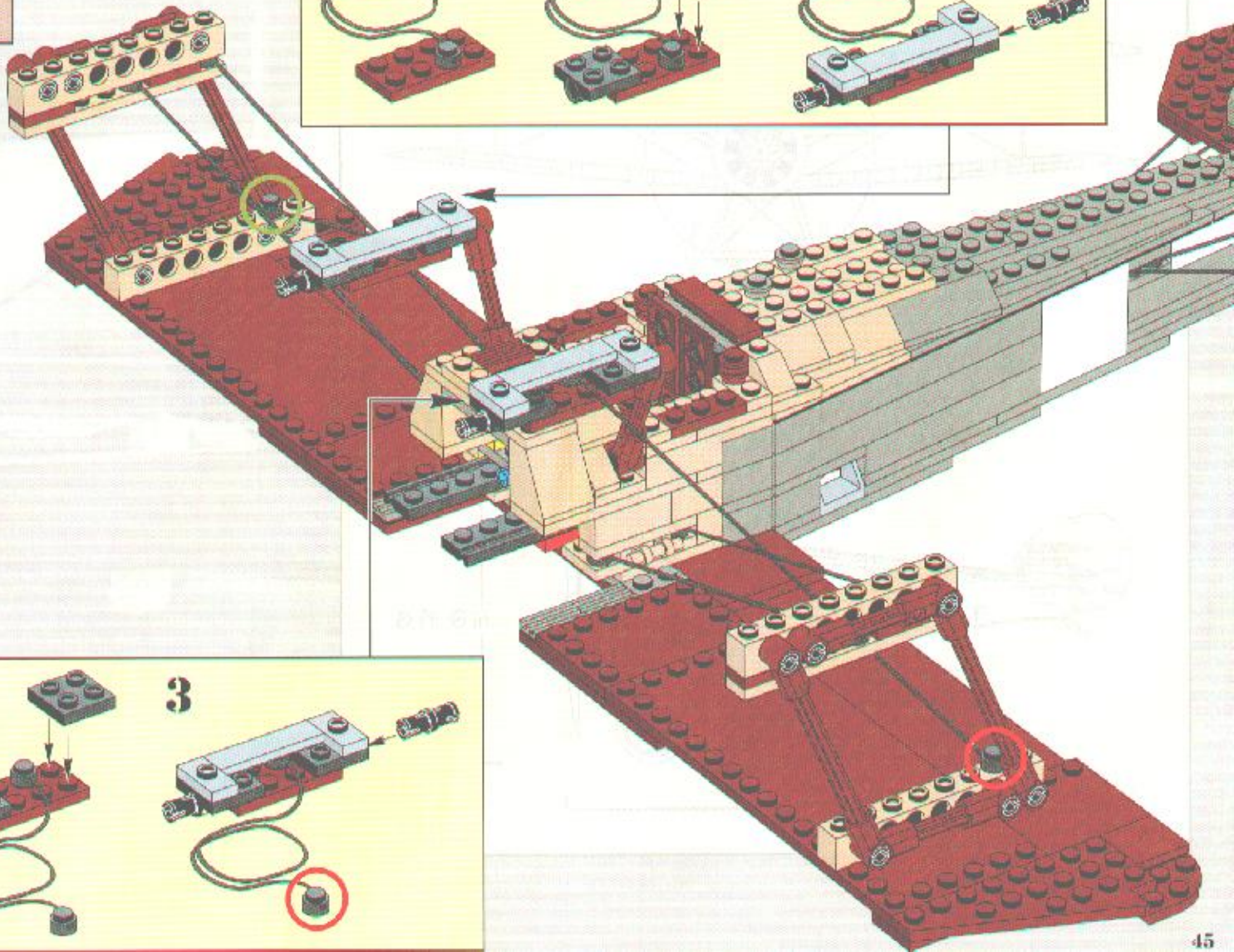
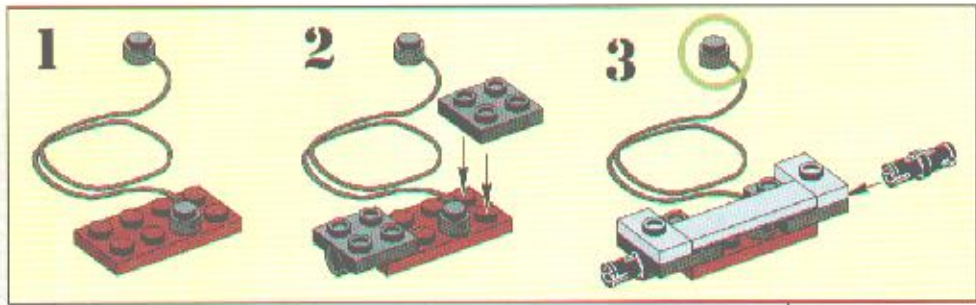

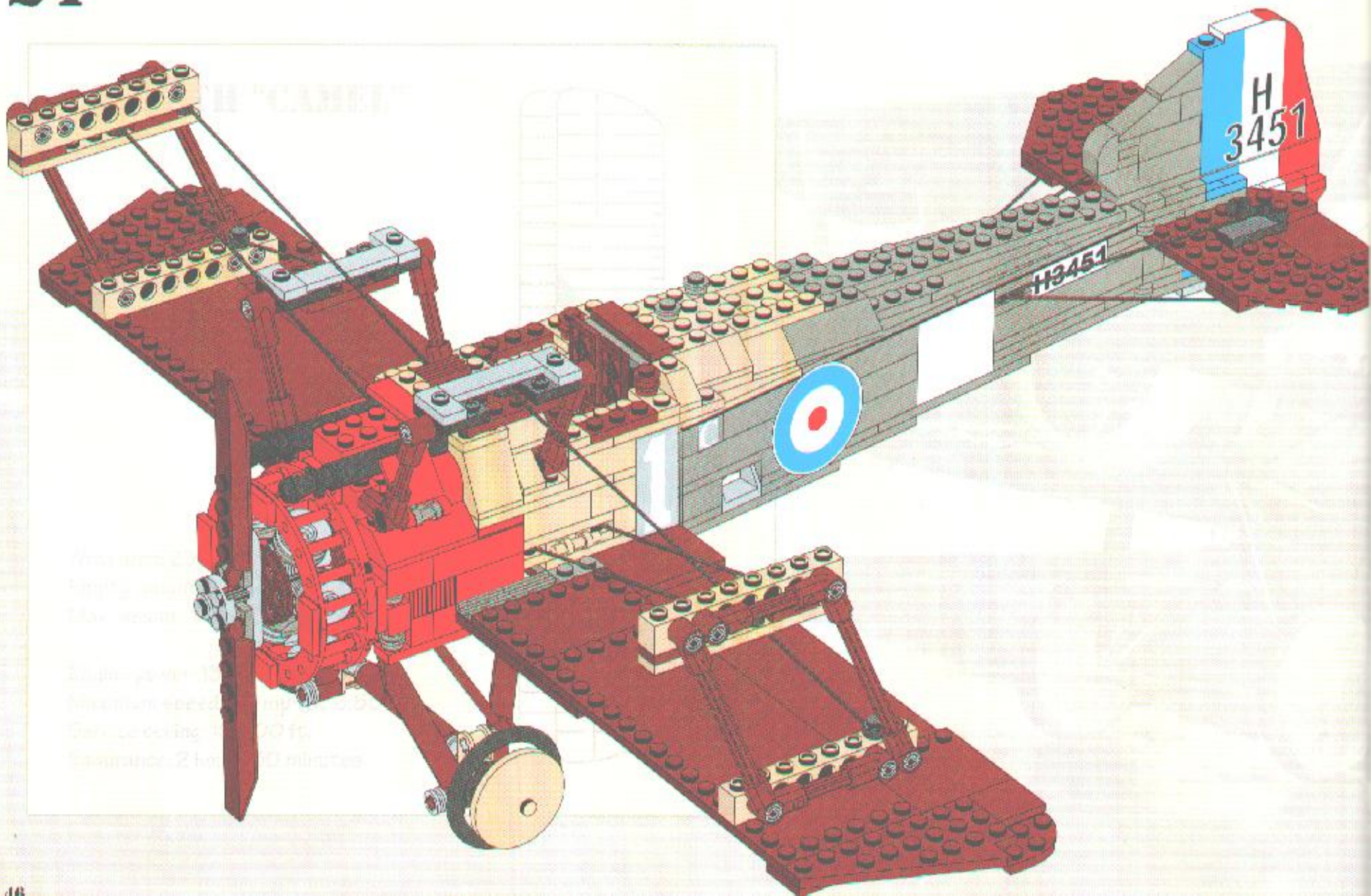

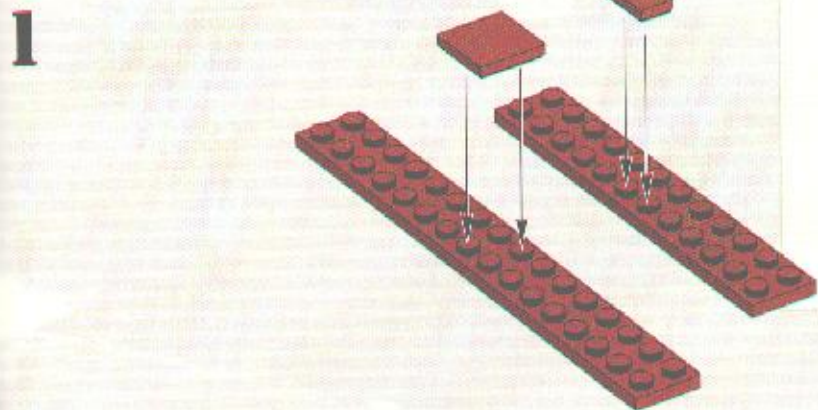
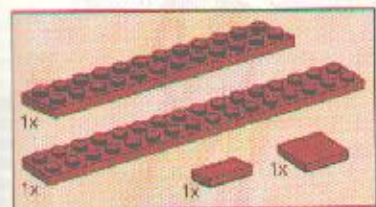

2

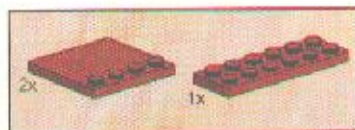

3

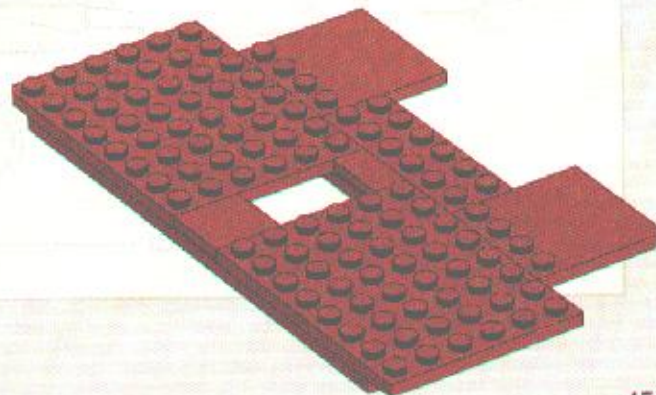

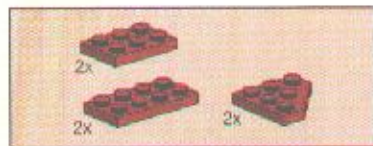

4

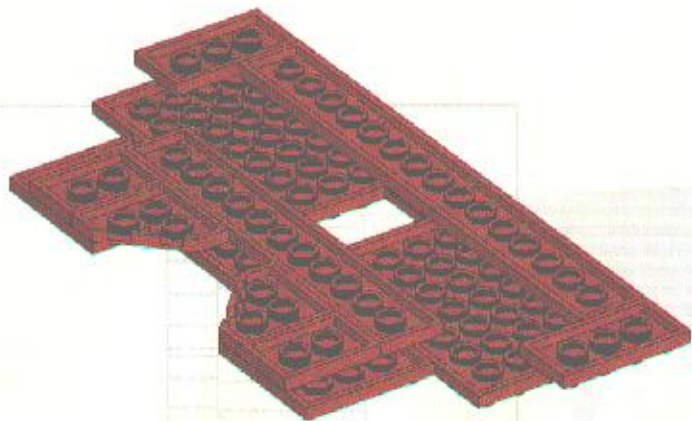

5

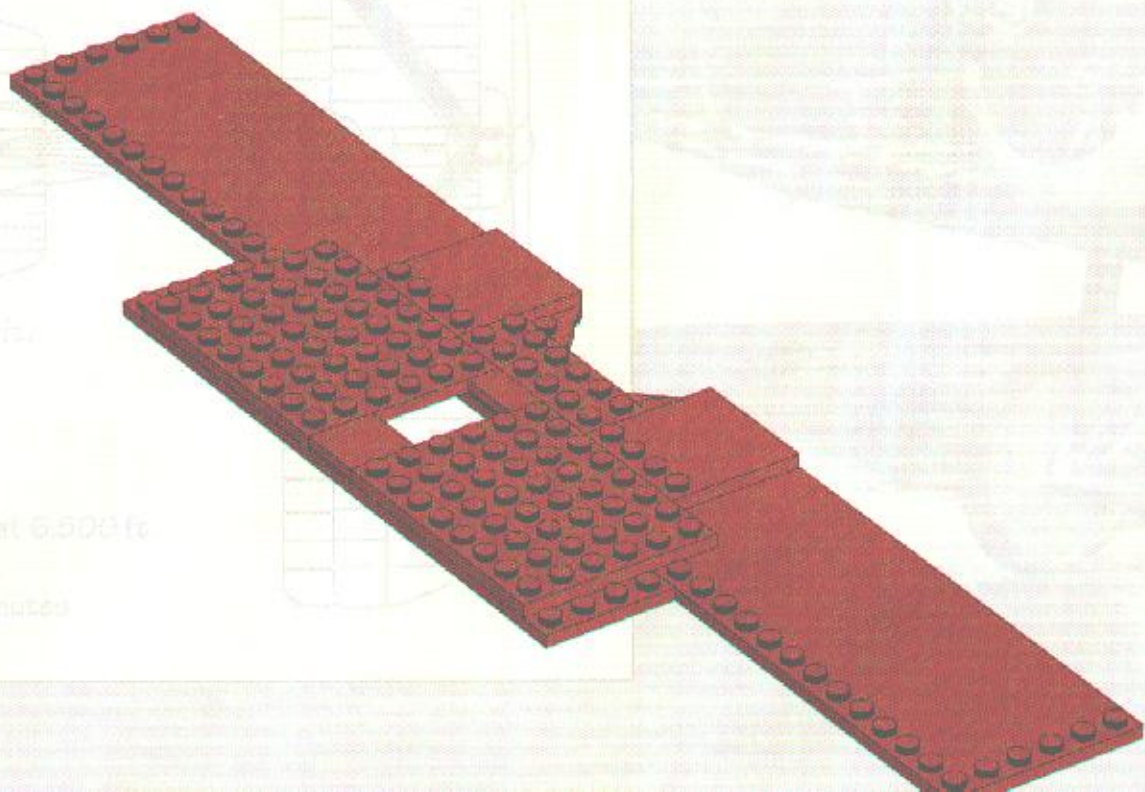

Wingspan: 31.08 square feet
 Length: 14.74 929 lbs
 Max. weight: 1,453 lbs

Engine power: 130 hp
 Maximum speed: 115 mph at 6,500 ft
 Service ceiling: 19,000 ft
 Endurance: 2 hours 30 minutes

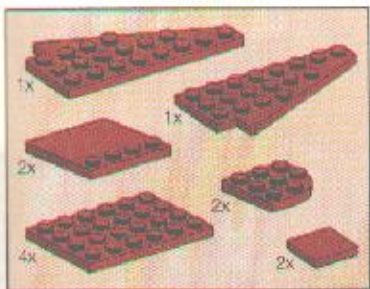

6

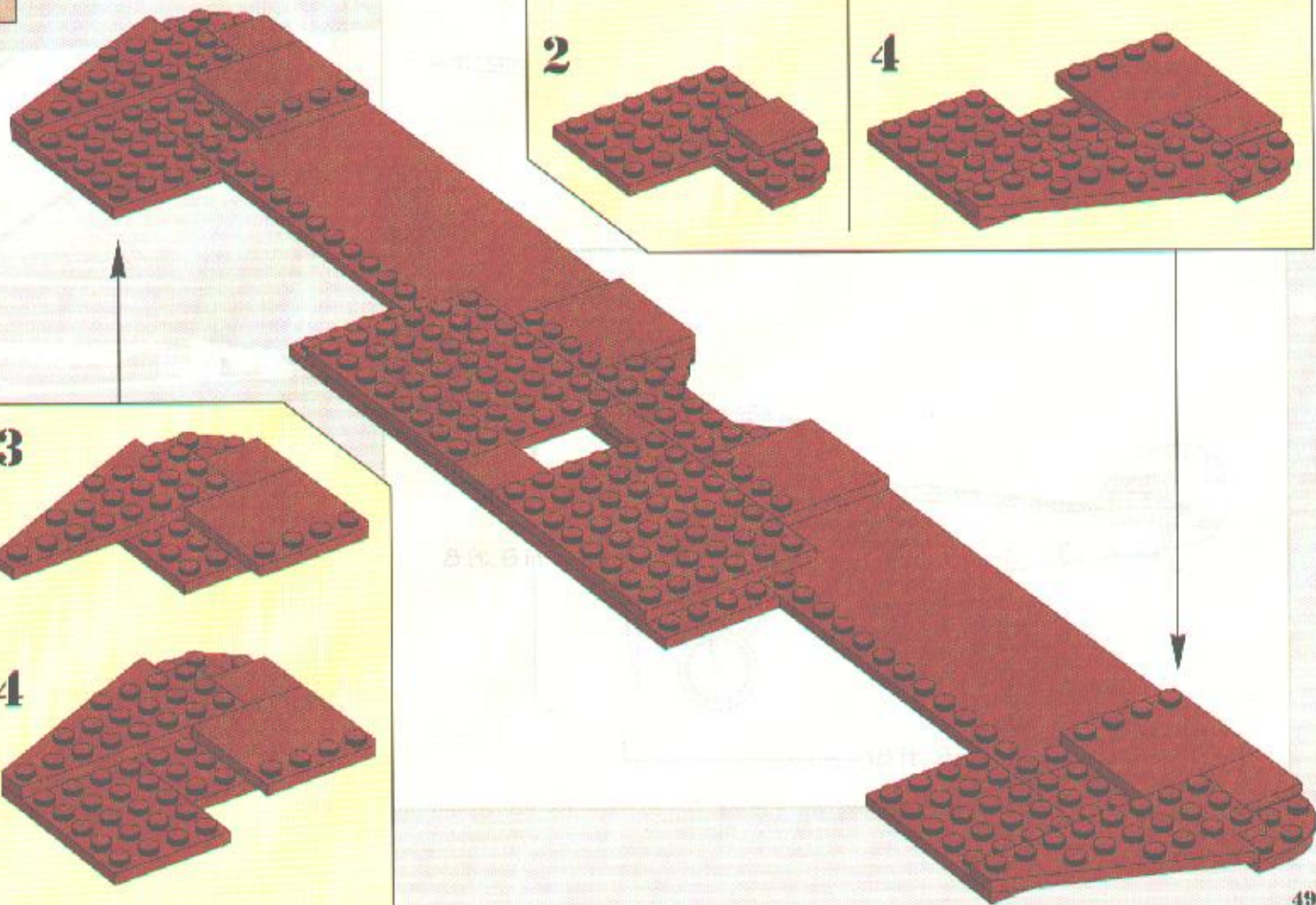

1



2



3



4



1



3



2



4

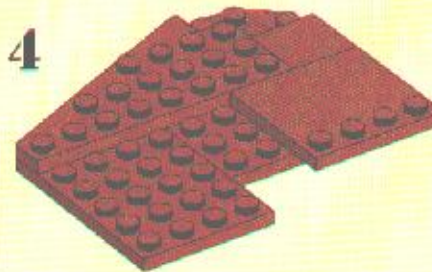



7

SOPWITH "PUPA"

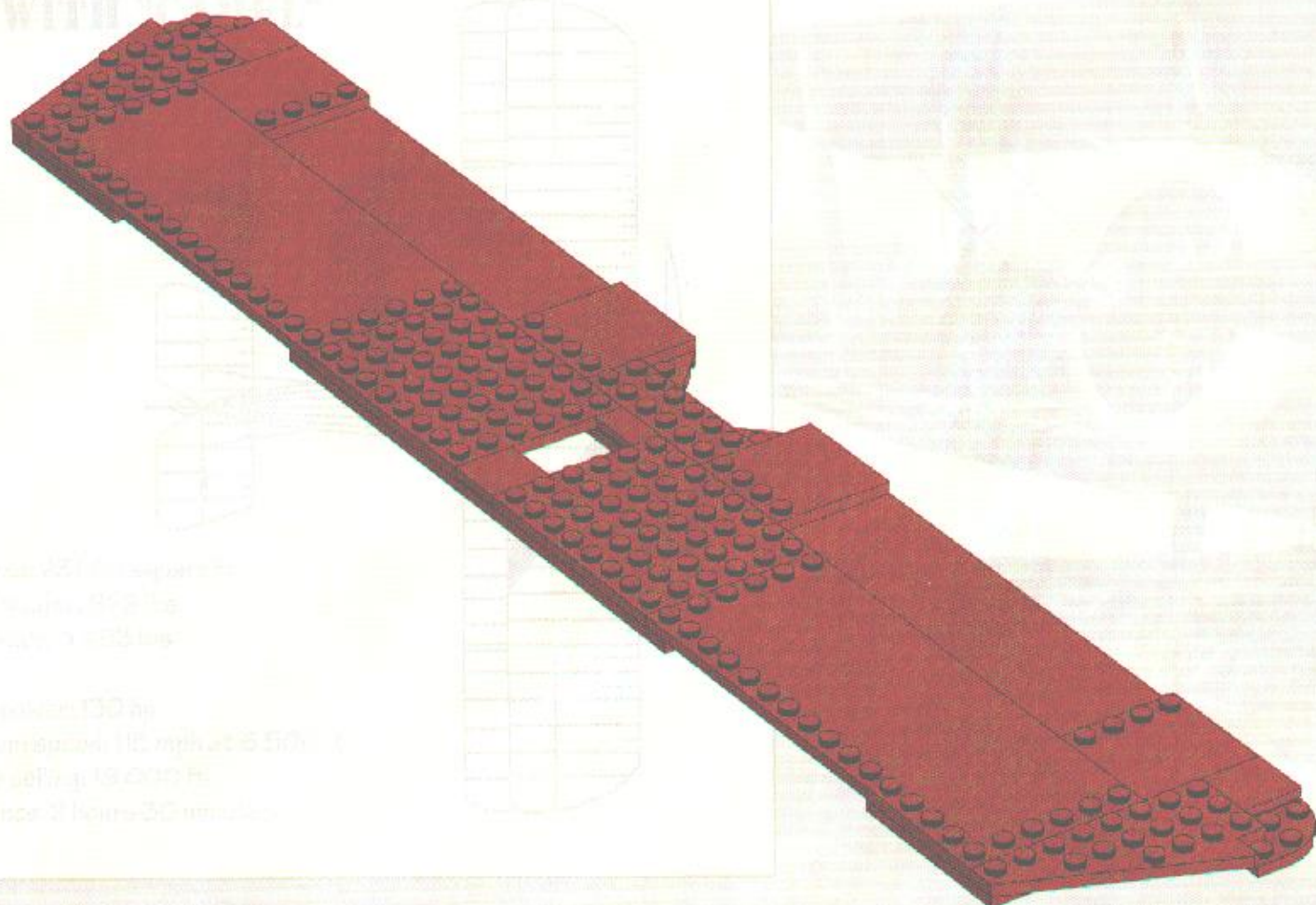

Wing area 231 sq. ft. span 27 ft.
Length 40 ft. 6 in. weight 1,500 lb.

Flaps 10 ft. 10 in. 130 sq. ft.
Maximum speed 110 mph at 5,500 ft.
Rate of climb 1,000 ft. per min.
Endurance 2 hours 30 minutes

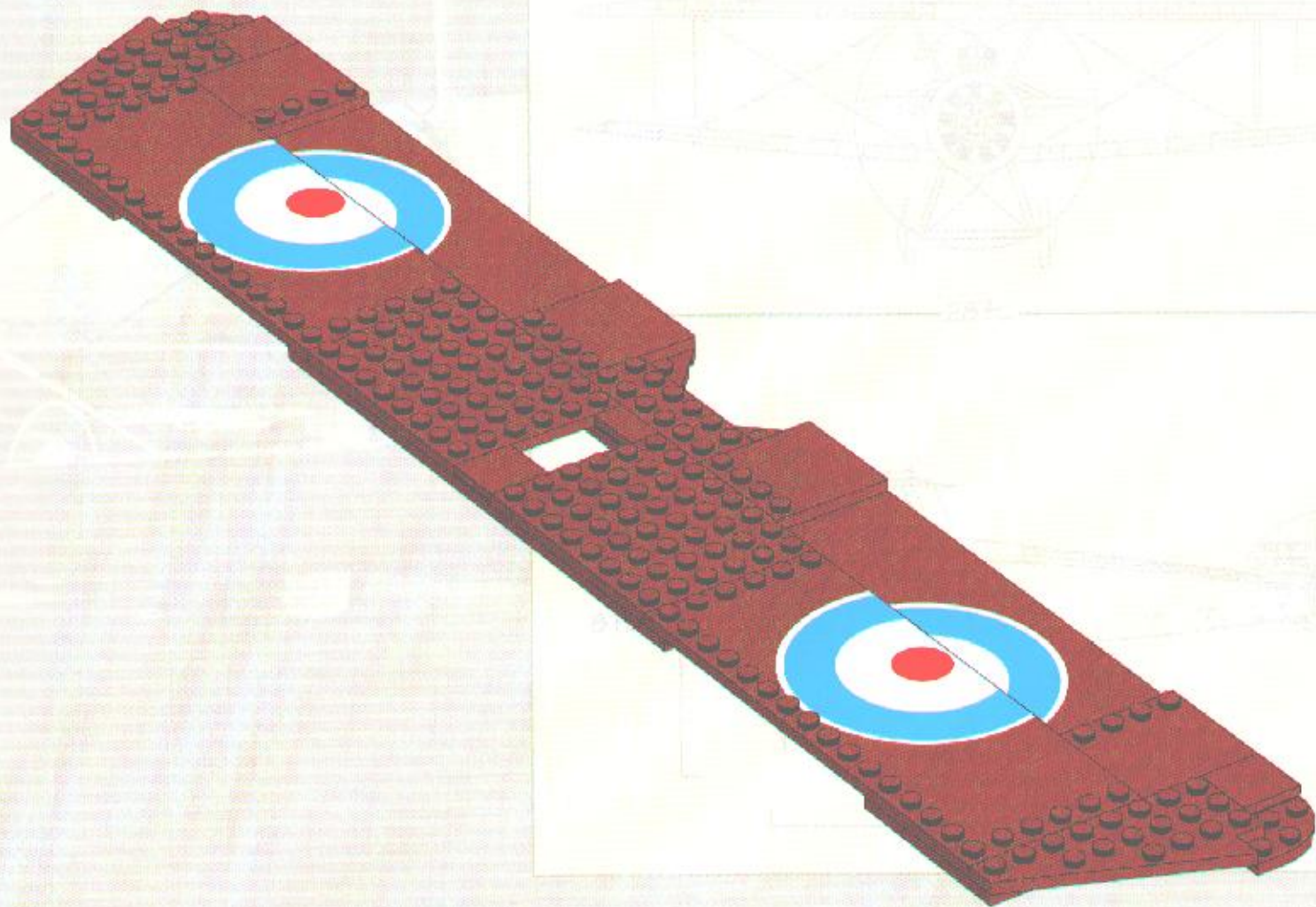

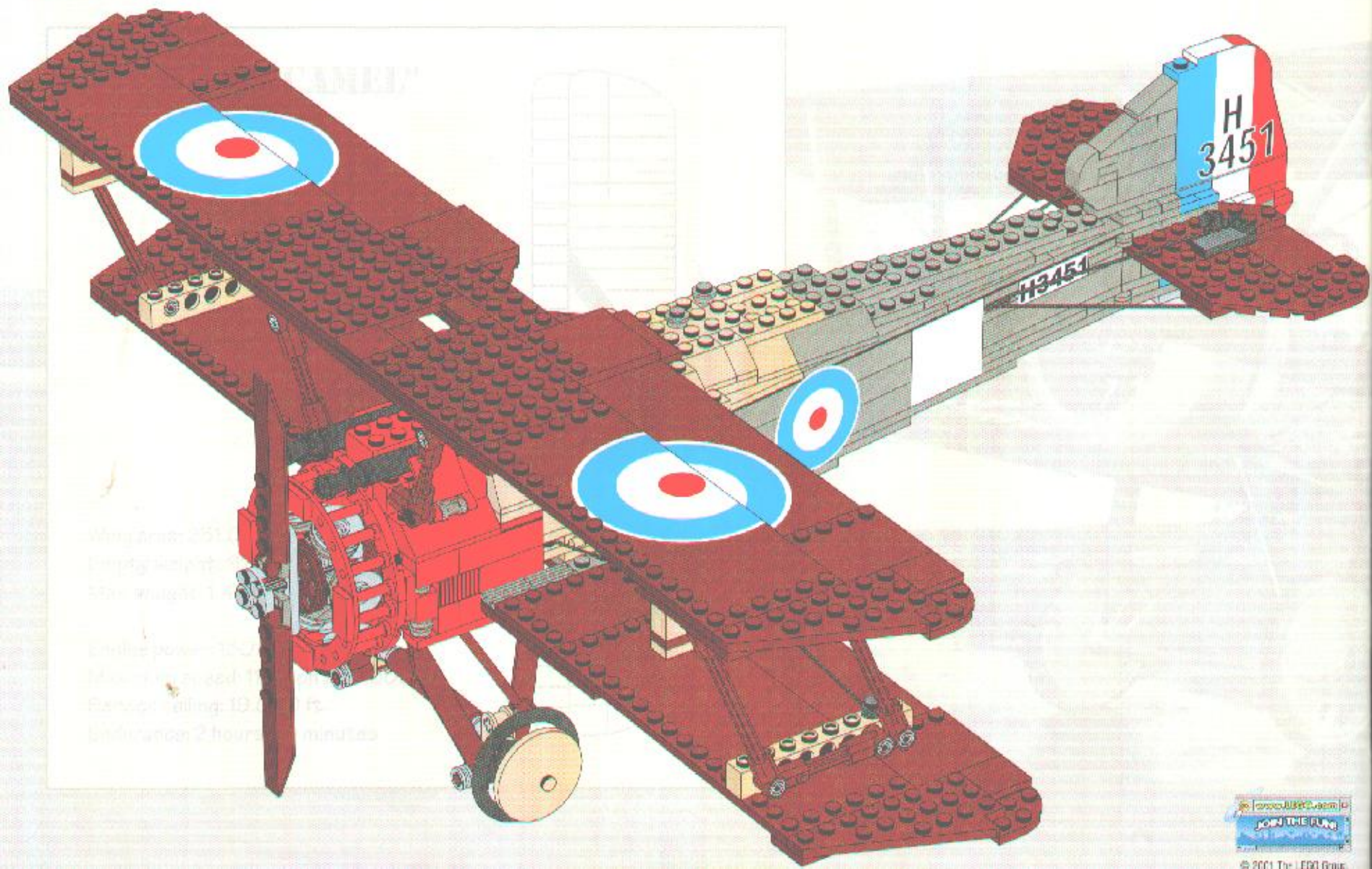

Wing Area: 251

Empty weight:

Main wing: 1

Engine power: 120

Maximum speed: 1

Range: 100 ft.

Endurance: 2 hours

minutes



CC

H3451

H3451

