

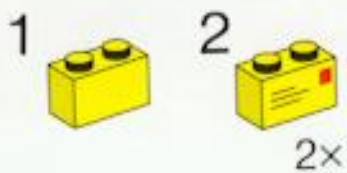

4558





1

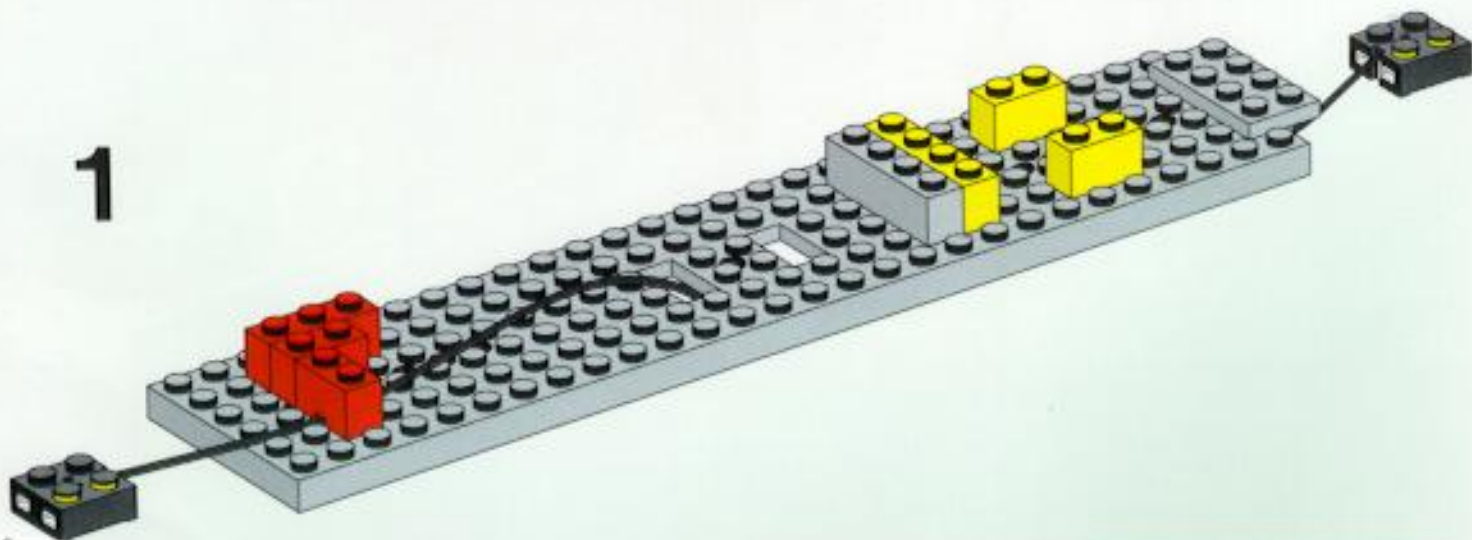

2

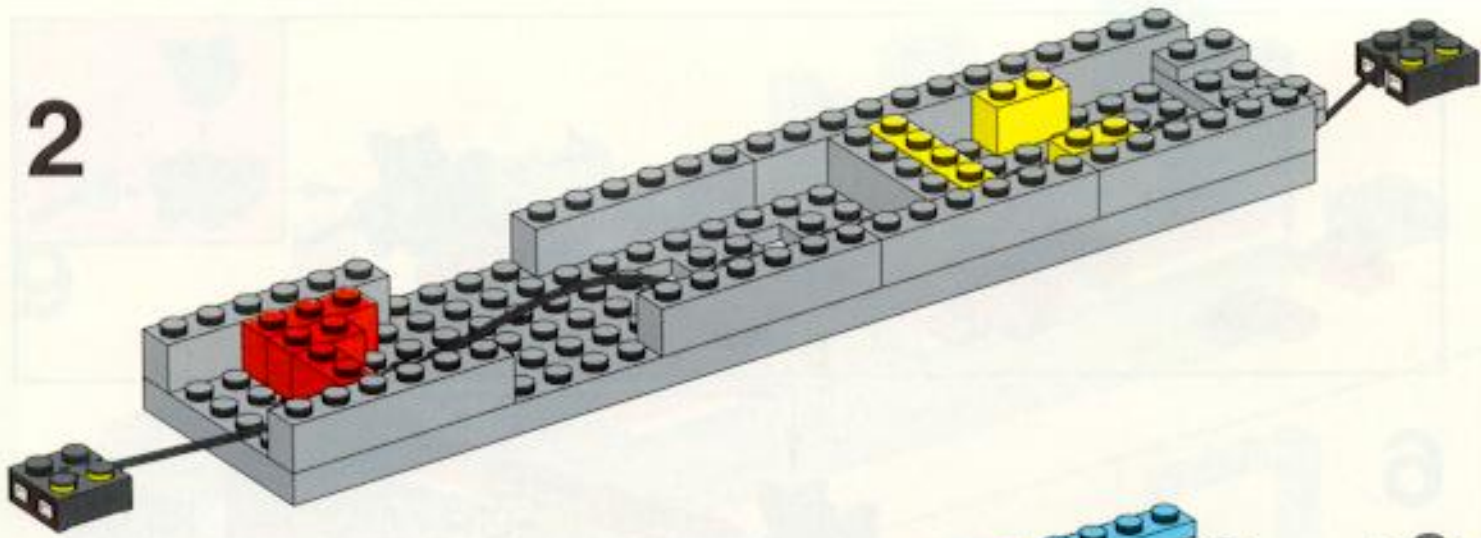

3

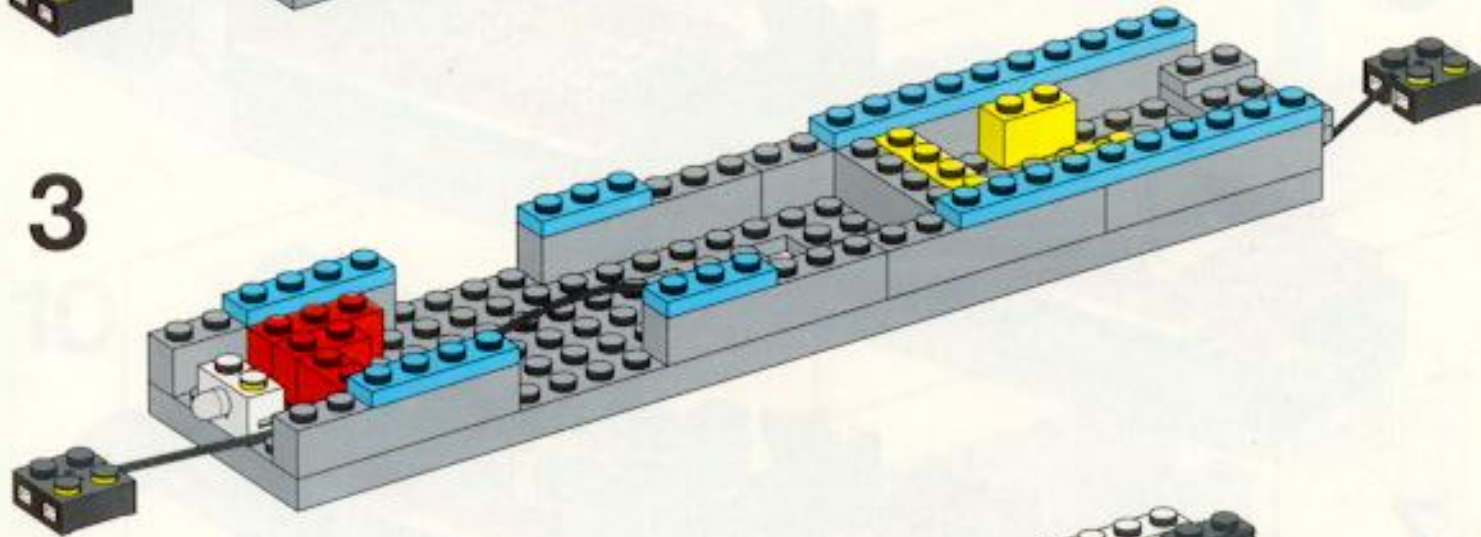

4

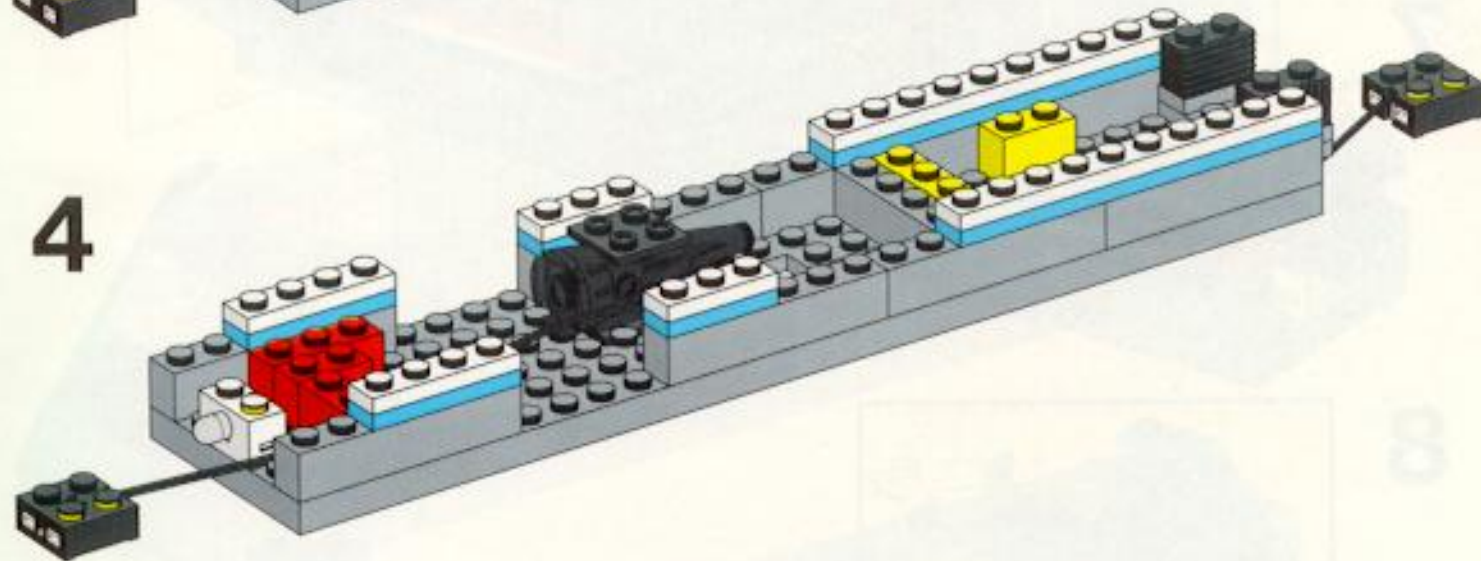

5

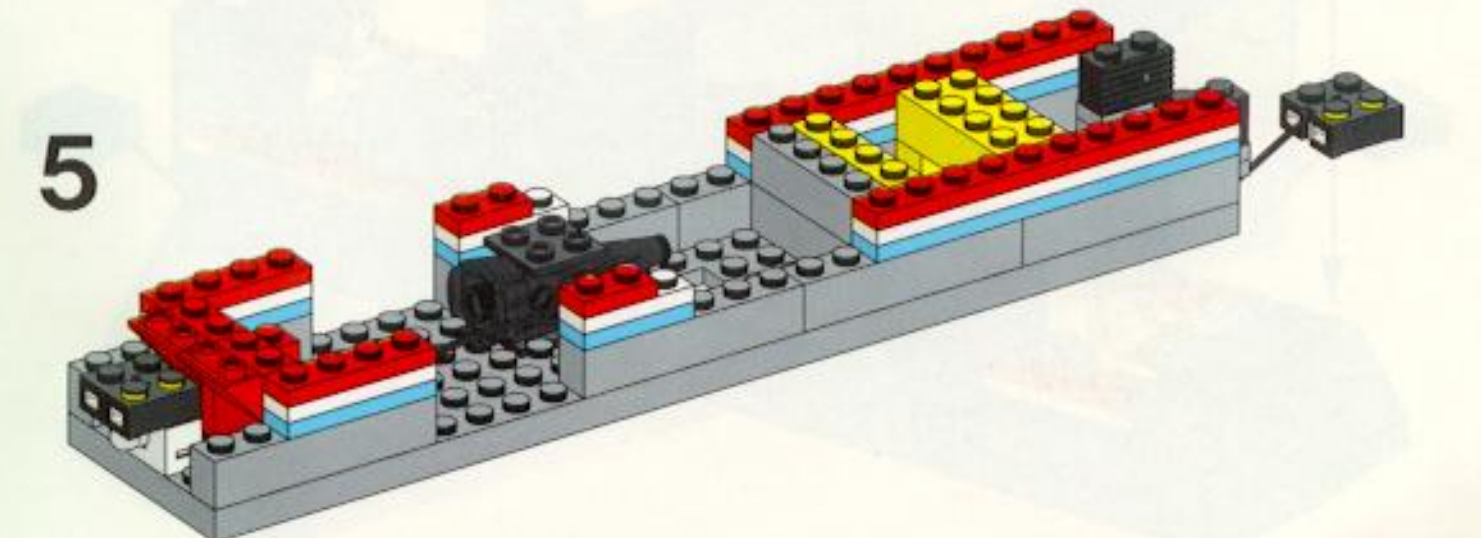

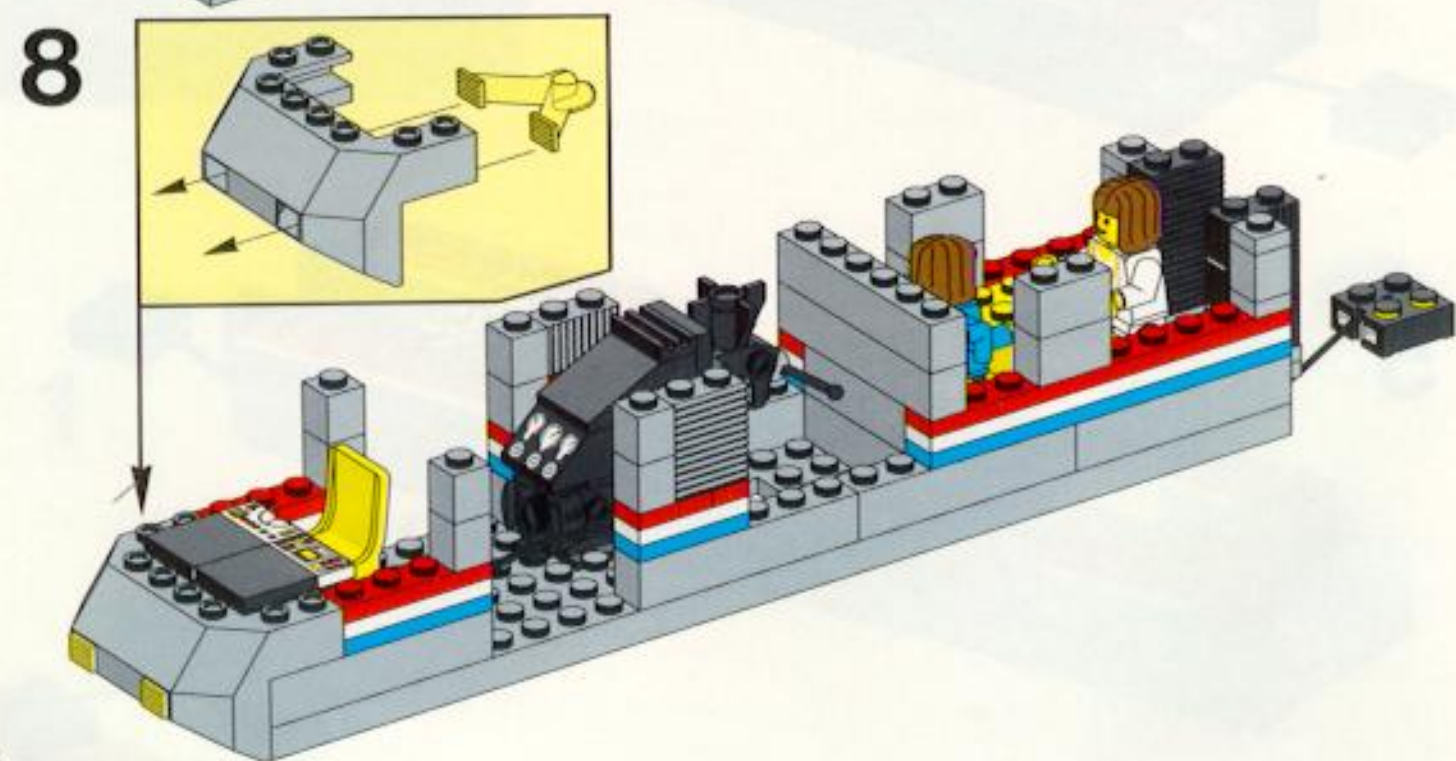
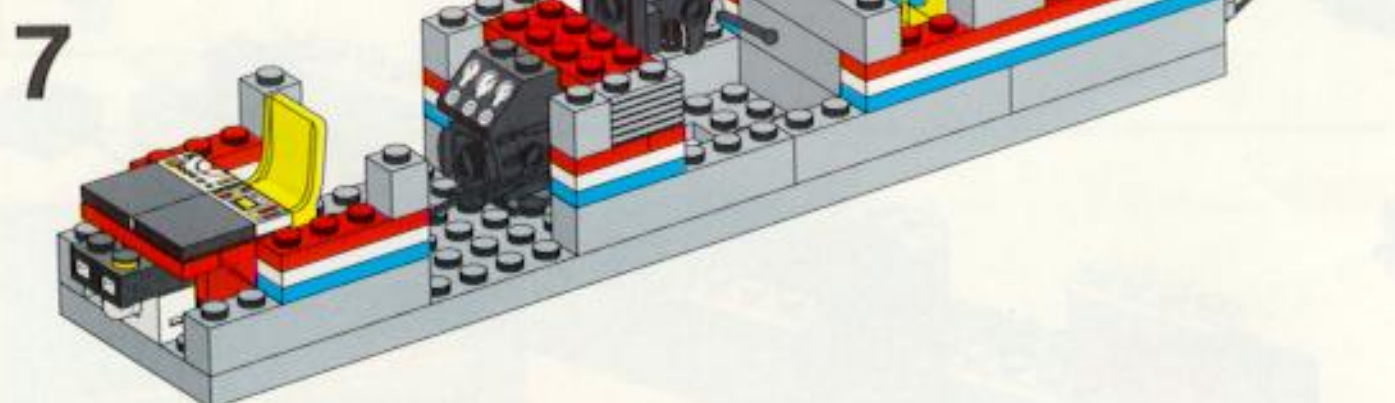
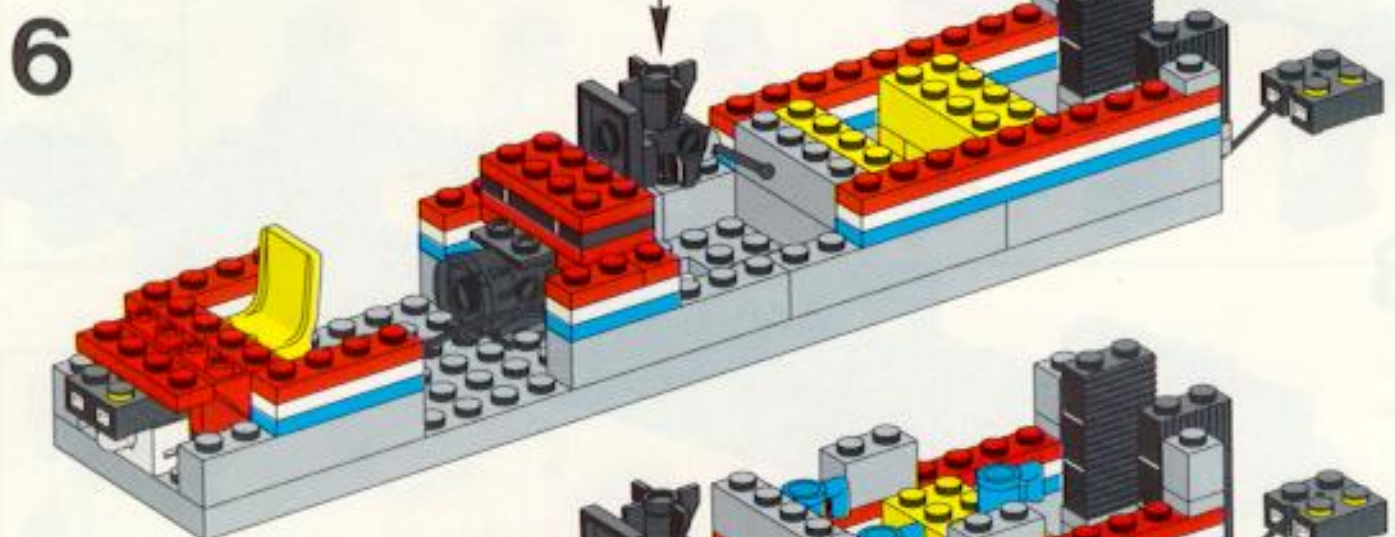
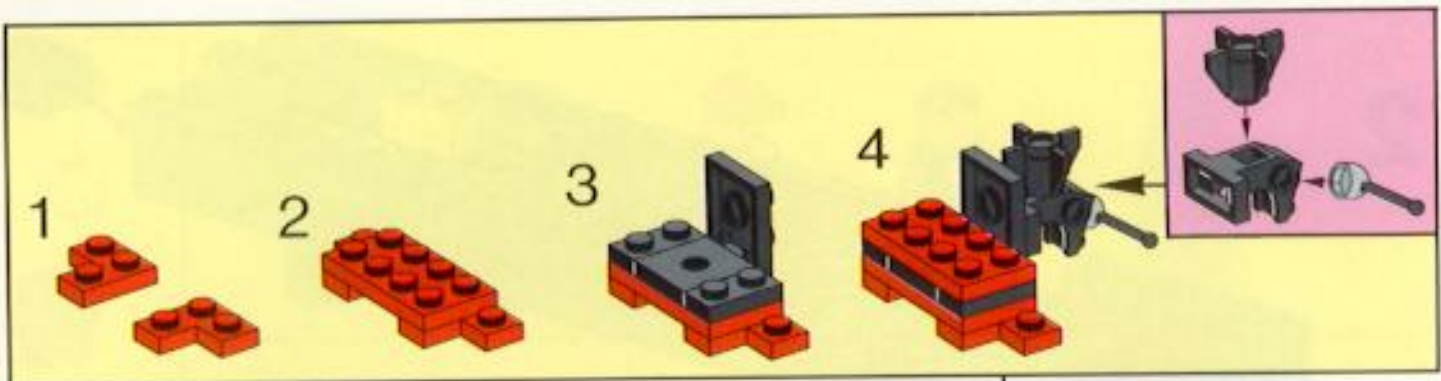

9

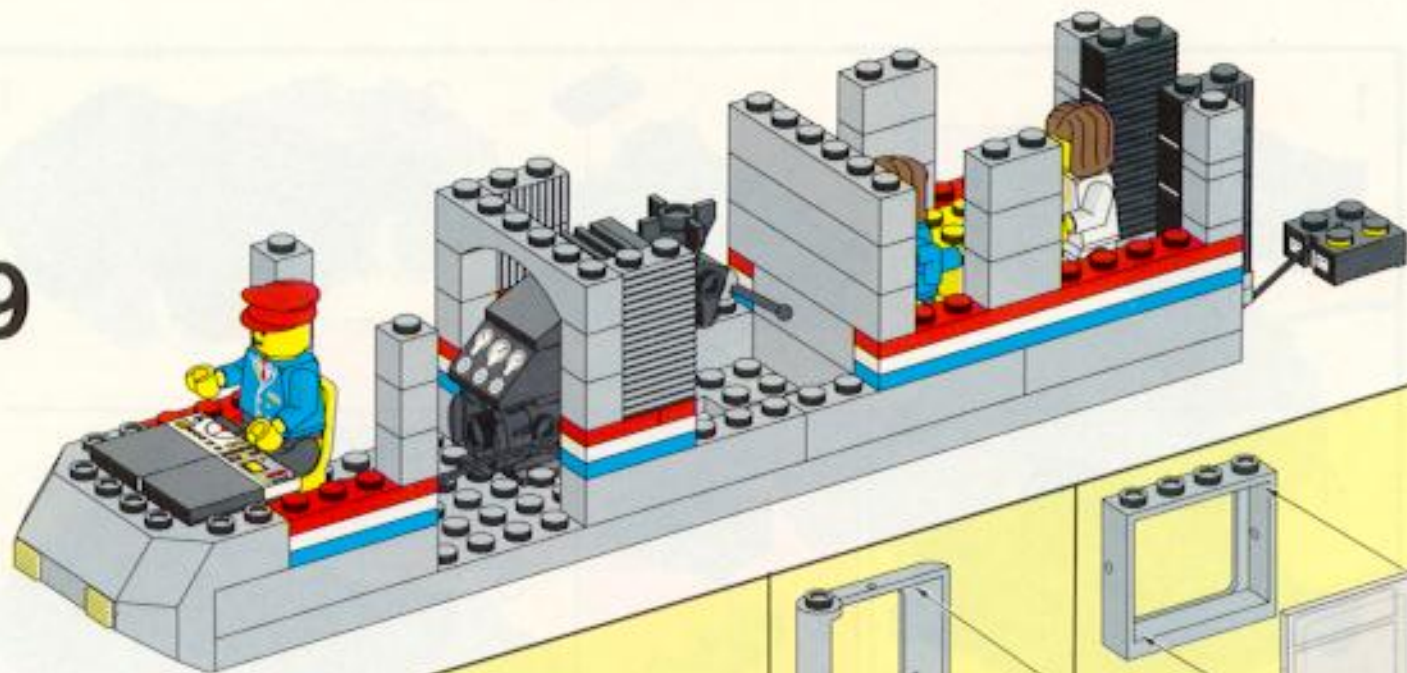

10

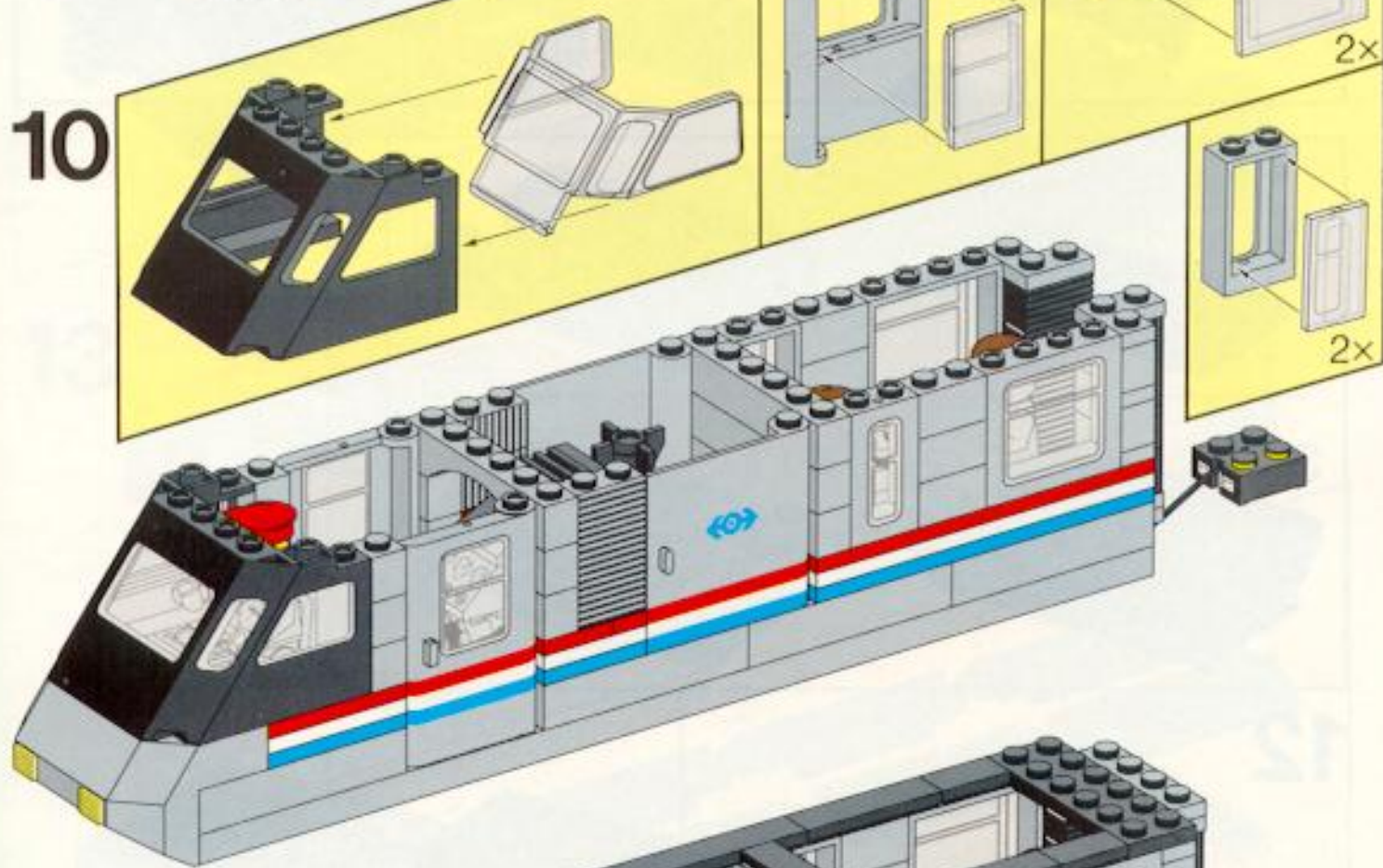

11

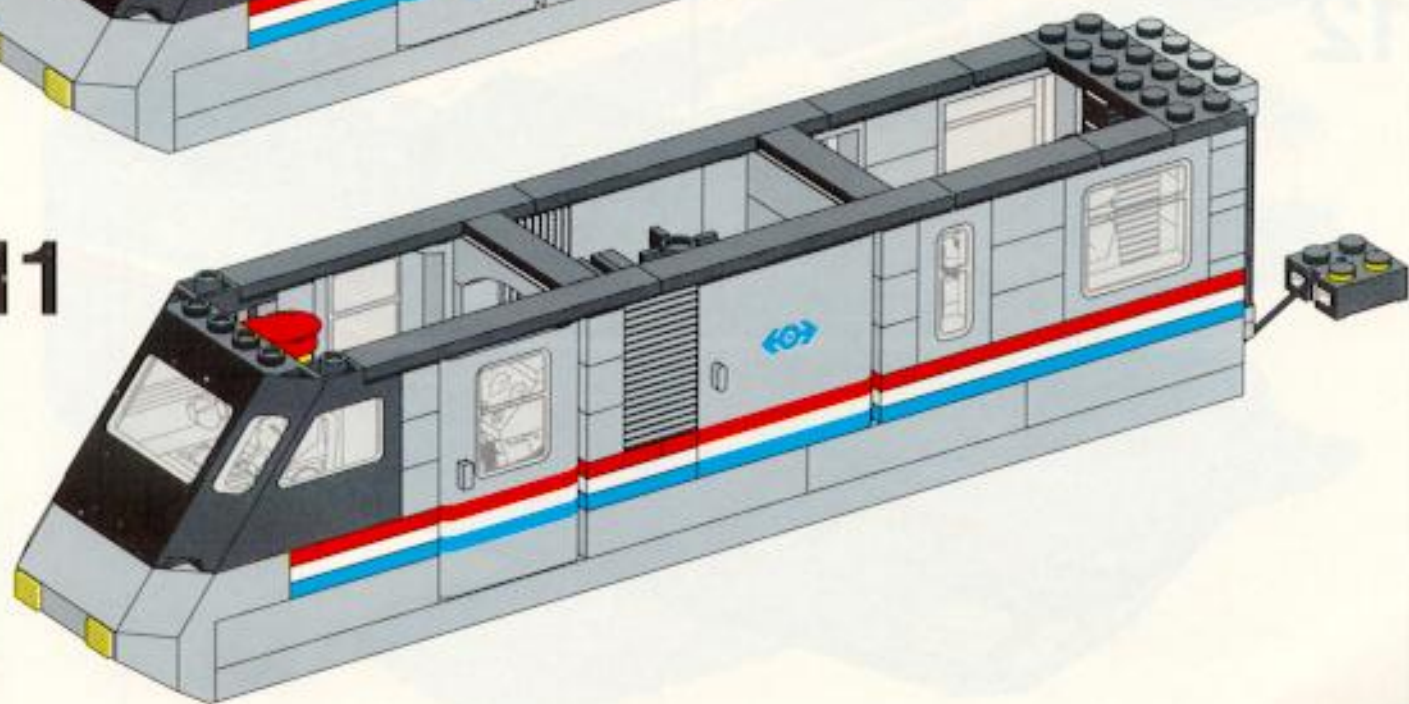

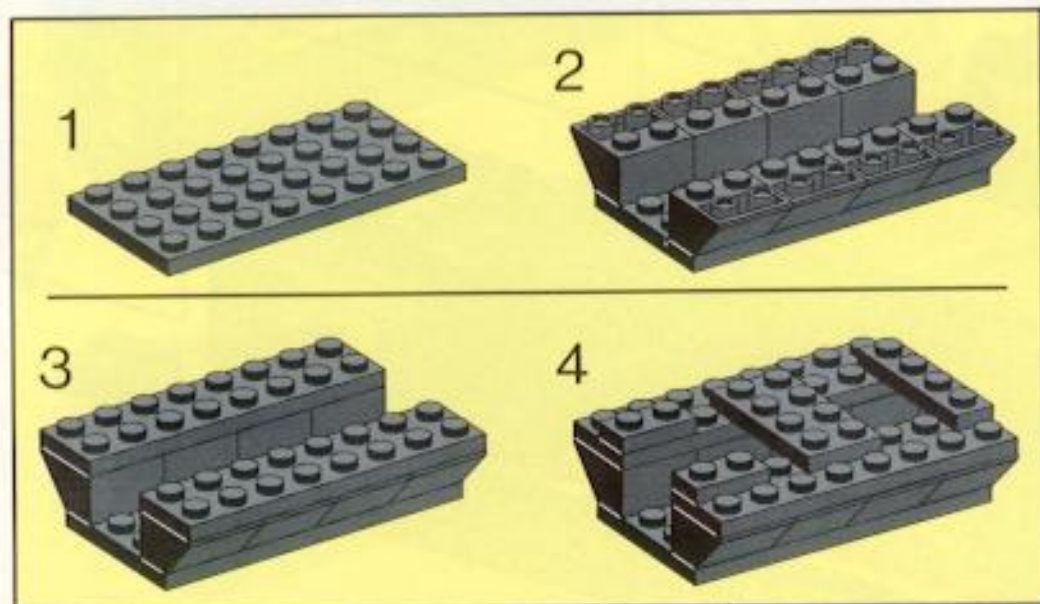
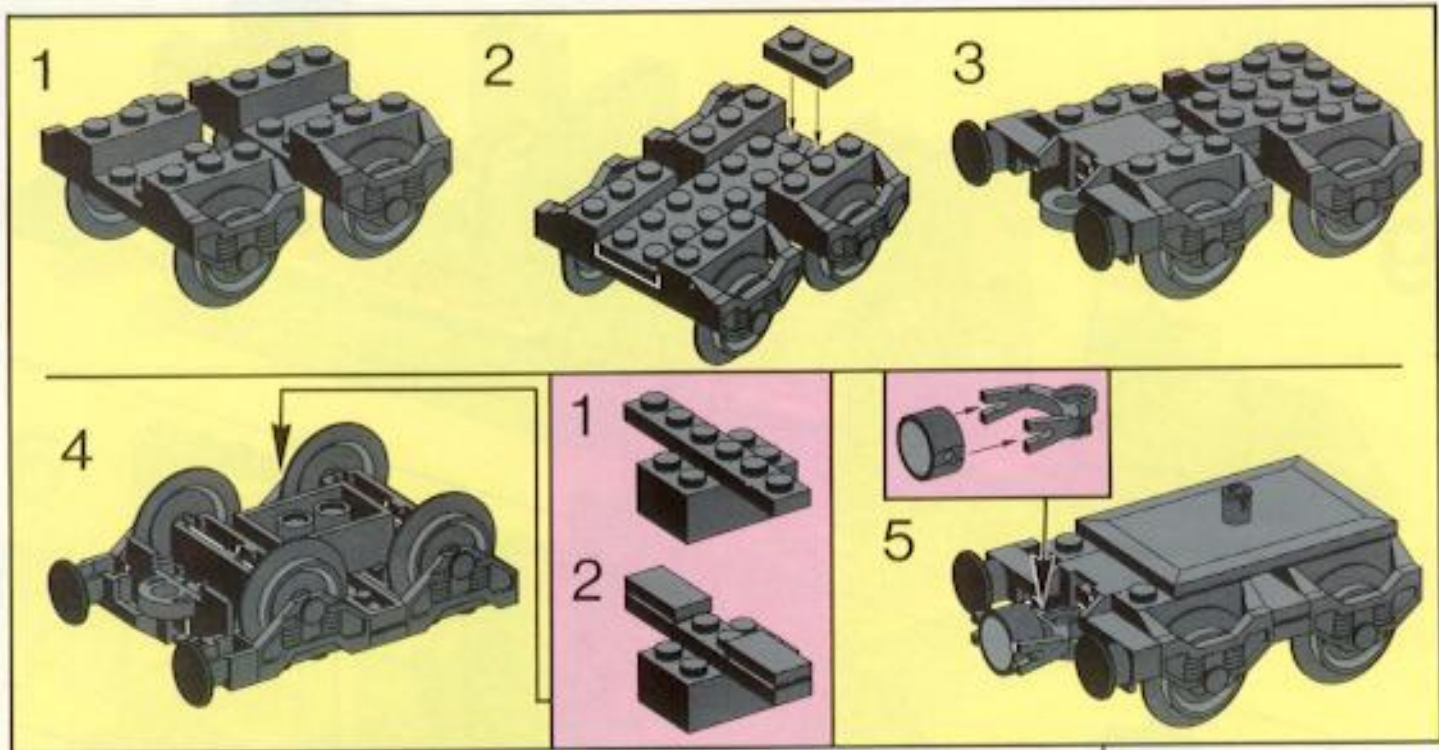

12

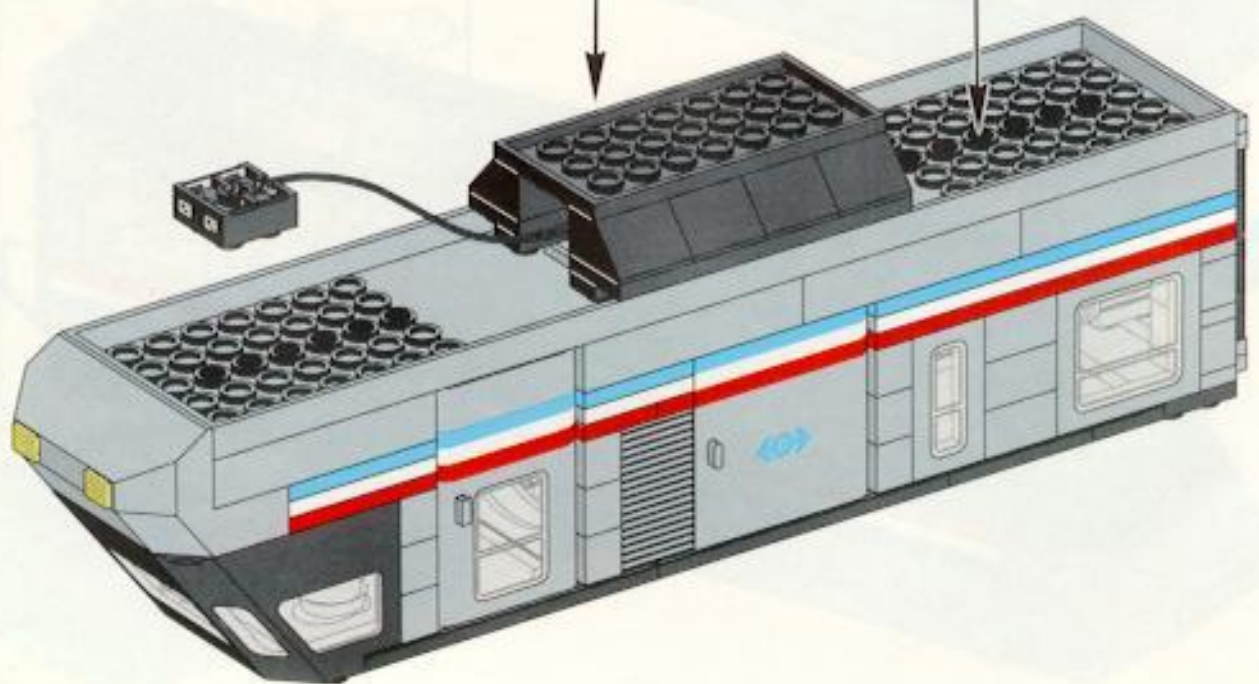



3



13

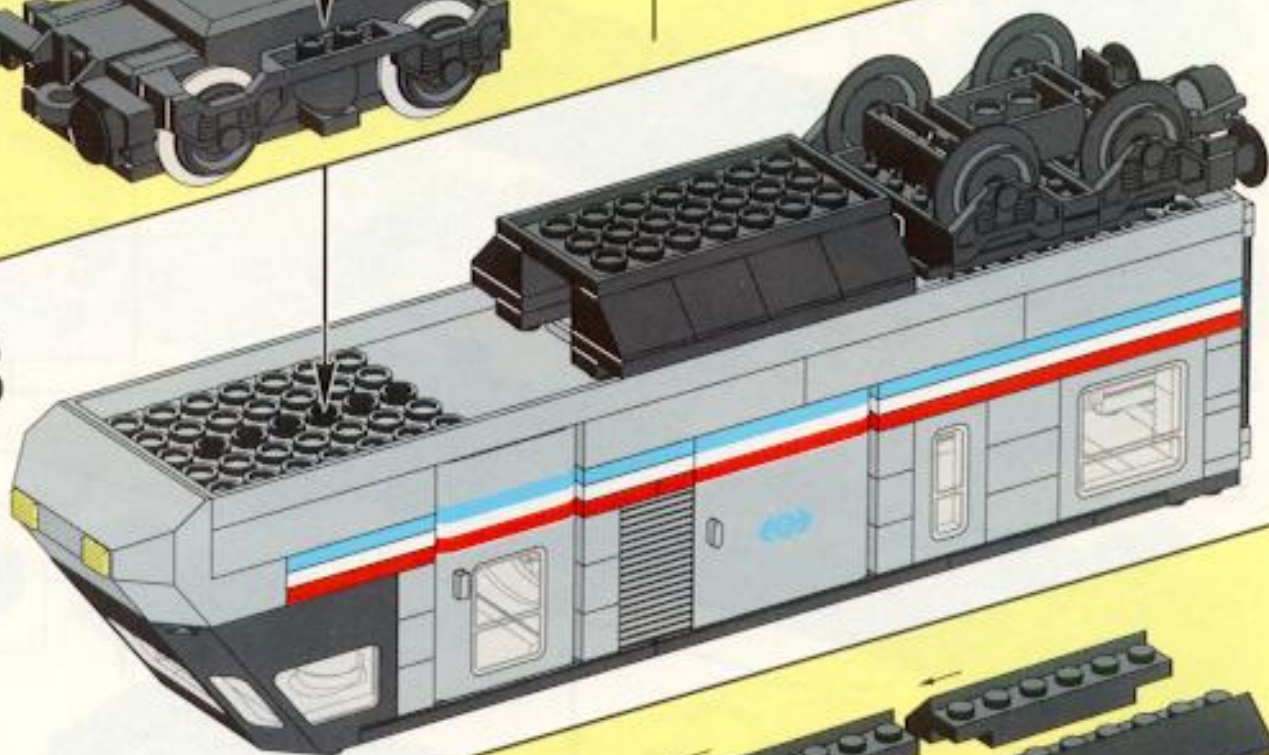

1

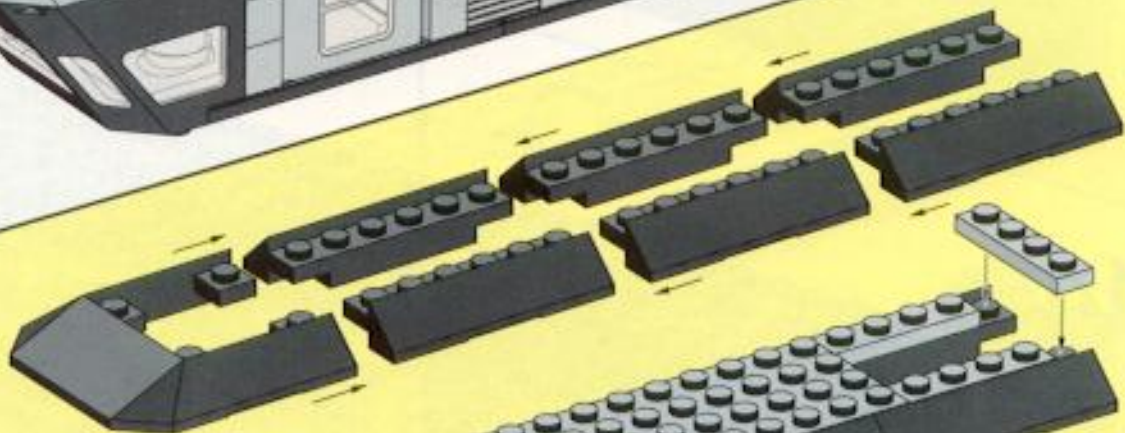

2



3



4

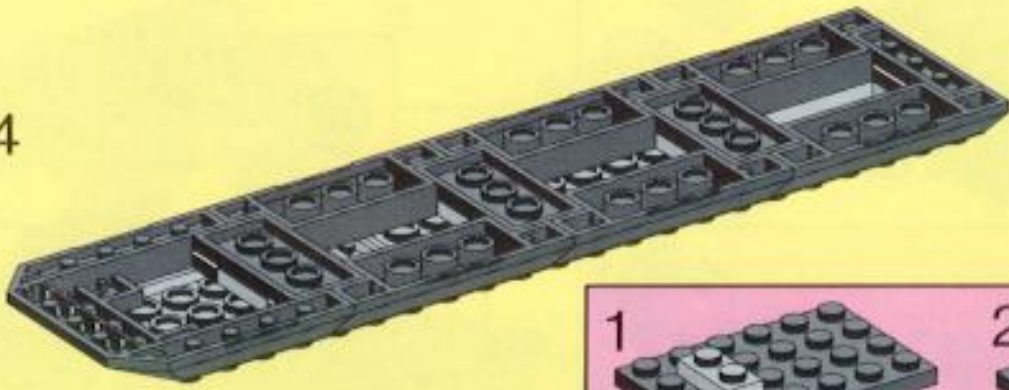

1



2

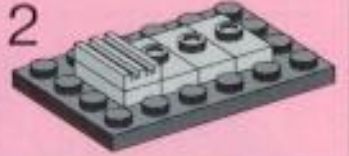

5

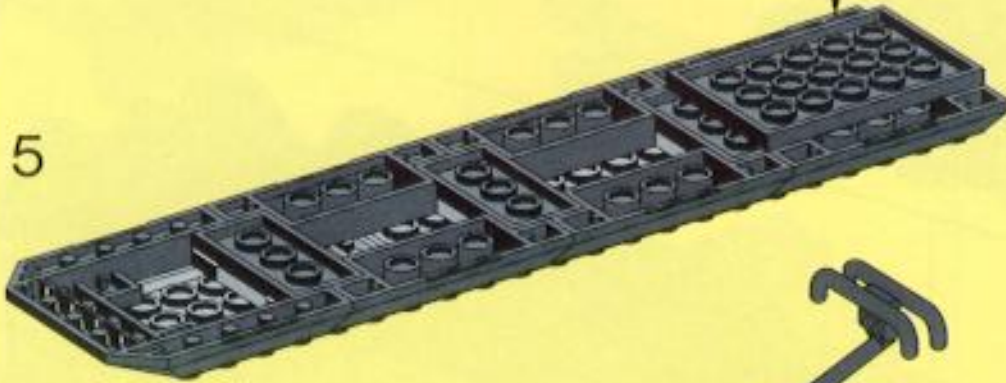

6

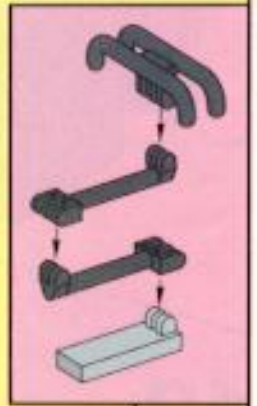
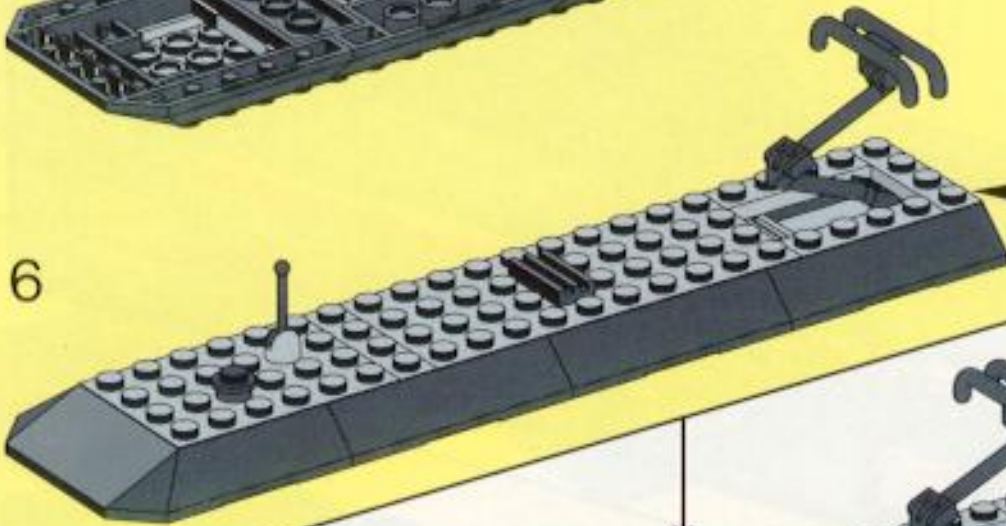

14

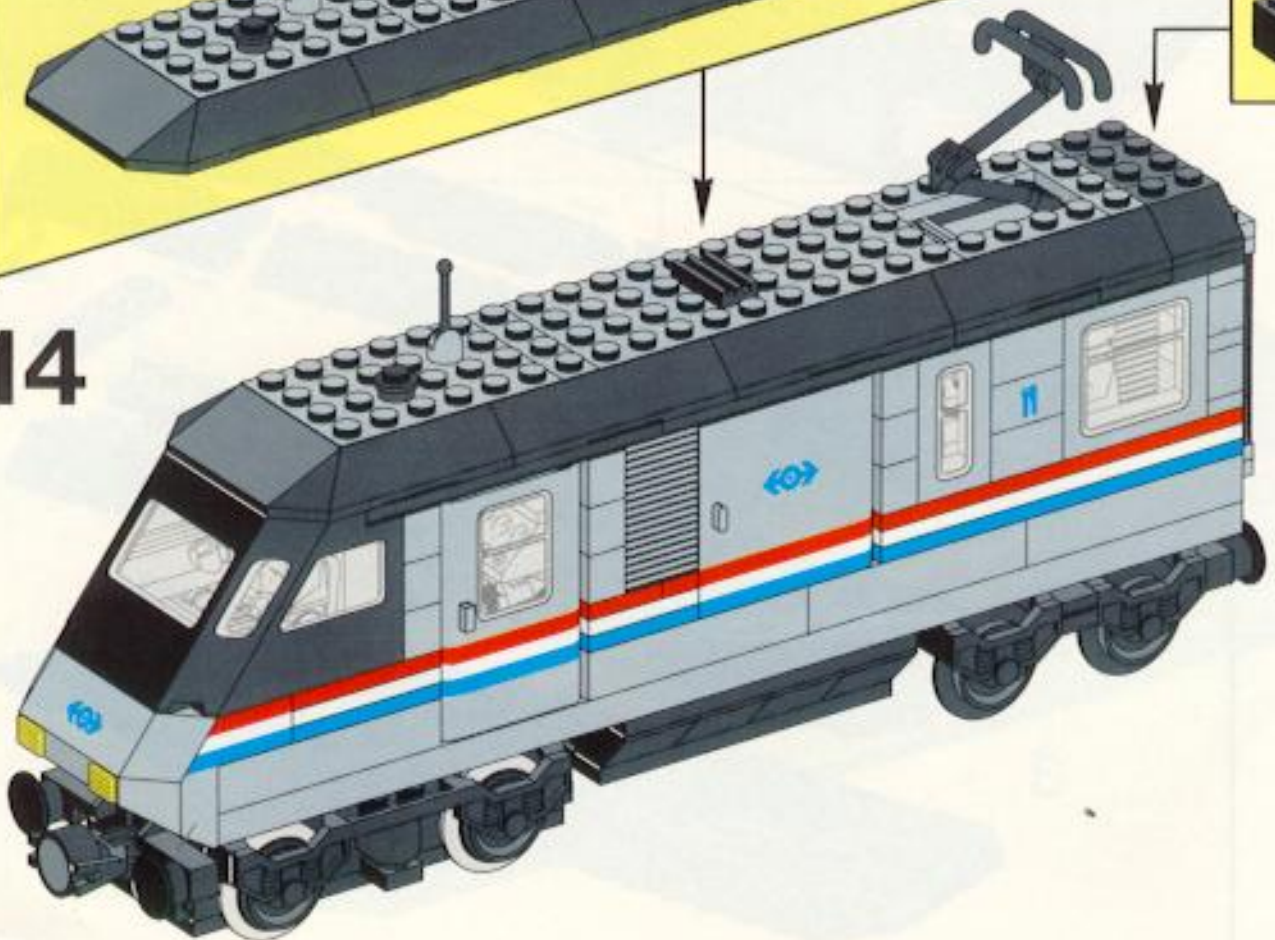



1

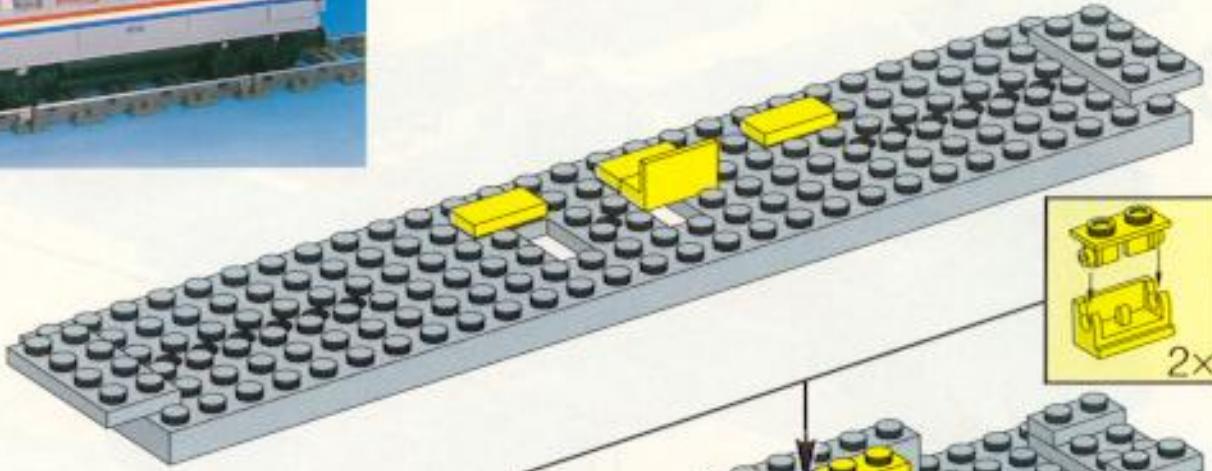

2

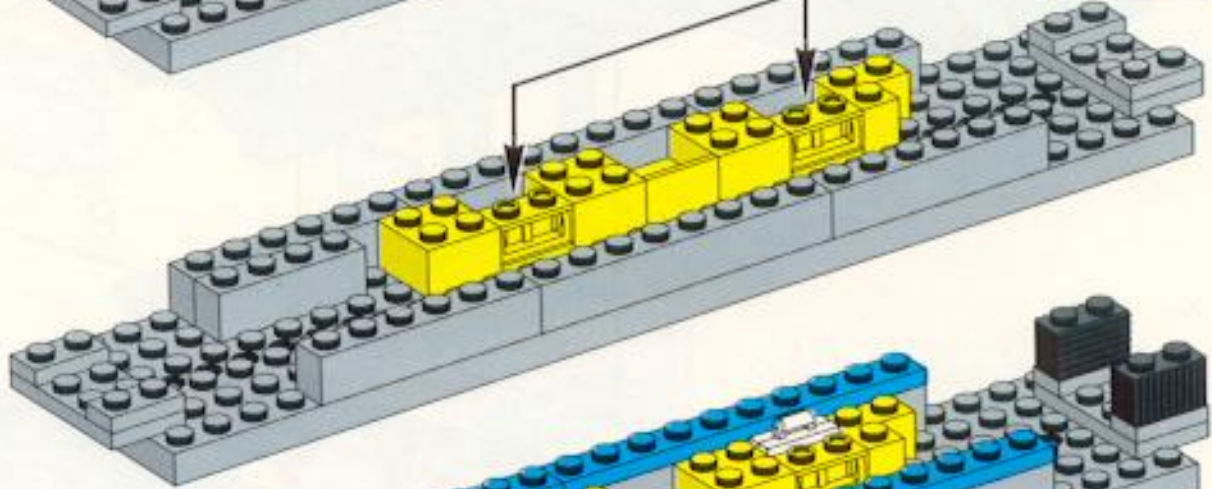

3

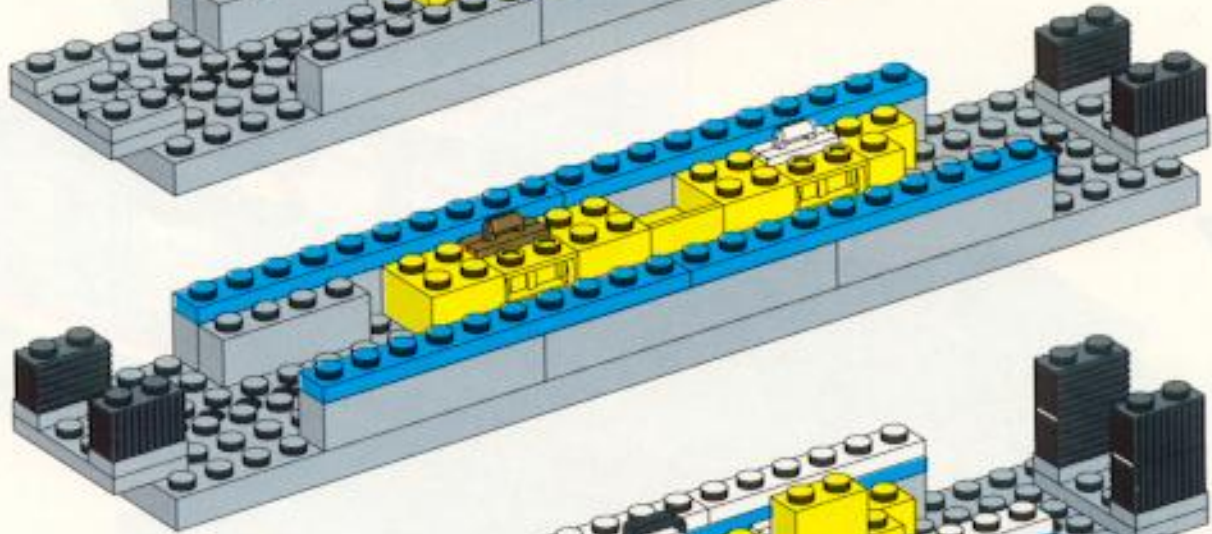

4

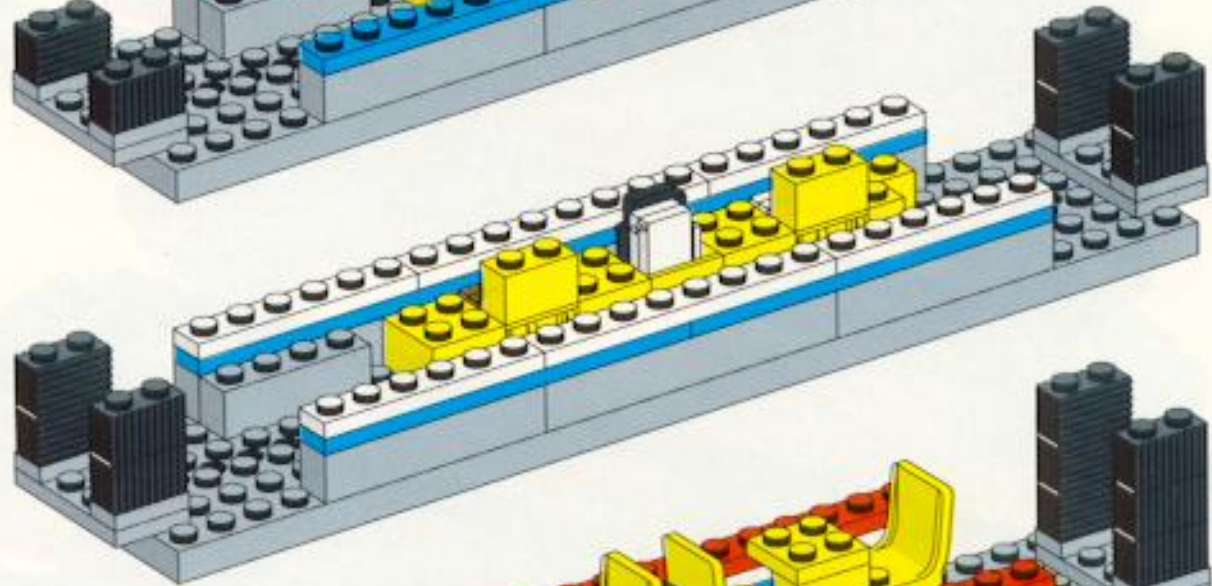

5

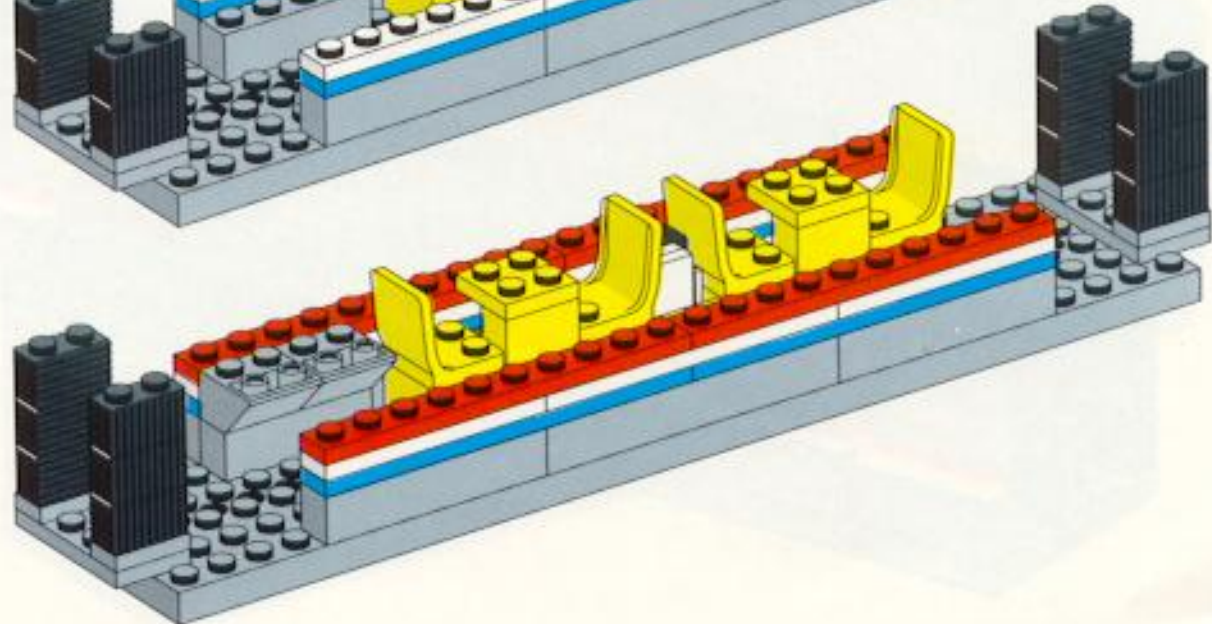

6

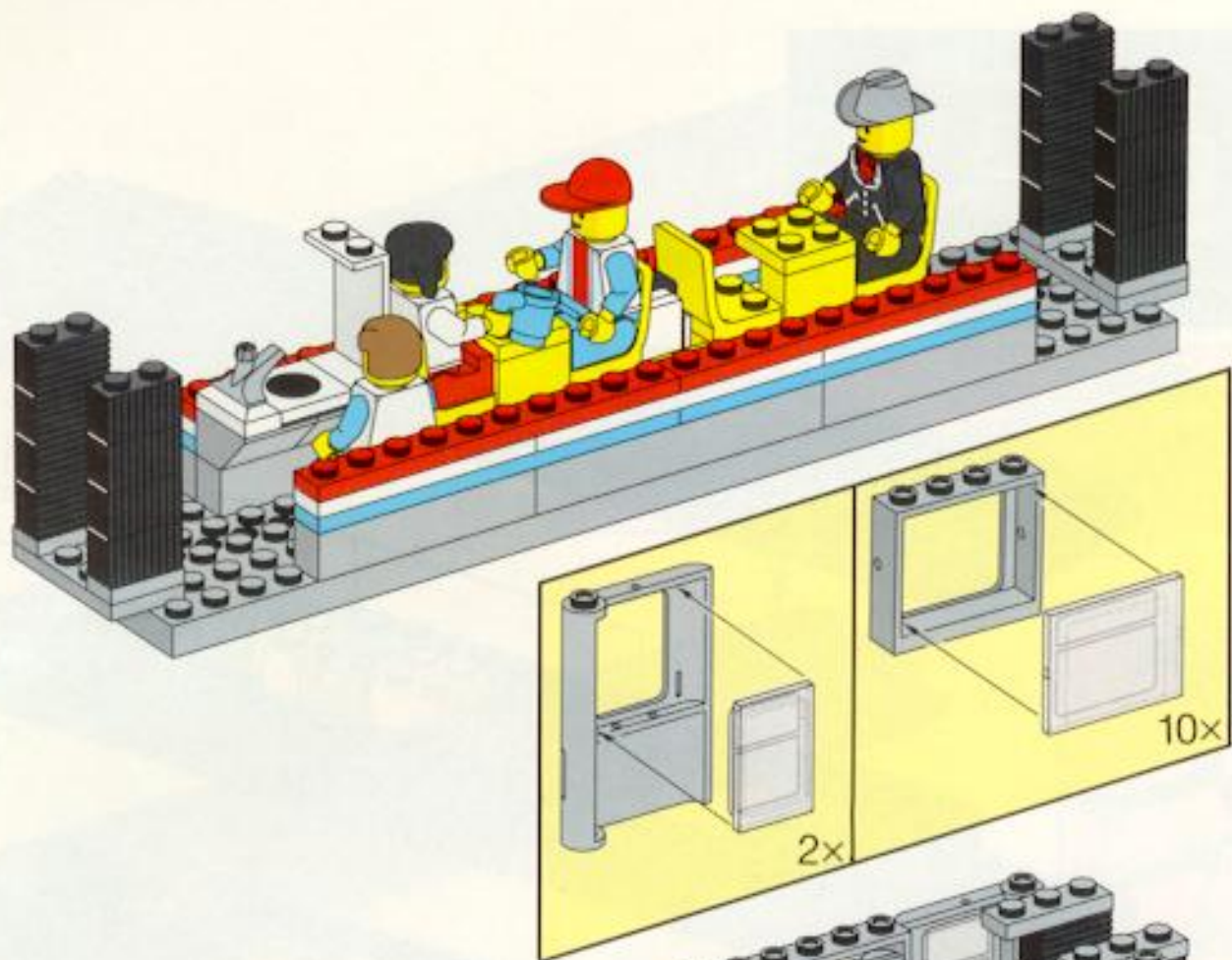

7

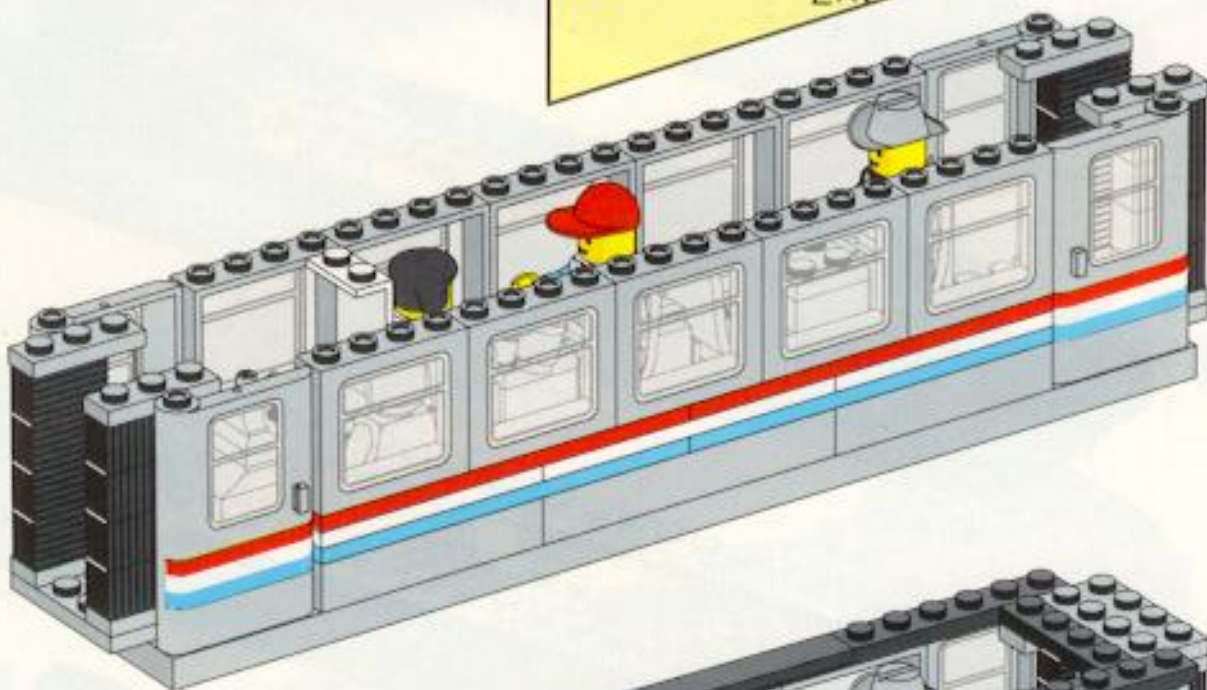

8

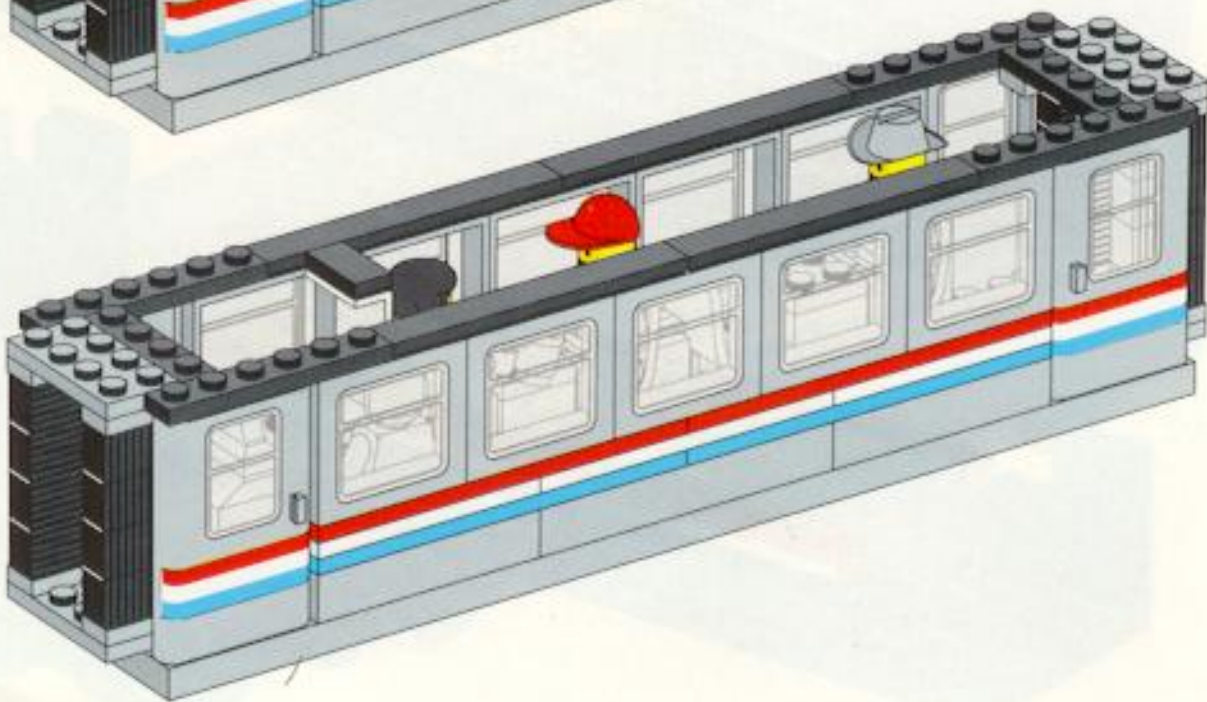

1

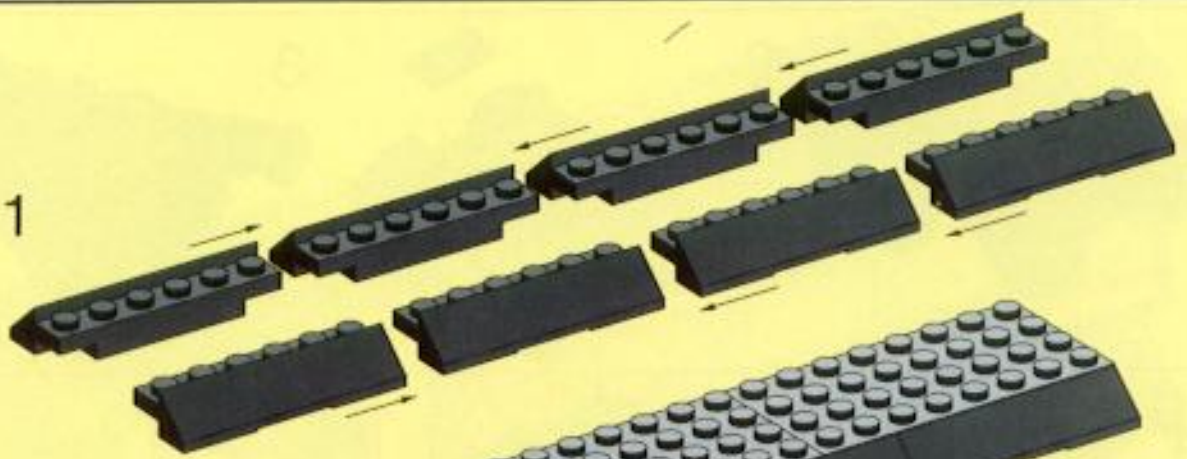

2

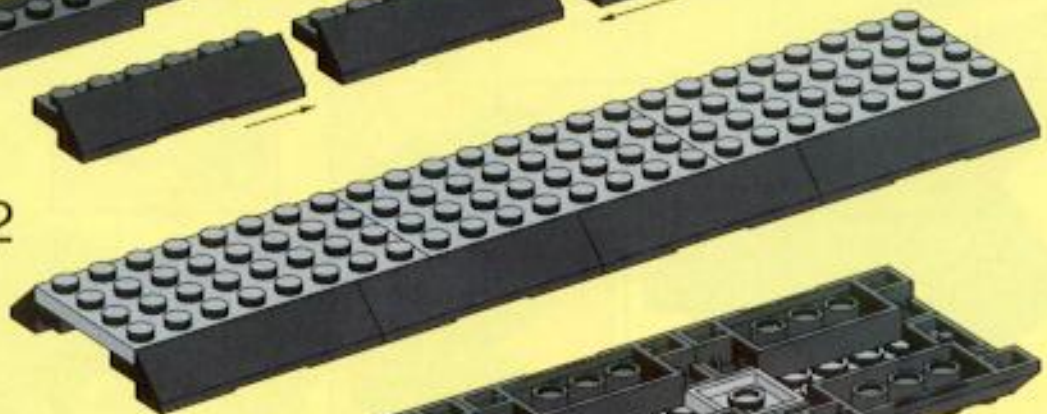

3

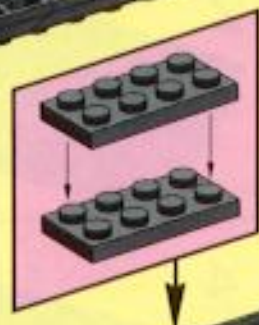
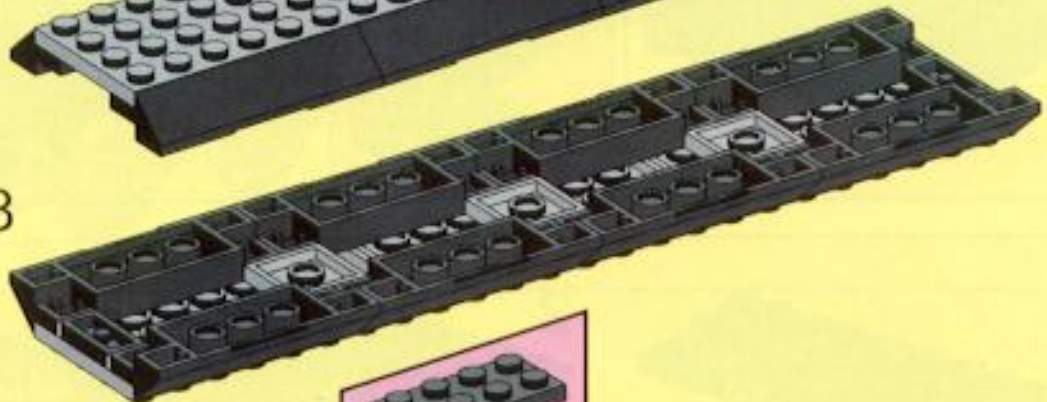

4

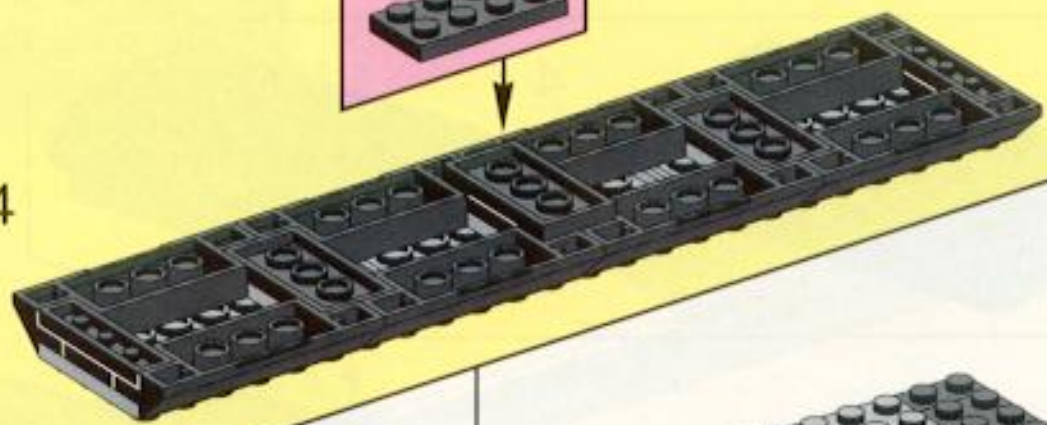

9

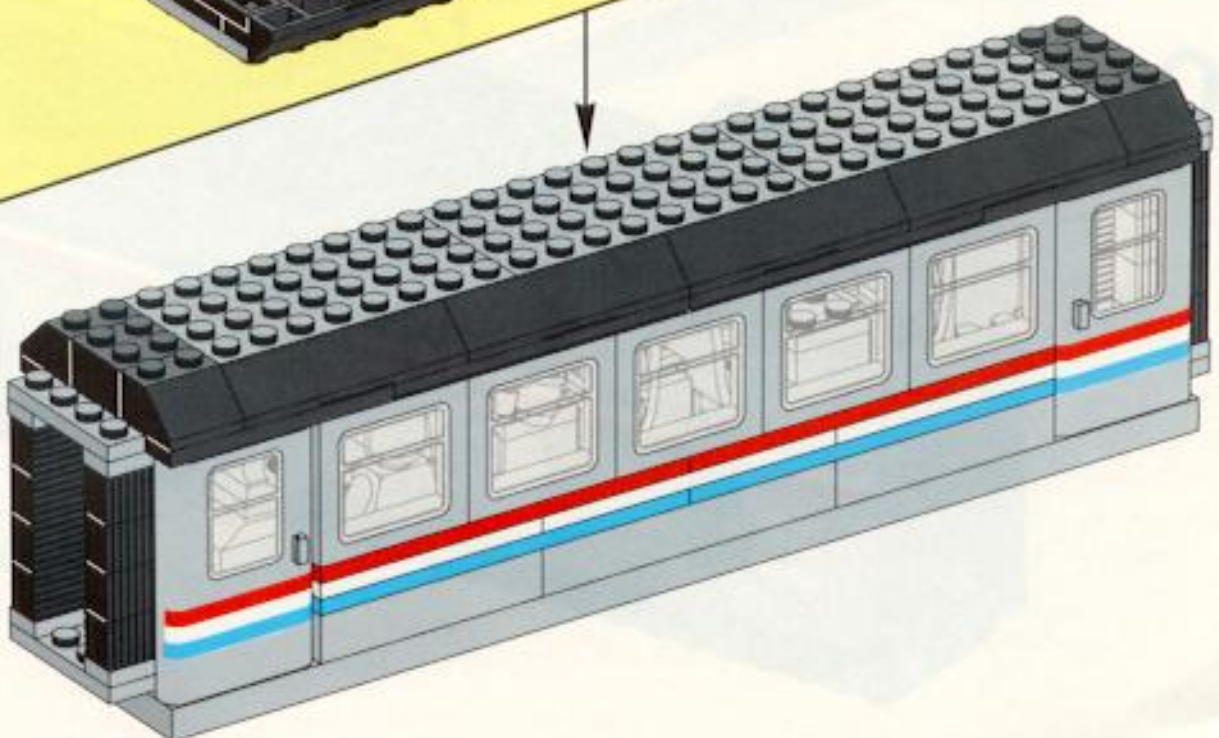

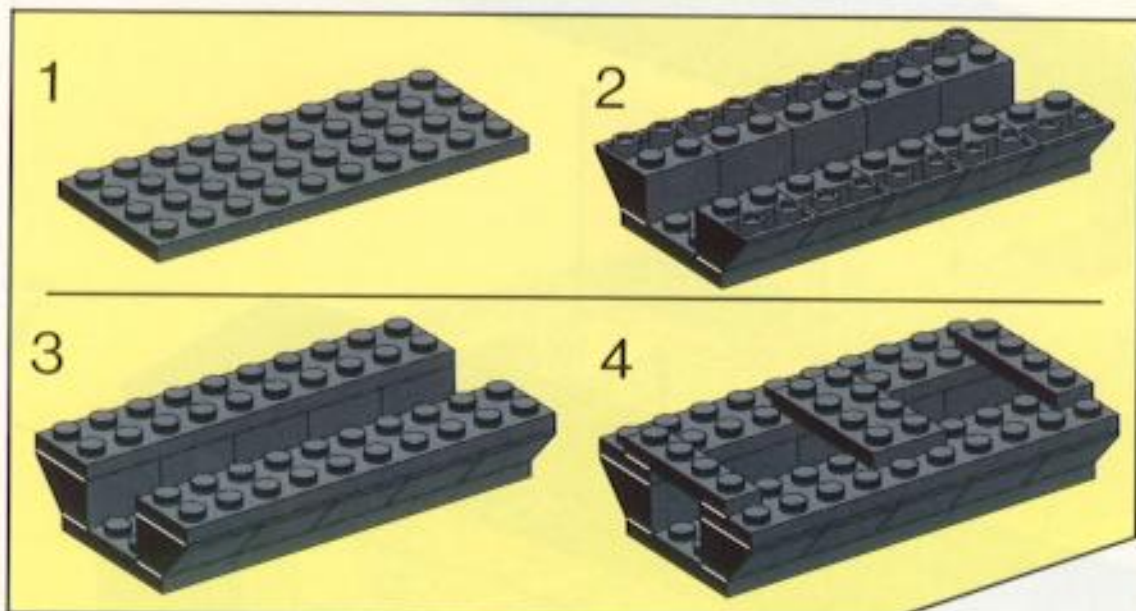
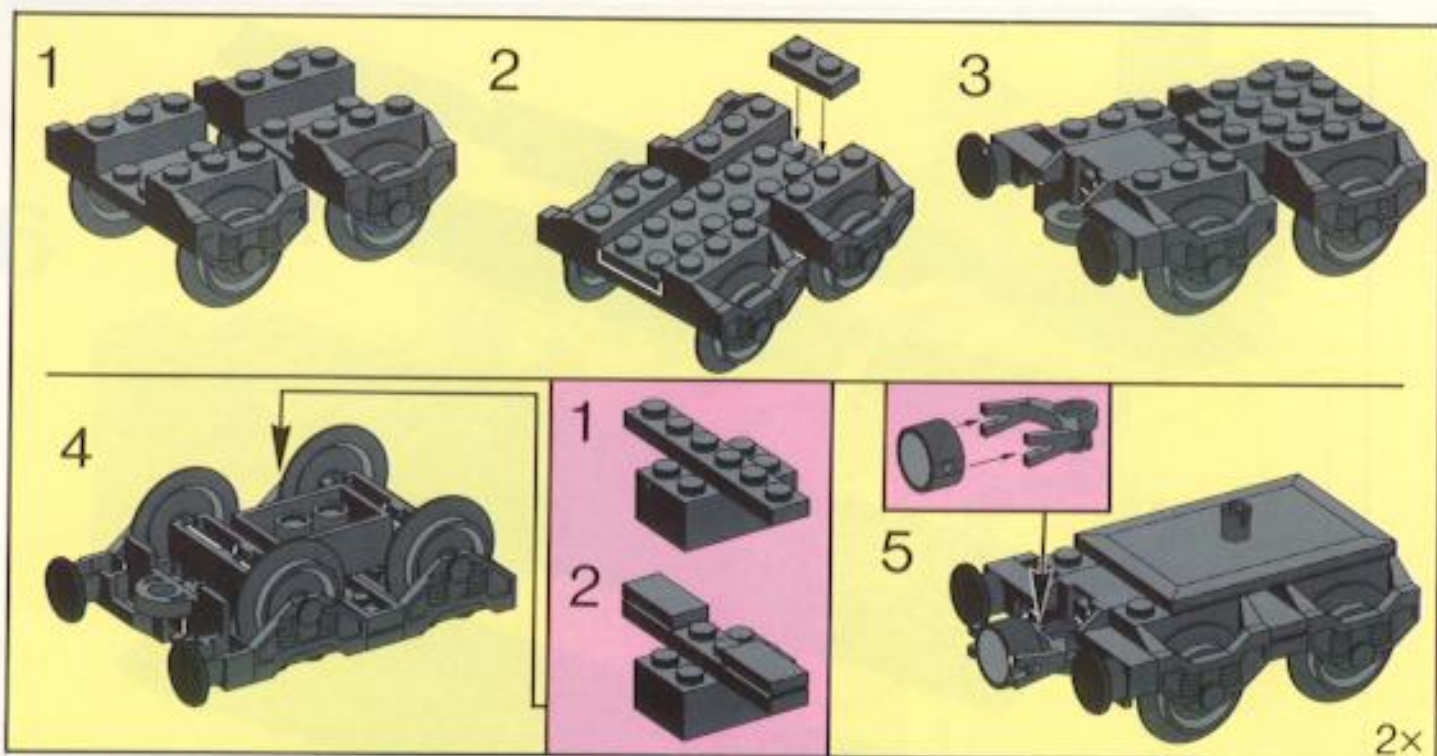

10

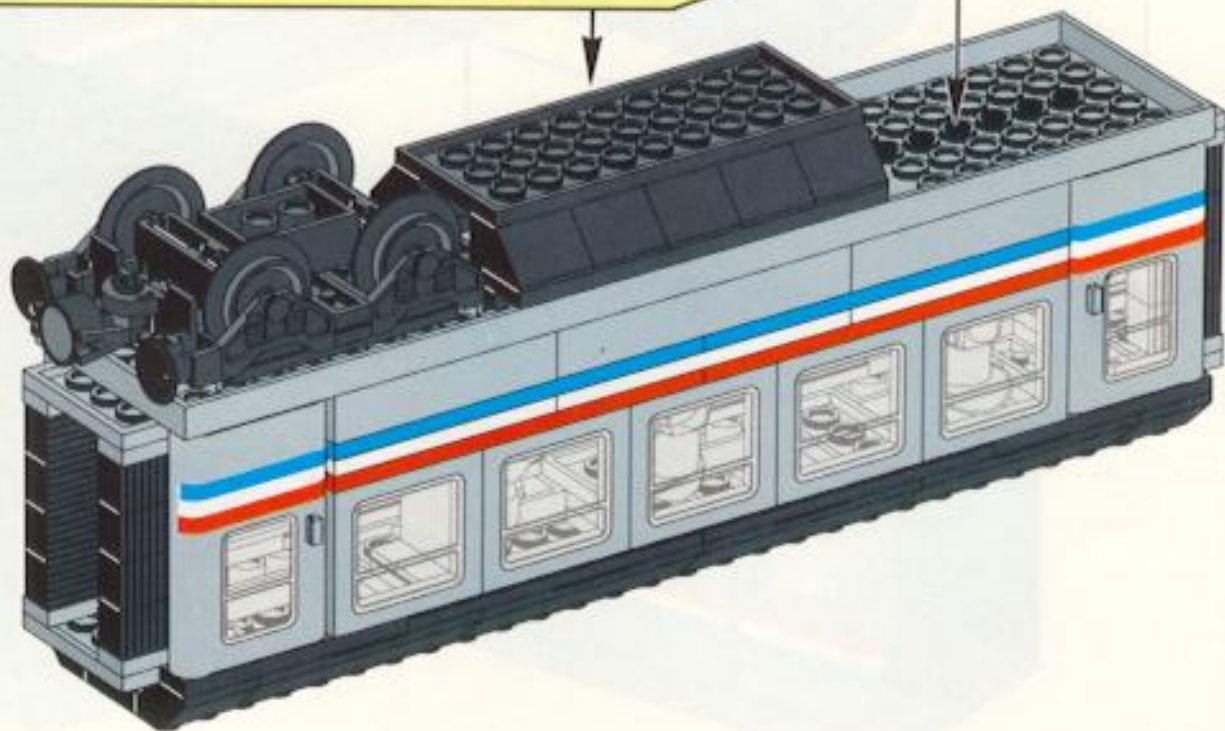

11



1

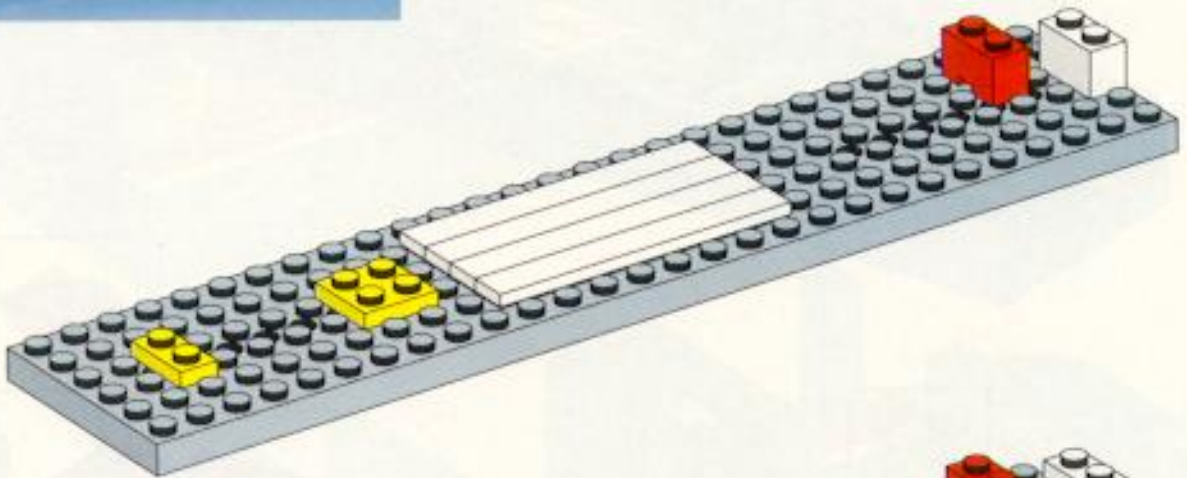

2

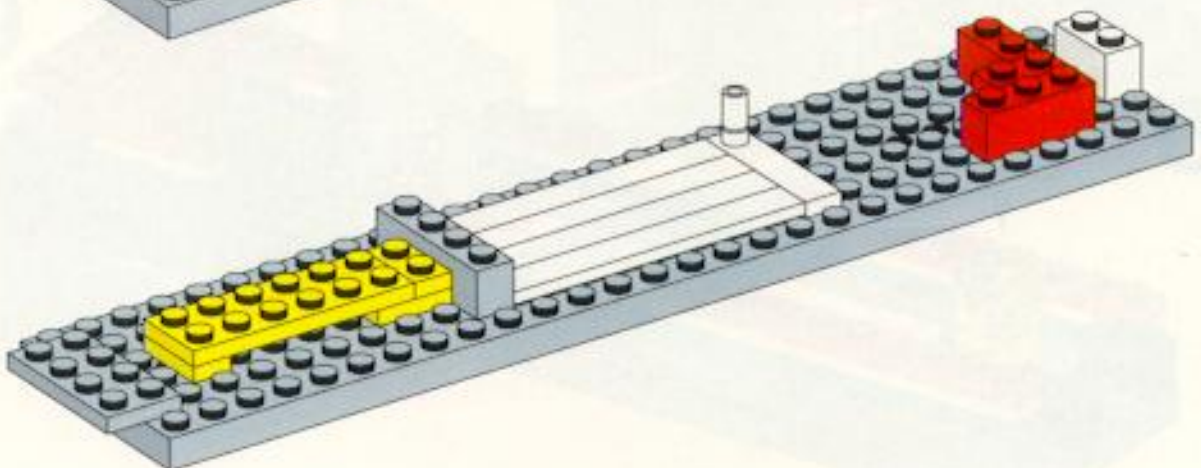

3

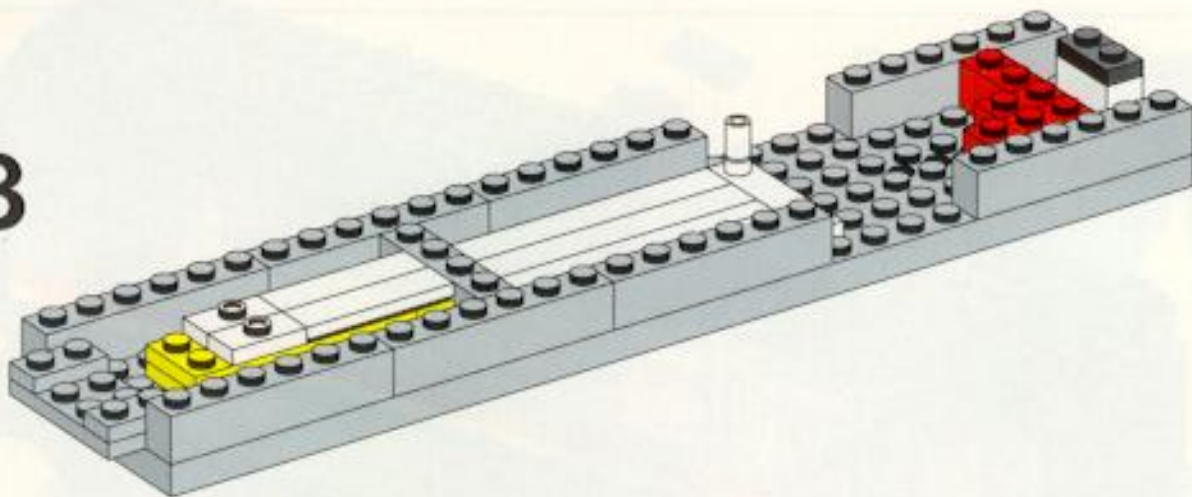

4

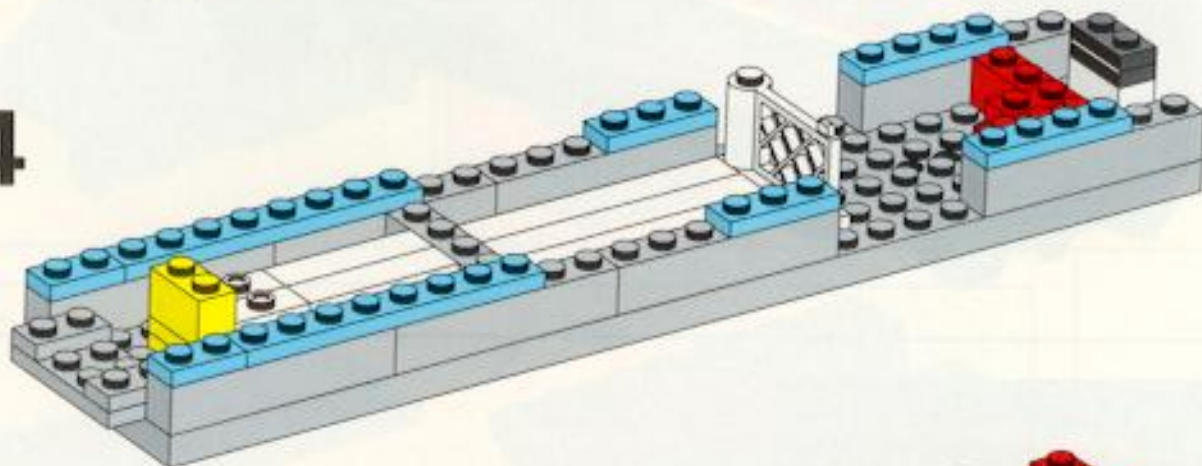

5

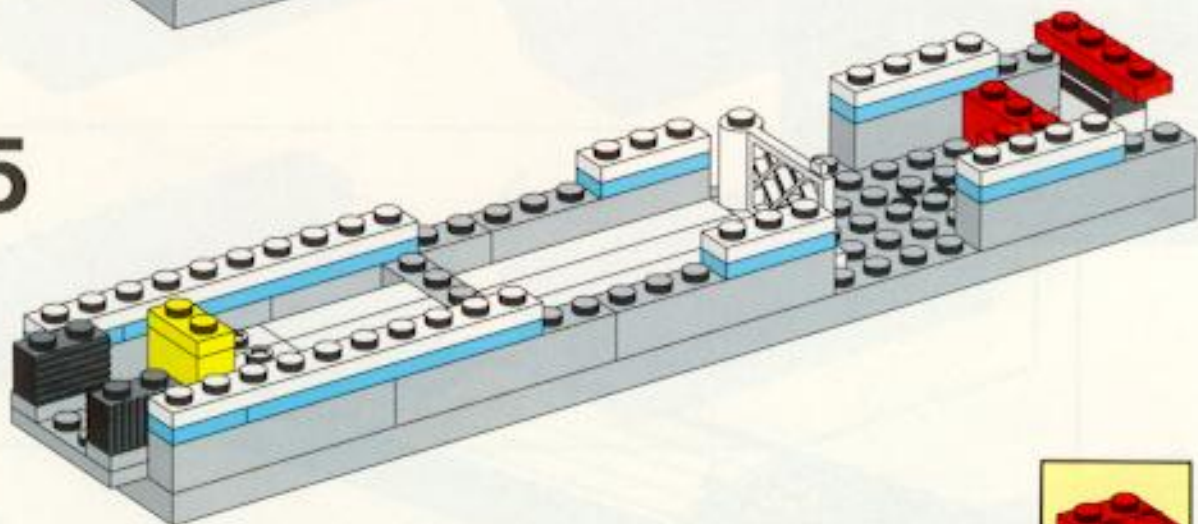

6

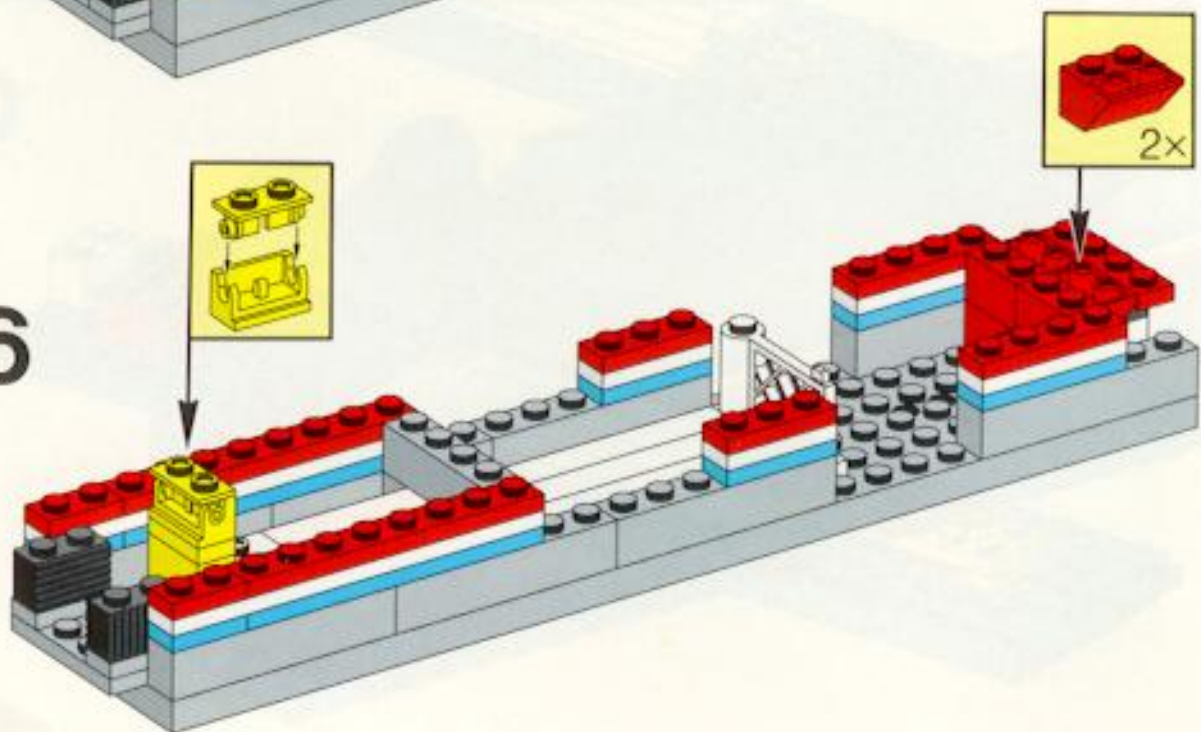

7

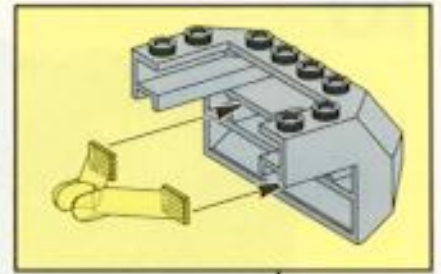
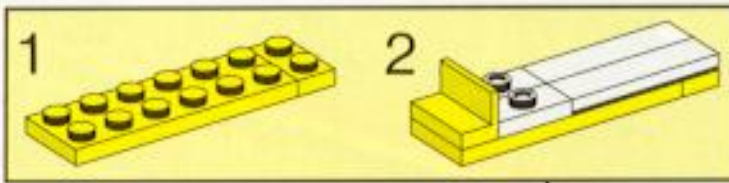
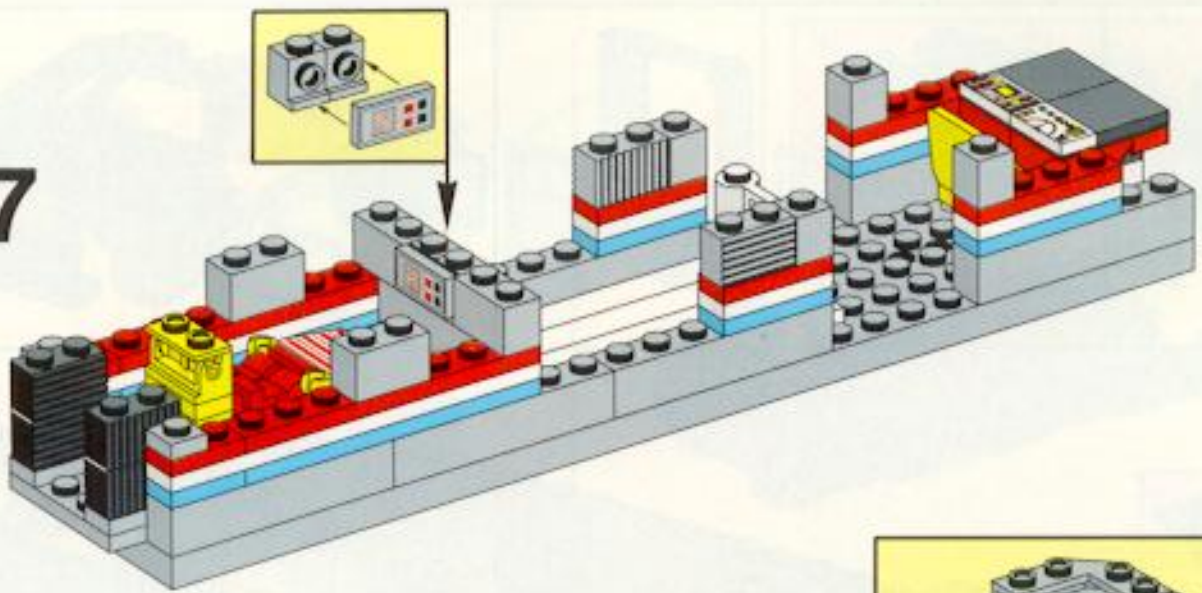

8

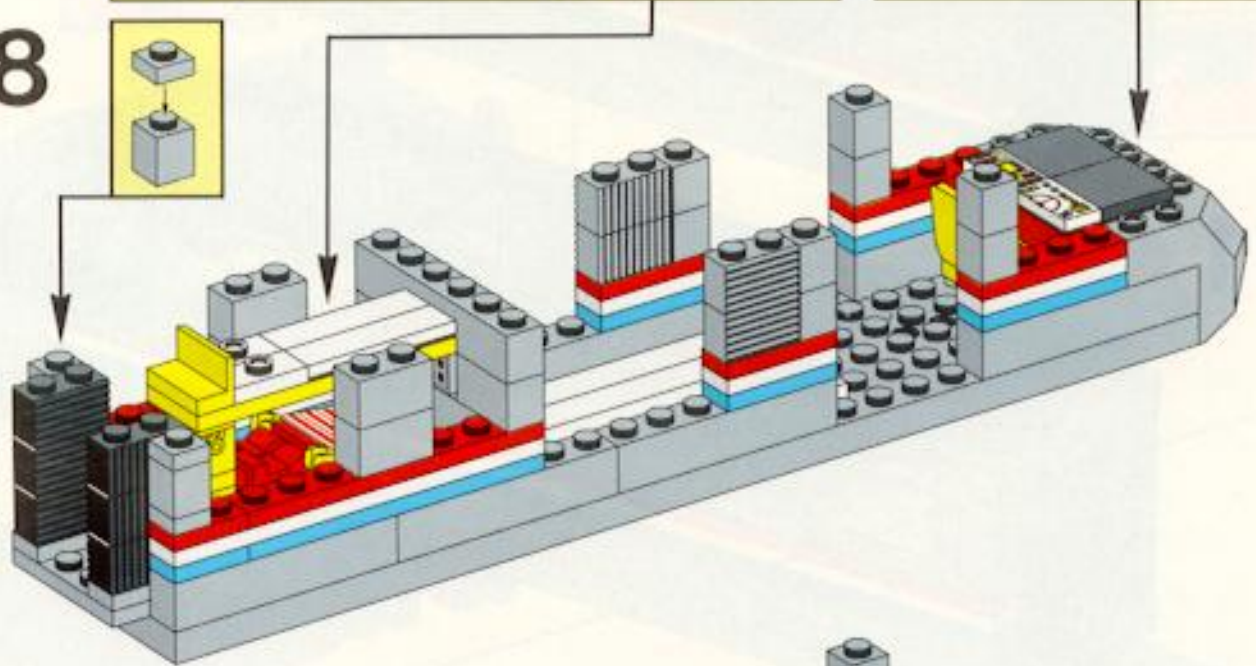
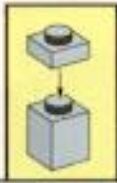

9

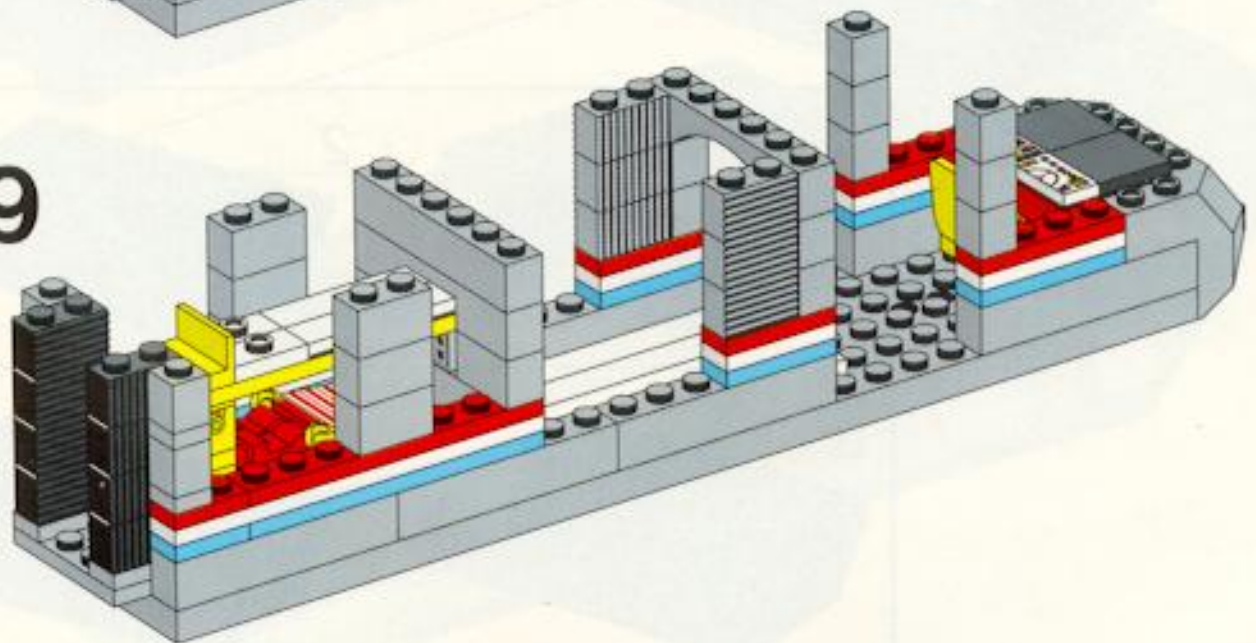

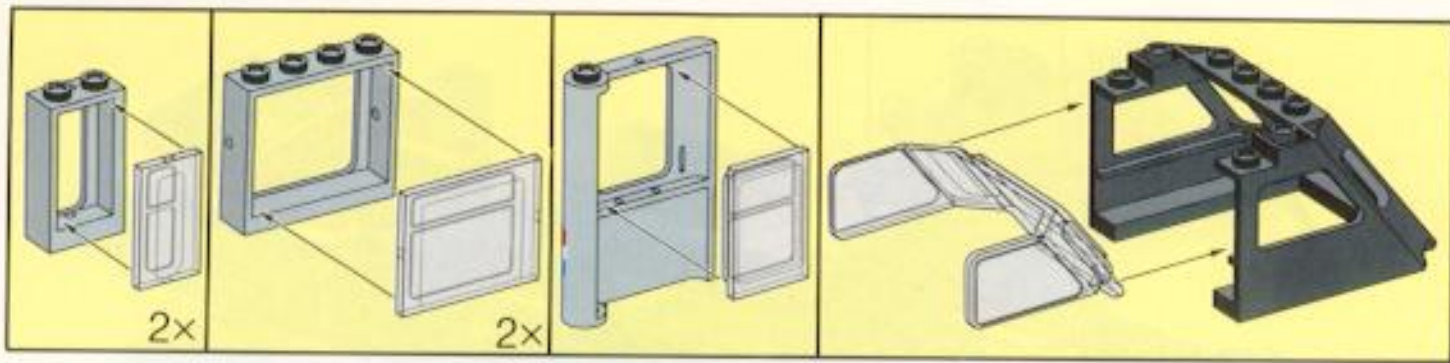

10

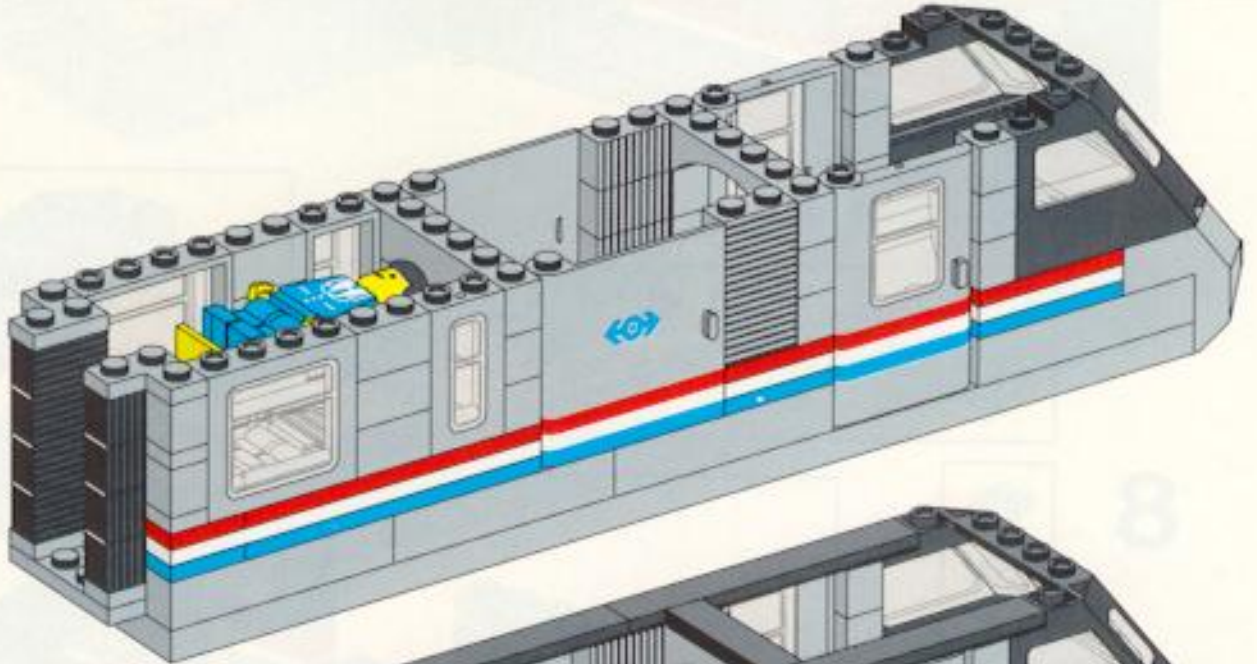

11

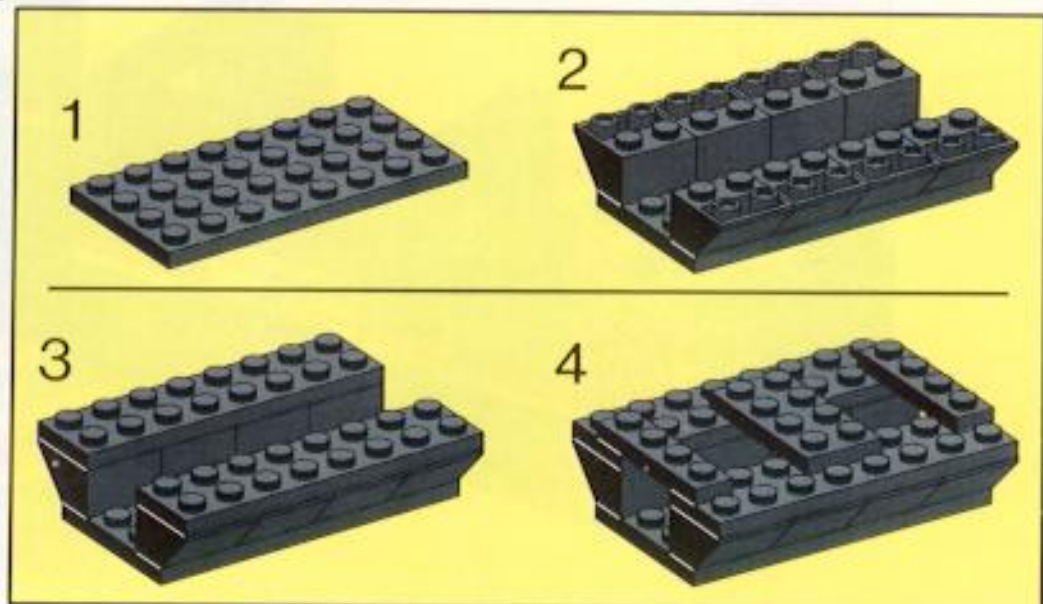
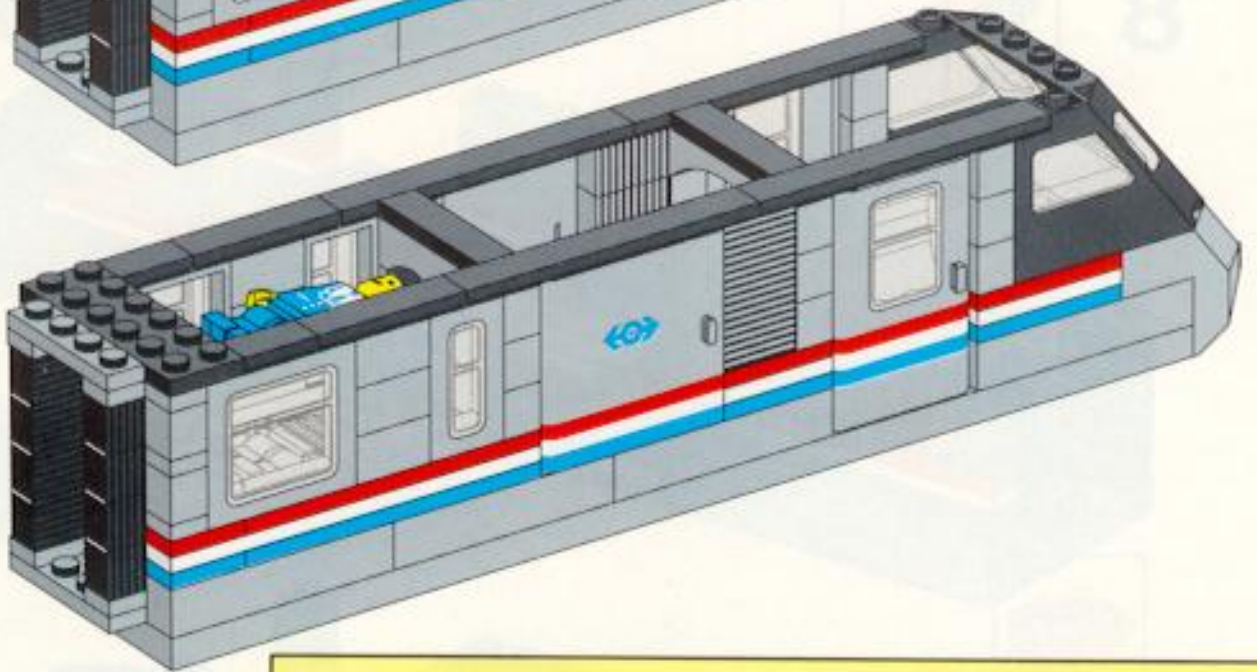

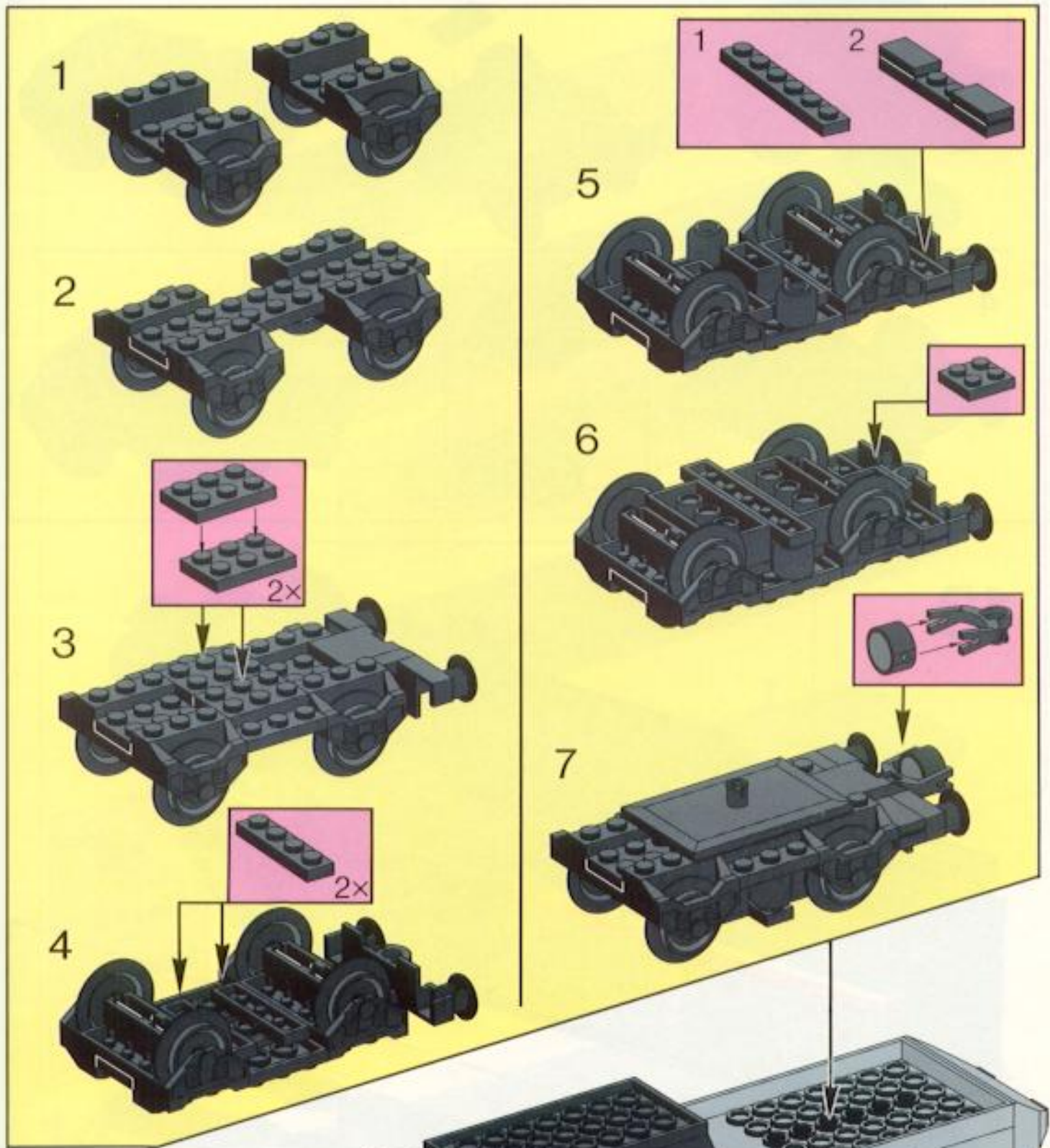

12

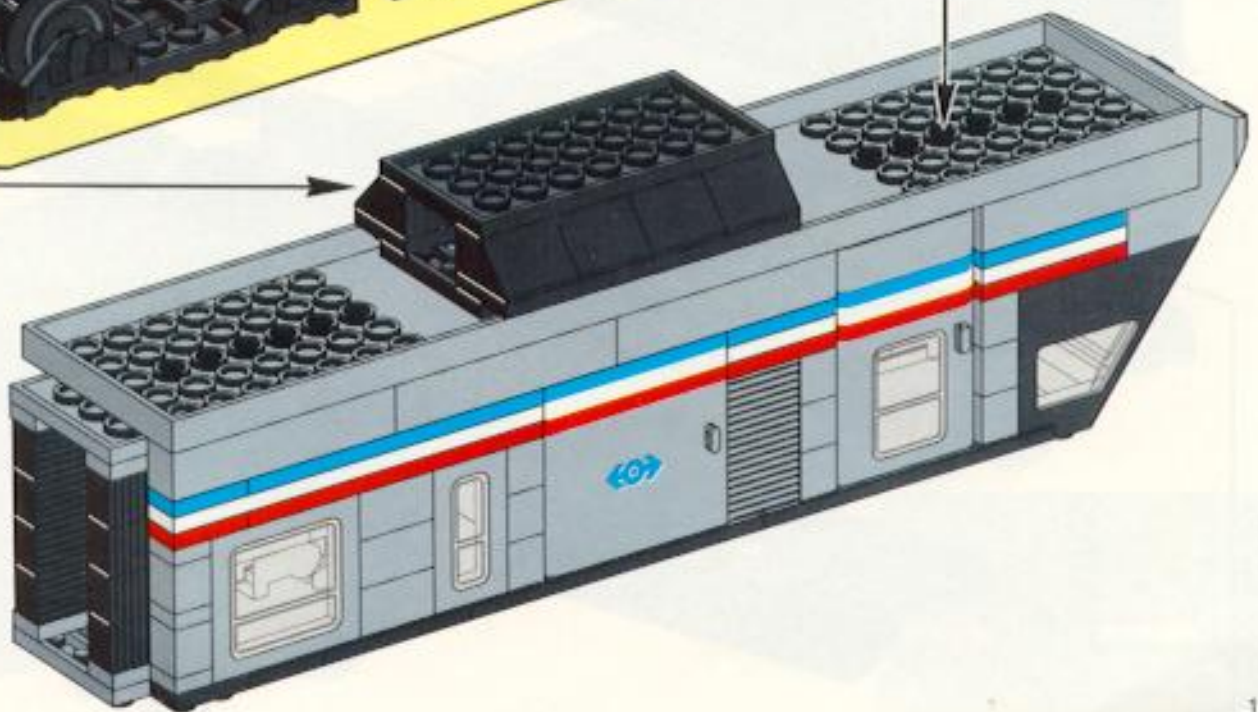

1



2



3



4

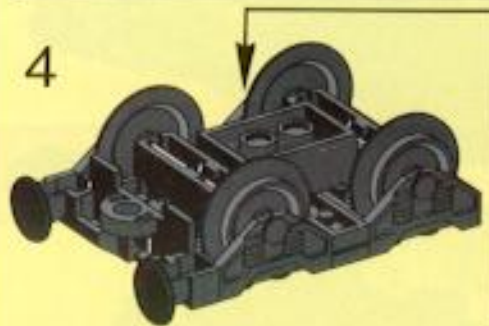

1



2



5



13

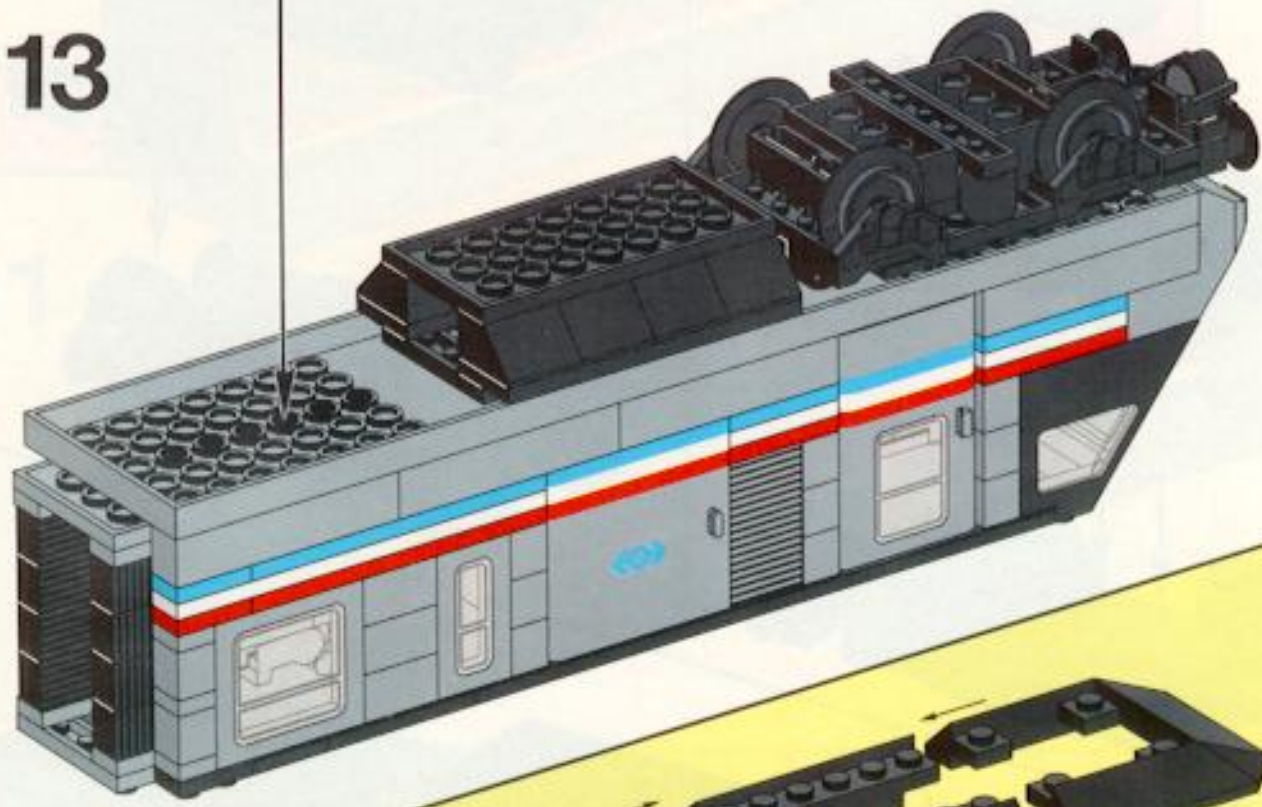

1

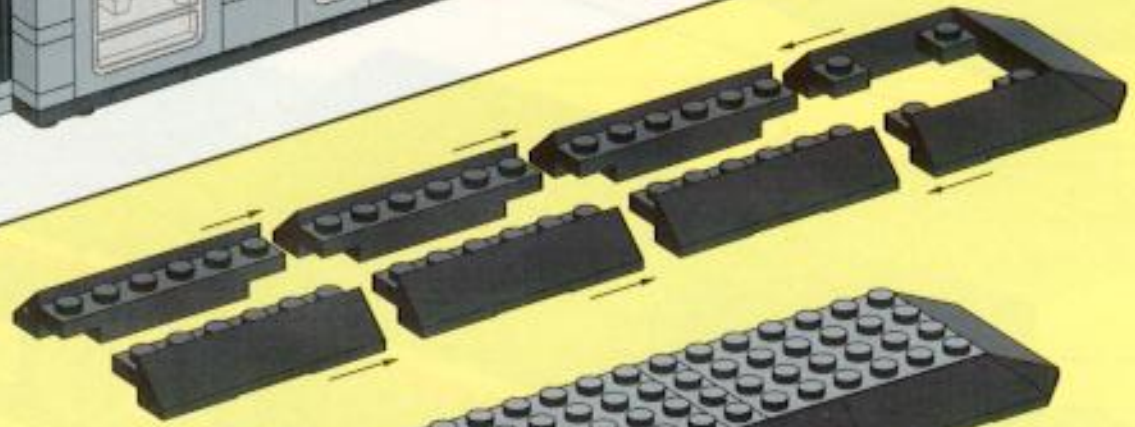

2



3

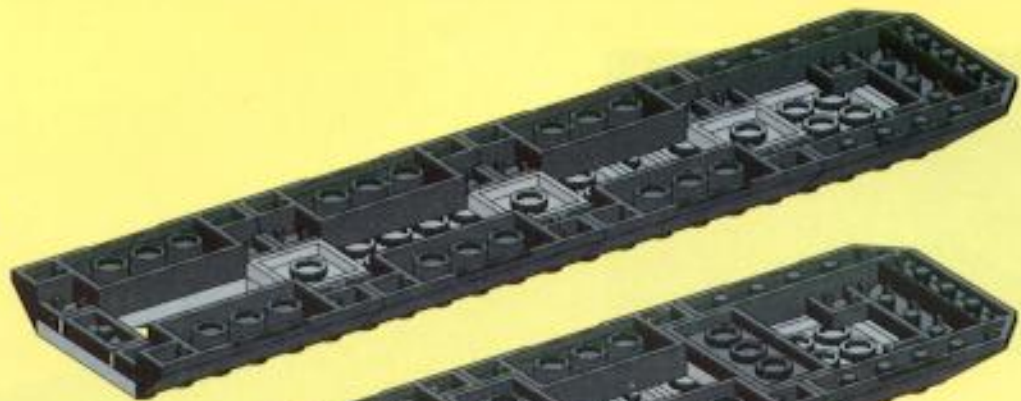

4

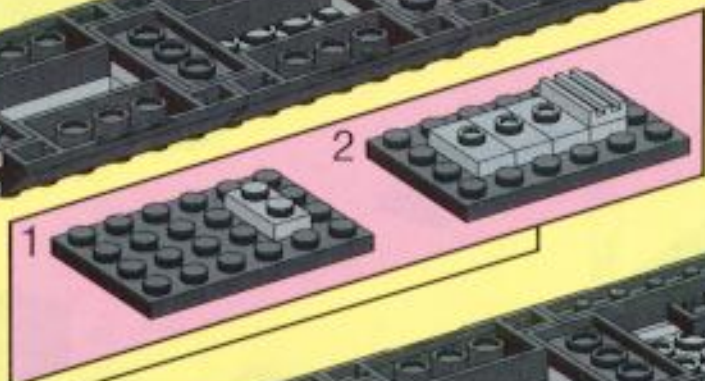

5

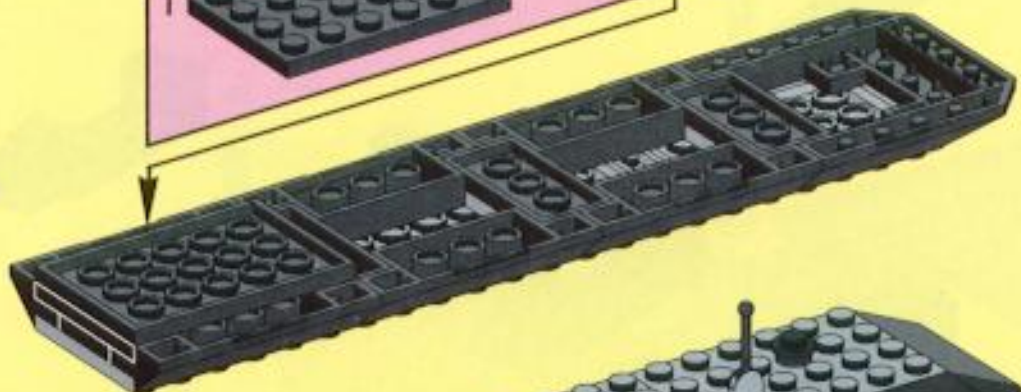

6

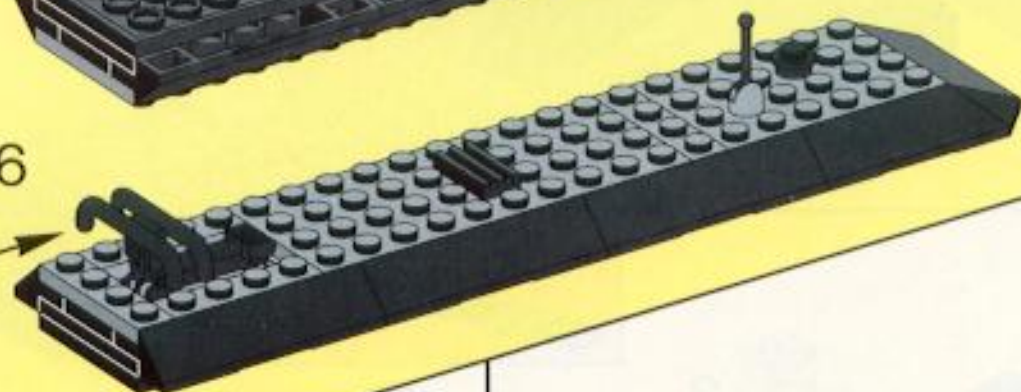

14





1

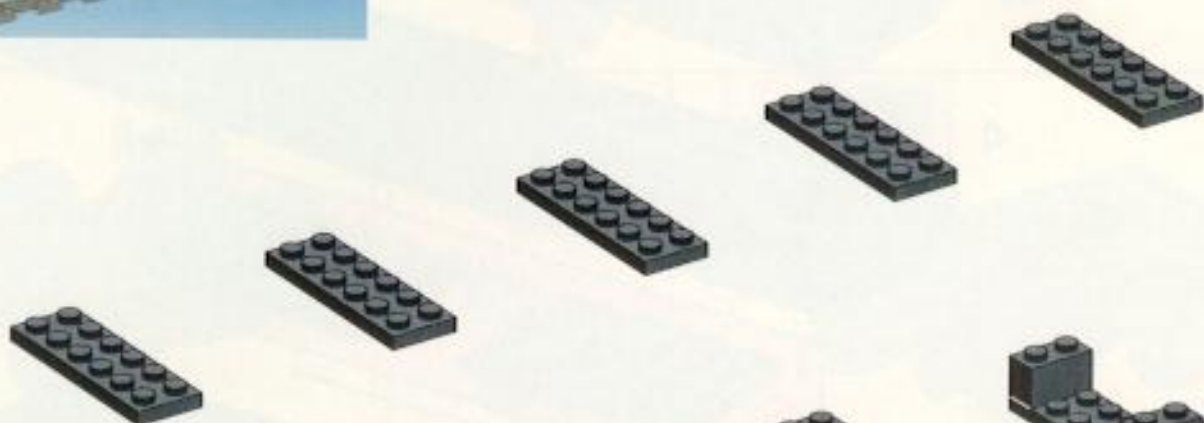

2

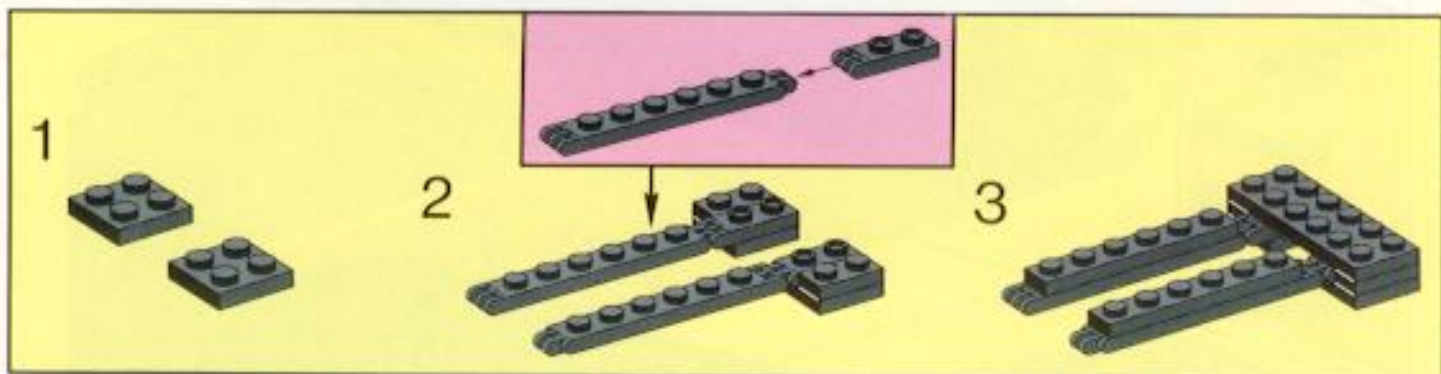

3

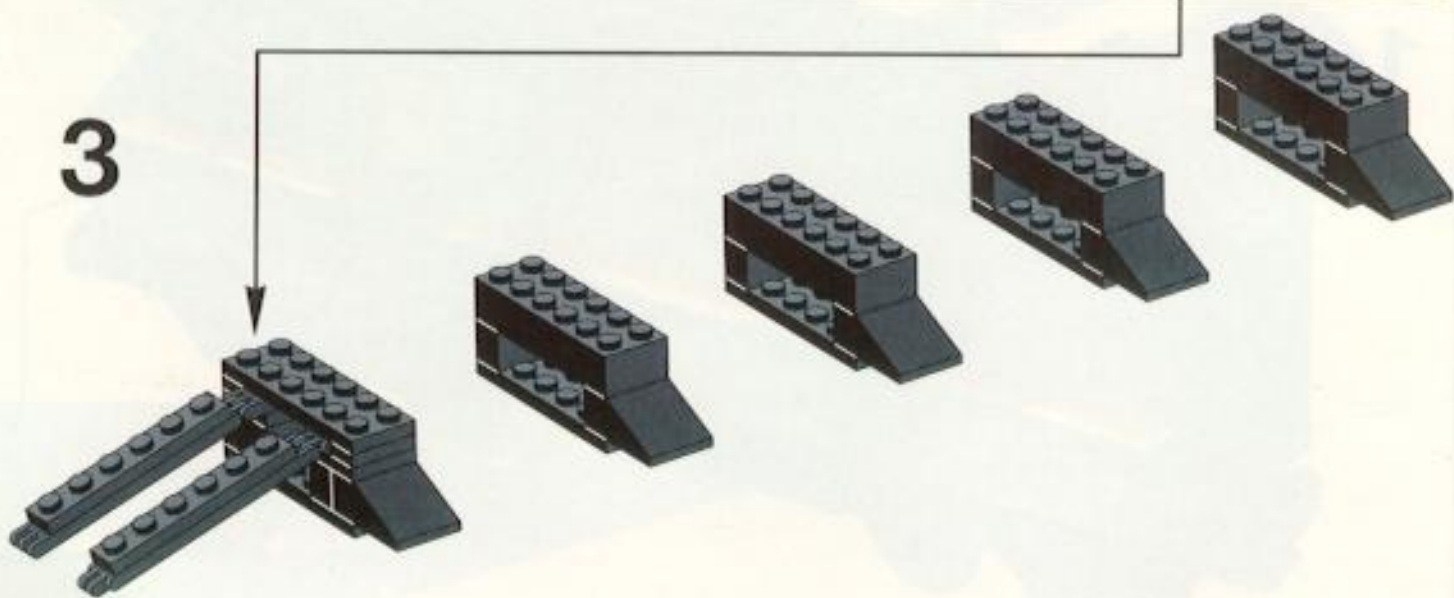

4

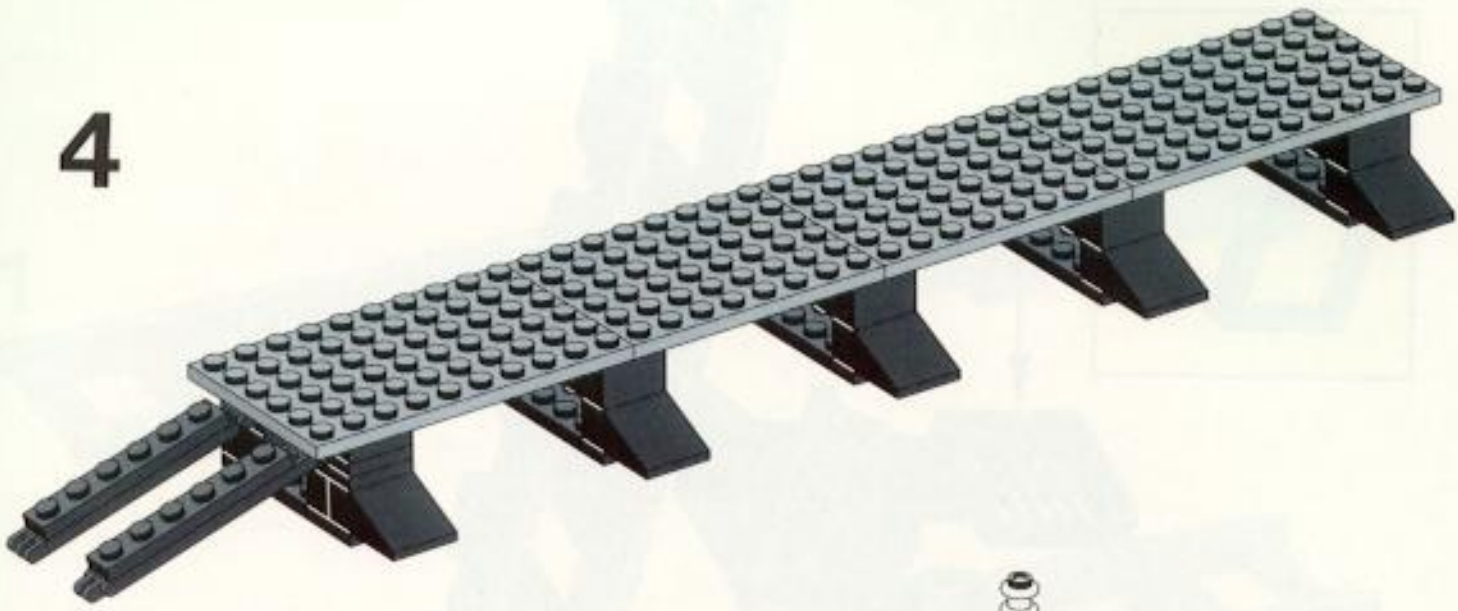

5

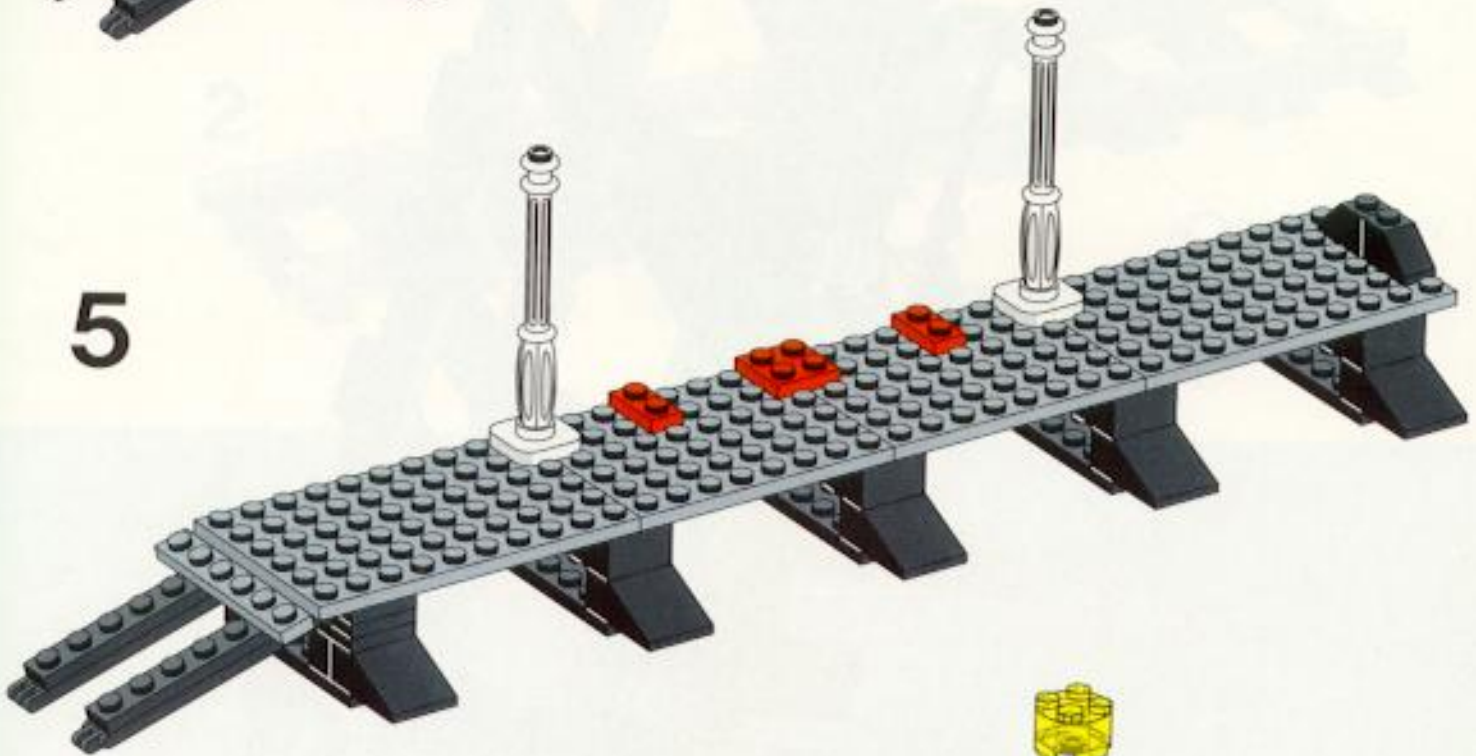

6

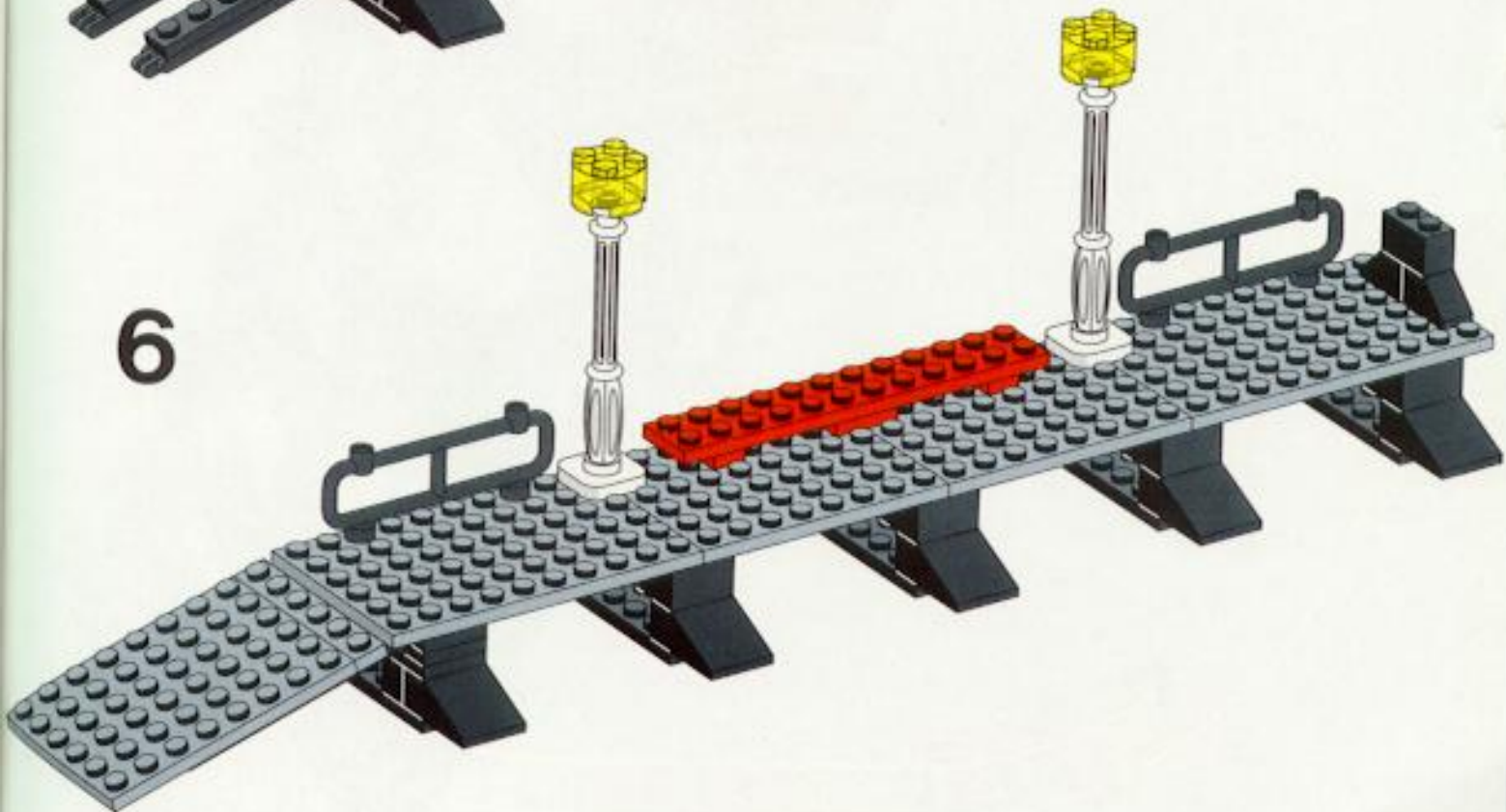

7

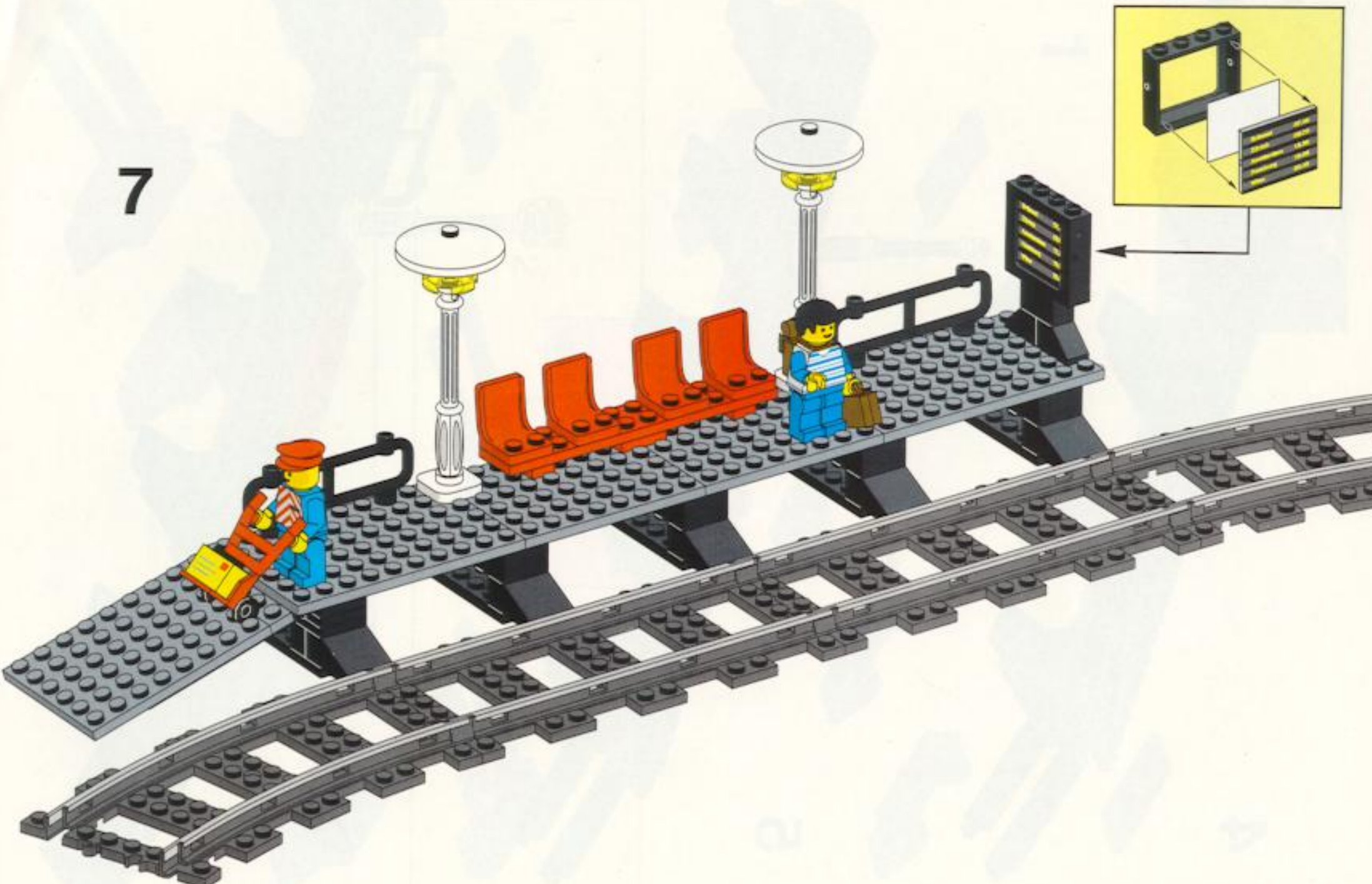

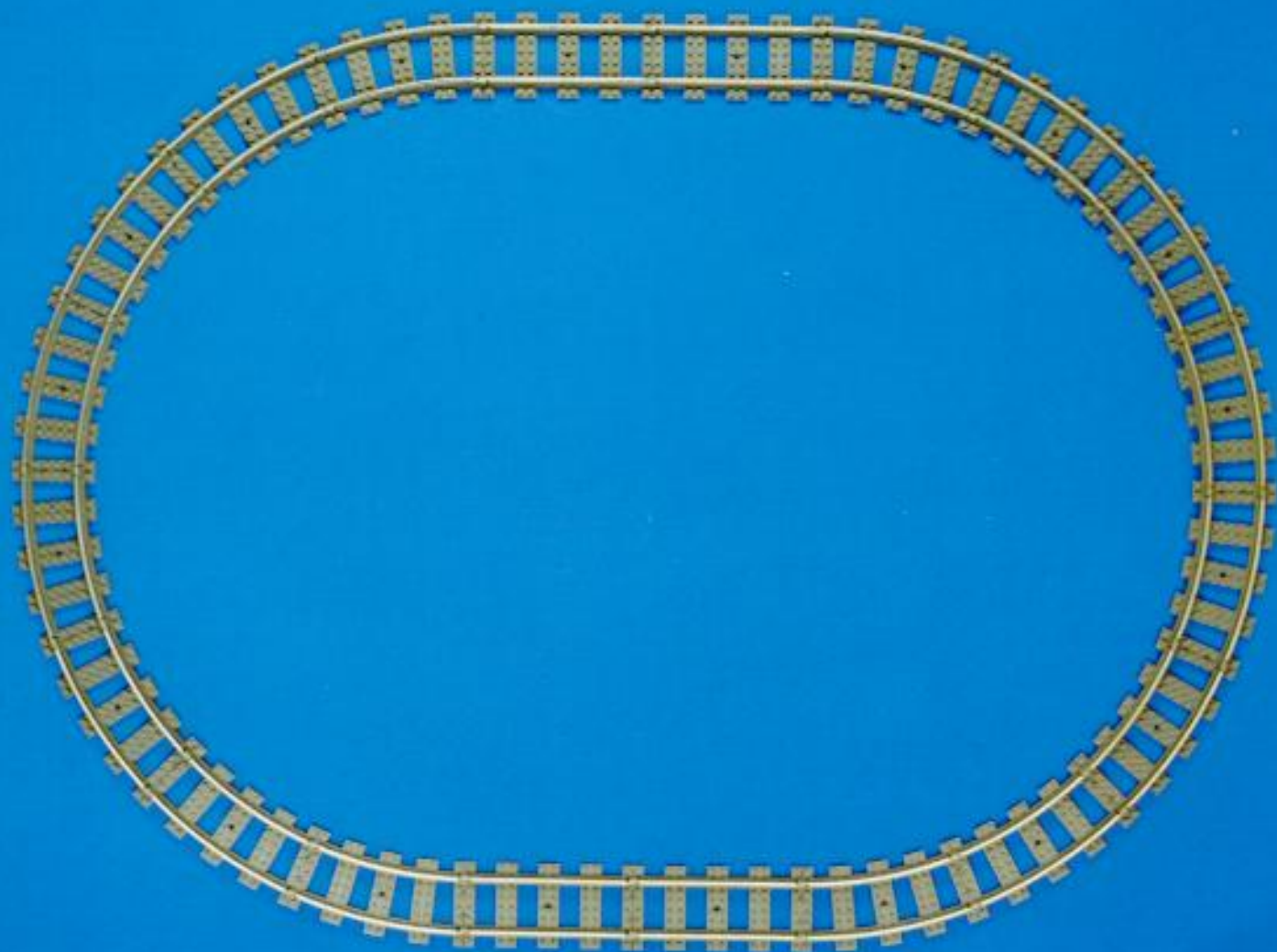
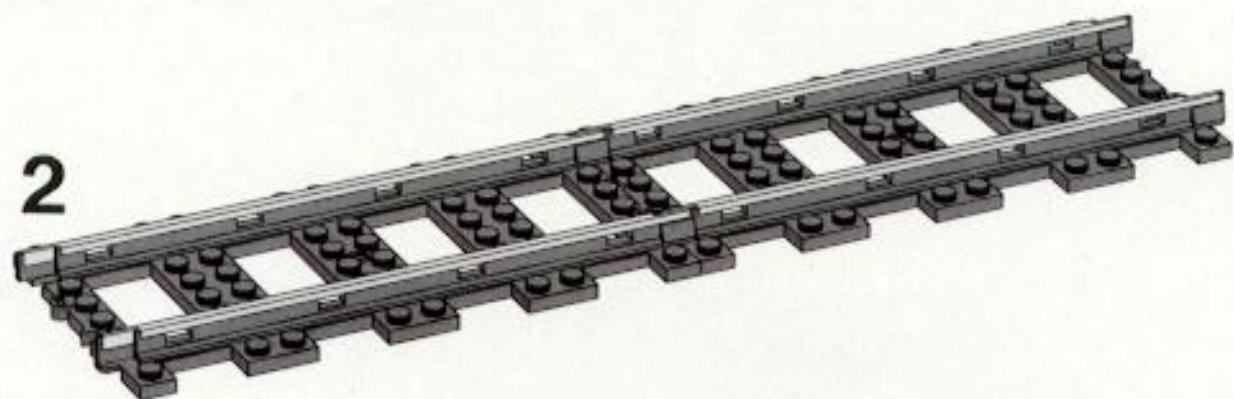
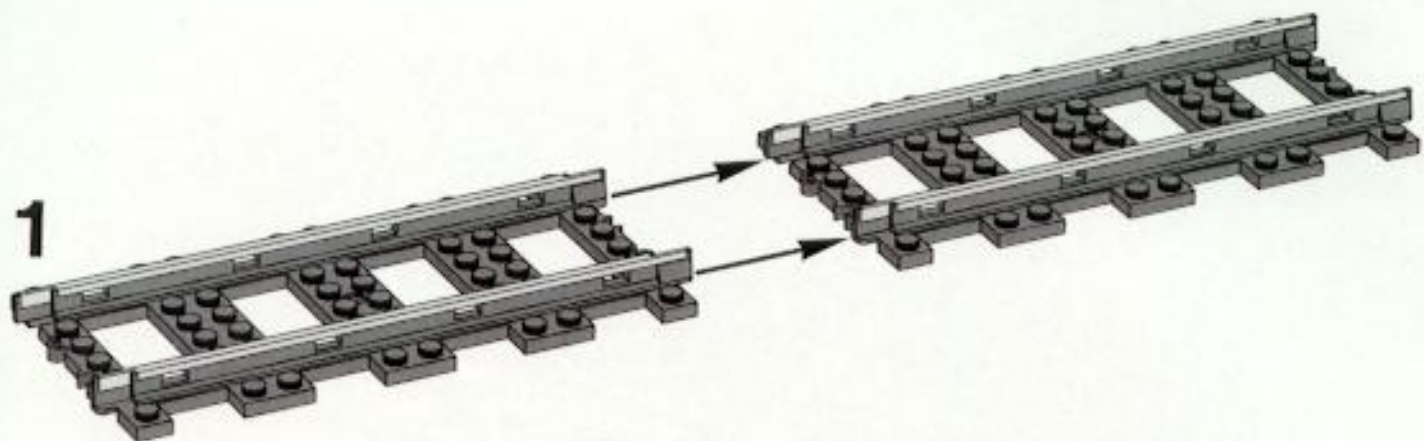

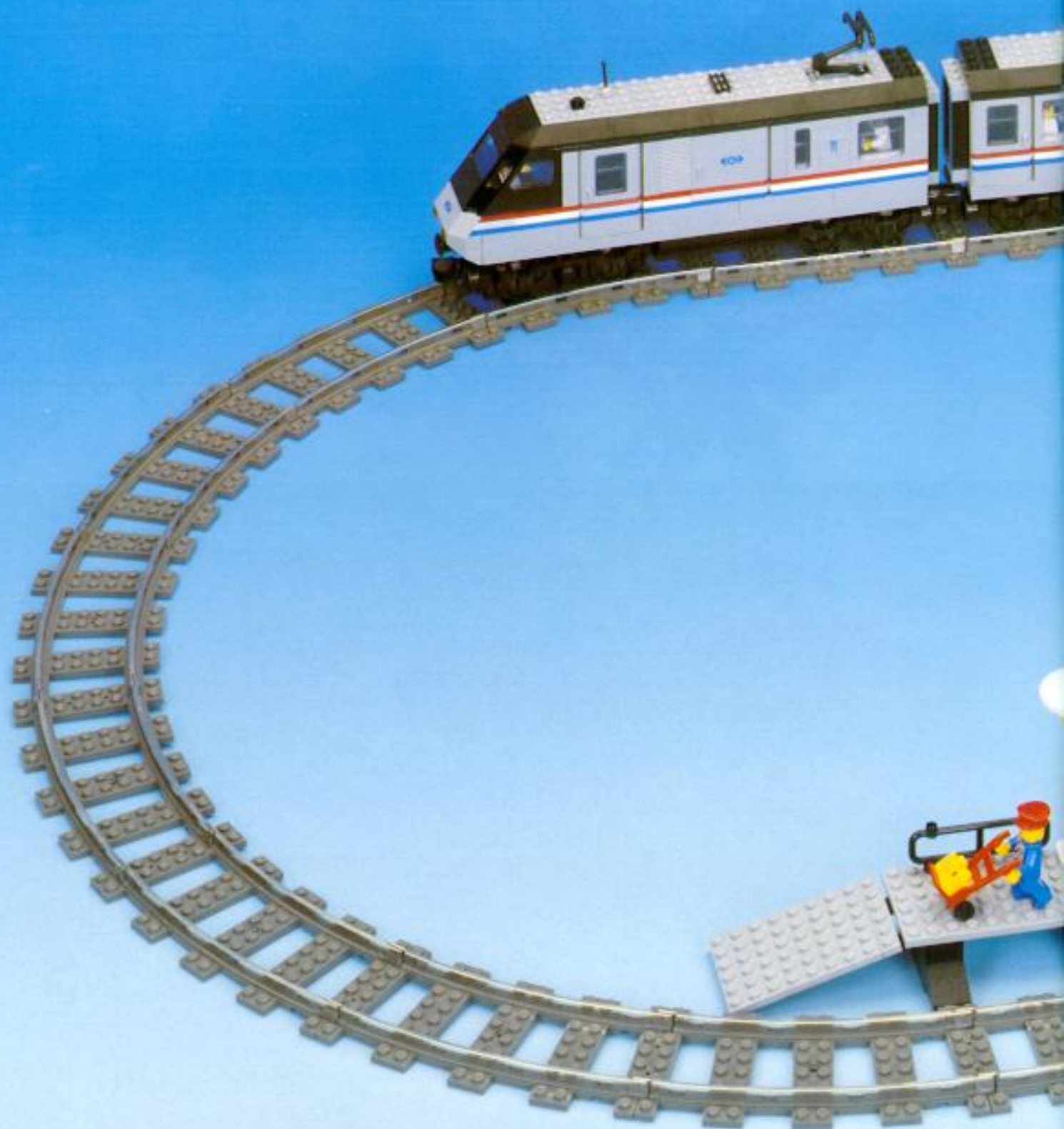

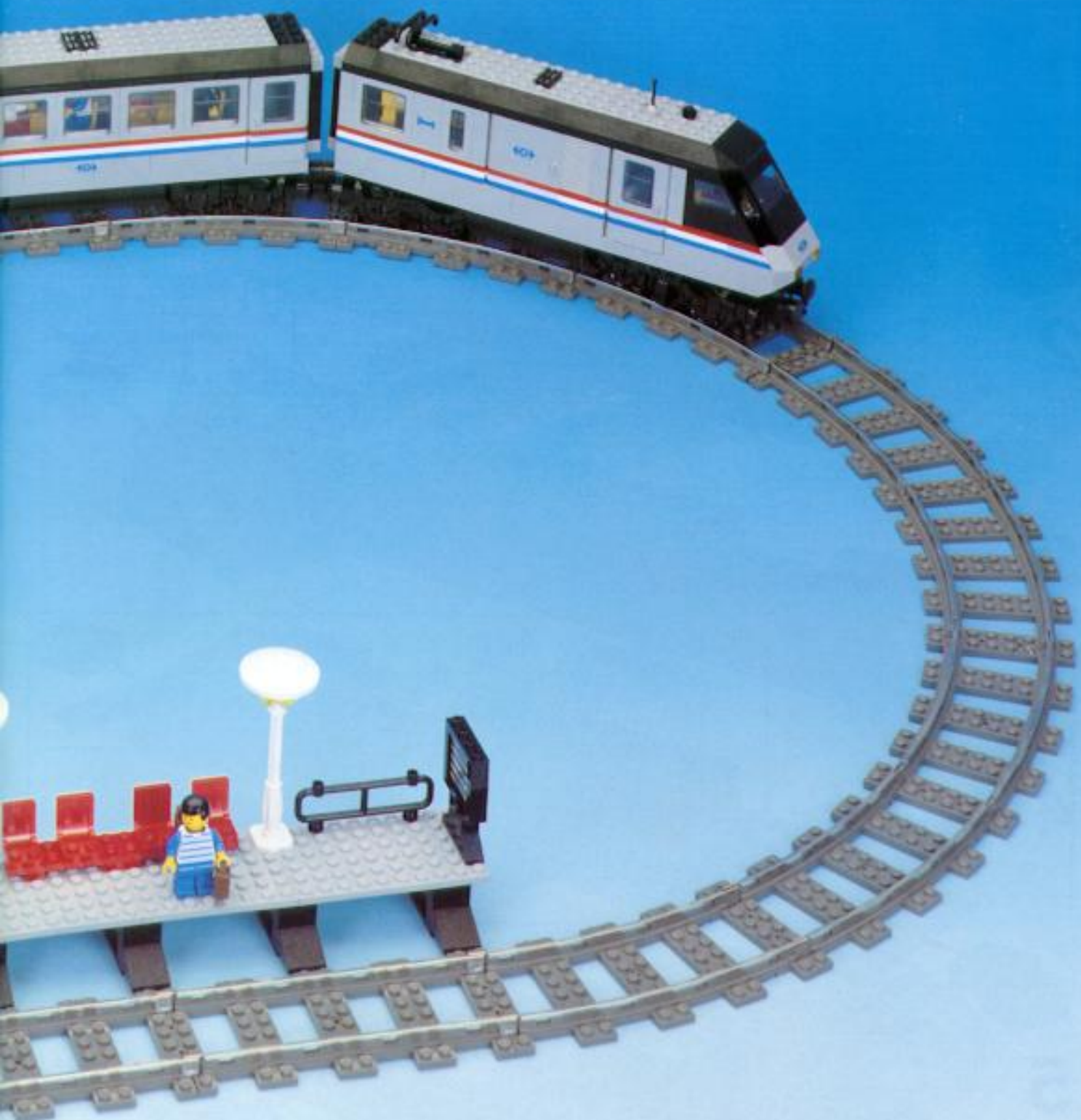



1

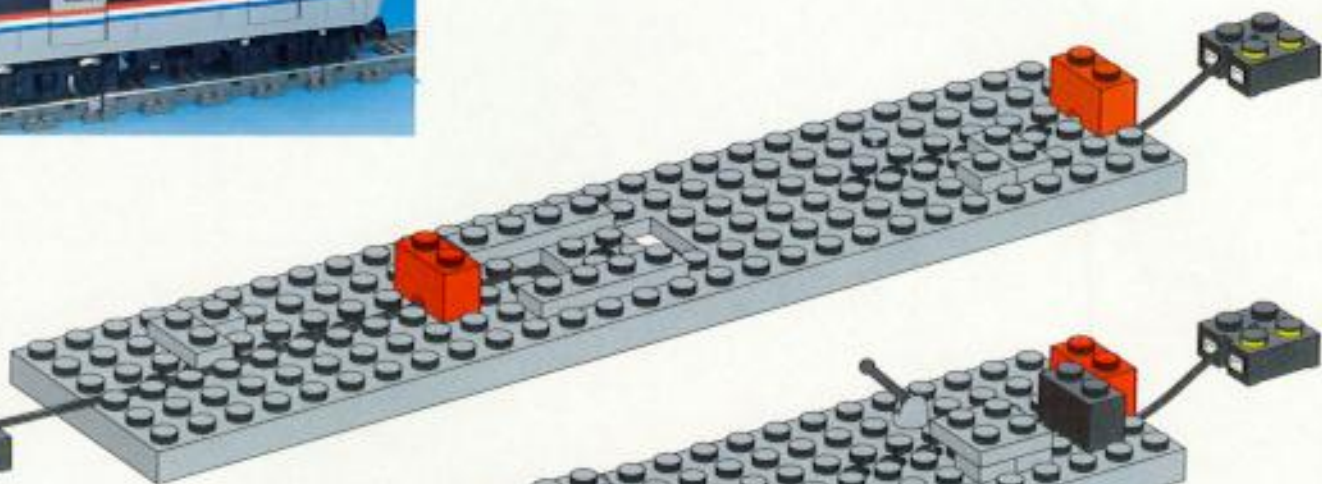

2

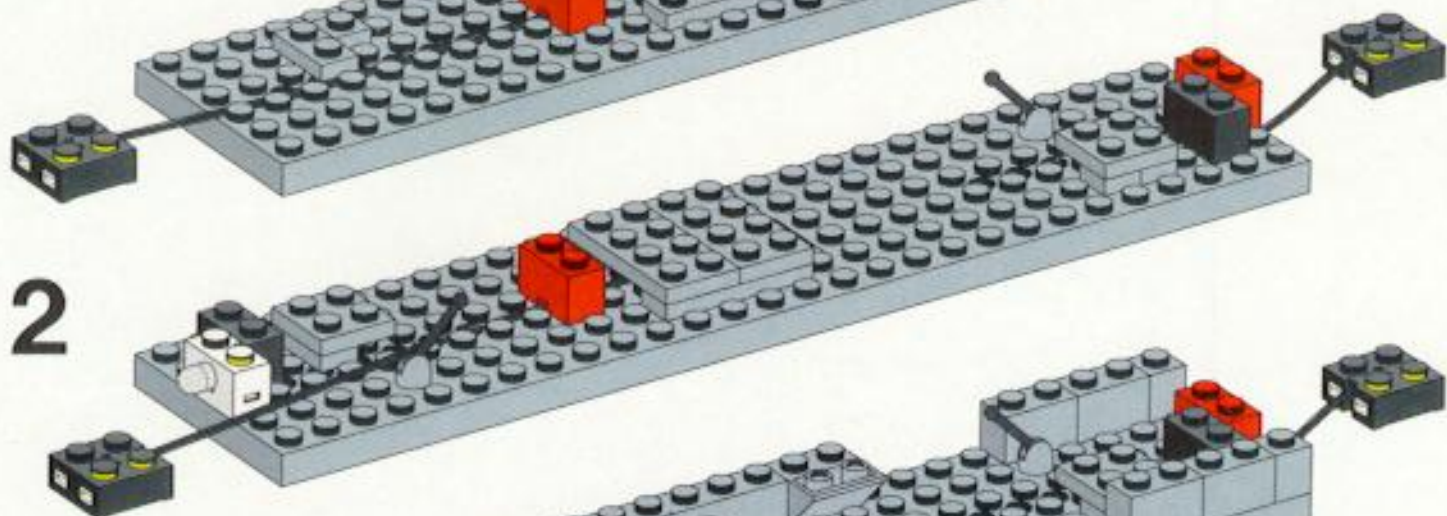

3

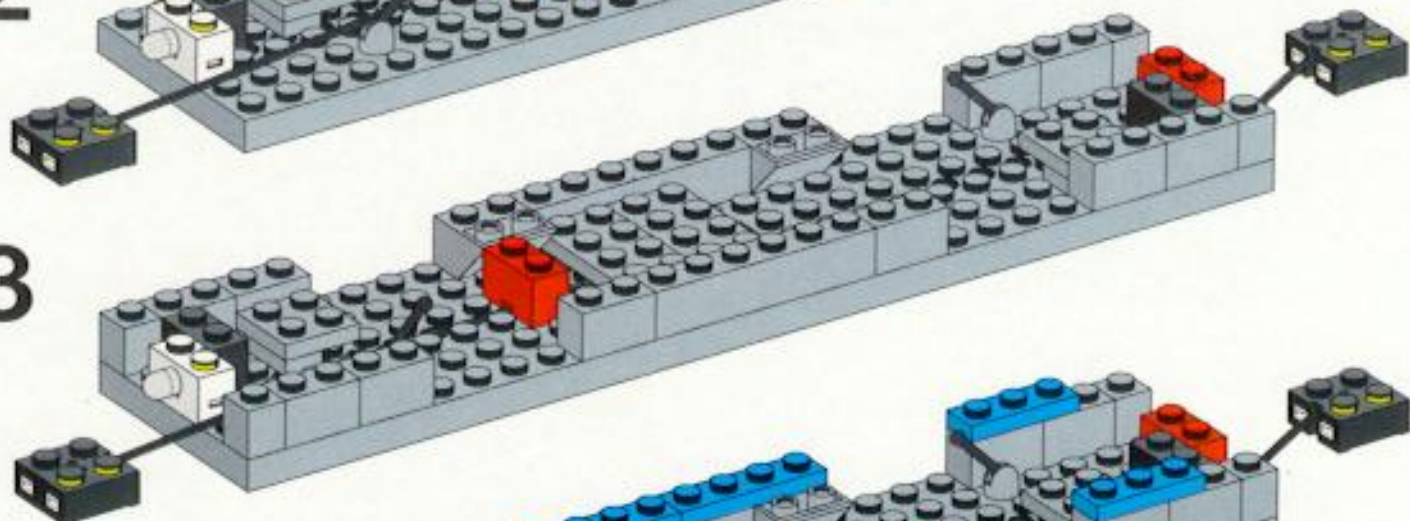

4

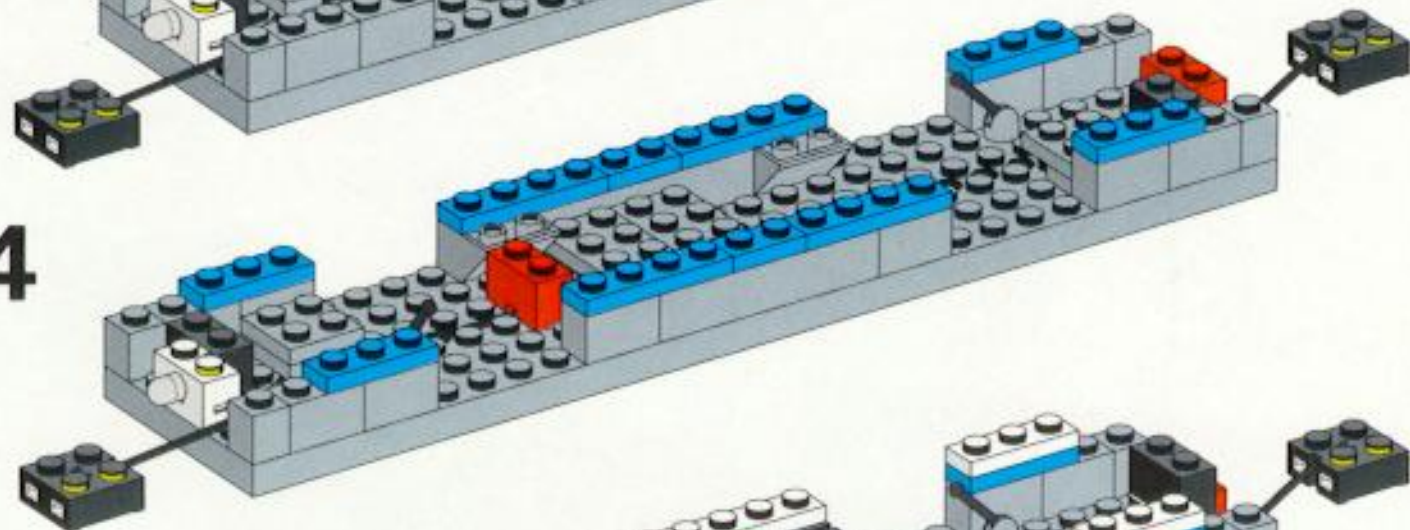

5

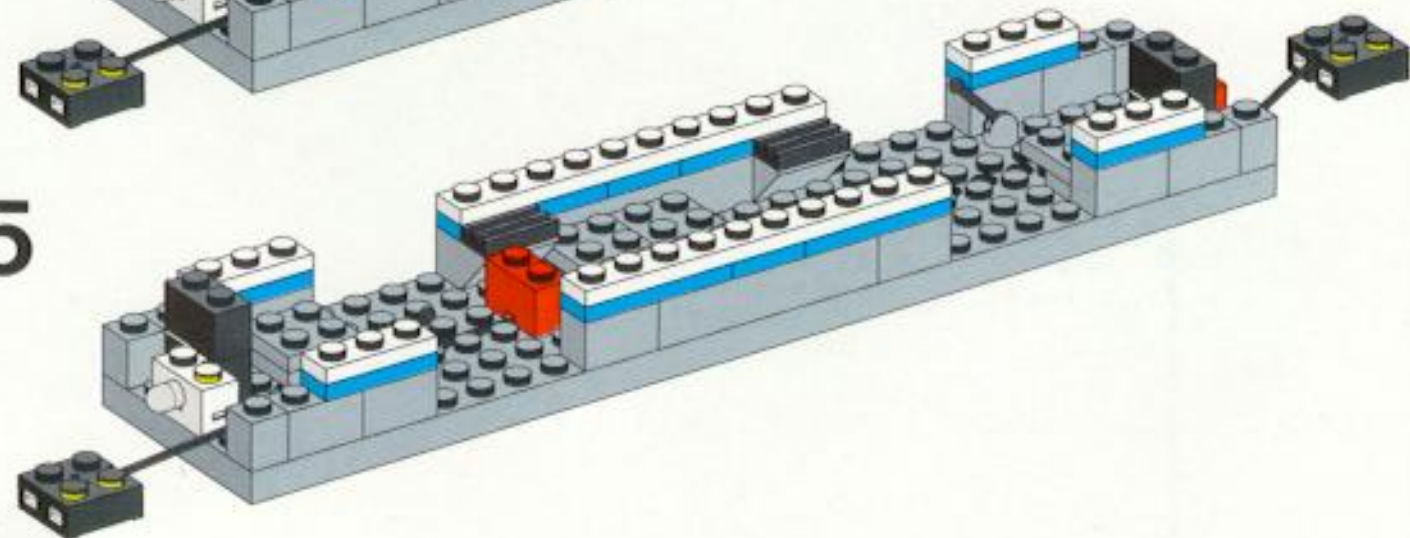

6

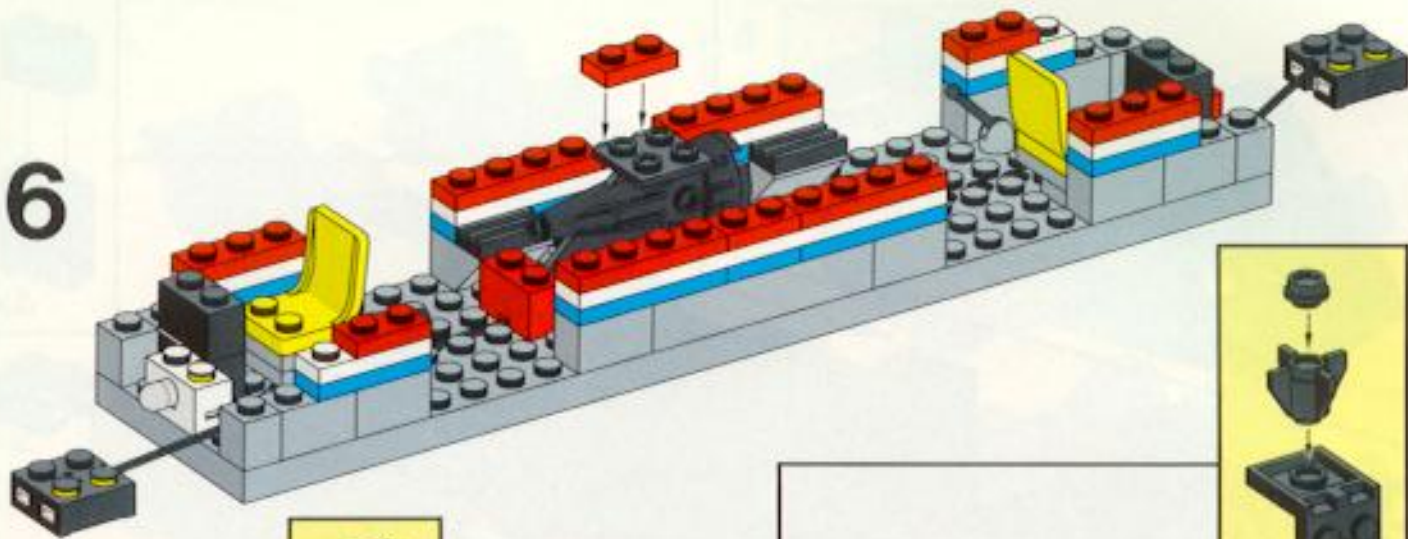

7

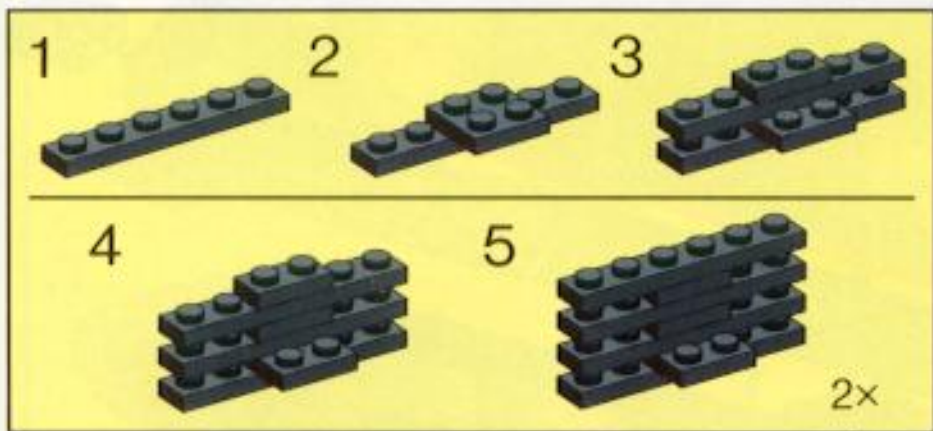
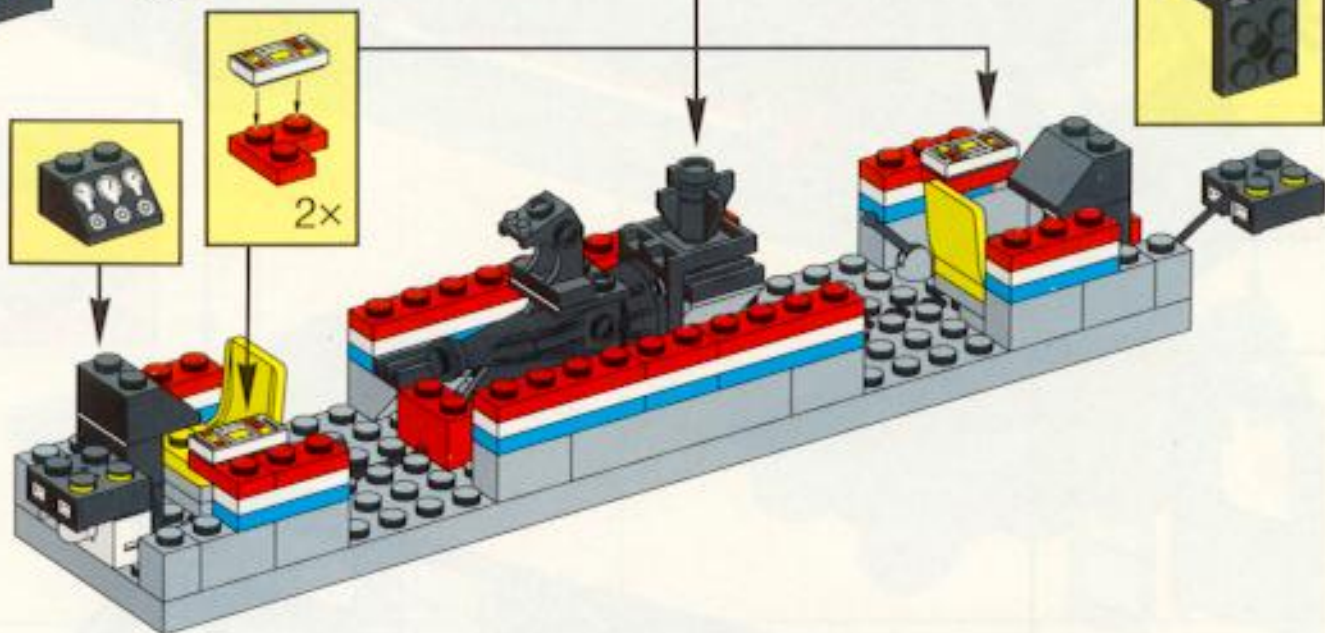

8

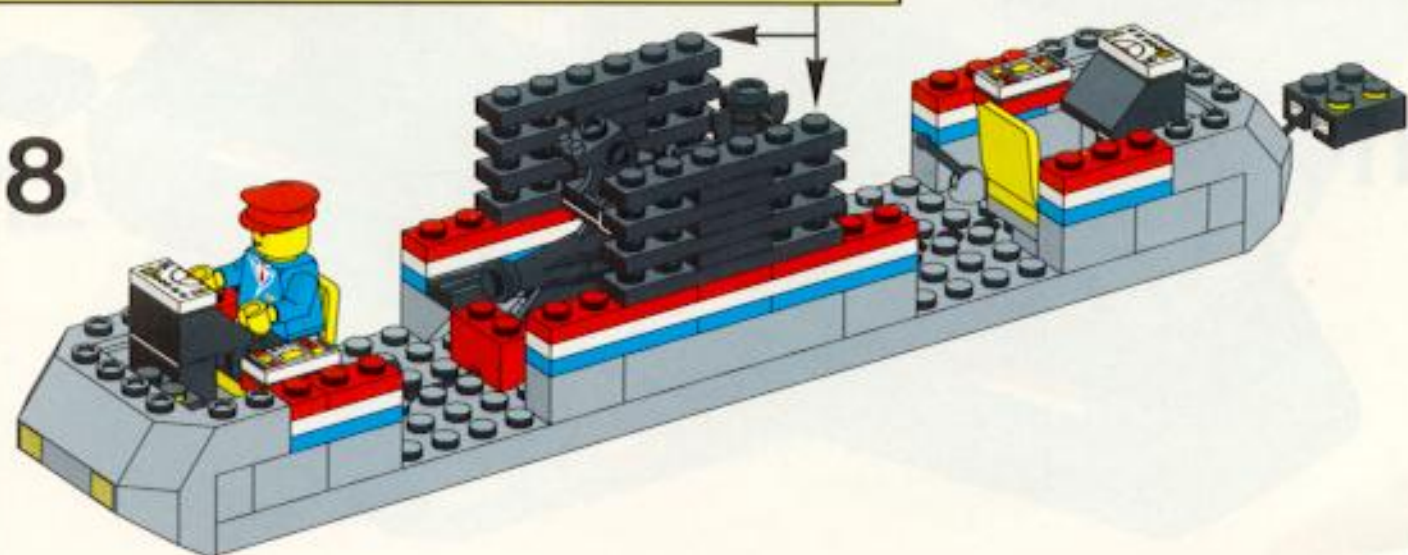

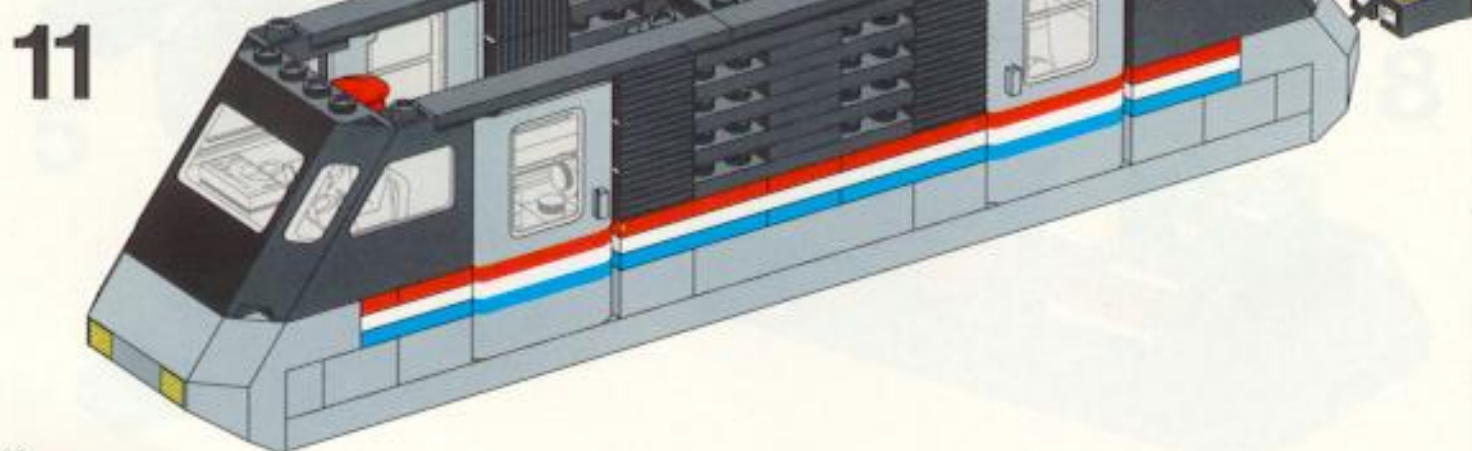
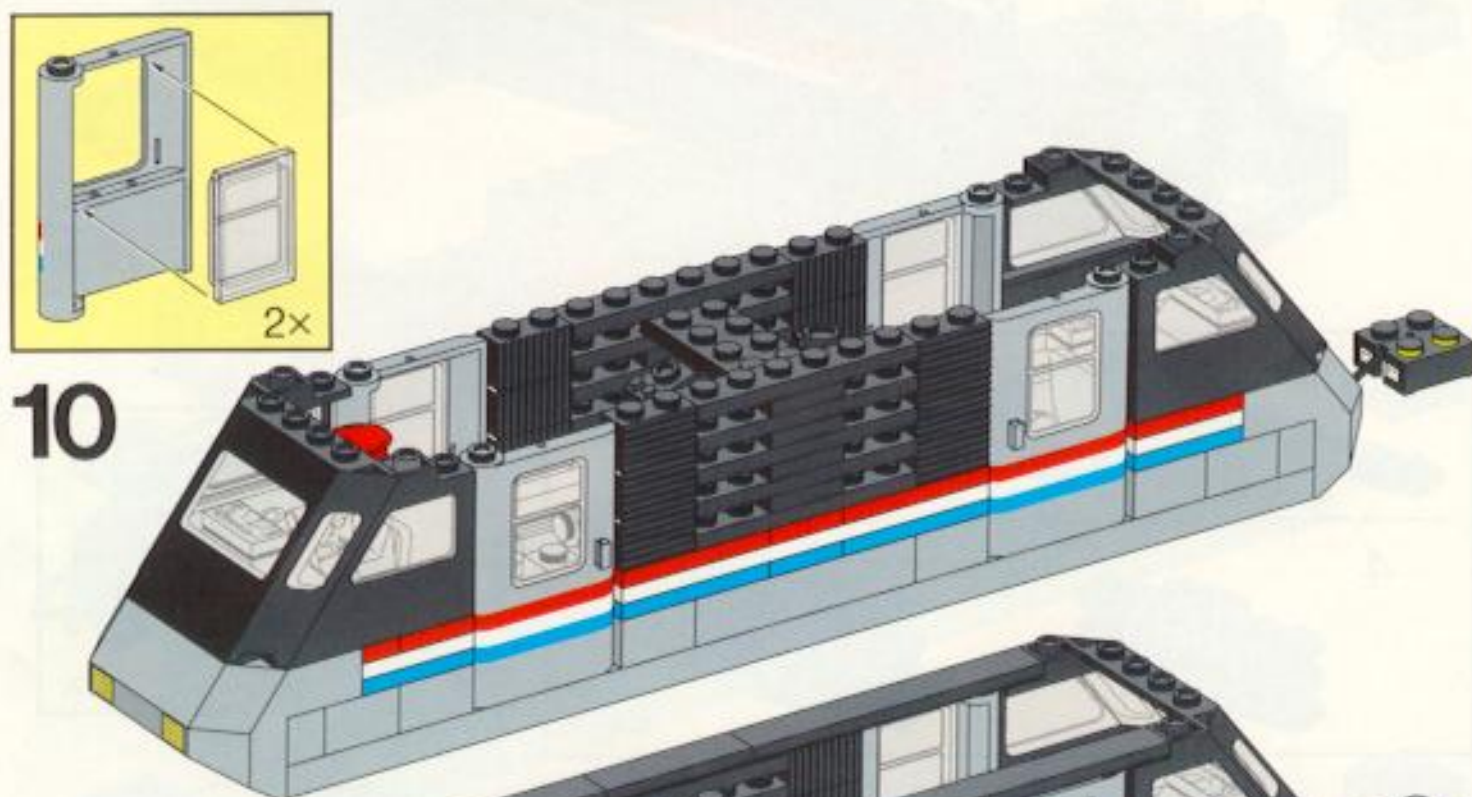
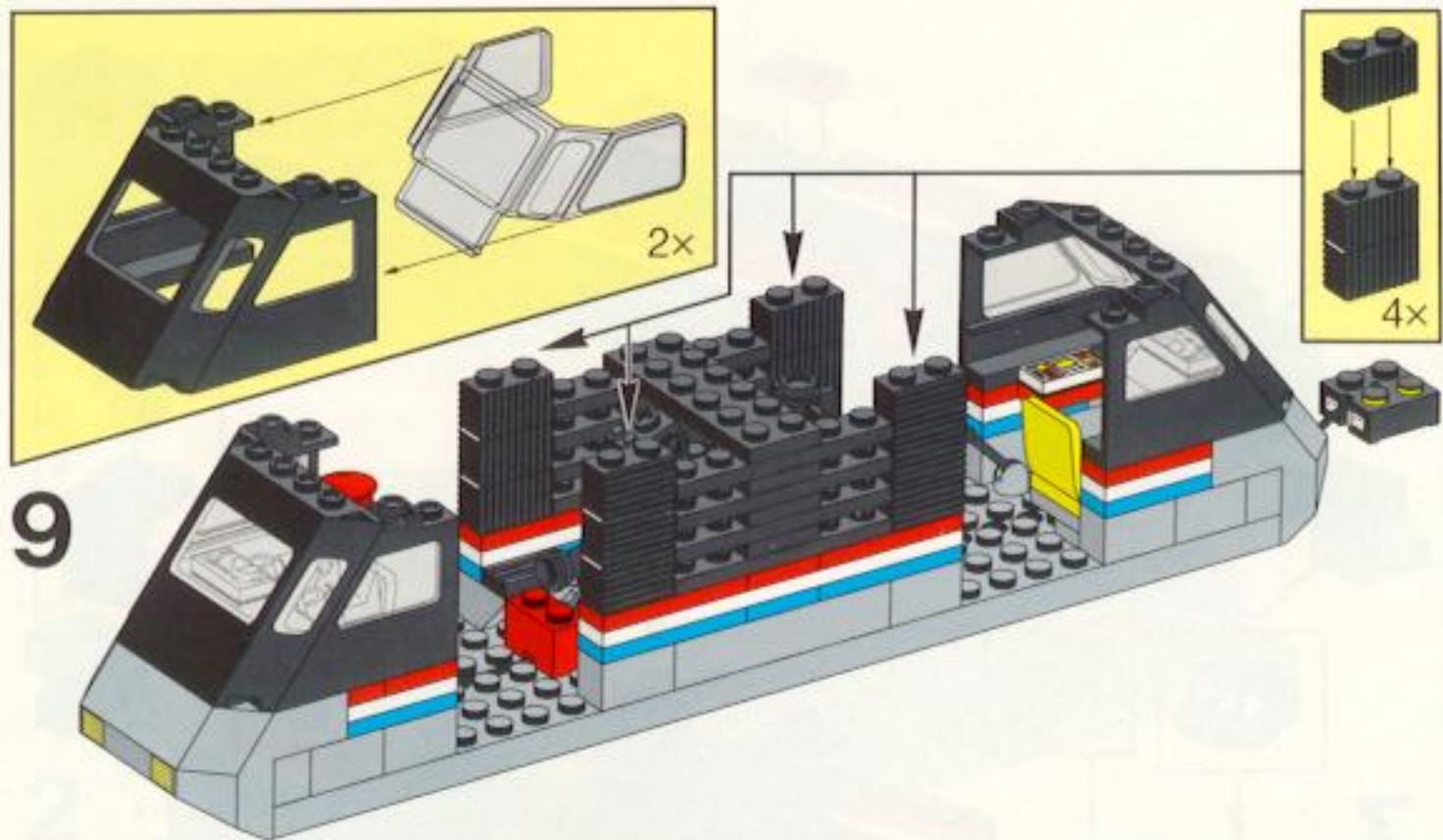

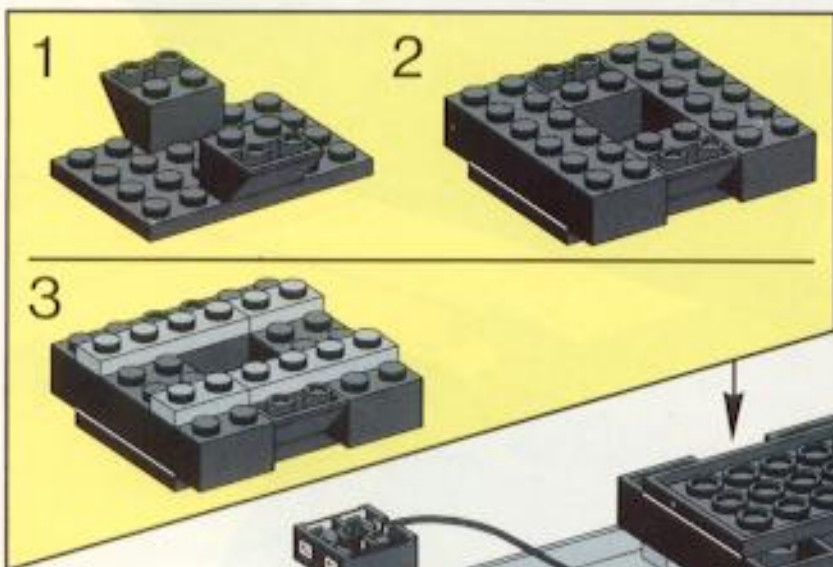
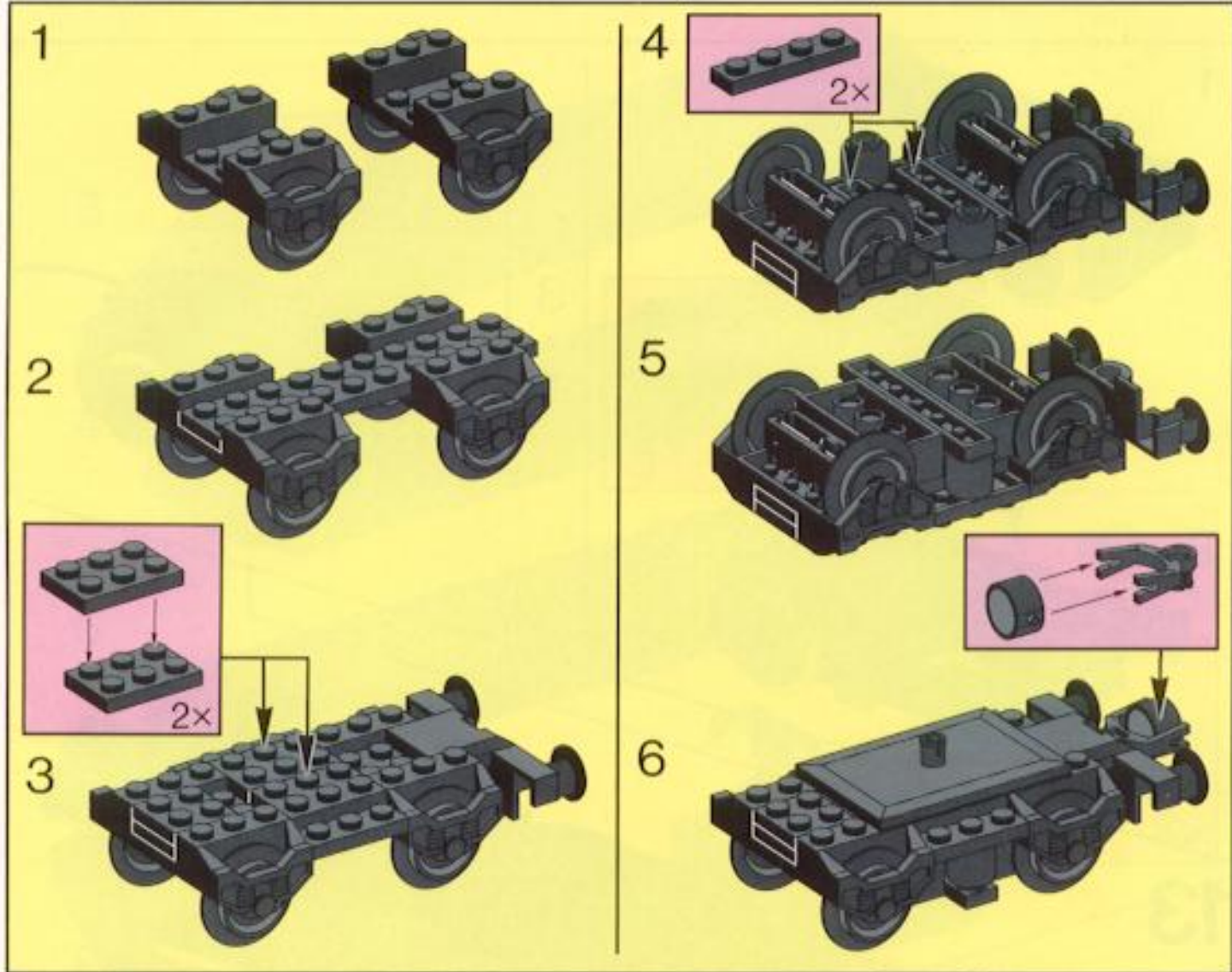

12

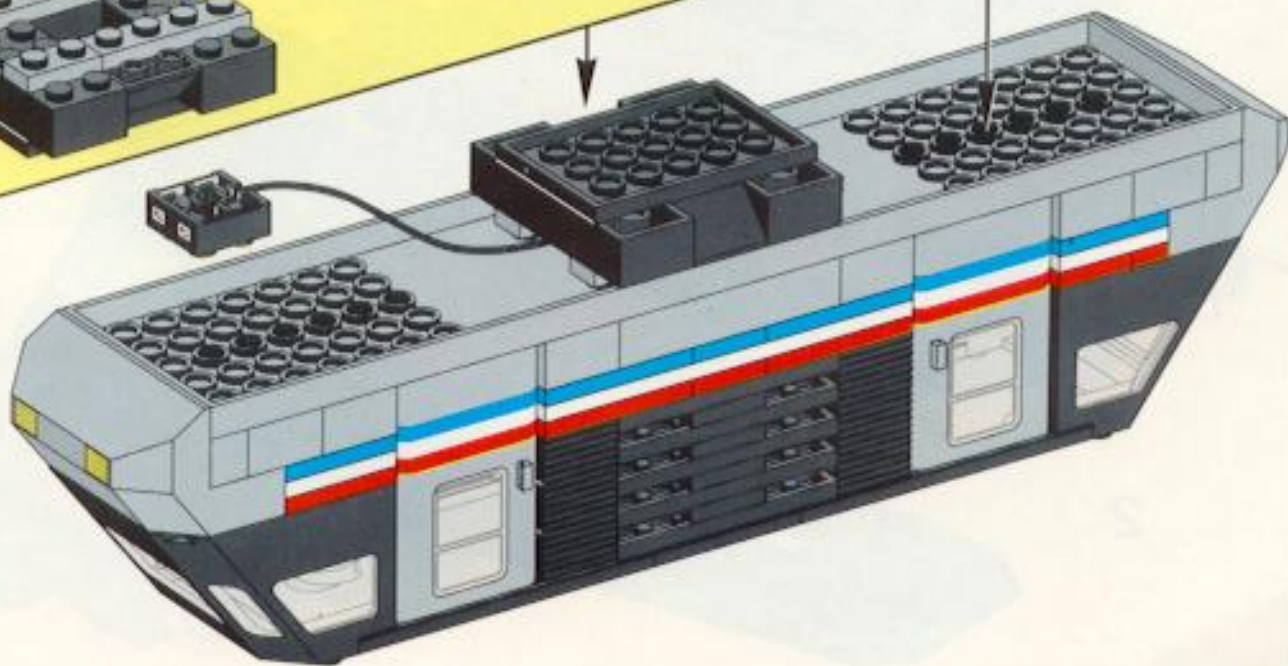

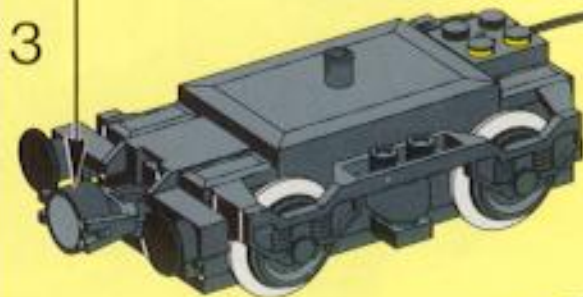
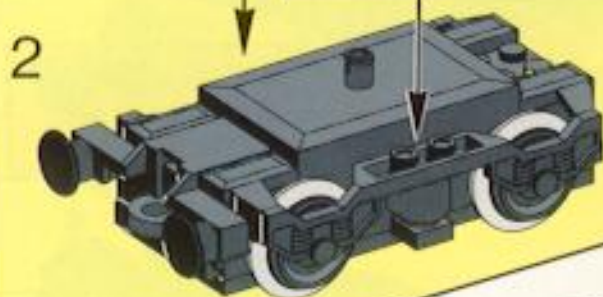
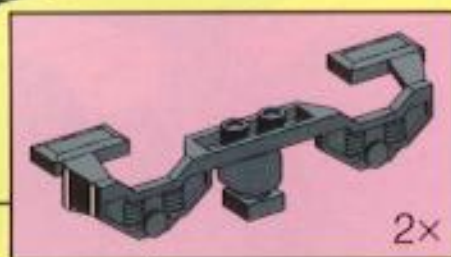

13

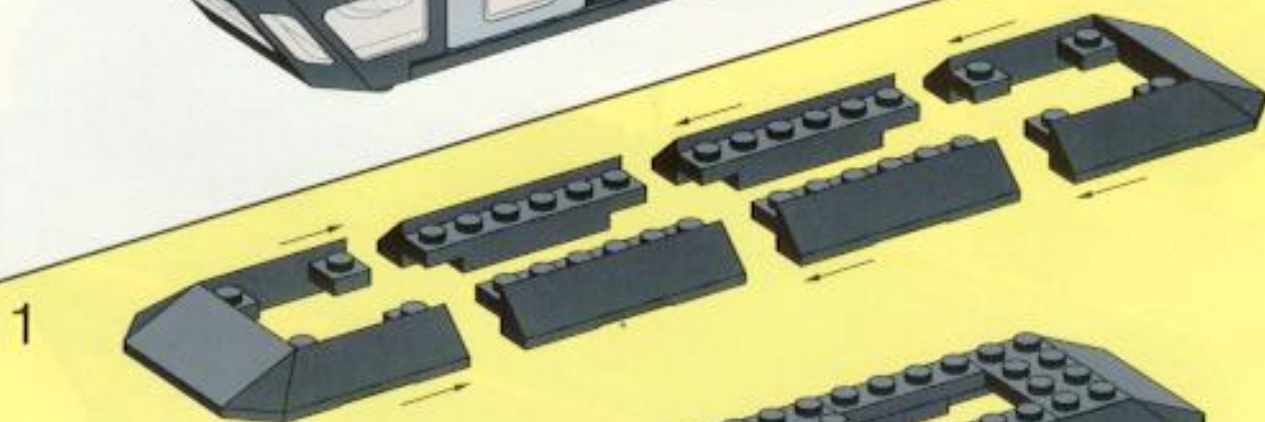
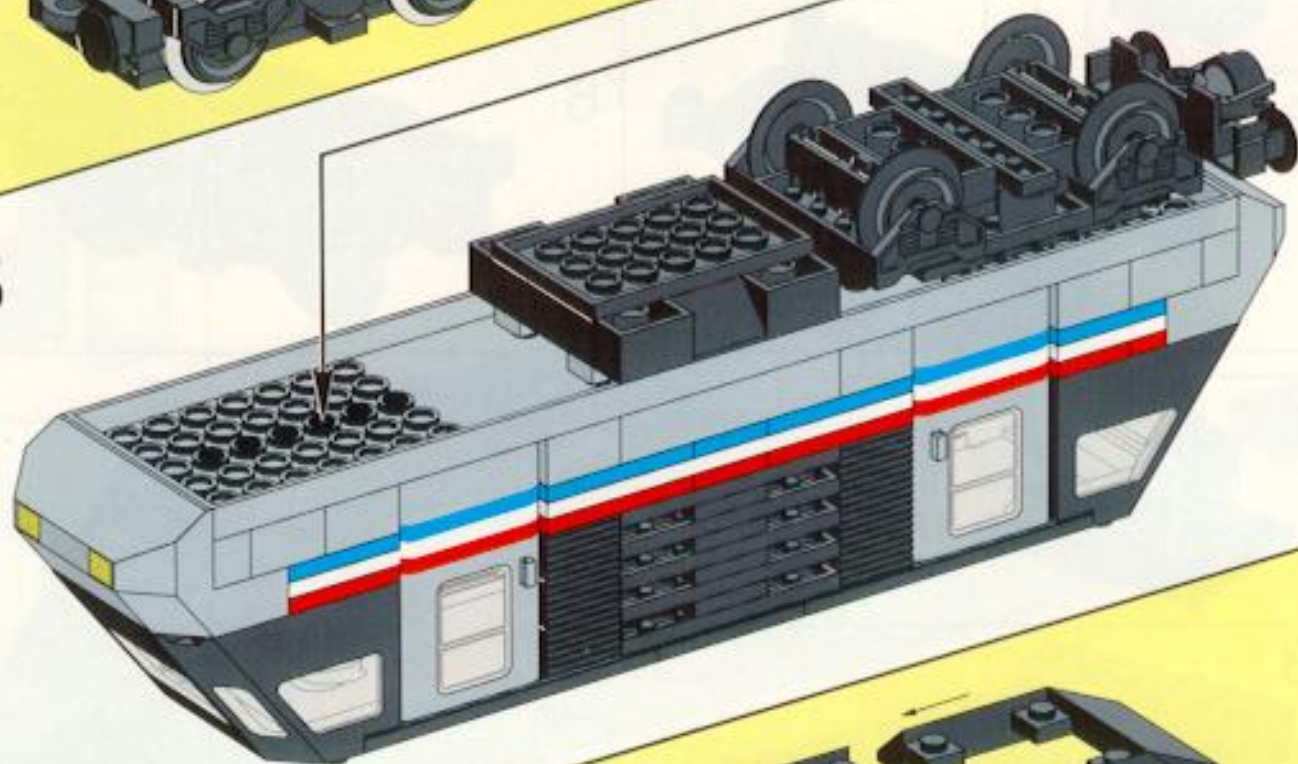

3



4



5

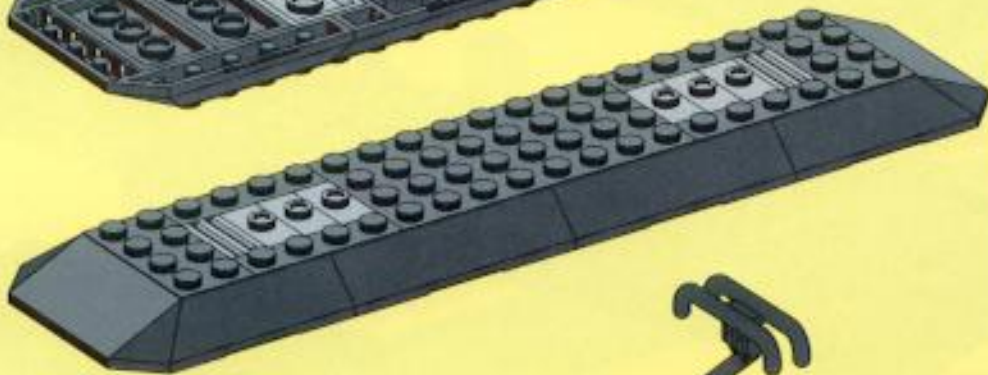

6

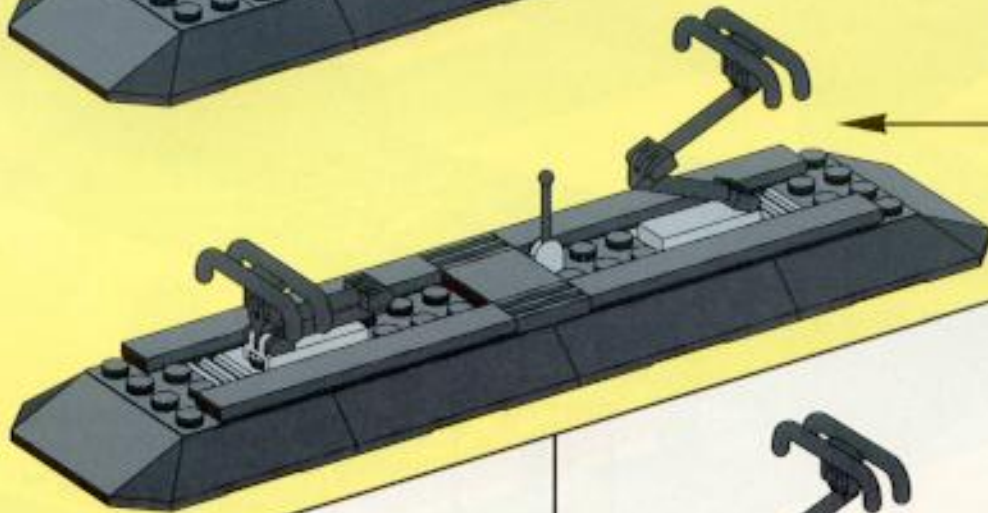

14





1

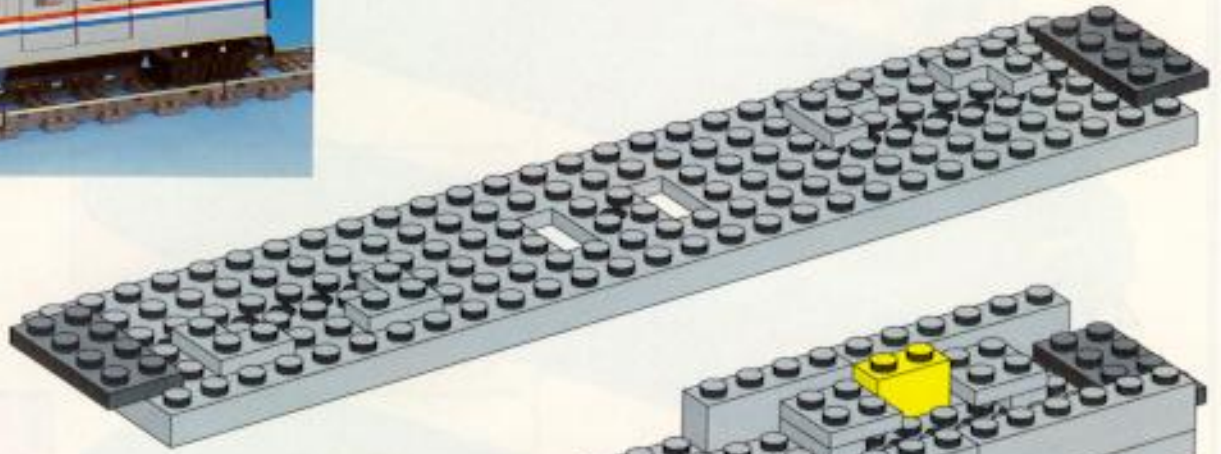

2

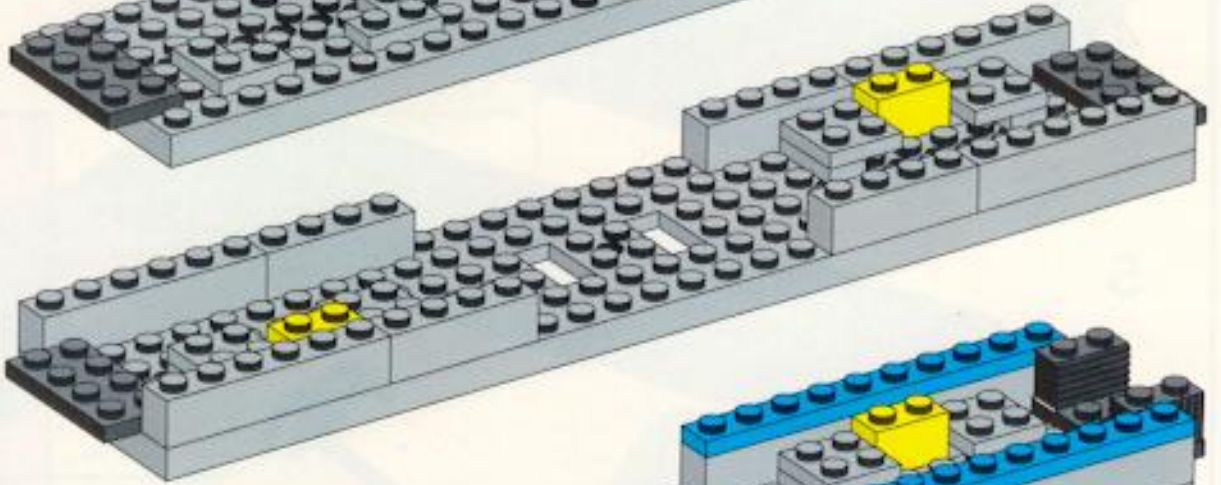

3

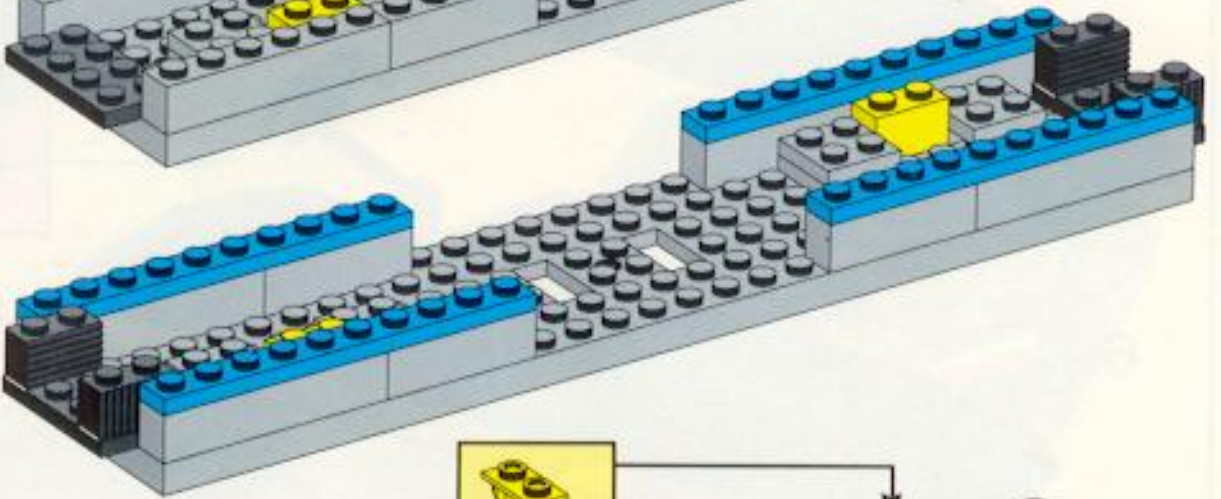

4

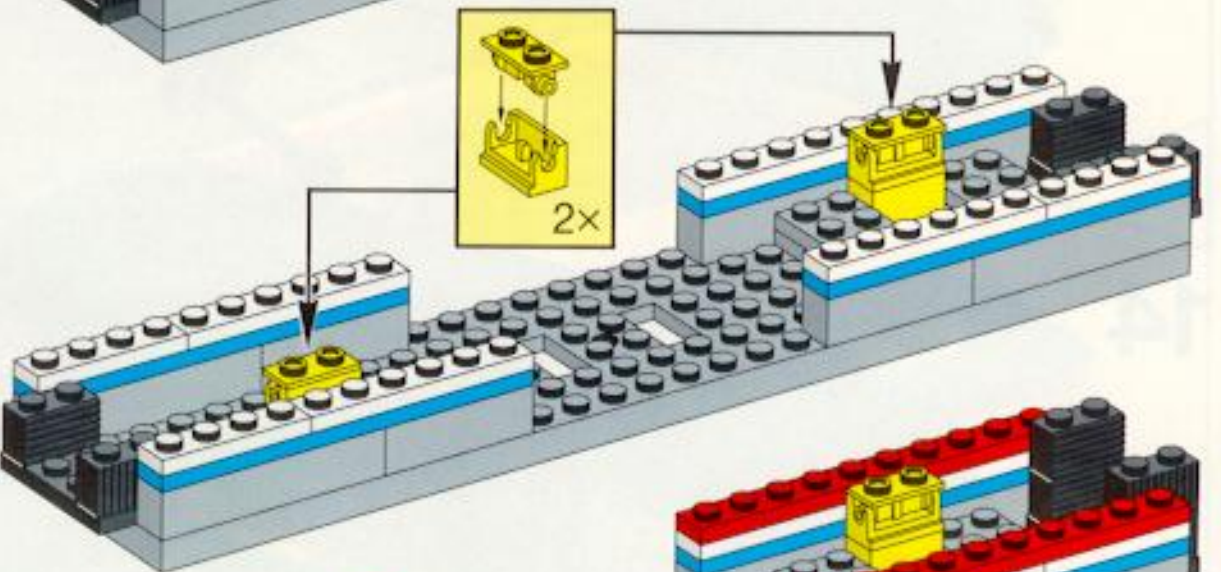

5

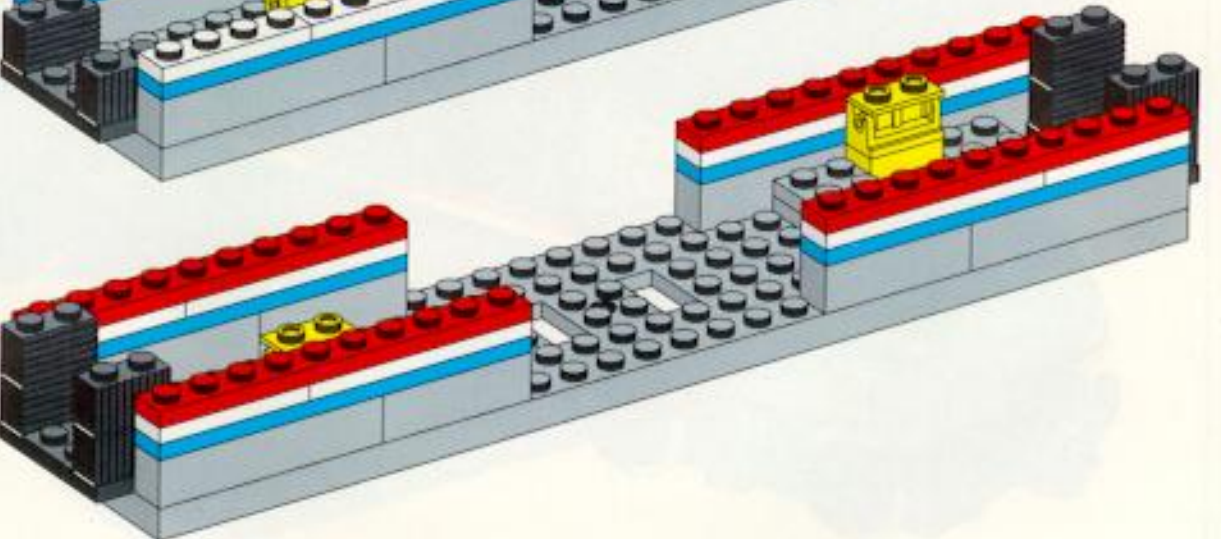

6

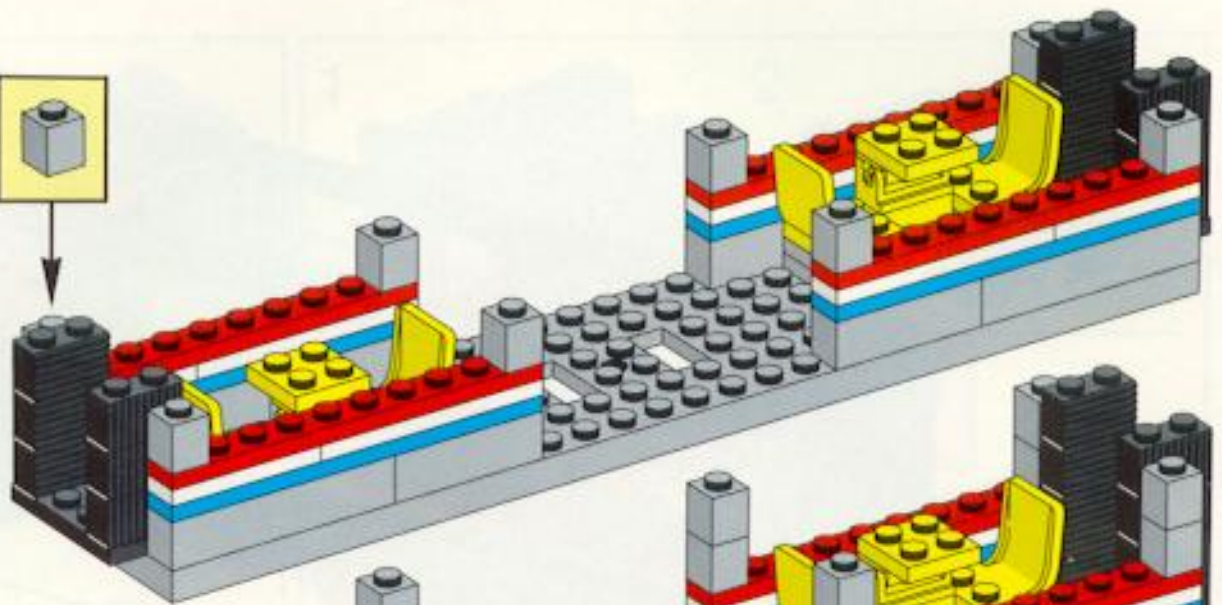

7

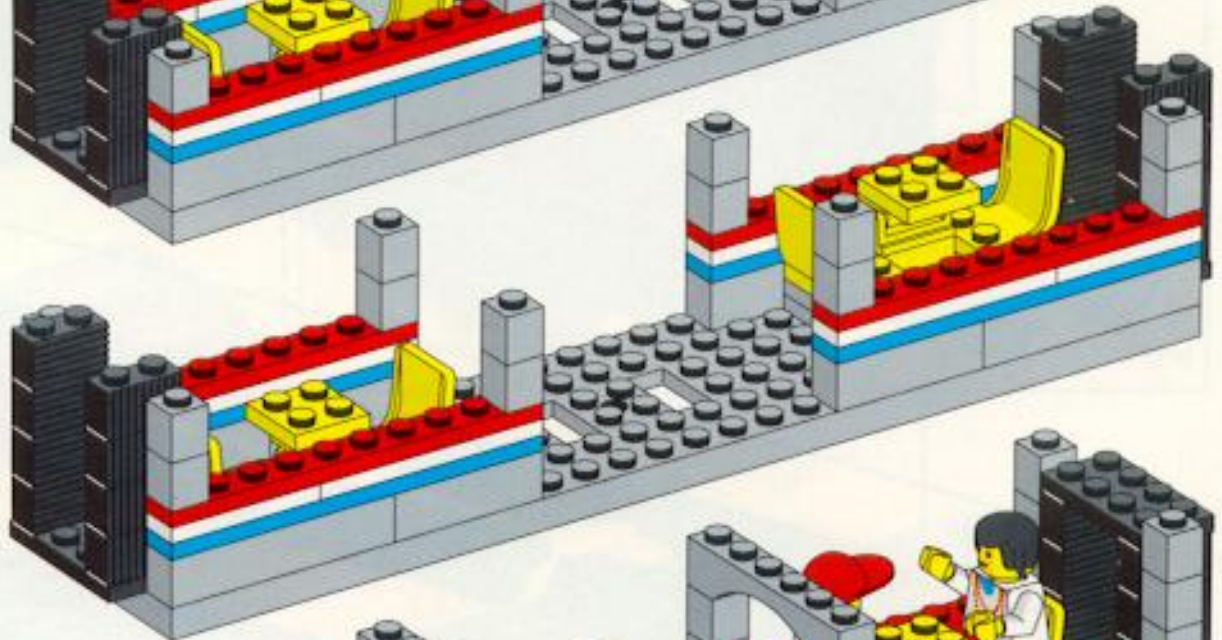

8

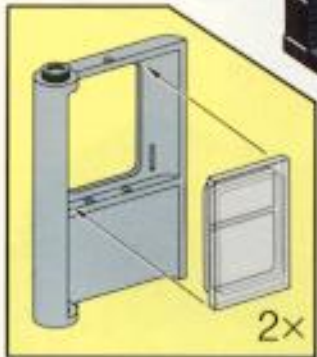
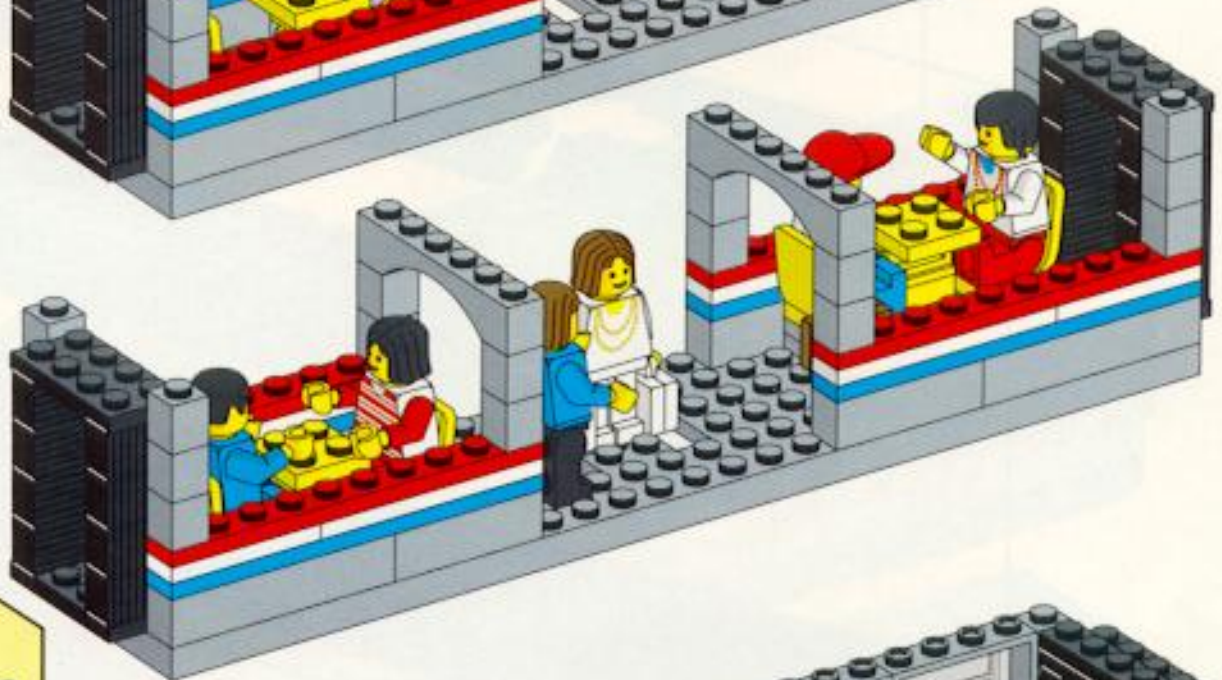

2x

9

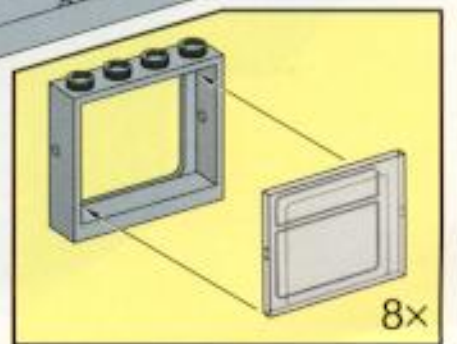
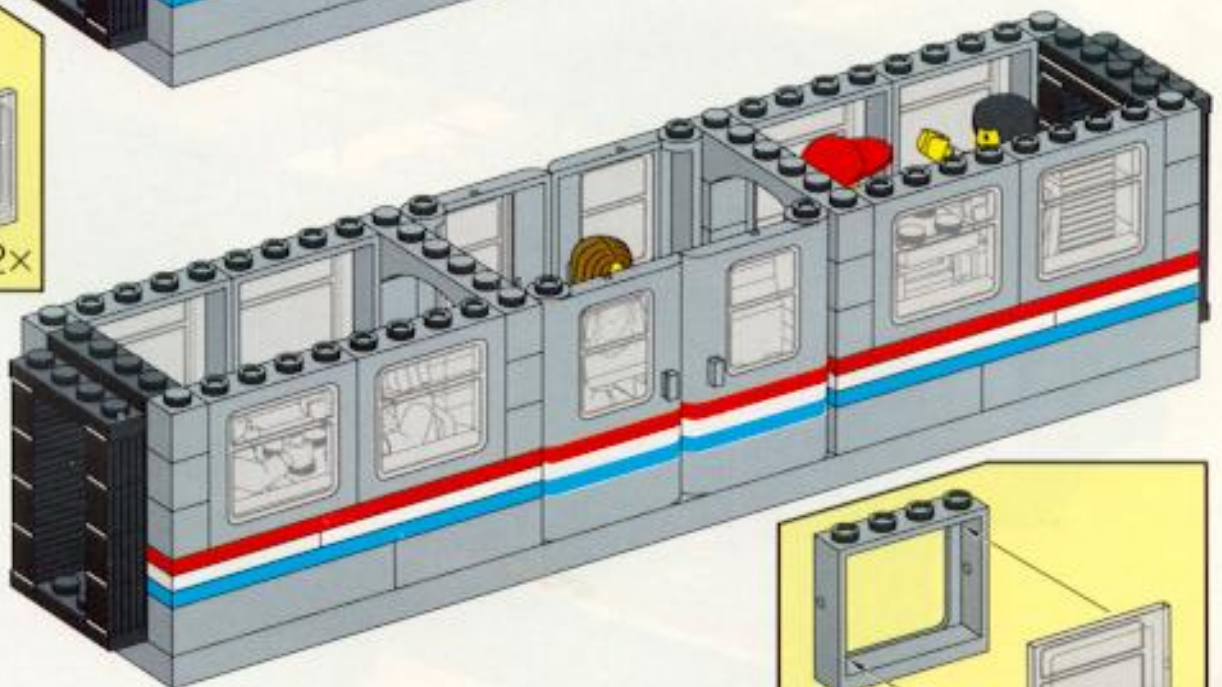

8x

10

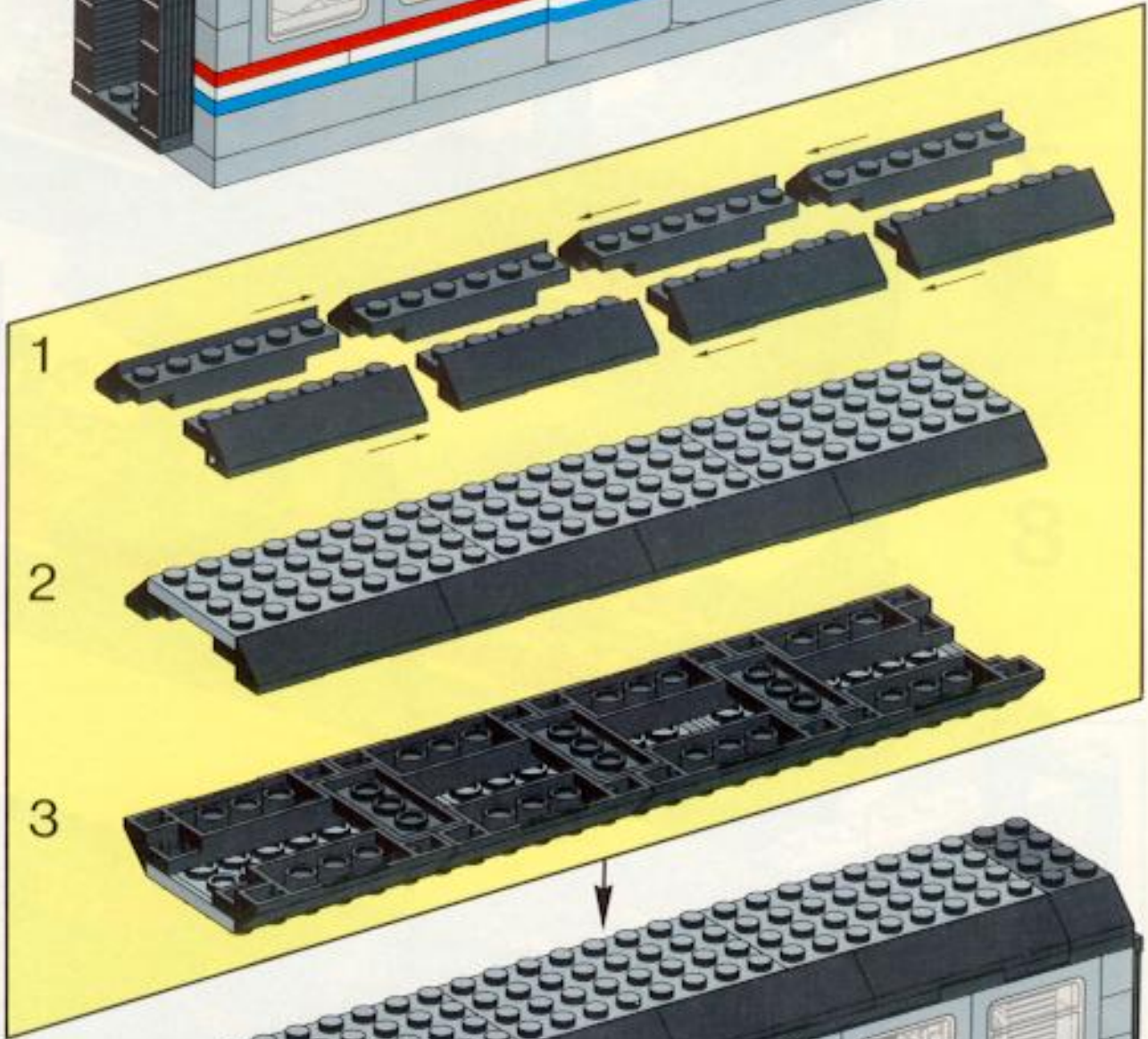
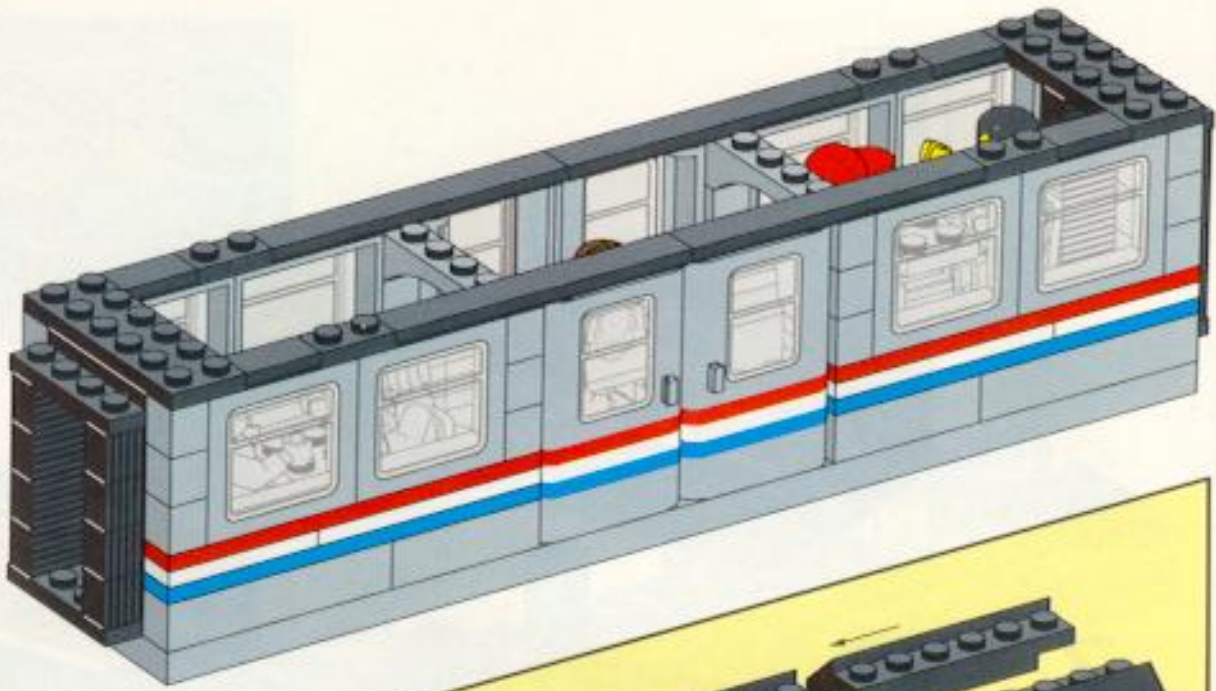

11

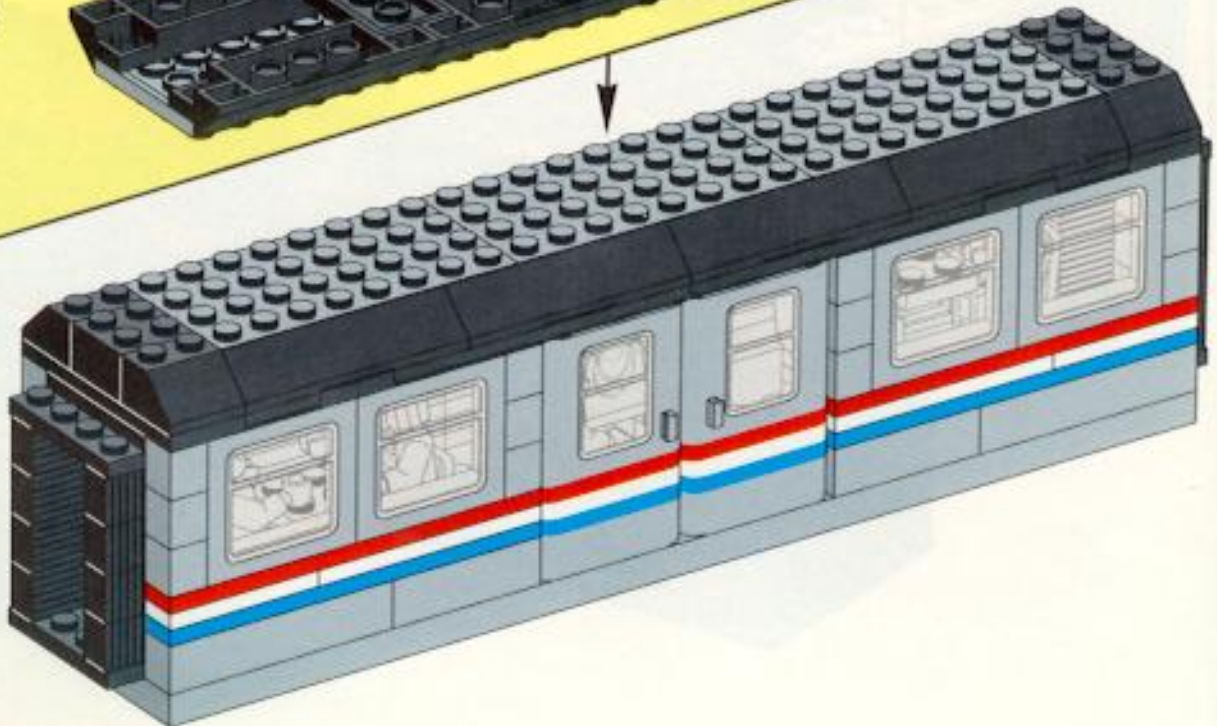

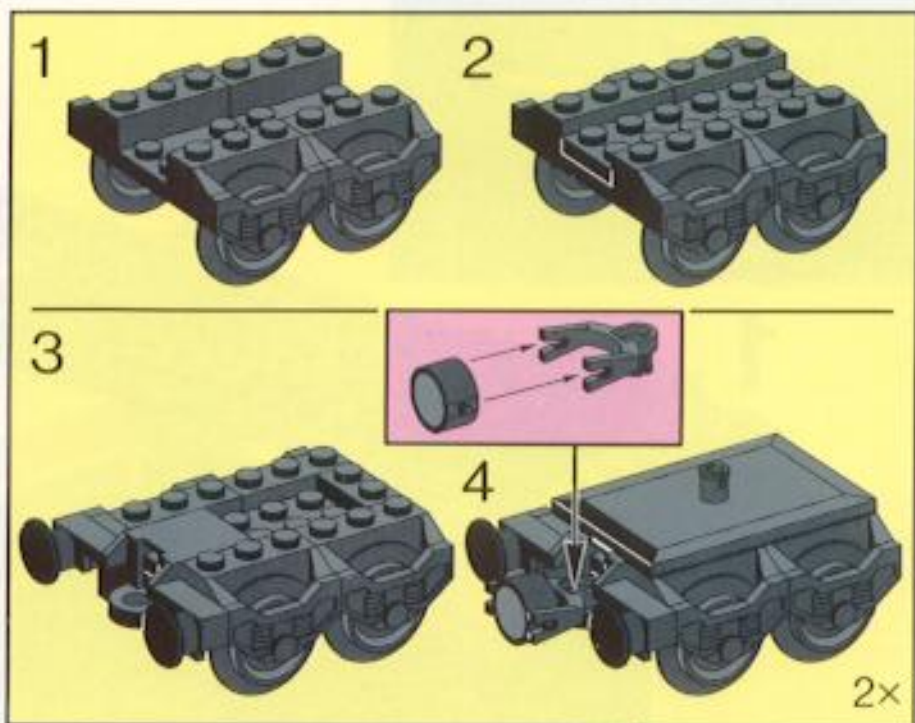
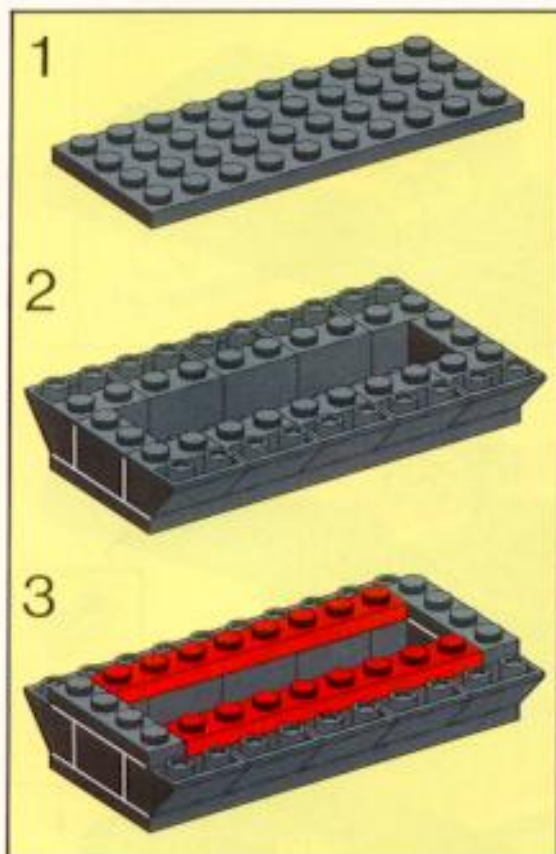

12

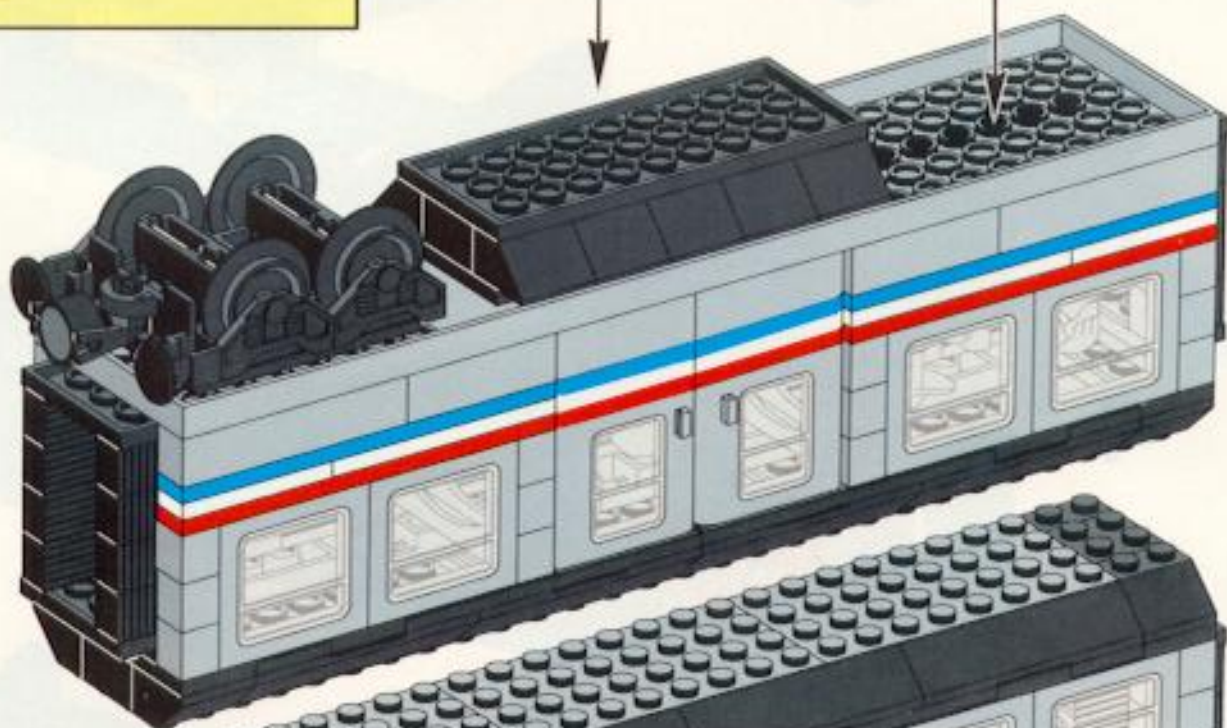

13





1

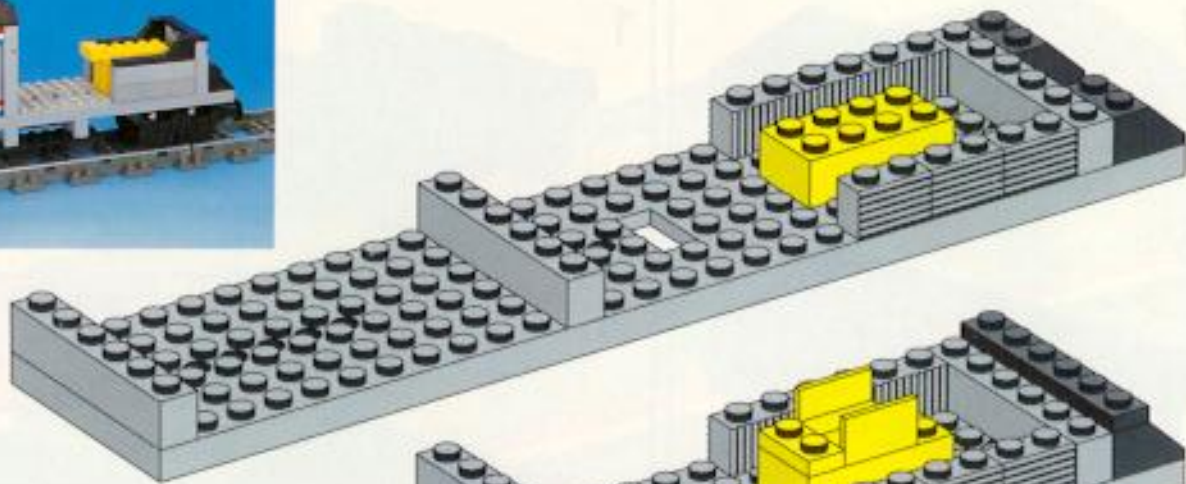

2

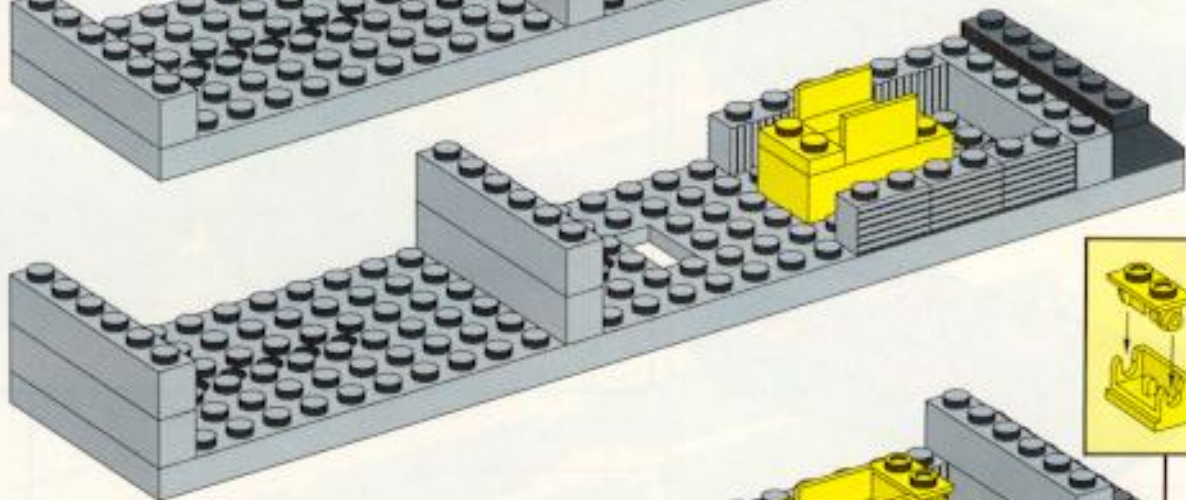

3

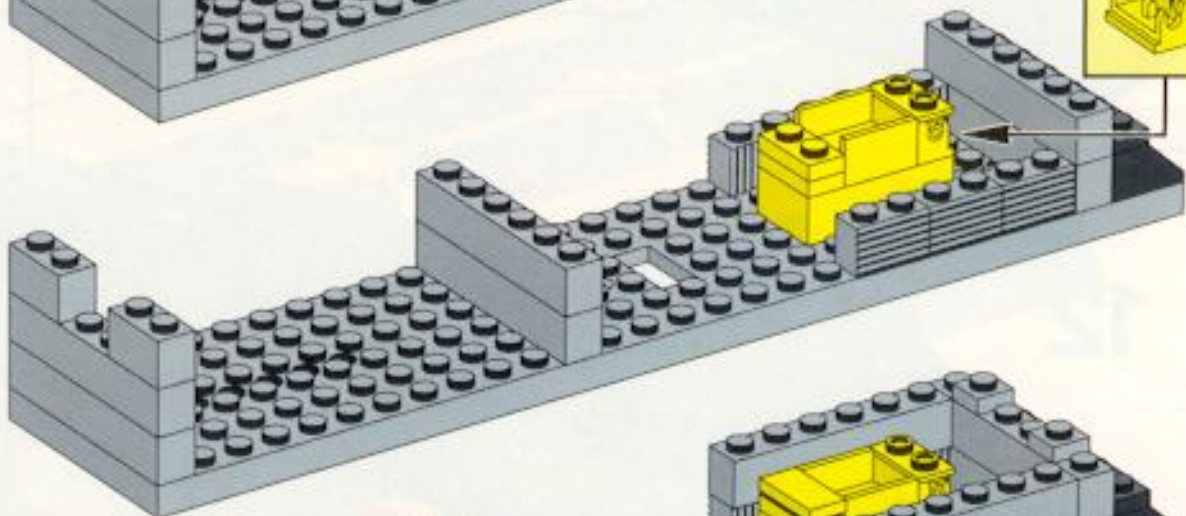

4

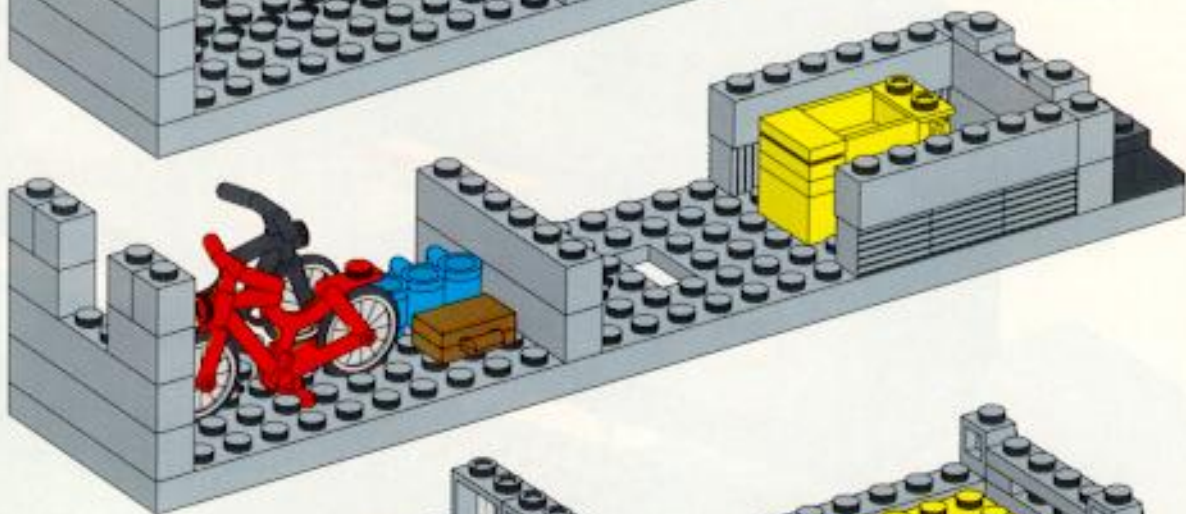

5

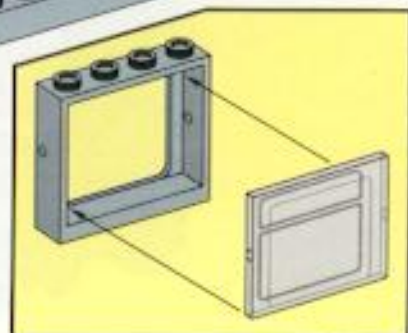
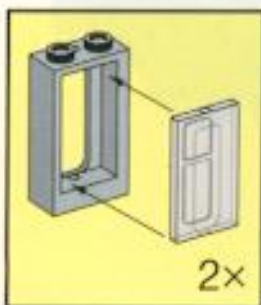
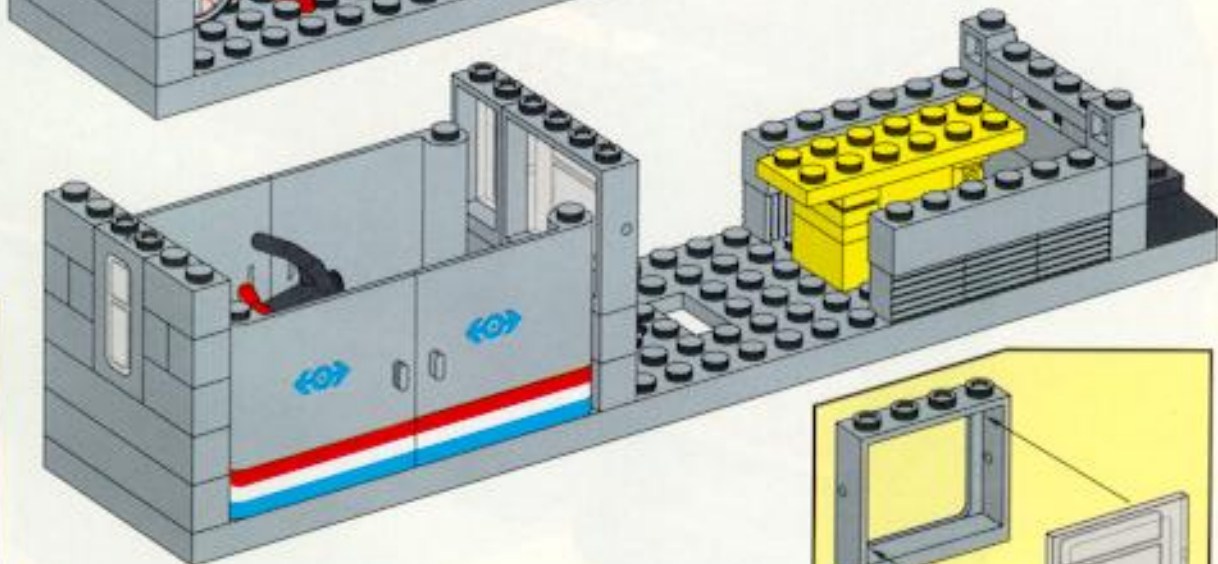

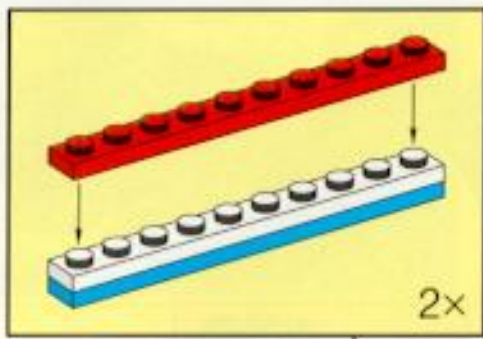

6

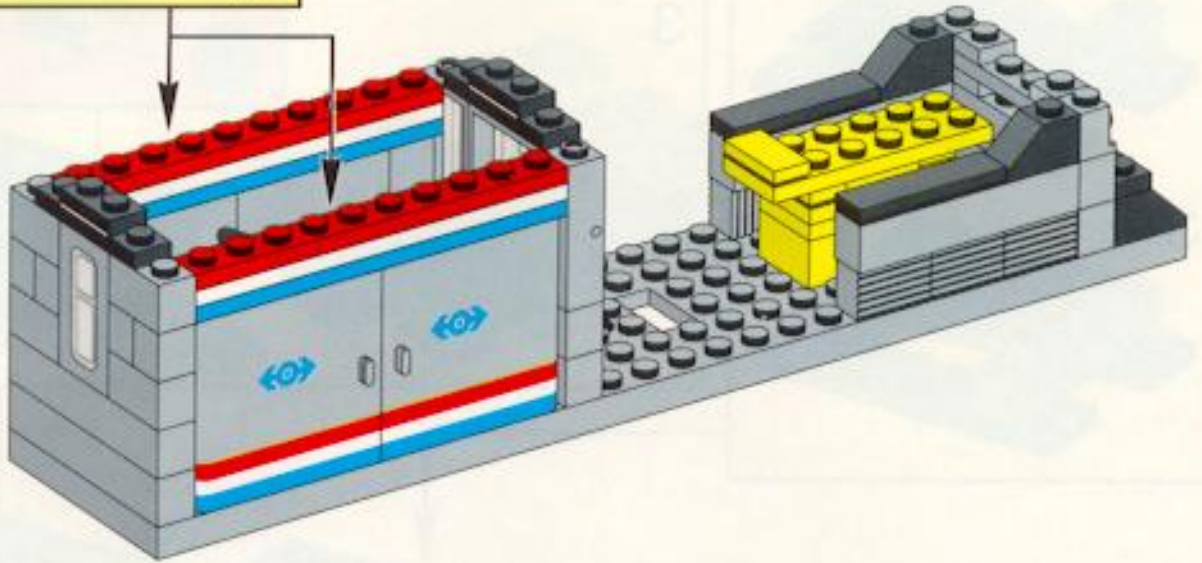

7

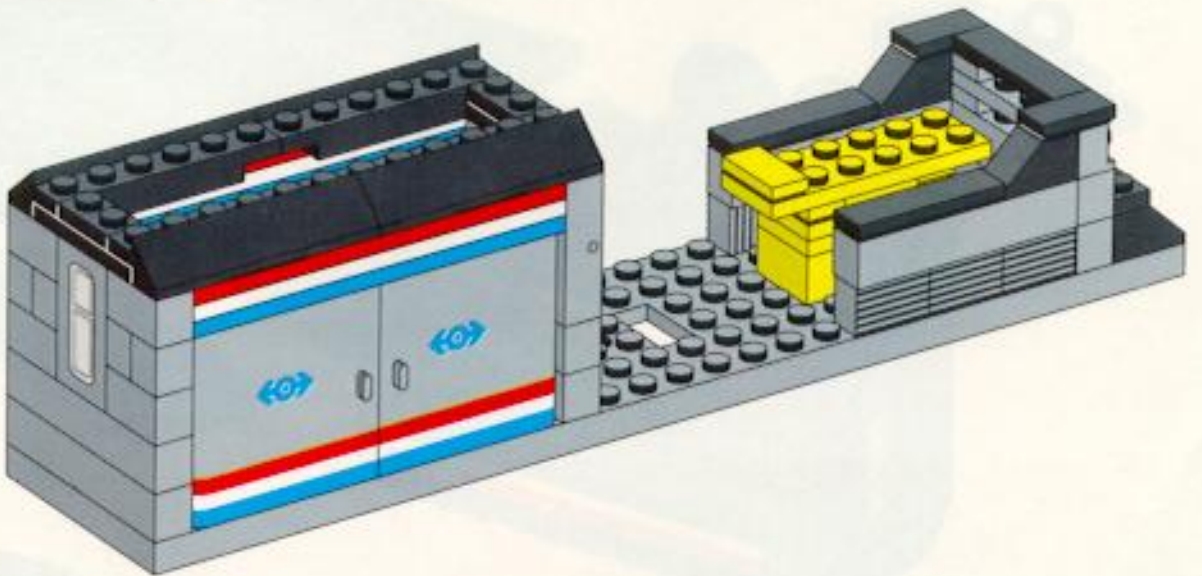

8

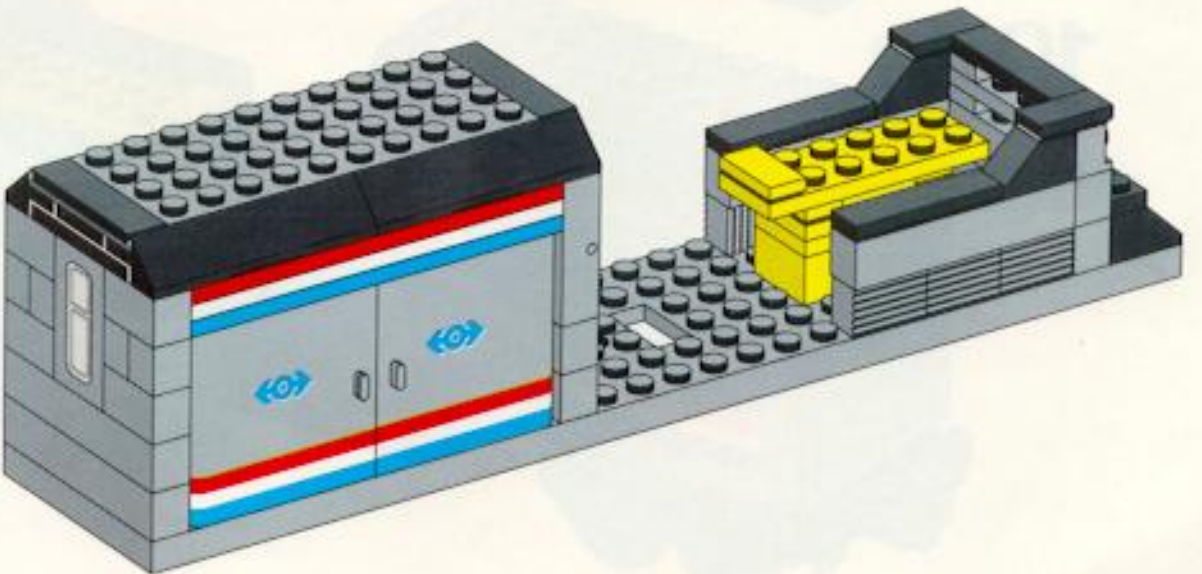

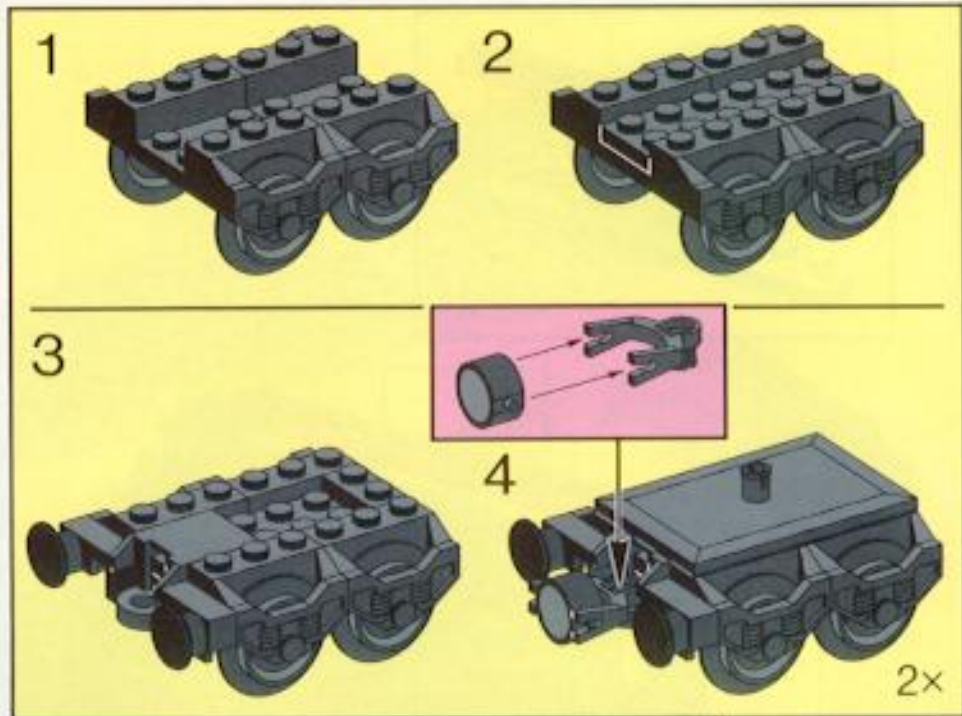
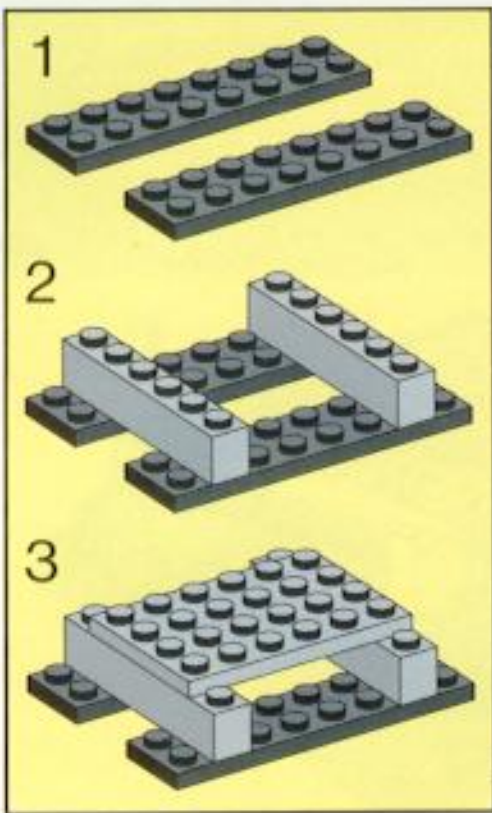

9

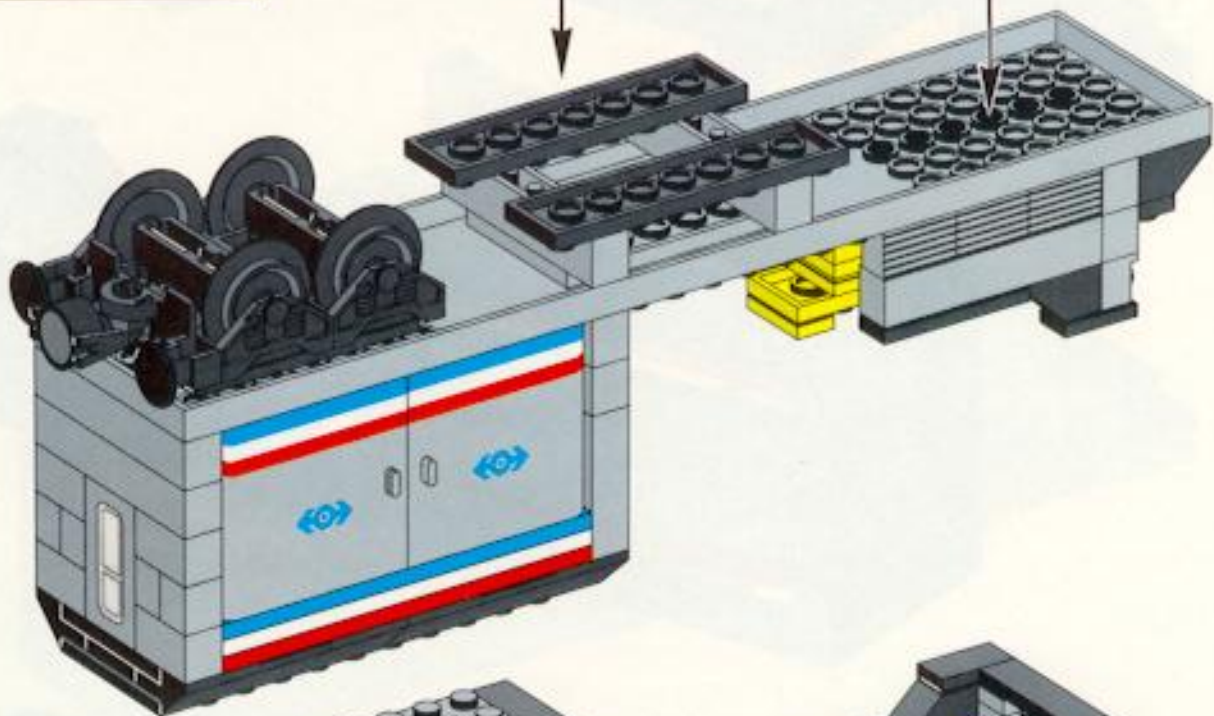

10

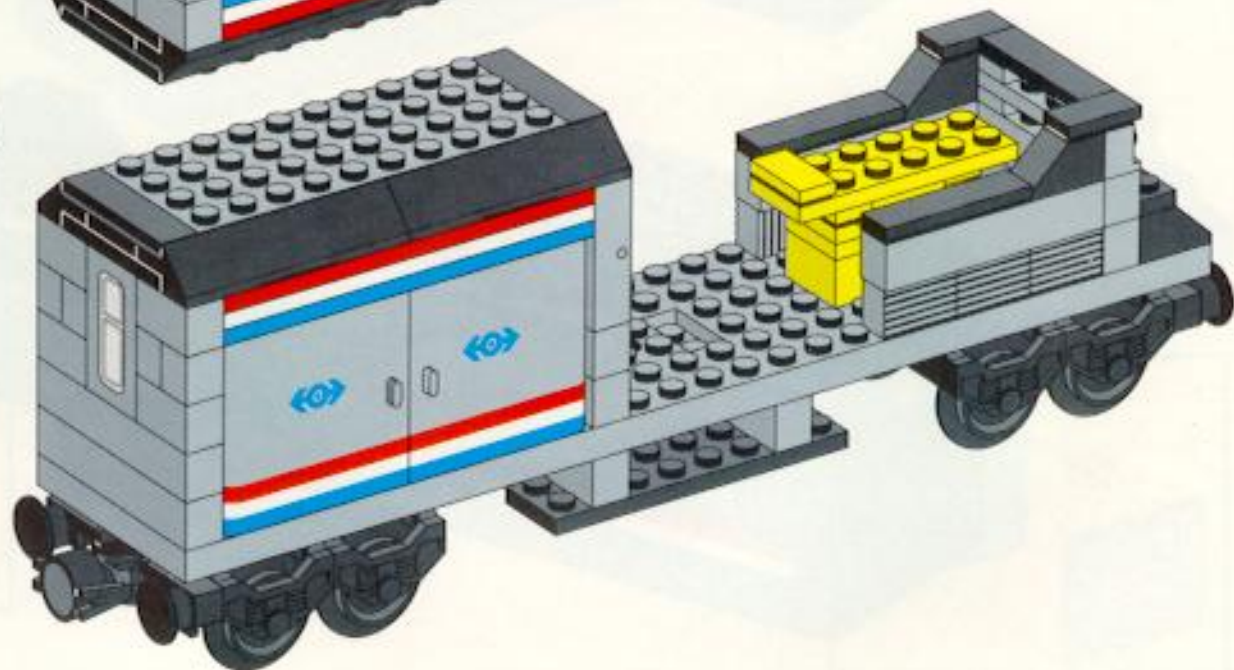



1

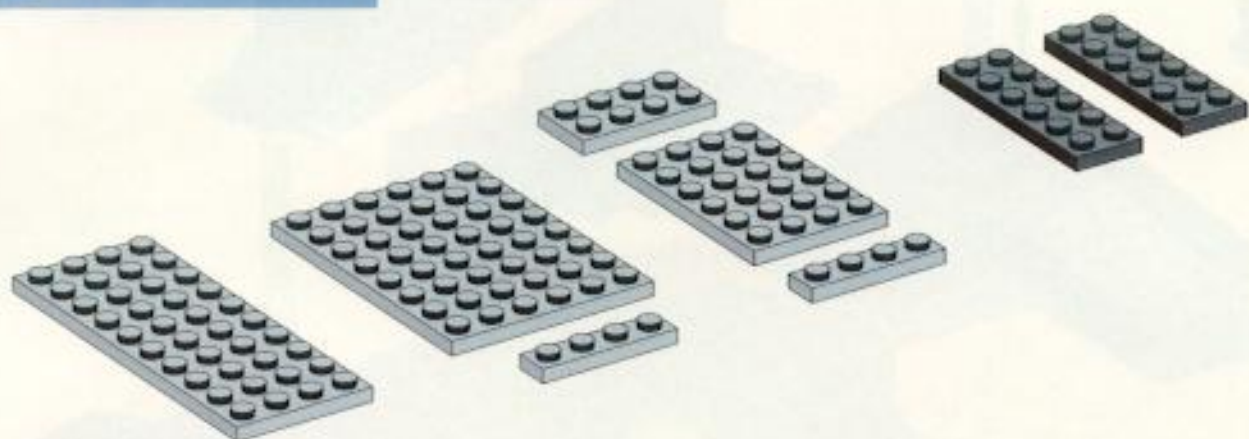

2

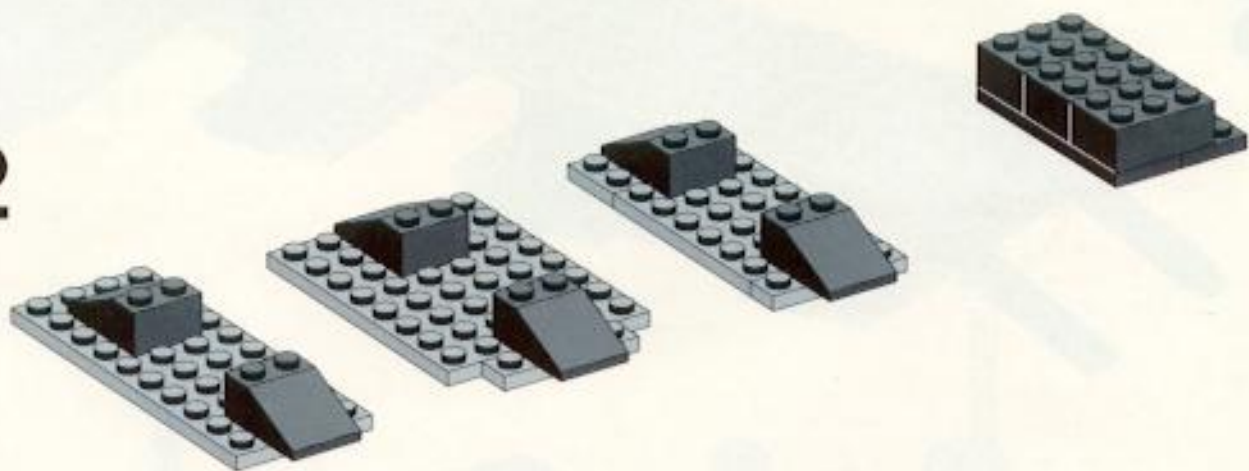

3

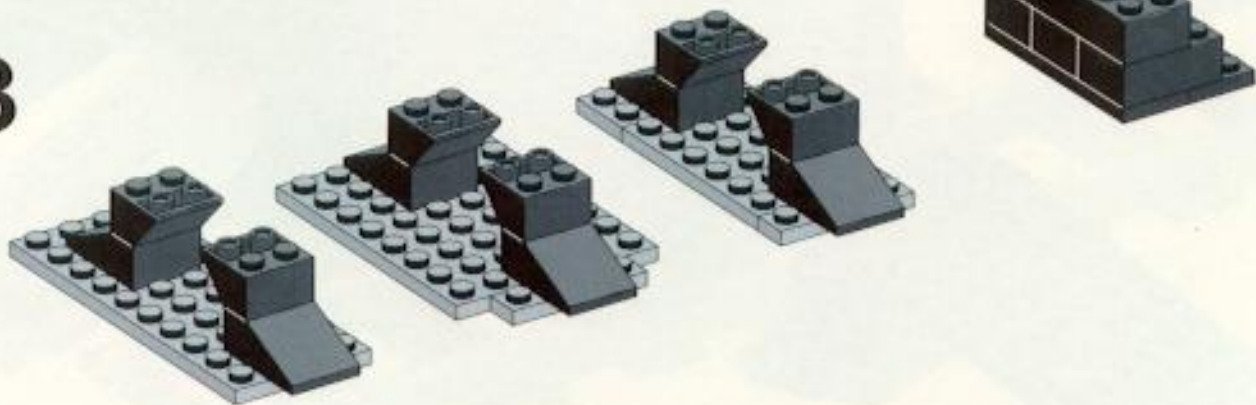

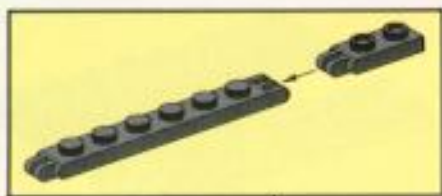

4

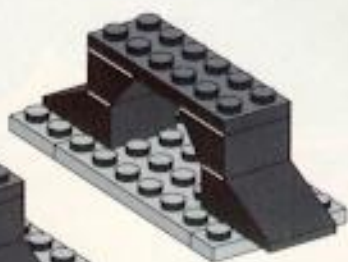
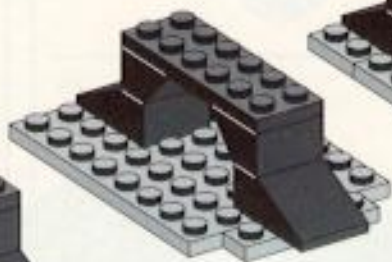

5

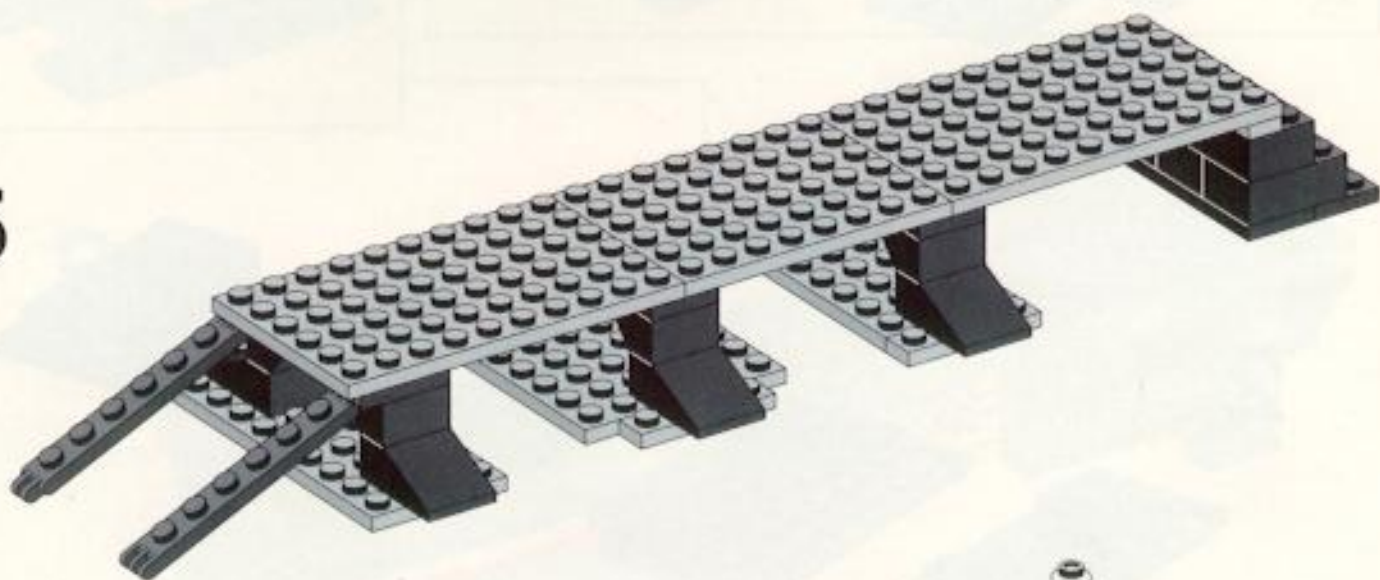

6

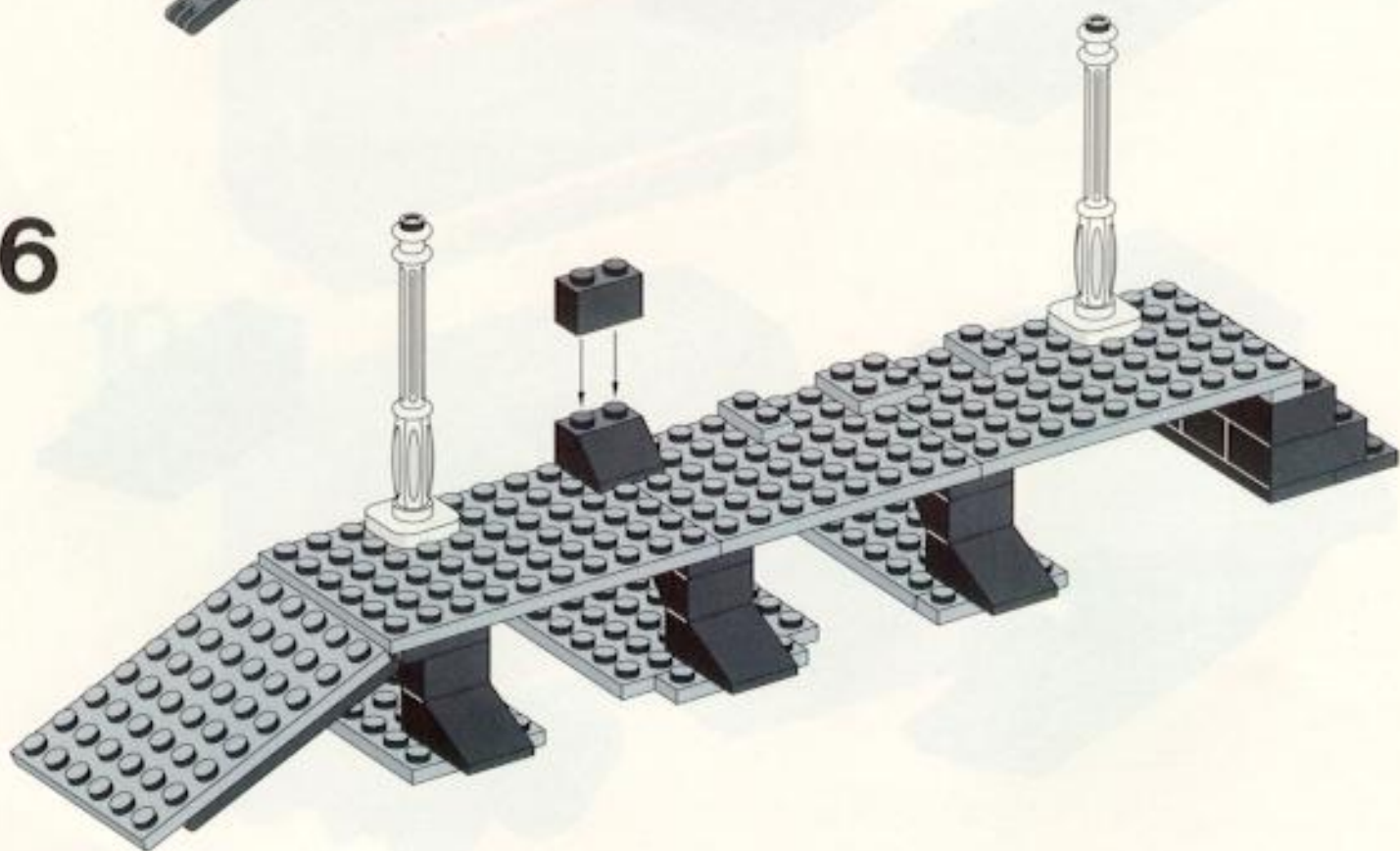

7

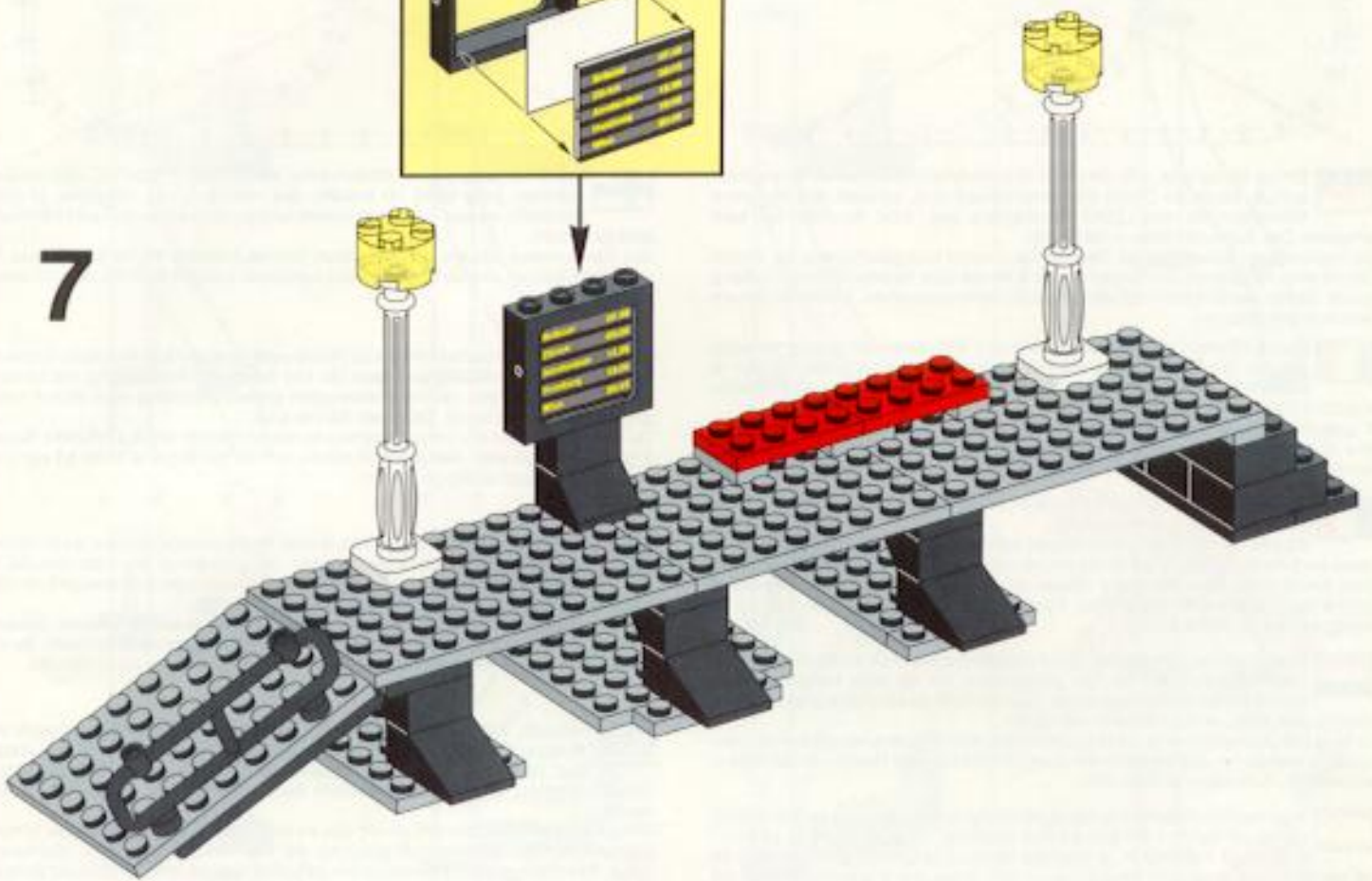
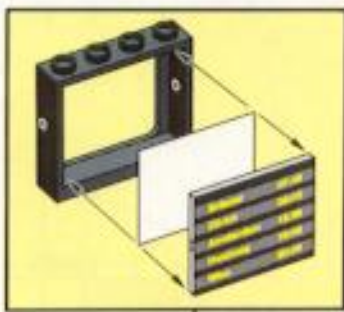

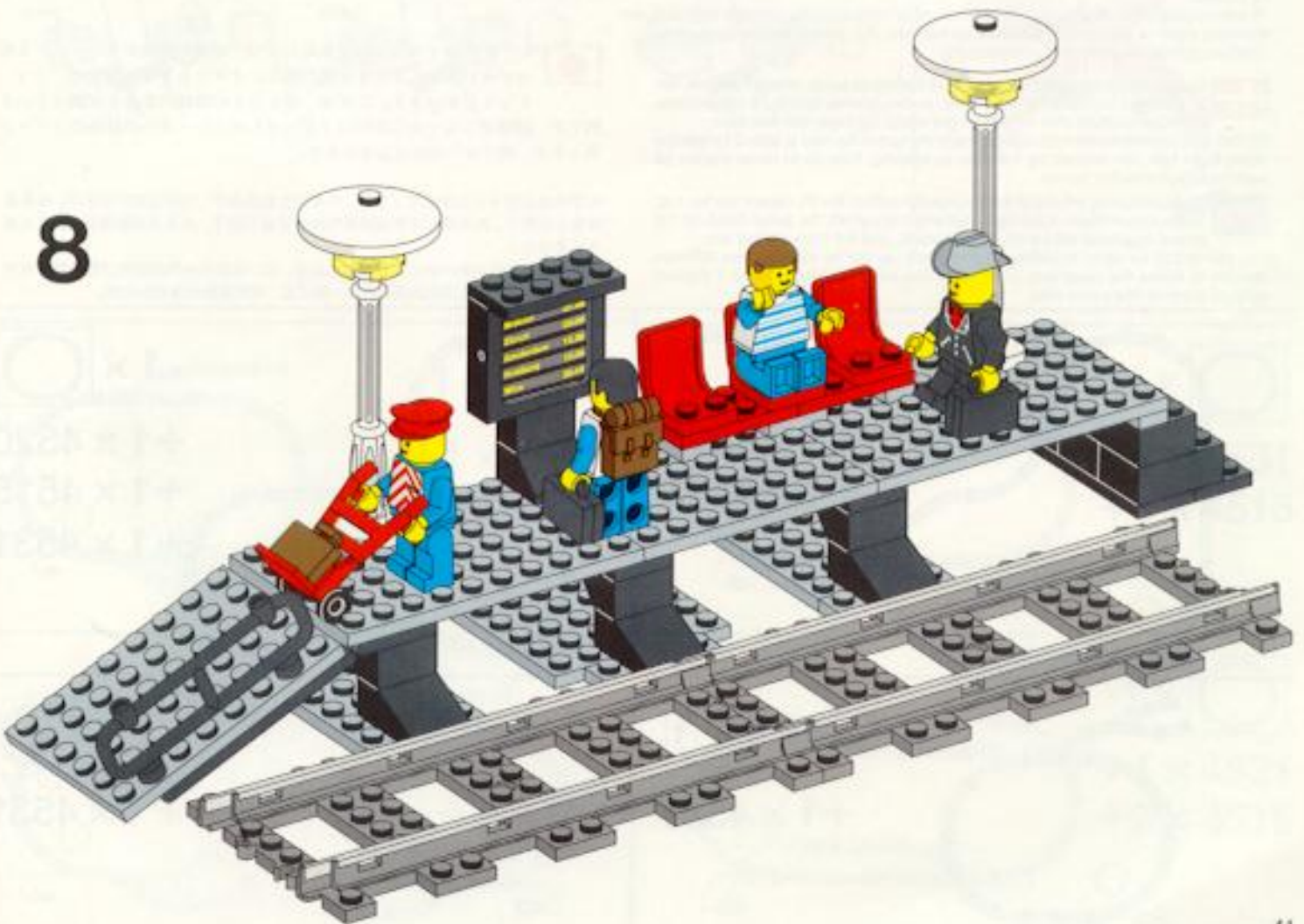

8

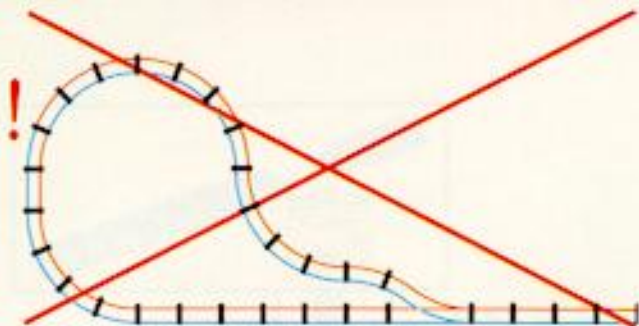





 Einige Gleispläne, z.B. die oben abgebildeten, verursachen einen Kurzschluss. Wenn die Gleise kurzgeschlossen sind, schaltet sich die grüne Kontrollleuchte des LEGO Fahrtreglers aus, bzw. leuchtet nur sehr schwach. Der Zug kann dann nicht fahren. Du kannst leicht feststellen, ob Dein Schienenkreis kurzgeschlossen ist, indem Du mit zwei verschiedenen Farben an der äußeren bzw. inneren Schiene entlang gehst. Treffen beide Farben auf derselben Schiene zusammen, ist das Schienenetz kurzgeschlossen.

 Alcuni elementi del circuito ferroviario 9 Volt possono causare un corto circuito. (Vedi illustrazioni a fondo pagina). In caso di corto circuito, la luce verde sul regolatore di velocità (speed regulator) è spenta o molto debole e il treno non parte. E' possibile accertare in quale punto avviene il corto circuito facendo in modo che due colori diversi corrispondano rispettivamente al binario esterno e a quello interno. Si avrà il corto circuito se i due colori si incontrano sullo stesso lato.

 Certains circuits de train 9 V peuvent provoquer un court-circuit - comme ceux montrés ici, par exemple. En cas de court-circuit, le témoin lumineux vert sur le régulateur de vitesse sera éteint ou très faible et le train ne roulera pas. Pour vérifier qu'un circuit peut fonctionner, dessinez votre réseau en prenant deux couleurs différentes pour le rail intérieur et le rail extérieur. Il y aura court-circuit si les deux couleurs se rejoignent sur le même côté.

 Sommige opstellingen van 9 Volt spoorbanen kunnen kortsluiting veroorzaken. Bijvoorbeeld de hier afgebeelde. Als de baan kortgesloten is, brandt het groene lampje op de stuureenheid (snelheidsregelaar) niet, of slechts zeer zwak, en de trein kan niet rijden. Je kunt zelf controleren waar de rails kortsluiten door met twee verschillende kleuren de buitenste en de binnenste rail te volgen. Als de twee kleuren elkaar ergens ontmoeten, is de baan kortgesloten.

 Algunas instalaciones de vías para trenes de 9V producen cortocircuitos, como por ejemplo las que aquí se muestran. Si se produce un cortocircuito en la instalación, la lámpara verde de la unidad de regulación de velocidad estará apagada o tendrá una luz muy tenue, por lo que el tren no podrá funcionar. Tú mismo puedes controlar dónde se produce el cortocircuito, dejando que dos distintos sigan la fila exterior e interior de las vías. Allí donde los dos colores se unen es donde se produce el cortocircuito.

 Nogle opbygninger af 9V togbaner vil forårsage kortslutning, f.eks. de, der er vist her. Hvis banen er kortsluttet, er den grønne lampe på reguleringsenheden slukket, eller vil lyse meget svagt, og toget kan ikke køre. Du kan selv kontrollere hvor din baneopbygning kortslutter ved at lade 2 forskellige farver følge hhv. den yderste og inderste sporstreng. Hvis de to farver mødes på samme side, kortslutter banen.

 Short circuiting will result from some lay-outs of the 9V railway tracks, e.g. those shown here. If the track has short circuited, the green lamp on the speed regulator will be off, or very weak, and the train will not run. You can check for short circuiting of your track lay-out by allowing two different colours to follow the outer and inner rails. The track will short circuit if the two colours meet on the same side.

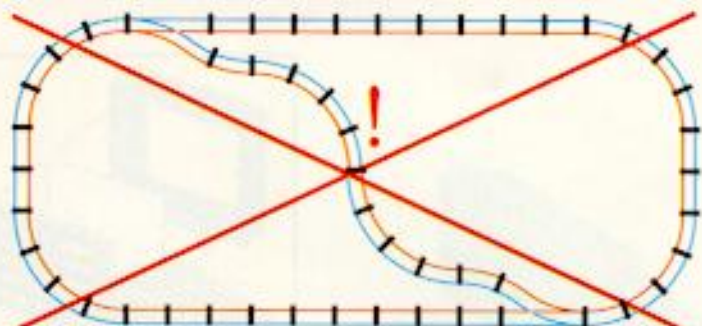

 Eräät 9V junaratojen rakennelmat aiheuttavat oikosulun, esimerkiksi sellaiset, jotka tässä on kuvattu. Jos radalla syntyy oikosulku, ei sääntöyksikön (speed regulator) vihreä lamppu pala tai se on hyvin himmeä eikä juna kulje. Voit itse tarkistaa oikosulun syntypaikan. Seuraa kahdella eri värillä ulompaa ja sisempää kiskoa. Jos nämä kaksi väriä kohtaavat samalla kiskolla, on rata oikosulussa.

 En del sammansättningar av 9V-banläggningar kan försäkra kortslutning, t.ex. sådana som visas här. Om banan fått kortslutning, släcks den gröna lampan på manöverenheten (speed regulator) eller också lyser den endast mycket svagt. Tåget kan då inte köra. Du kan själv se hur din bananläggning kortsluter genom att låta två olika färger följa den yttersta resp. den innersta rälsen. Om de två färgerna möts på samma sida uppstår kortslutning på banan.

 Algumas construções de vias férreas de 9V poderão causar curto-circuitos, p.ex., as que se mostram aqui. Se a via sofrer um curto-circuito, a lâmpada verde da unidade reguladora (speed regulator) apagará ou brilhará com menos força, e o comboio não poderá andar. Você mesmo pode controlar o local de curto-circuitos da sua própria via, deixando 2 cores diferentes seguir o trilho exterior e interior, respectivamente. Se as duas cores se encontrarem no mesmo lado, a via sofrerá um curto-circuito.

 Μερικές διατάξεις των γραμμών του εννιάβολτου τρένου προκαλούν βραχυκυκλώμα, όπως π.χ. αυτή που φαίνεται στο σχέδιο. Όταν οι γραμμές βραχυκυκλώνουν, το πράσινο φωτάκι στο ρυθμιστή ταχύτητας (speed regulator) θα σβήσει, ή θα είναι πολύ αδύνατο, και το τρένακι δεν θα τρέξει. Μπορείς να ελέγξεις και από μόνος σου αν οι γραμμές βραχυκυκλώνουν, χρησιμοποιώντας δύο διαφορετικά χρώματα για την εσωτερική και την εξωτερική ράγα. Αν τα δύο χρώματα συναντηθούν στην ίδια πλευρά, τότε οι γραμμές βραχυκυκλώνουν.

 レールのレイアウトのしかたにより、電流の回路がショートする場合があります。たとえば図の様なレイアウトをした場合は、ショートしてしまいます。これは、ポイントの接続のしかたが誤っている例です。回路がショートした時はスピードレギュレーターの緑色のライトが消えるか、暗くなり列車は止まります。

如果您鋪設的9伏特鐵軌出了錯誤，將會發生短路現象，例如這裏所顯示的。如果鐵軌發生短路了，此時顯示速度調節器的綠燈就會不亮了，或者是非常微弱，而且火車也不會前進了。如果您要檢查您鋪設的軌道是否會發生短路，可以用兩種不同的顏色沿著內側的和外側的軌道前進，如果這兩個顏色在同一點交會，那麼鐵軌就會發生短路。

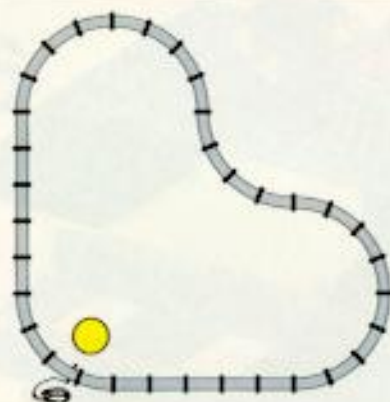

1 x 
+1 x 4520
+1 x 4515

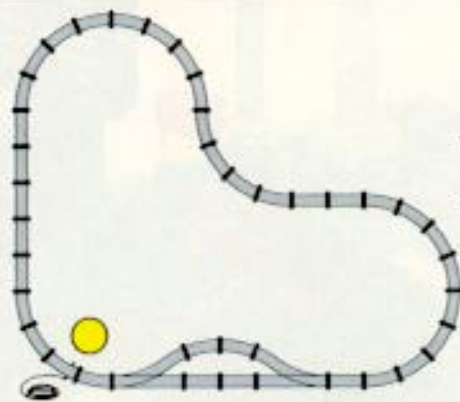

1 x 
+1 x 4520
+1 x 4515
+1 x 4531

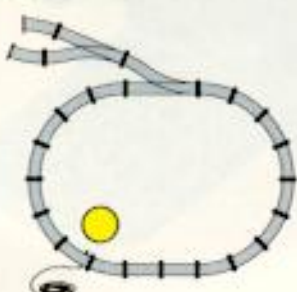

1 x 
+1 x 4531



1 x 
+1 x 4531

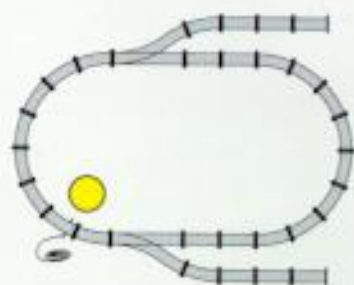
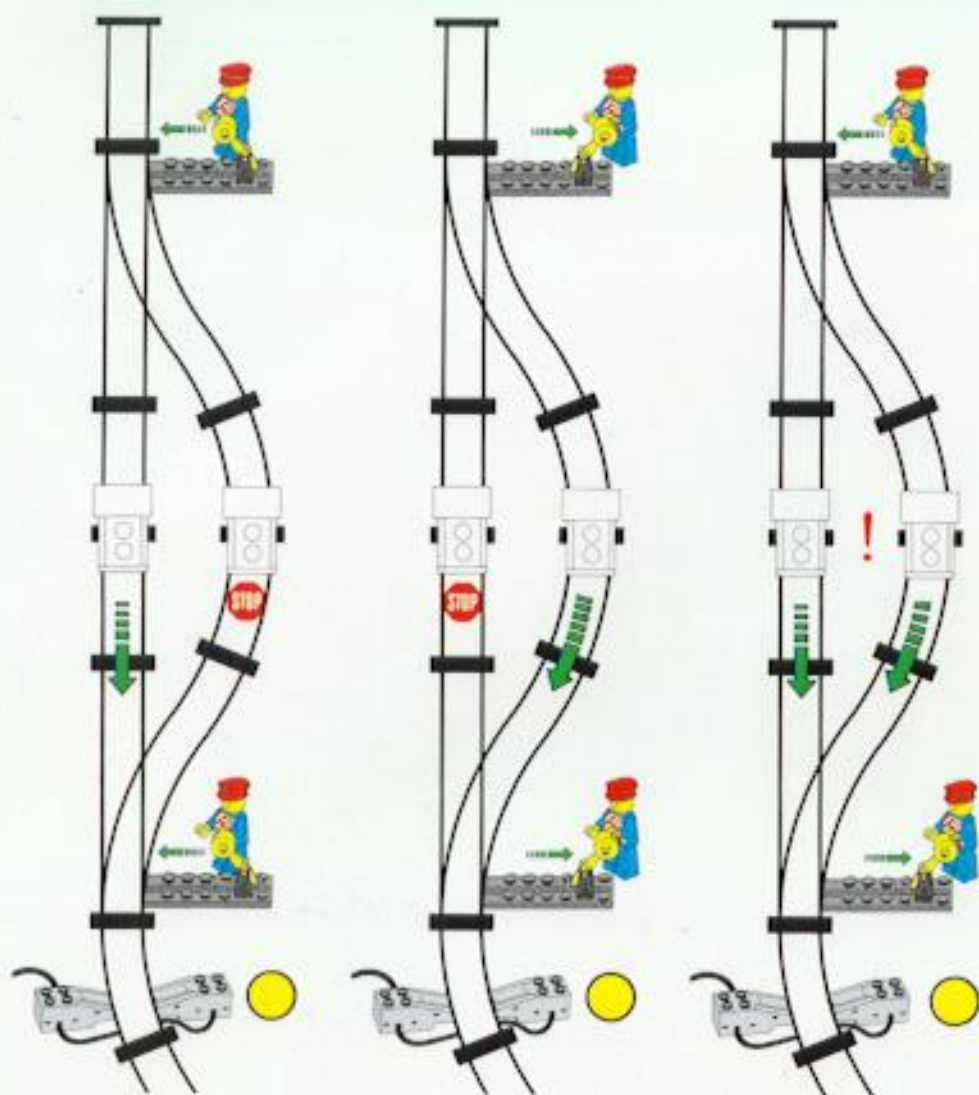

1 × 
 +1 × 4531
 +1 × 4515



1 × 
 +1 × 4531
 +1 × 4515



1 × 
 +1 × 4531
 +1 × 4520

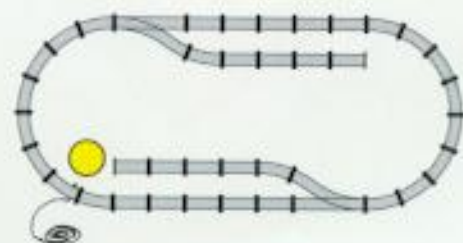

1 × 
 +1 × 4531
 +2 × 4515

