

LEGO

4714

Harry Potter™

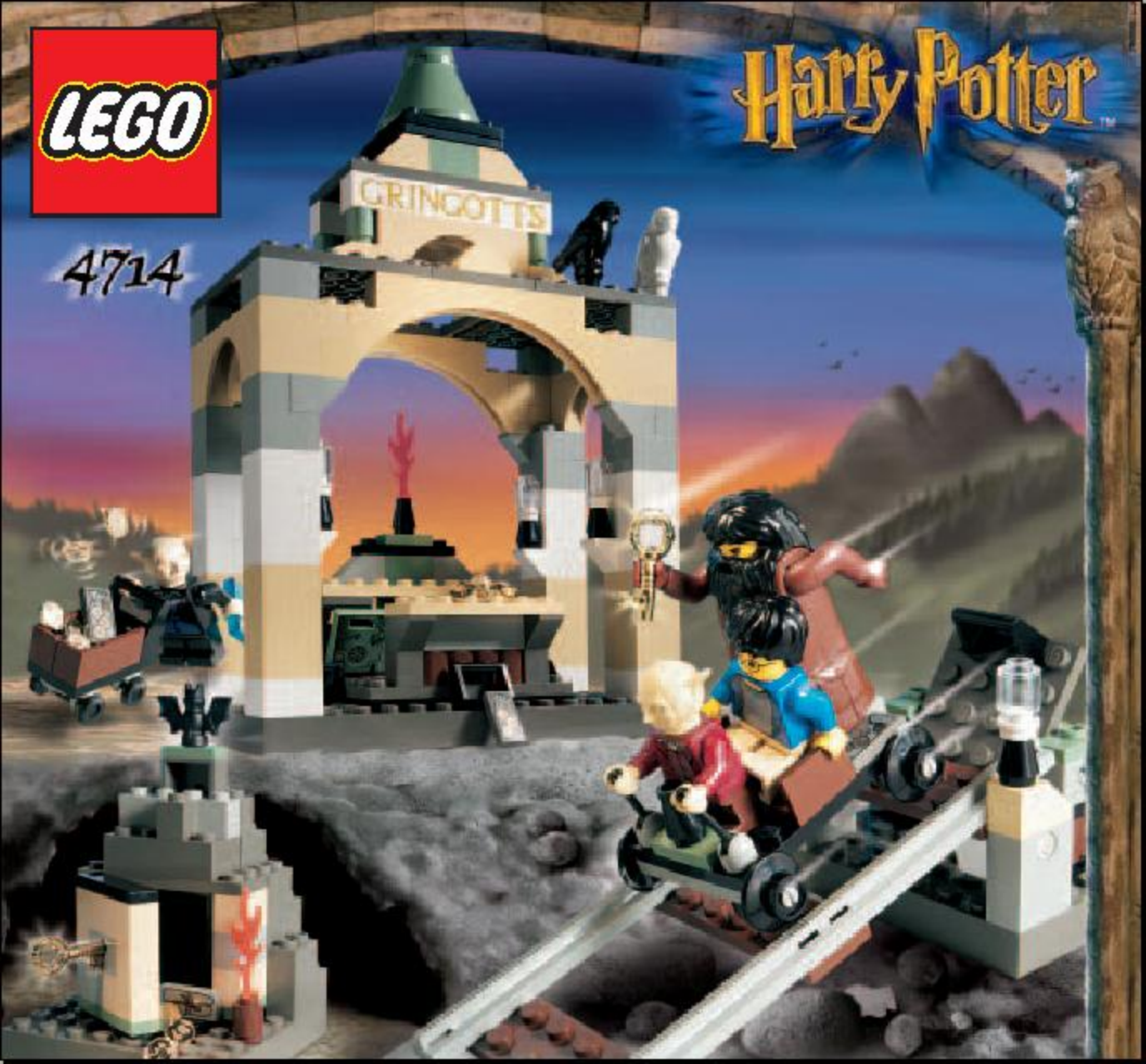

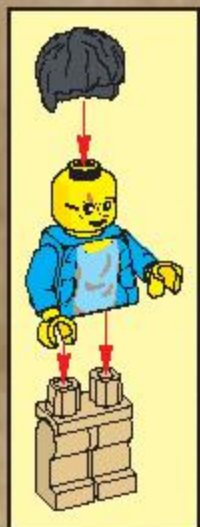
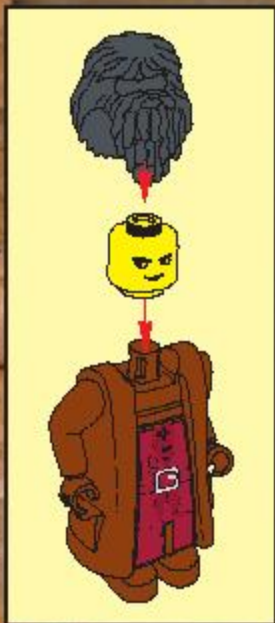



1

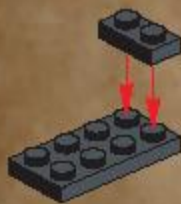

2



3

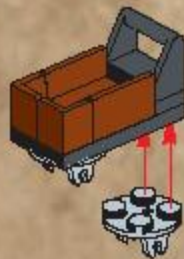

4





1



2



3



4

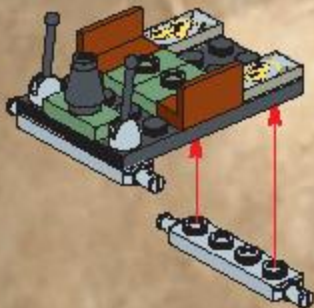

5

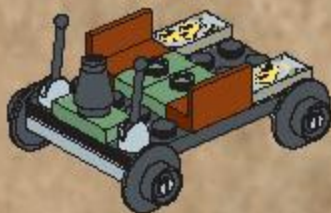

6





1

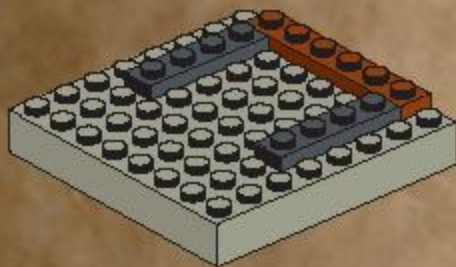

2

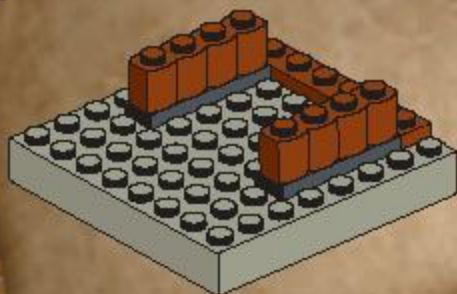

3

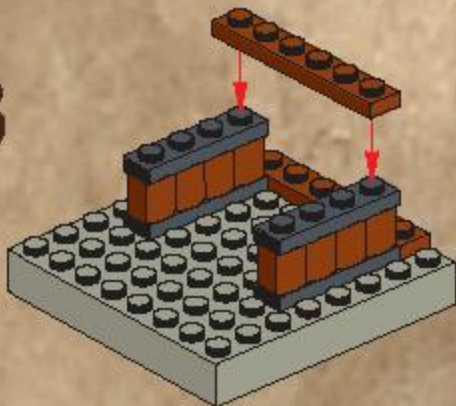

4



1

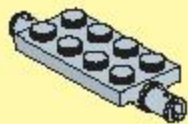

2



3

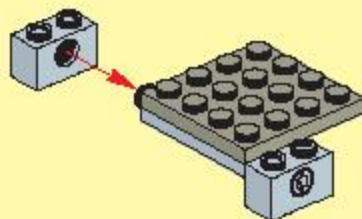

4



5

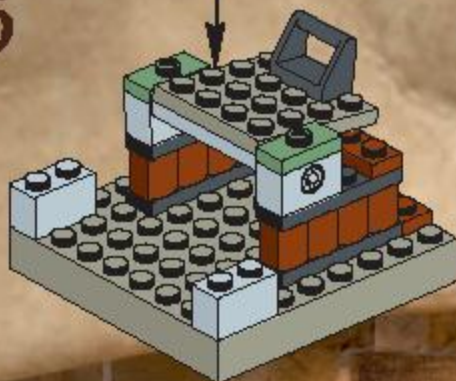

1

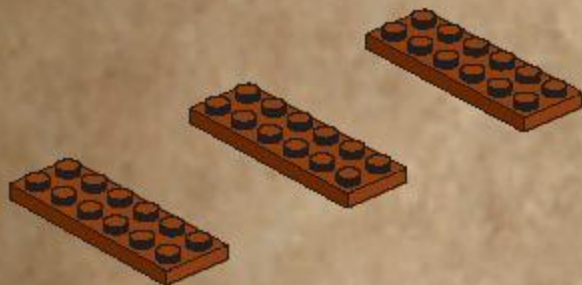

2

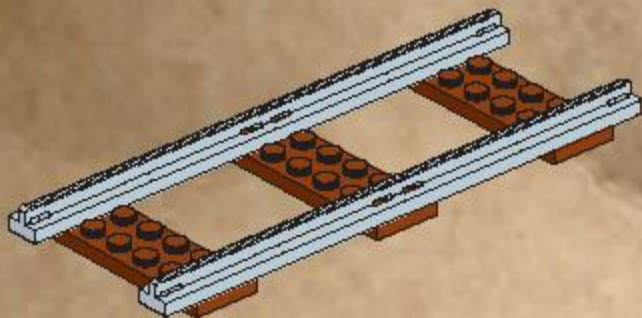

3

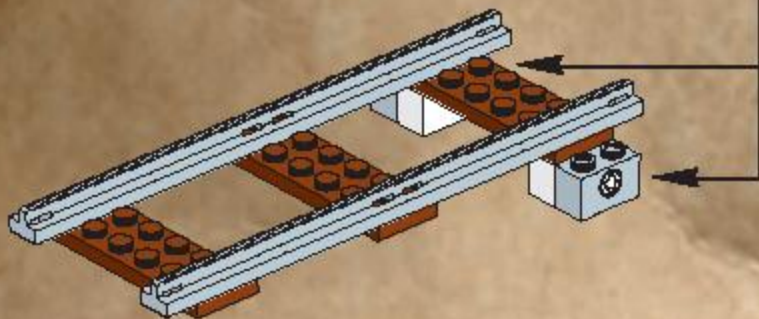
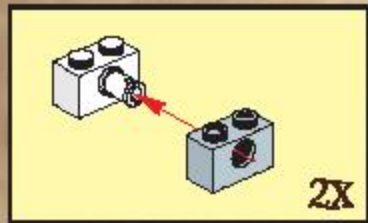

6

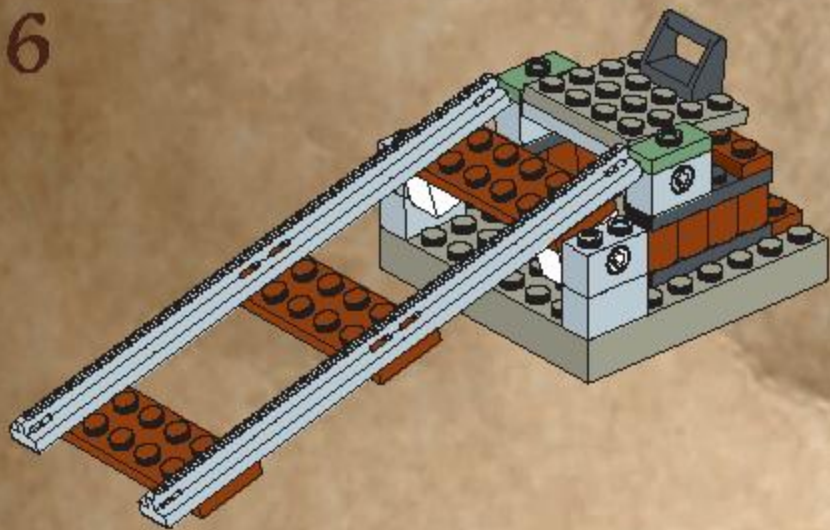

7

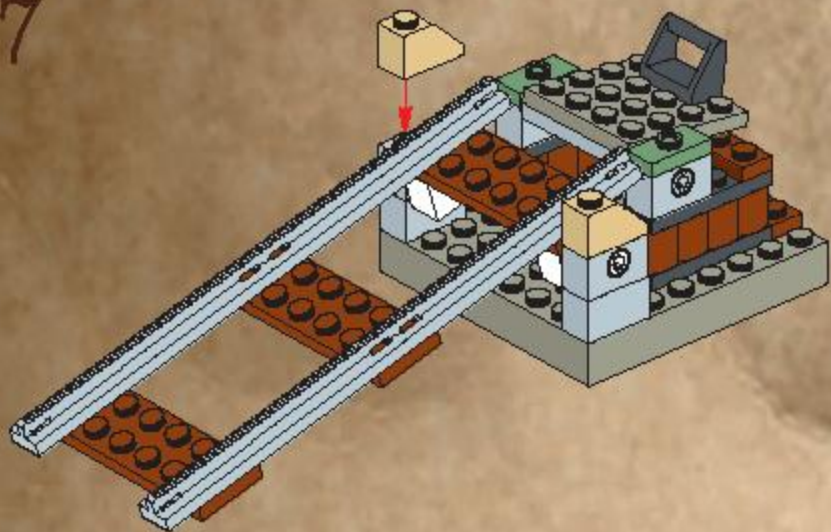

8

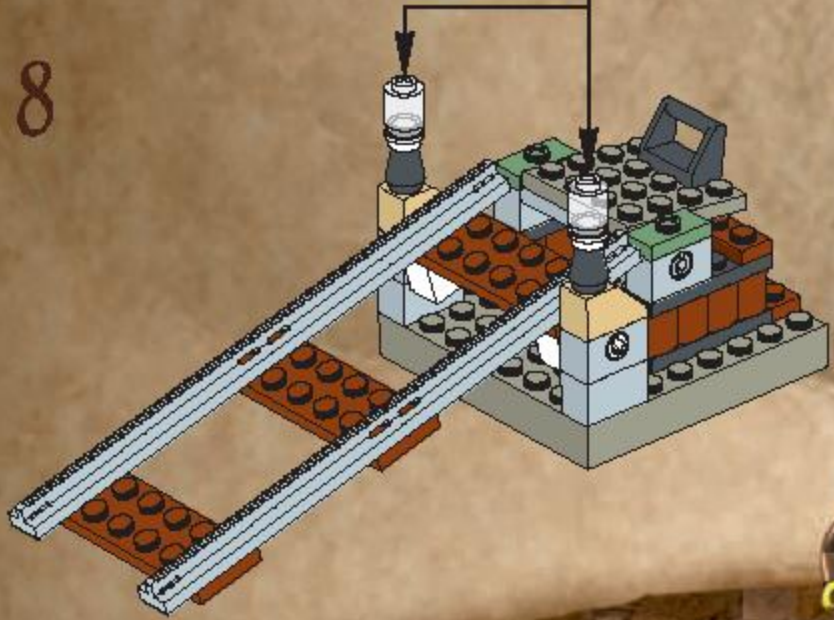
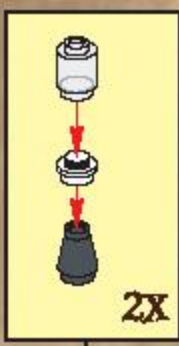

11



1

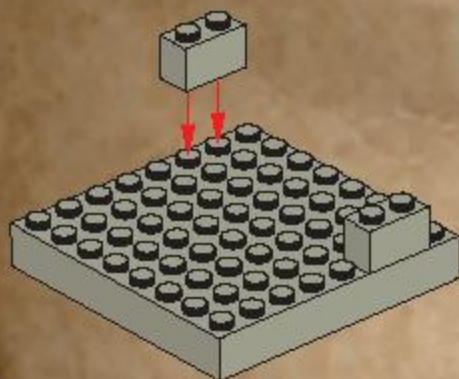

2

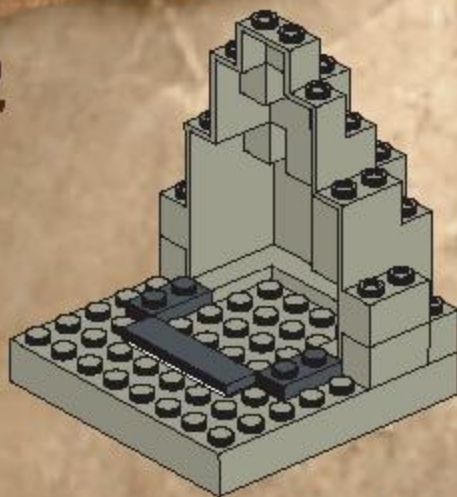

3

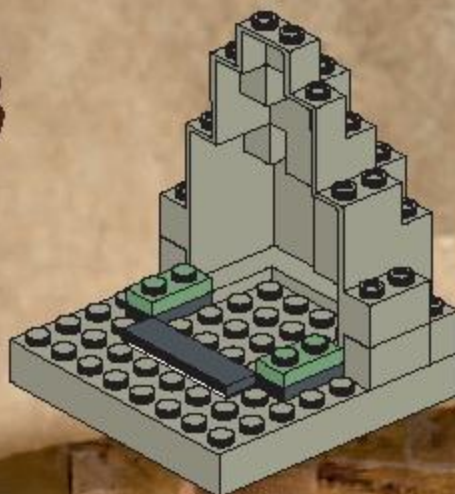

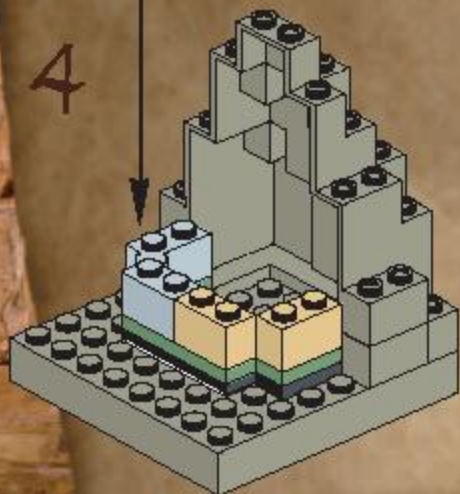
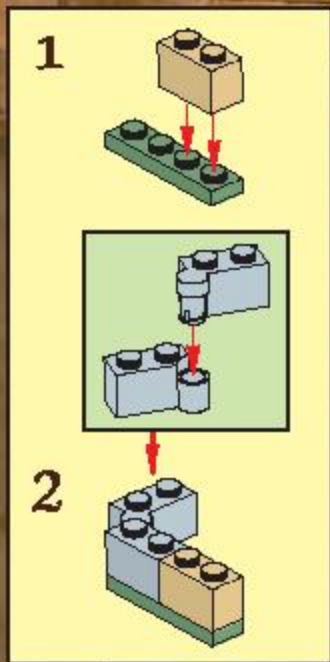

5

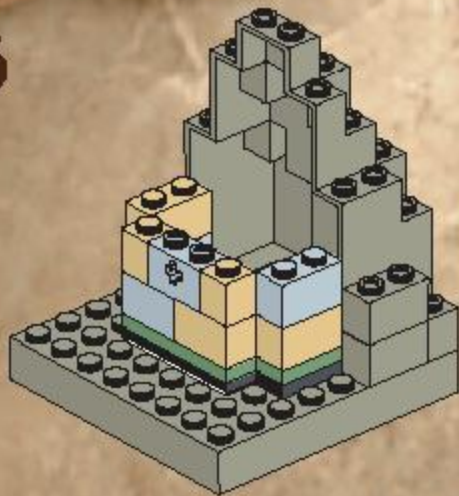

6

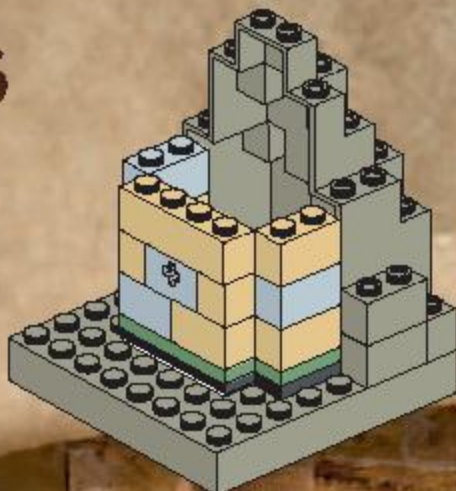

7

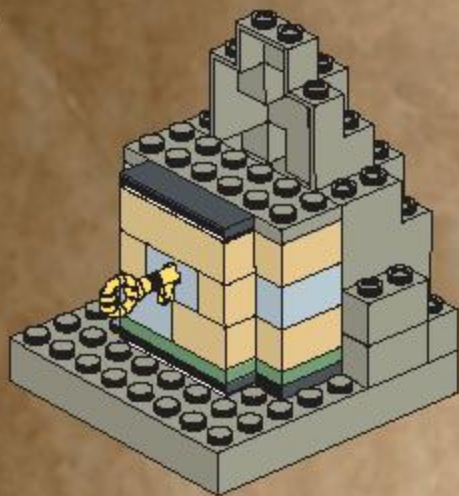

8

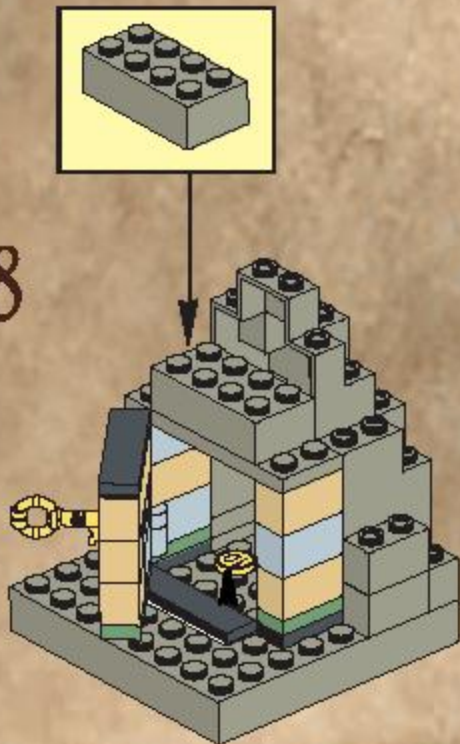

9



10



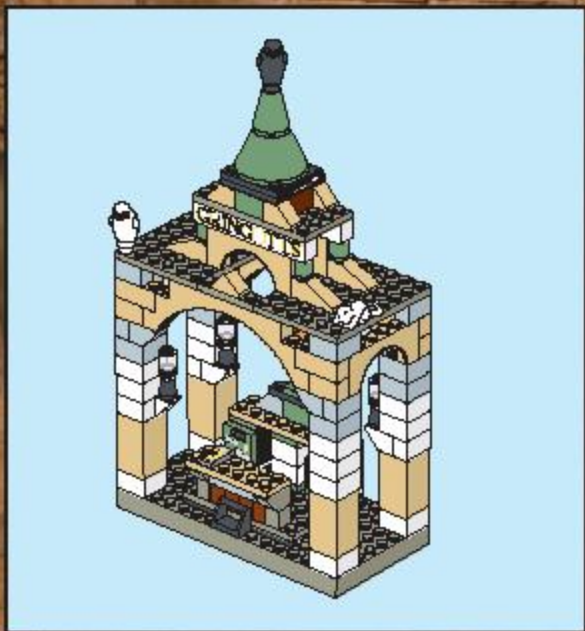

1

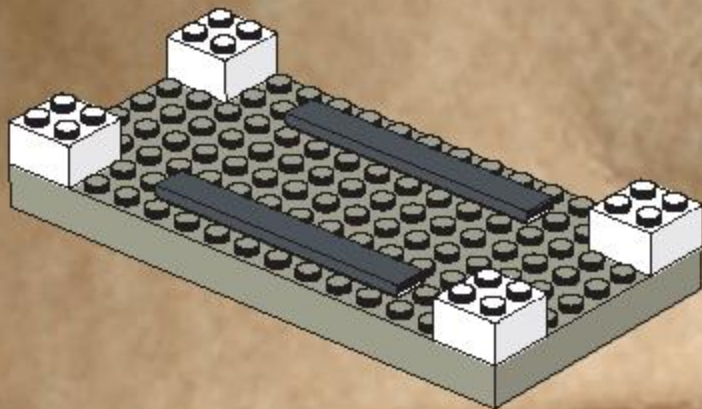

2

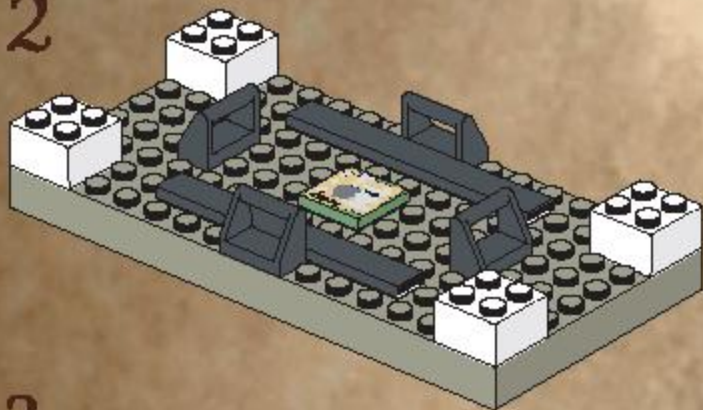

3

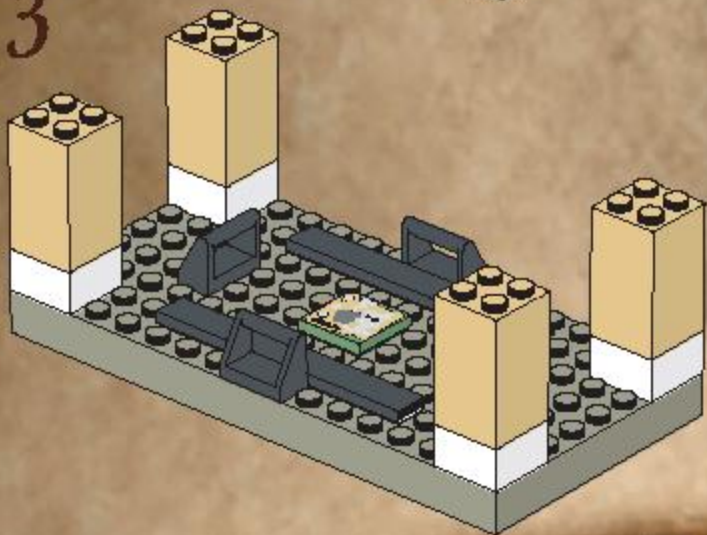

4

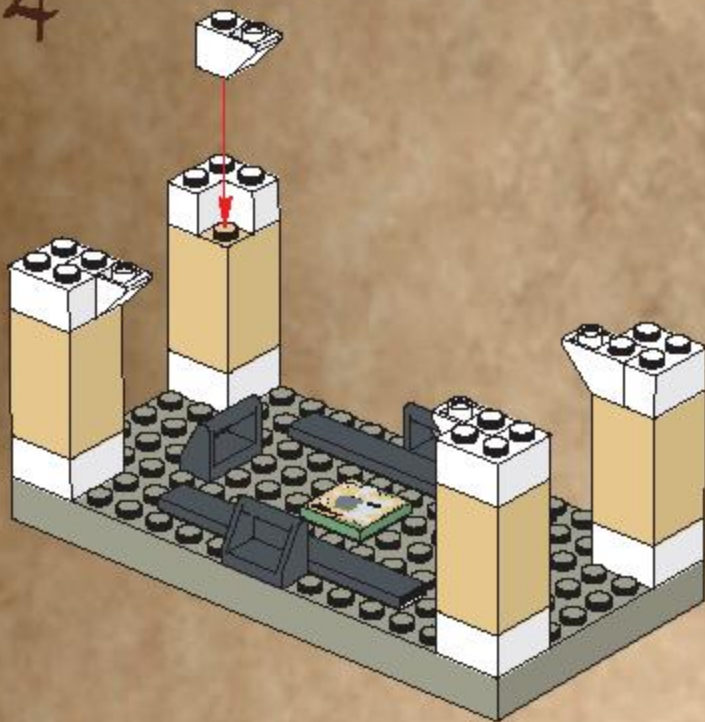

5

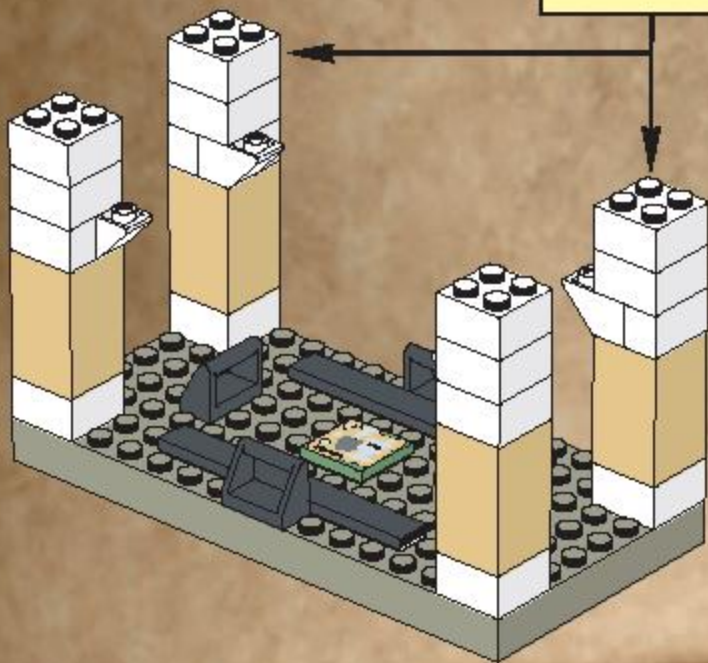
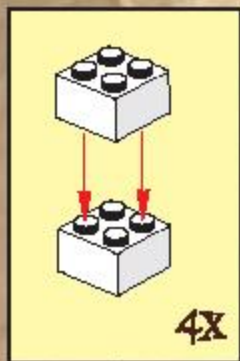

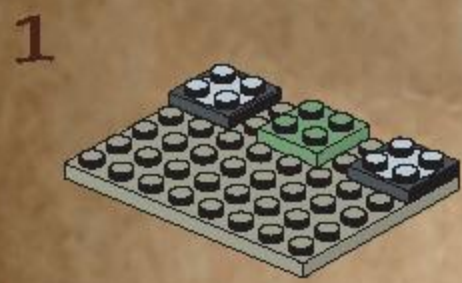
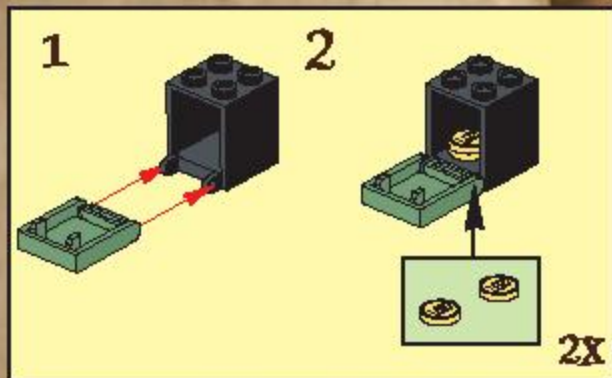

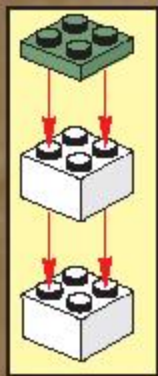

3

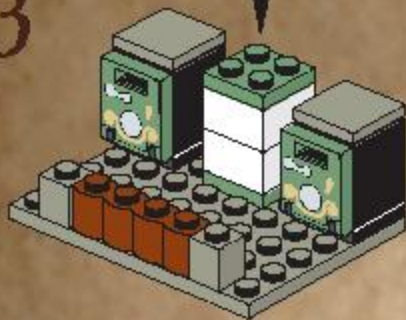

4

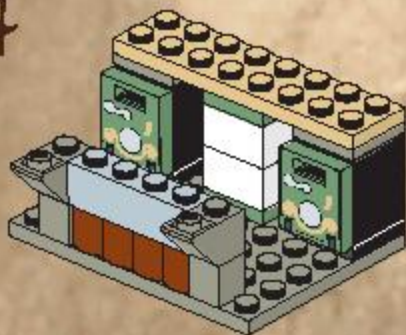

5

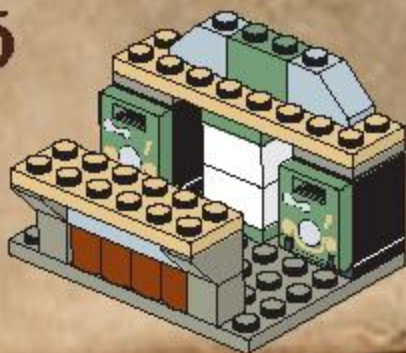

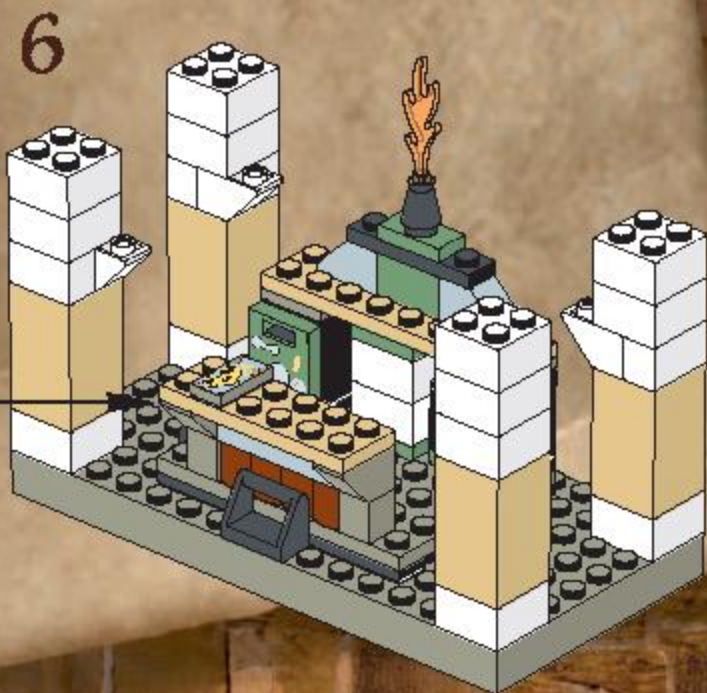
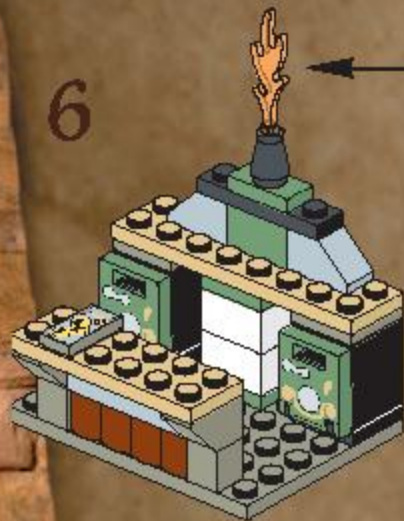

7

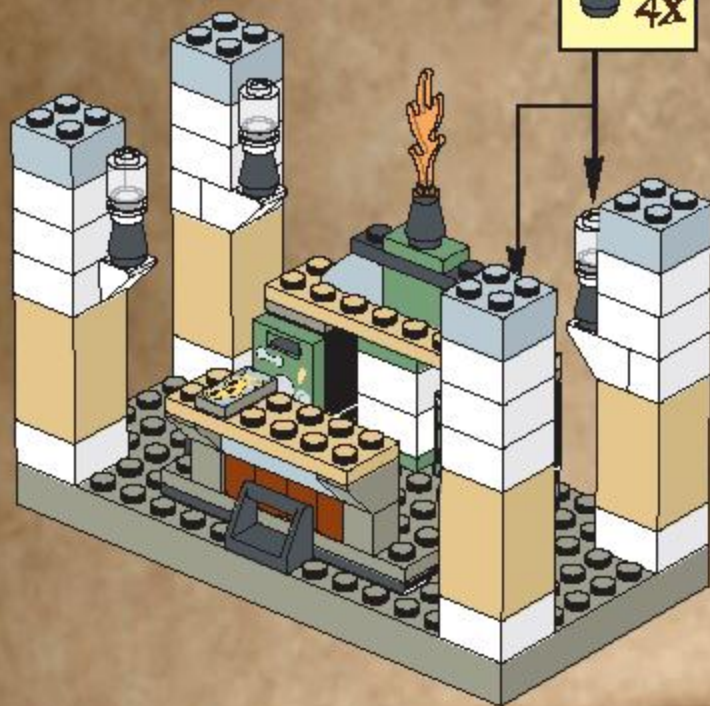

8

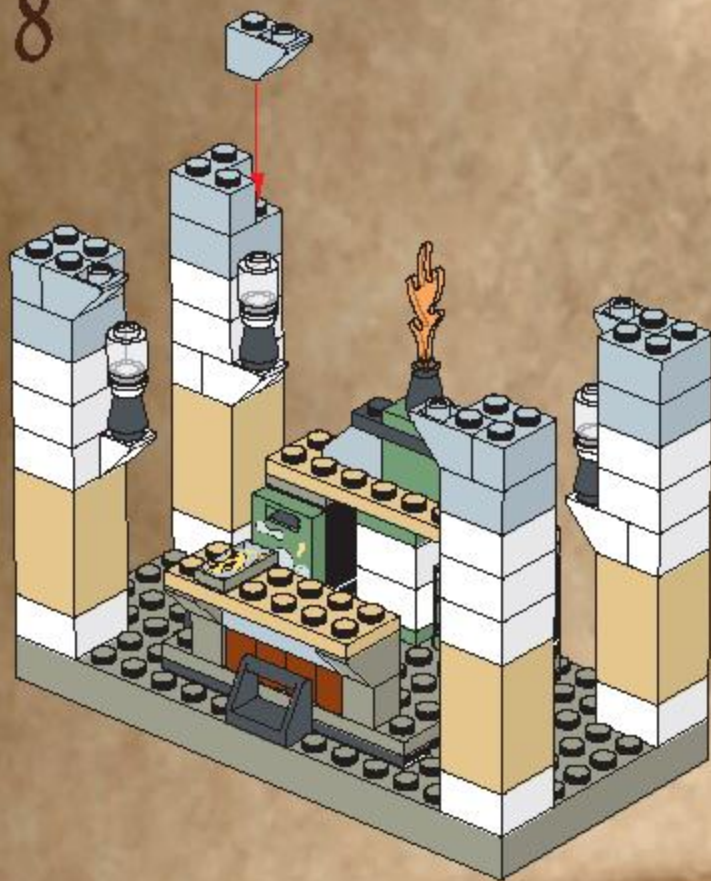

9

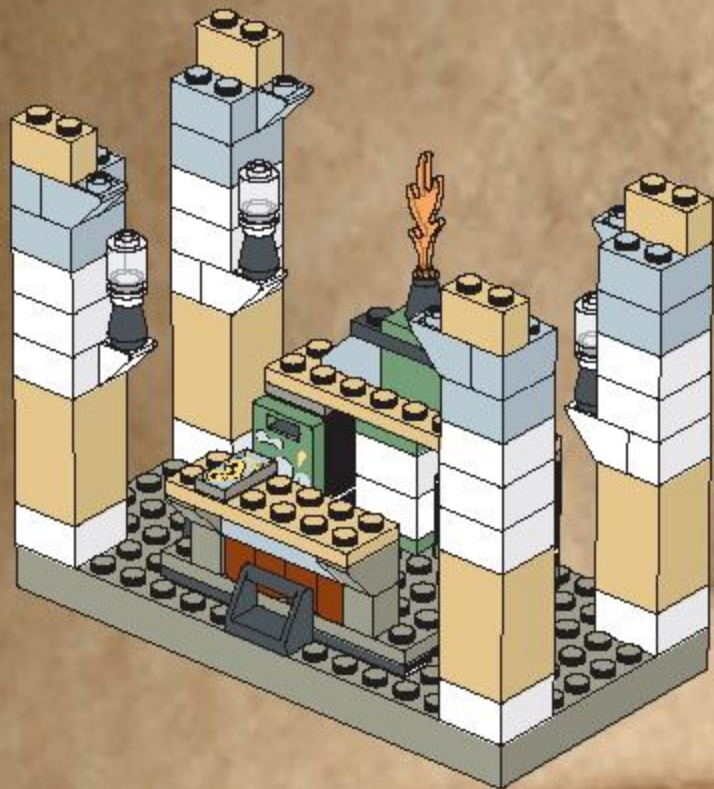

10

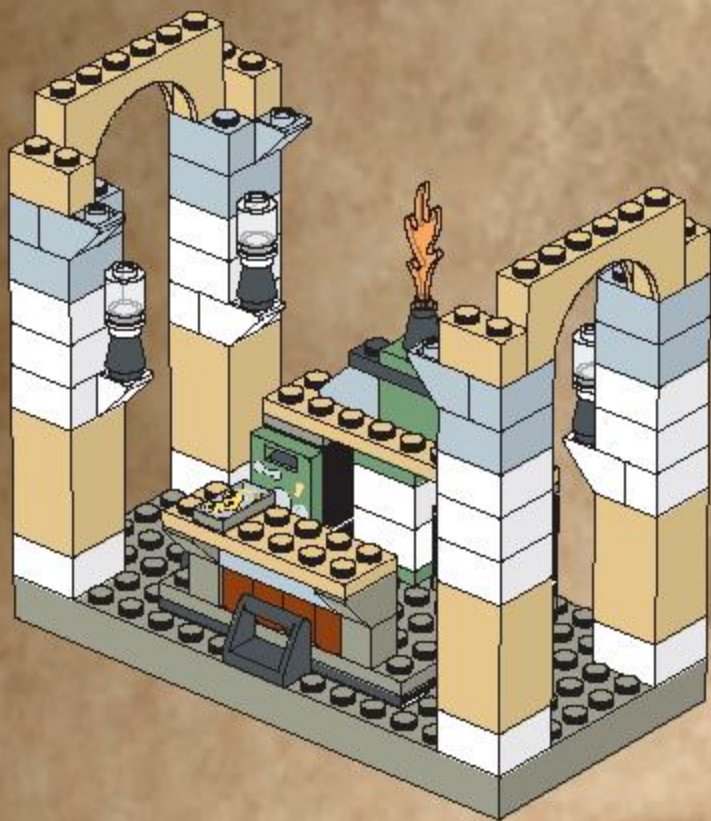

26

11

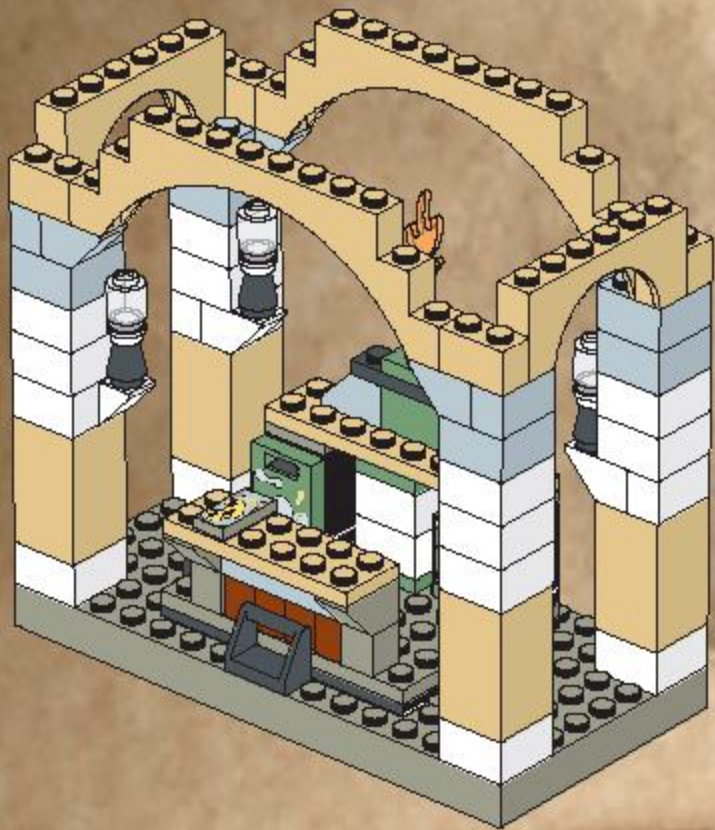

12

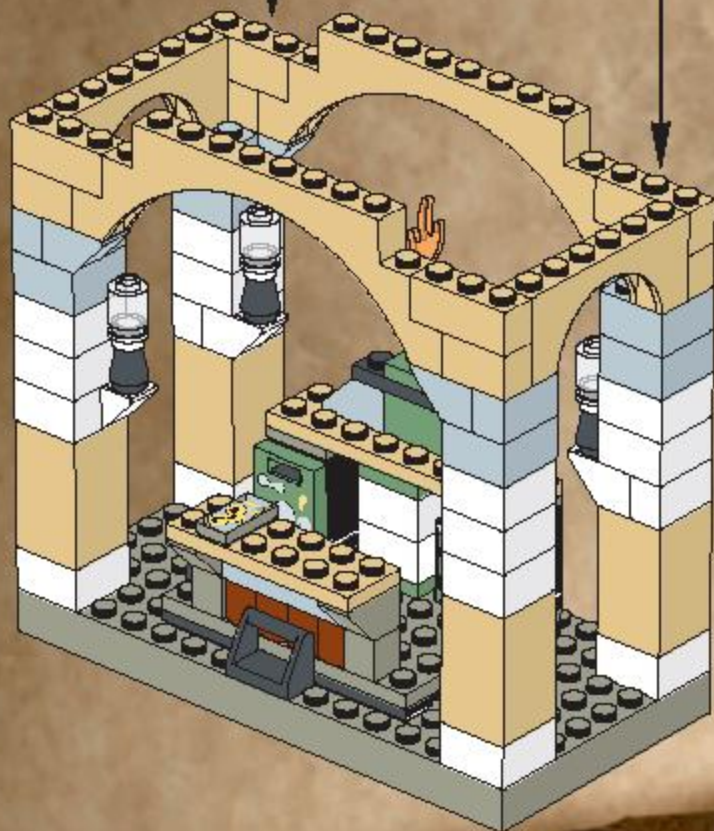
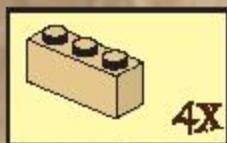

13

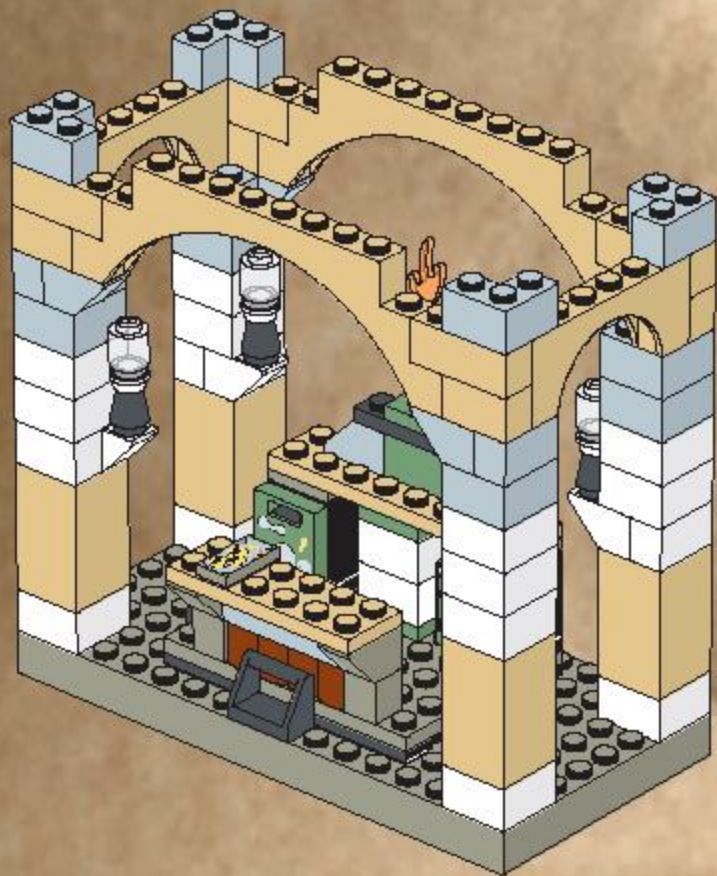

14



15



16

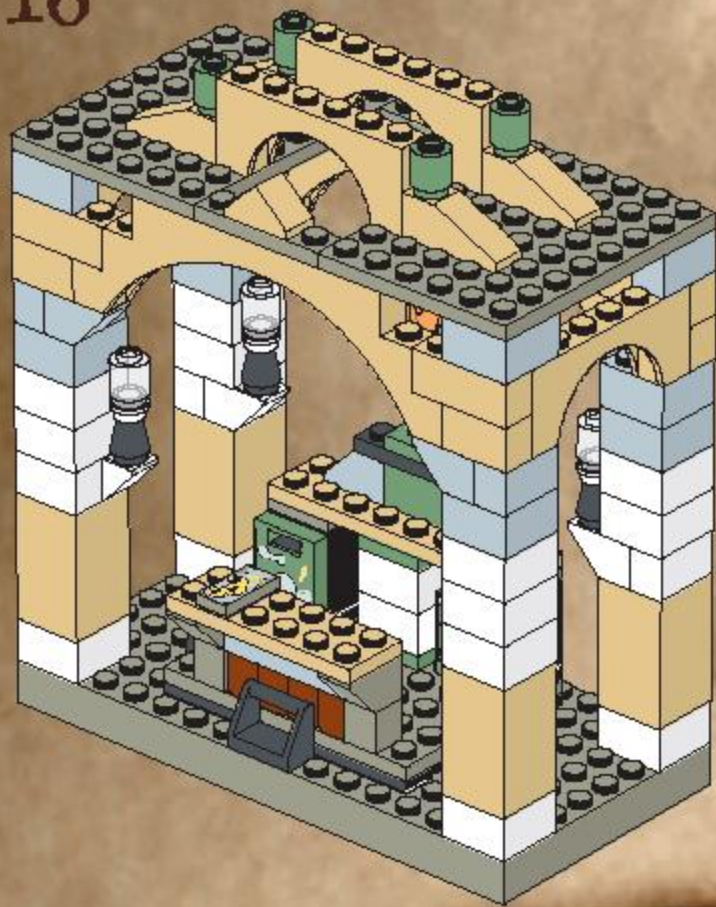

17



18



19

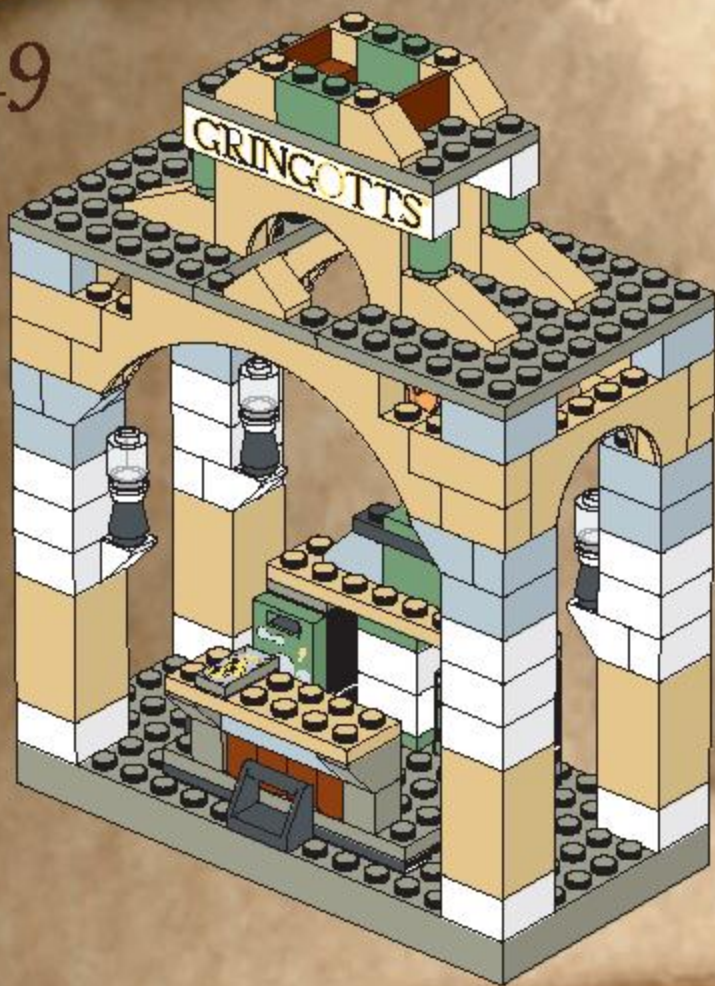

20

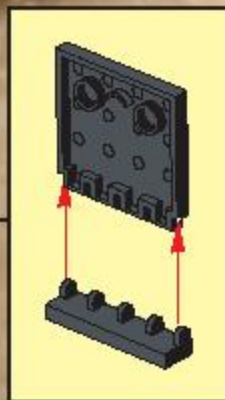

21

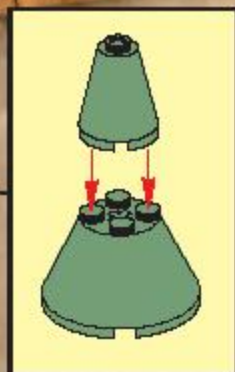
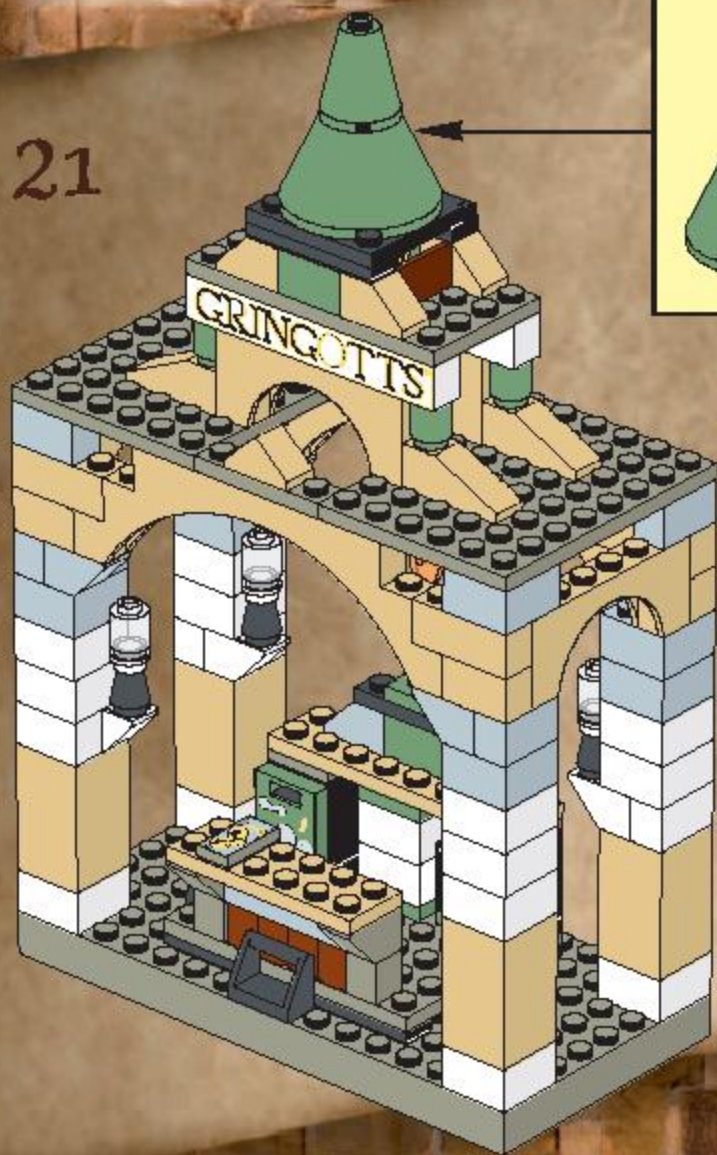

22

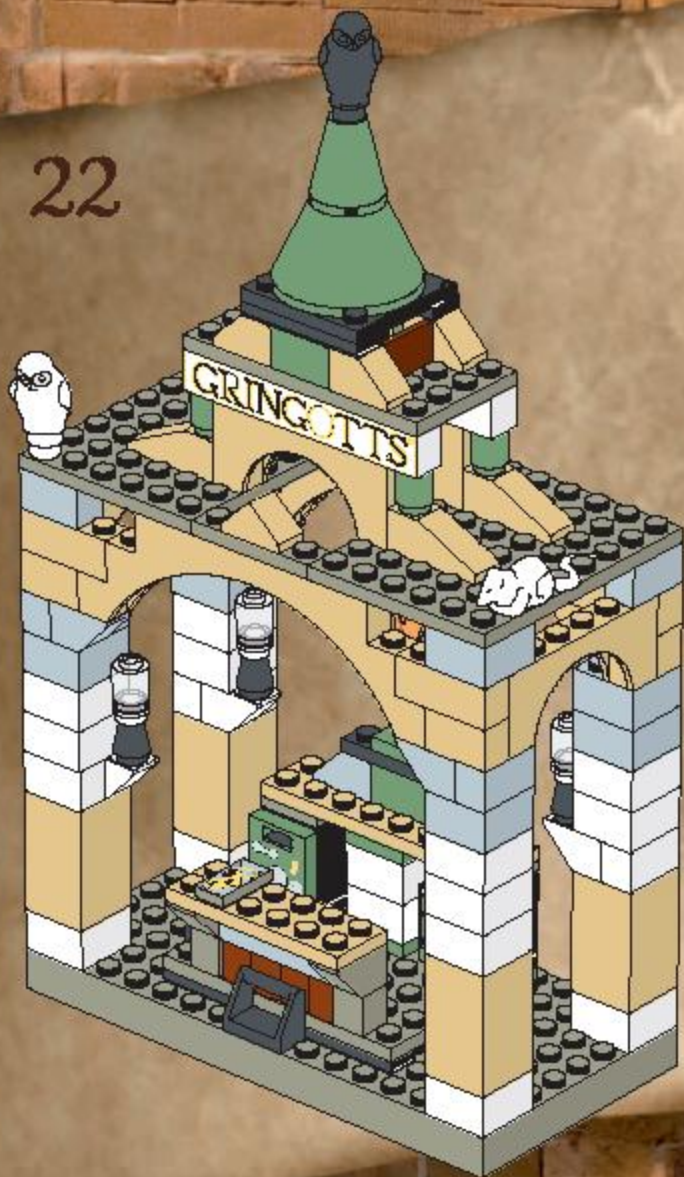

38







1

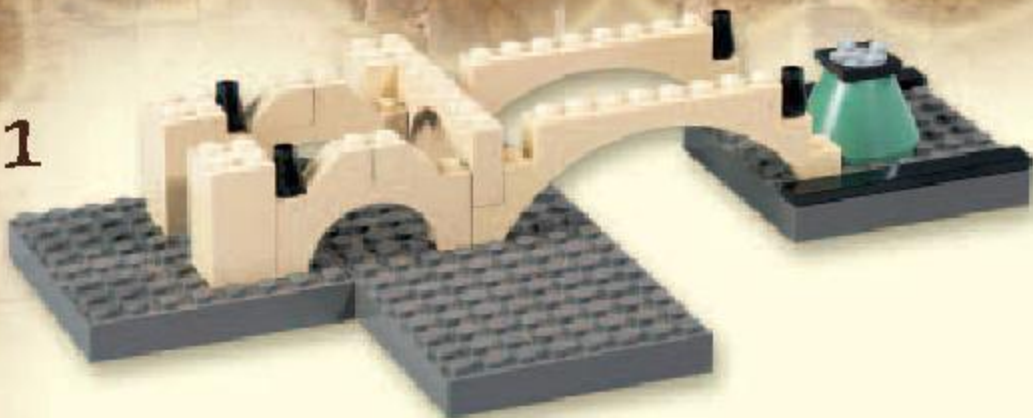

2

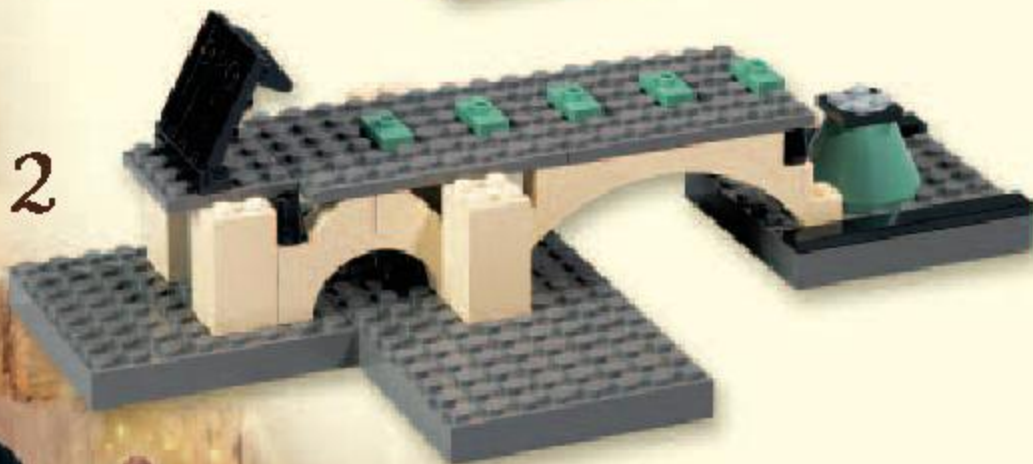



1



2



3



1



2



3



4



1

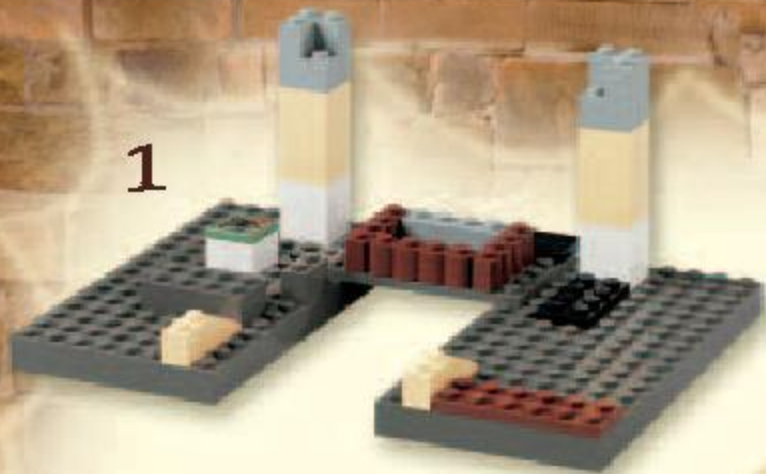

2

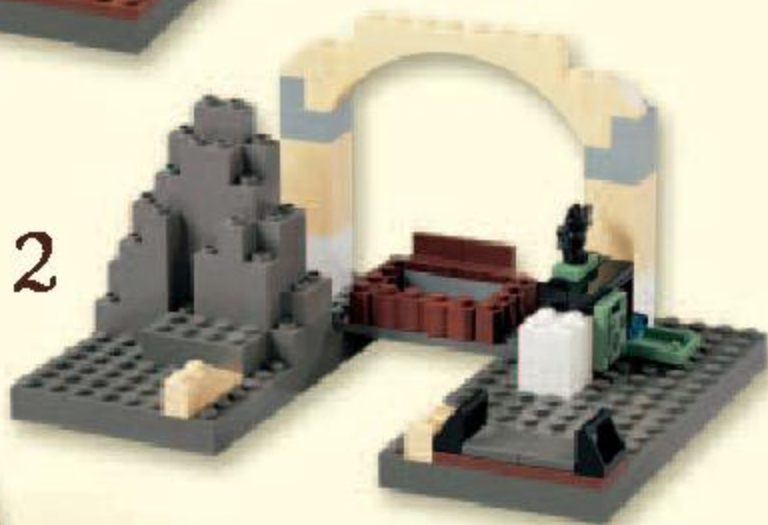

3

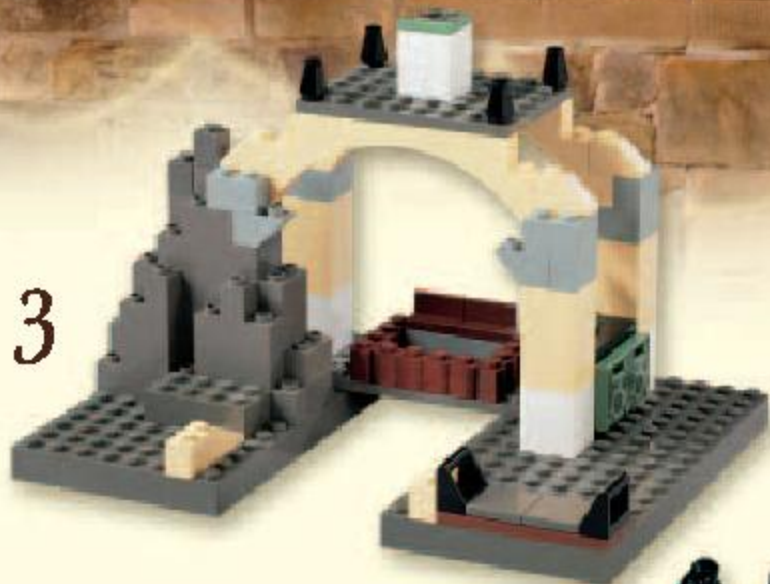

4

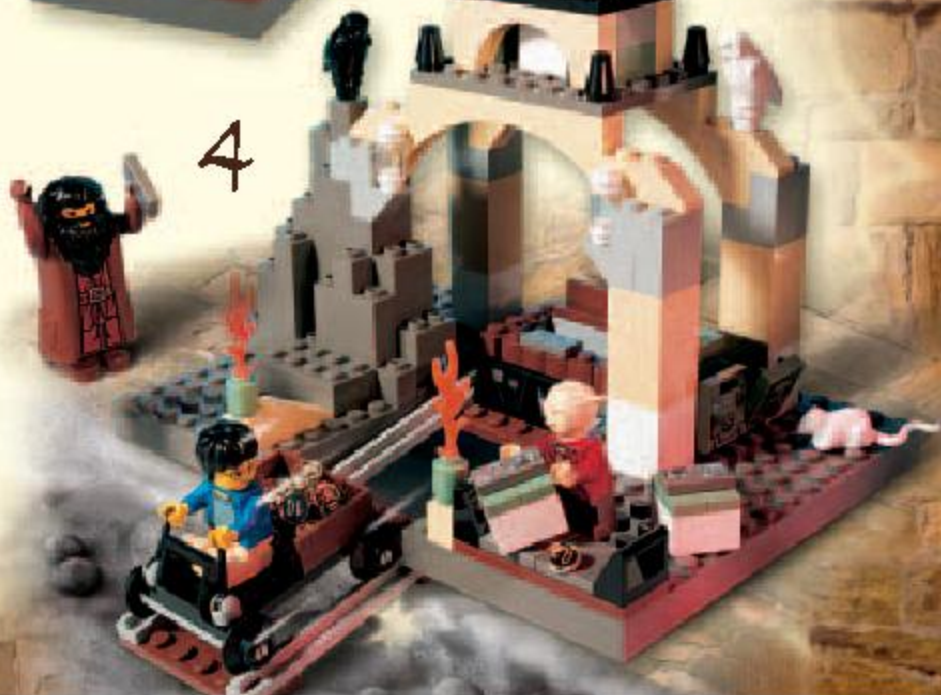



SOFTWARE



www.harrypotter.com



© 2002 WARNER BROS. ENTERTAINMENT INC. HARRY POTTER, CHARACTERS, NAMES AND RELATED MATTER ARE TRADEMARKS OF AND © WARNER BROS. ENTERTAINMENT INC.

LEGO, THE LEGO LOGO, AND THE LEGO BANNER ARE TRADEMARKS OF AND © 2002 LEGO SYSTEMS A/S.

LEGO SYSTEMS A/S, BRUNNENSTRASSE 1, 76646 BRUNNEN, GERMANY

© 2002 THE LEGO GROUP

4770428