



3368

CITY



1

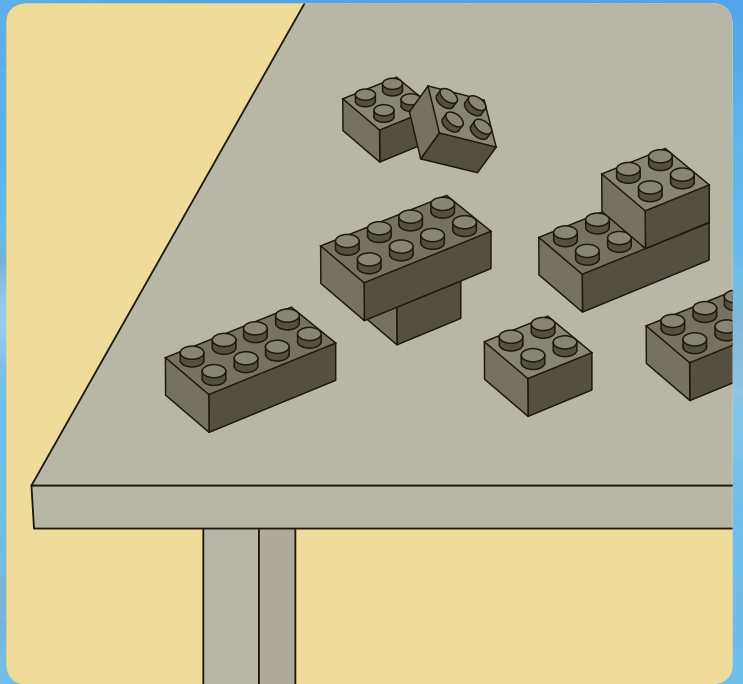
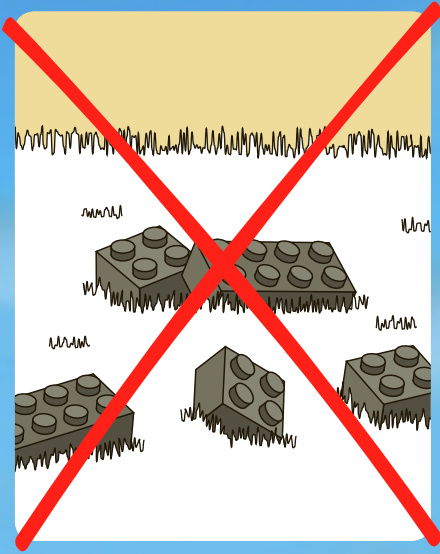

2

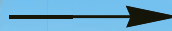

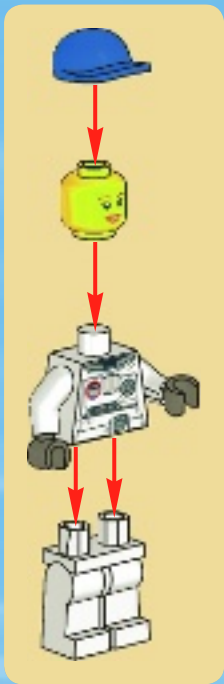
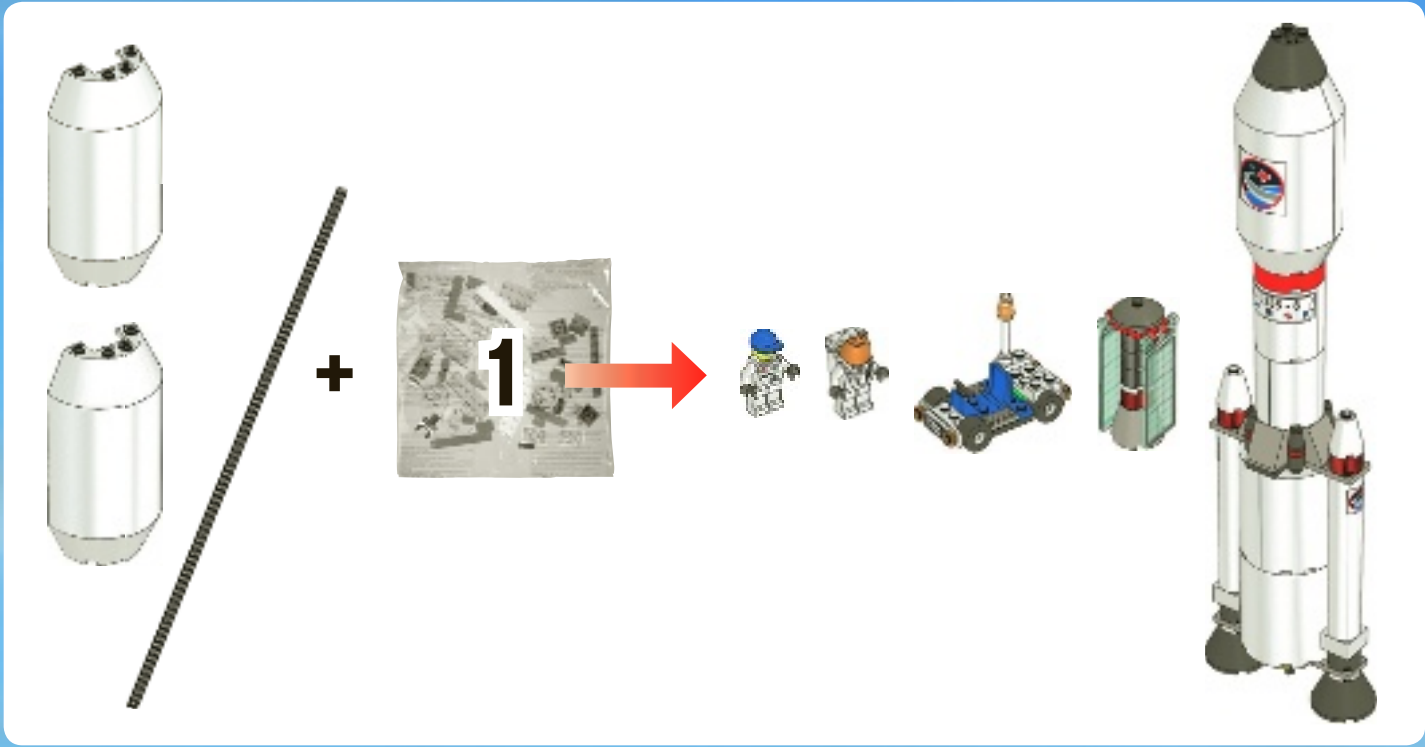



1

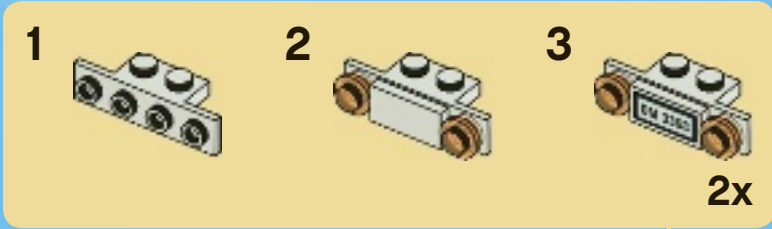
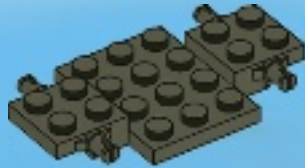

2

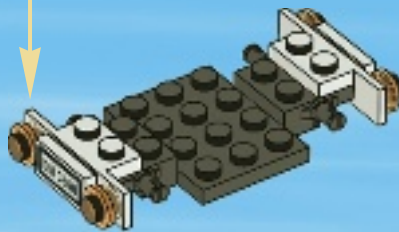

3

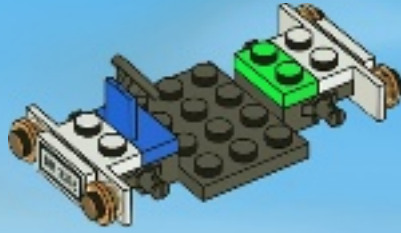

4

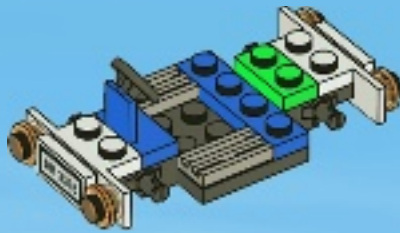

5

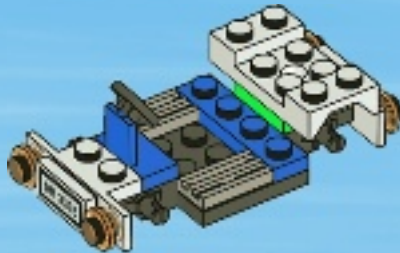

6

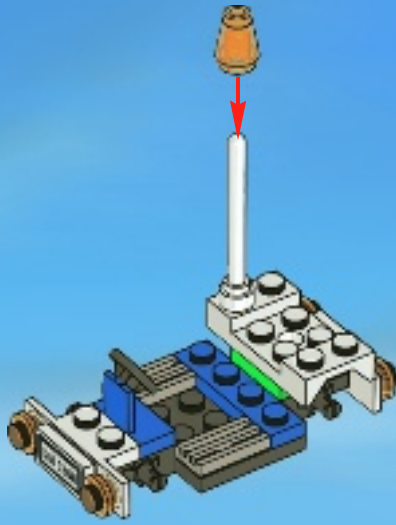

7

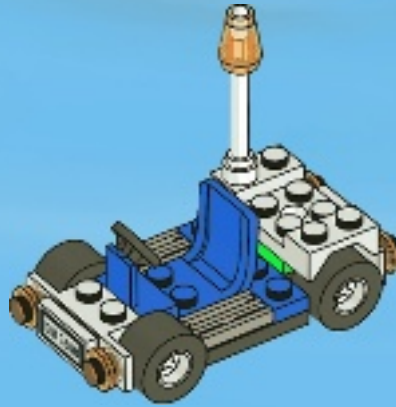

8

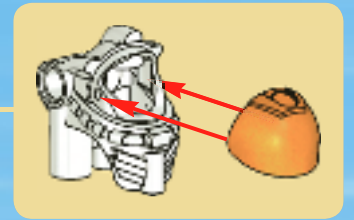



1

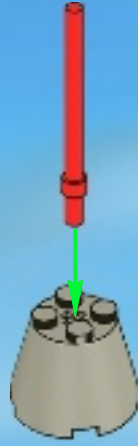

2



3



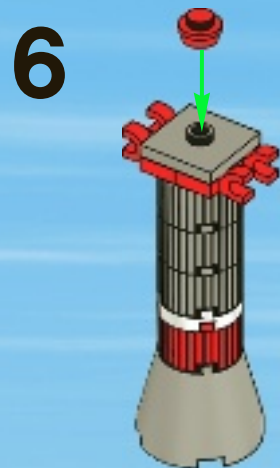
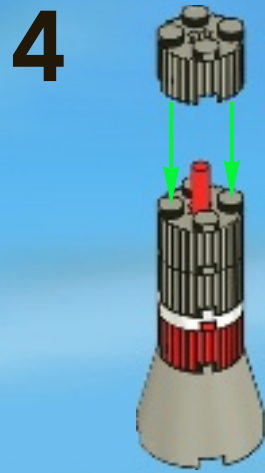

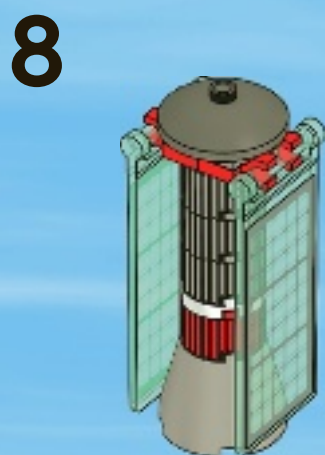
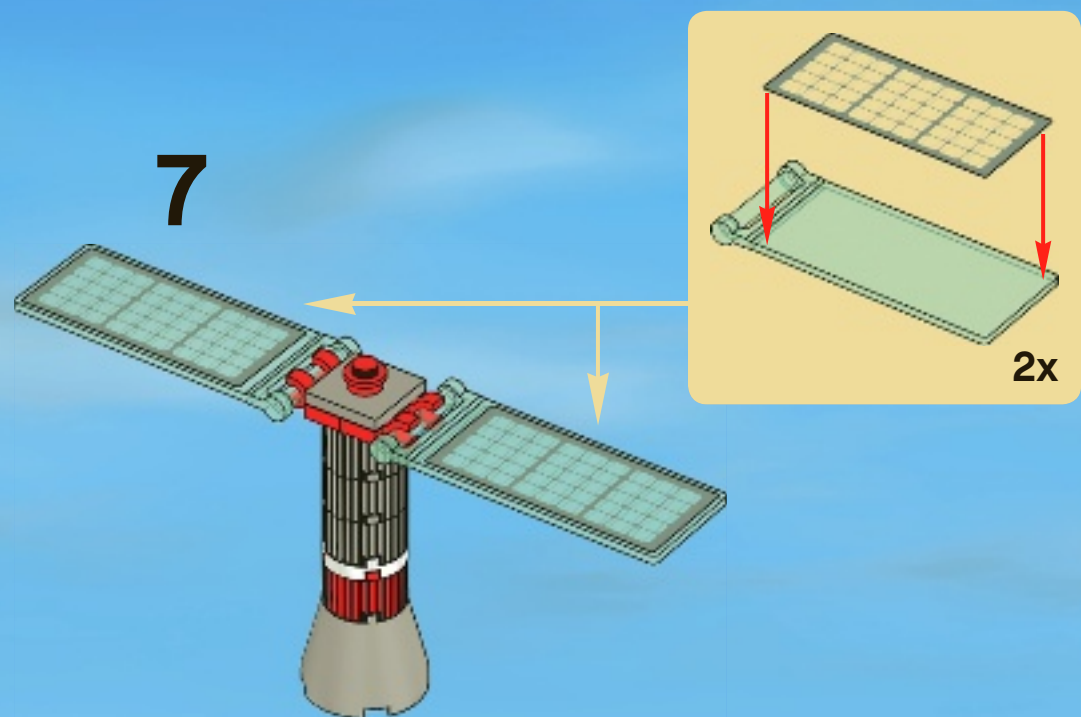



1



2



3



4

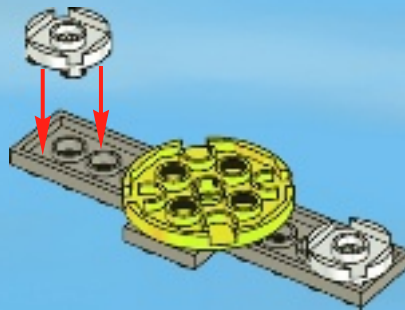

5

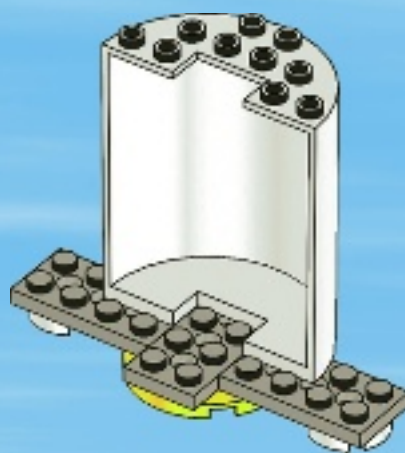

6



7



8

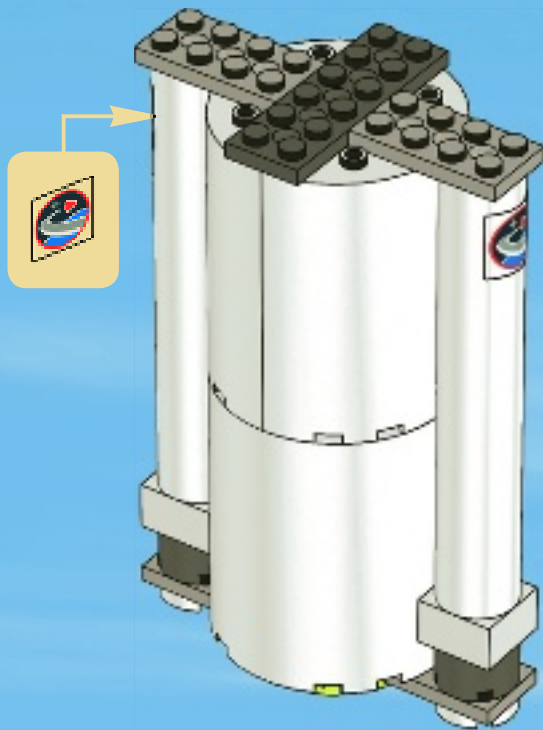

9

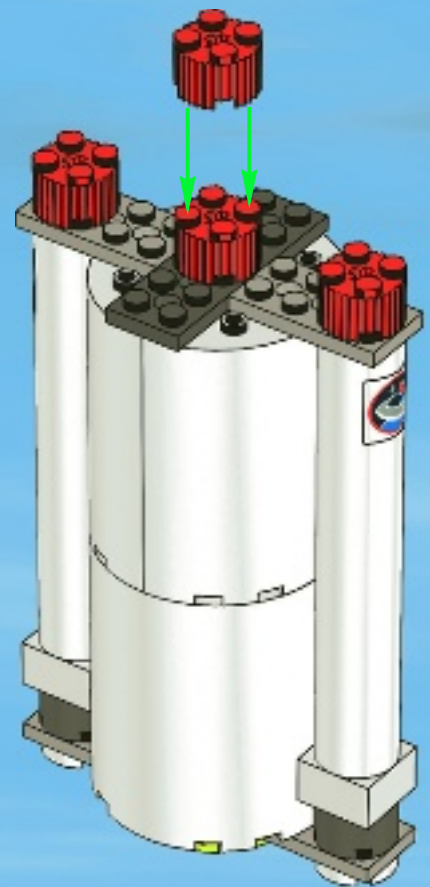

10

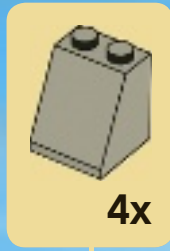

11

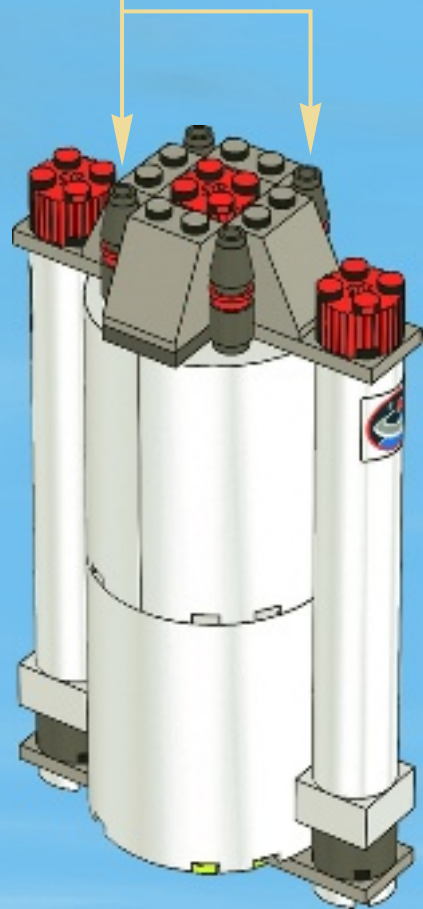

12

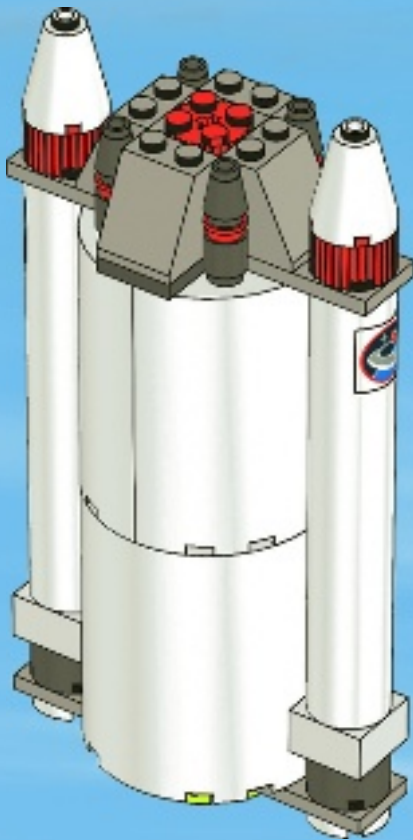

13



14



15



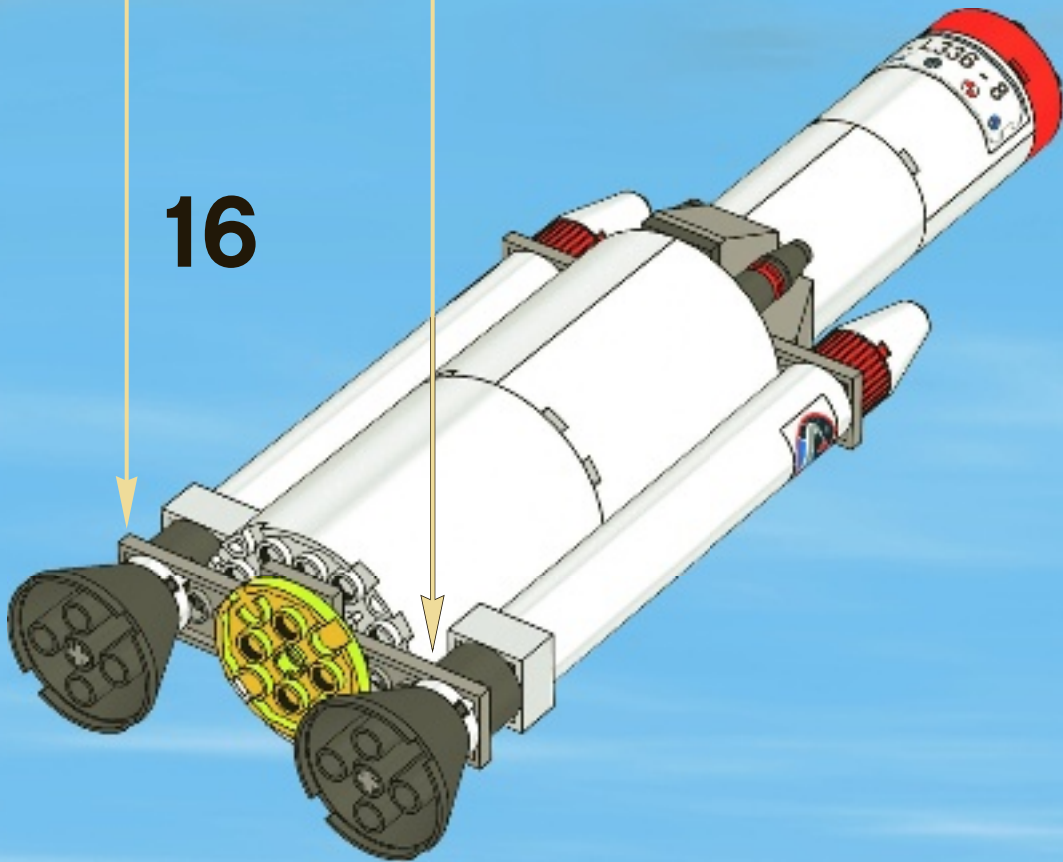
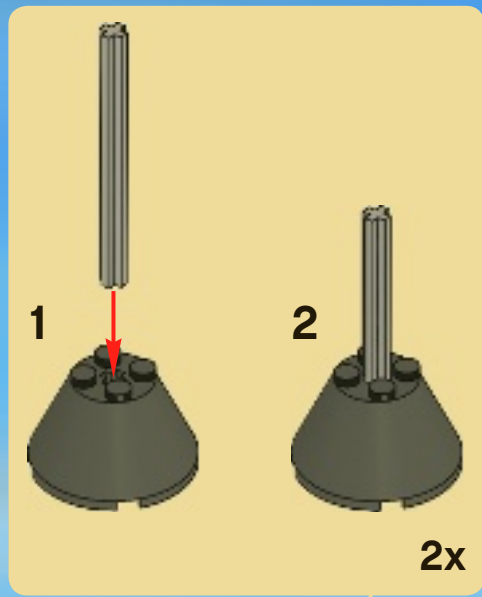

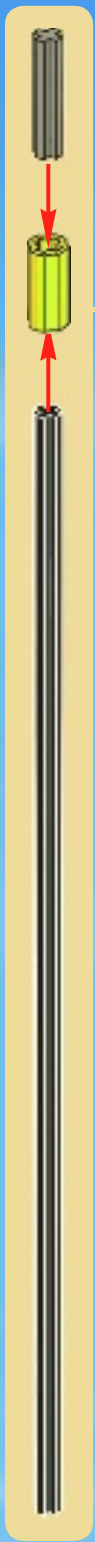

17

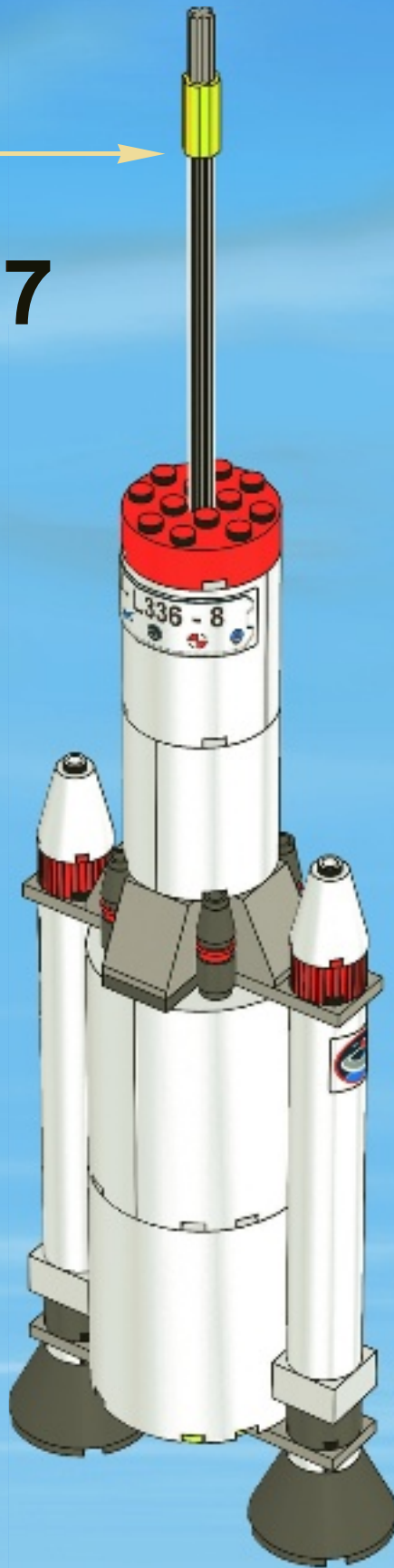

18



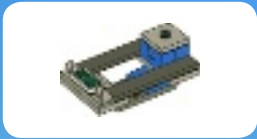

1

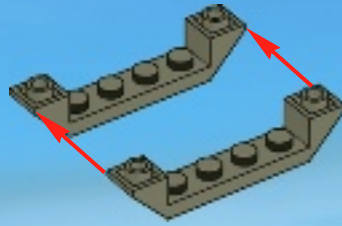

2

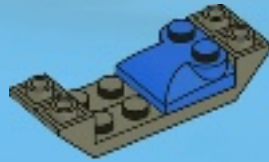

3



4

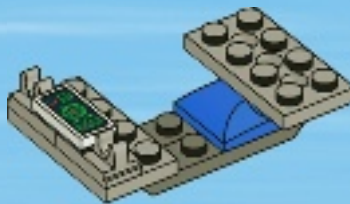

1

2

3

4

A vertical yellow box containing four numbered steps (1-4) showing the assembly of a grey Technic beam with various components. Step 1 shows a plain grey 1x6 Technic beam. Step 2 shows a grey 1x6 Technic beam with a 1x2 Technic beam attached to its right end. Step 3 shows a grey 1x6 Technic beam with a white sensor attached to its top. Step 4 shows a grey 1x6 Technic beam with a green sensor attached to its bottom. A yellow arrow points from the bottom of this box to the final assembly step (4) on the right.

5

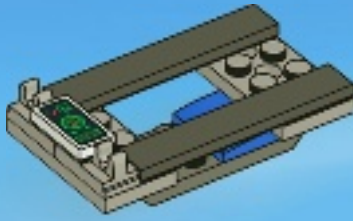

6

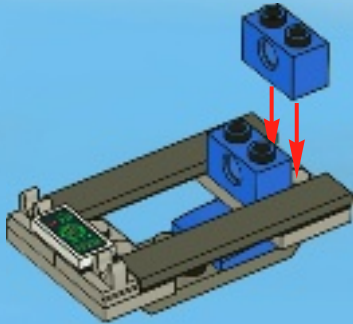

7

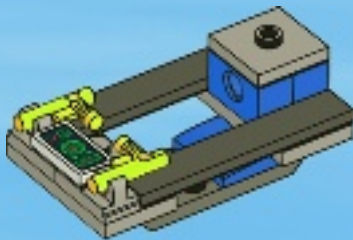

8

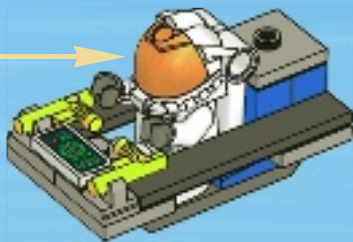
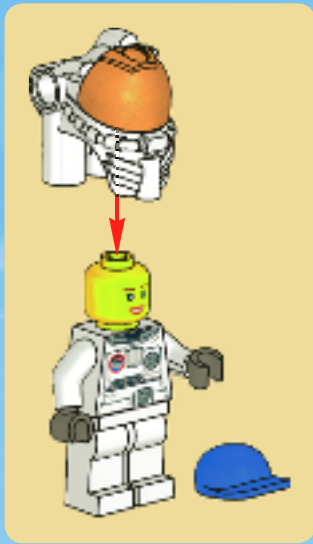

19

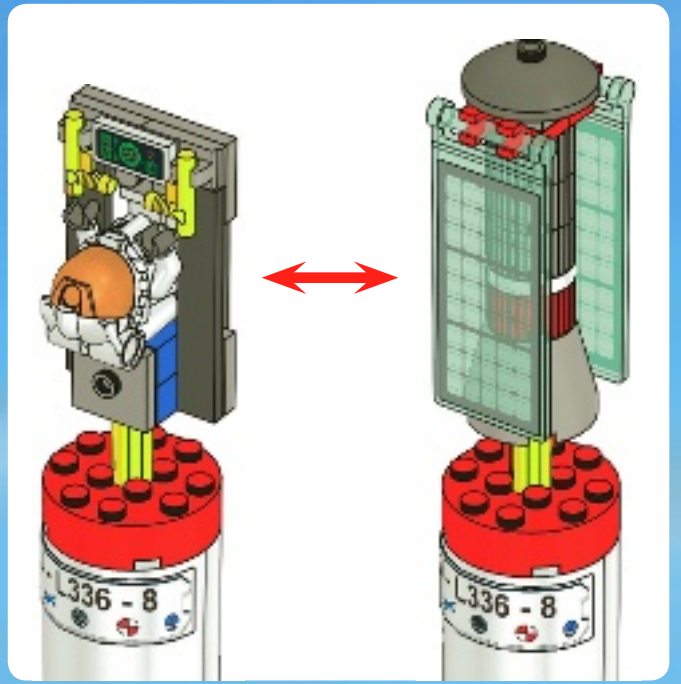
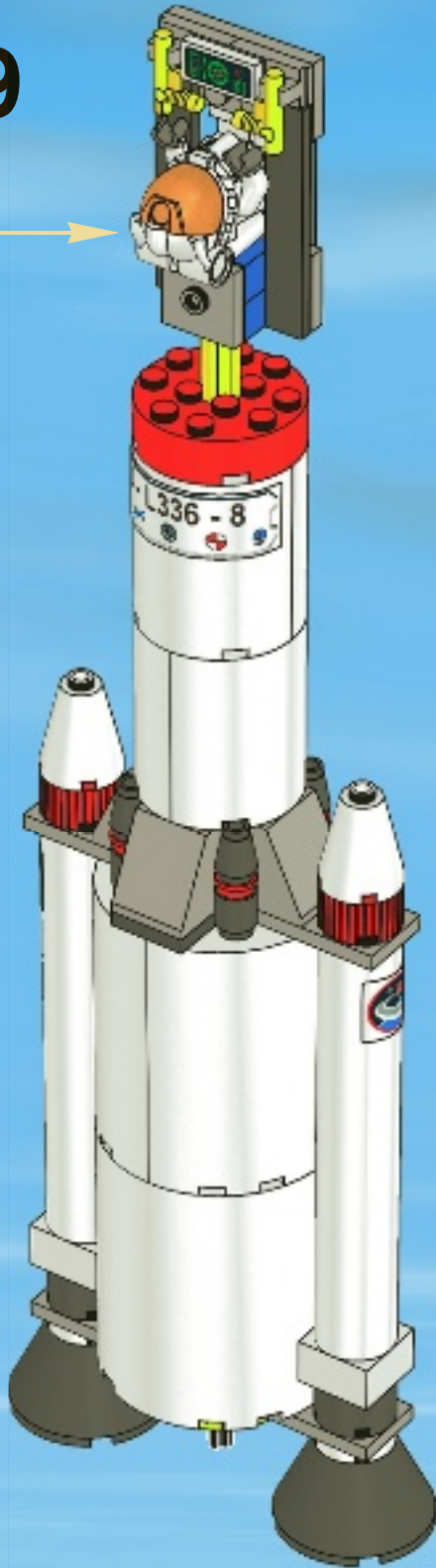

20



21





WIN!

Go to www.LEGOsurvey.com/product to fill out a survey for a chance to win a cool LEGO® Product.

No purchase necessary.

Open to all residents where not prohibited.



www.LEGOsurvey.com/product

GEWINNE!

Nimm an der Umfrage auf www.LEGOsurvey.com/product teil und hab die Chance ein cooles LEGO® Produkt zu gewinnen!

Die Teilnahme am Gewinnspiel führt zu keinerlei Kaufverpflichtungen. Teilnahme in allen nicht ausgeschlossenen Ländern möglich.

WIN!

Ga naar www.LEGOsurvey.com/product, vul een enquêteformulier in en maak kans op een cool LEGO® product.

Geen aankoopverplichting, iedereen mag deelnemen, uitgezonderd ingezetenden van landen waar een enquêteverbod geldt.

GAGNE !

Visite www.LEGOsurvey.com/product pour répondre à un questionnaire et avoir une chance de gagner un produit LEGO® très cool !

Aucune obligation d'achat. Ouvert à tous les résidents des pays autorisés.

当てよう!

www.LEGOsurvey.com/product にアクセスして、アンケートにご記入ください。当選者にはレゴ®製品を差し上げます。

お買い上げの必要はありません。禁止されていない限り、すべての皆様にご利用いただけます。



CITY

3368





+



2

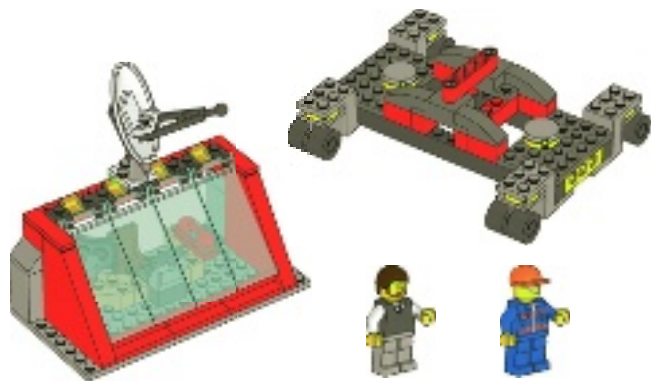



1

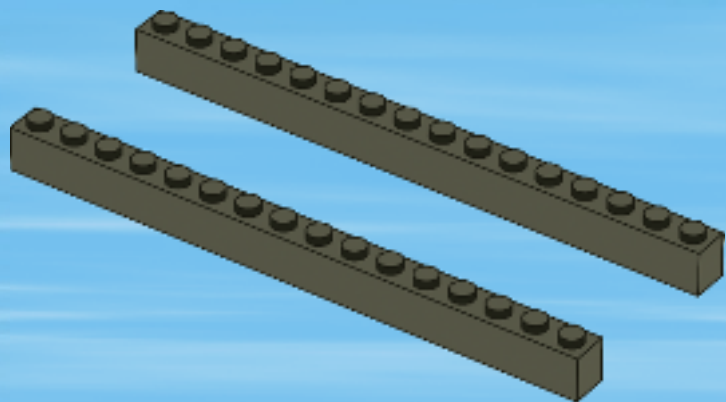

2

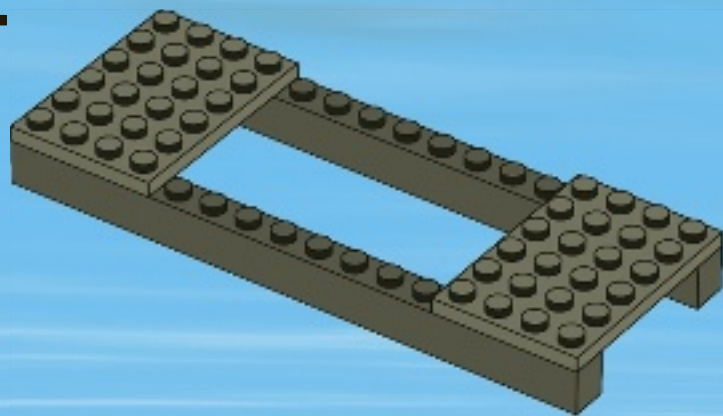

3

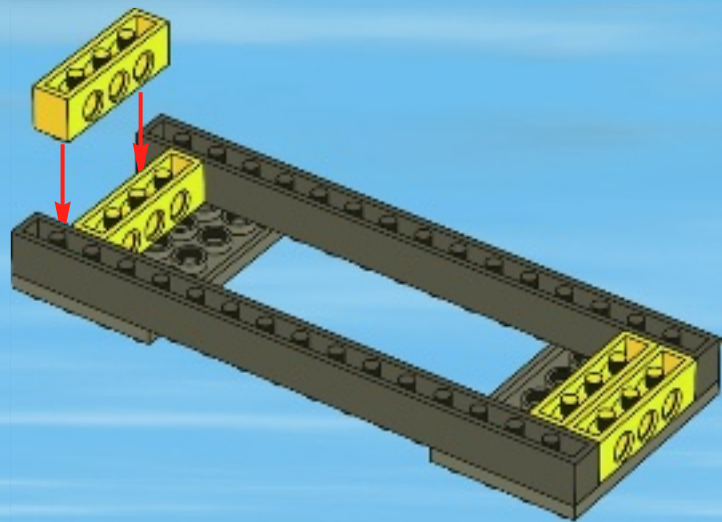

4

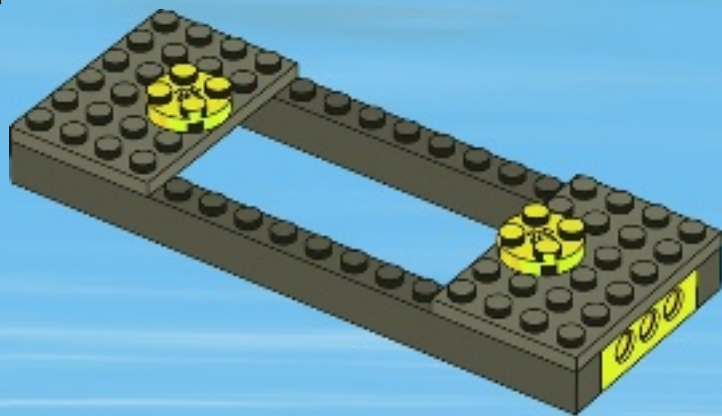

5

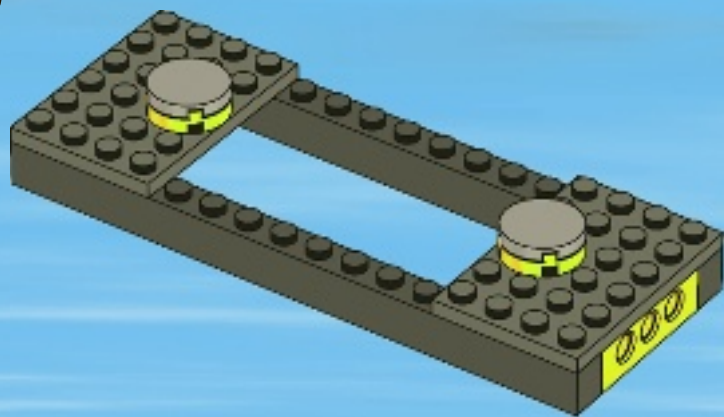

6

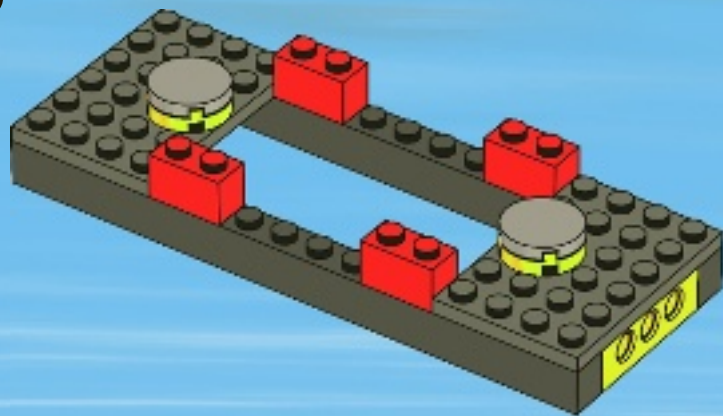

7

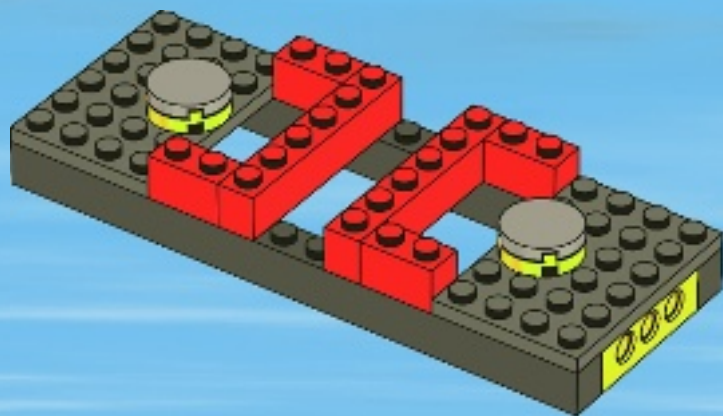

9

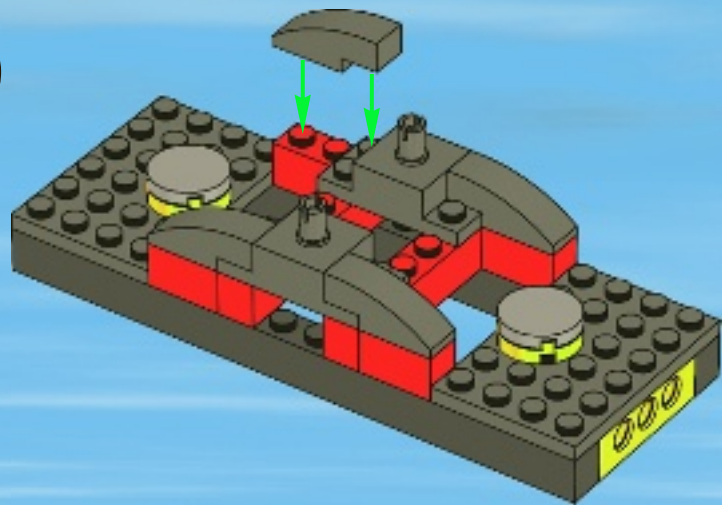

10

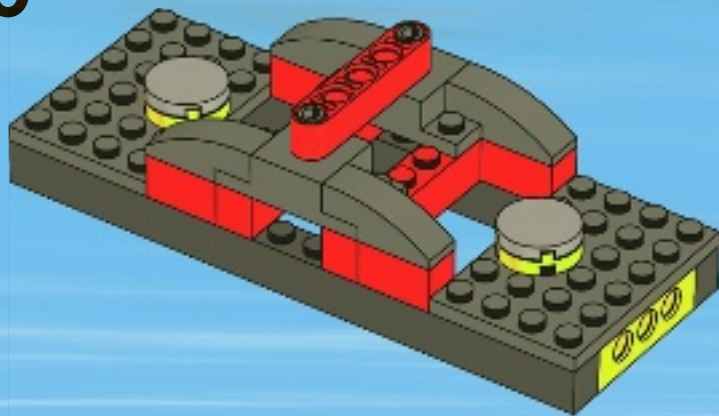

1



2



3

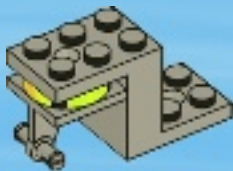

4

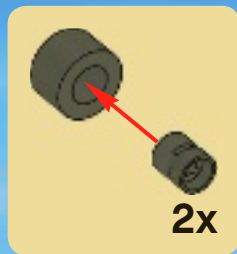

4x

11

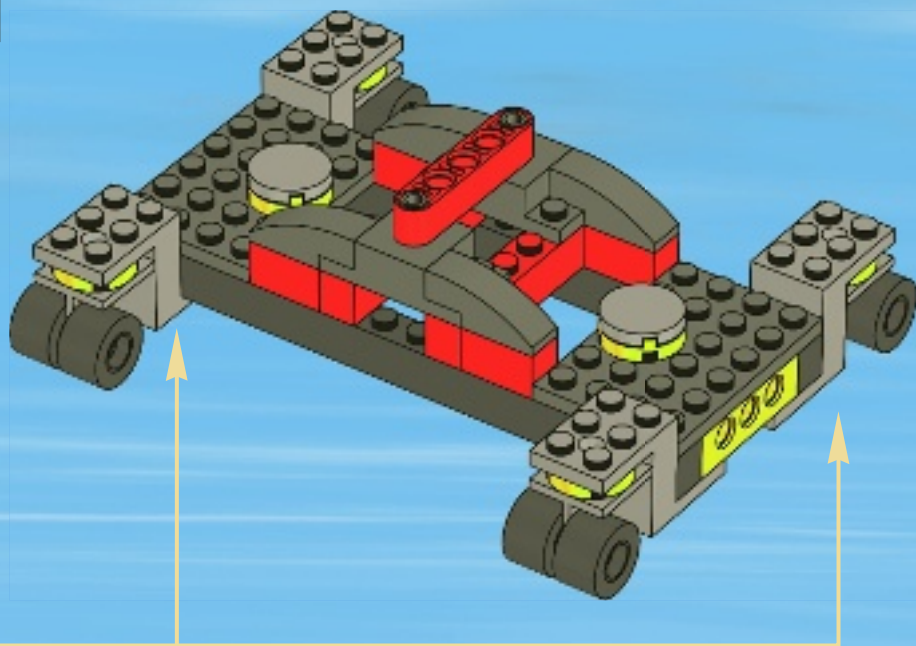

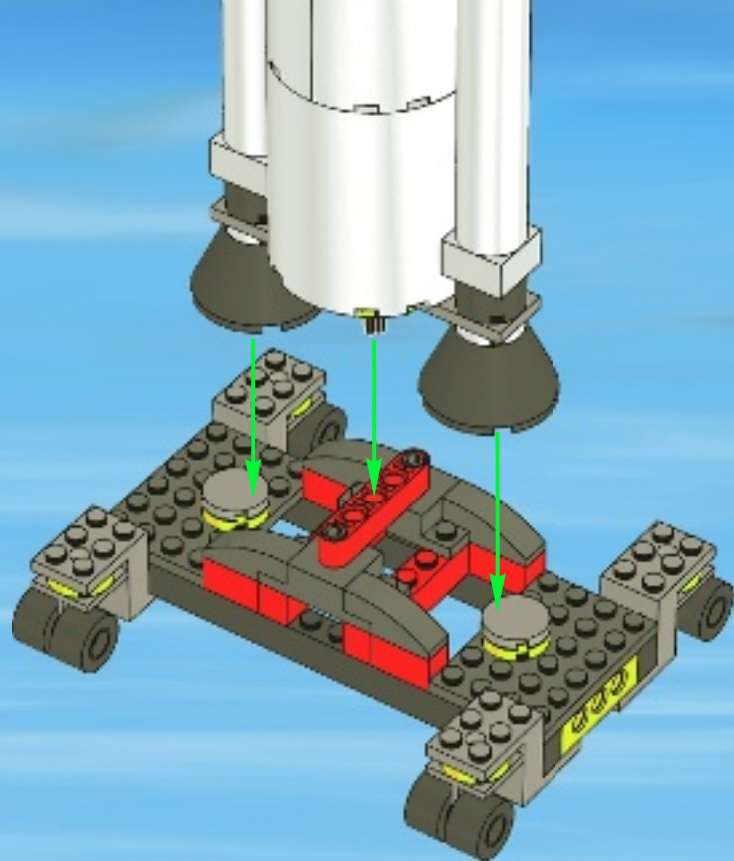



1

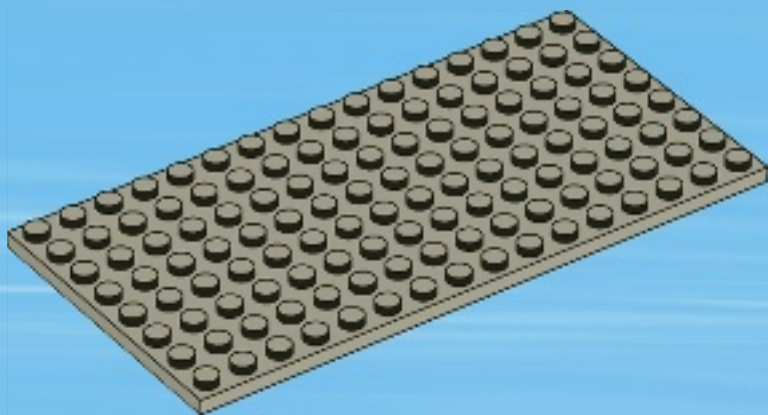

2

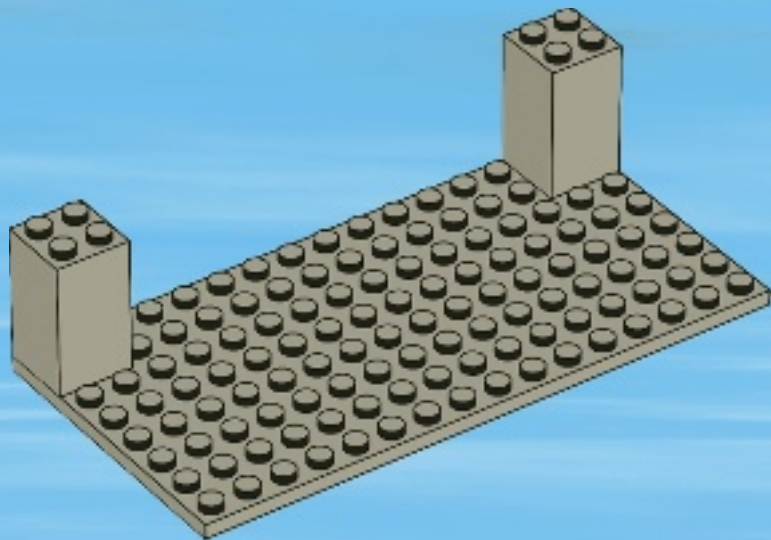

3

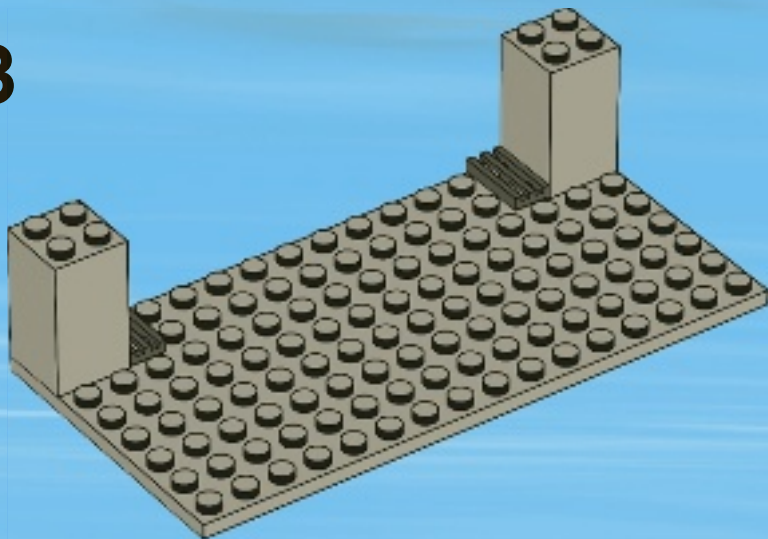

4

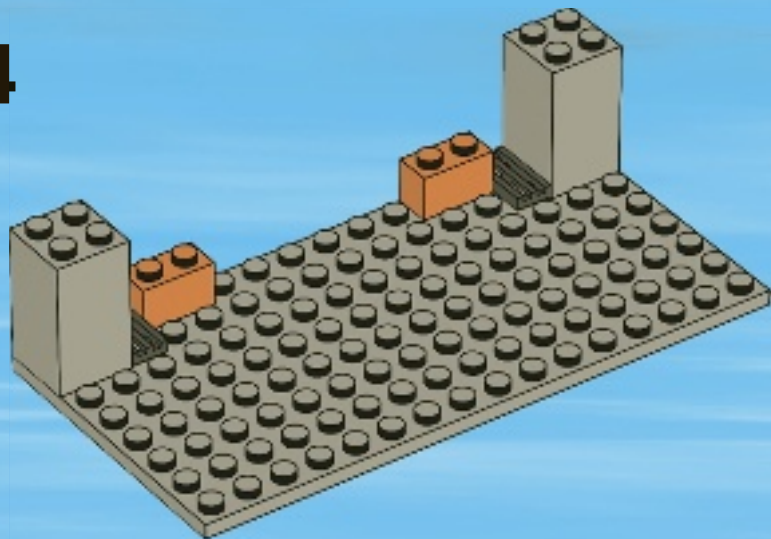

5

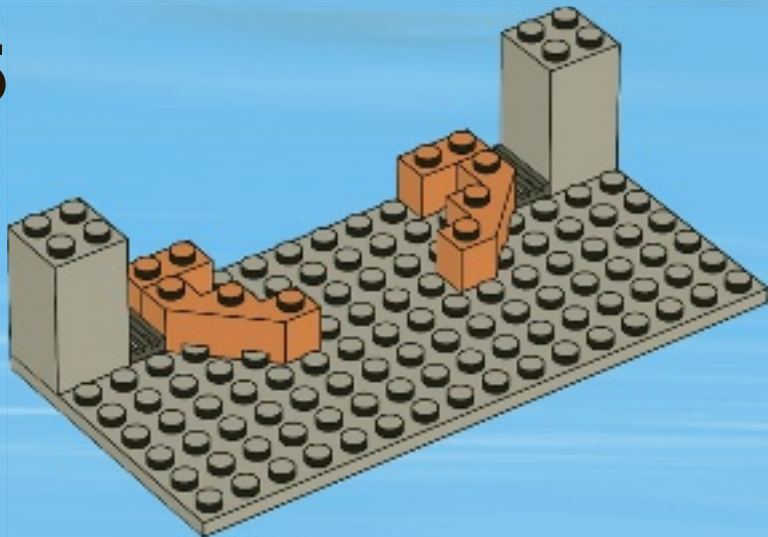

6

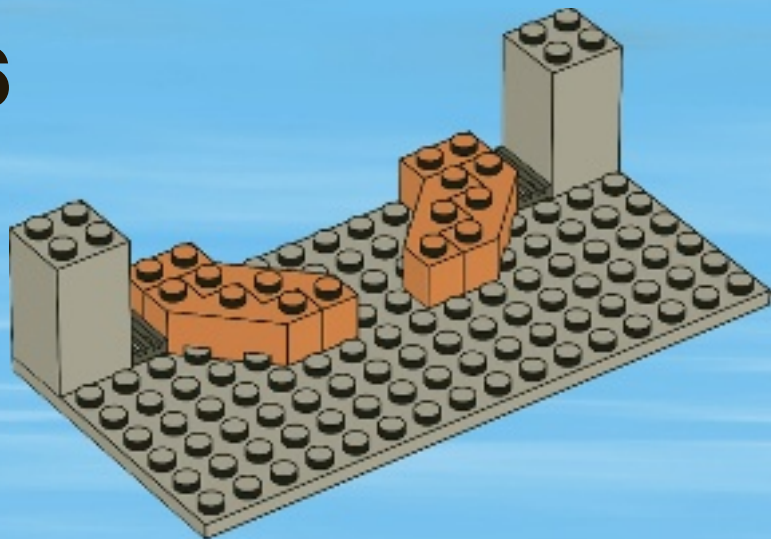

1



2



3



7

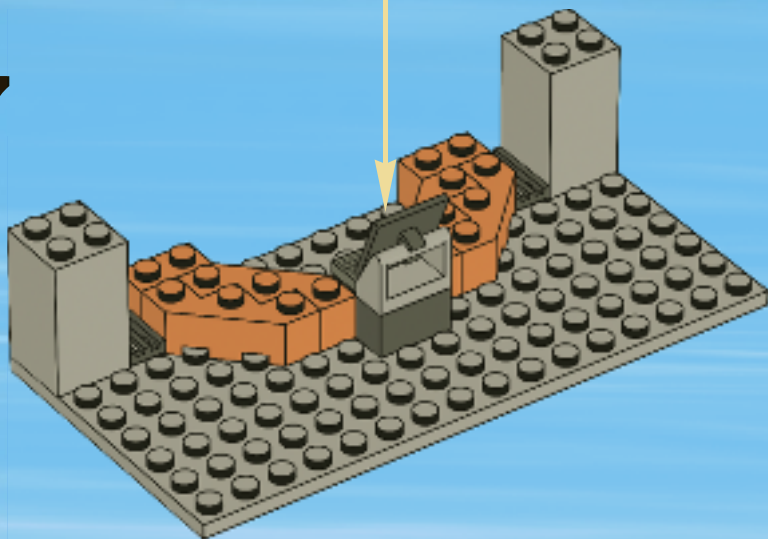

8

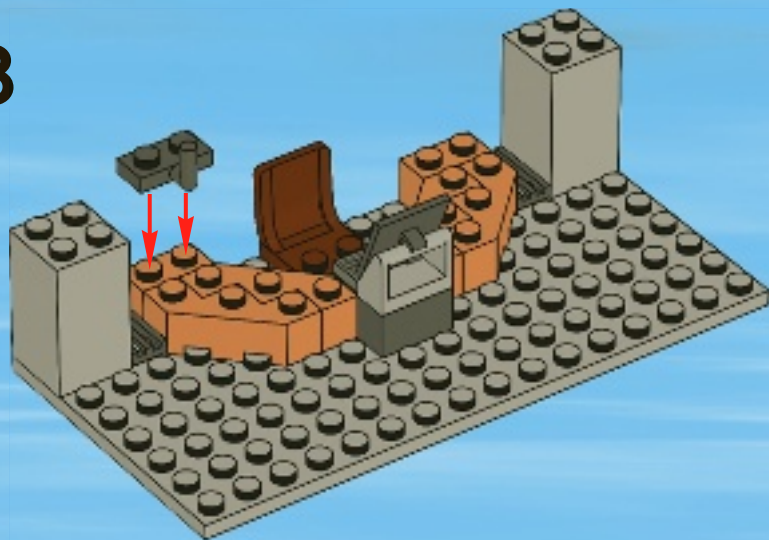

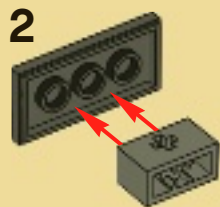
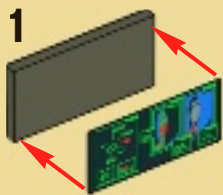

9

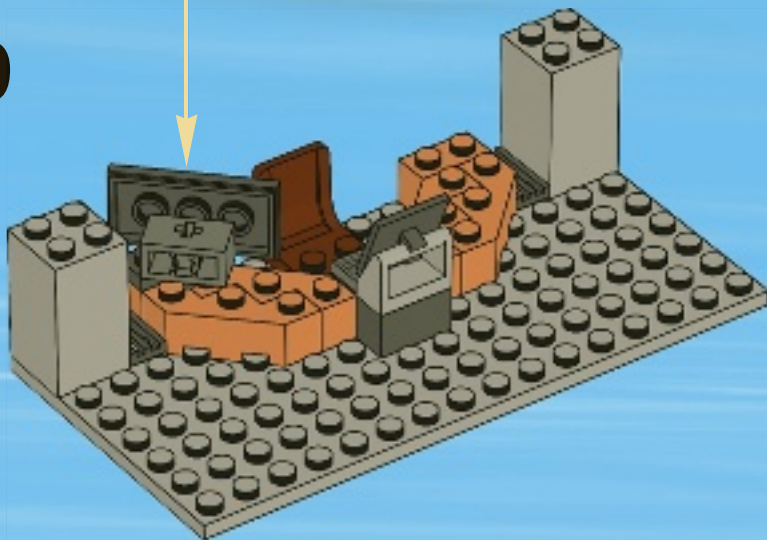

11

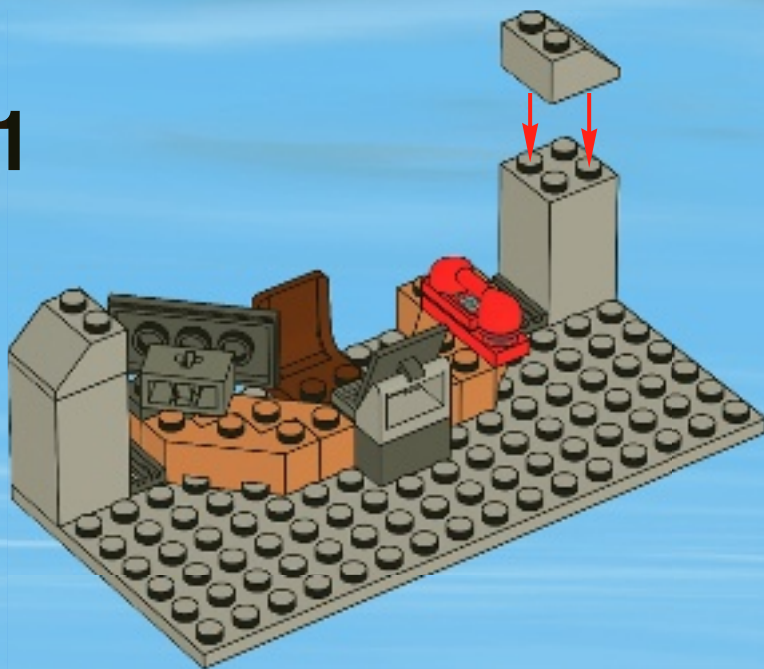

12

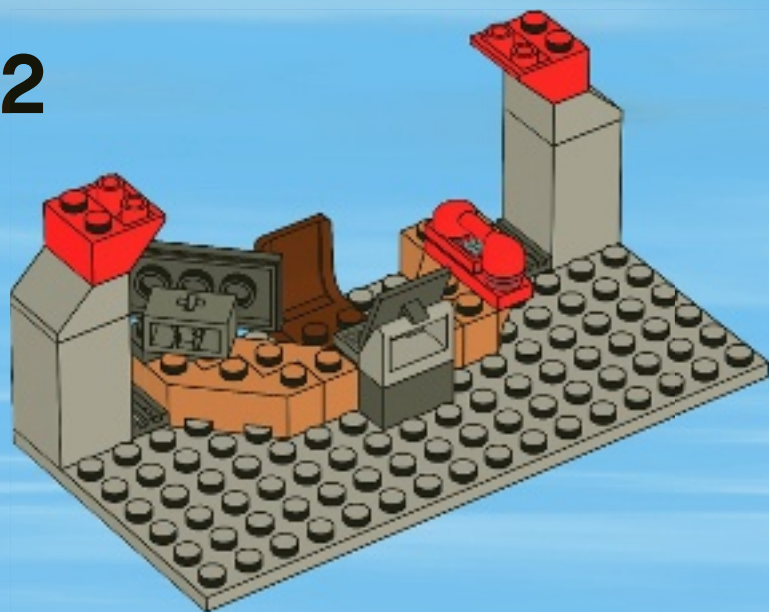

13

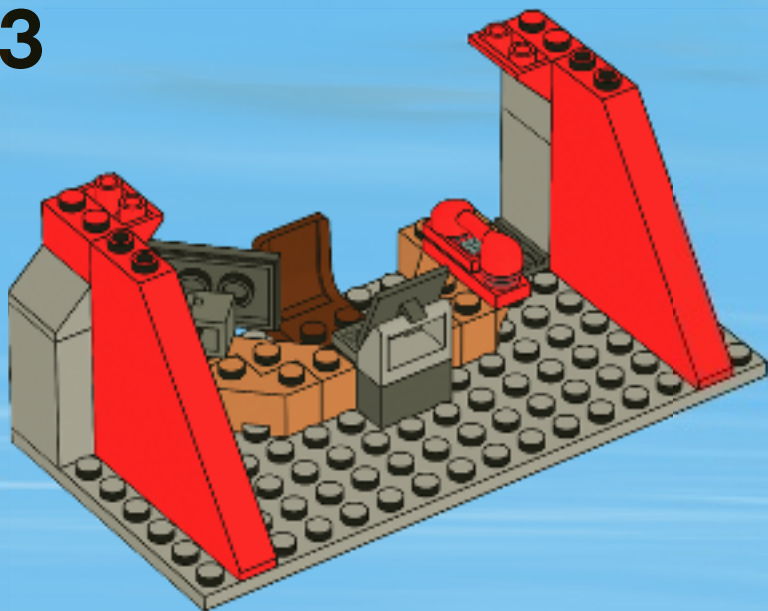

14

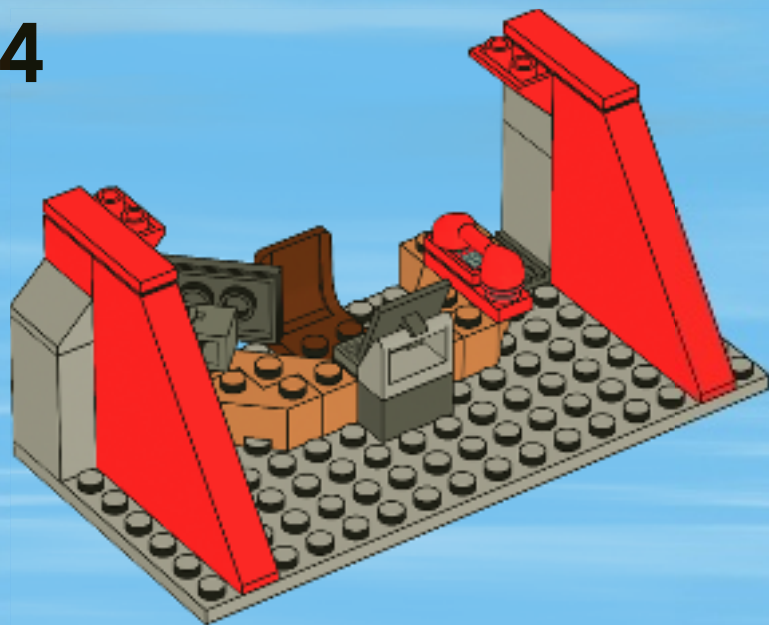

15

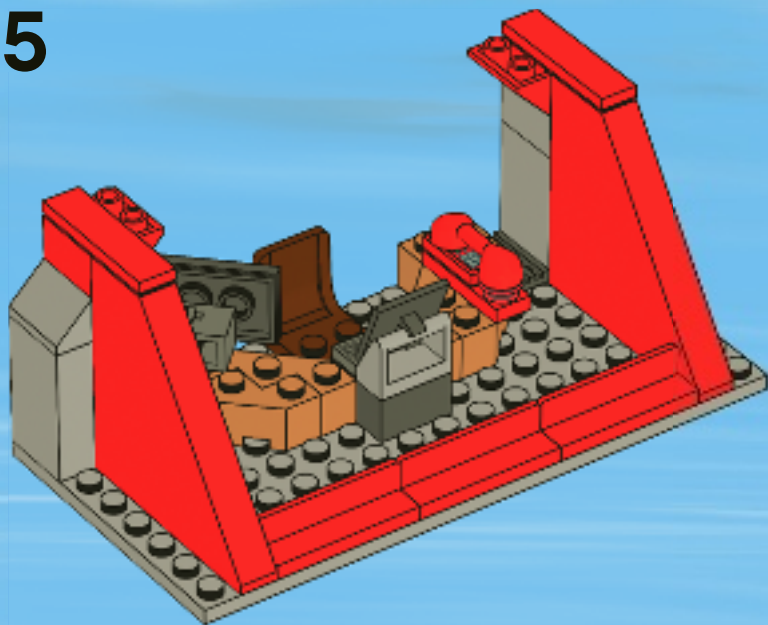

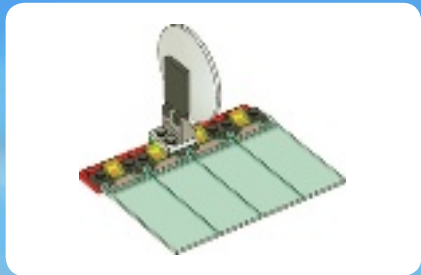

1

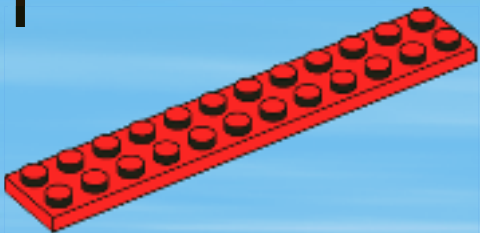

2

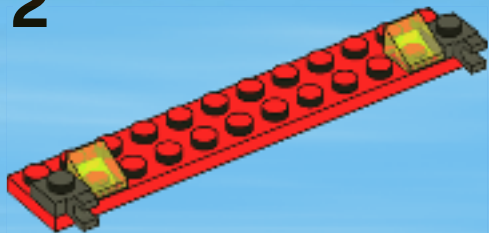

3



4



5

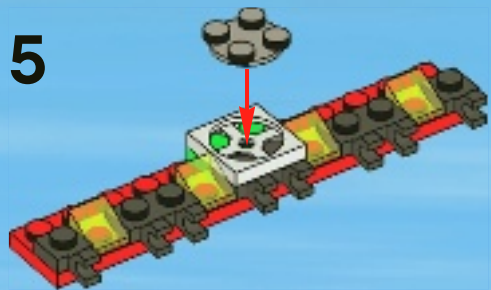

6

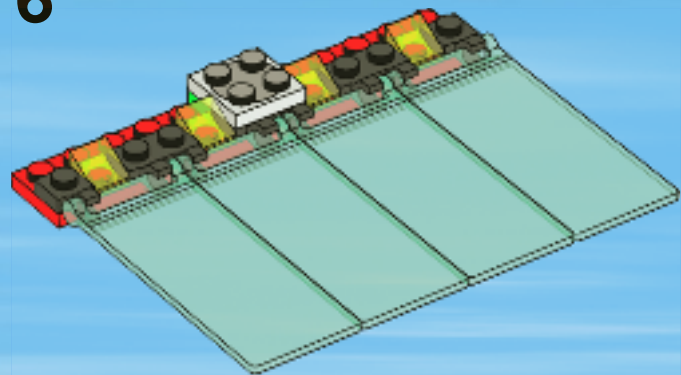

7

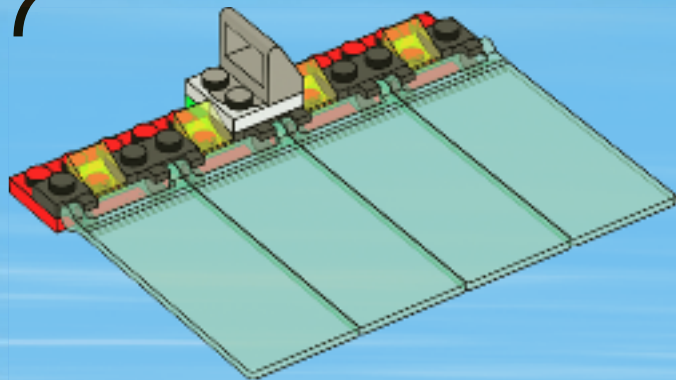

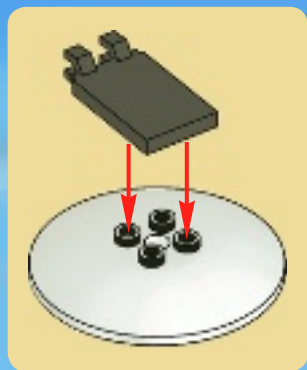

8

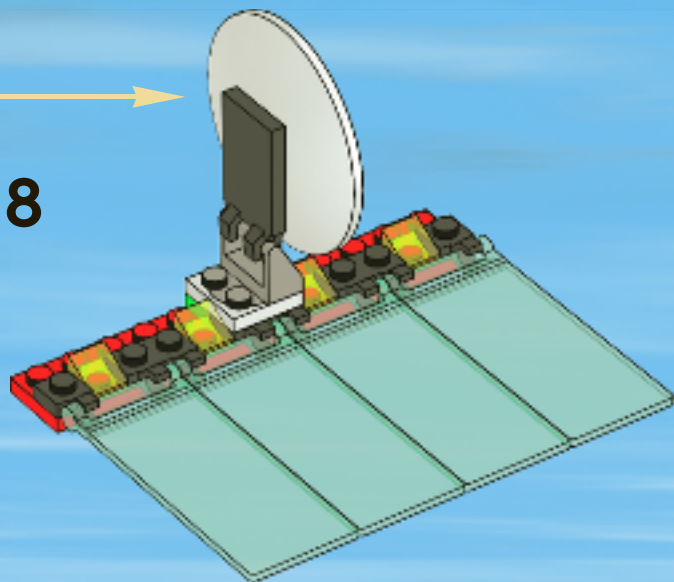

16

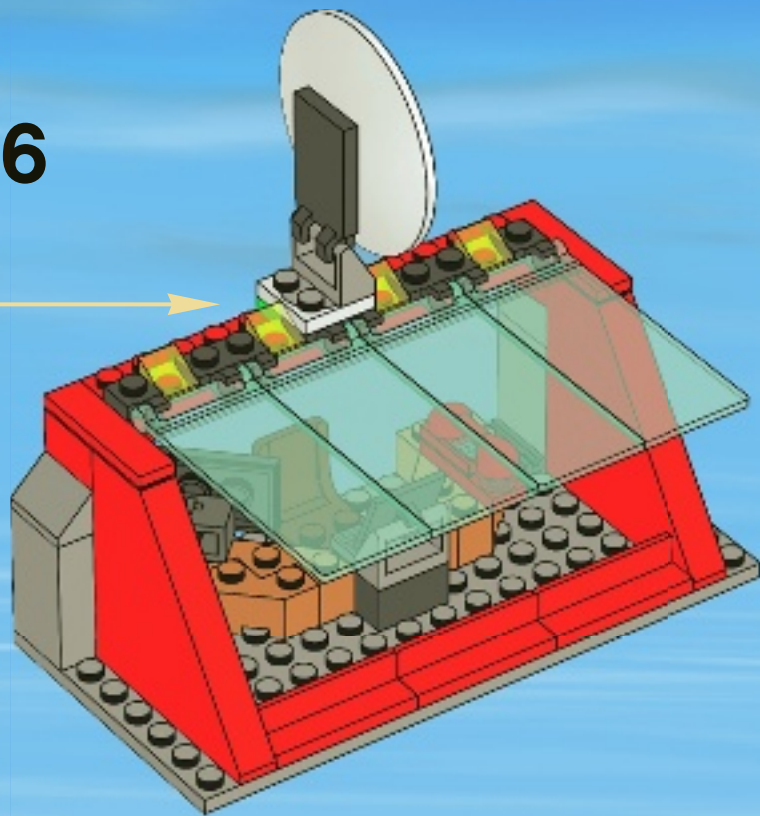

17

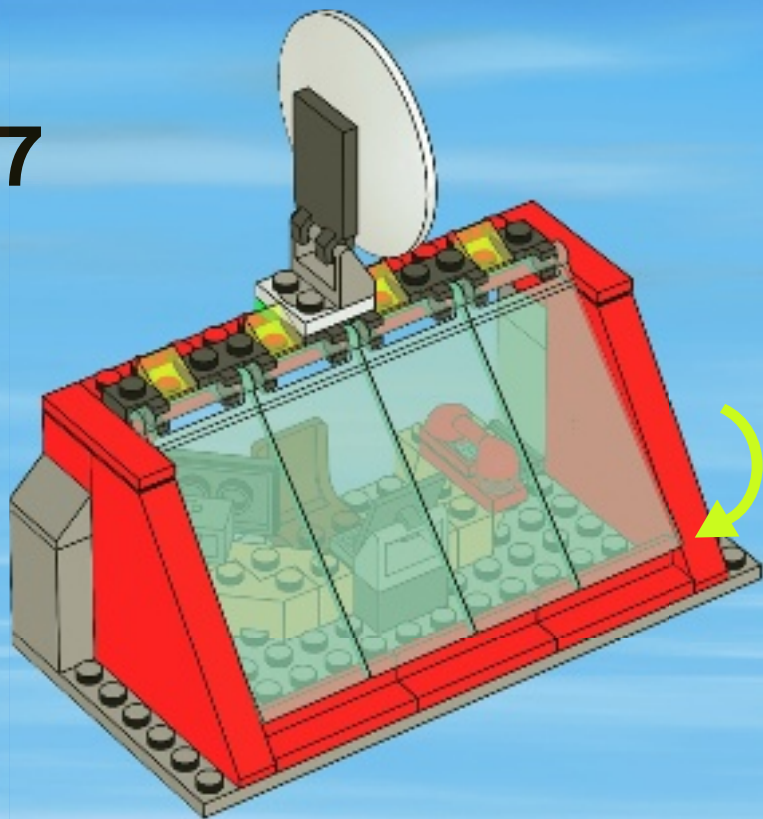

18

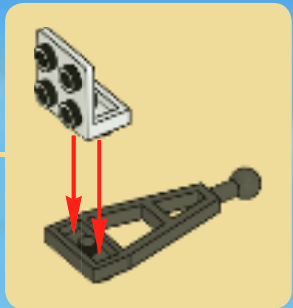
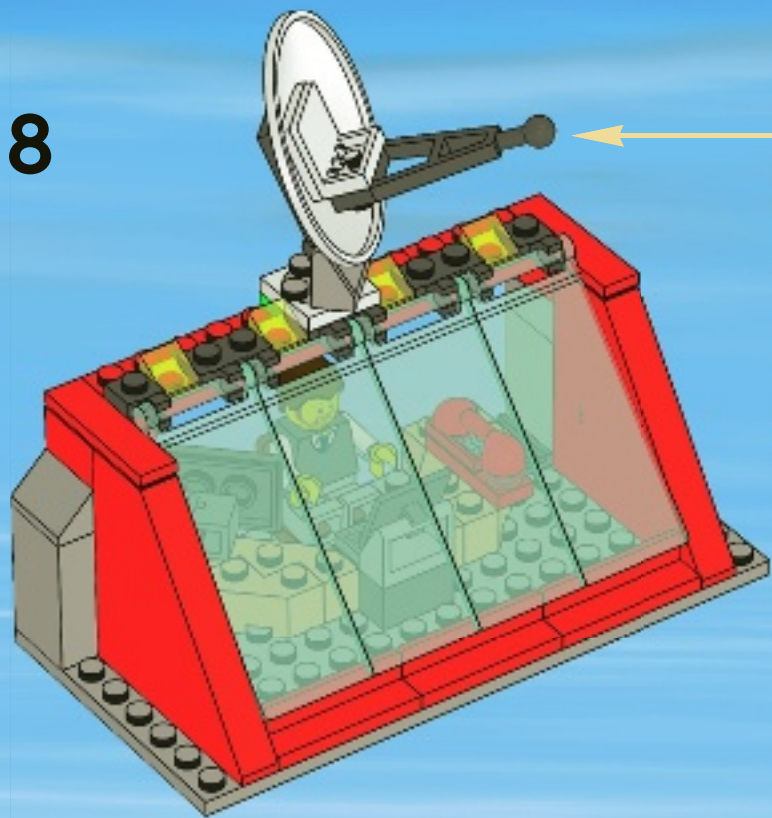

The LEGO CITY logo is located in the top left corner. It consists of the word "LEGO" in its signature white font on a red square background, followed by the word "CITY" in a blue, stylized font.The word "CITY" is part of the LEGO CITY logo, rendered in a blue, stylized font.A LEGO astronaut minifigure is positioned on the left side of the page. It has a white body, a gold helmet, and is shown from the waist up, facing right.

**The three-stage Saturn V is
the largest and most powerful rocket ever
launched.**

Die dreistufige Saturn V ist die größte und leistungsstärkste Rakete, die jemals ins All geschossen wurde.

La Fusée à trois étages Saturn V est la plus haute et la plus puissante jamais lancée.

El cohete Saturno V, de tres fases, es el más grande y potente que jamás se ha lanzado.

O Saturno V de três andares é o maior e mais potente foguetão jamais lançado.

A háromfokozatú Saturn V a legnagyobb és legerősebb rakéta, amelyet valaha felölttek.



The LEGO CITY logo is located in the top left corner. It consists of the word "LEGO" in its signature yellow font with a black outline, set against a red square background. To the right of this, the word "CITY" is written in a large, white, sans-serif font with a slight shadow effect.The word "CITY" is part of the LEGO CITY logo, positioned to the right of the red square containing the "LEGO" text.

The ISS

(International Space Station) is where about six astronauts live and work in space (typically for six months at a time).

Auf der internationalen Raumstation ISS (International Space Station) gibt es meist um die sechs Astronauten, die im Weltraum arbeiten und leben. Jeder Astronaut bleibt normalerweise sechs Monate auf der ISS.

L'ISS (station spatiale internationale) est l'endroit où environ six astronautes vivent et travaillent dans l'espace (normalement pour 6 mois chacun).

La EEI (Estación Espacial Internacional) es una instalación situada en el espacio en la que conviven y trabajan unos seis astronautas (normalmente durante periodos de 6 meses).

O Centro da Estação Espacial Internacional é onde cerca de seis astronautas vivem e trabalham no espaço (cada um deles fica, geralmente, seis meses).

A Nemzetközi Űrállomás (ISS) az a hely, ahol körülbelül 6 űrhajós él és dolgozik az űrben (általában mindegyikük 6 hónapon át).

**The longest stay at the ISS
was 377 days.**

Der längste Aufenthalt auf der ISS dauerte 377 Tage.

Le séjour le plus long dans l'ISS (station spatiale internationale) a été de 377 jours.

El máximo periodo de tiempo que ha permanecido una persona en la EEI es de 377 días.

A estadia mais longa na Estação Espacial Internacional foi 377 dias.

A Nemzetközi Űrállomáson töltött leghosszabb időtartam 377 nap volt.



ISS - International Space Station



LEGO**CITY**

NASA Astronaut



Spacesuits help protect astronauts from extreme temperatures (-157 degrees Celsius to 121 degrees Celsius).

Weltraumanzüge schützen Astronauten vor extremen Temperaturen (-157° Celsius bis 121° Celsius).

Les combinaisons spatiales aident les astronautes à se protéger des températures extrêmes (moins 157 degrés Celsius à plus 121 degrés Celsius).

Los trajes espaciales protegen a los astronautas frente a temperaturas extremas (comprendidos entre -157 y 121 grados centígrados).

Os fatos de astronautas protegem-nos contra temperaturas extremas (compreendidas entre -157°C e 121°C).

Az űrhajósokat az űrruha védi a rendkívüli hőmérséklettől (mínusz 157 Celsius-foktól 121 Celsius-fokig).

In collaboration with NASA, In Zusammenarbeit mit der NASA,
En collaboration avec la NASA, En colaboración con la NASA,
En colaboración con la NASA, A NASA közreműködésével.

**Every 97 minutes, the Hubble
Space Telescope completes an orbit around Earth
– Fast enough to travel across the United States
in about 10 minutes.**

Alle 97 Minuten hat das Hubble-Weltraumteleskop die Erde einmal umkreist – schnell genug, um in zehn Minuten durch die USA zu reisen.

Chaque 97 minutes, le Télescope Spatial Hubble complète une orbite autour de la Terre, assez vite pour traverser les États-Unis en environ 10 minutes.

El Telescopio Espacial Hubble completa una órbita alrededor de la tierra cada 97 minutos (su velocidad es suficiente como para atravesar Estados Unidos de costa a costa en unos 10 minutos).

O Telescópio Espacial Hubble completa uma órbita à volta da Terra todas os 97 minutos. – suficientemente rápido para atravessar os Estados Unidos em cerca de 10 minutos.

A Hubble távcső minden 97 percben egy teljes keringést végez a Föld körül. – elég gyors ahhoz, hogy 10 perc alatt elhaladjon az Egyesült Államok fölött.





CREATOR

5766





CITY



7279



7285



7286



7287



7288



7498

LEGO

CITY



7942



7239



7207



7208

YES! I want to join the LEGO Club FREE! **OUI!** Je veux m'abonner au LEGO Club GRATUIT! **Ja!** Ich möchte Mitglied im kostenlosen LEGO Club werden.
Ja! Ik wil graag GRATIS lid worden van de LEGO Club. **Ja!** Jeg ønsker å melde meg inn i LEGO Club gratis! **Ja!** Jag vill gå med i LEGO Club GRATIS!

First name • Prénom Vorname • Voornaam Fornavn • Förnamn														
Last name • Nom de famille Name • Achternaam • Etternavn • Efternamn														
Date of Birth • Date de naissance Geburtsdag • Geboortedatum Fødselsdato • Födelsedatum					Boy • Garçon Junge • Jongen • Gutt • Pojk					Girl • Fille Mädchen • Meisje Jente • Flicka				
Street • Adresse Straße, Hausnr. Straat, huysnr. • Adress														
City • Ville Ort • Woonplaats Poststed • Postort							State Prov. County							
Zip/Postcode Code Postal • PLZ Postcode Postnummer							Country Pays Land							
Email • Courriel E-Mail • E-post														

Mail to: /
Poster à:

  LEGO Club
P.O. Box 1157
Enfield, CT USA
06083-1157

Send til: LEGO Club Norge
 Postboks 58
1314 Vøyenenga

Mail to: LEGO Club
  33 Bath Road
Slough SL1 3UF
United Kingdom

Skickas till: LEGO Club Sverige
 Ubox 841
202 29 Malmö

Per Post an: LEGO Club
   Postfach 14 15
D-36243 Niederaula

Poster à: LEGO Club
 21 rue de la Banque
75 002 PARIS
FRANCE

Stuur op naar: LEGO Club
 Postbus 40250
3504 AB Utrecht

Fill in your email address and we will send you a membership confirmation and monthly email newsletters. If you do not wish to receive the newsletters please tick here. Remplis ton adresse e-mail et nous t'enverrons une confirmation d'adhésion ainsi que le bulletin e-mail mensuel. Si tu ne désires pas recevoir le bulletin, coche cette case. Vul je e-mailadres in en we sturen je een bevestiging van je lidmaatschap en maandelijkse e-mail nieuwsbrieven. Als je geen e-mail wilt ontvangen, kruis dan dit vakje aan.

If you do not wish to receive additional mailings from the LEGO Club please tick here. Si tu ne désires pas recevoir de courrier supplémentaire du Club LEGO, coche cette case. Als je geen verdere post van de LEGO Club wilt ontvangen, kruis dan dit vakje aan.

Ich möchte per E-Mail den monatlichen LEGO Club Newsletter erhalten. Önsker du at vi skal sende en liten hilsen til barnet ditt for å bekrefte medlemskapet, ber vi deg krysse av i feltet, samt oppgi e-postadressen som hilsenen skal sendes til. Om du vill att vi ska skicka en bekräftelse på ditt barns medlemskap, ber vi dig sätta ett kryss i rutan och skriva den e-post adress som bekräftelsen ska skickas till.

Om du vill få annan informasjon från LEGO Gruppen, sätt ett kryss här. Dersom du ønsker å motta annen informasjon fra LEGO Gruppen, setter du et kryss her.

 The English language version of the magazine can only be mailed to addresses in the US, Canada, the UK and Republic of Ireland. Club membership is valid for two years and includes free copies of the LEGO Club Magazine and e-mail newsletters. In the US and Canada please allow up to 6 weeks for delivery of your first magazine. In the UK and Republic of Ireland please allow six to 14 weeks for delivery of your first magazine. By signing this form you consent the LEGO Club to use your child's data for LEGO mailings. The data will only be used for LEGO mailings and will not be sold, rented or otherwise disclosed to any company outside the LEGO Company except for disclosure to companies acting as our agents to help us provide services requested by the child. This coupon is valid for one free membership per person, group or organization. Photocopied copies are not accepted.  La version française du magazine peut être postée uniquement au Canada. L'abonnement est valide pour 2 ans et inclut des exemplaires gratuits du magazine LEGO. Aux E-U et au Canada, allouer 6 semaines pour la livraison initiale. En remplissant ce formulaire, vous consentez à ce que LEGO utilise les informations de votre enfant pour des envois postaux de LEGO. L'information sera utilisée uniquement pour des envois postaux par LEGO et ne sera en aucun cas, vendue, louée, échangée ou divulguée à d'autres compagnies autres que la compagnie LEGO, à l'exception des compagnies affiliées qui nous procurent des services auxquels l'enfant en a fait la demande. Formulaires photocopiés acceptés.  Mit der folgenden Unterschrift erkläre ich, für mein Kind den Beitritt als Mitglied zum kostenlosen LEGO Club, der von der LEGO GmbH, D-85627 Grasbrunn, betrieben wird. Die Mitgliedschaft beinhaltet die Zusendung des LEGO Club Magazins und kann beiderseits jederzeit beendet werden. Mit der Mitgliedschaft im LEGO Club sind keinerlei Verpflichtungen verbunden. Das deutschsprachige LEGO Club Magazin wird nur an Adressen in Deutschland, Österreich und der Schweiz versendet. Eine Anmeldebestätigung kann nur per E-Mail geschickt werden. Das Magazin erscheint fünfmal jährlich. Daher kann die Zustellung des ersten Heftes bis zu drei Monate dauern. Die Mitgliedschaft ist beidseitig jederzeit kündbar, ohne dass Ihnen Kosten entstehen. Sie können der werblichen Nutzung Ihrer Daten jederzeit widersprechen. Kündigung und Widerspruch können Sie telefonisch erklären (00800 / 5346 5555, Anruf gebührenfrei, Kosten für Anrufe aus dem Mobilfunknetz können abweichen) oder an die LEGO GmbH senden.  Het Nederlandse LEGO Club Magazine kan alleen worden gestuurd naar adressen in Nederland. Het lidmaatschap is 2 jaar geldig en geeft recht op toezending van het gratis LEGO Club Magazine en LEGO Club e-mails. Het eerste magazine zal binnen 12 tot 14 weken toegestuurd worden. Het lidmaatschap kan op ieder moment opgezegd worden en kan na 2 jaar gratis worden verlengd, tenzij LEGO met deze activiteit stopt. Uw gegevens worden uitsluitend gebruikt voor mailings van LEGO en zullen niet worden verkocht, verhuurd of op welke wijze dan ook verspreid aan derden buiten de LEGO Groep, uitgezonderd de organisaties die namens ons optreden om de informatie te sturen waarvoor toestemming is verleend.  Den norske utgaven av magasinet sendes kun til adresser i Norge. Medlemskap i klubben gjelder 2 år og inkluderer gratisutgaver av LEGO Club Magazine. Pæren minimum oppsett seks eller leveringsditt for første magasin. Ved å undertegne dette skjemaet, gir du ditt samtykke til at LEGO Club kan bruke opplysningene om barnet ditt i LEGO fansendelser. Databene vil utelukkende bli brukt i LEGO fansendelser og vil ikke bli solgt, utleid eller brukt på annen måte igrans tilgjengelig for selskaper utenfor LEGO gruppen, unntatt selskaper som er våre agenter og som hjelper oss å tilby tjenestene barnet ettertar. Dette skjemaet gjelder for ett gratis medlemskap per person, gruppe eller organisasjon.  Den svenska versionen av tidningen kan endast skickas till adresser i Sverige. Club-medlemskapet är giltigt i 2 år och innefattar gratis exemplar av LEGO Club Magazine. Vänligen räkna med minimum 6 veckor för leverans av din första tidning. Genom att skicka in det här formuläret godkänner du att LEGO Club använder barnets uppgifter för LEGO utskick. Uppgifterna kommer bara att användas för LEGO utskick och kommer inte att säljas, hyras ut eller vidarebefordras till något företag som inte tillhör LEGO Gruppen, med undantag av företag som agerar som våra ombud för att tillhandahålla tjänster som barnet har begärt. Den här kupongen gäller för ett gratis medlemskap per person, grupp eller organisation.  En complétant ce bulletin d'adhésion, vous acceptez que LEGO Club utilise les données relatives à votre enfant pour l'envoi de courriers concernant LEGO. Ces données seront uniquement utilisées pour l'envoi d'information concernant LEGO et ne seront ni vendues, ni louées, ni utilisées par d'autres sociétés que le groupe LEGO, à l'exception des sociétés agissant pour le compte de LEGO dans le cas où elles sont sous-traitées de services divers. L'abonnement au LEGO Club est valable pour une période de 2 ans. Il inclut l'envoi par courrier du magazine LEGO Club et par email des newsletters. Un délai de 6 à 14 semaines est à prévoir pour la réception de votre premier magazine. Ce bulletin d'adhésion gratuit est valable pour l'inscription d'une seule personne. Les photocopies sont acceptées. ATTENTION! Le bulletin d'adhésion doit être rempli et signé par un parent ou un tuteur.

Parent's signature • Signature d'un parent ou d'un tuteur
 Unterschrift Erziehungsberechtigter/ • Handtekening ouders •
 Foreldres/foresattes underskrift • Förälders /förmyndares underskrift

Date
 Datum
 Date



www.LEGOclub.com



LEGO® Club Email



LEGO® Club Magazine

LEGO club™

FREE! GRATIS! GRATUIT!

 www.LEGO.com

SIGN UP ONLINE!

www.LEGOclub.com



00800 5346 5555*



1-866-534-6258 • 1-877-518-5346

US & Canada only

One-time enrollment

- * Freephone. Mobile charges may apply.
- * Numéro sans frais. Des frais peuvent s'appliquer avec les téléphones cellulaires.
- * Gebührenfrei, Kosten für Anrufe aus Mobilfunknetzen können abweichen.
- * Gratis telefoonnummer vanaf vaste lijn.
- * Det er et gratis nummer, når du ringer fra fasttelefon.
- * Det är gratis, när du ringer från en fast telefon.
- * Numéro sans frais. Des frais peuvent s'appliquer avec les téléphones portables.



3368

CITY



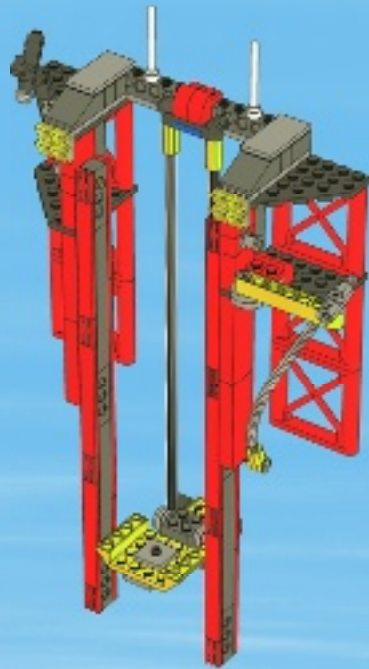
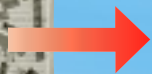

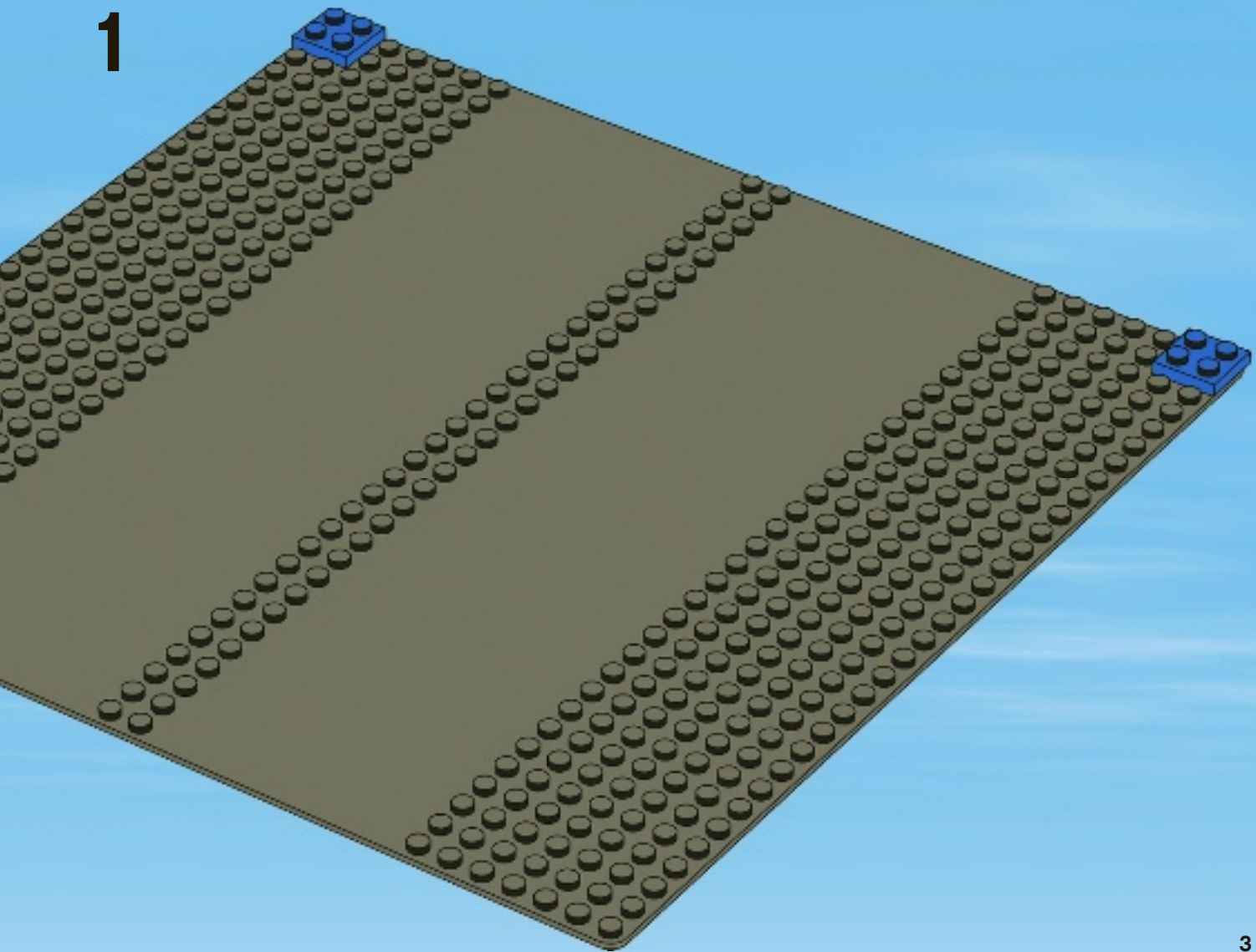
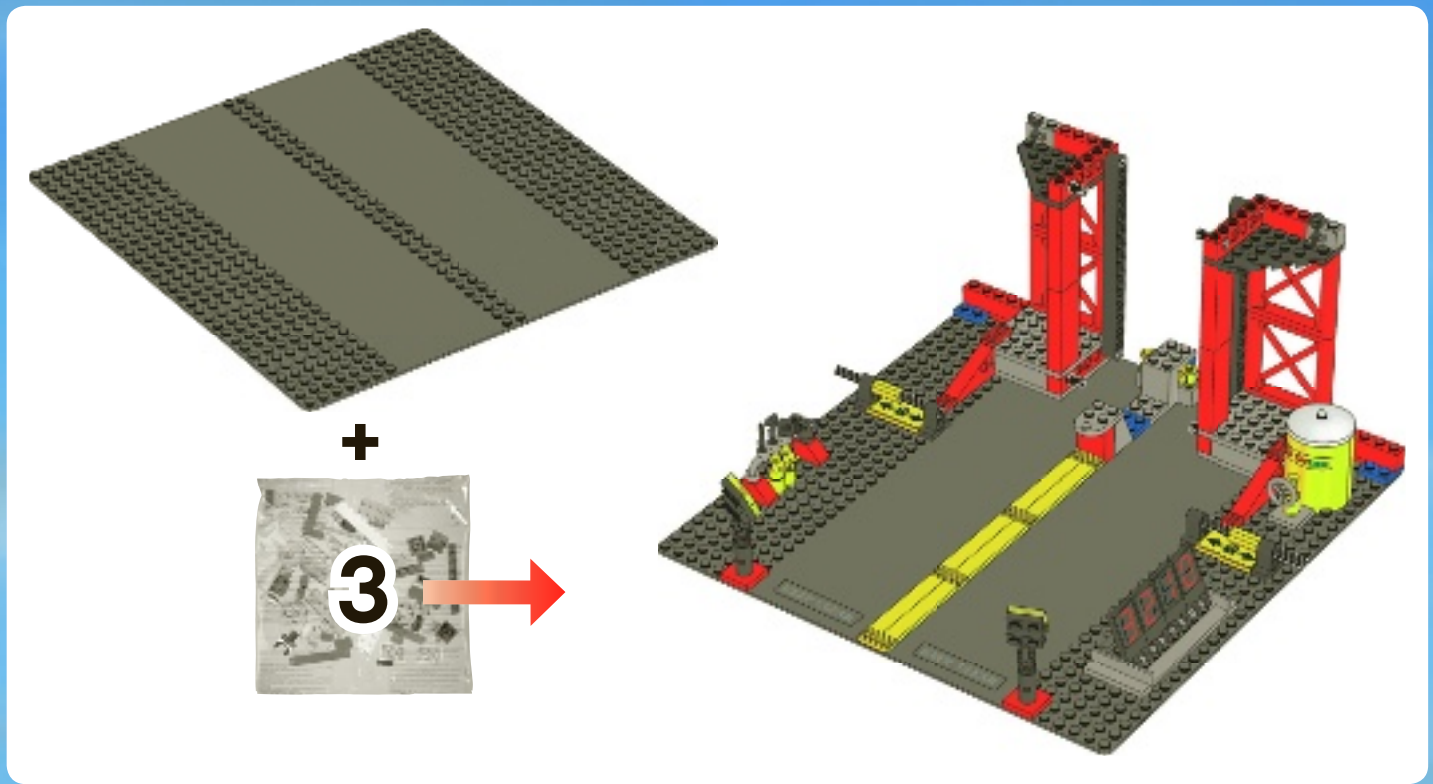

2

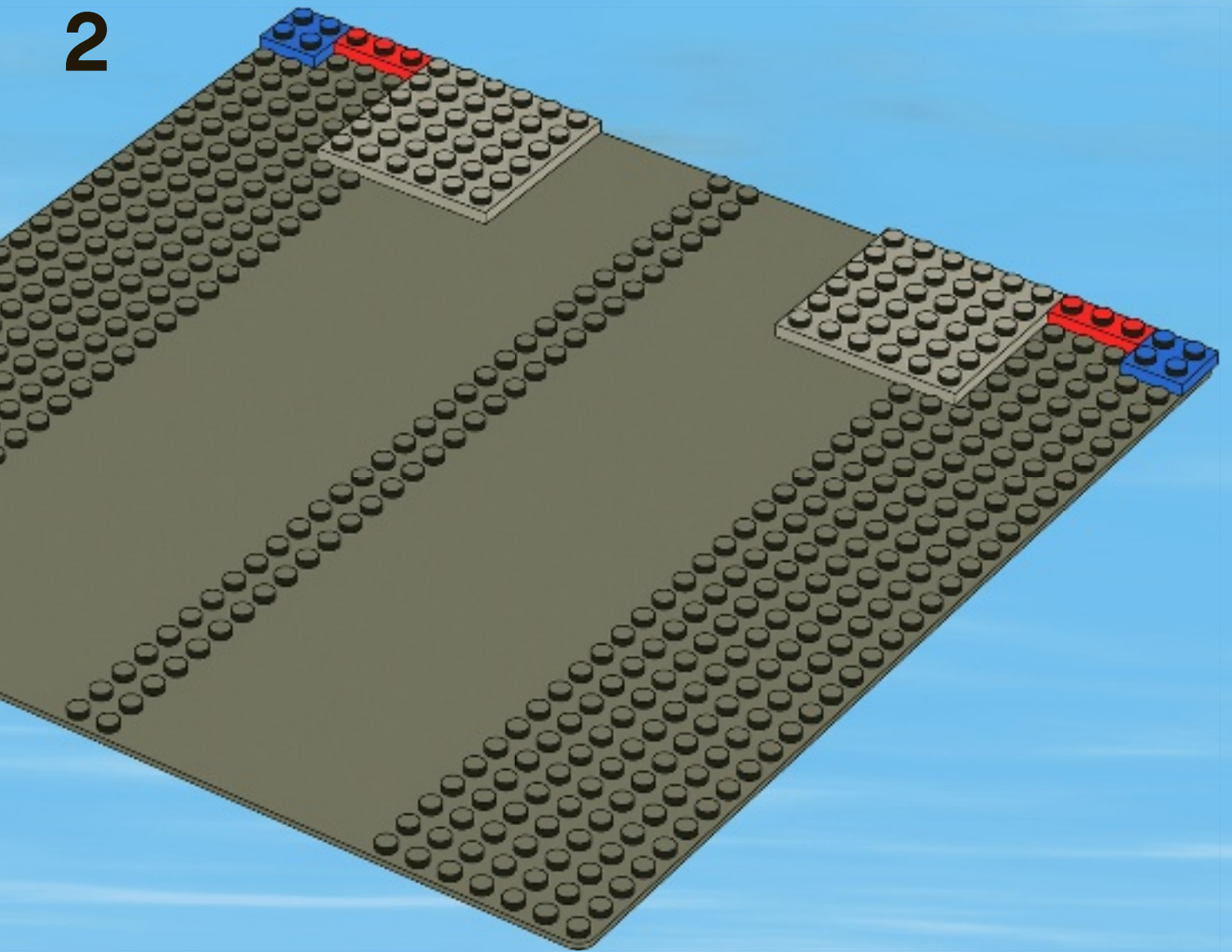

3

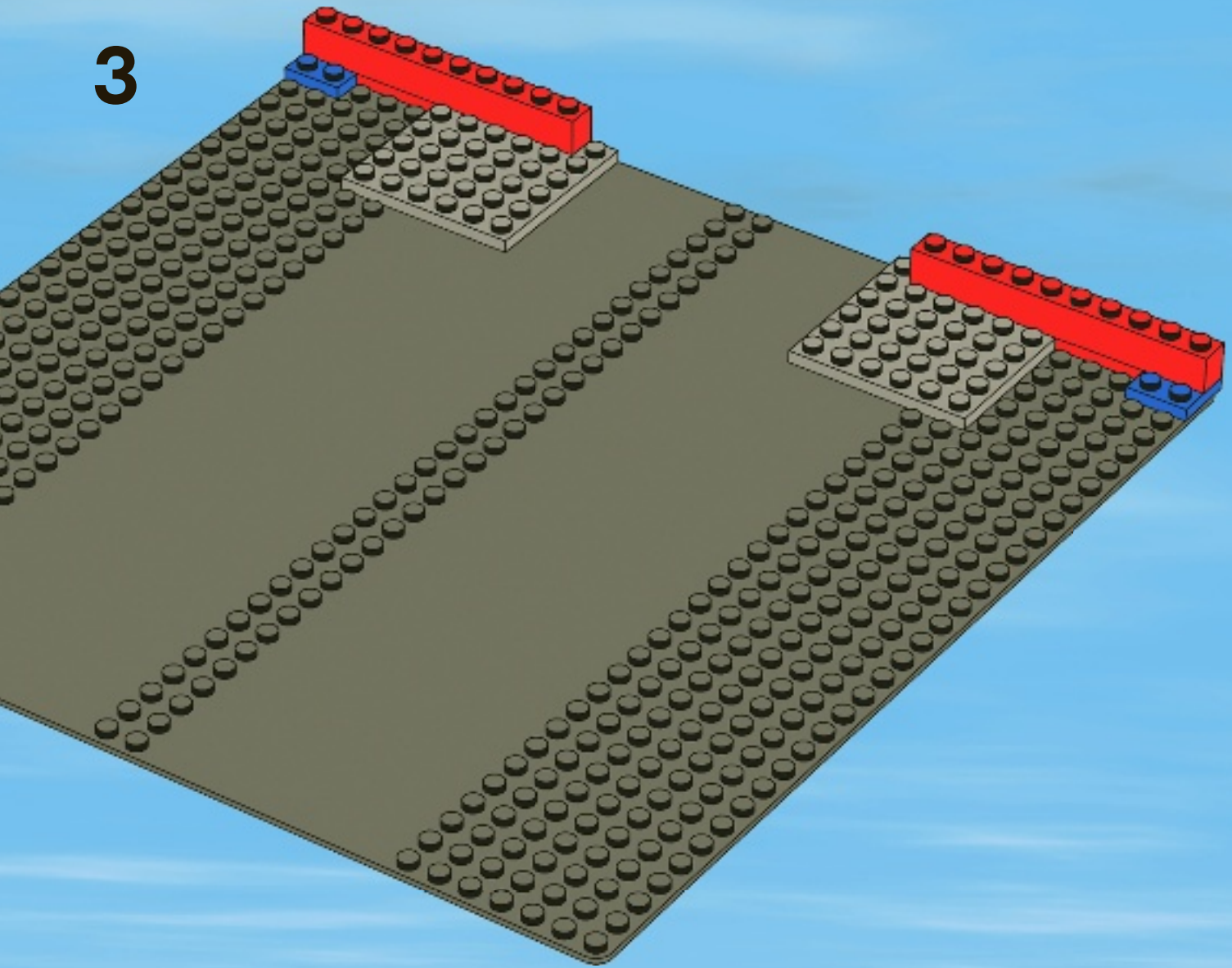

4

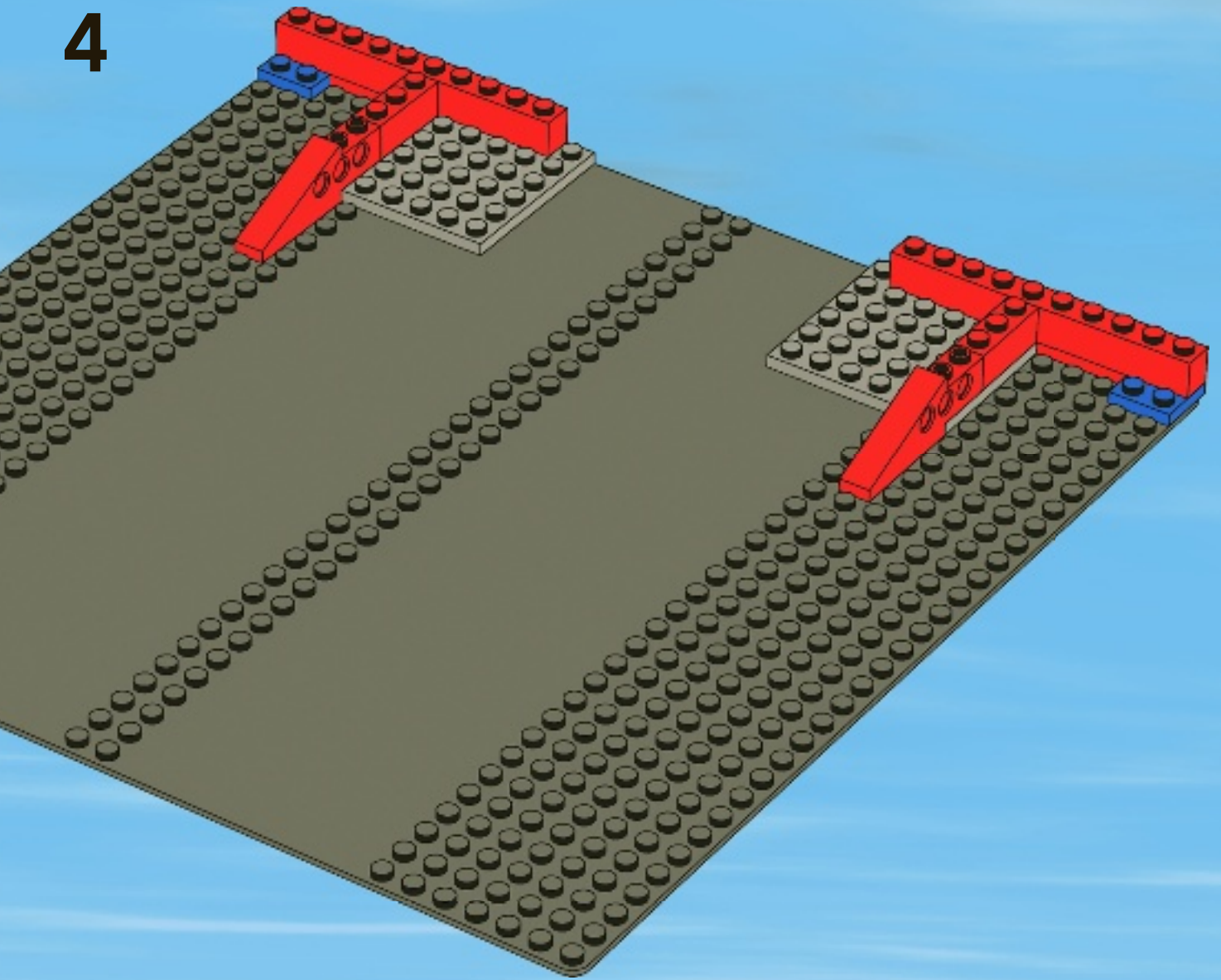

5

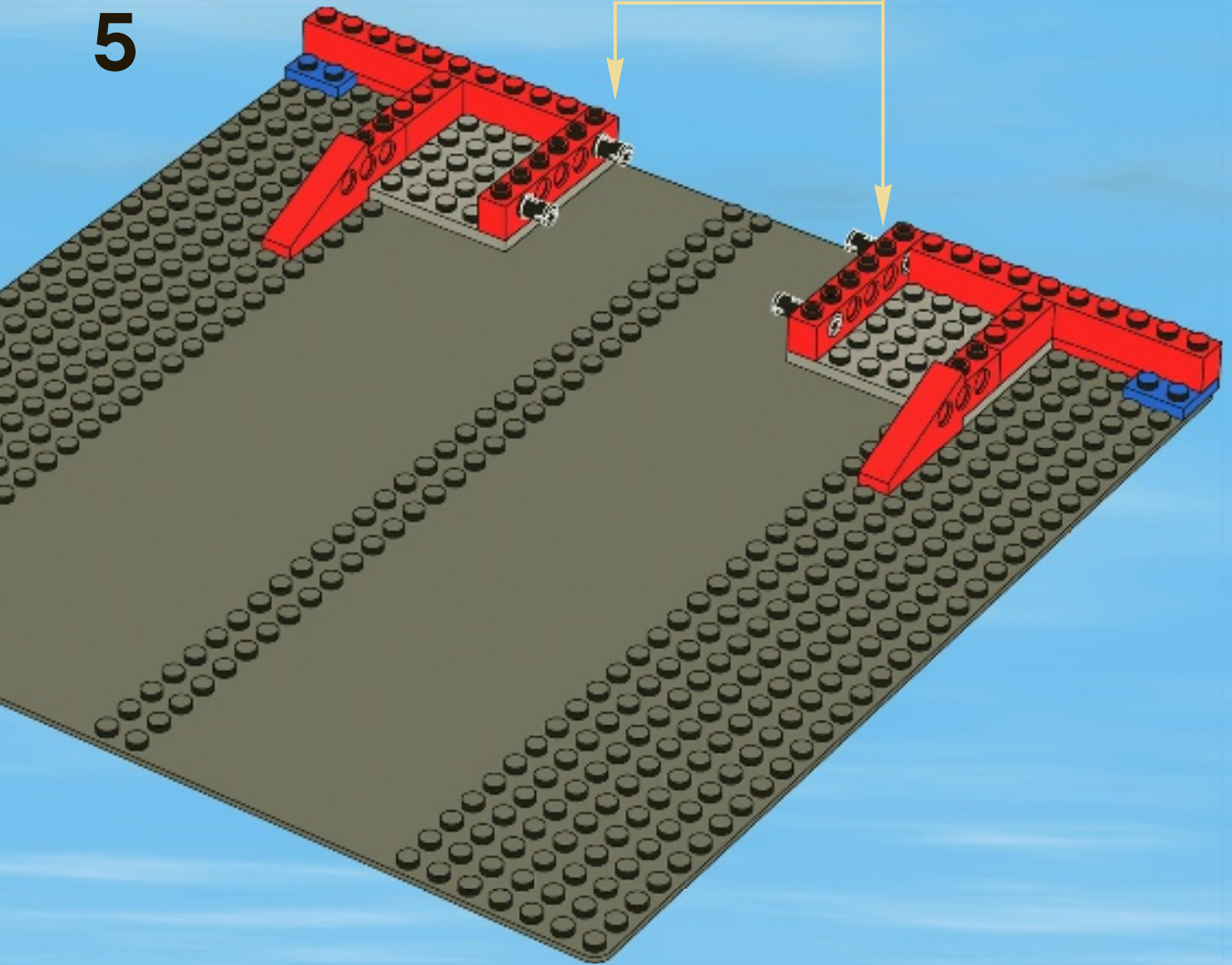
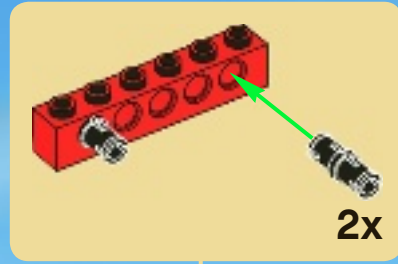

6

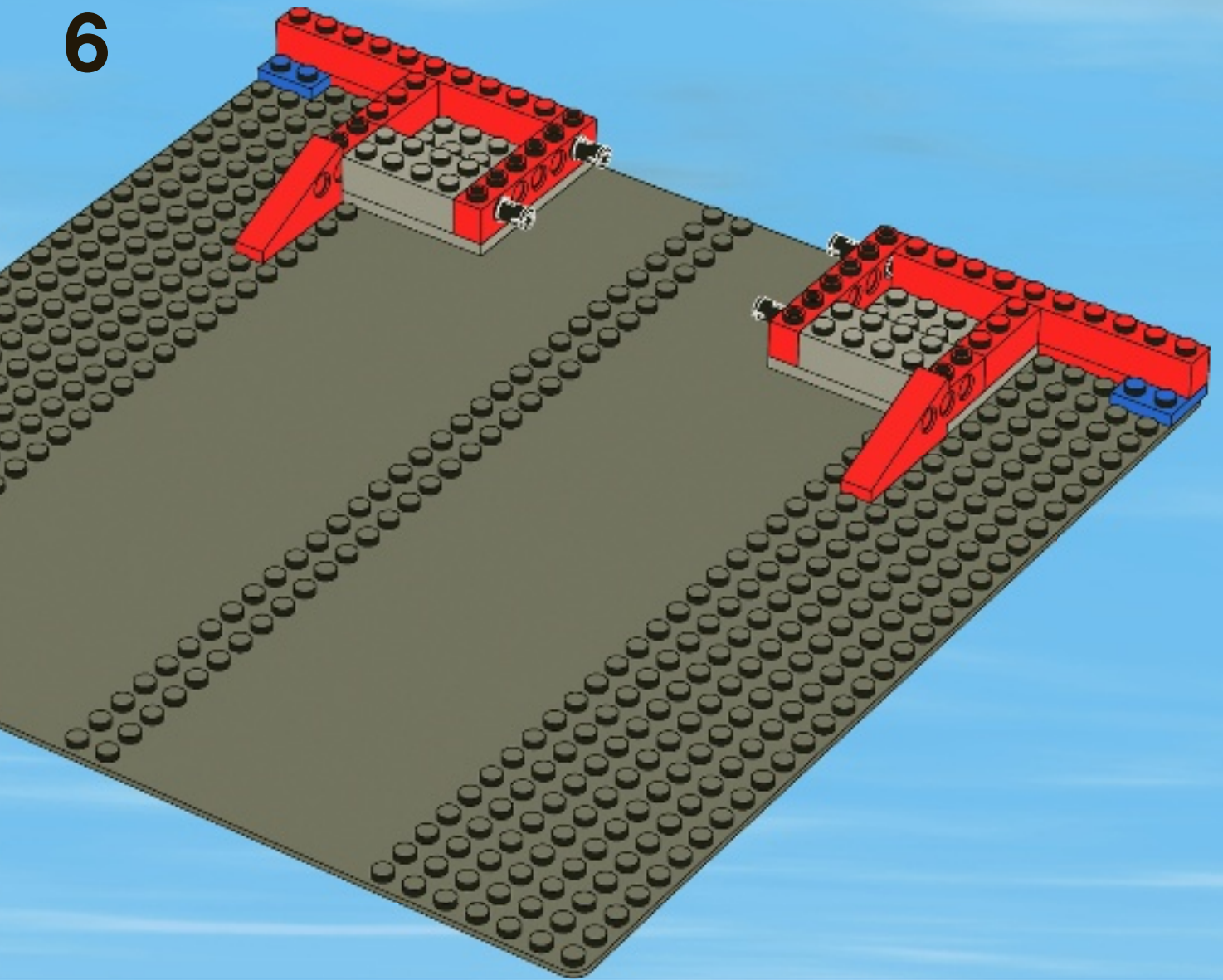

7

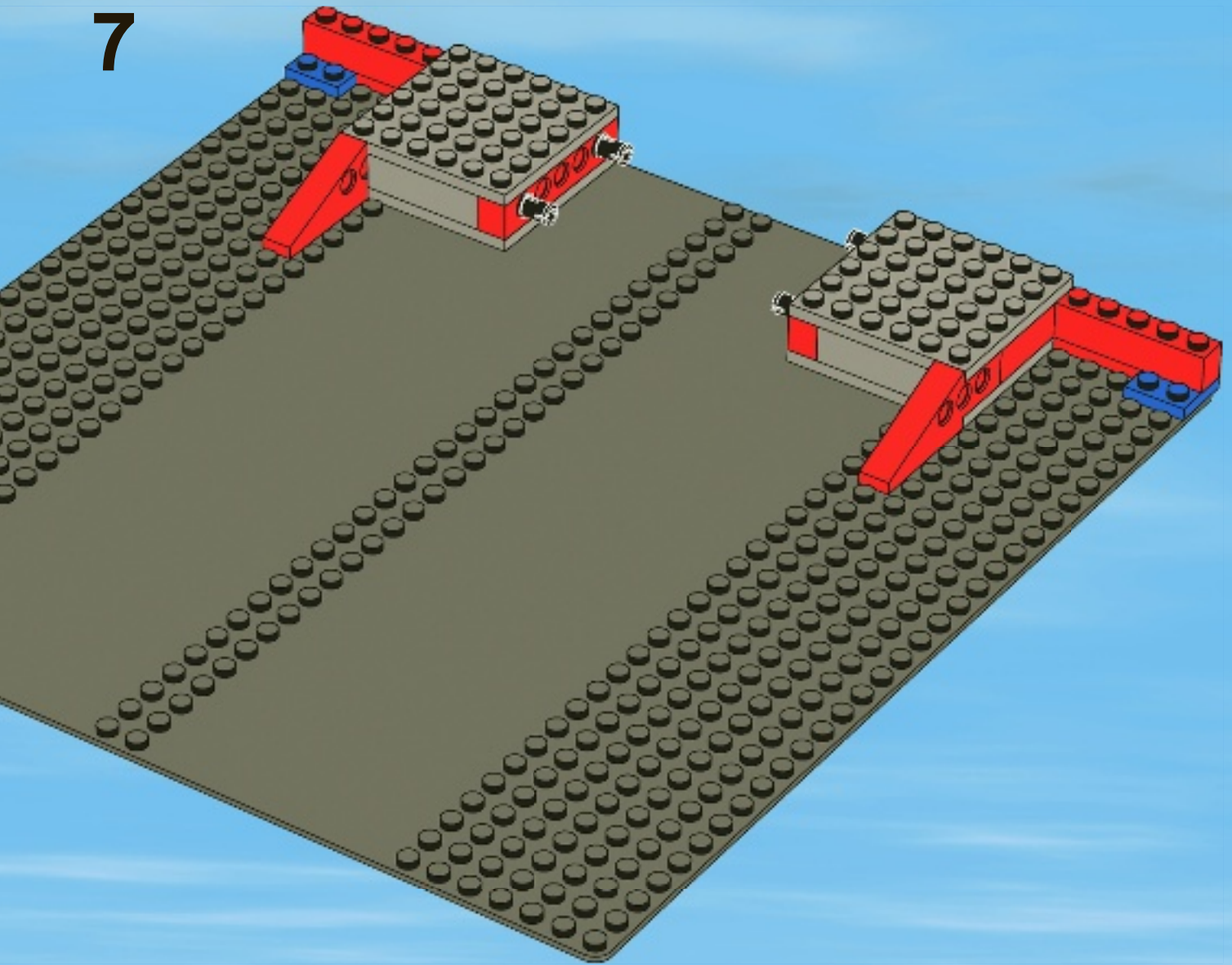

8

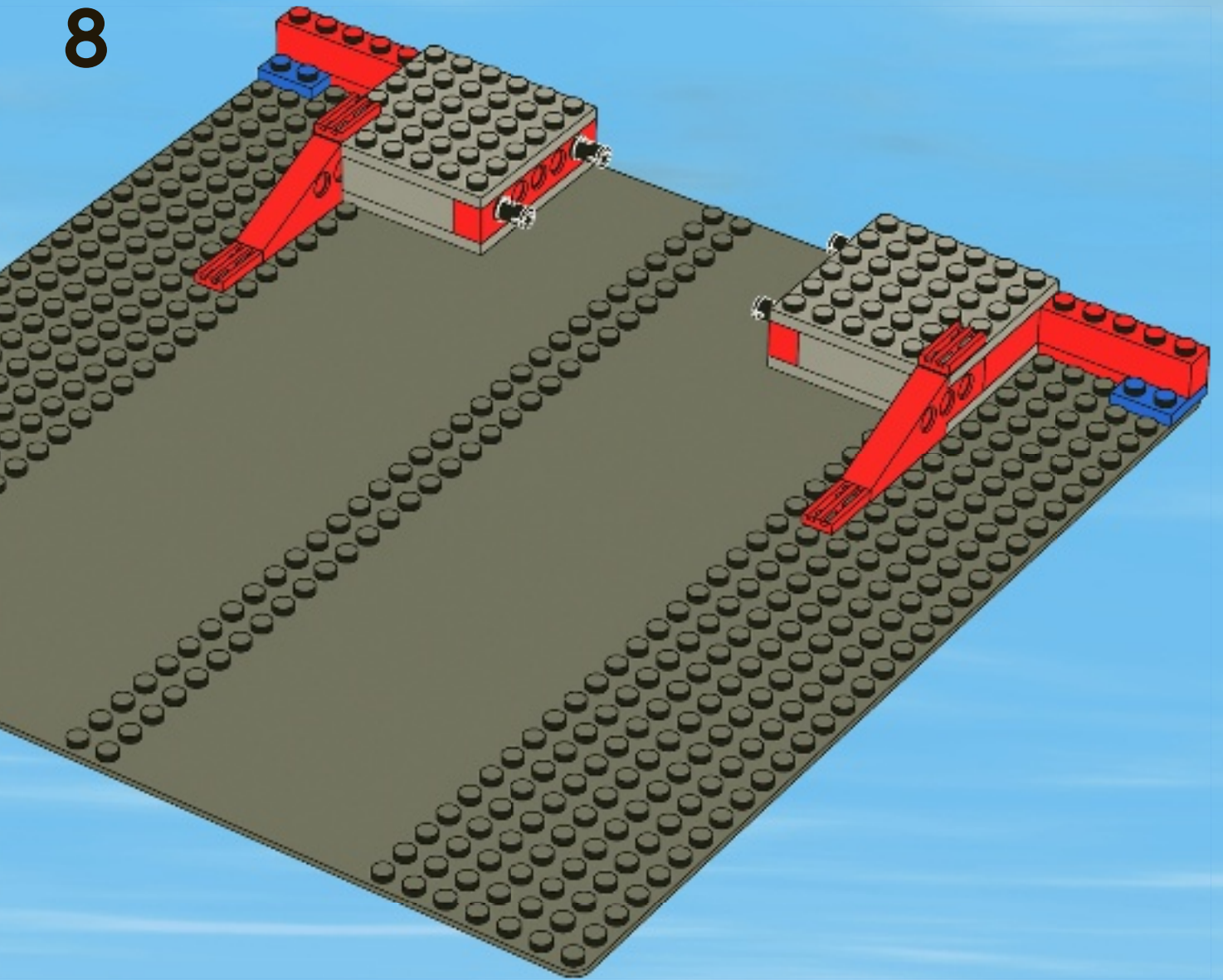

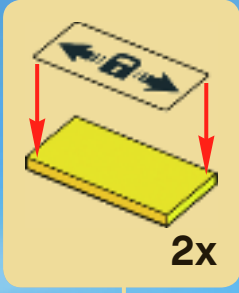

9

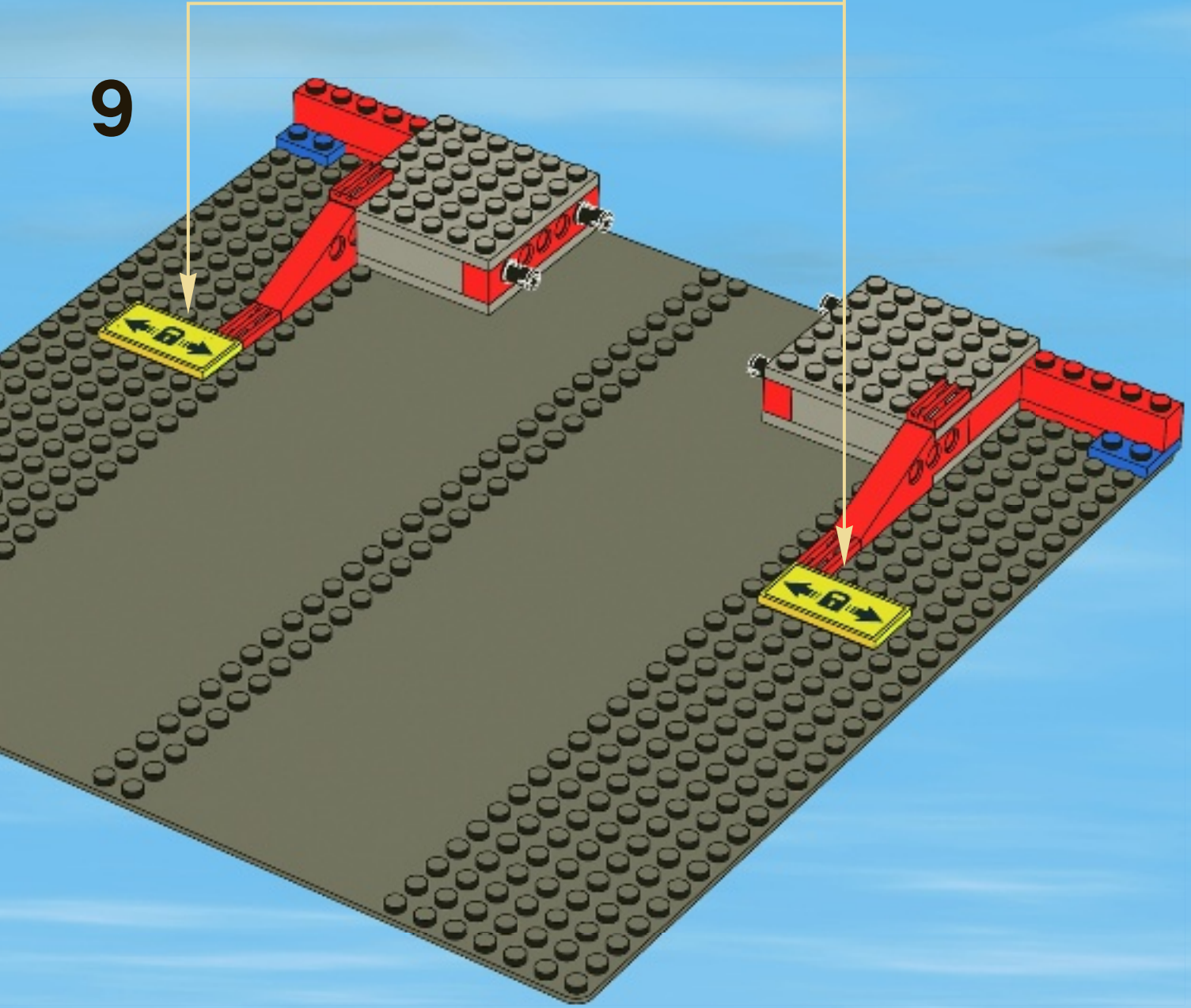

10

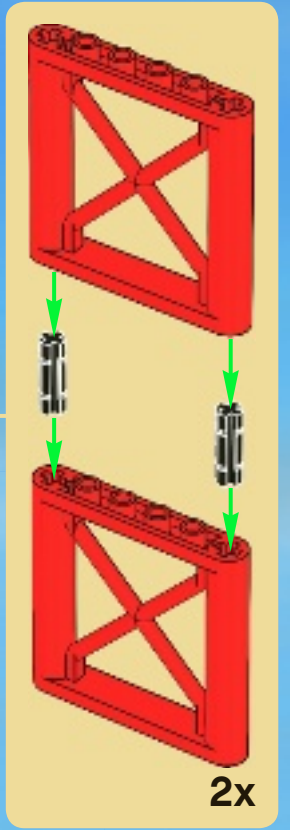
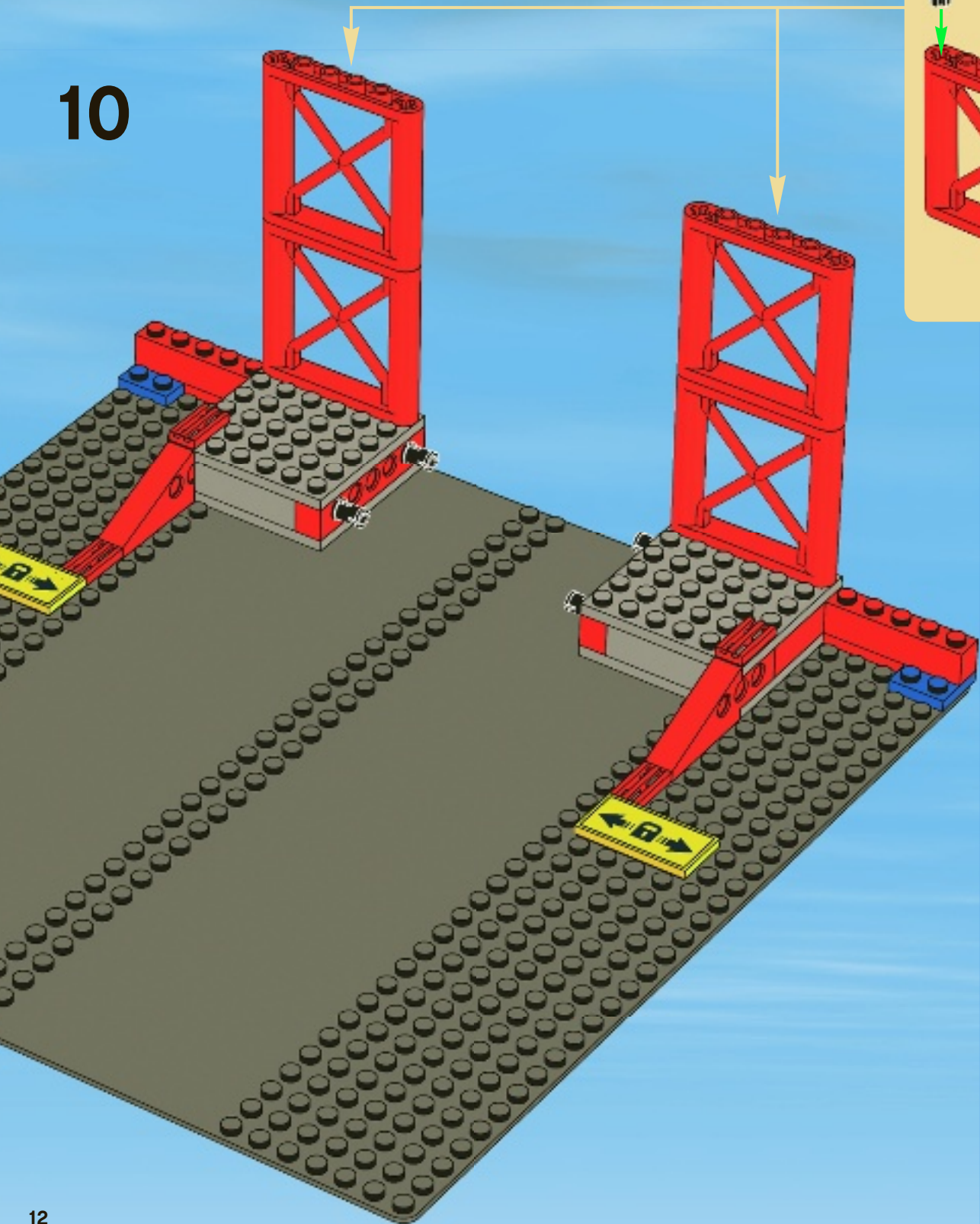

11

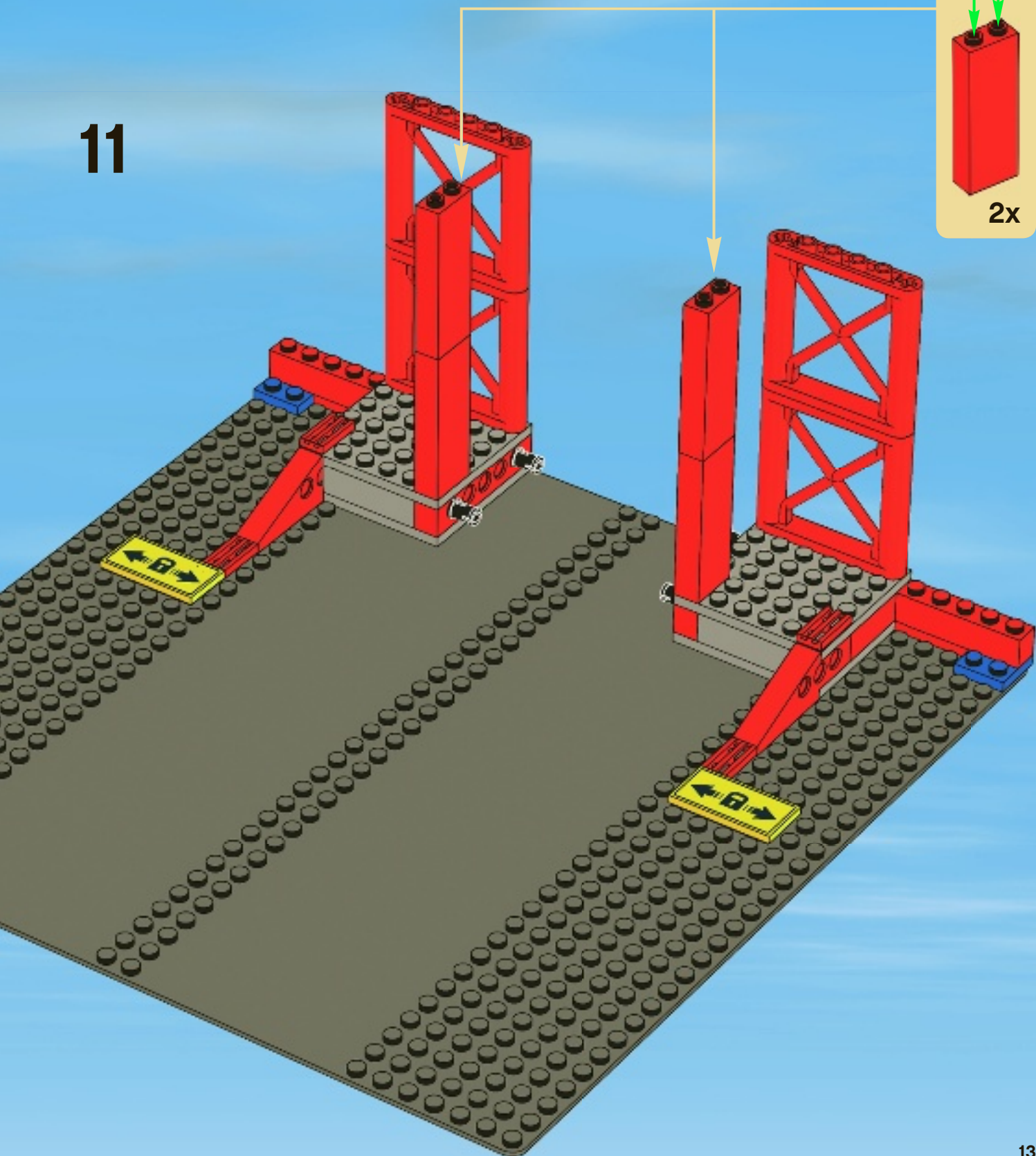

12

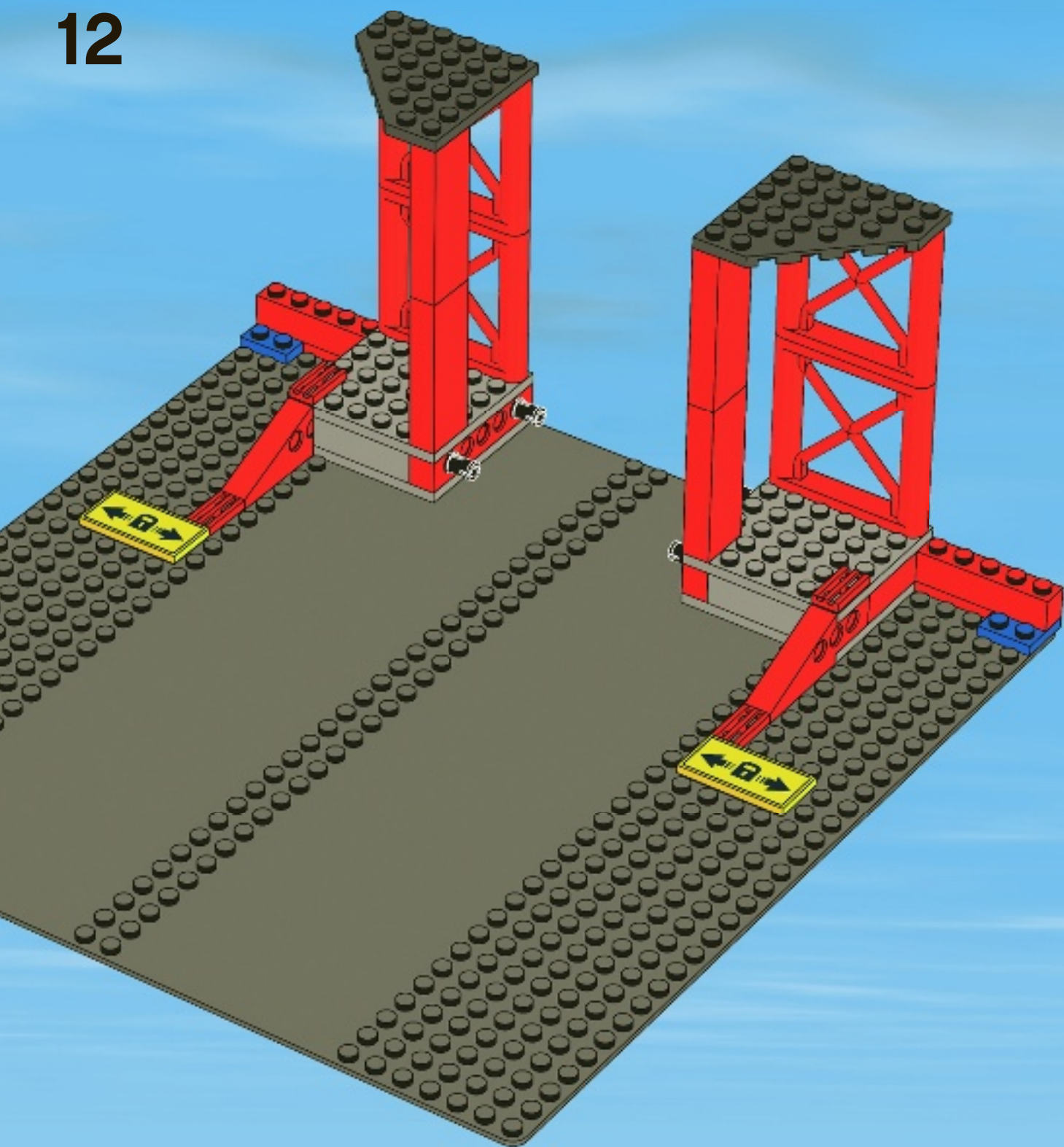

13

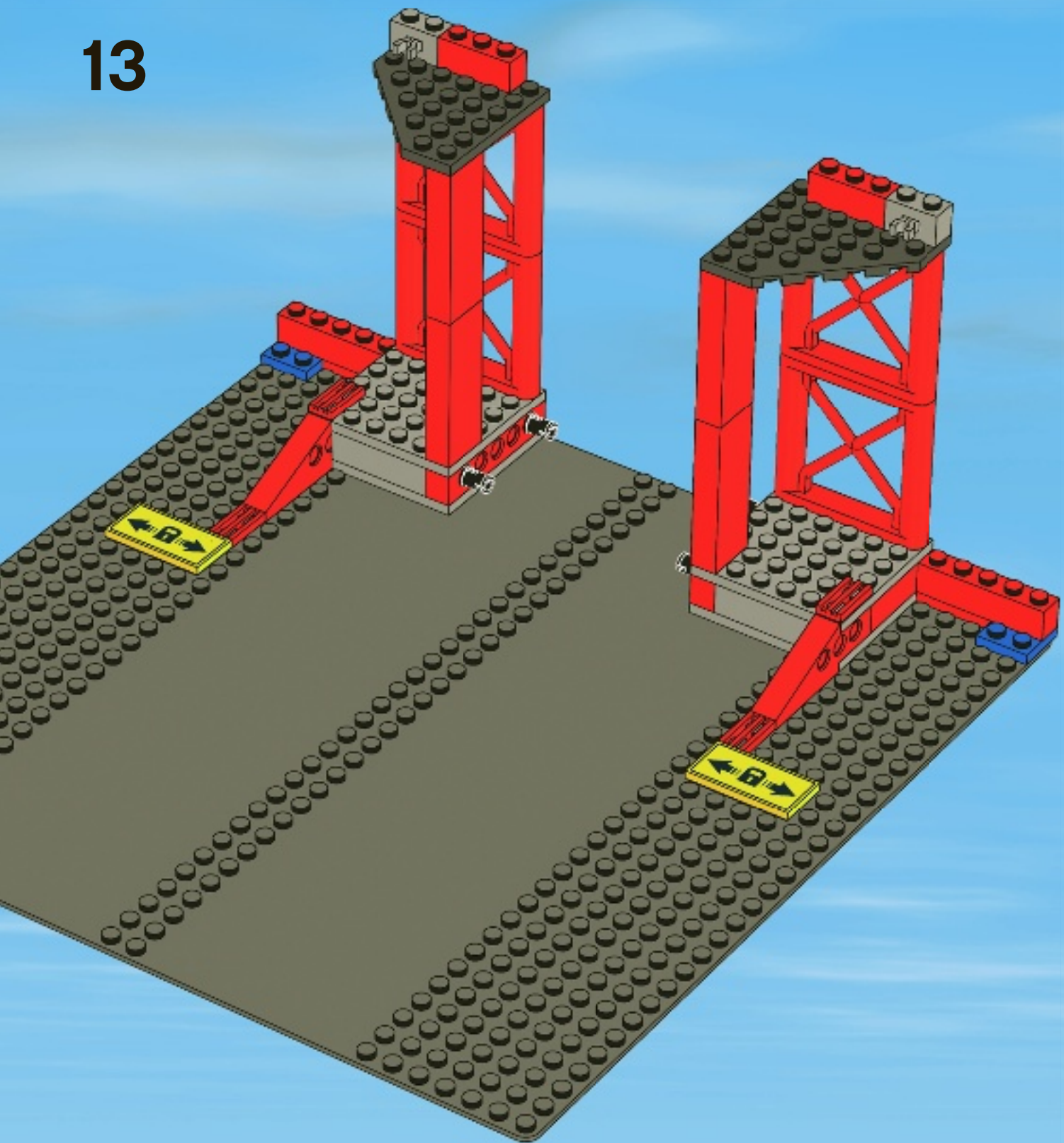

14

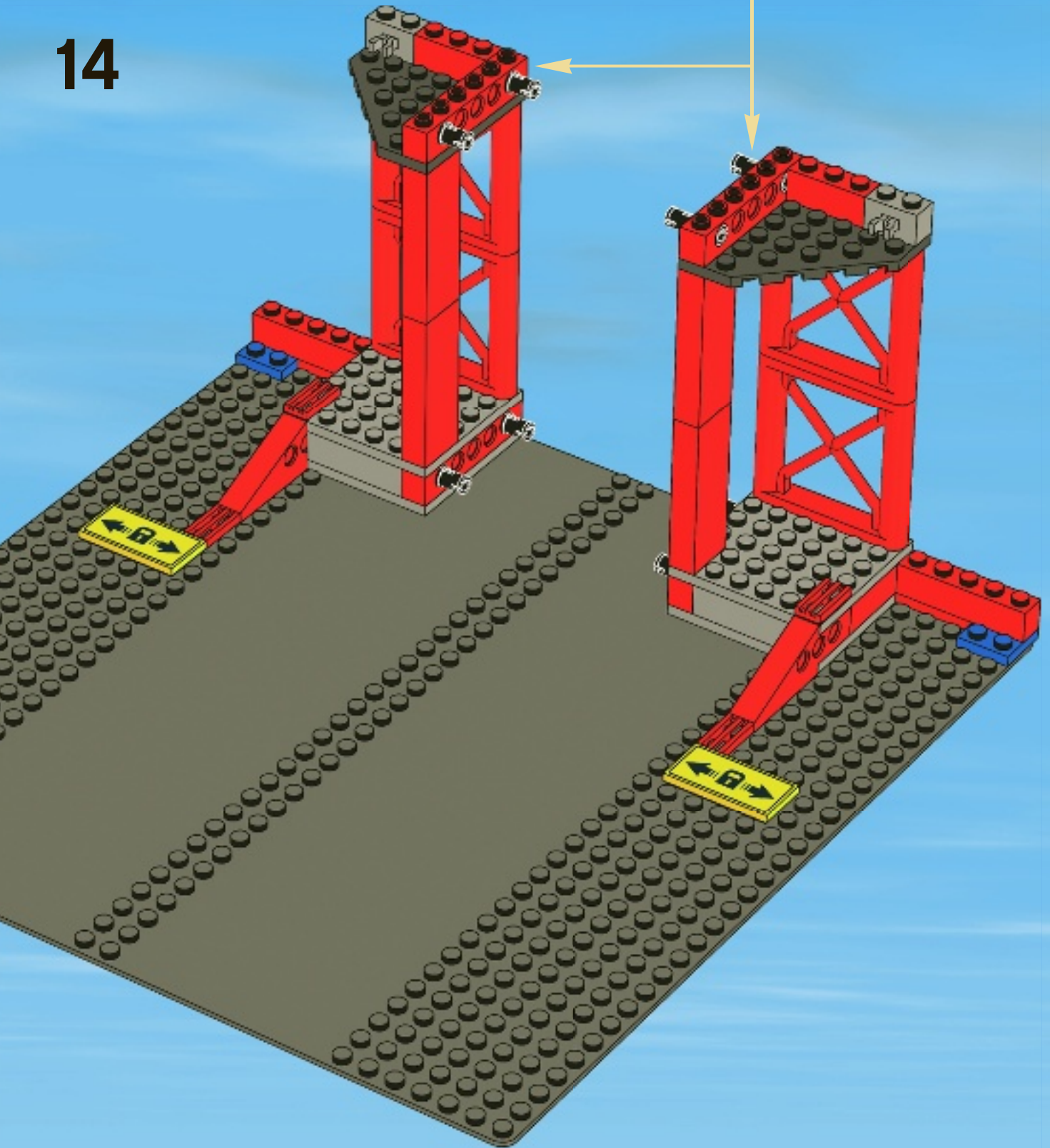
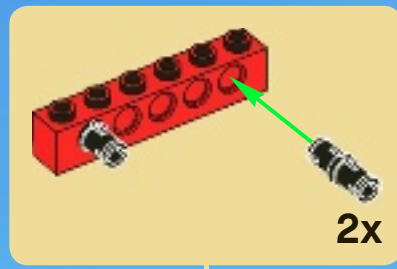

15

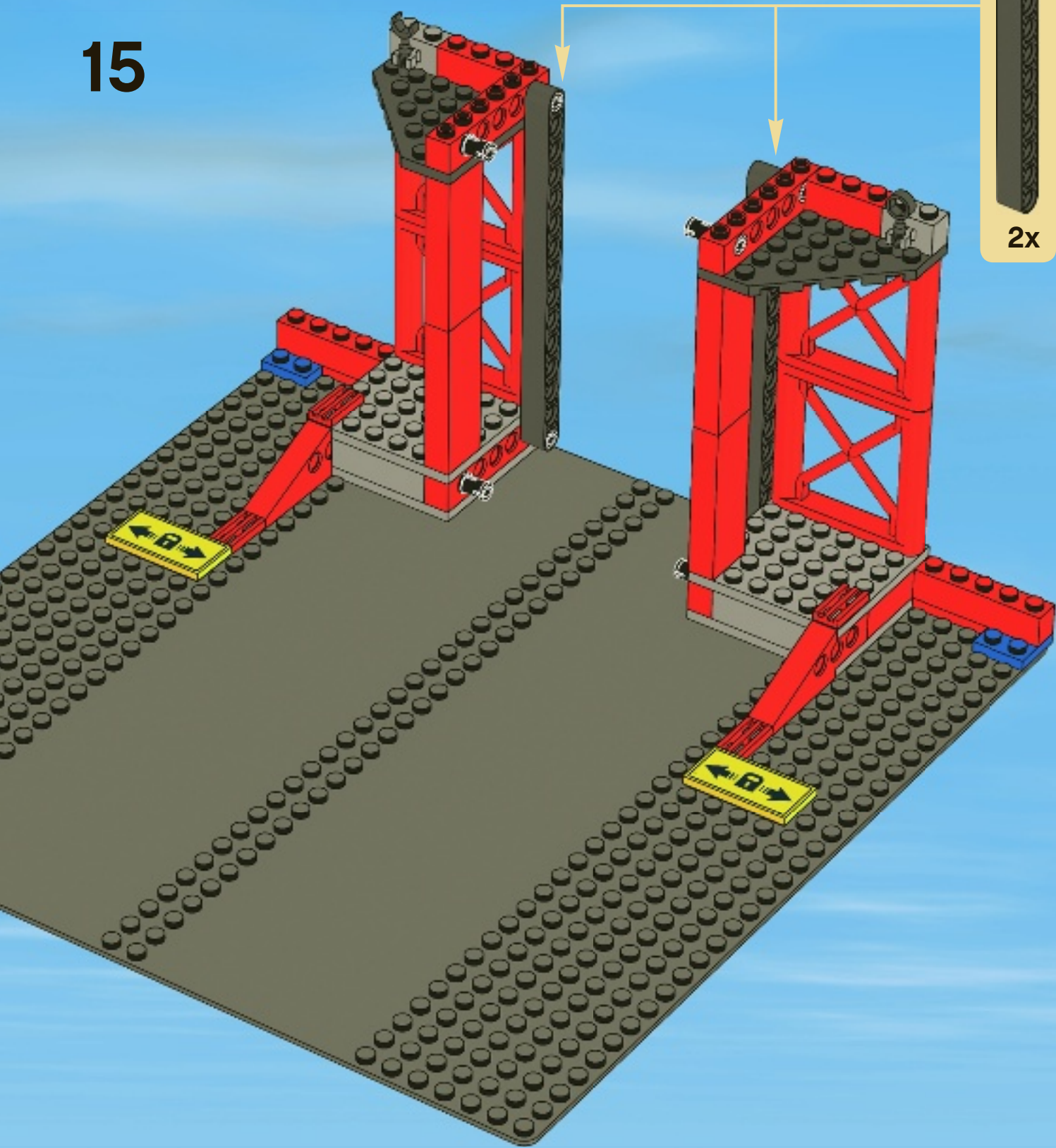

2x

16

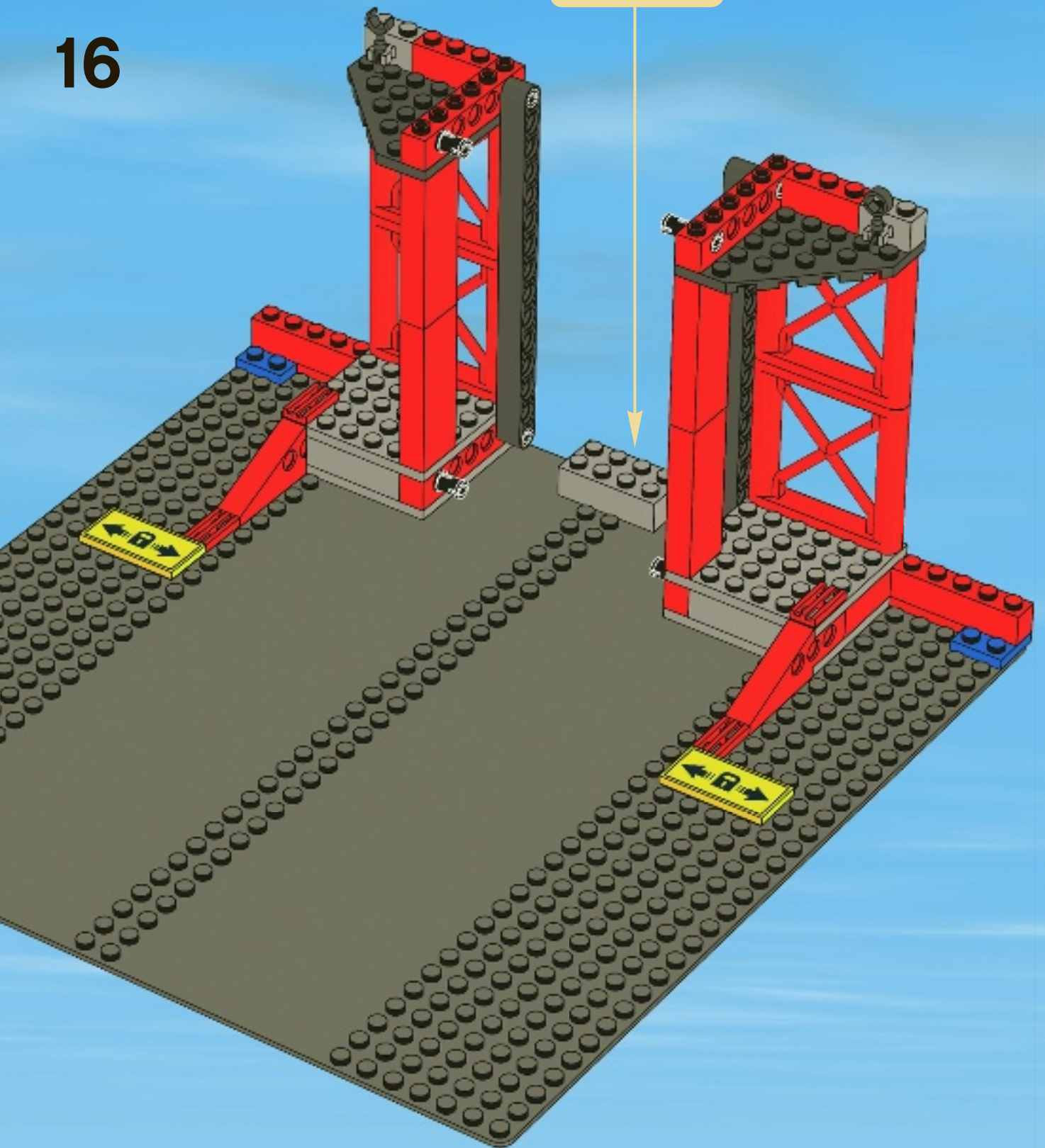
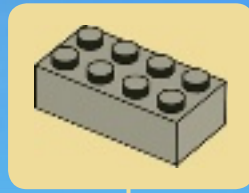

1



2



17

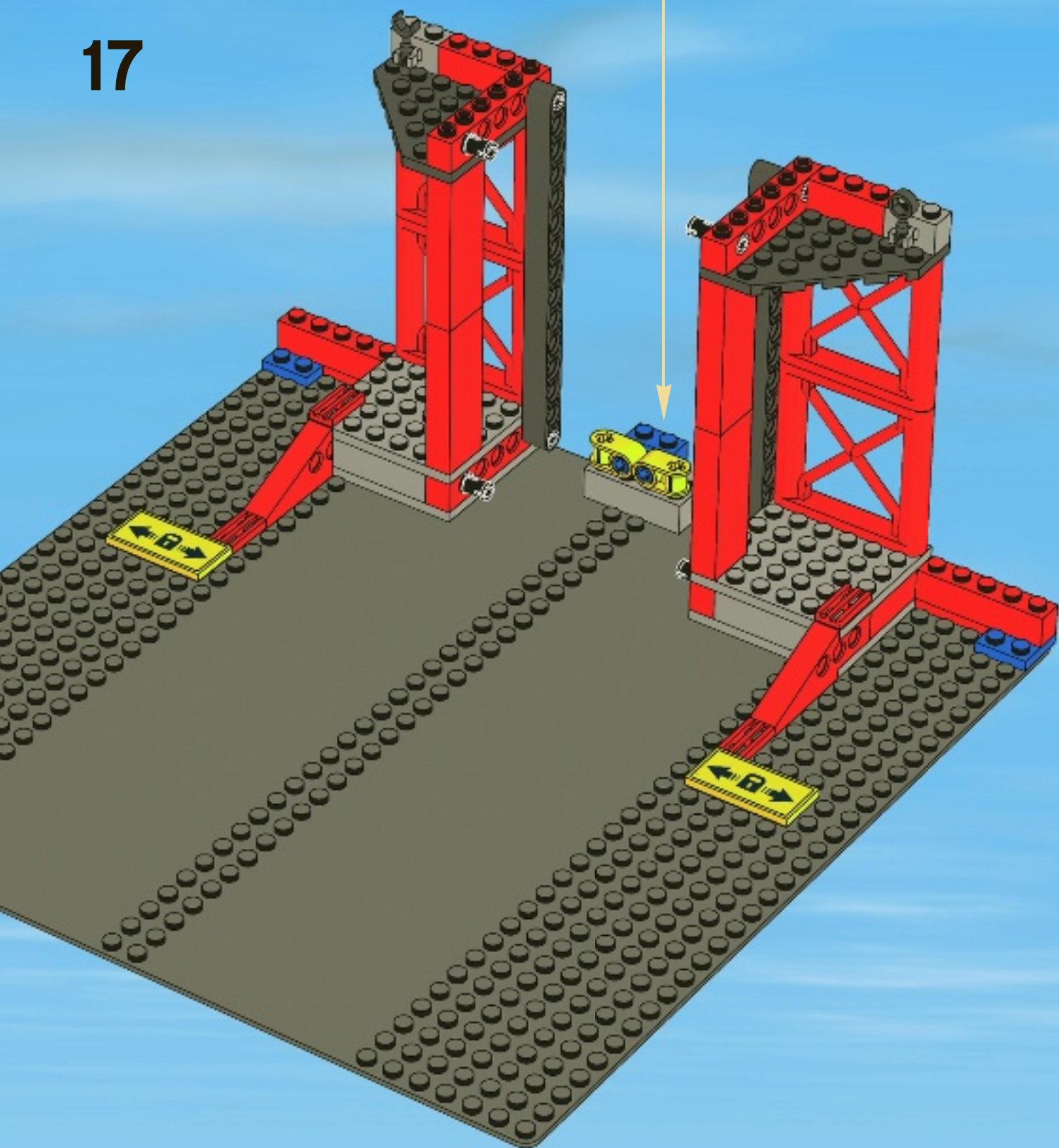

18

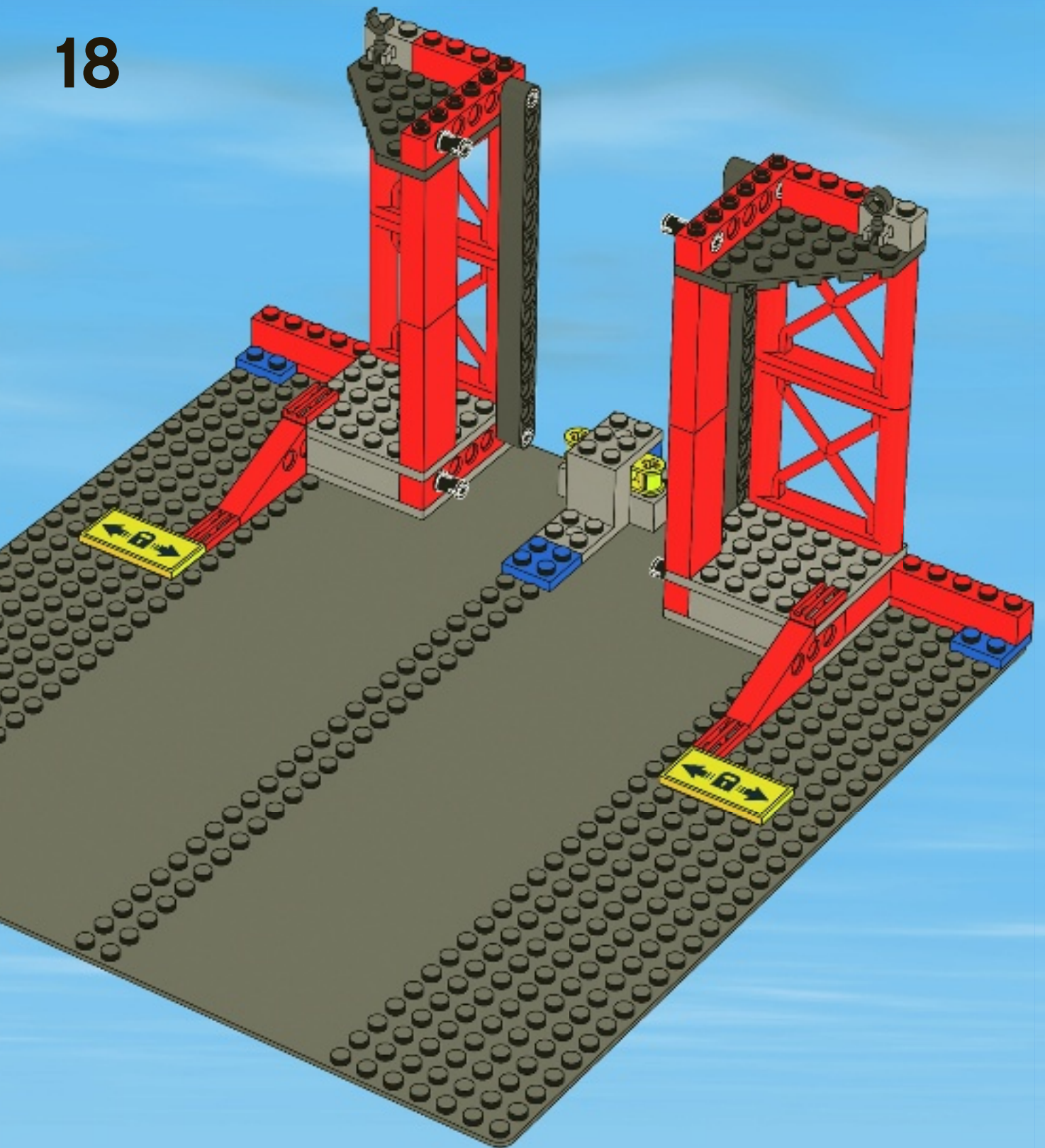

19

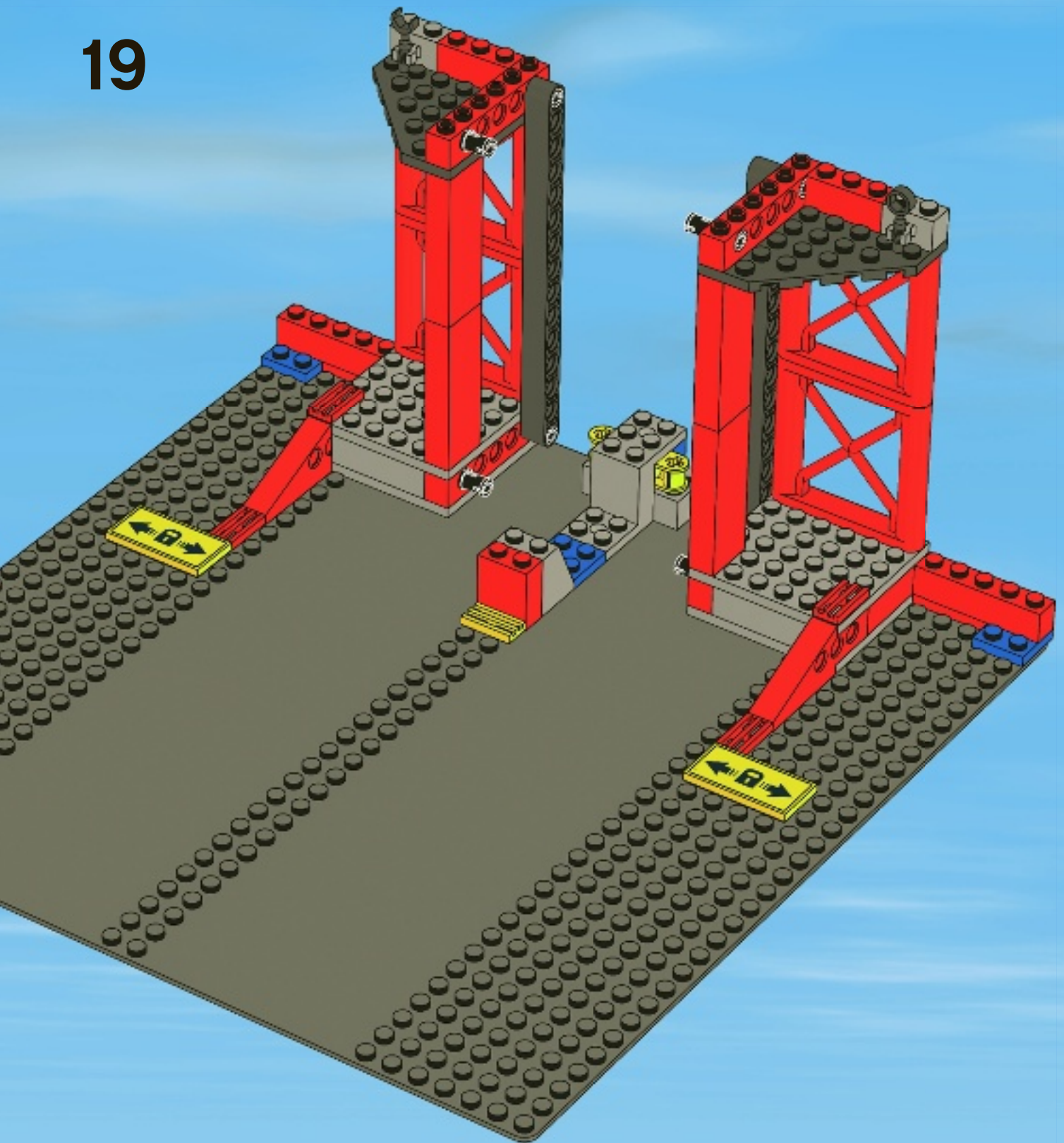

20

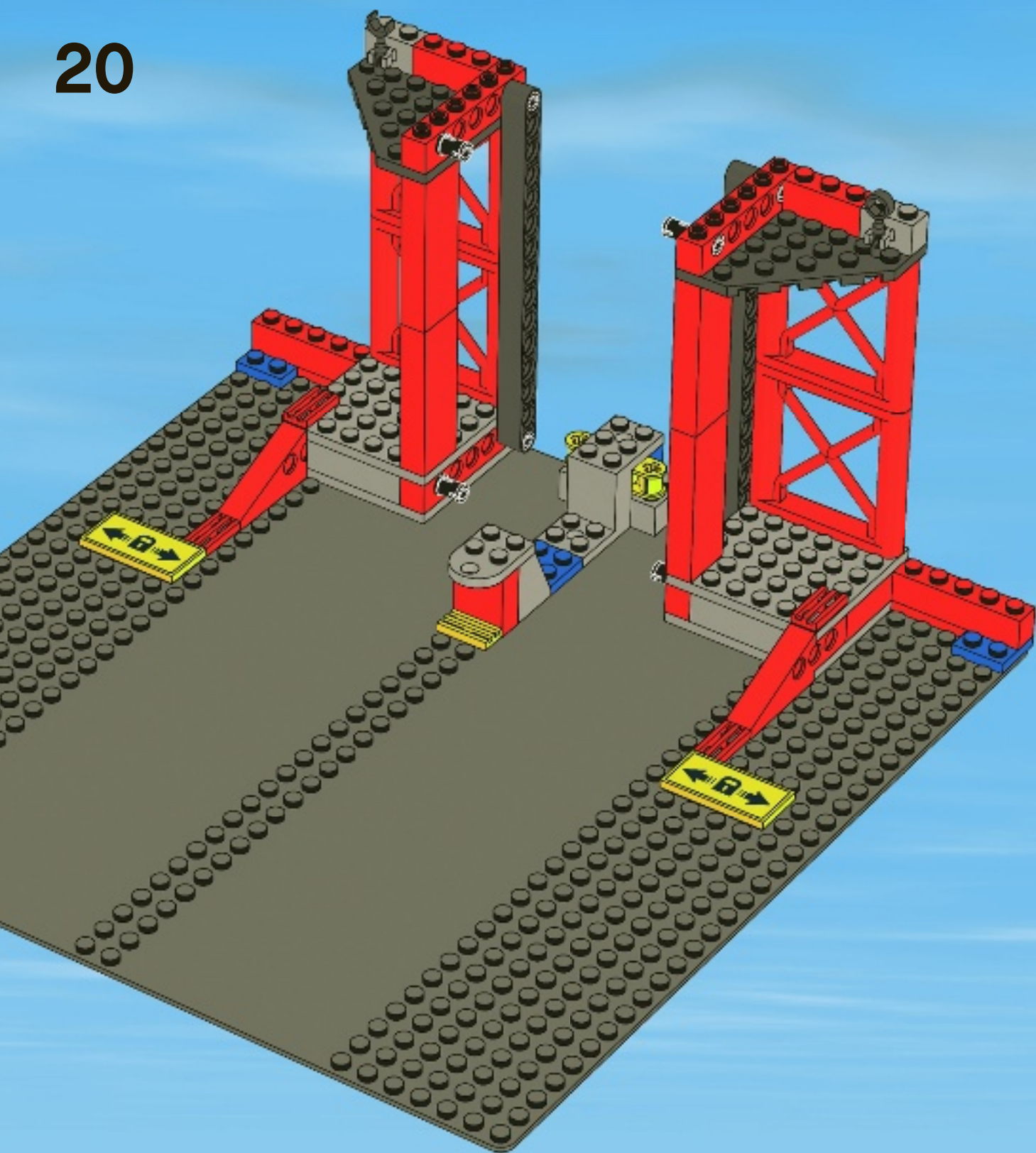

21

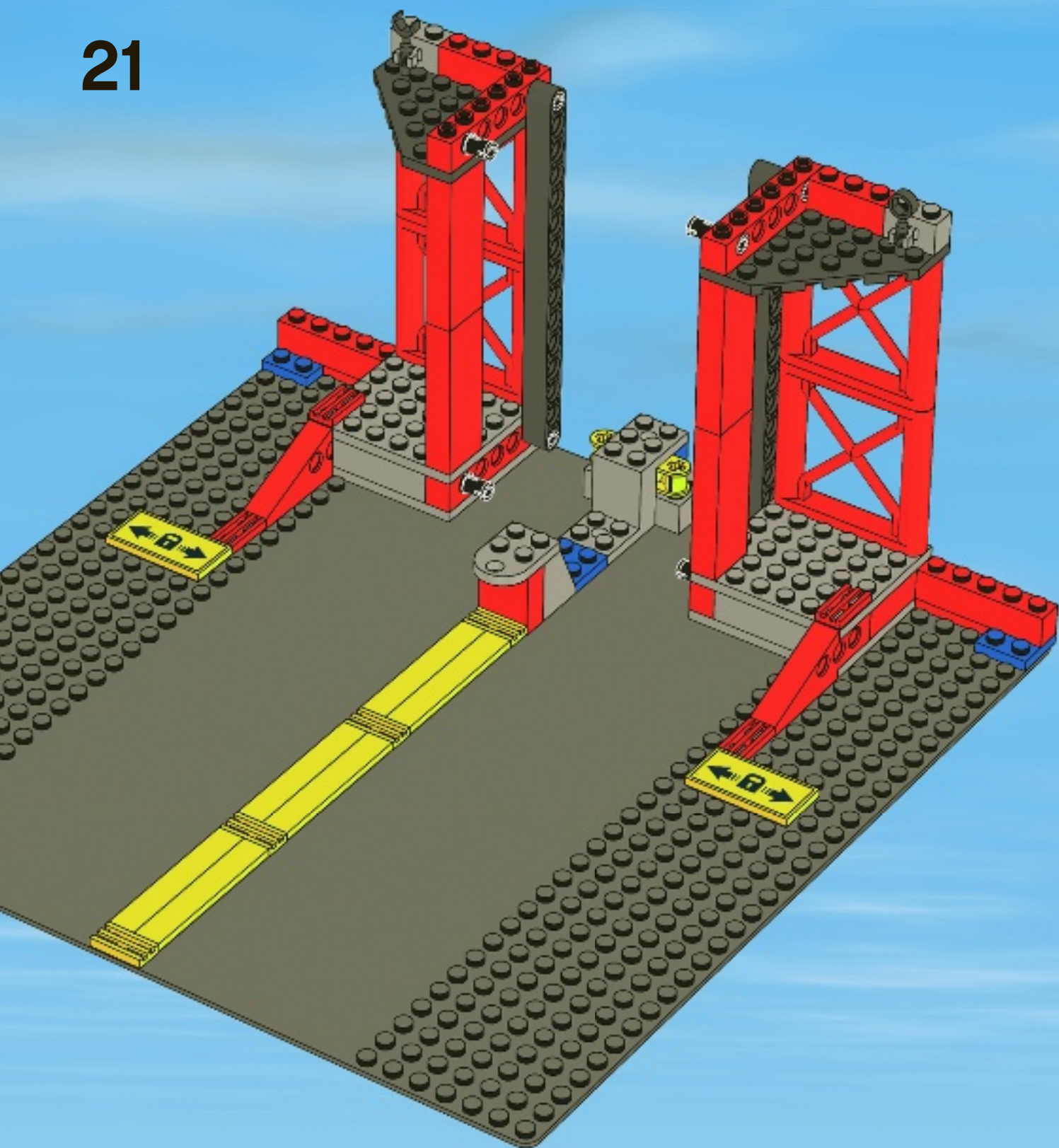

22

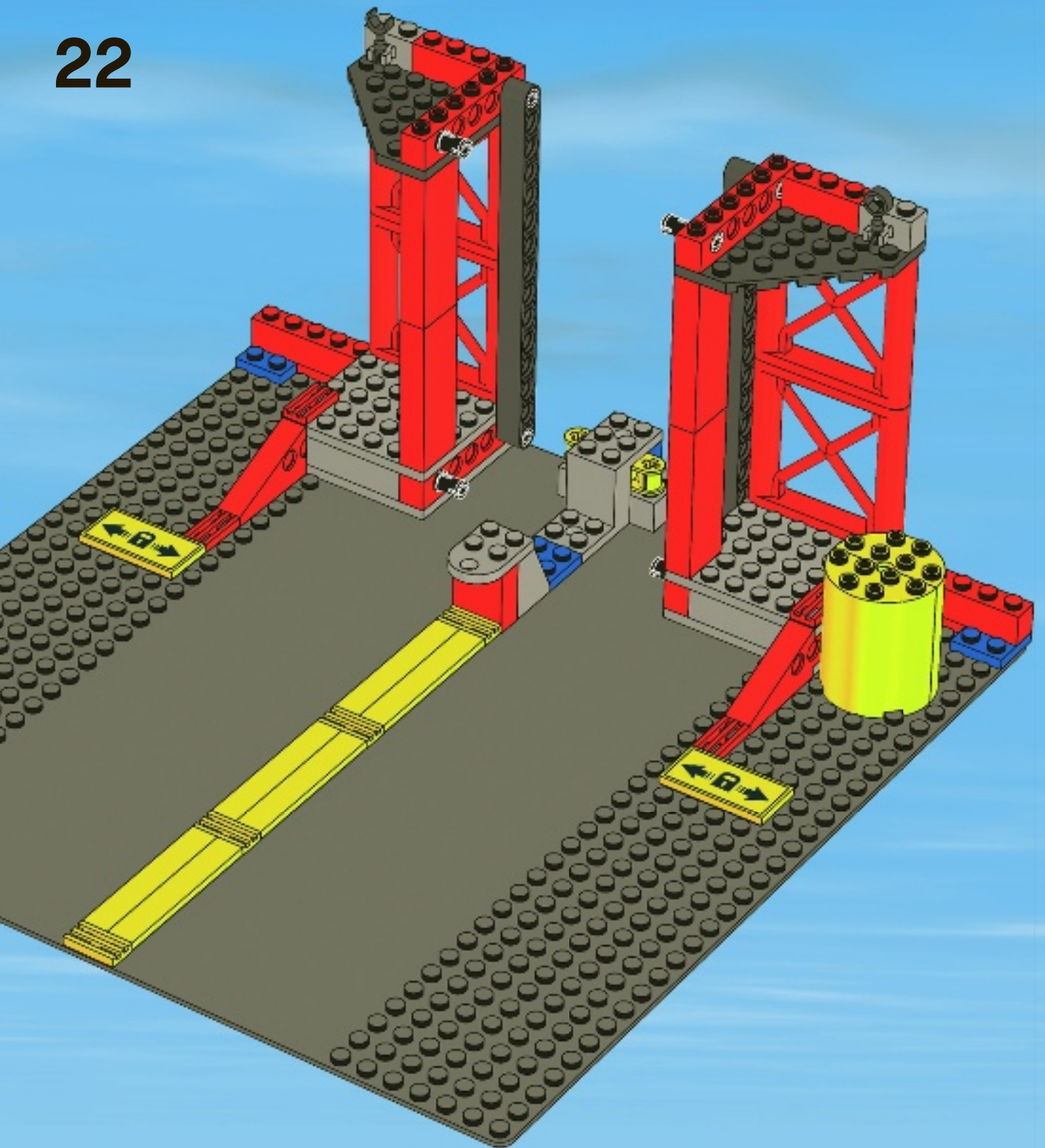

23

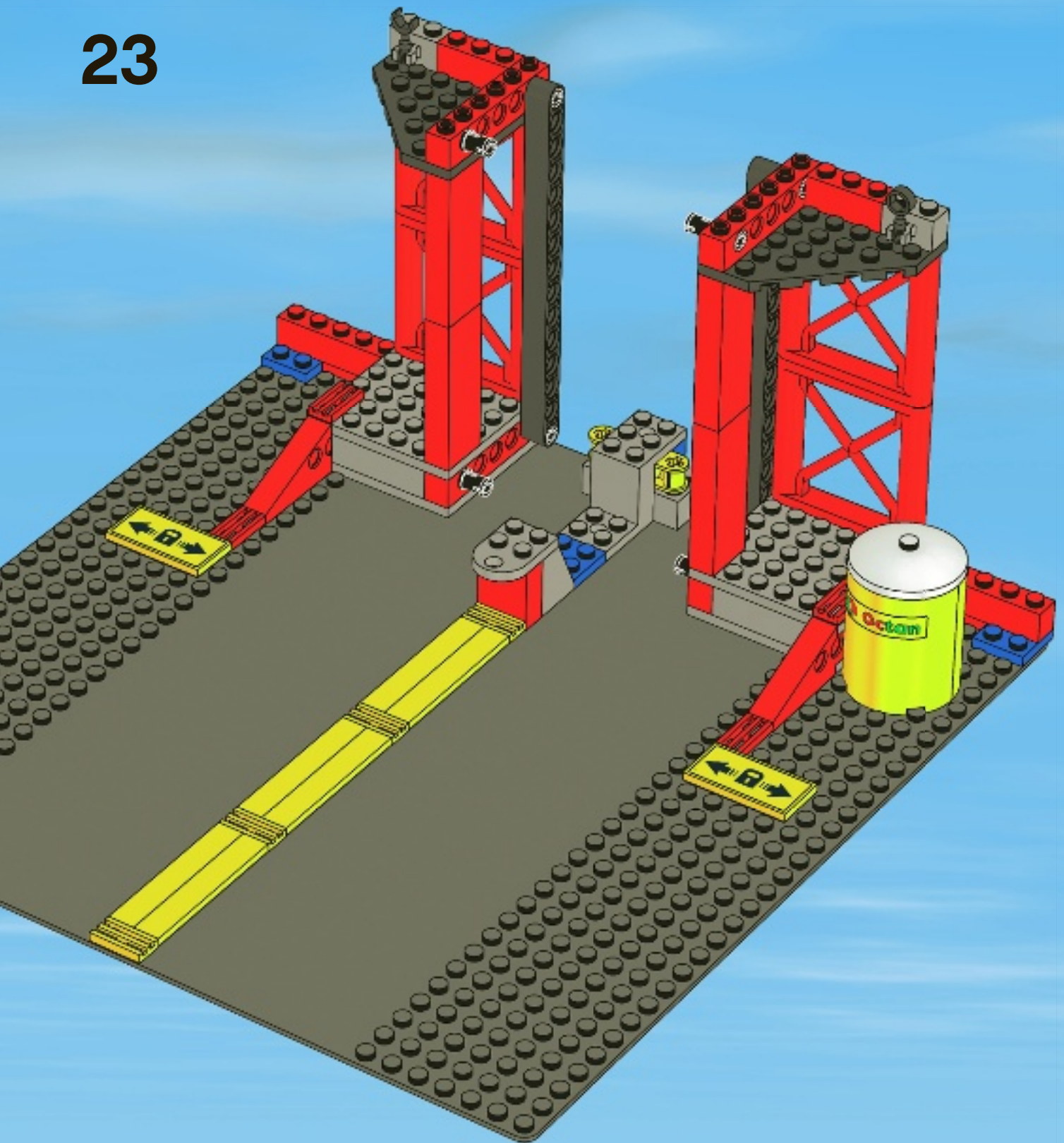



24

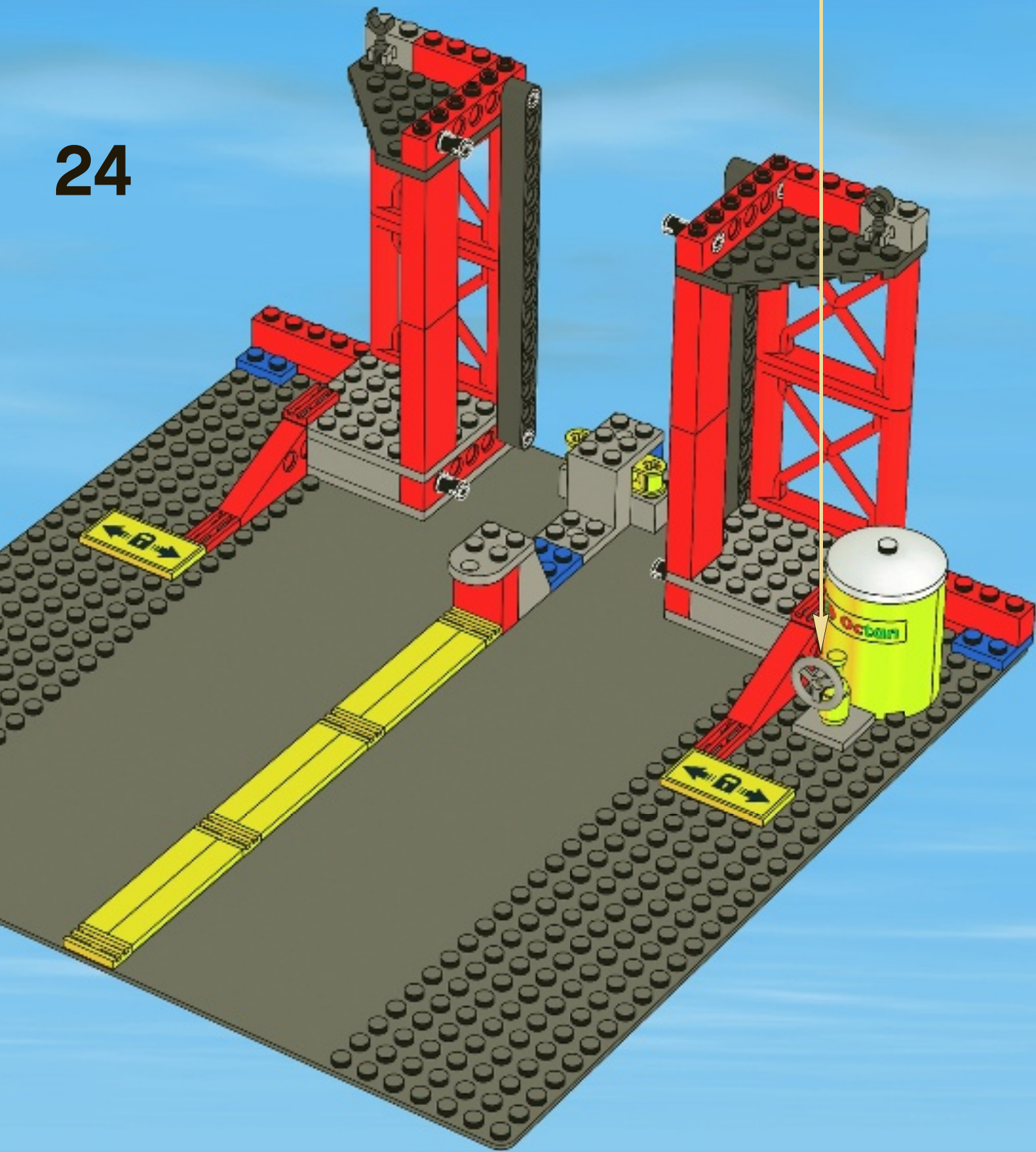

1

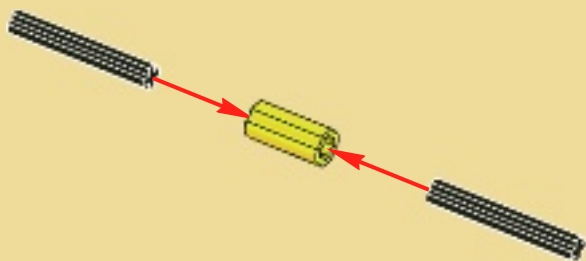

2

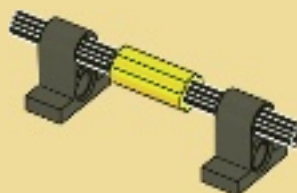

2x

25

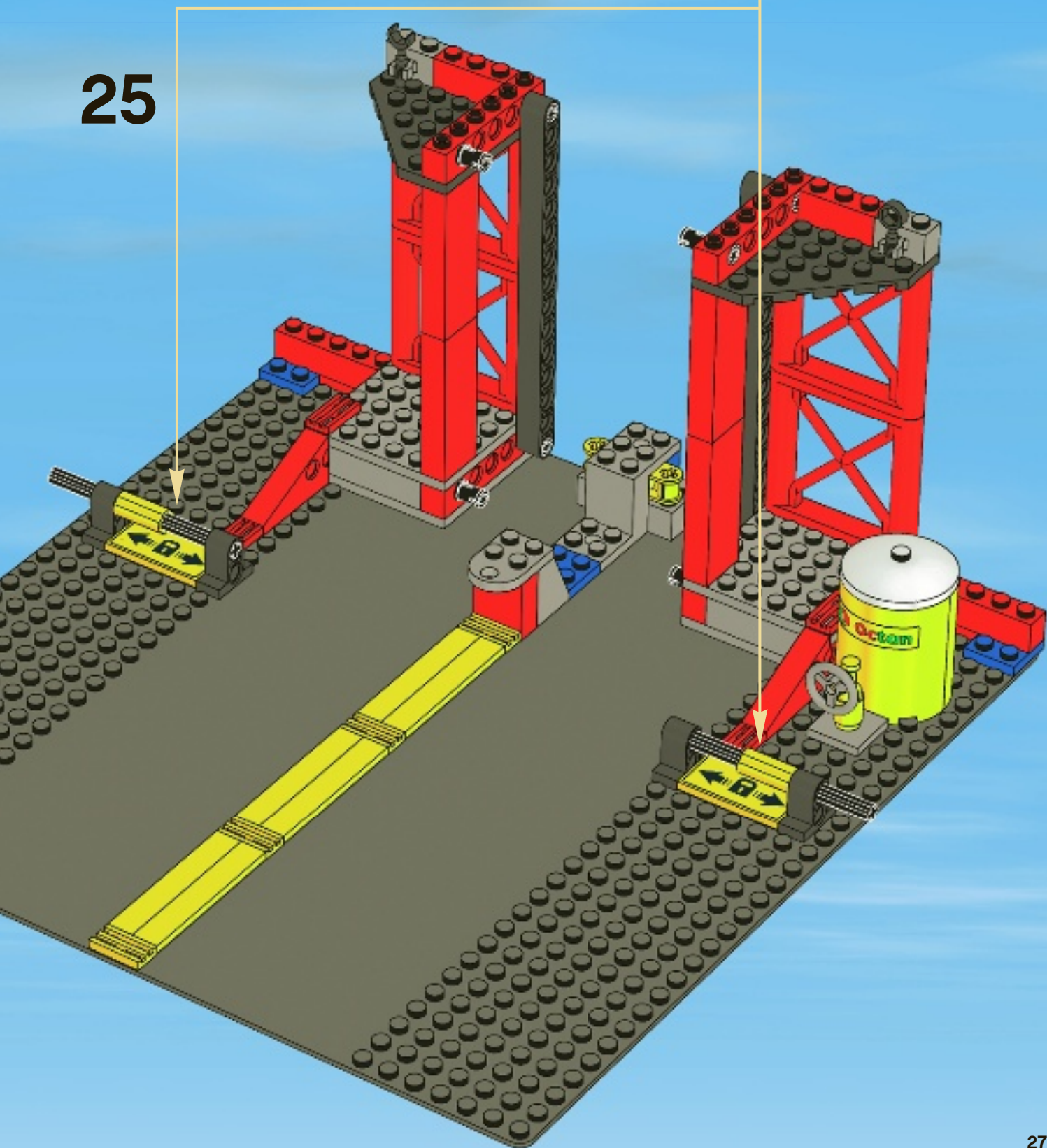

27

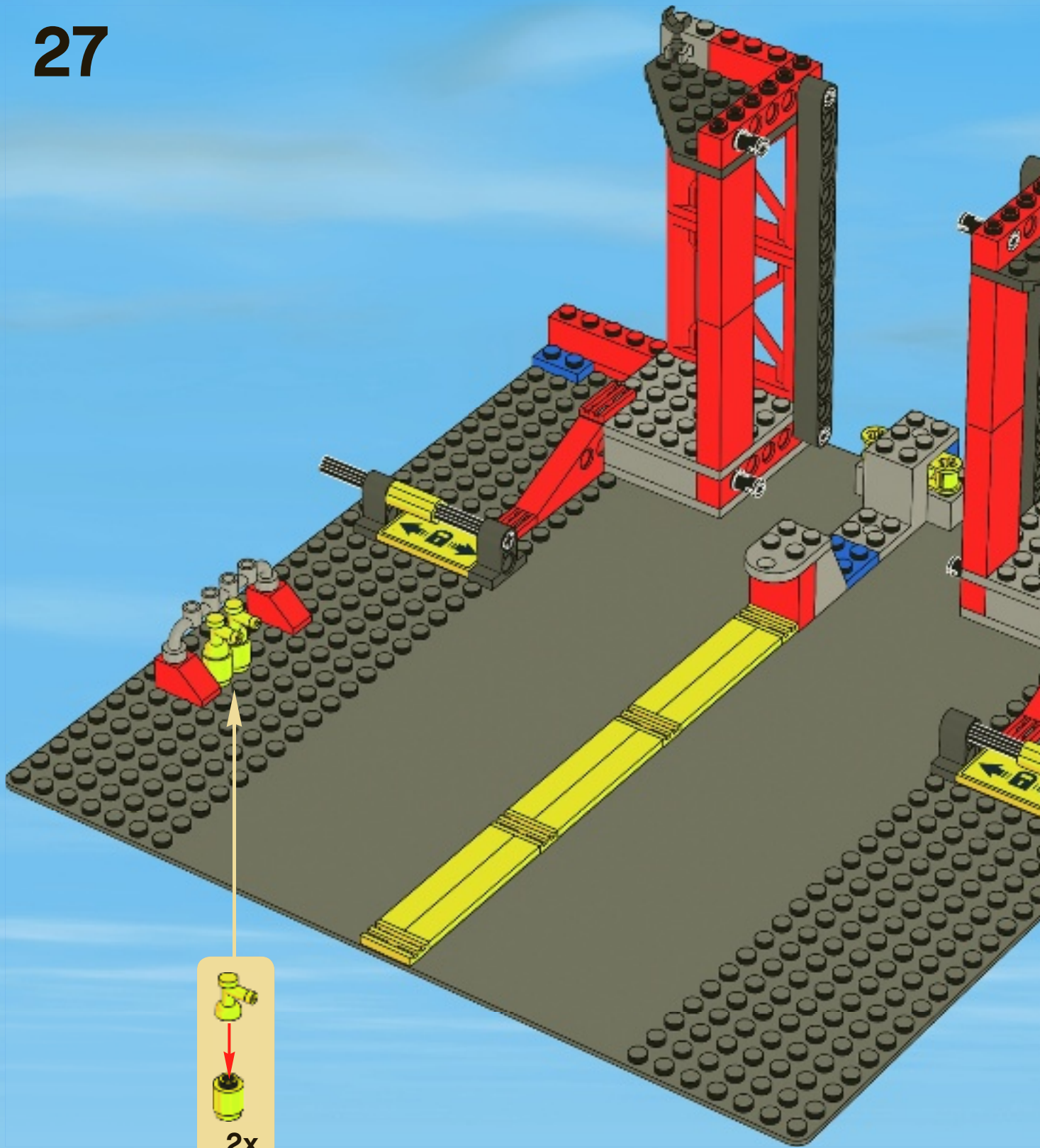

2x

28

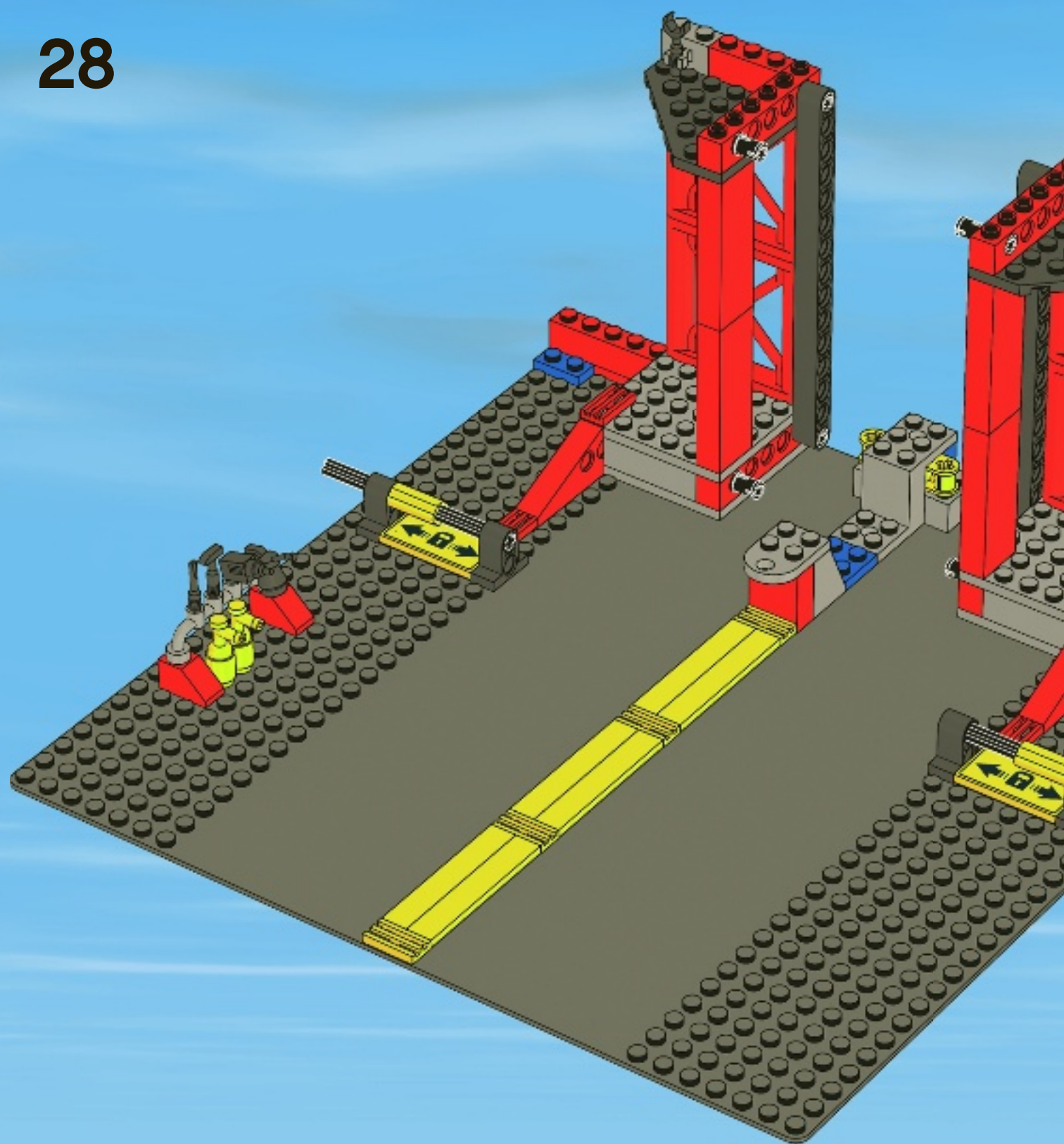

29

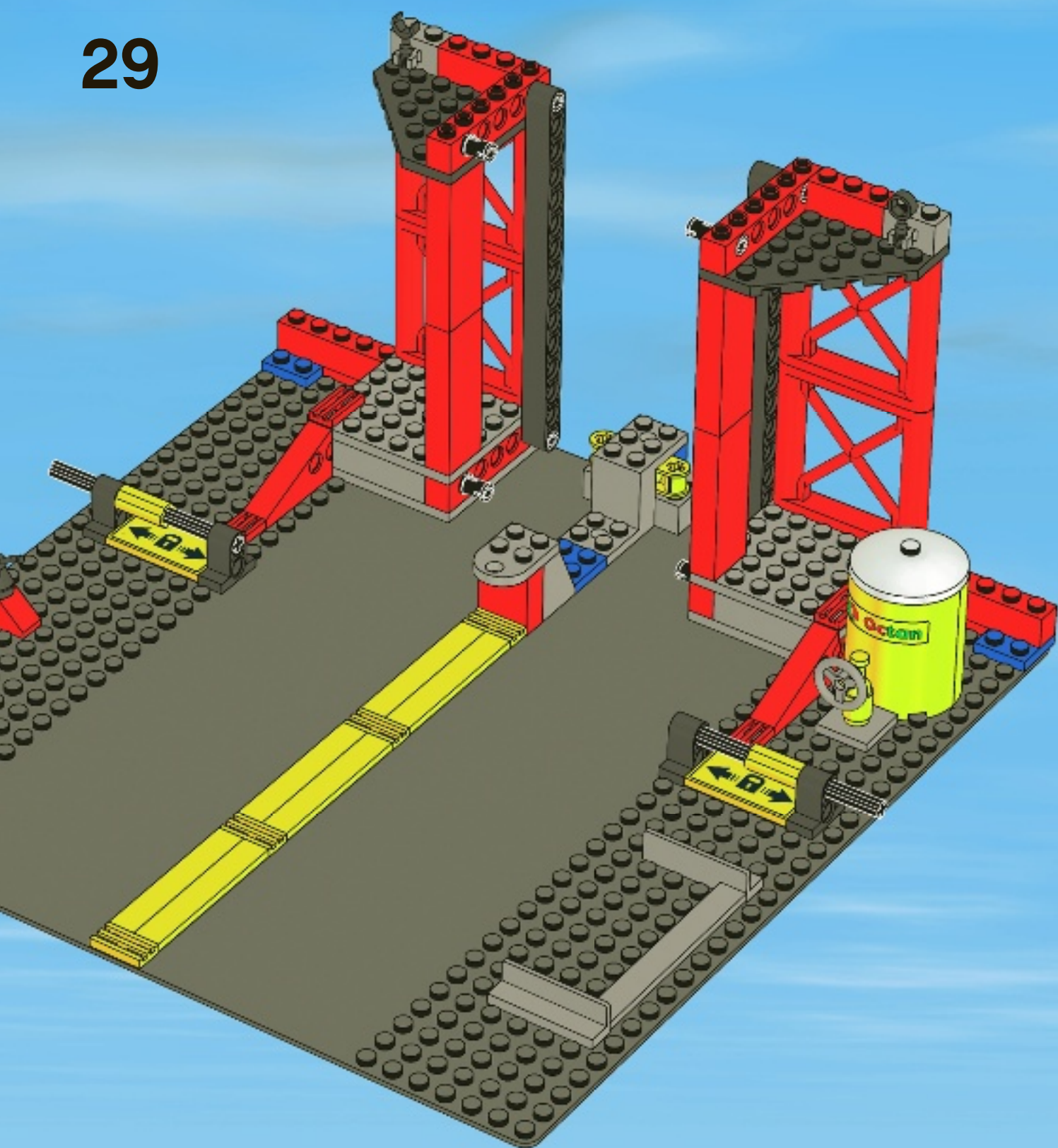

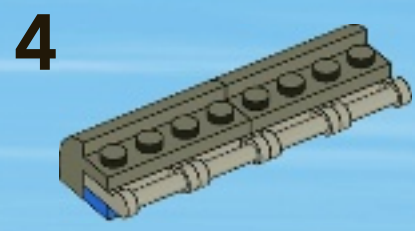
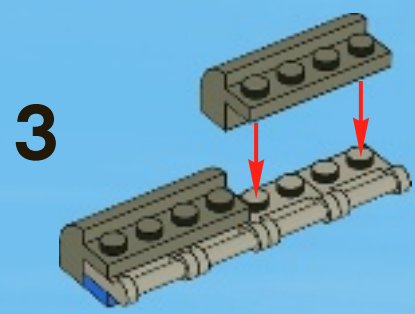
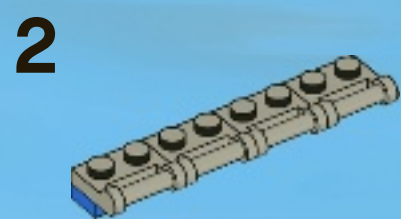
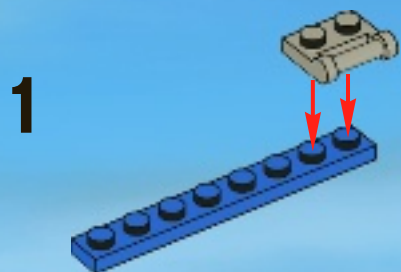

30

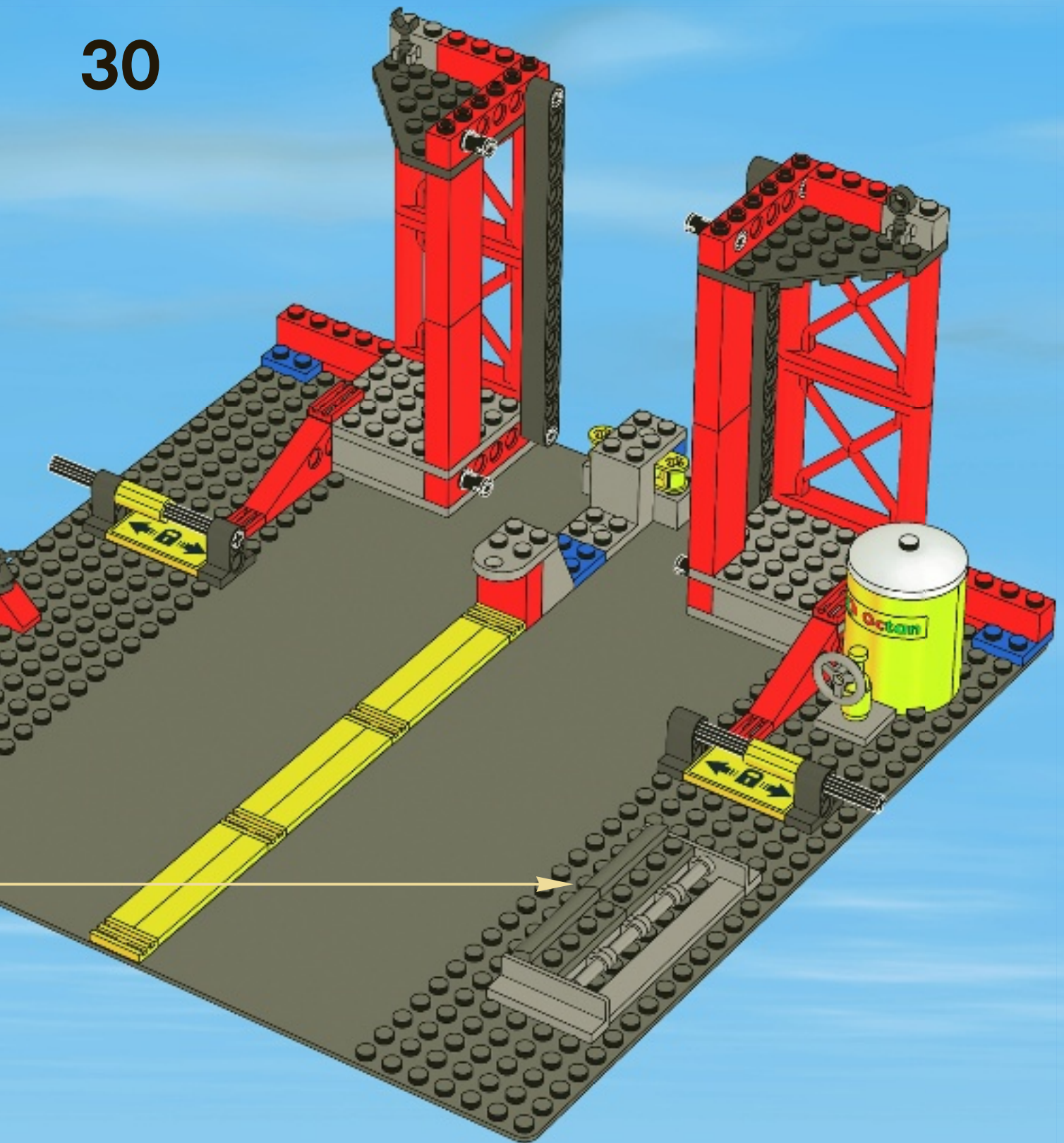

31

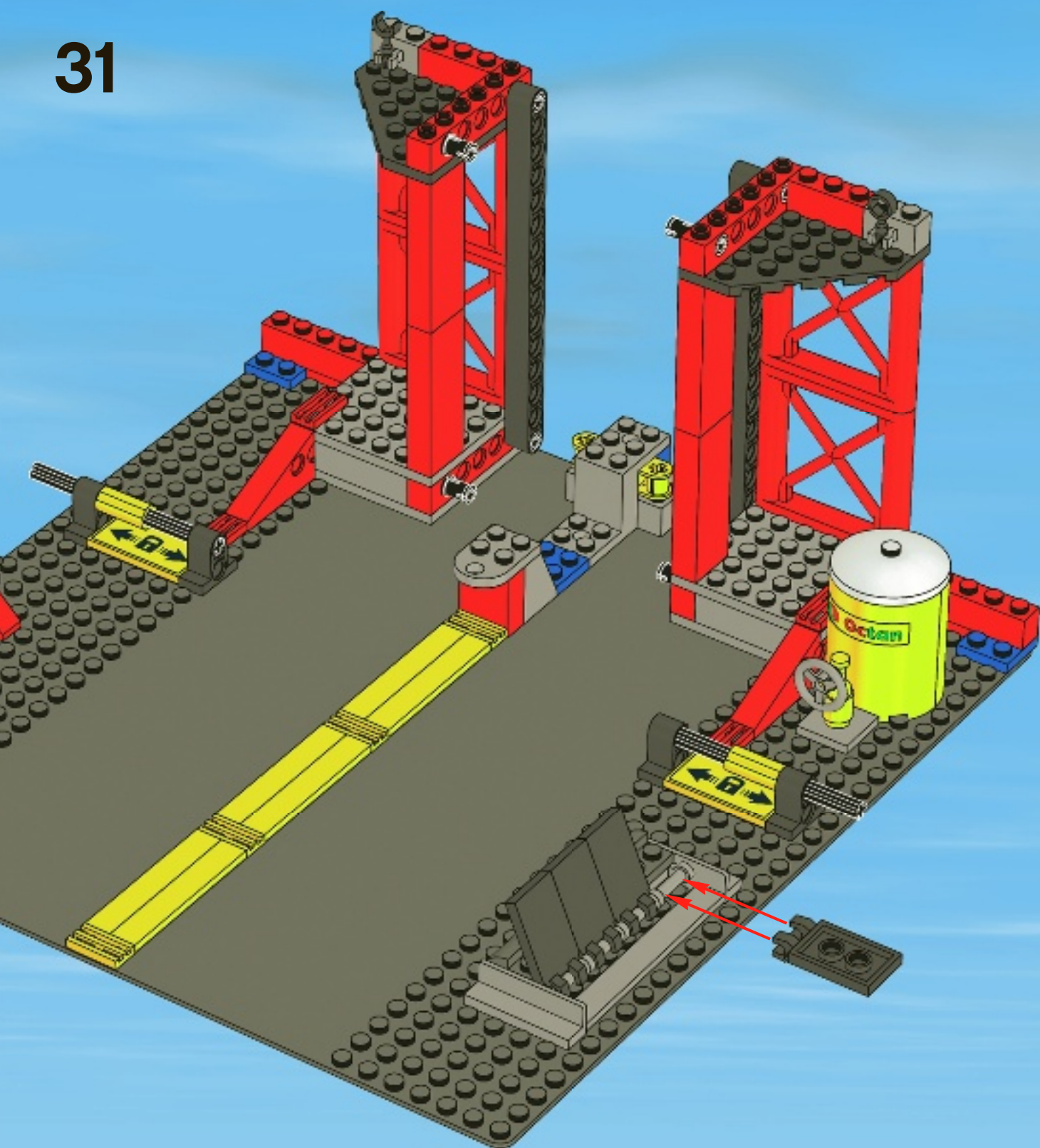

32

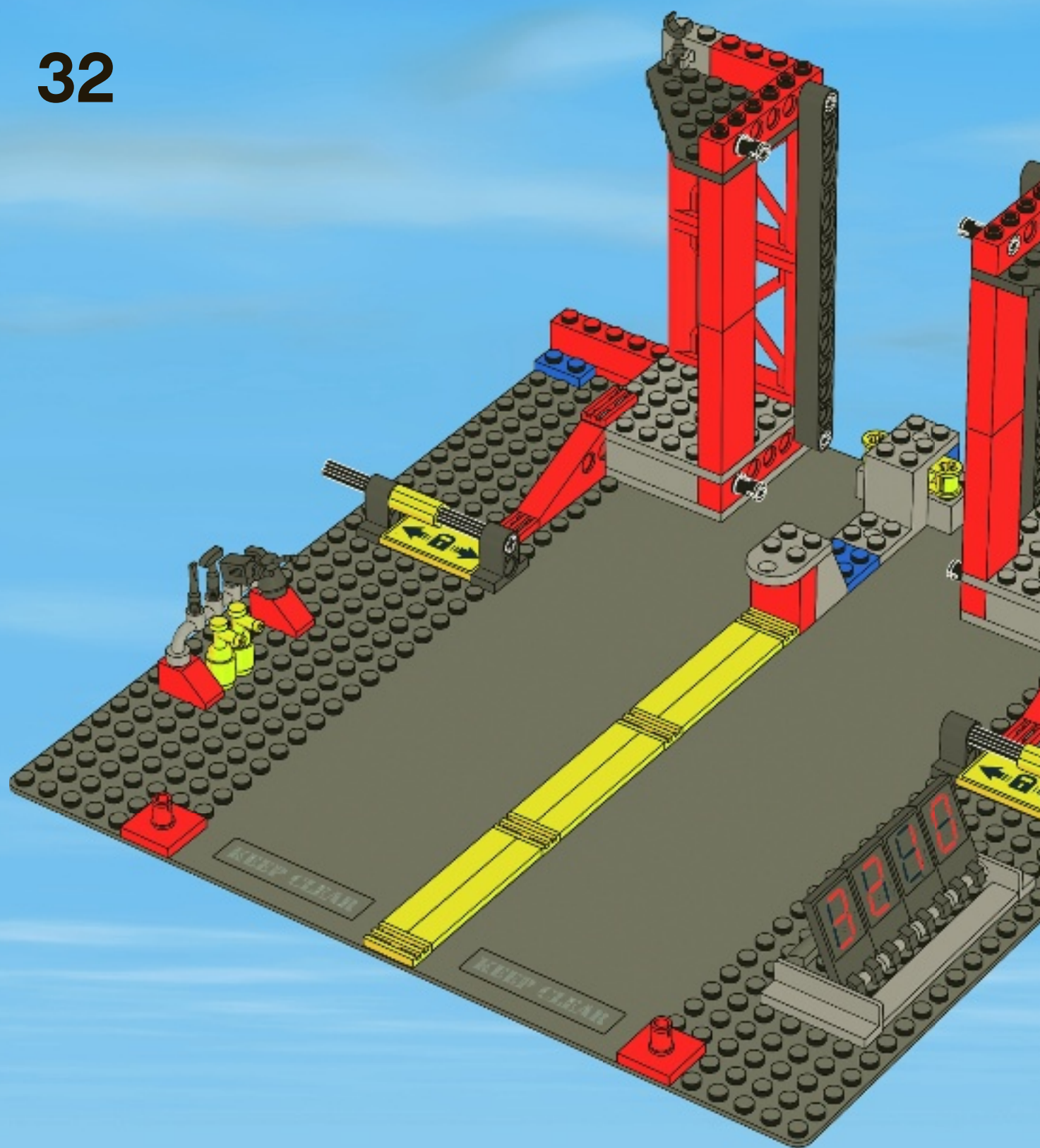

1

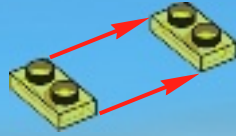

2



3

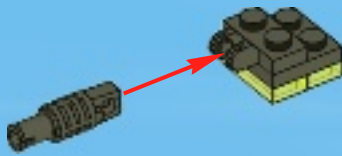

4

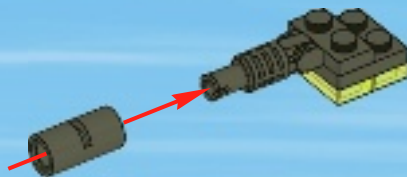

2x

33

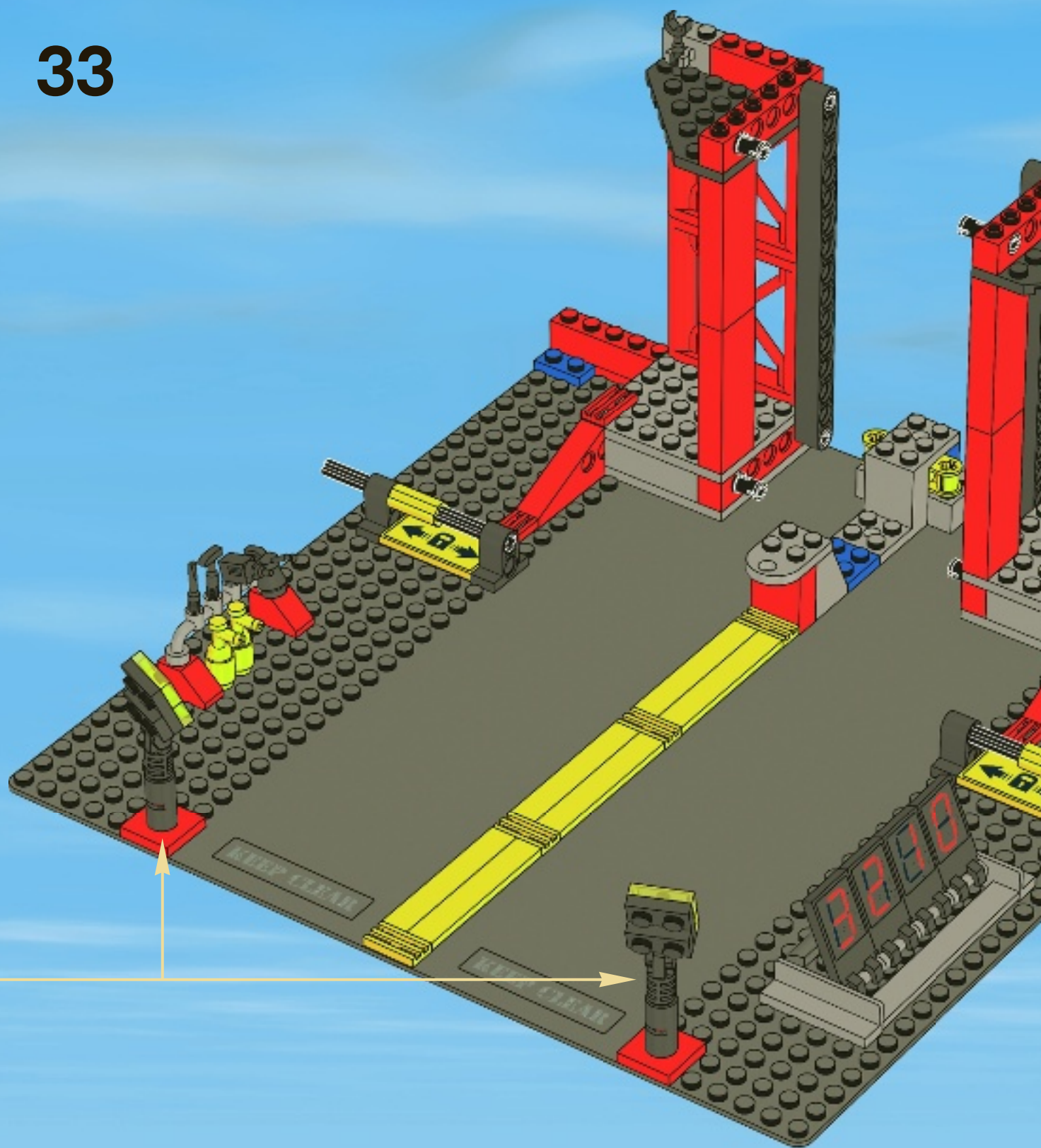



+

4



34

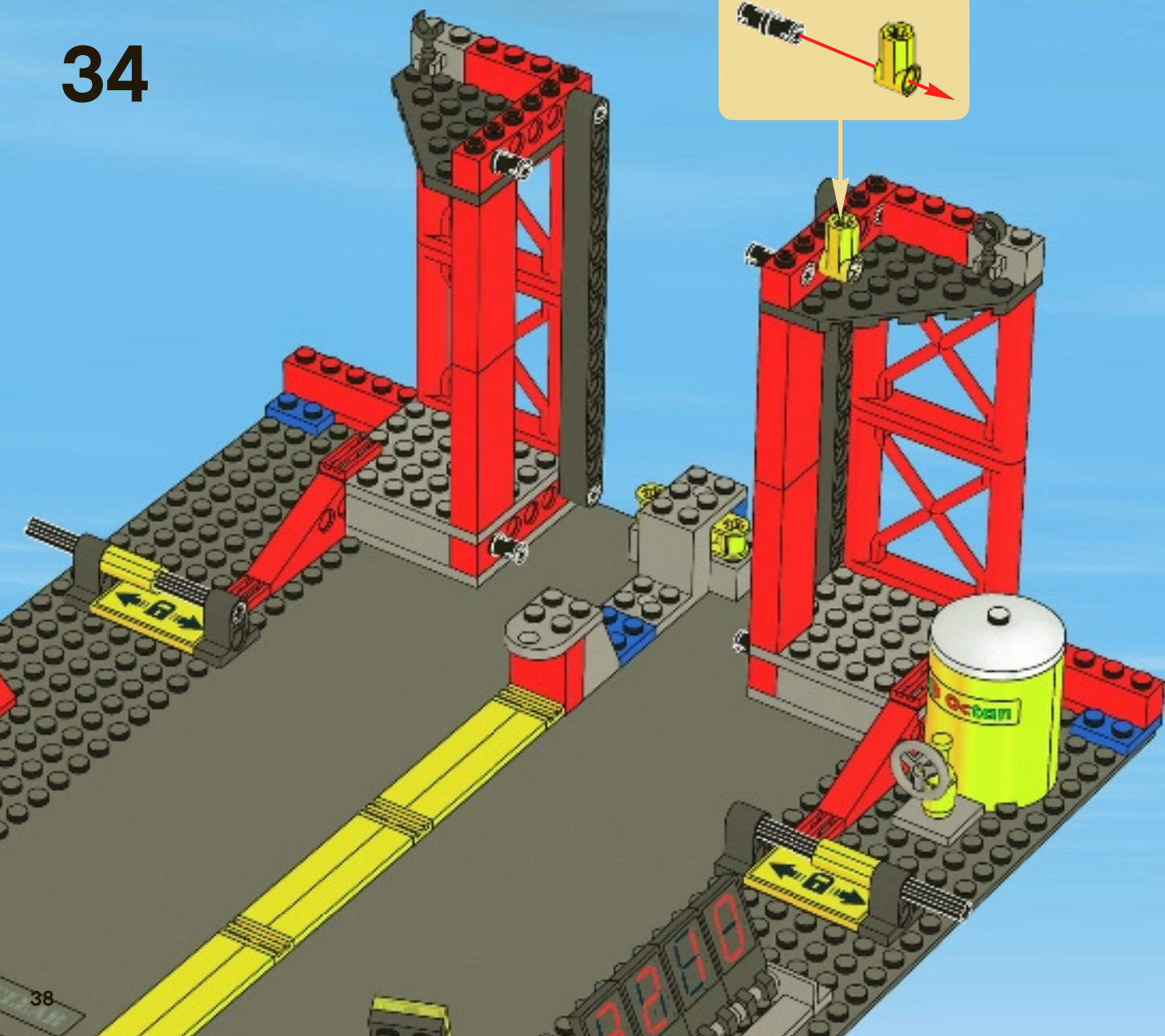
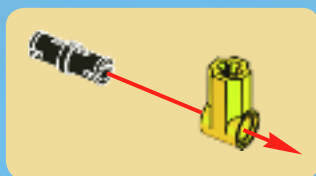

35

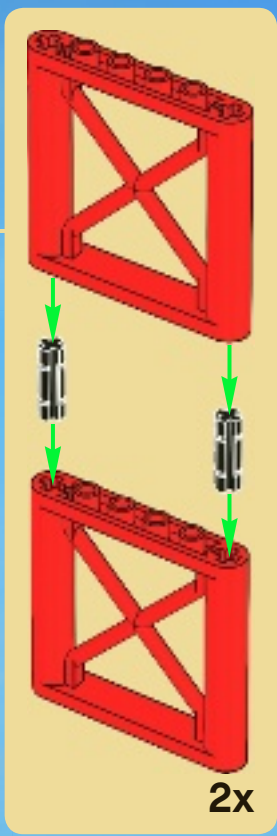

36

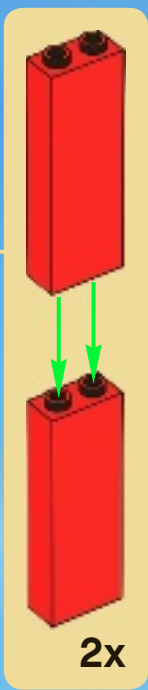
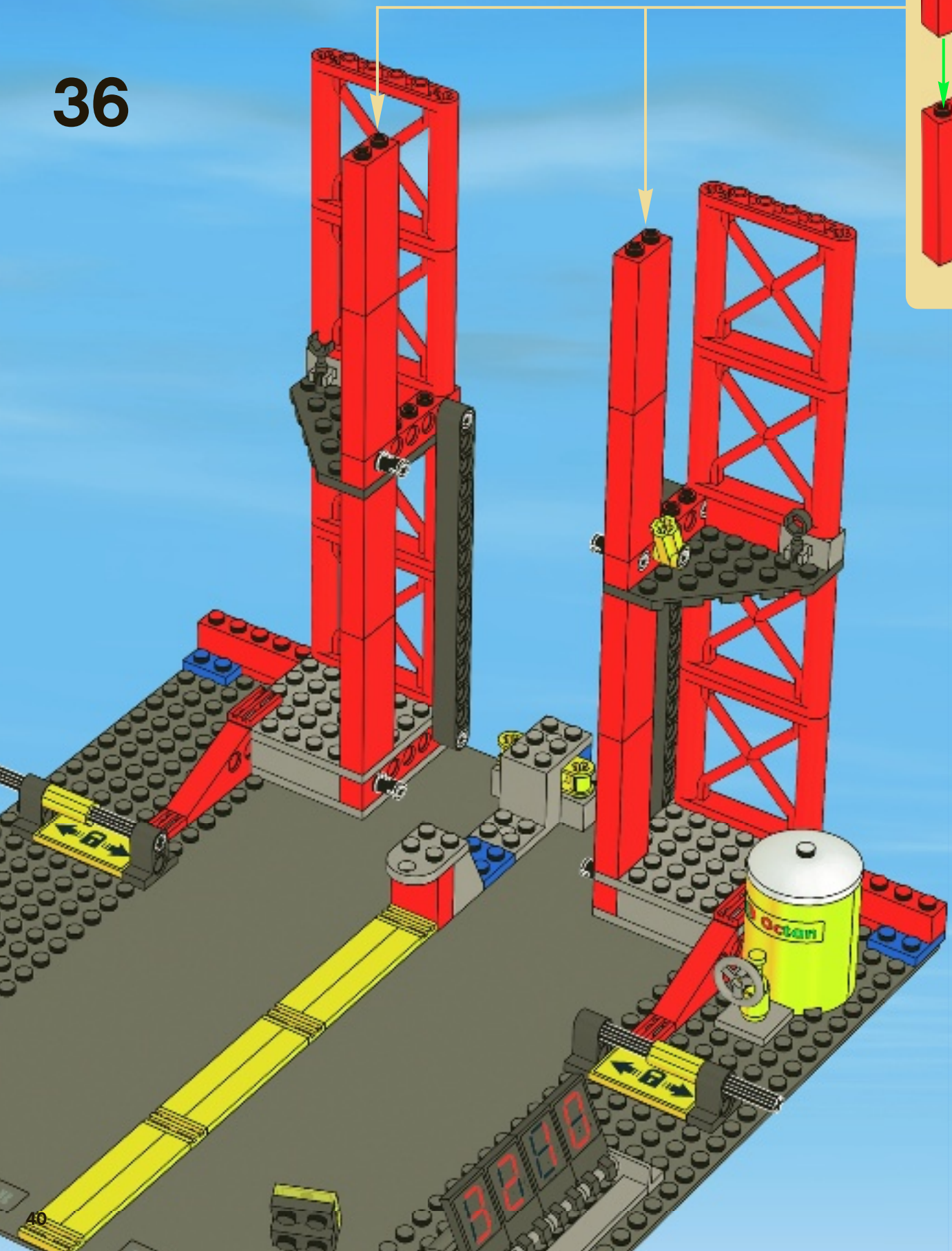

2x

37

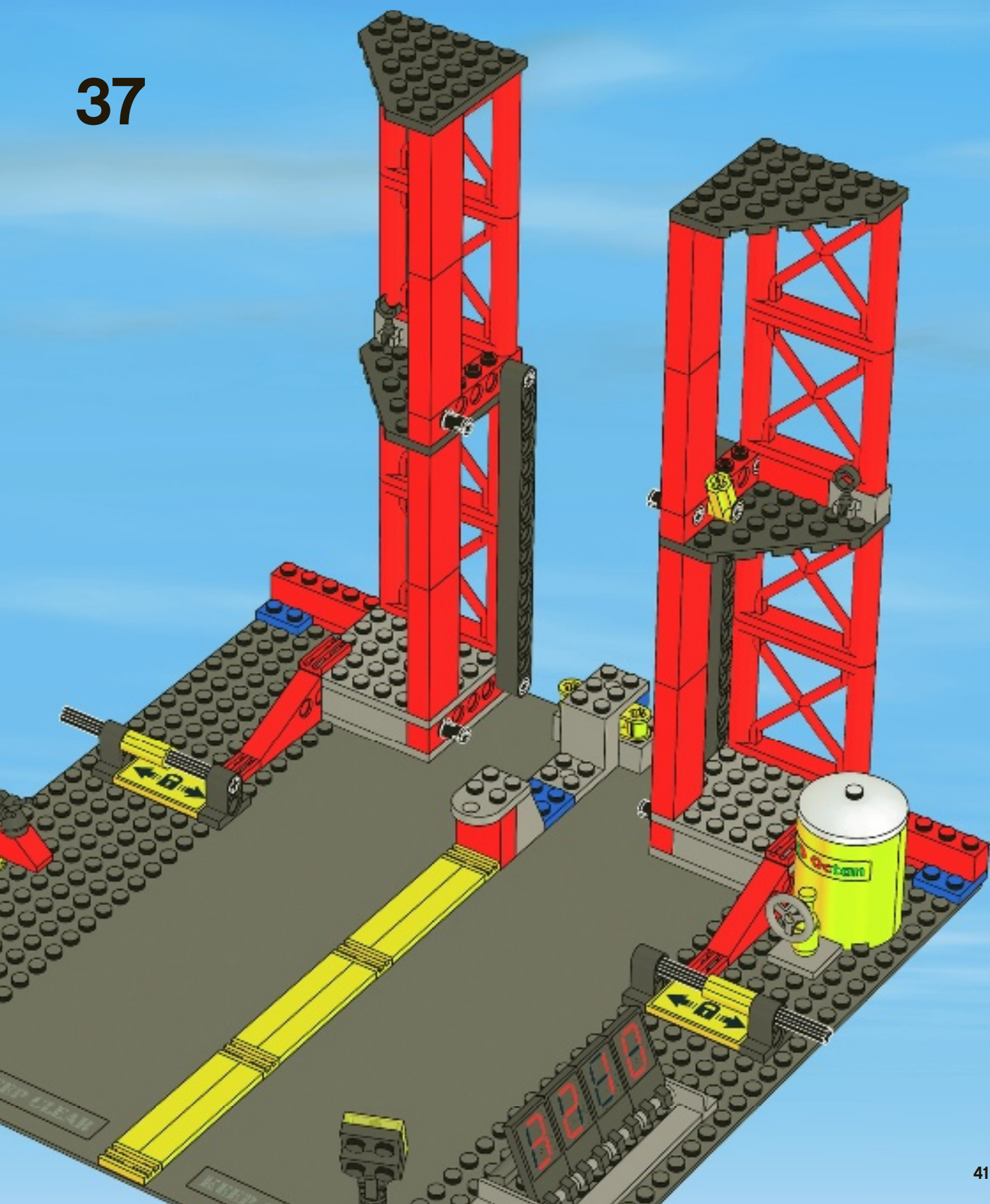

39

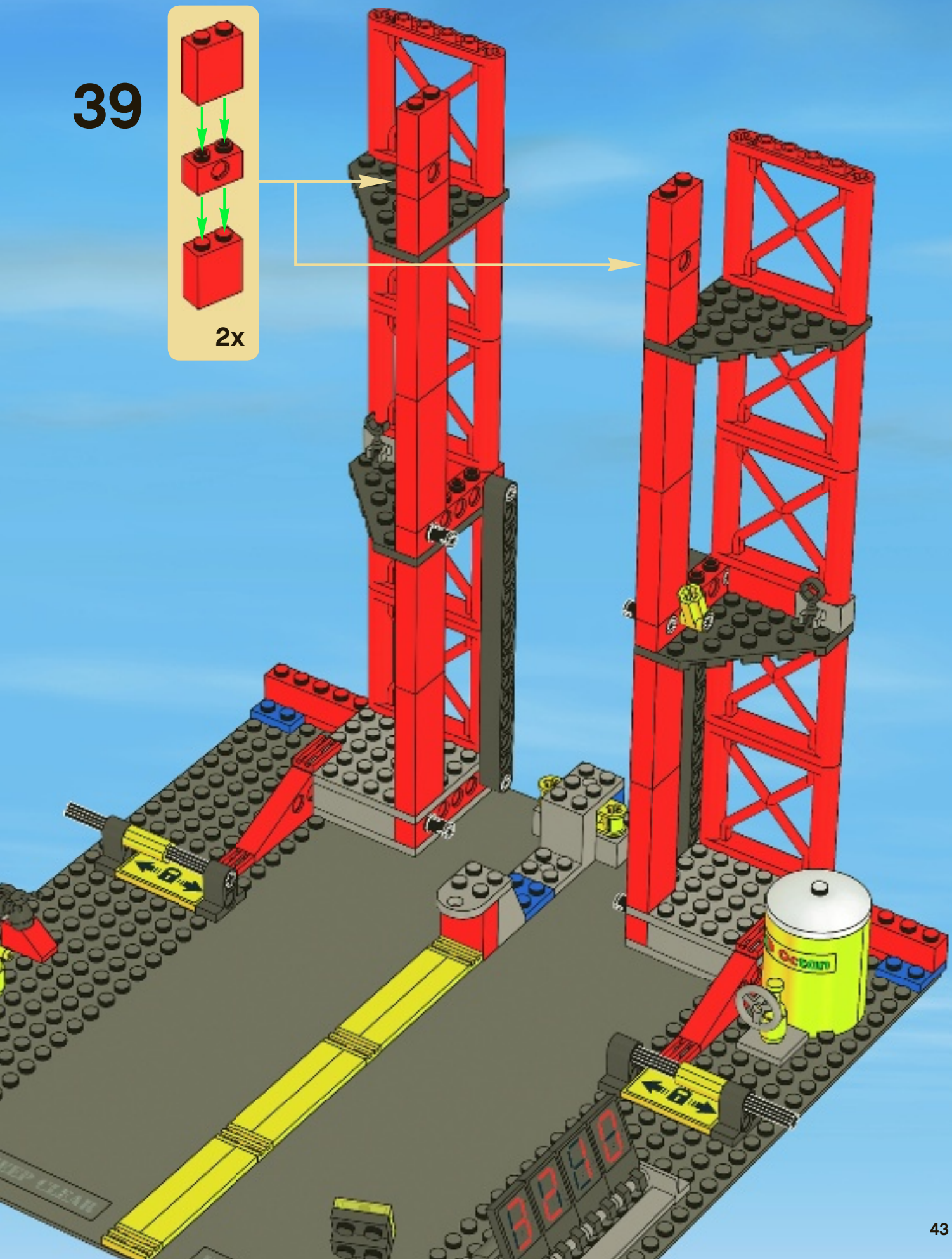
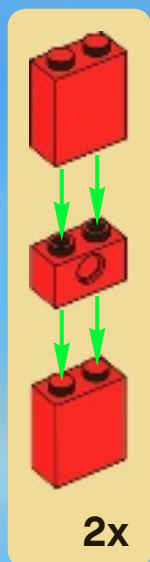

40

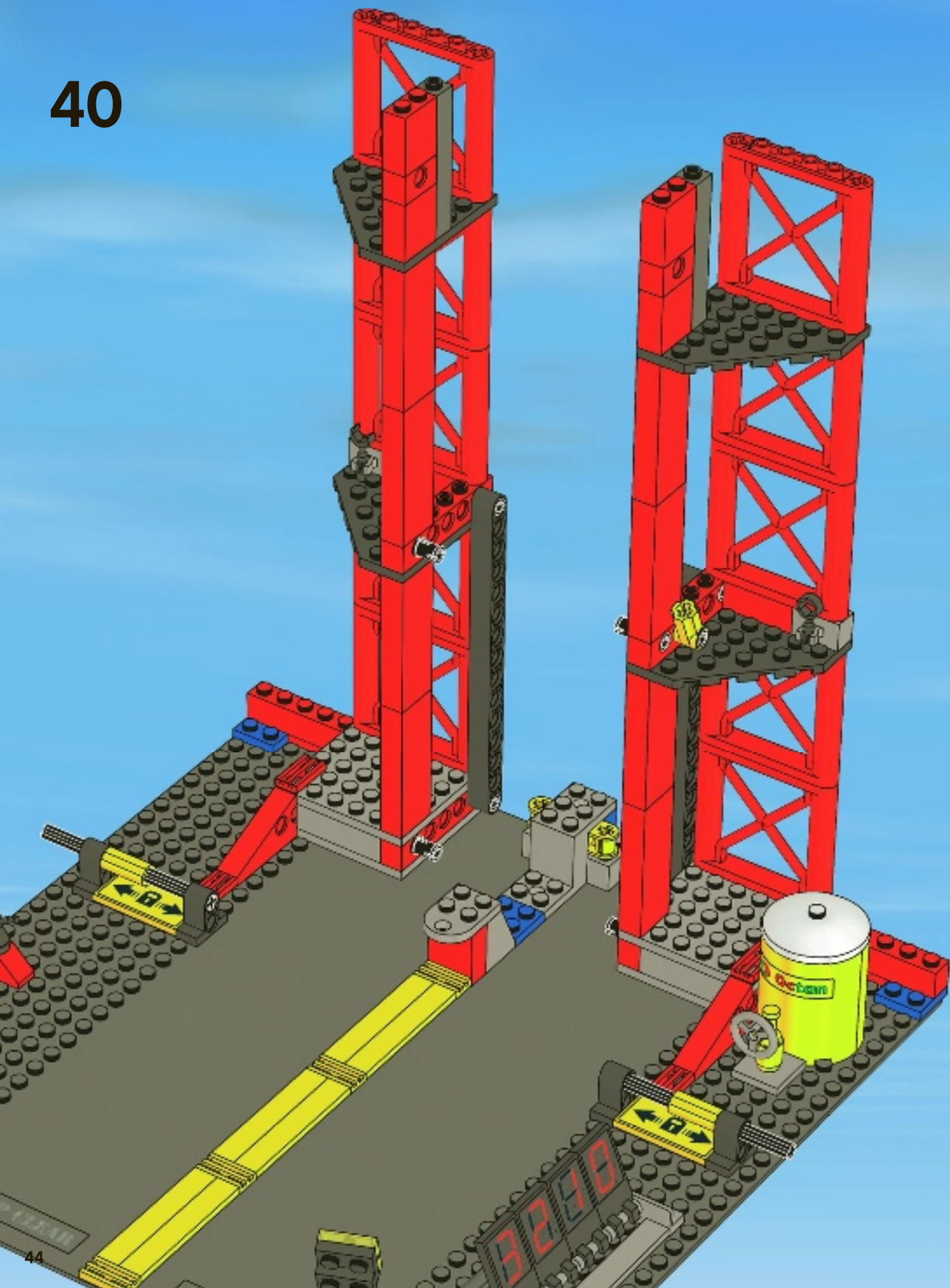

41

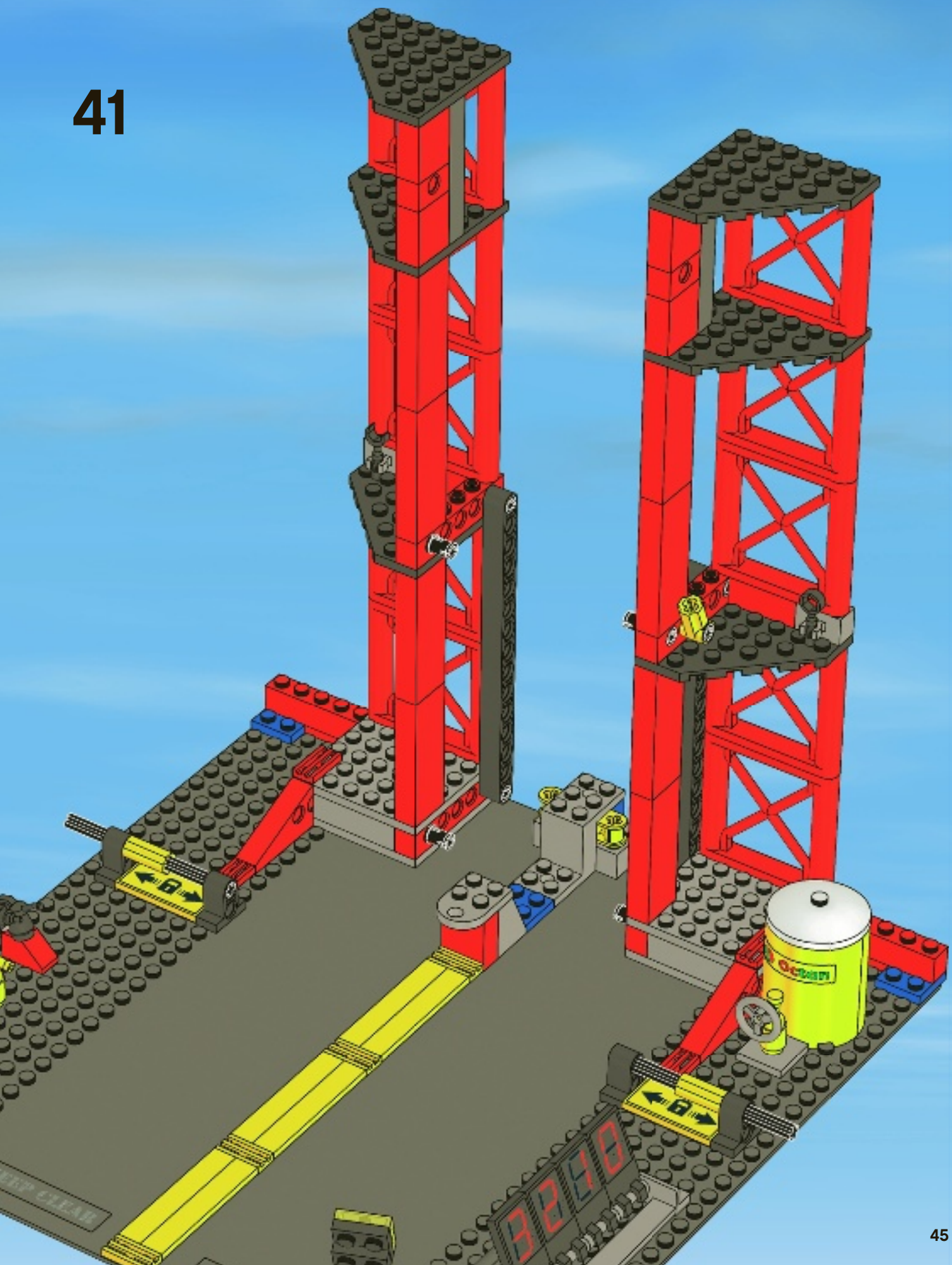

1



2

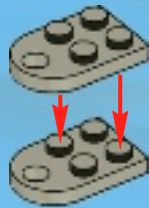

3

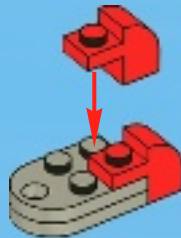

4



42

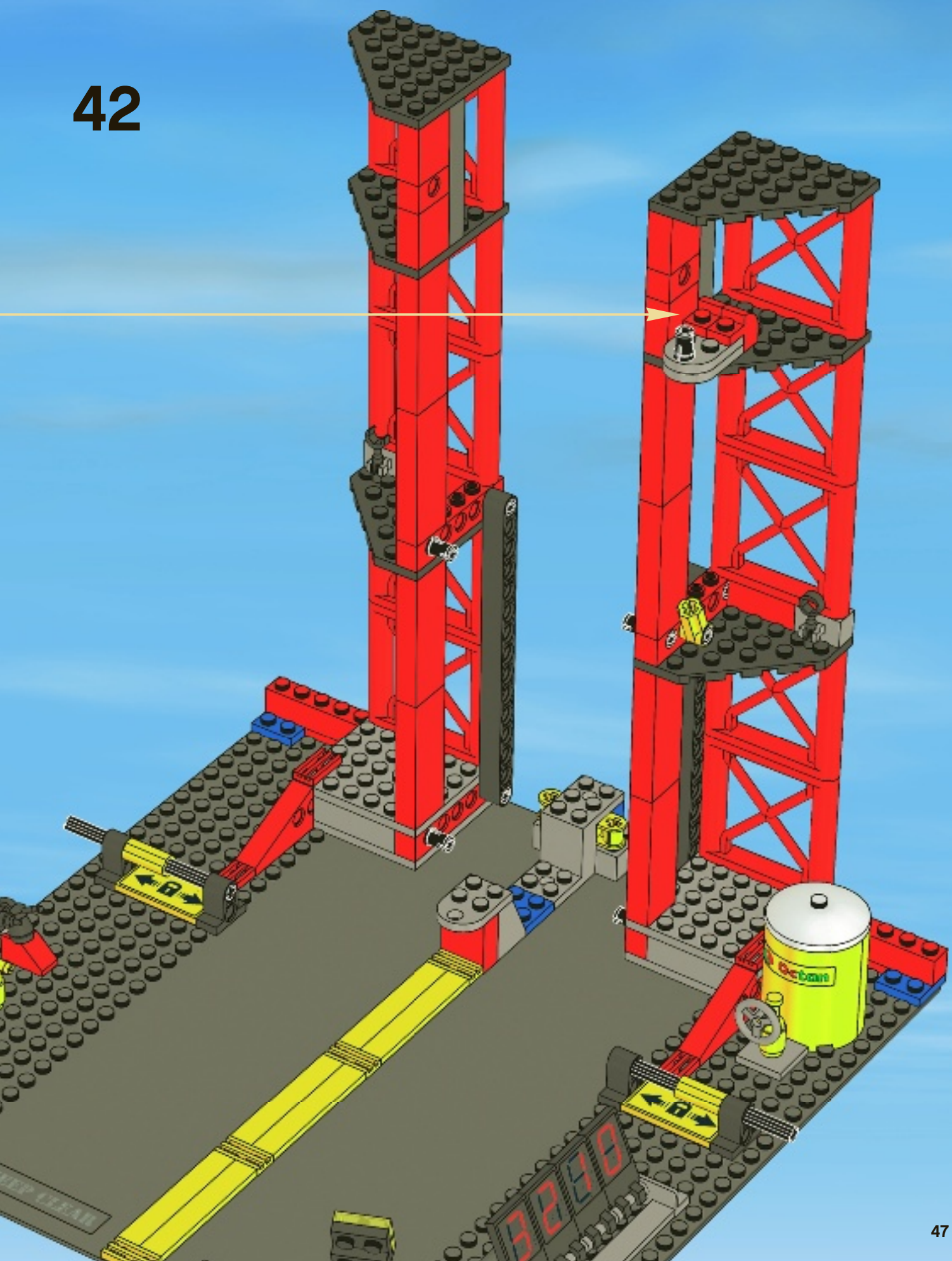

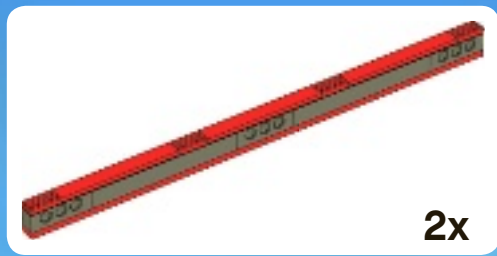

1

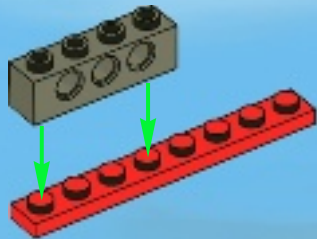

2

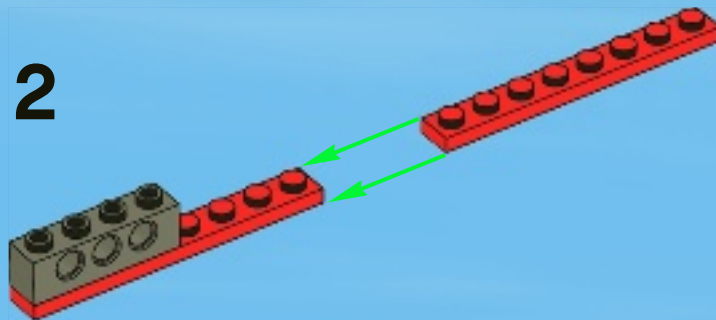

3

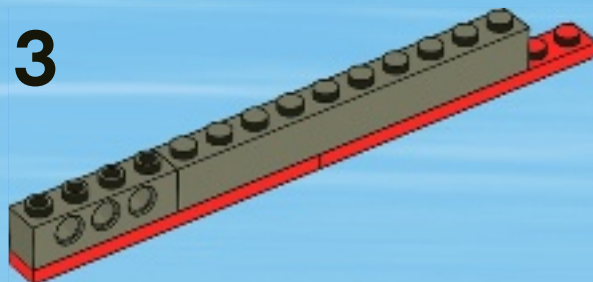

4

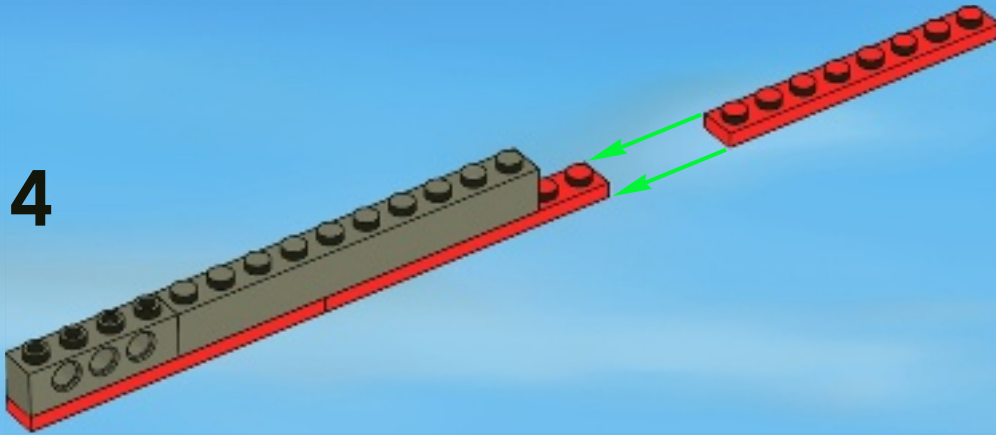

5

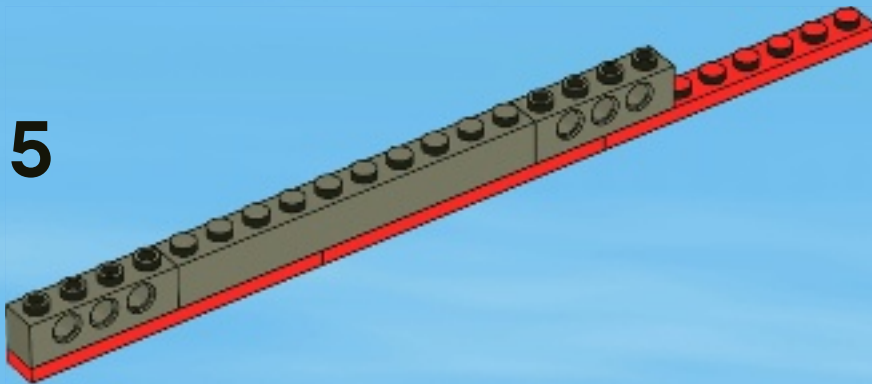

6

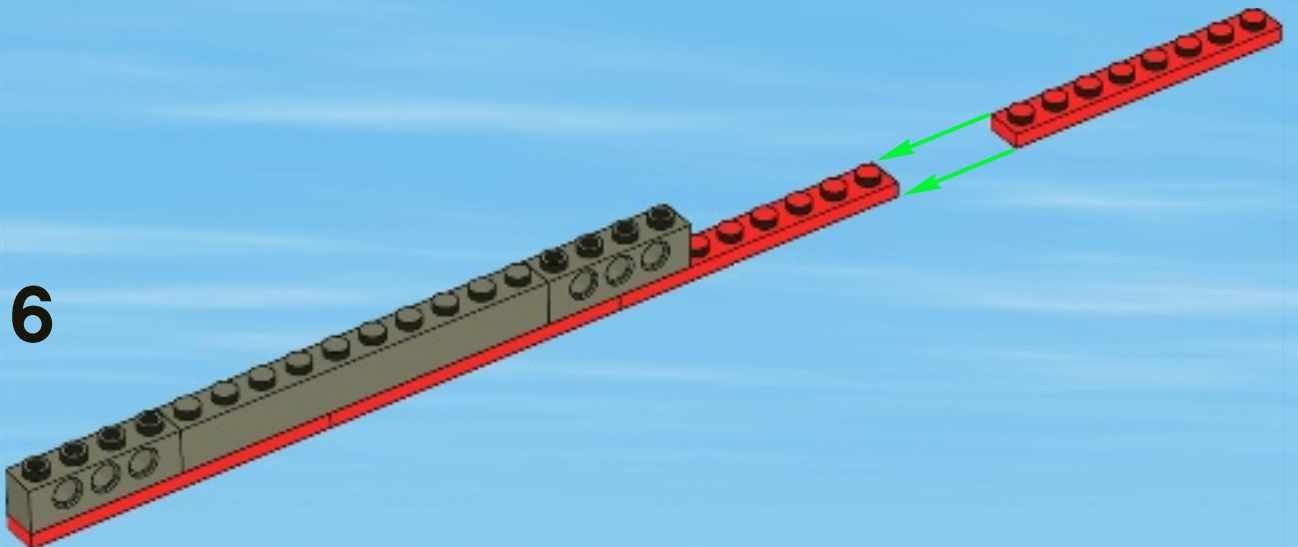

7

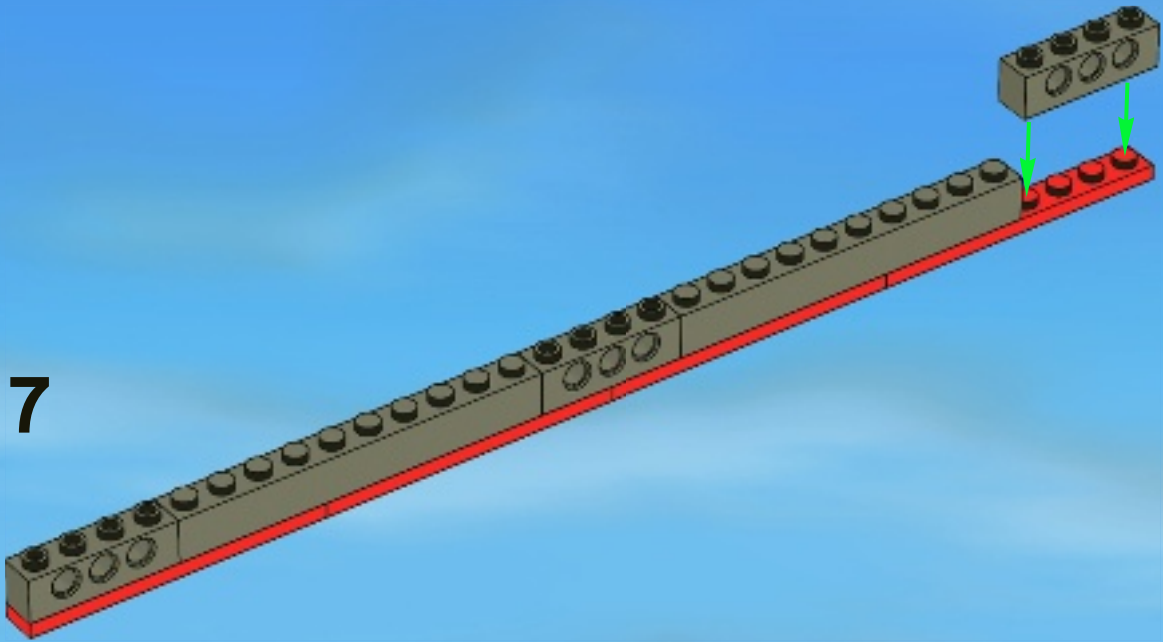

8

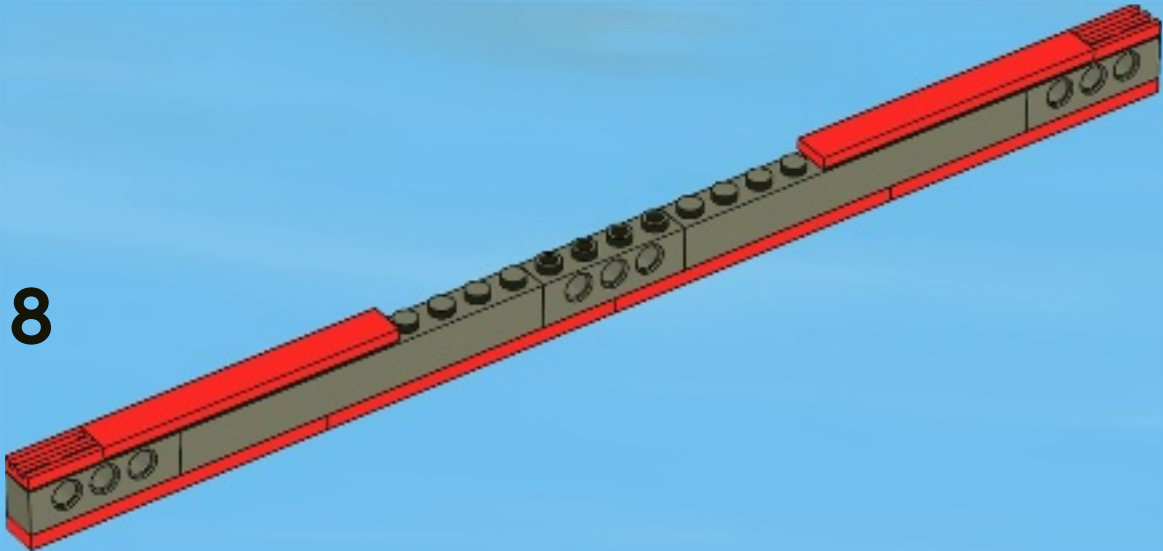

9

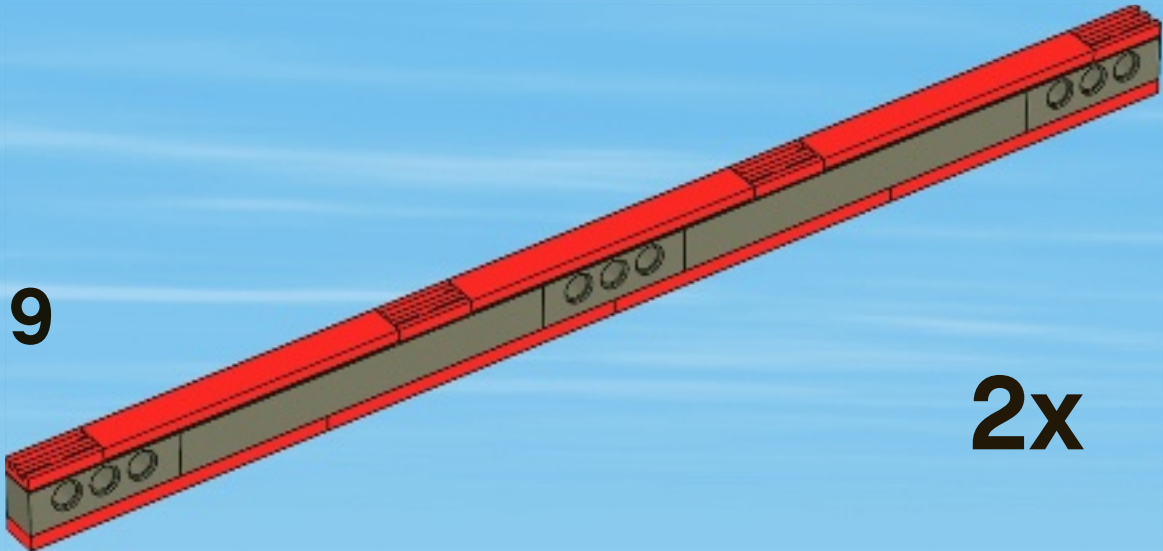

2x

43

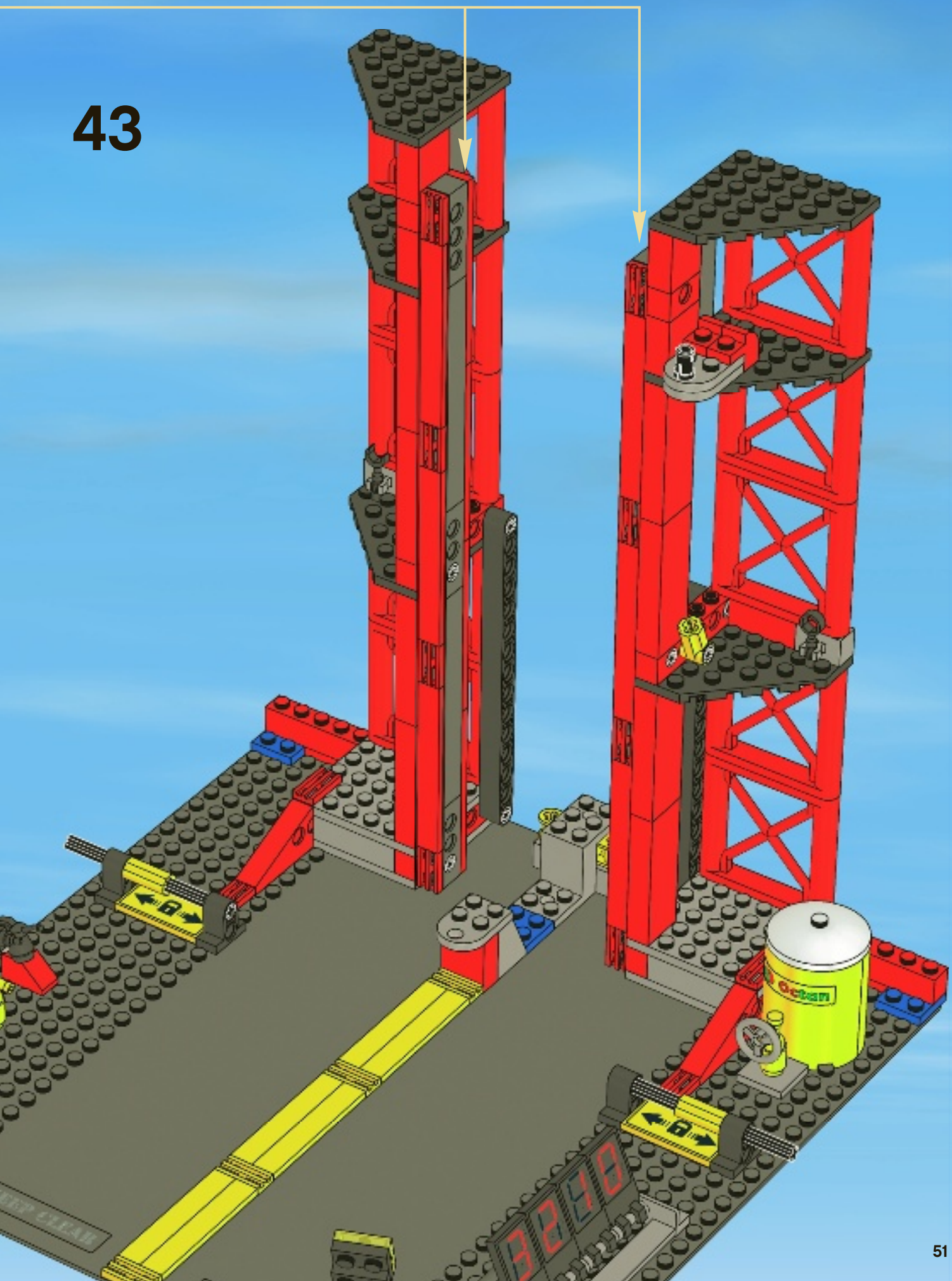

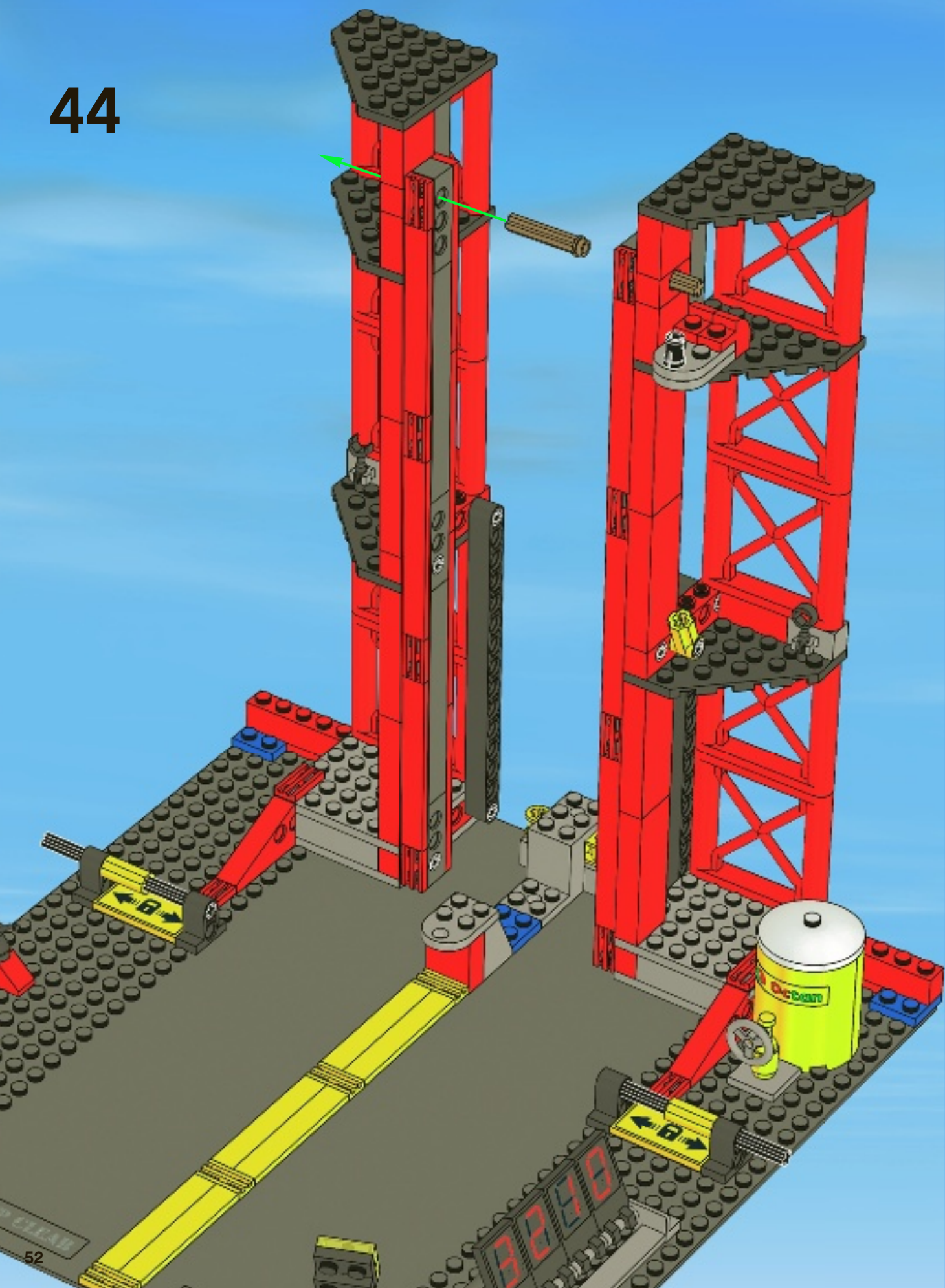

44

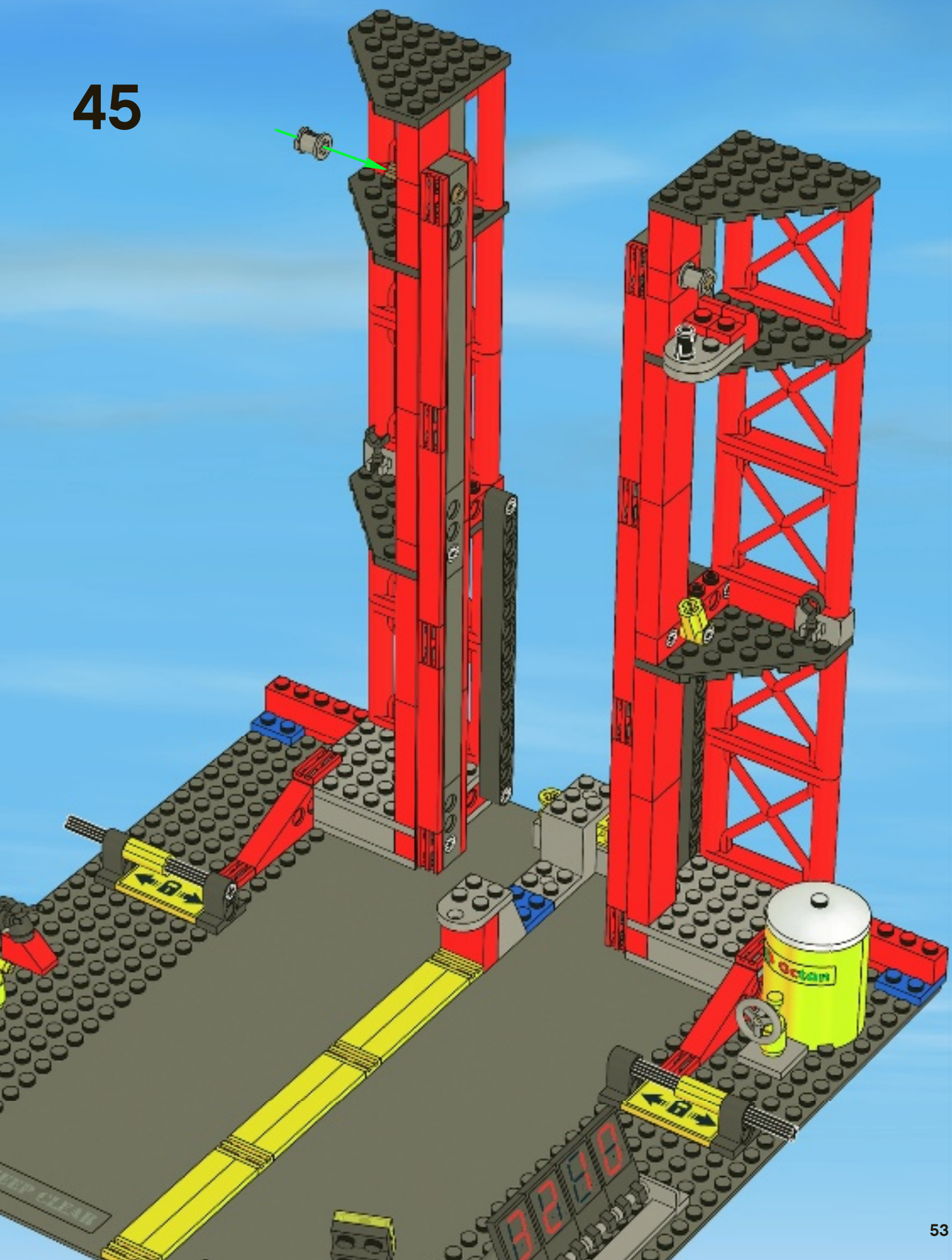

45

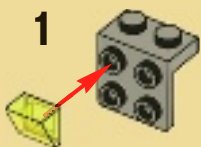

1 

2 

2x

46

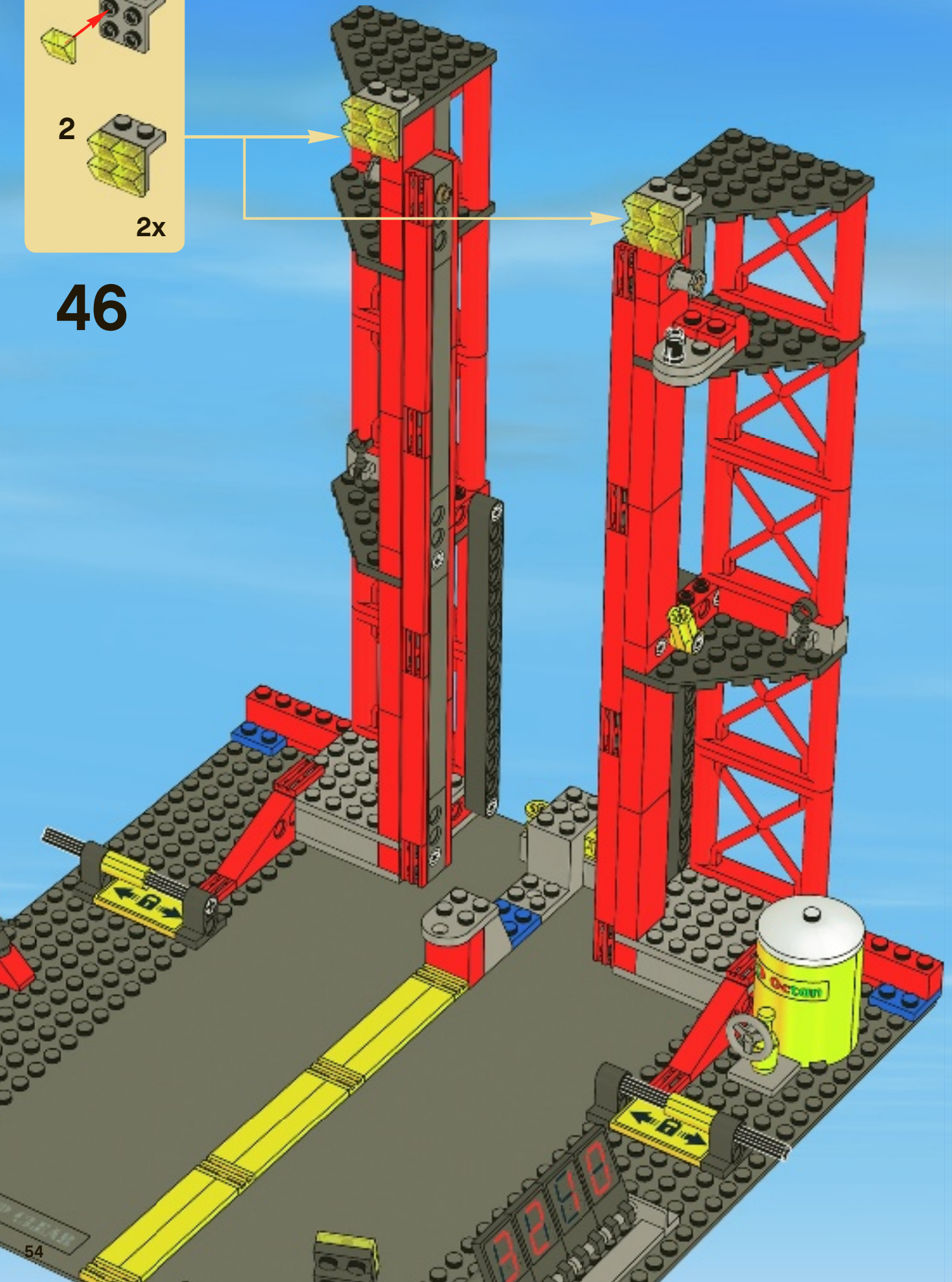

47

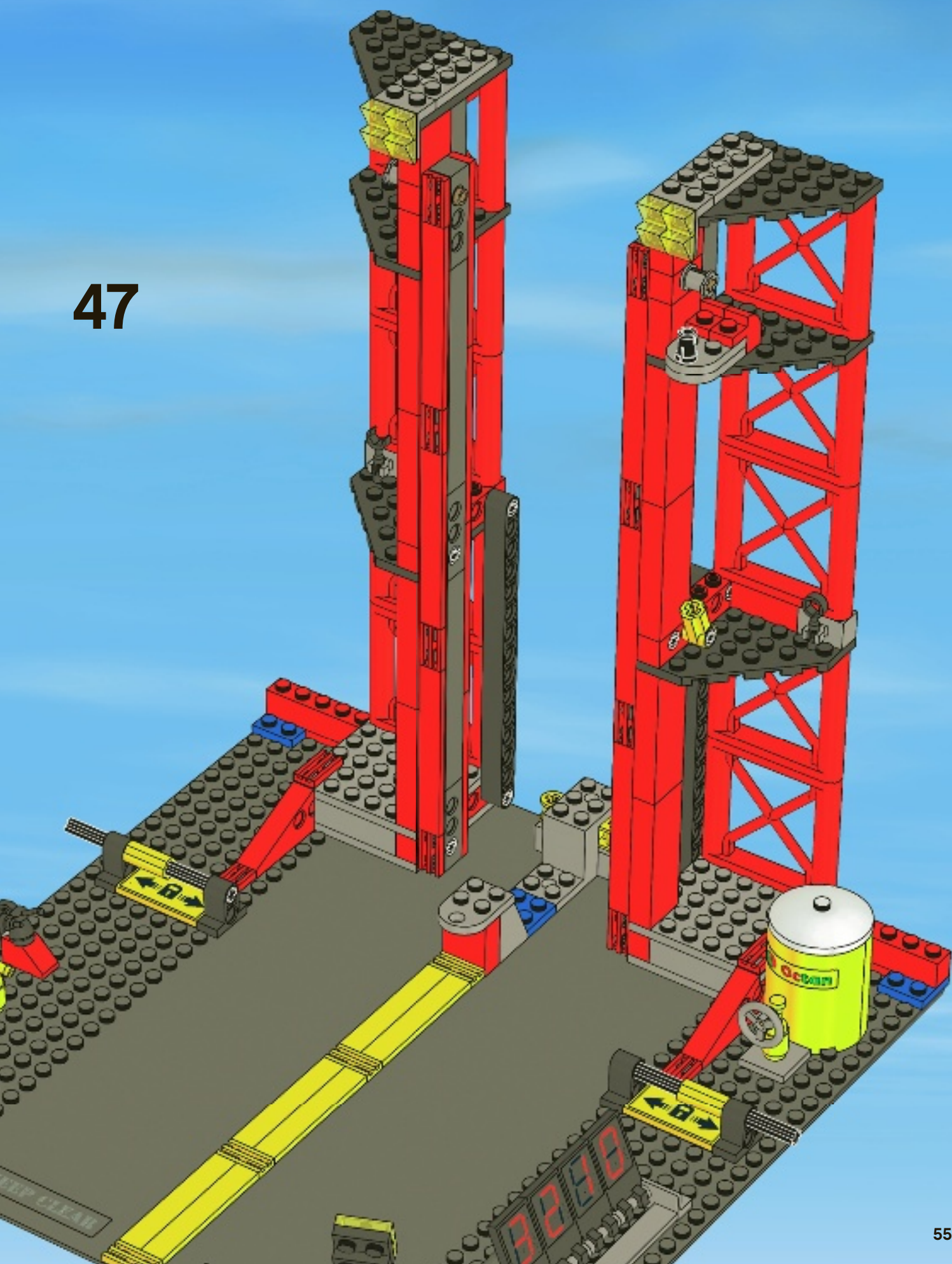

48

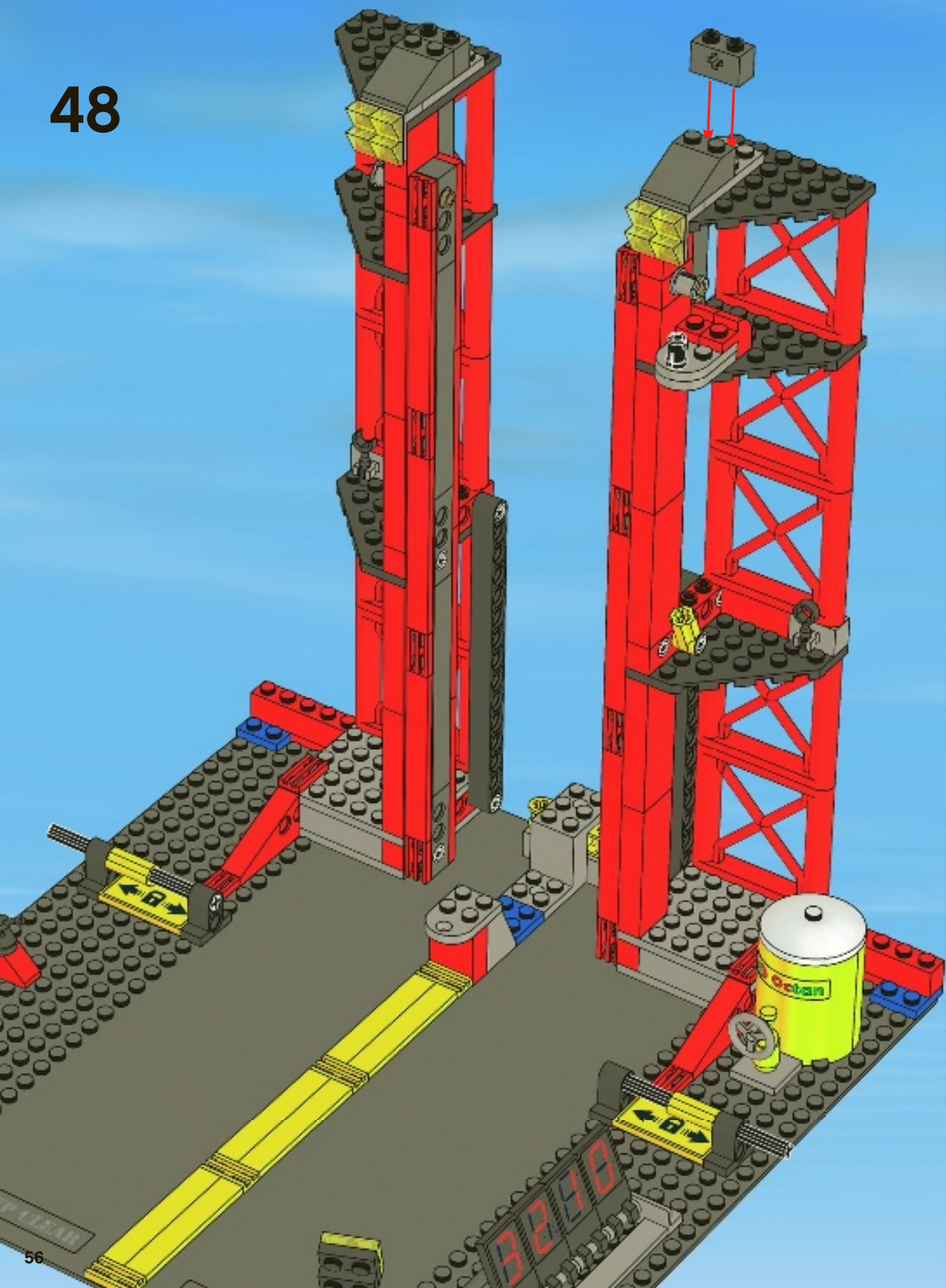

49

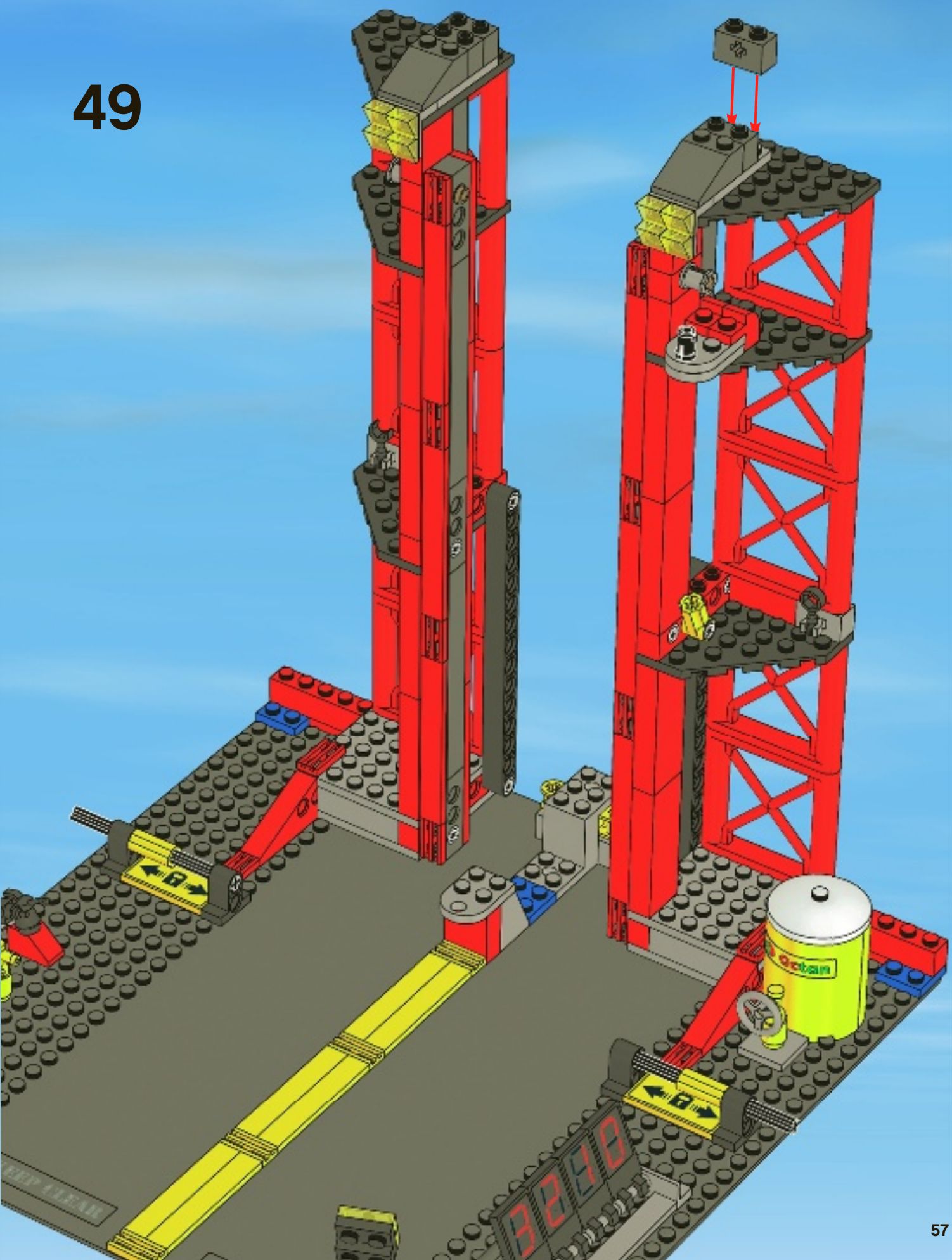

1

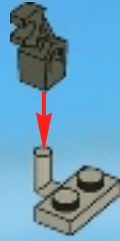

2

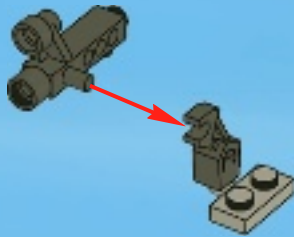

3



50

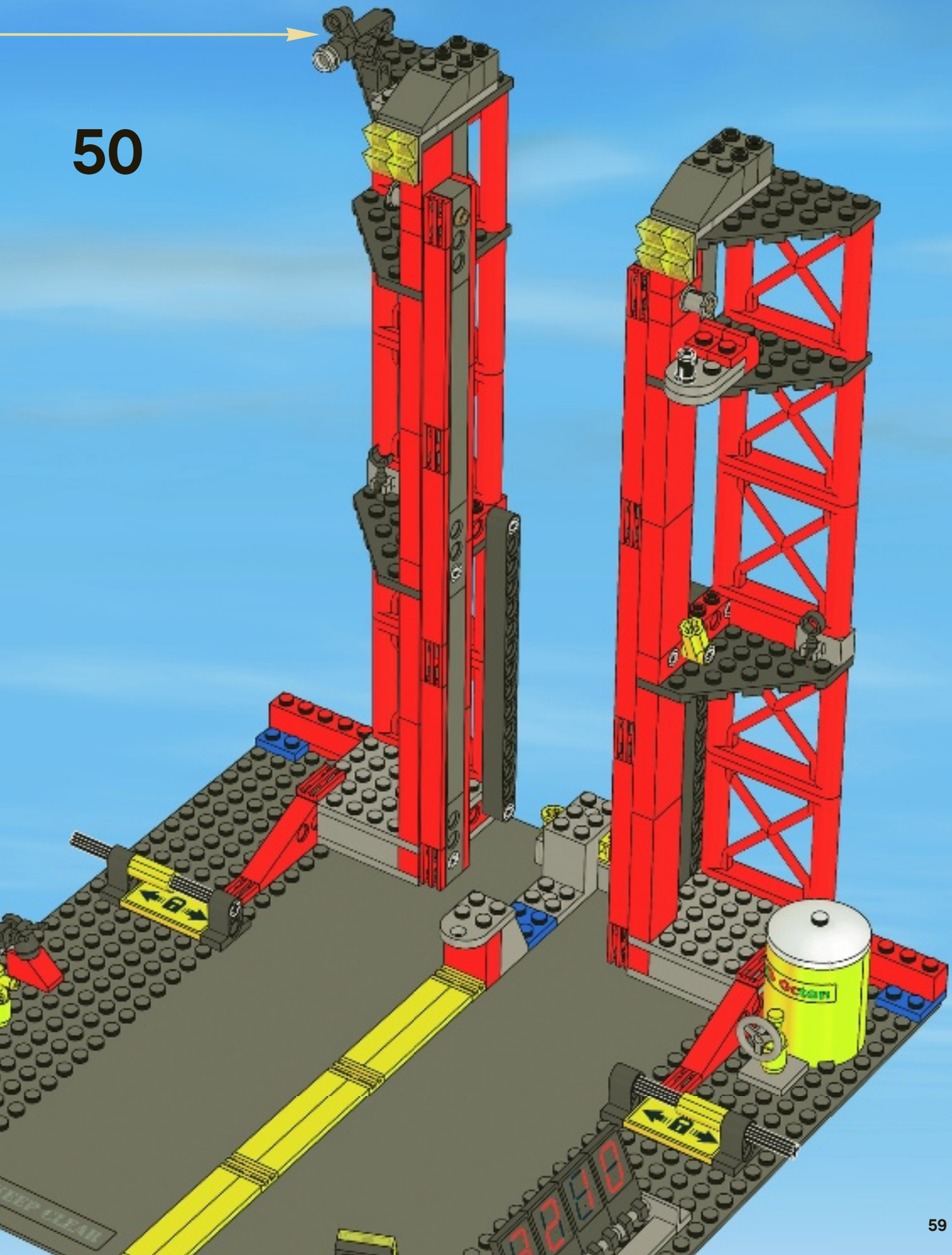

1

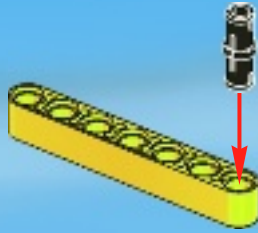

2

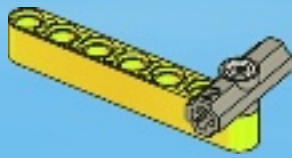

3

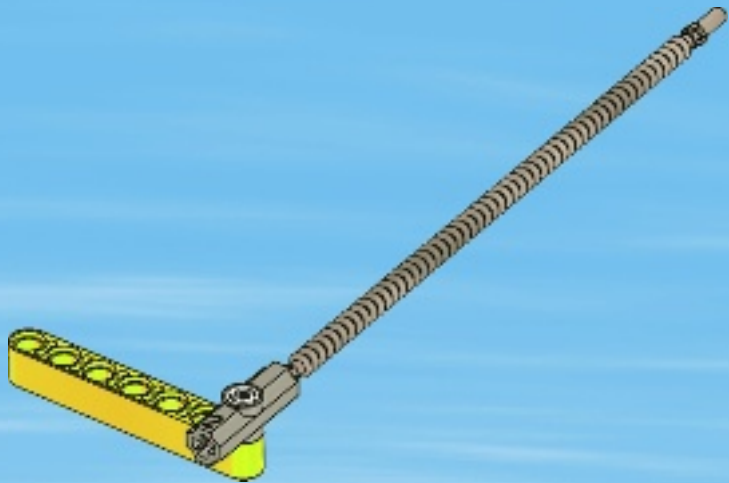

51

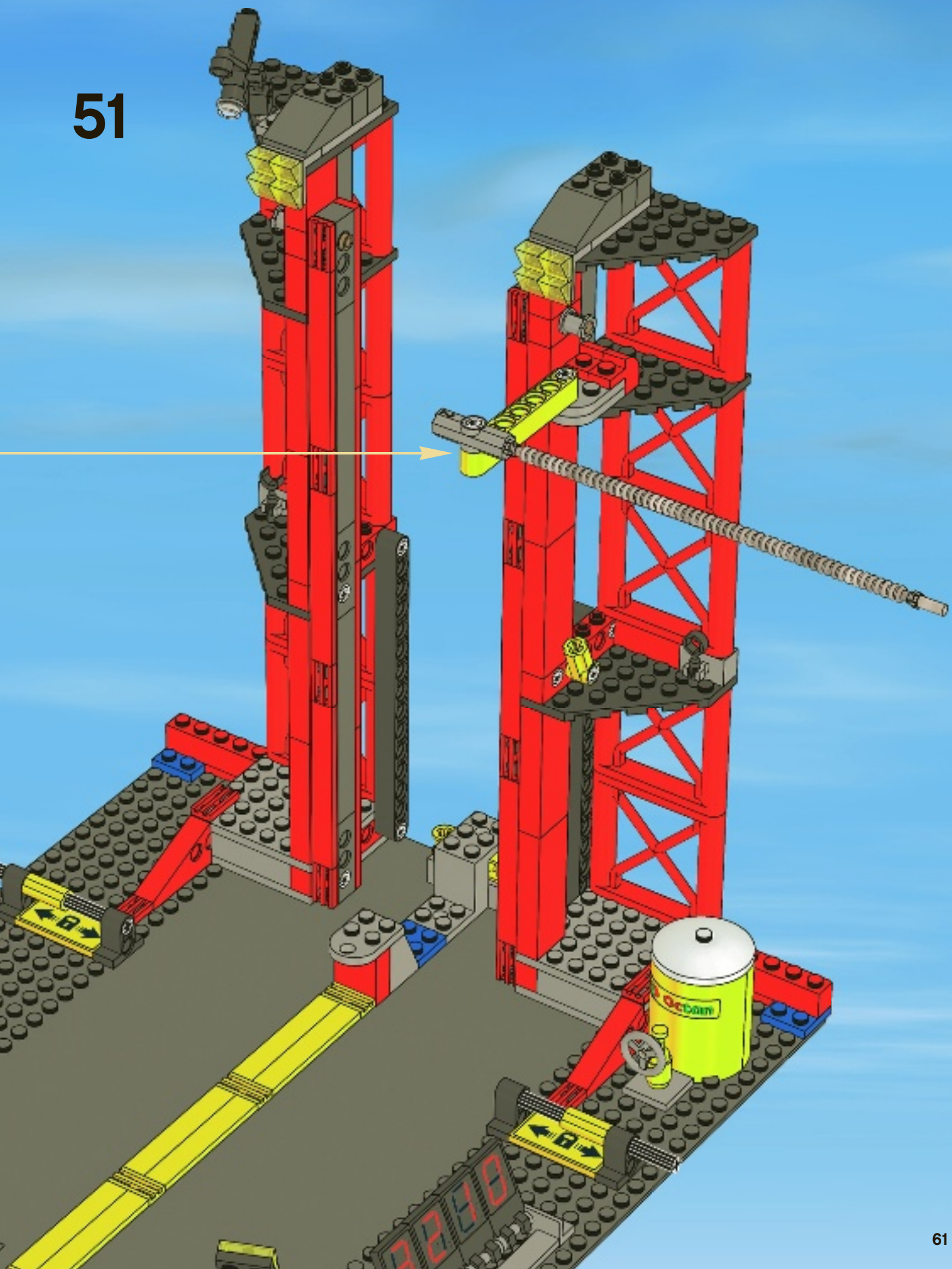

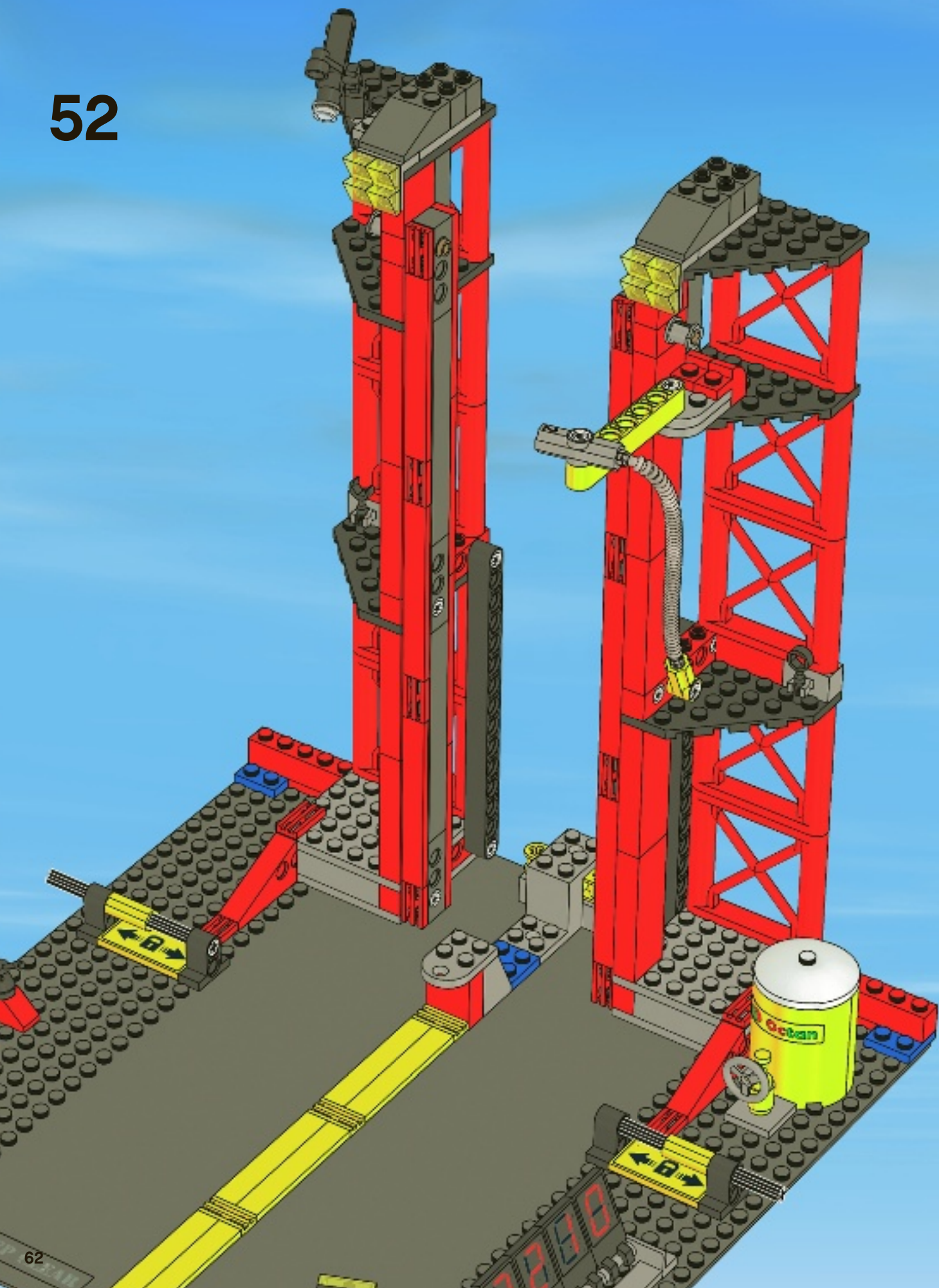

53

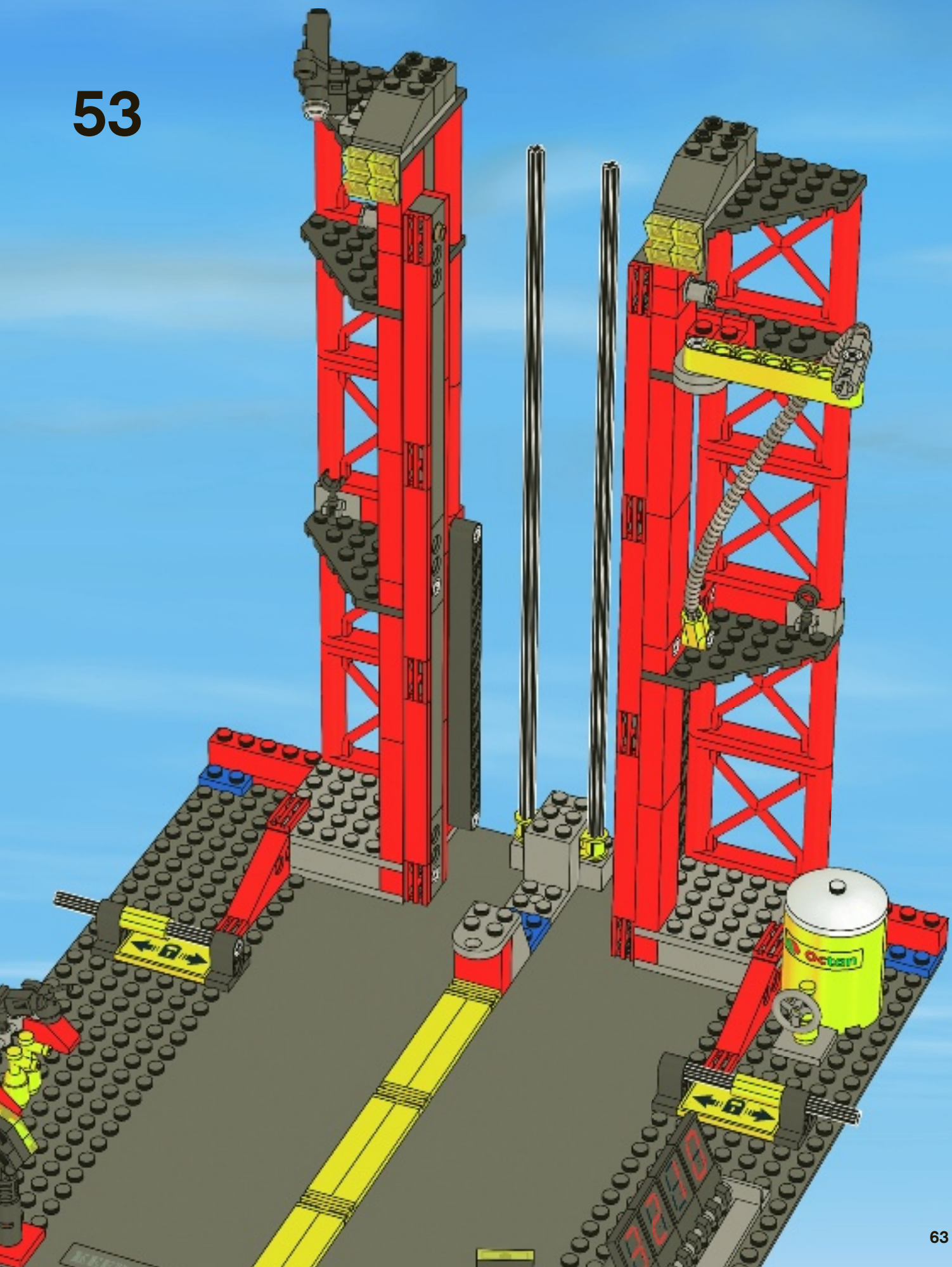



1

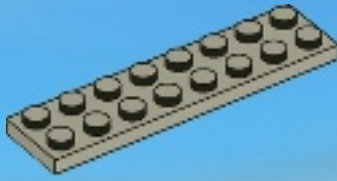

2

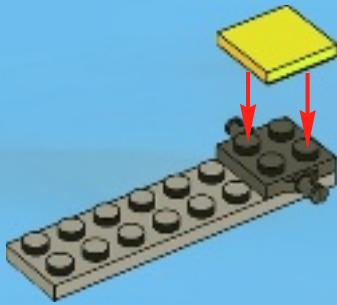

3

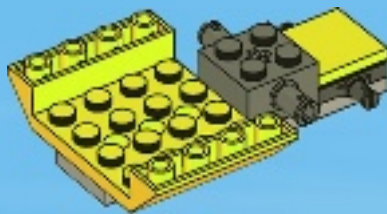

4

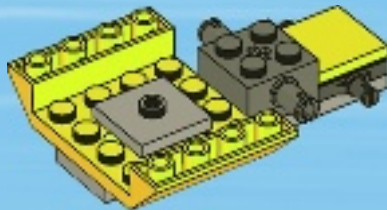

5

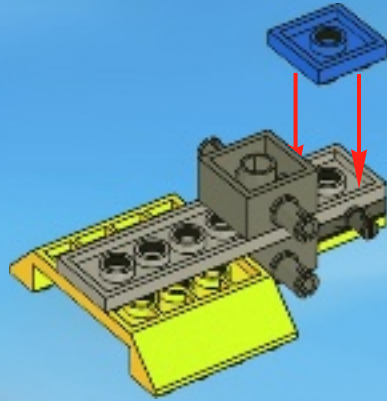

6

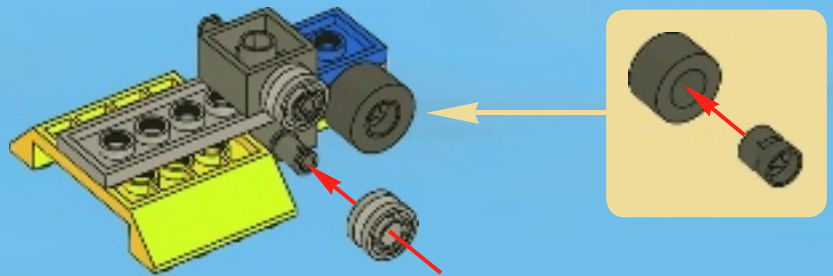

7

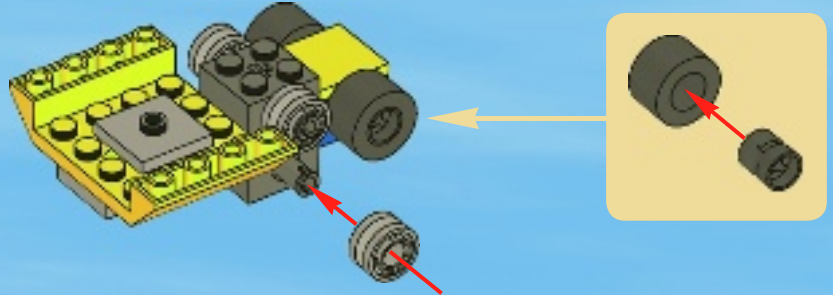

8

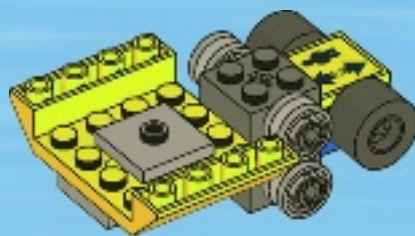

55

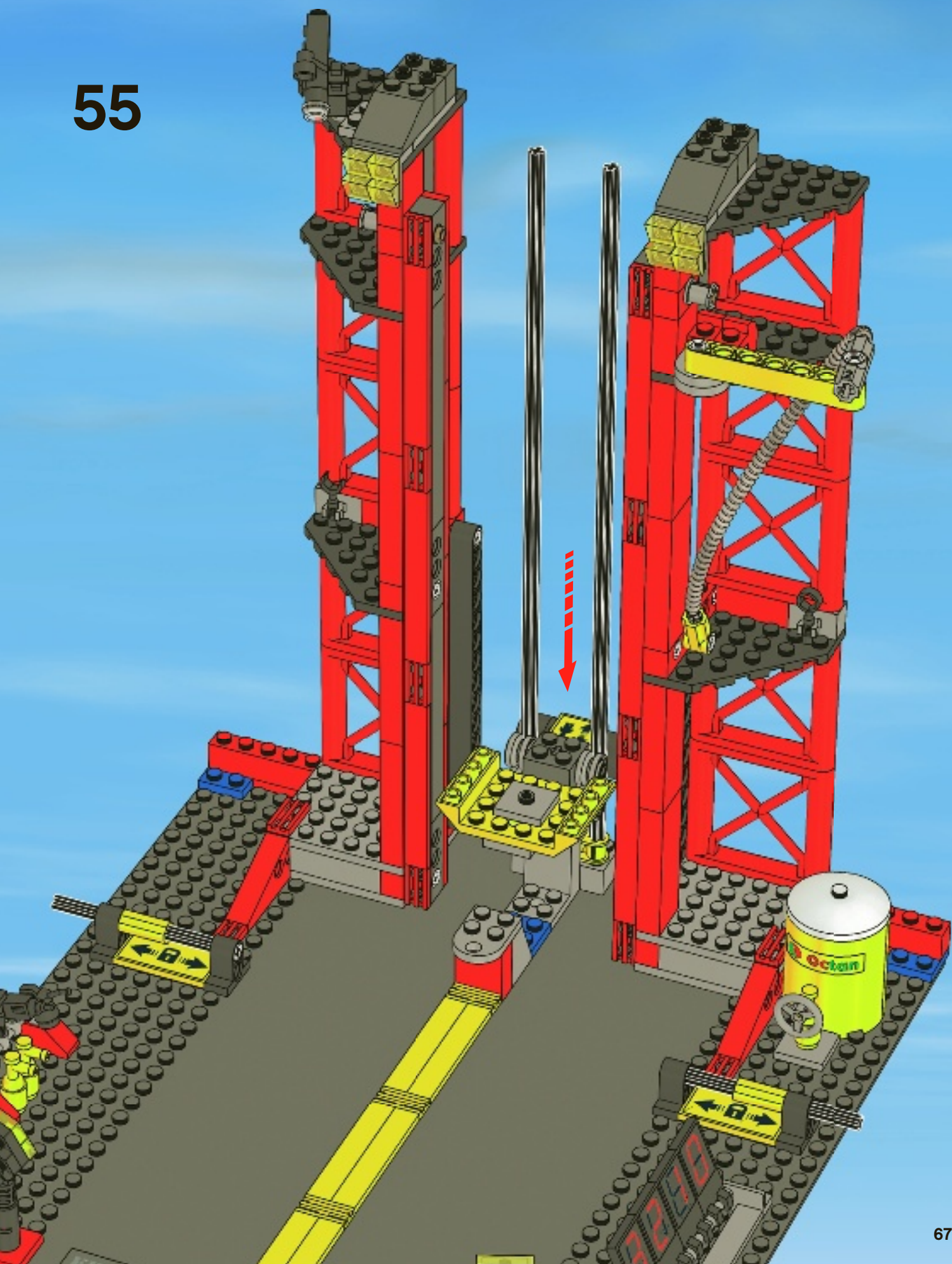

56

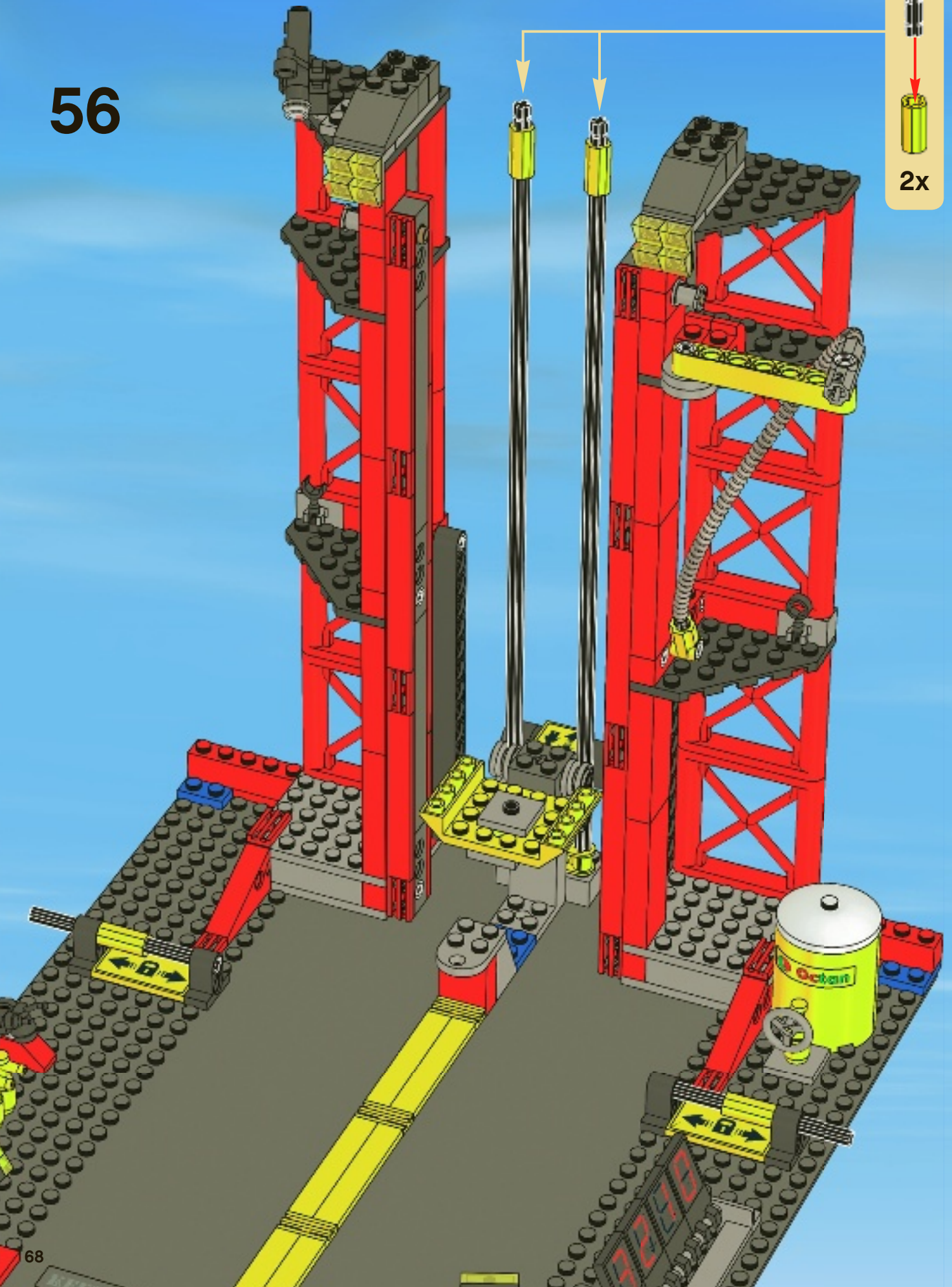

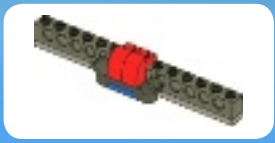

1

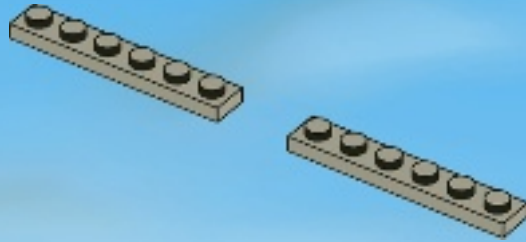

2

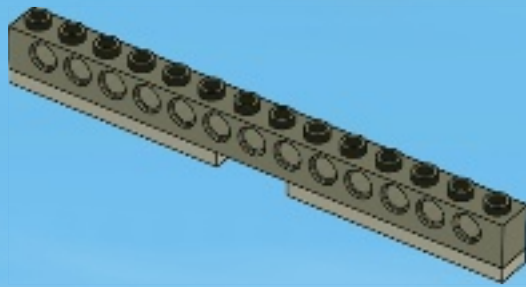

3



4

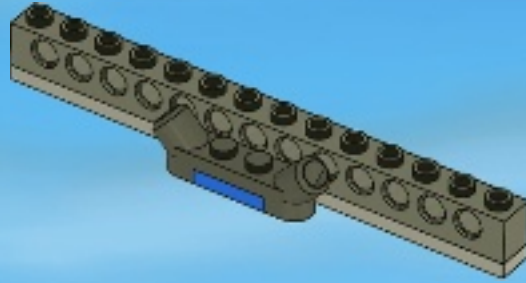

5

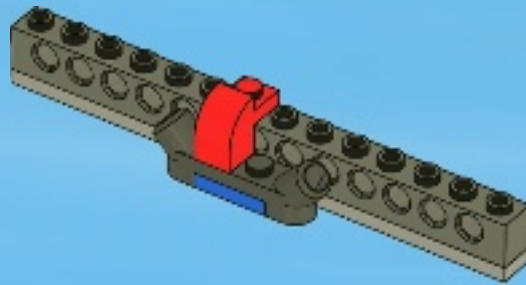

6

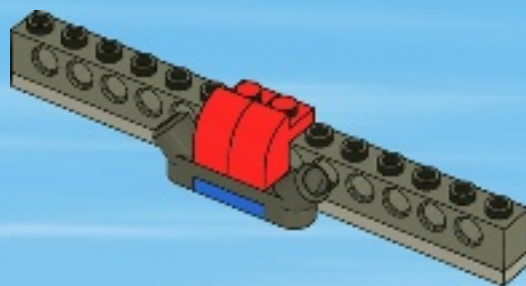

57

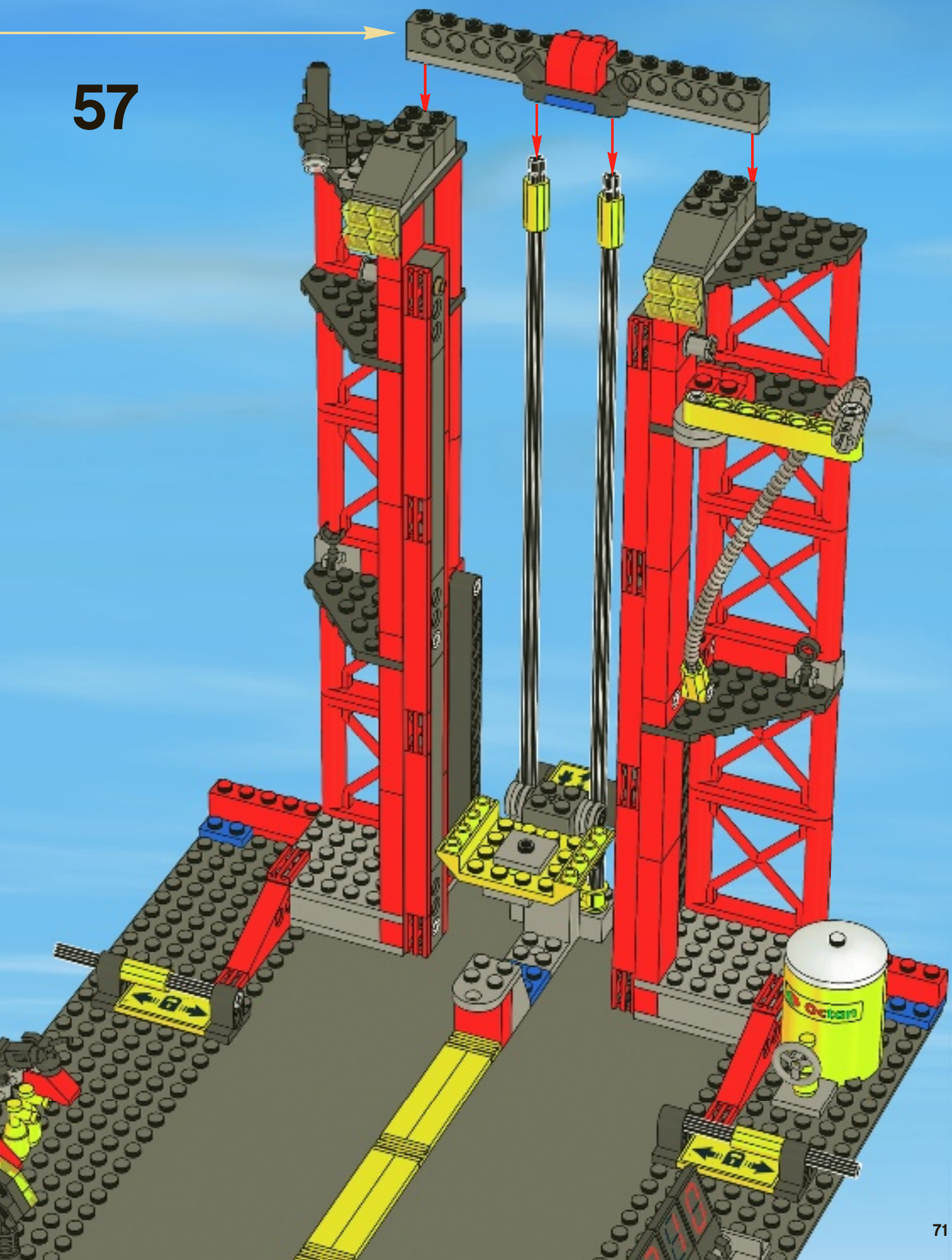

58

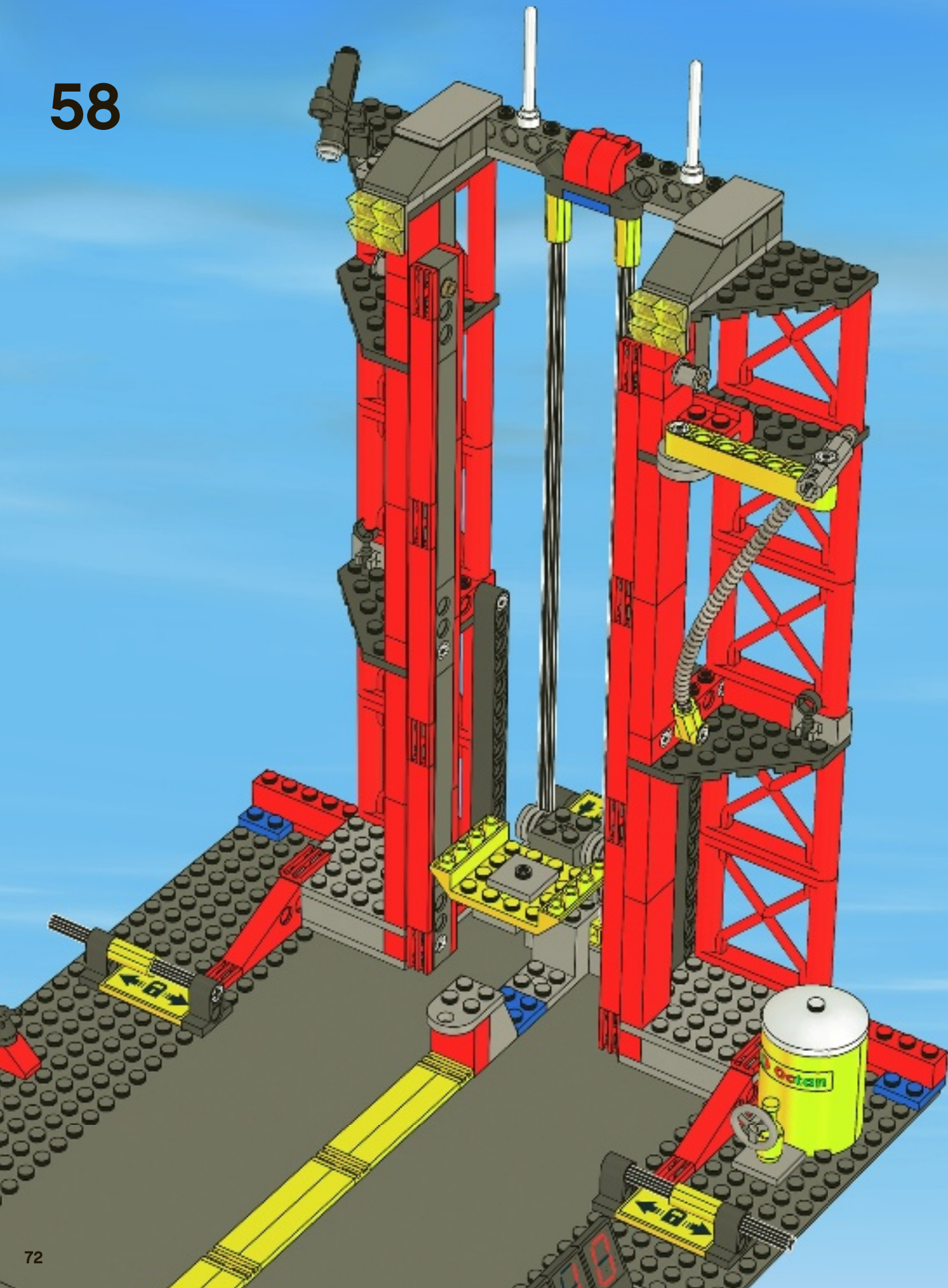

59

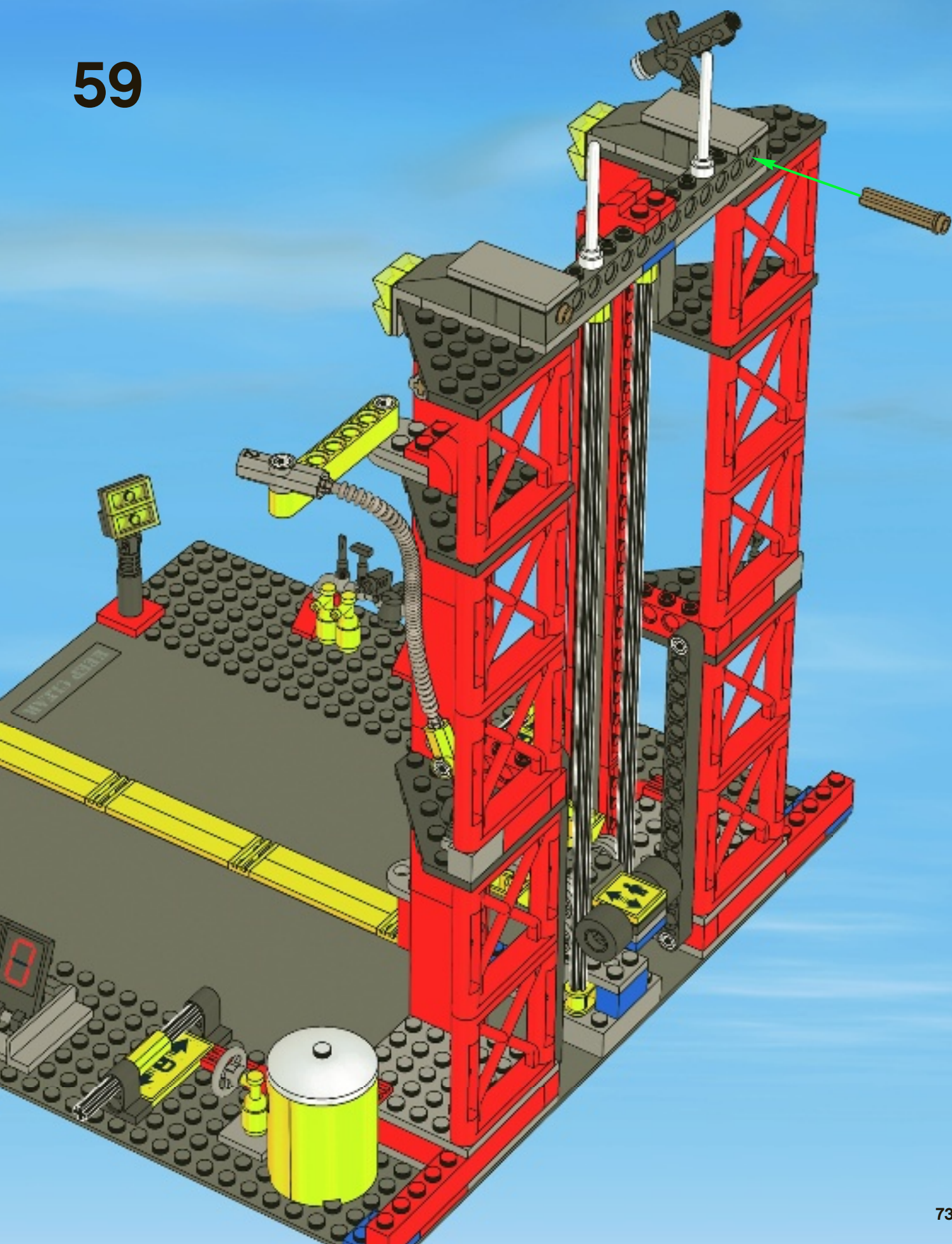

60



- 5x 4258455
- 2x 4598526
- 4x 4244627
- 4x 4565393
- 4x 4211516
- 3x 4211419
- 9x 4211444
- 2x 4211357
- 2x 4211769
- 3x 4610816
- 1x 4497653
- 2x 4211410
- 5x 4234535
- 2x 4560183
- 2x 4211438
- 1x 4211481
- 1x 4211406
- 4x 4211474
- 1x 4598522
- 2x 4211350
- 2x 4277927
- 2x 4211598
- 2x 4211650
- 3x 4211385
- 1x 4611702
- 2x 4211480
- 1x 4211524
- 1x 4227657
- 1x 4211701
- 1x 4540203
- 1x 4211567
- 2x 4211622
- 4x 4211758
- 1x 4211815
- 1x 4211805
- 2x 4100331

- 3x 306901
- 2x 394201
- 1x 4615649
- 2x 4282737
- 1x 4600181
- 3x 403201
- 1x 396001
- 1x 4514791
- 4x 4163987
- 2x 4597129
- 4x 4569476
- 3x 395701
- 2x 9327
- 2x 4602932
- 1x 4600121
- 4x 4170500
- 1x 368001

- 4x 300421
- 5x 4143832
- 8x 4212414
- 4x 362221
- 2x 300921
- 2x 611121
- 1x 4538723
- 10x 4540606
- 5x 4612108
- 1x 4610843
- 2x 370021
- 2x 4508550
- 4x 389421
- 4x 609121
- 1x 4142132
- 2x 4121934
- 2x 366021
- 2x 4610845

- 1x 4558598
- 1x 306921
- 3x 362321
- 2x 243121
- 8x 346021
- 6x 416221
- 1x 4255035
- 12x 241221
- 2x 4556153
- 2x 246021
- 5x 614121
- 3x 4171662
- 2x 302328
- 1x 3005740
- 1x 3005741
- 6x 4508534
- 12x 4260942
- 4x 4194746
- 1x 4567338
- 4x 4222960
- 1x 4522302
- 2x 370023
- 5x 302223
- 1x 371023



1x 346023
 1x 4496366
 1x 407923
 1x 9341
 1x 4548877
 2x 4567909
 1x 9566
 3x 306224
 1x 4549996
 1x 306824
 2x 4560181
 6x 663624
 4x 241224
 6x 403224
 1x 4515349
 1x 4609766
 1x 4615232

2x 4550074
 3x 4256320
 1x 4610938
 1x 4578503
 1x 4194017
 1x 4570664
 2x 4514194
 4x 370124
 1x 4495934
 2x 4173666
 1x 4107066
 5x 4519010
 2x 4569382
 4x 4569386
 1x 4595943
 1x 4583147
 1x 4211206
 4x 4566927

1x 300326
 2x 4159335
 4x 306226
 4x 4529236
 2x 614326
 3x 4143243
 2x 302226
 1x 4560182
 2x 663626
 2x 4517925
 2x 4515340
 4x 4144024
 2x 241226
 1x 4569733
 3x 4556158
 1x 460026
 5x 4297713
 11x 4121715
 10x 4109810
 4x 370526
 3x 4233937

1x 4274405
 1x 3200126
 6x 4106977
 1x 4609276
 1x 4275535
 1x 4294996
 1x 436026
 1x 4516196
 2x 4526982
 10x 4186769
 14x 4508215
 1x 244126
 1x 4143199
 2x 246526
 2x 4542573
 1x 4507668

2x 4210690
 4x 4211107
 5x 4210935
 2x 4211024
 2x 4239373
 6x 4213607
 1x 4211137
 2x 4211106
 2x 4294180
 4x 4246896
 2x 4210968
 1x 4493478
 2x 4211115
 1x 4210865

Customer Service
 Kundenservice
 Service Consommateurs
 Servicio Al Consumidor
www.lego.com/service or dial
 00800 5346 5555 :
 1-800-422-5346 :

