



Friends



3061

 **WARNING: CHOKING HAZARD.**
Toy contains small parts and a small ball.
Not for children under 3 years.

1

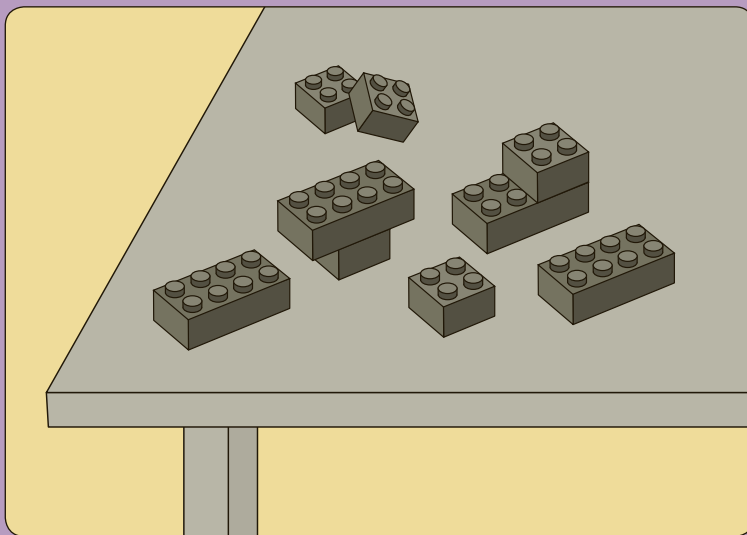
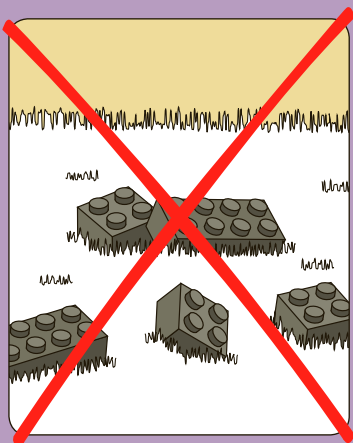

2



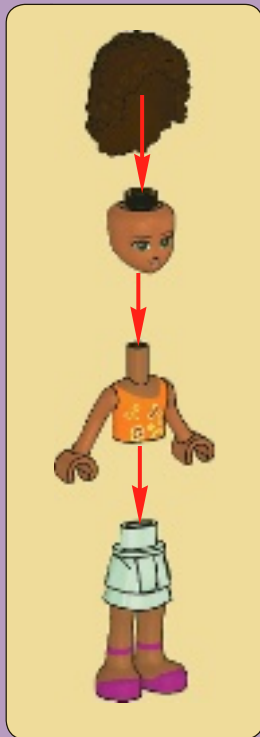
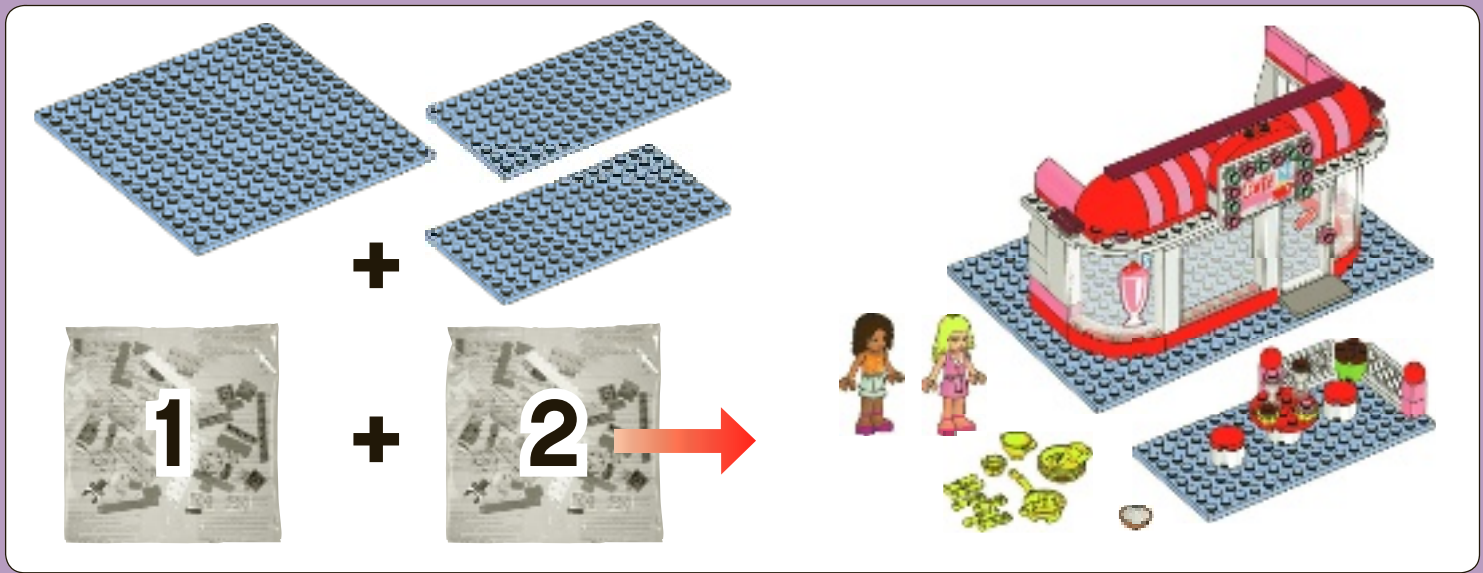

AVERTISSEMENT : RISQUE D'ÉTOUFFEMENT.
Le jouet contient des petites pièces ainsi qu'une petite boule.
Il ne convient pas aux enfants de moins de 3 ans.



ADVERTENCIA: PELIGRO DE ASFIXIA.
Juguete que contiene partes pequeñas y una pelota pequeña.
No recomendado para niños menores de 3 años.

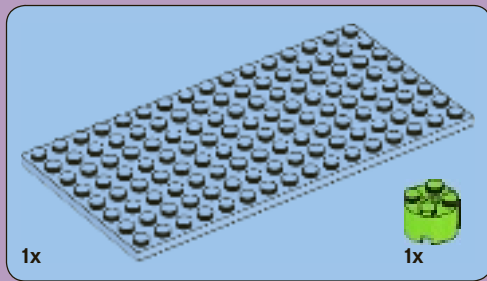

1

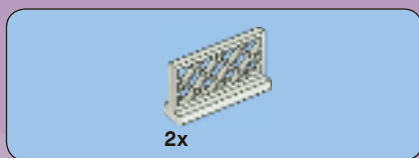
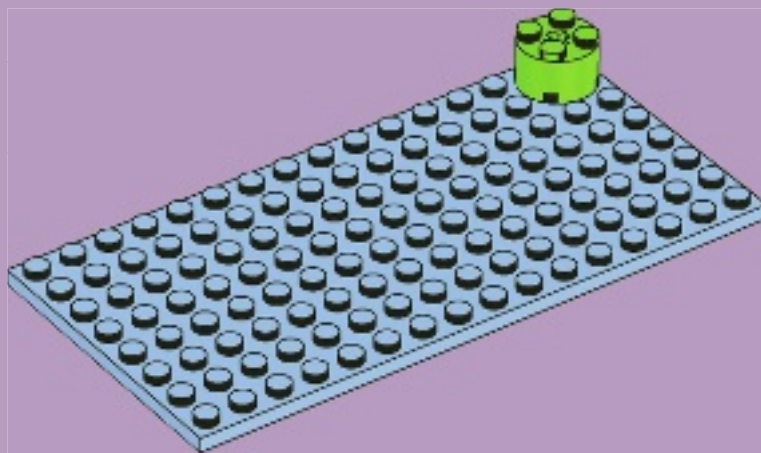

2

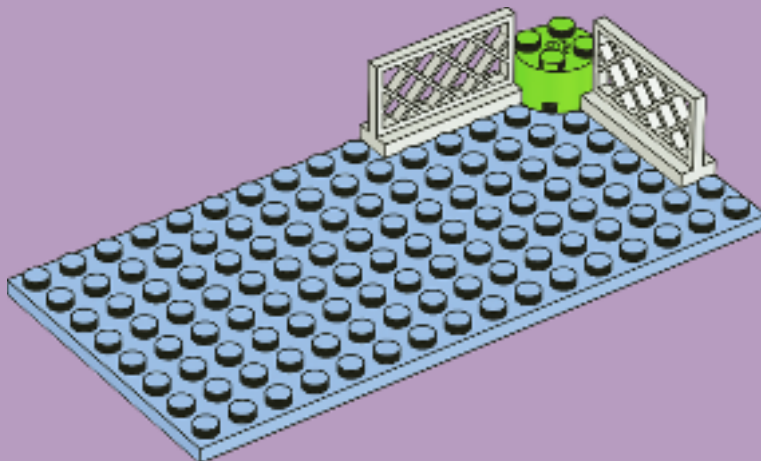



4x



1x

3

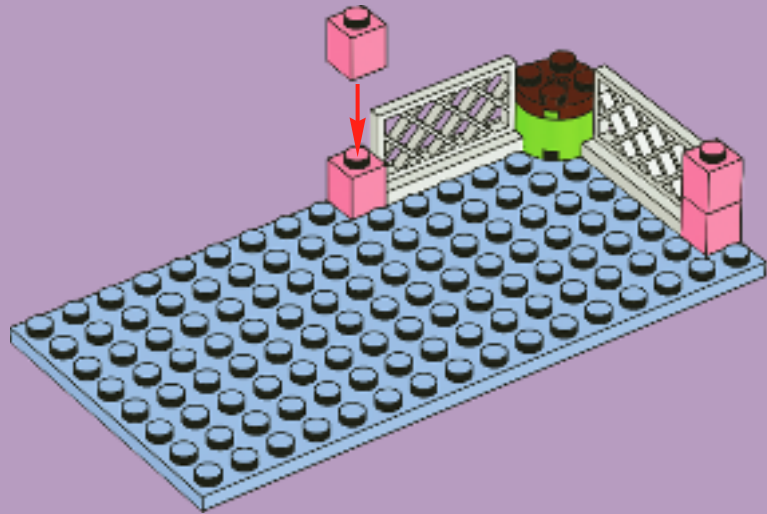

3x

4

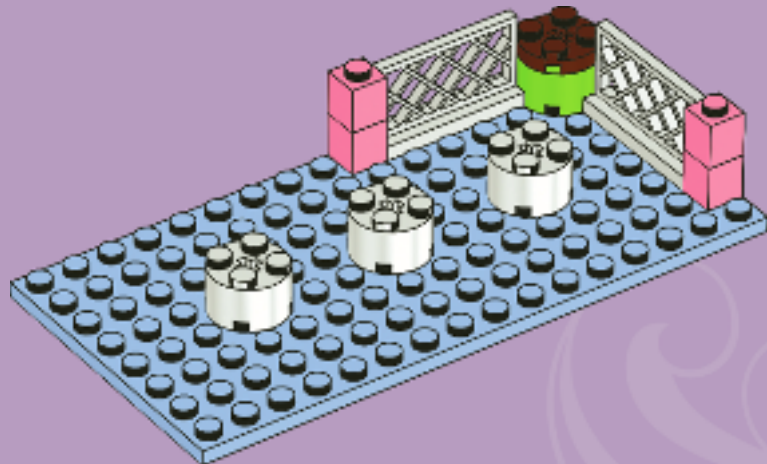



1x



2x

5

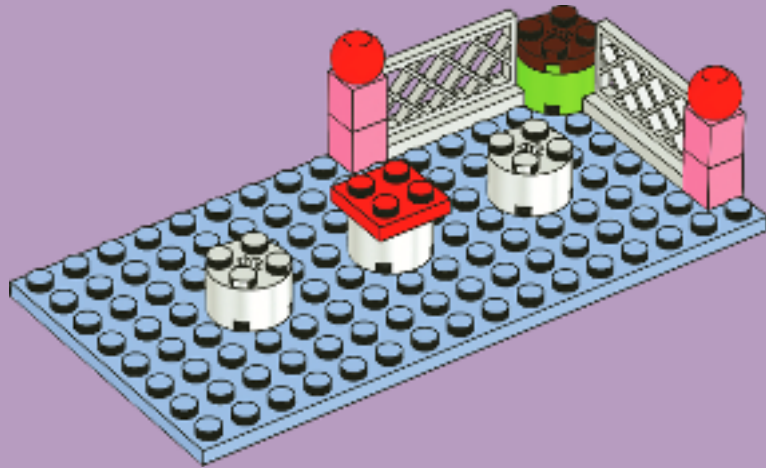

1x



2x

6

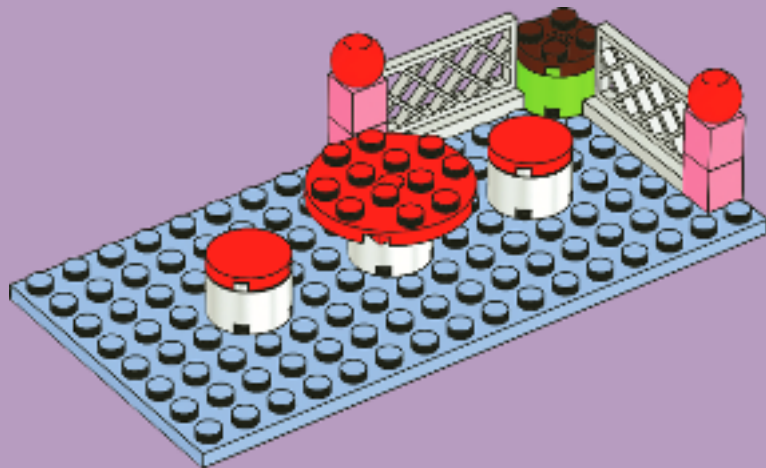



7



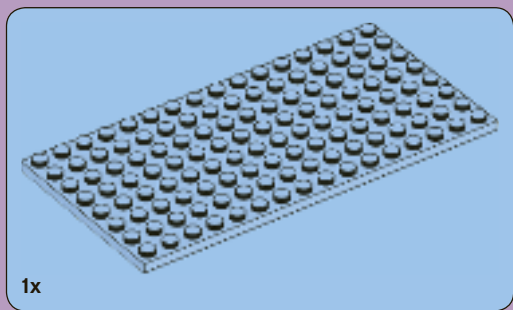

1x

1

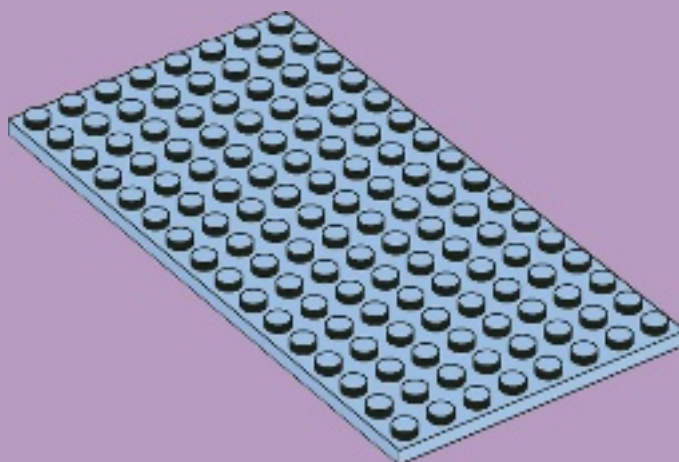

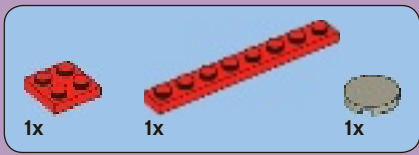

2

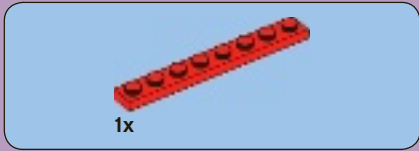
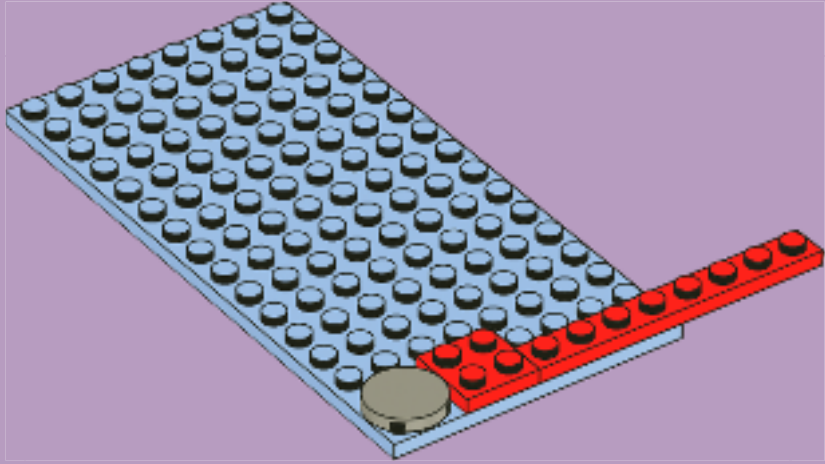

3

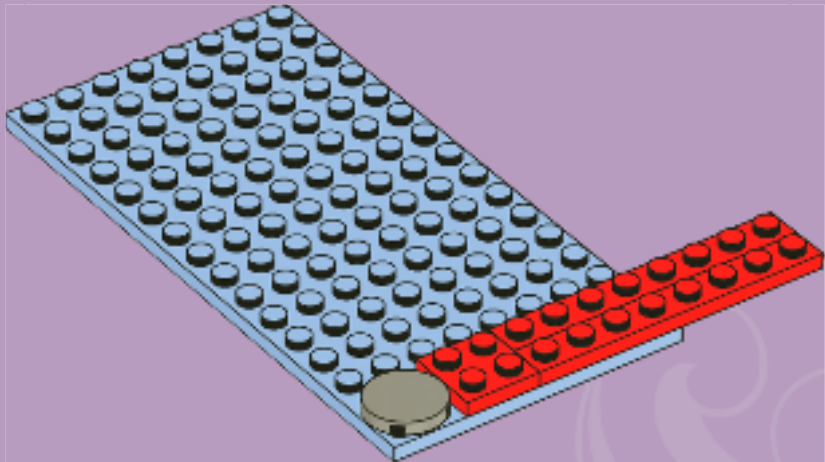

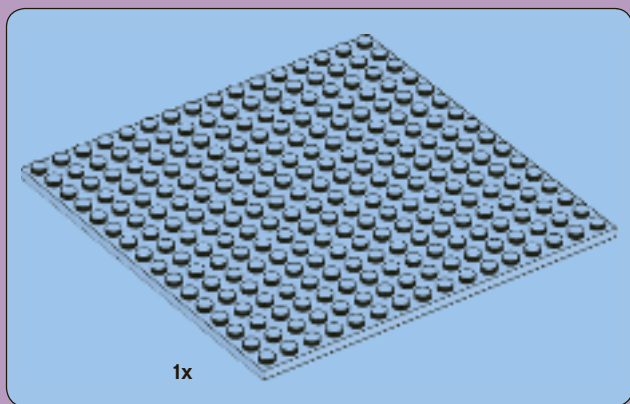

4

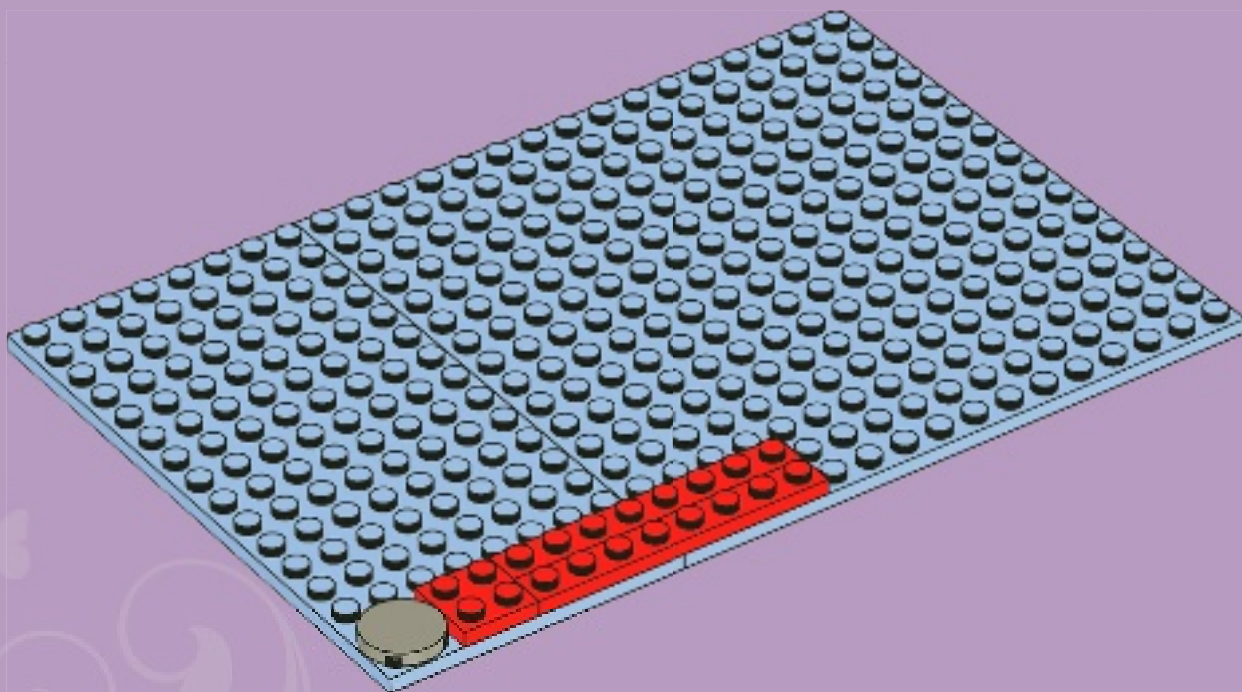

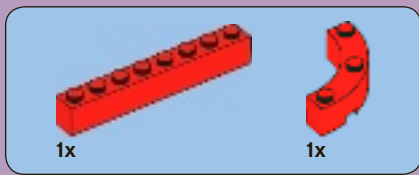

5

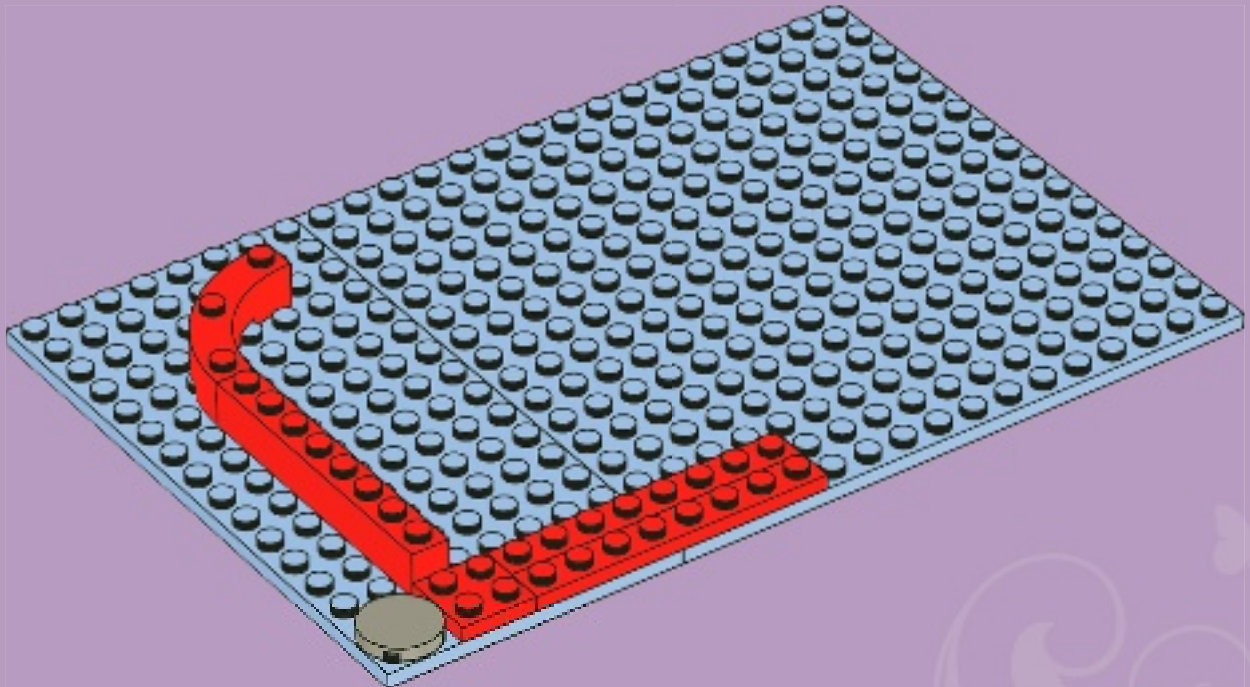

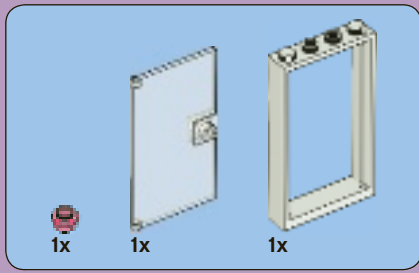

6

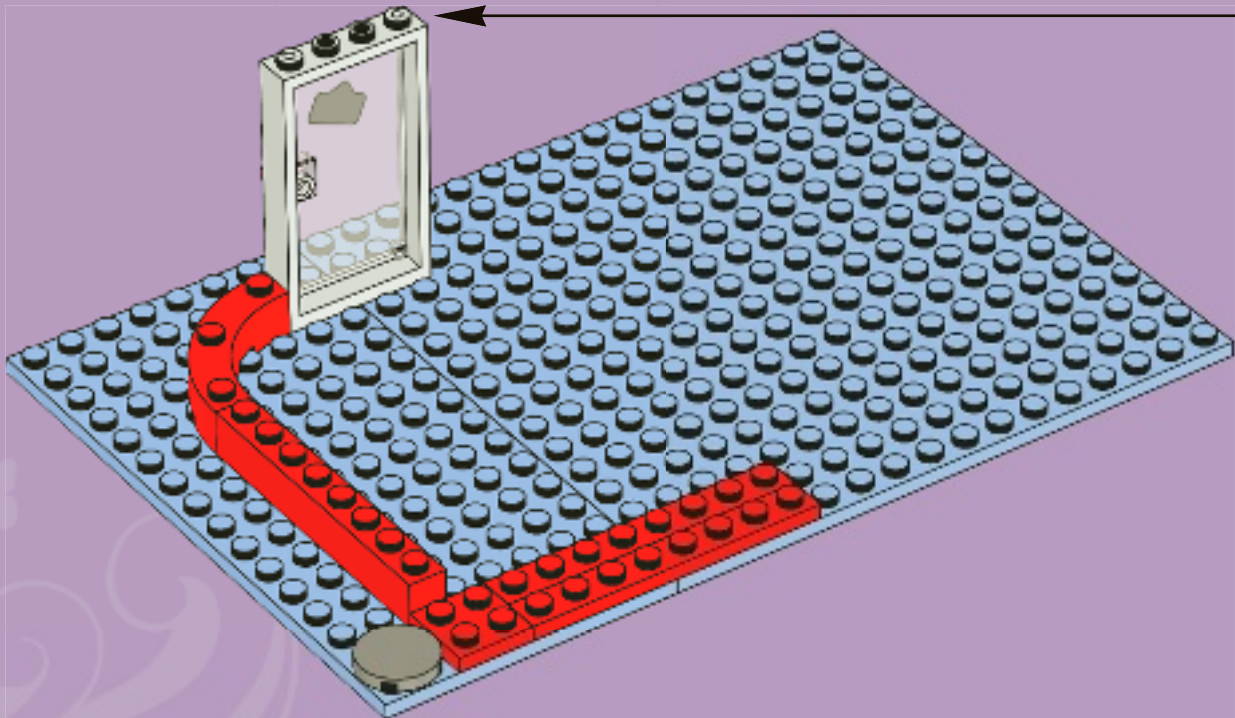
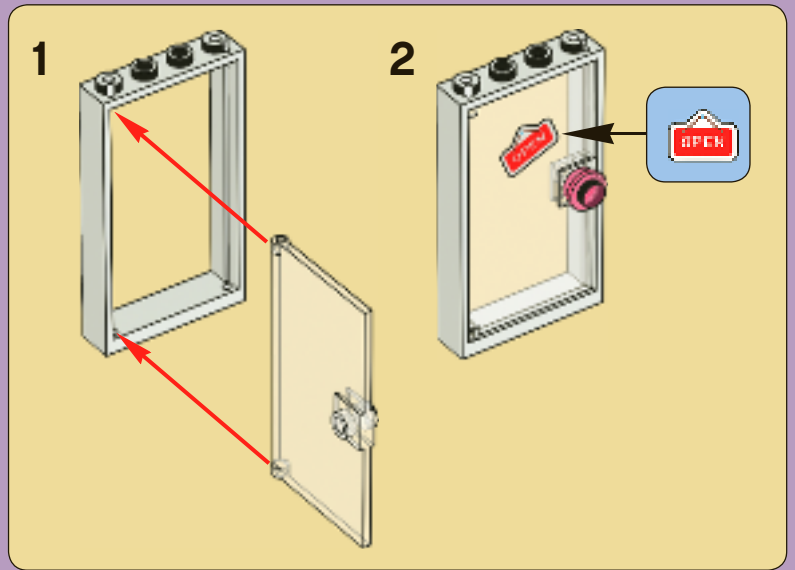

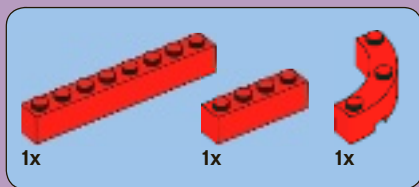

7

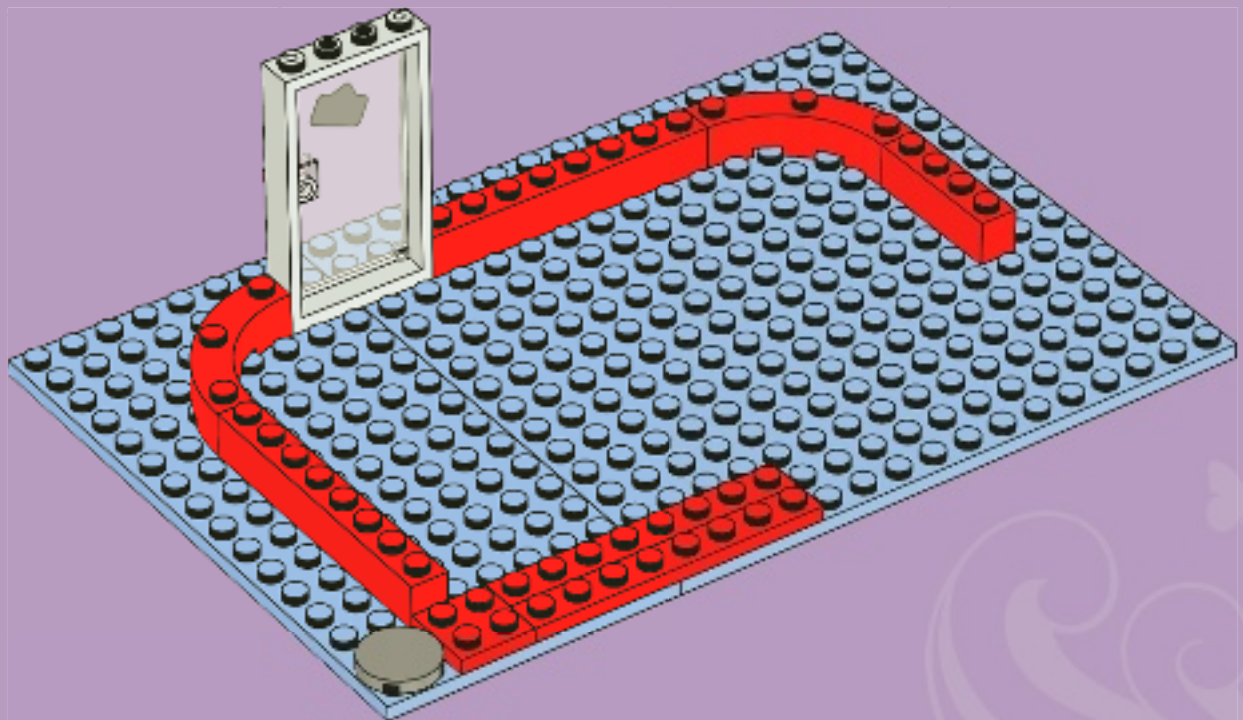

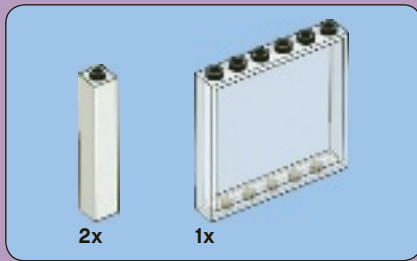

8

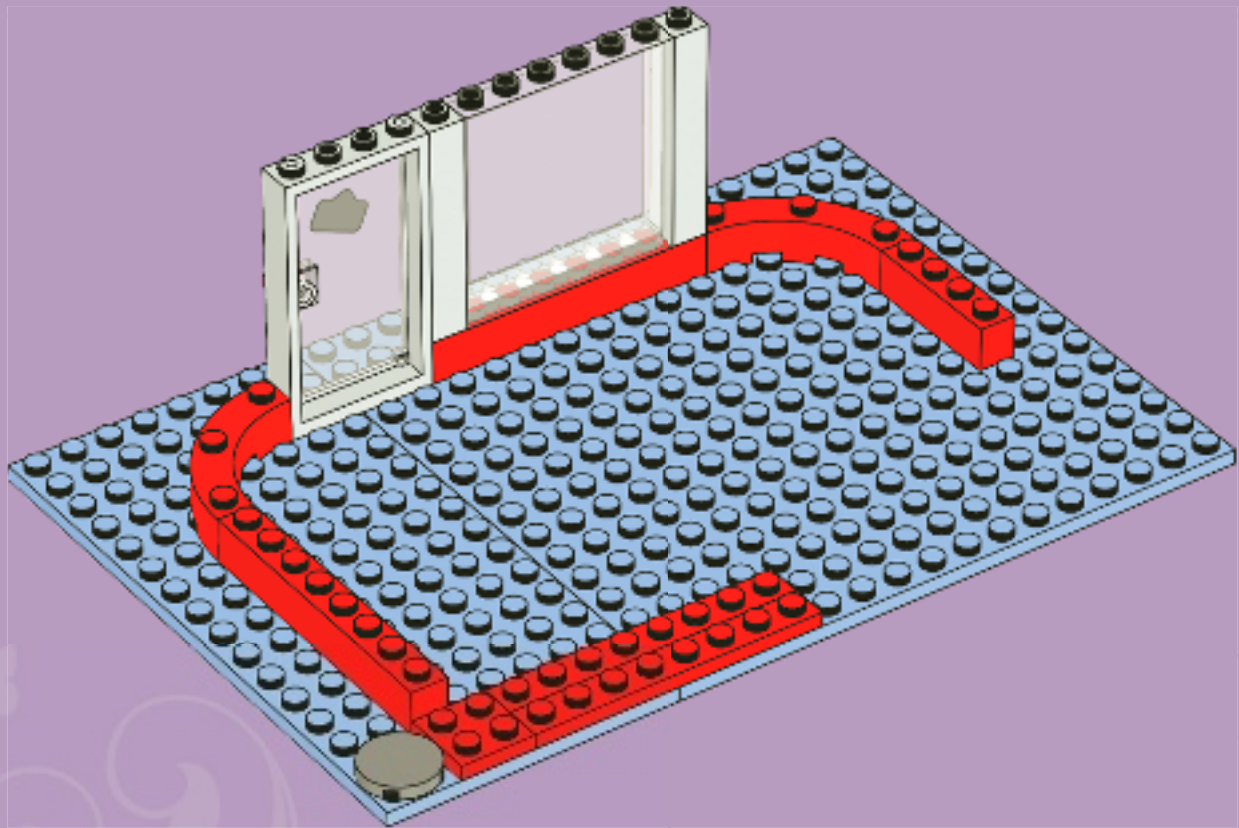

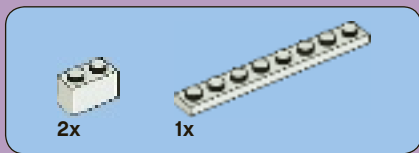

9

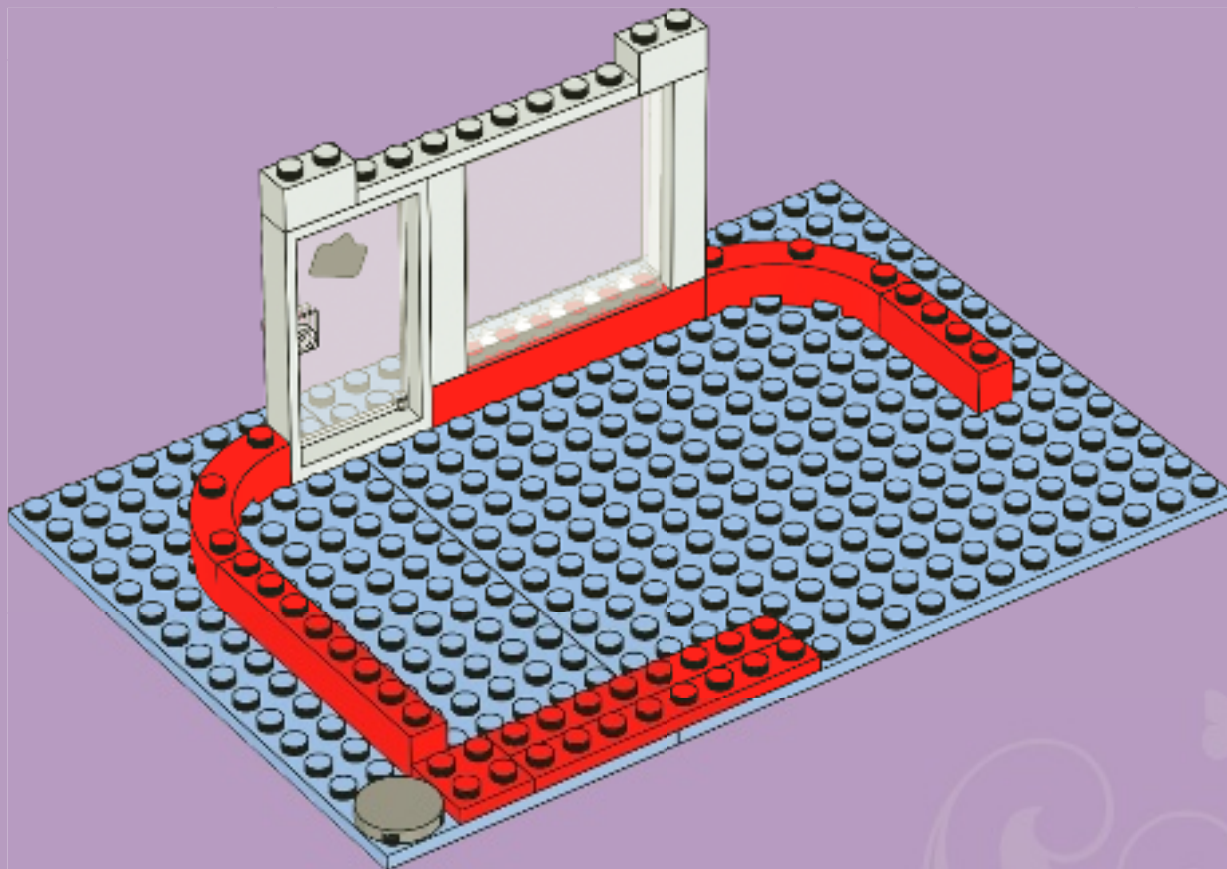

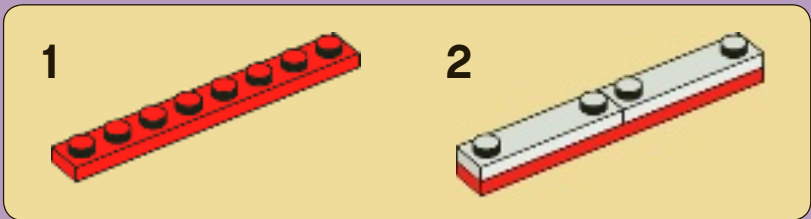

10

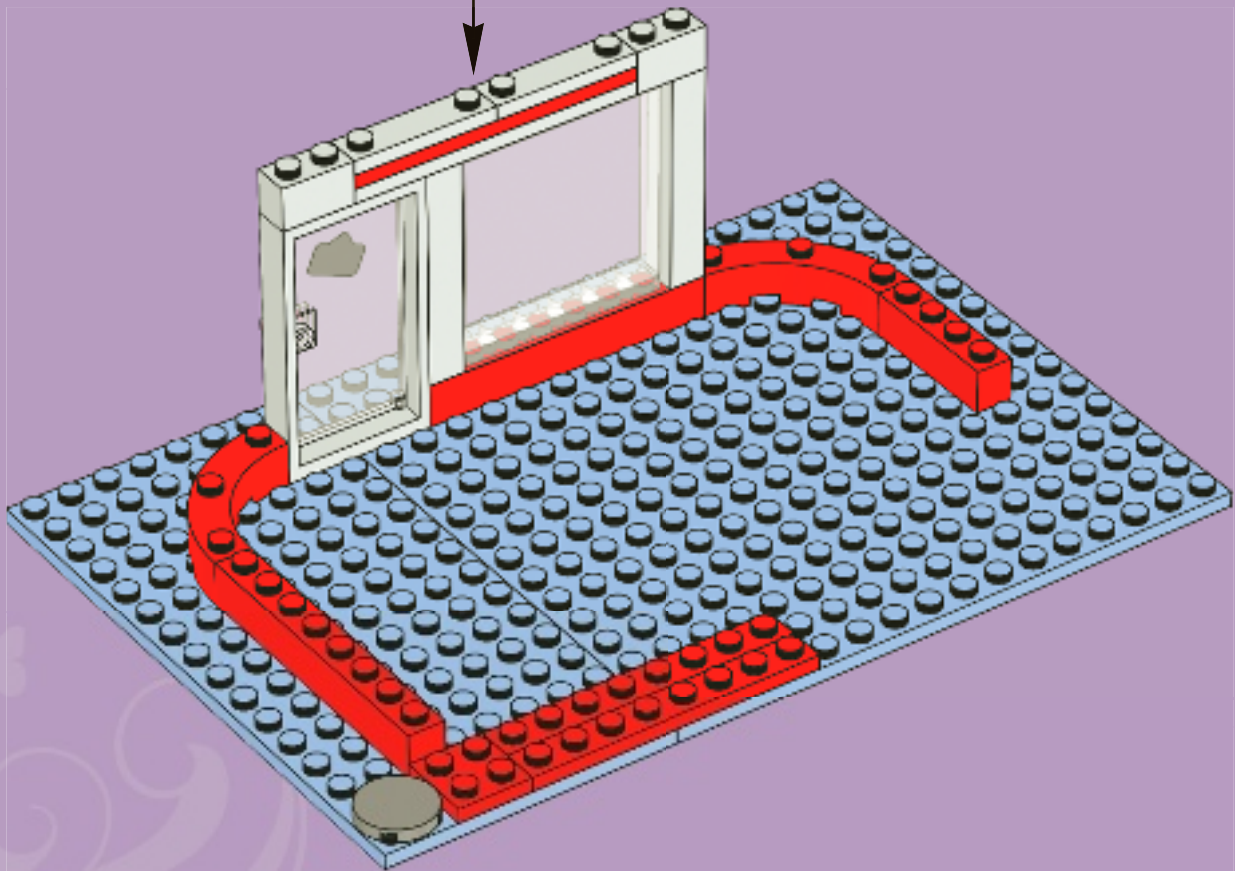



11

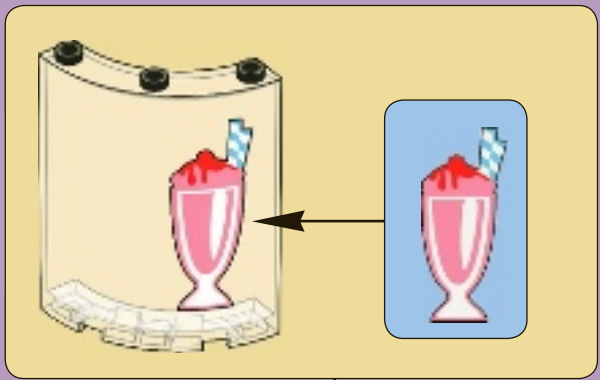
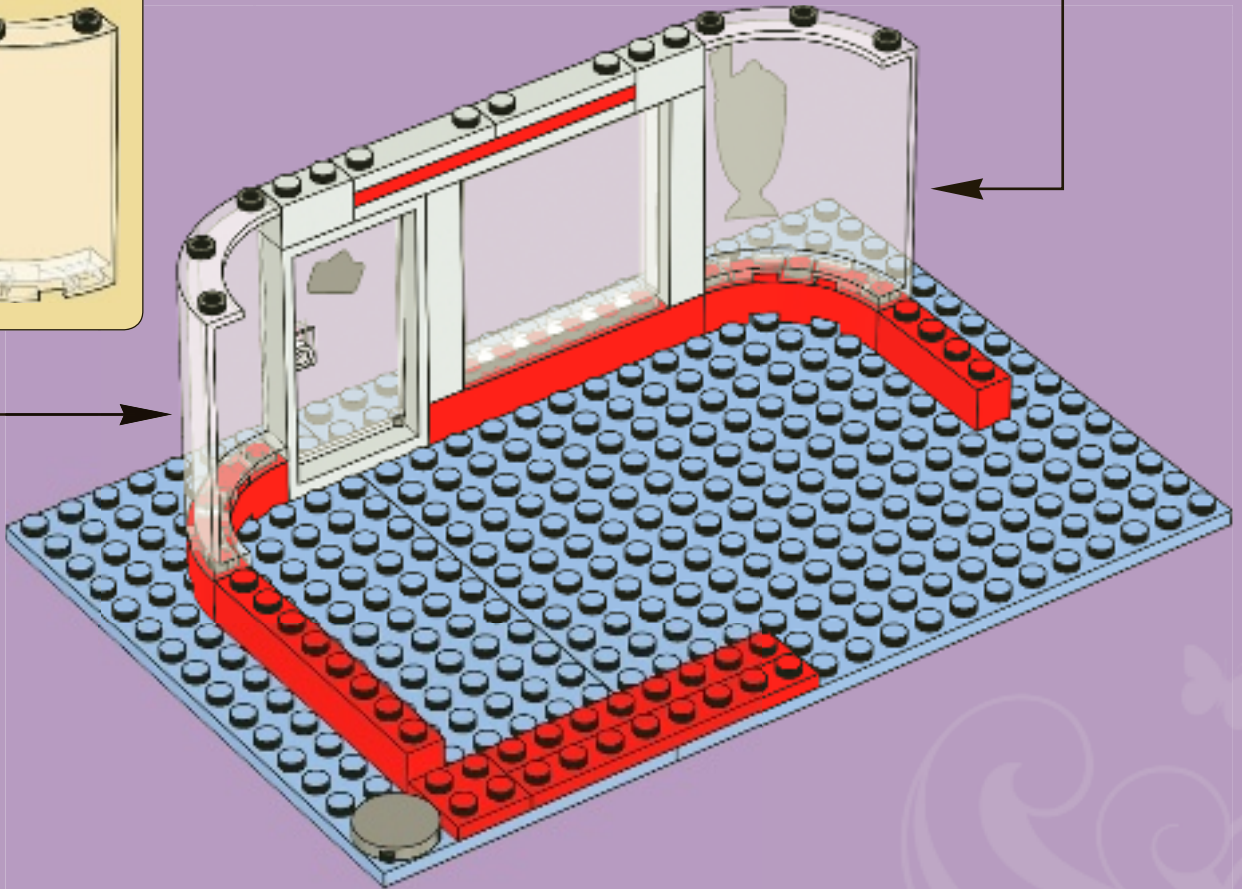
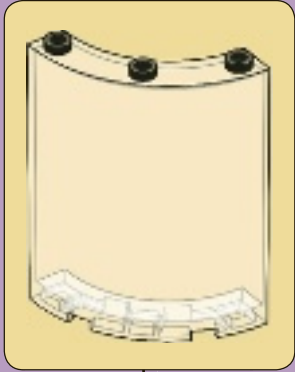



3x

12

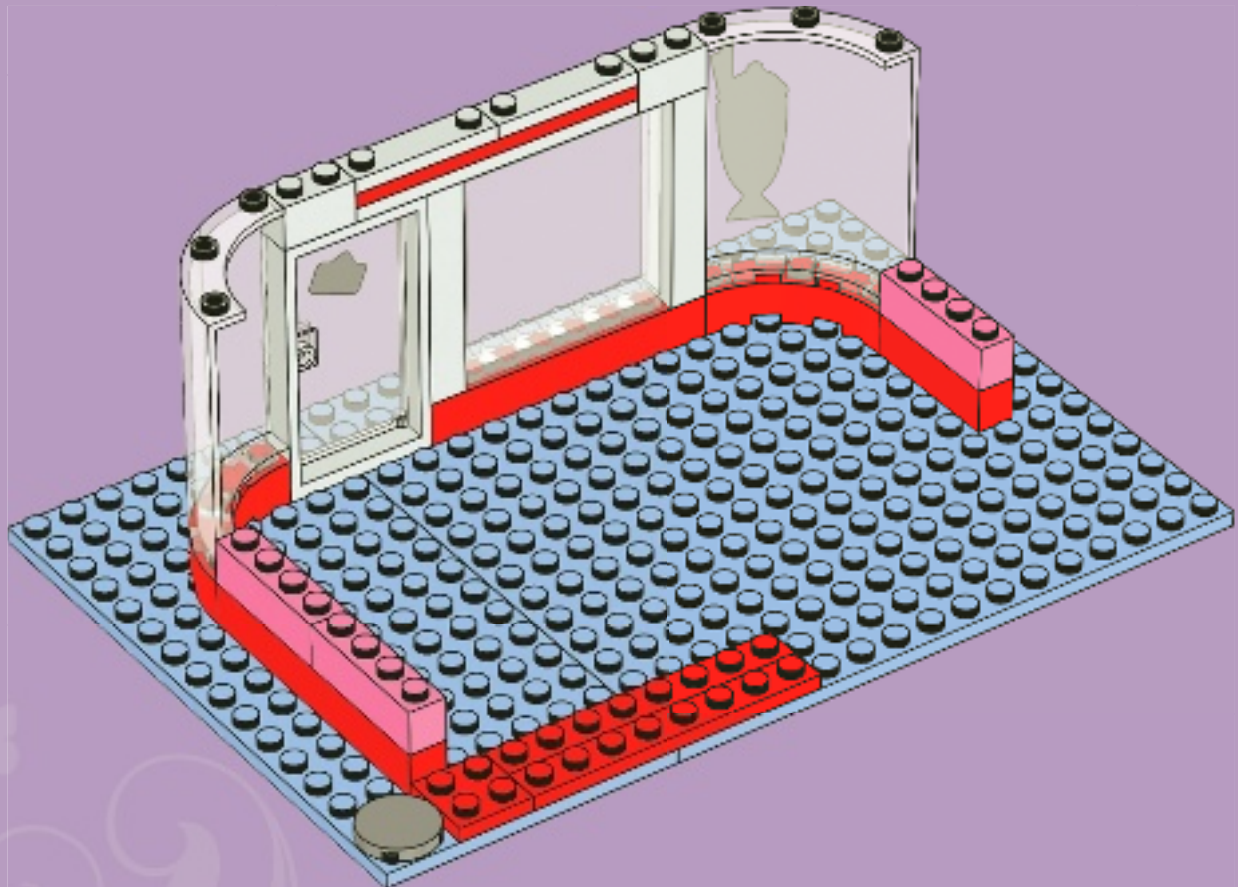

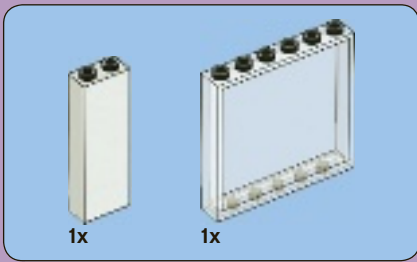

13

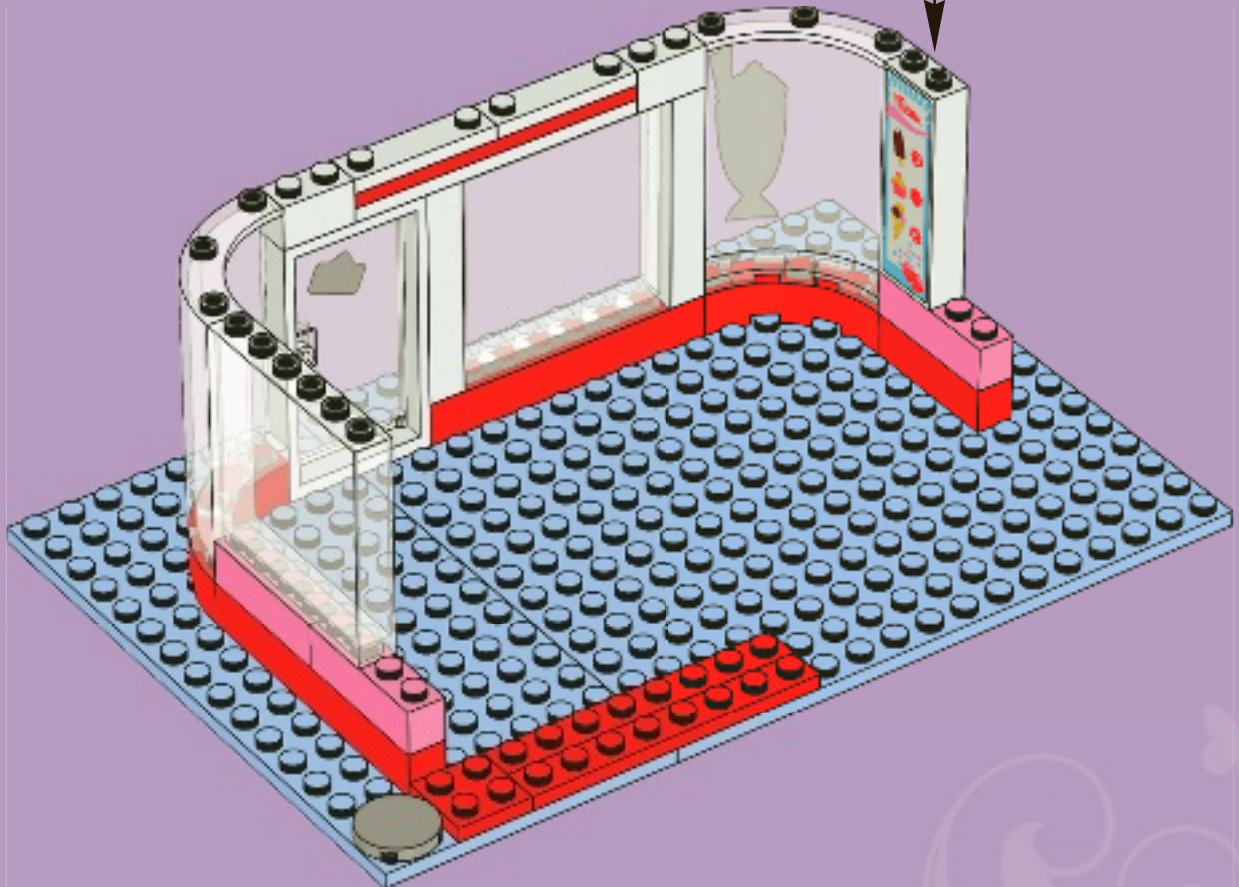
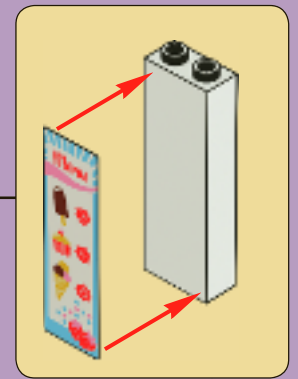



1x



1x

14

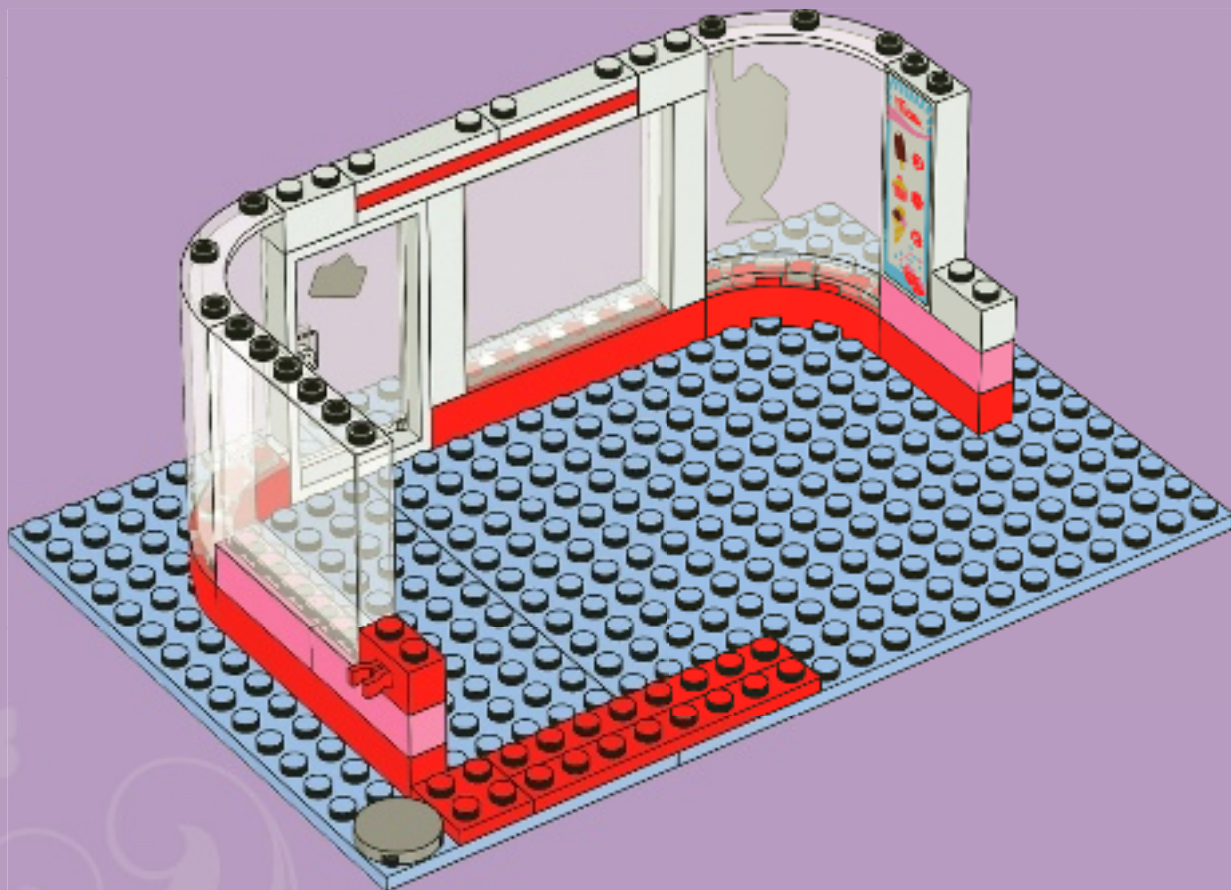



15

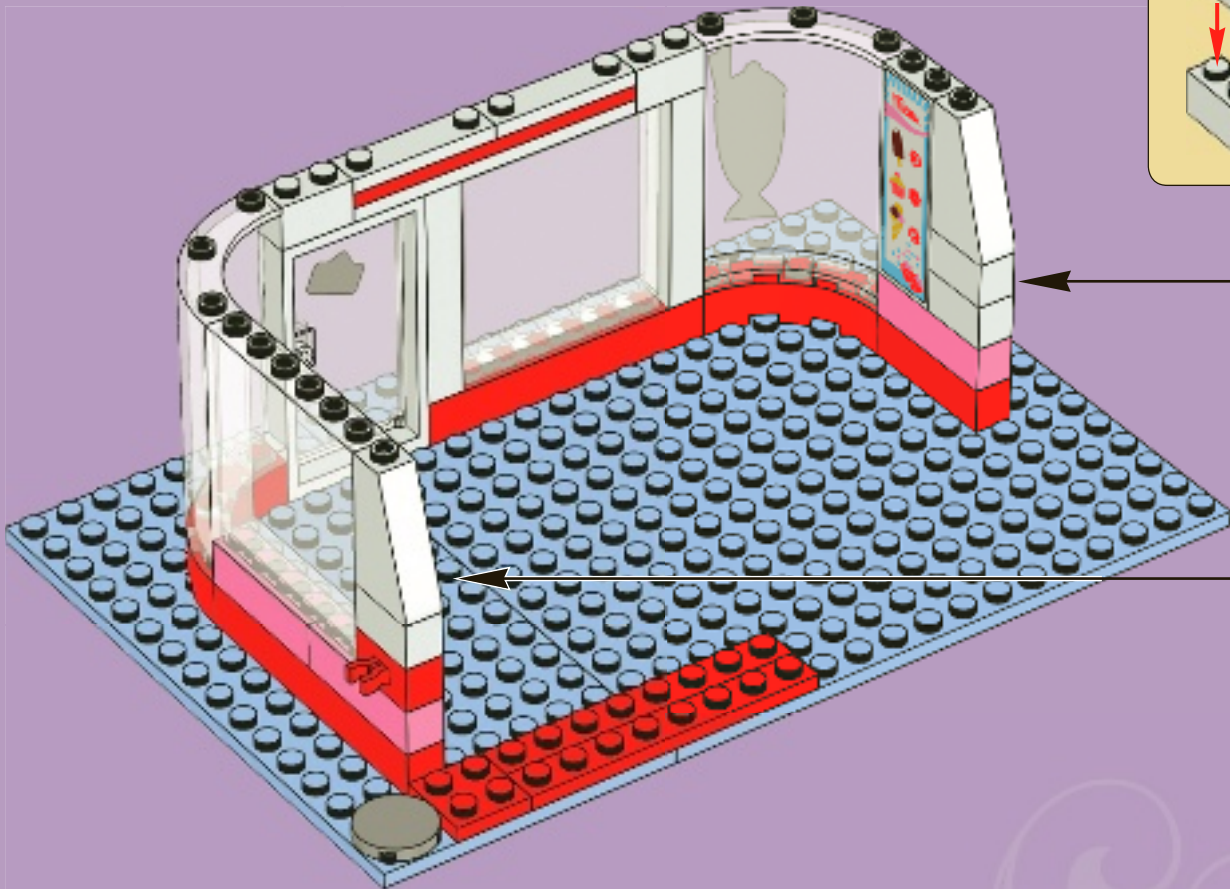
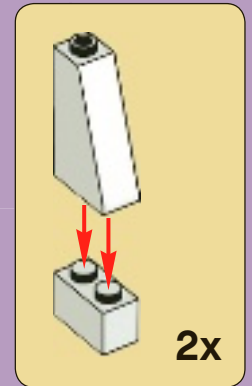

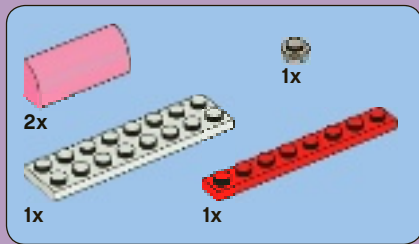

16

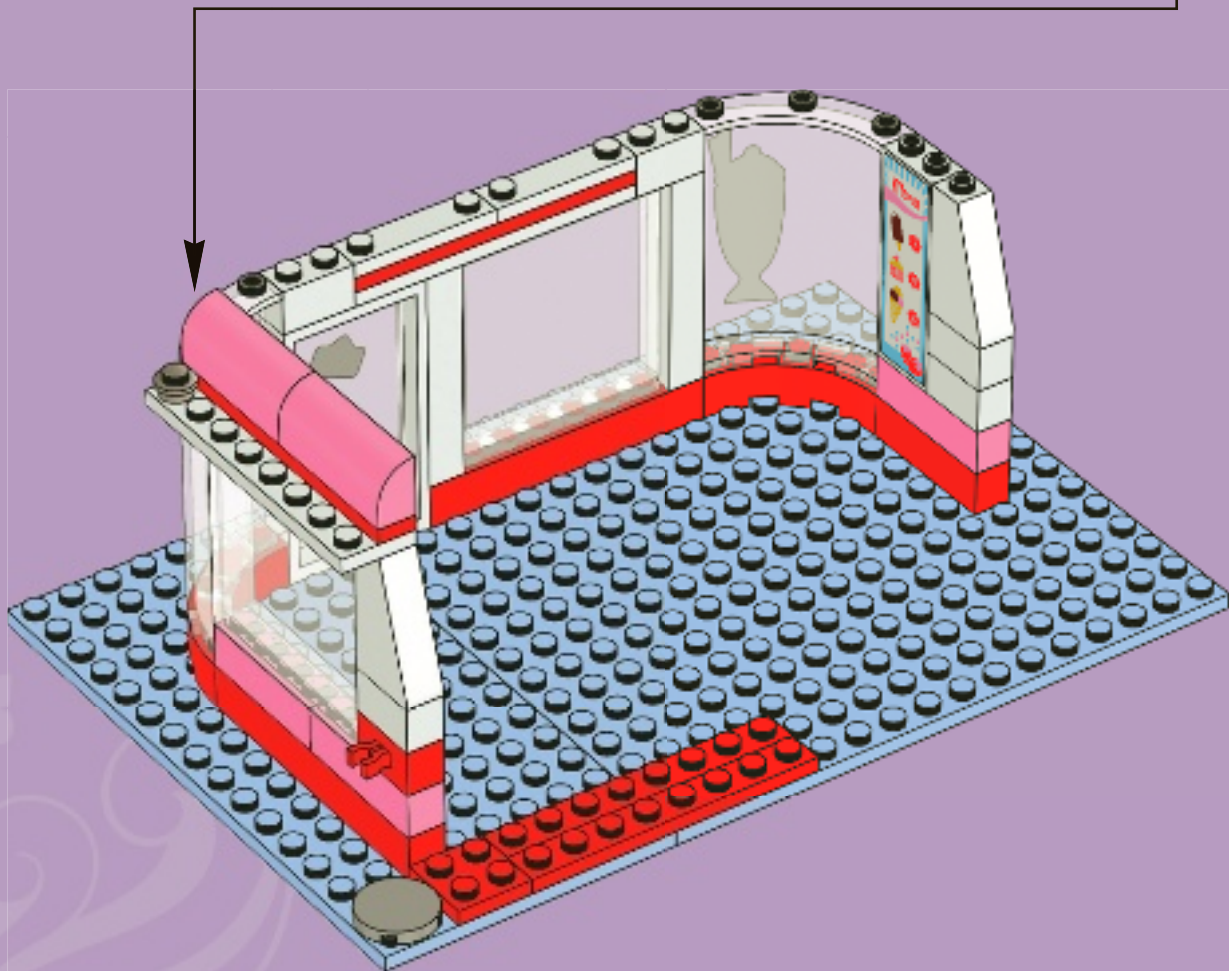
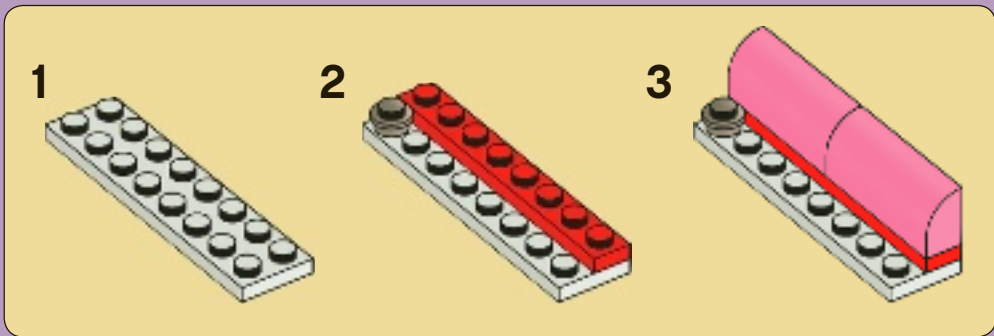

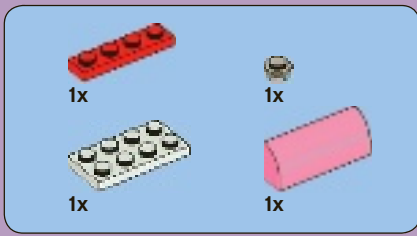

17

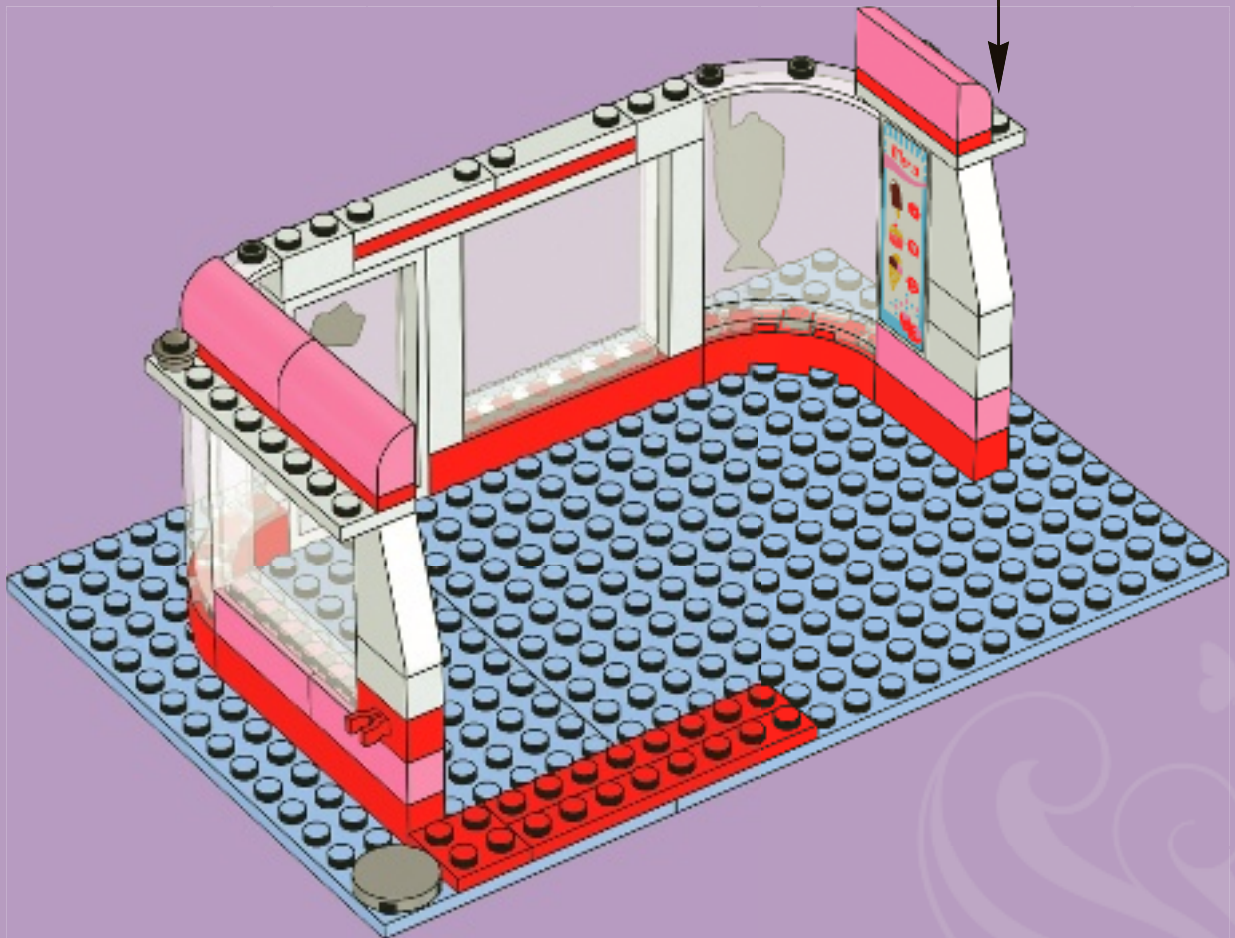



1x

1



1x

1x

2



1x

3

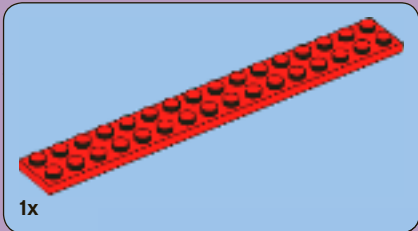

1x

4

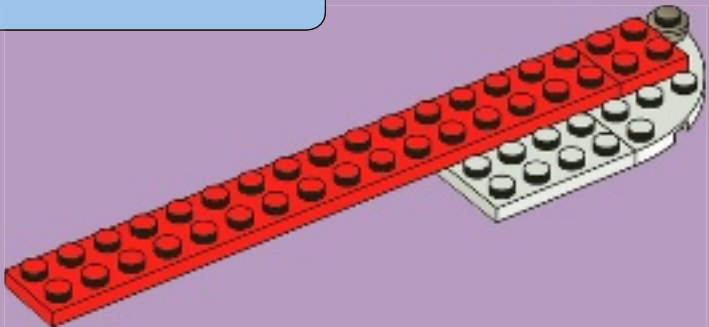

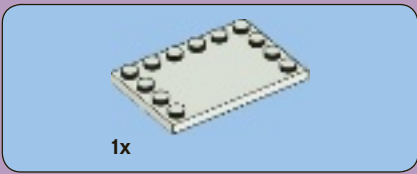

5

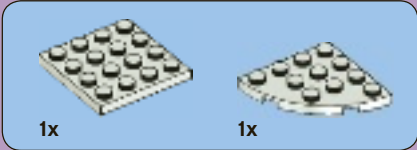
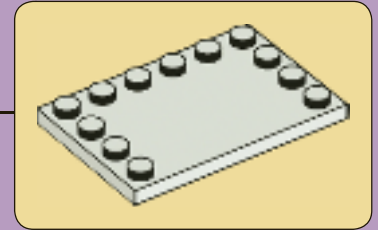
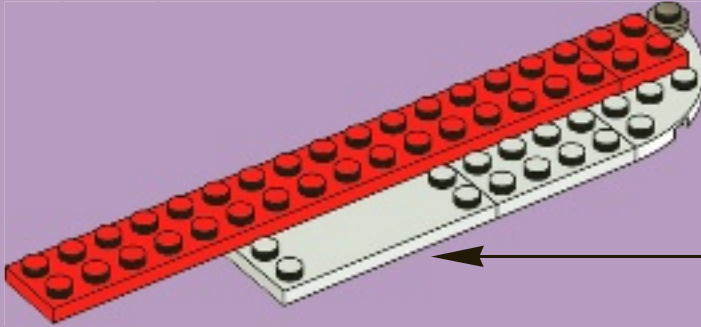

6

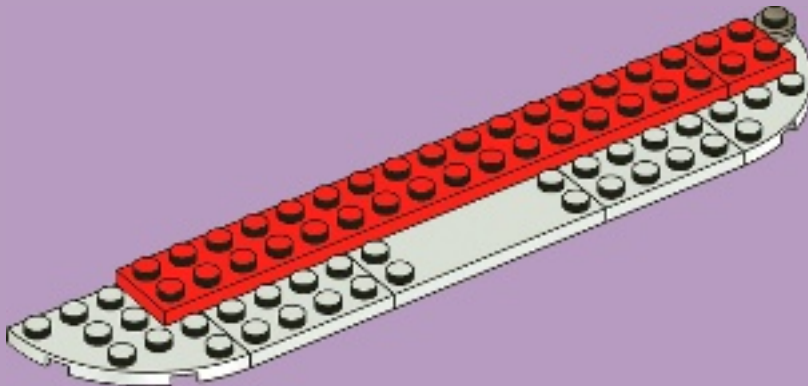



1x



1x

7

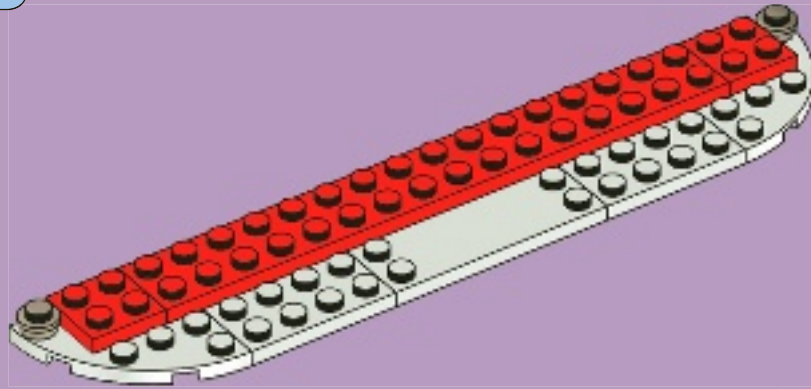

2x



2x

8

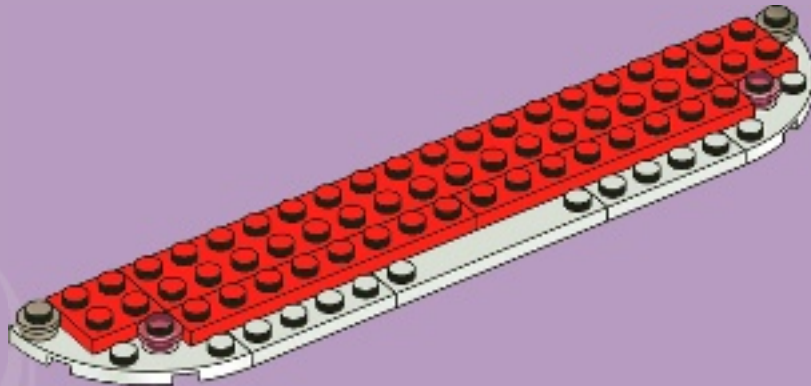



9

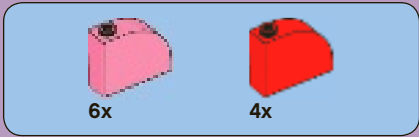
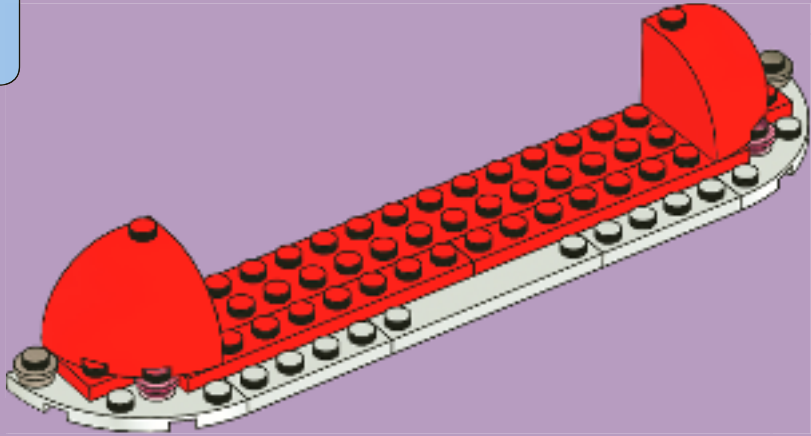

10

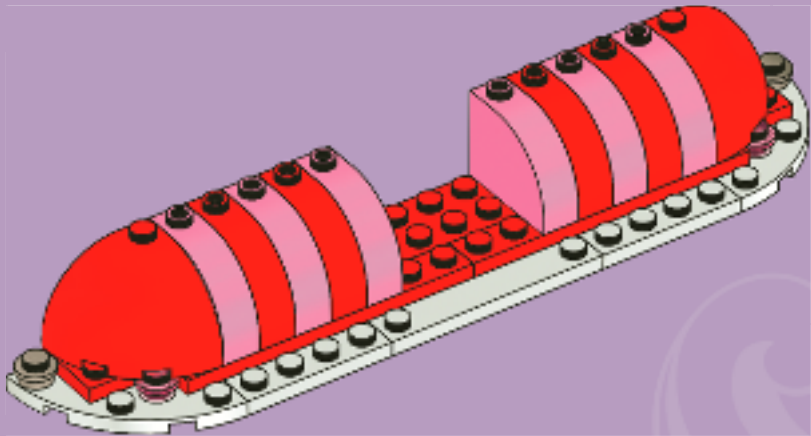



11

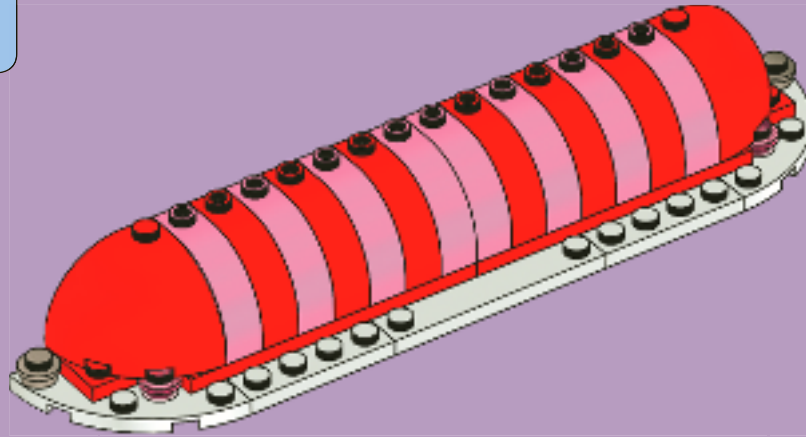

12

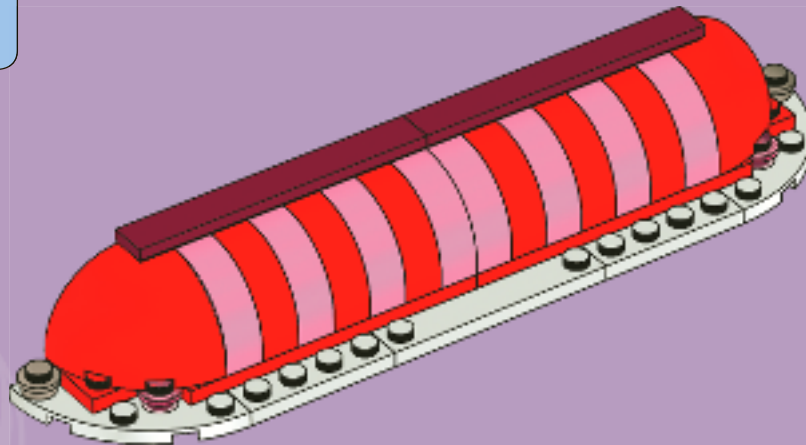

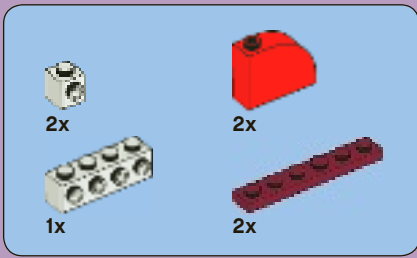

13

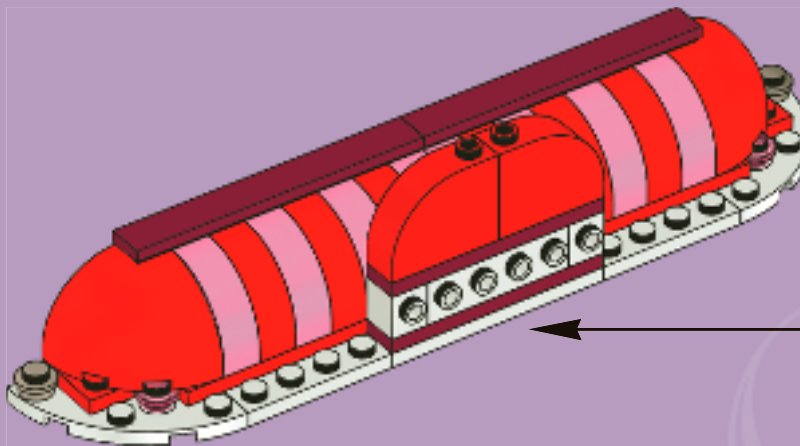
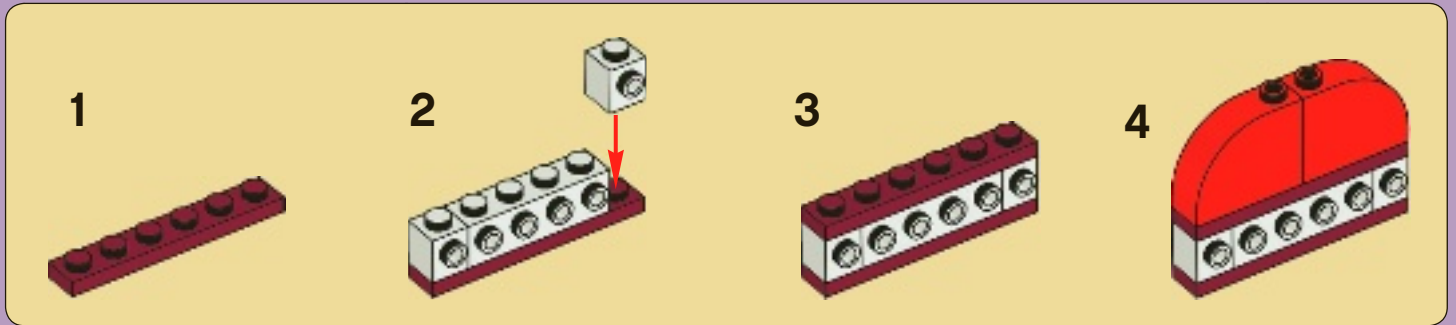



14

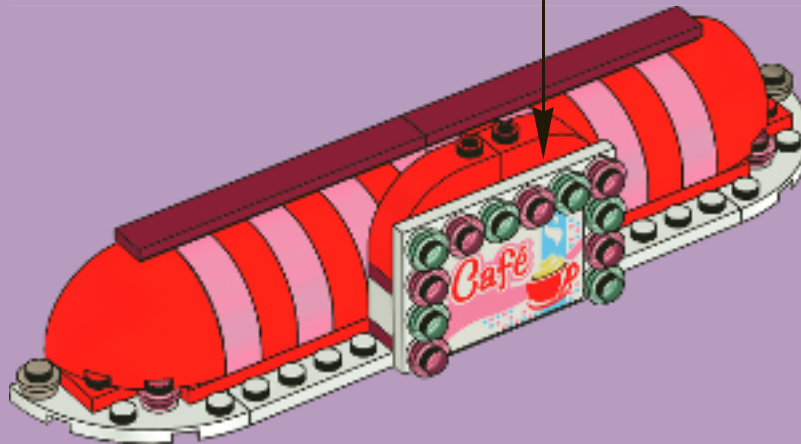
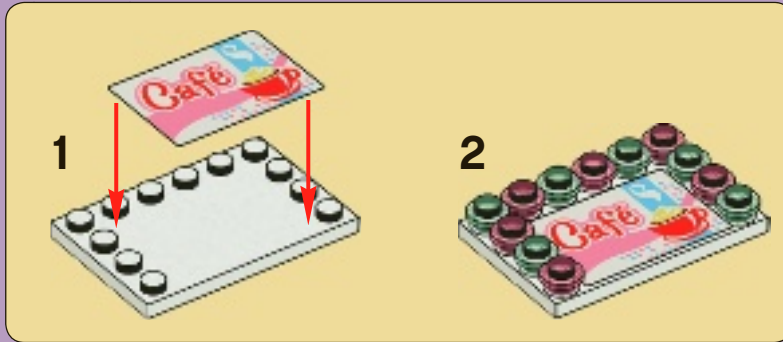

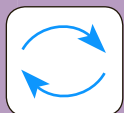

15





2x

16





1x

17



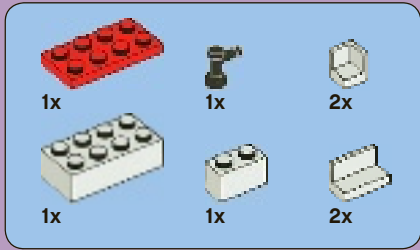
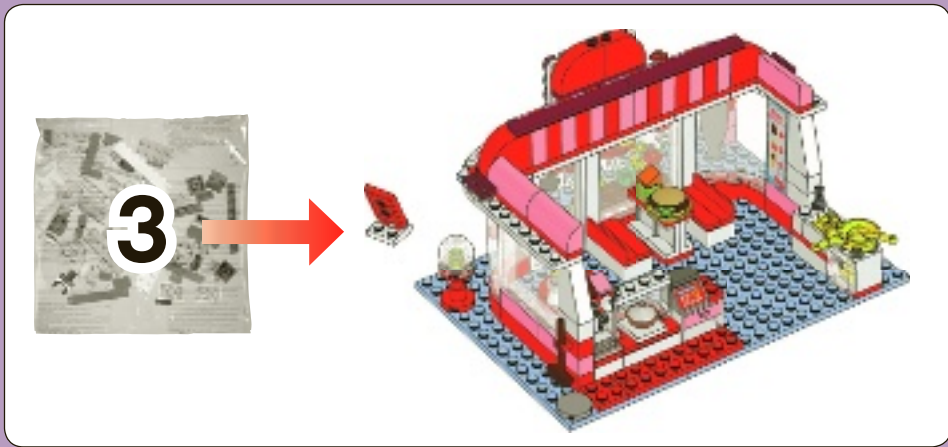

18

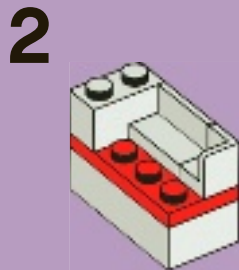

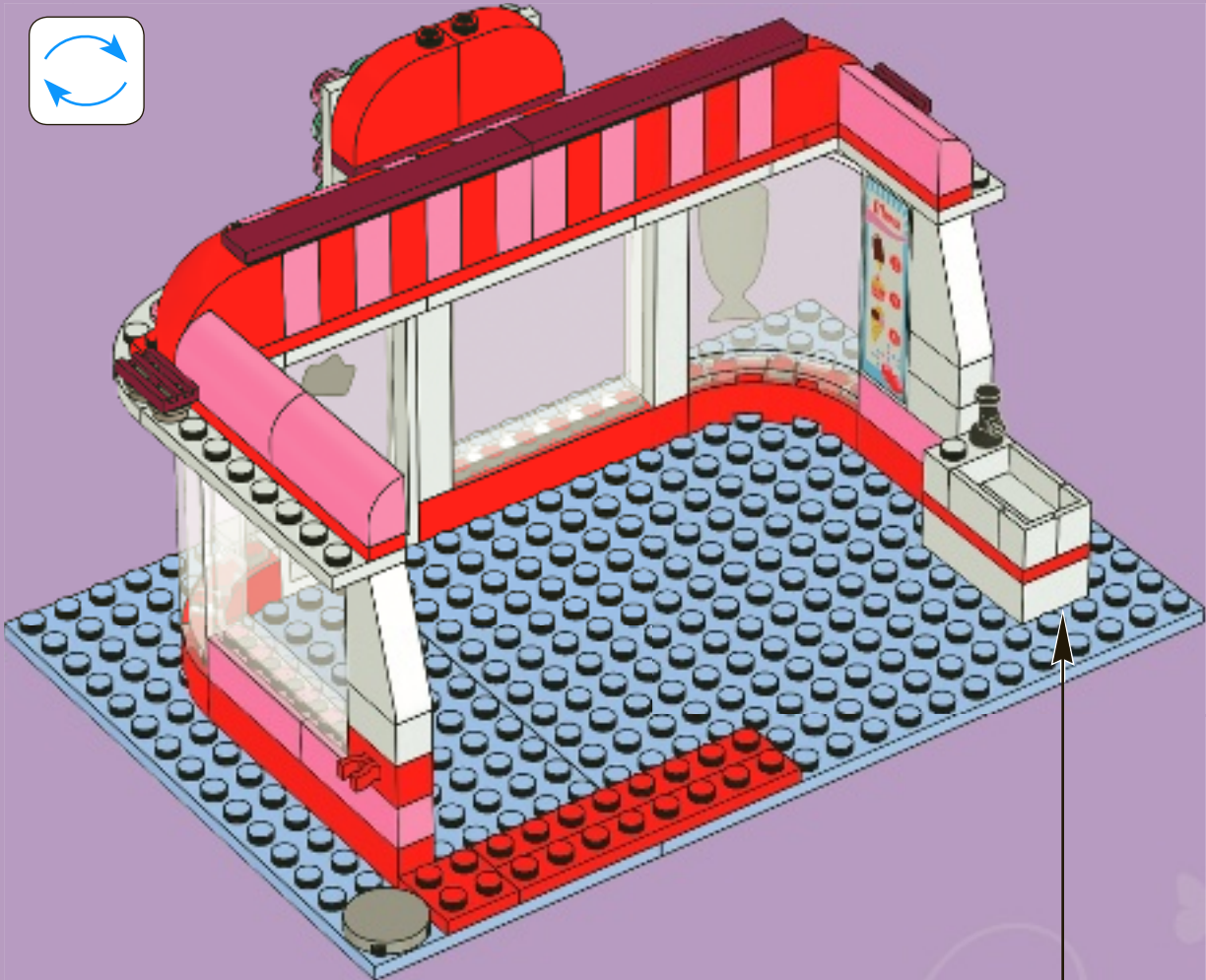

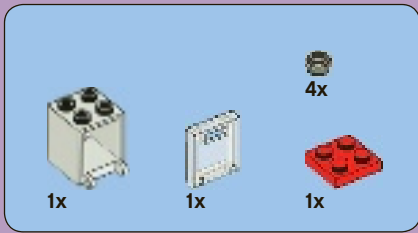

19

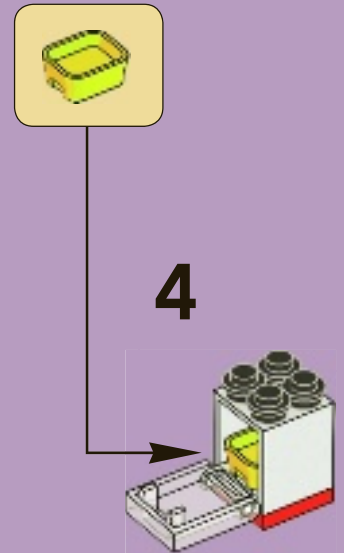
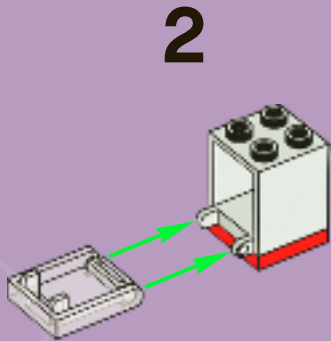

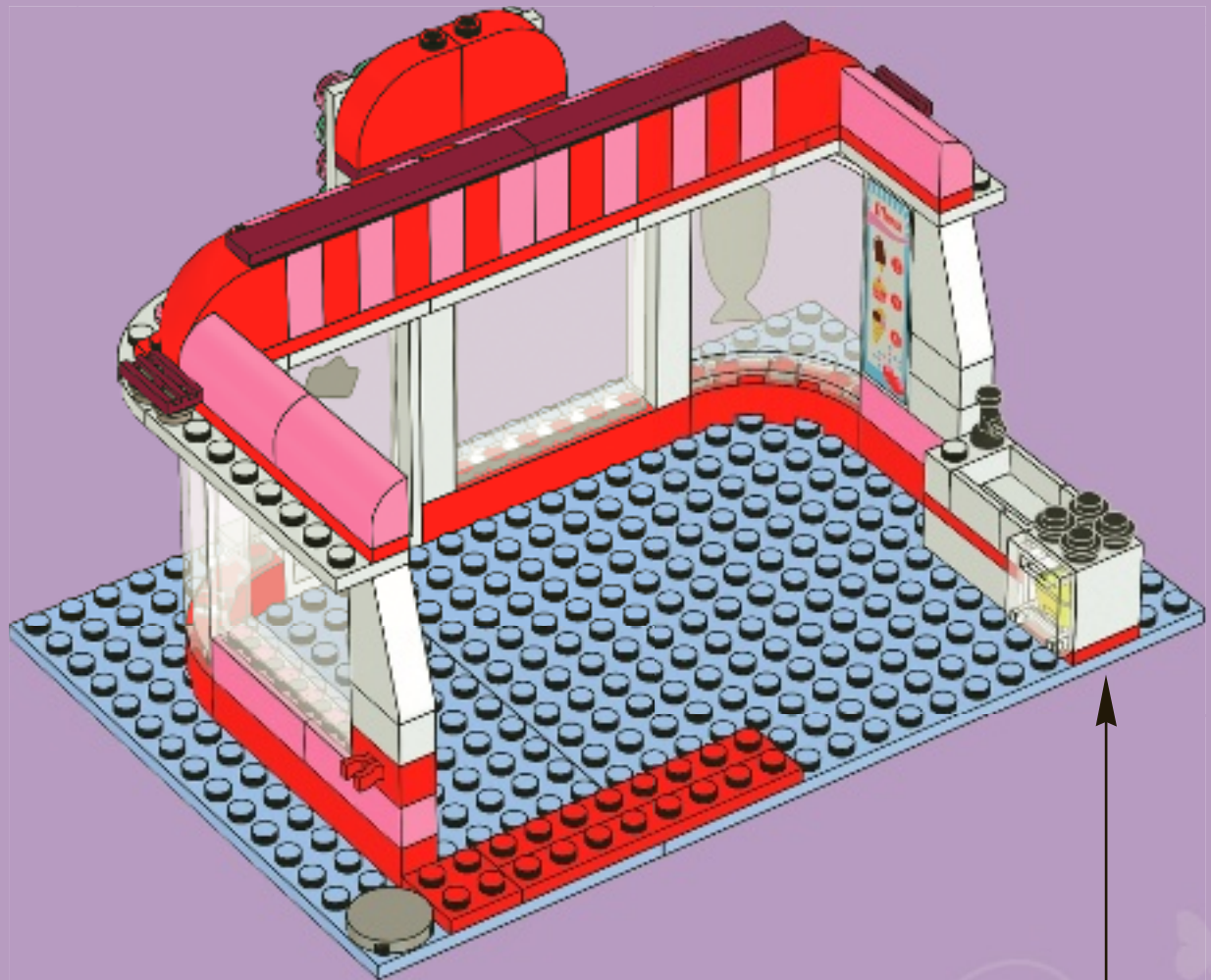

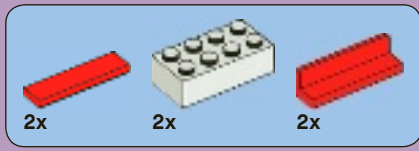

20

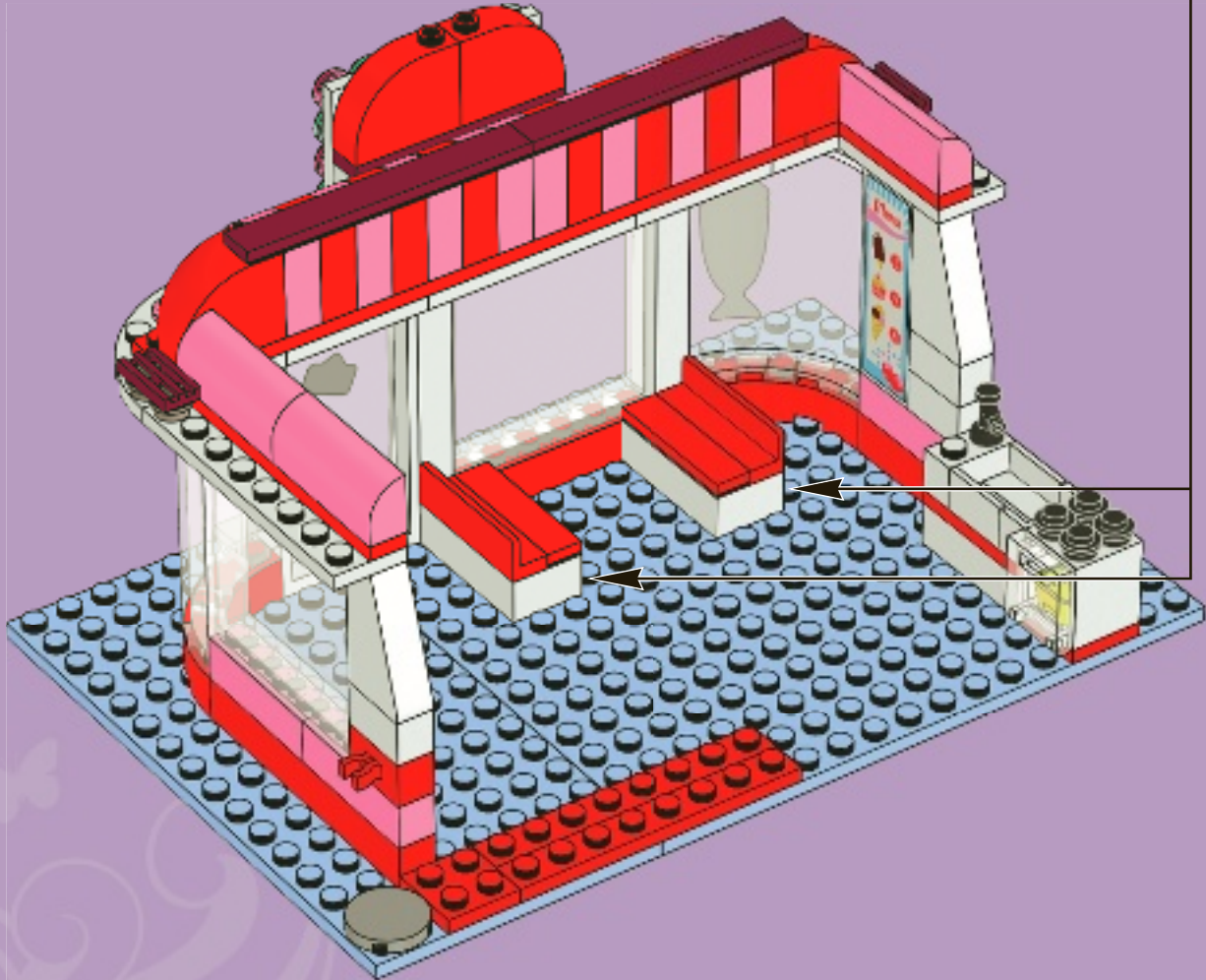
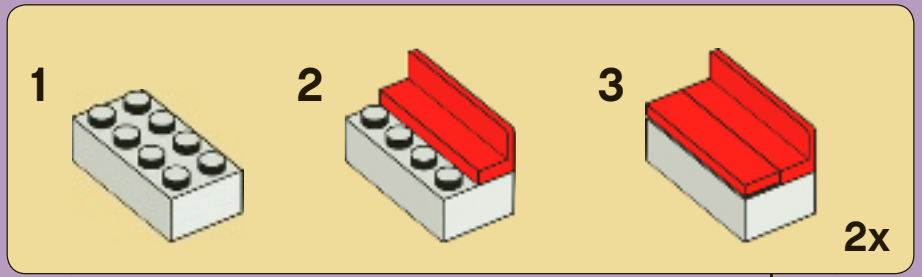

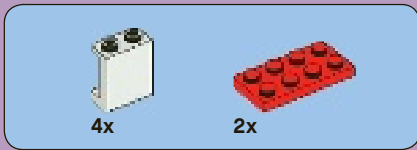

21

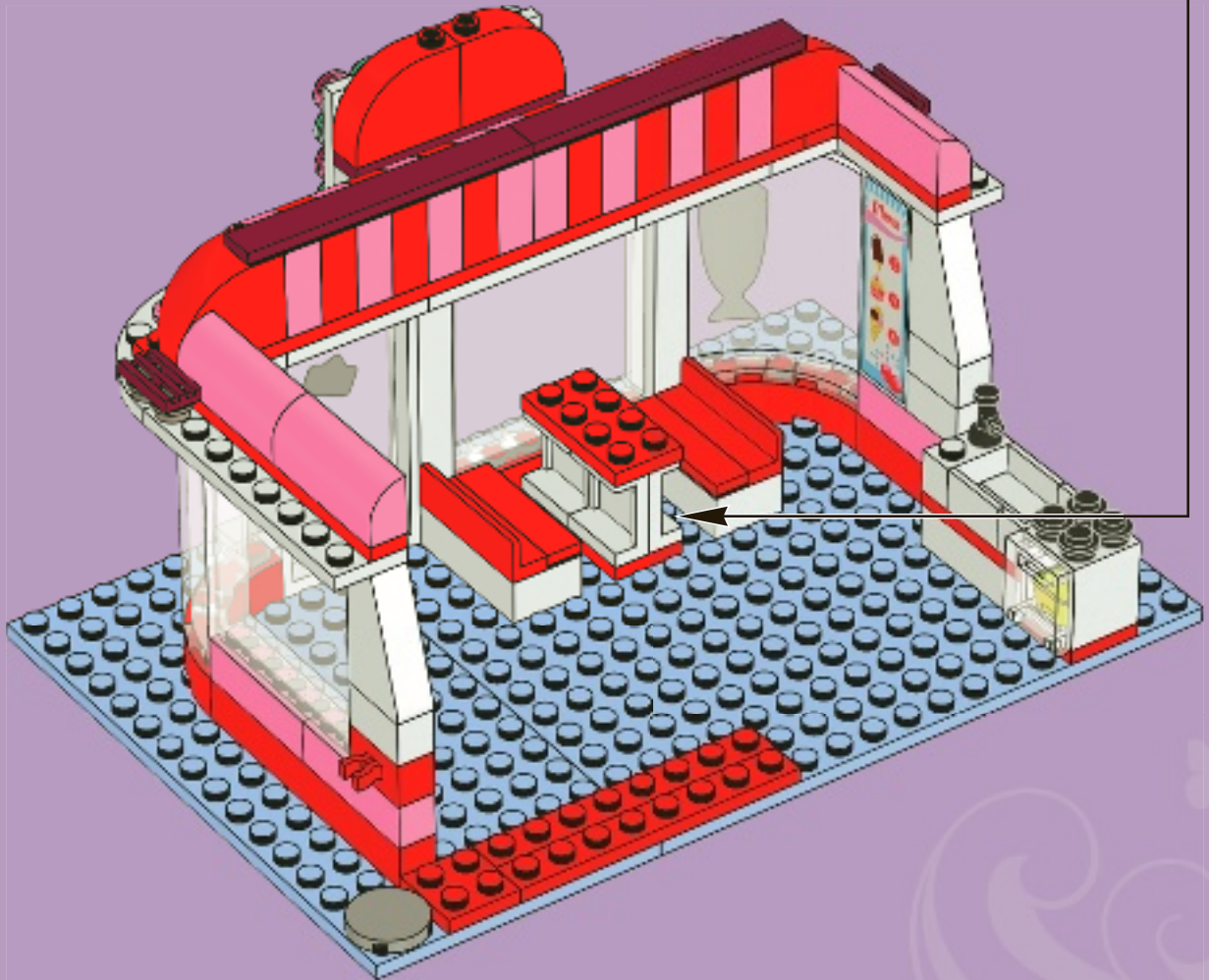
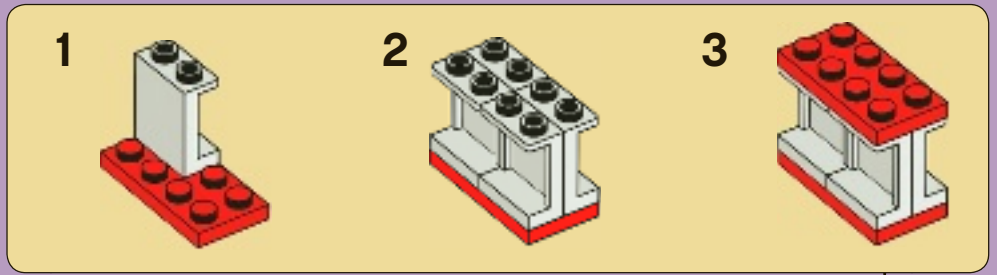



22

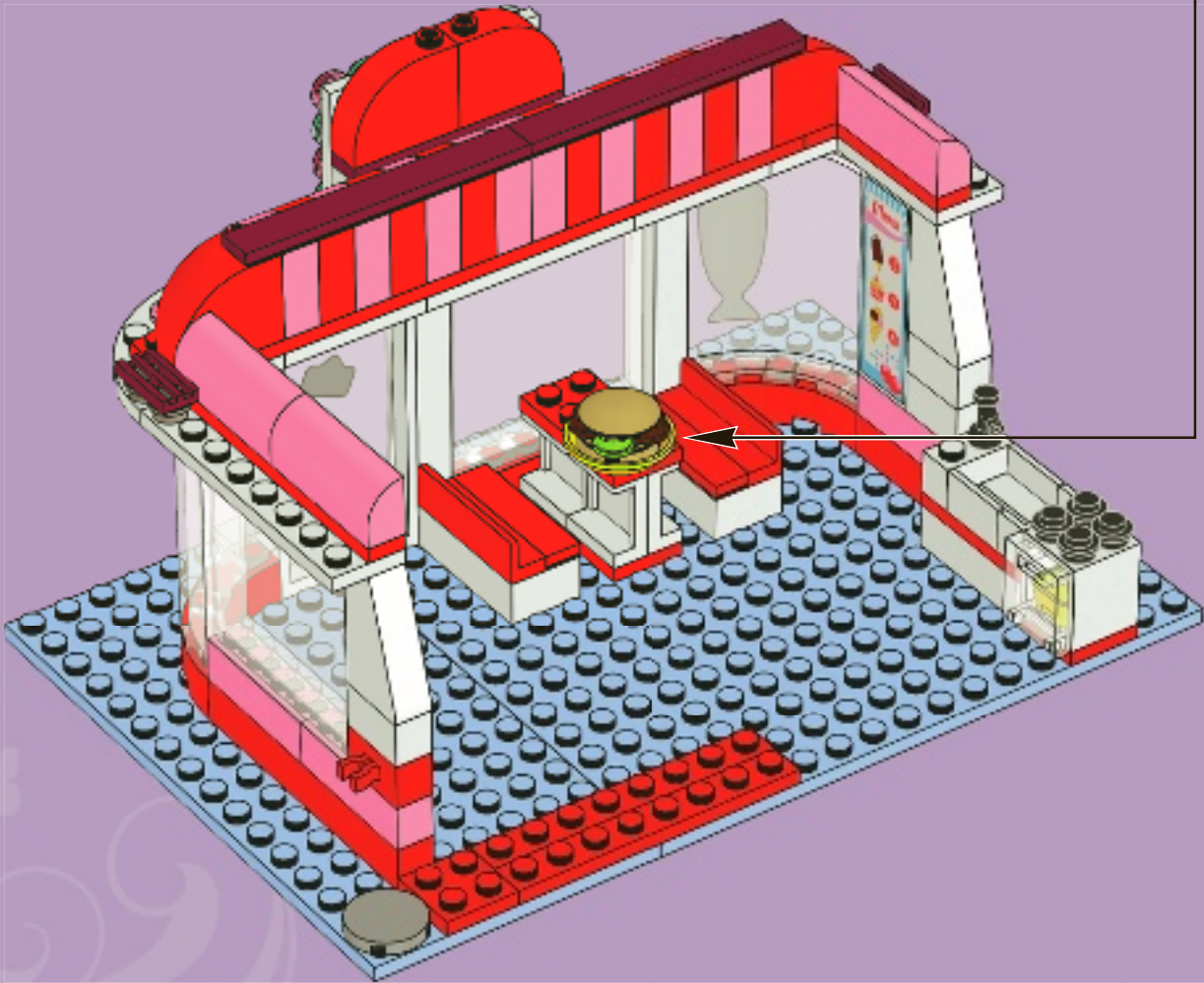



23

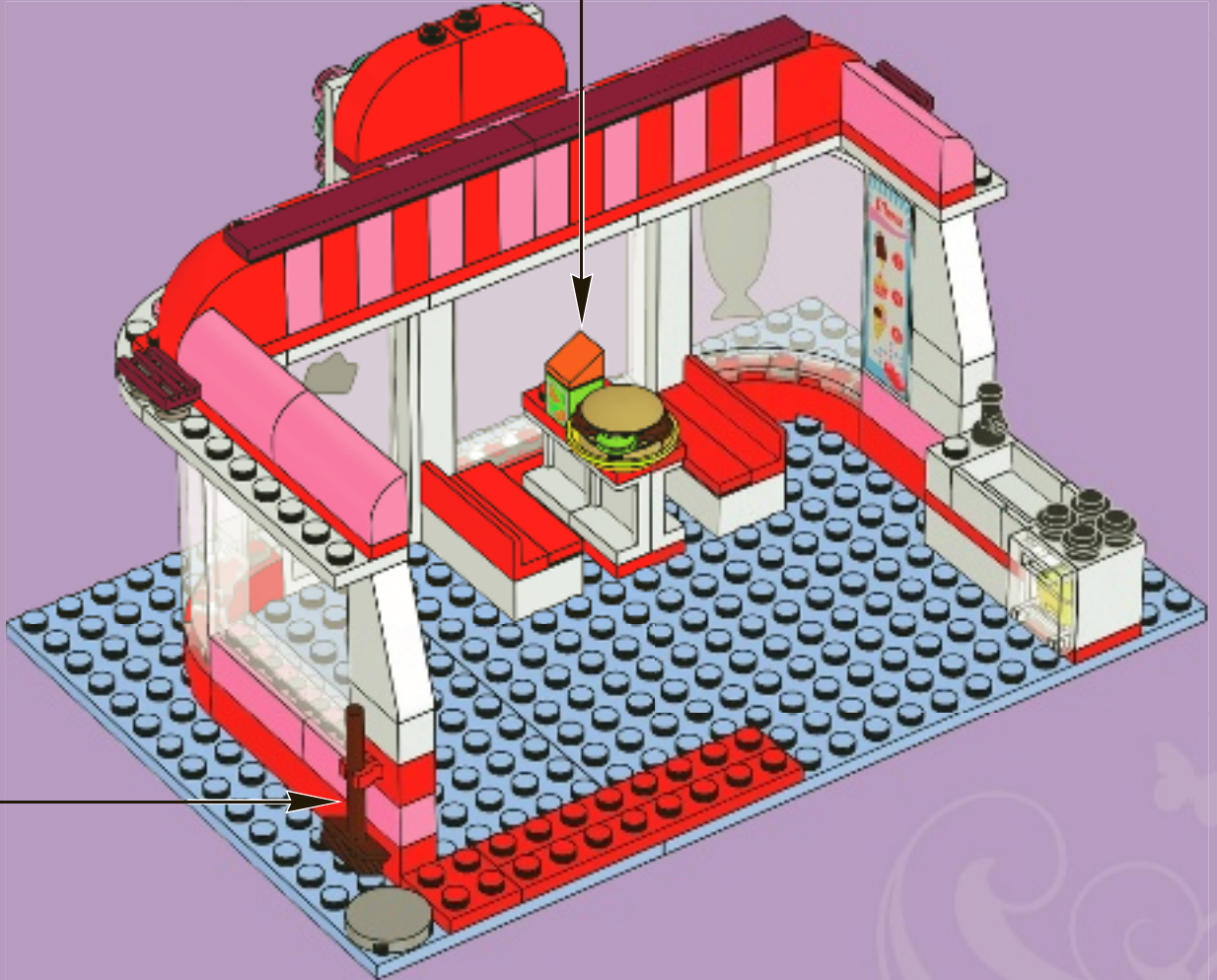
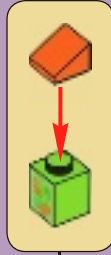

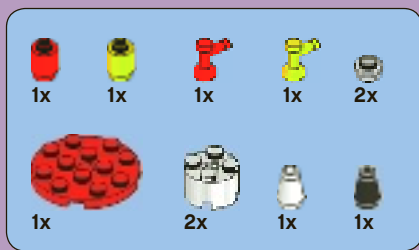

24

1



2



3

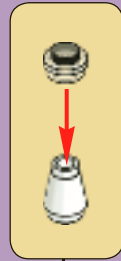

4



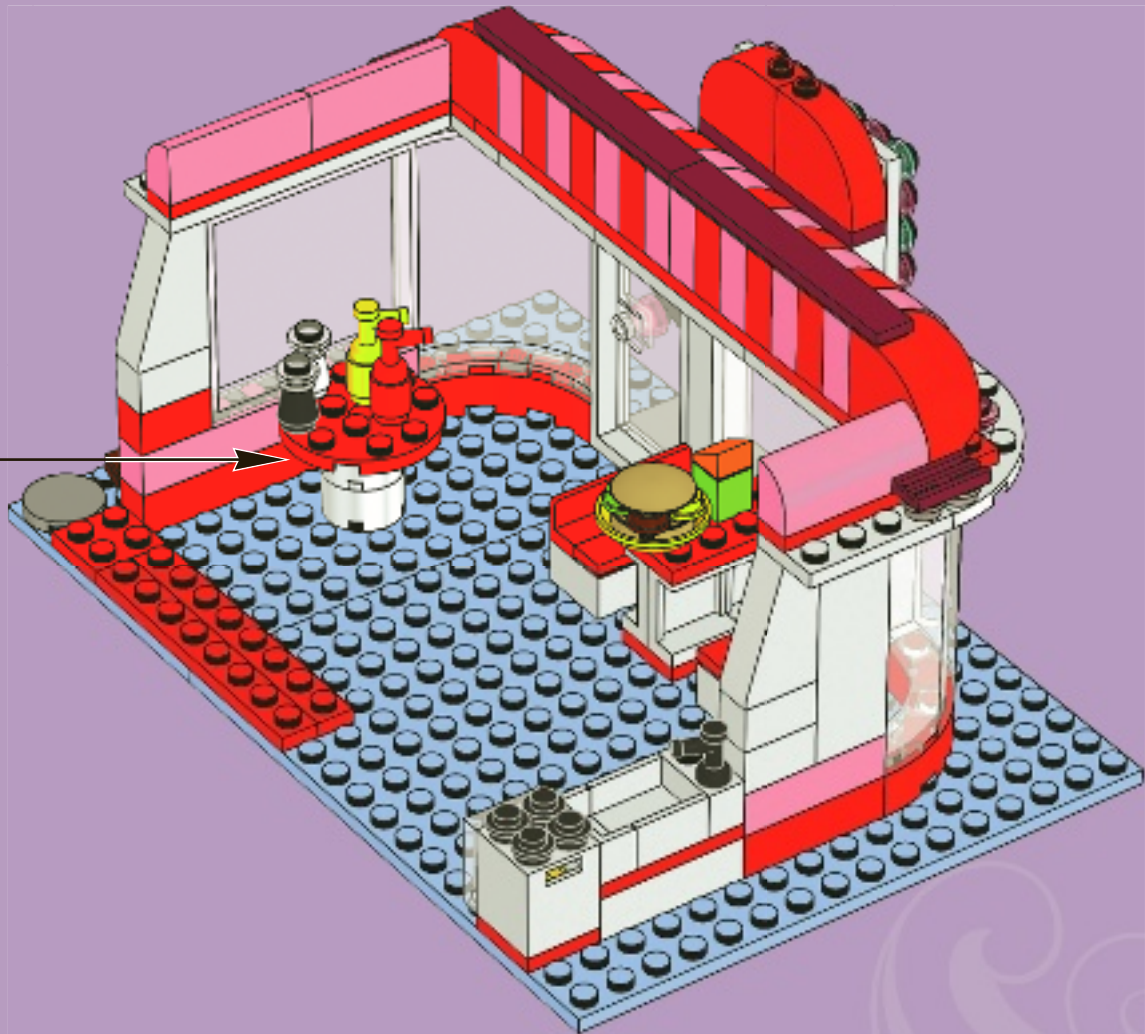

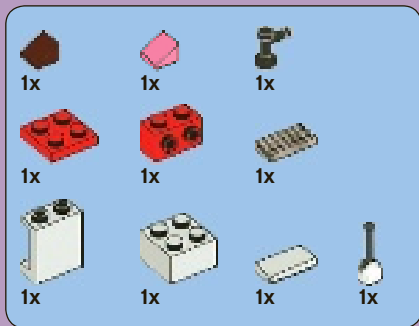

25

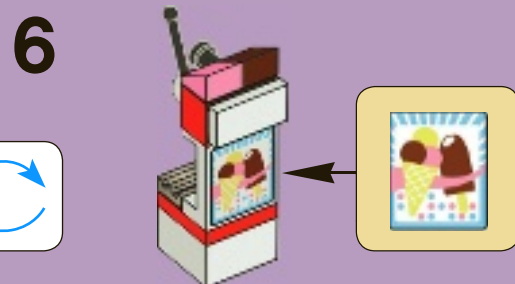
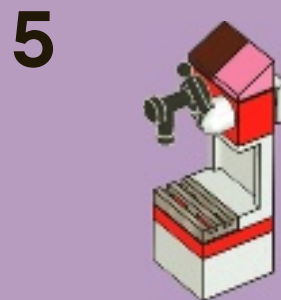
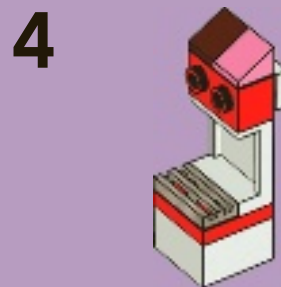
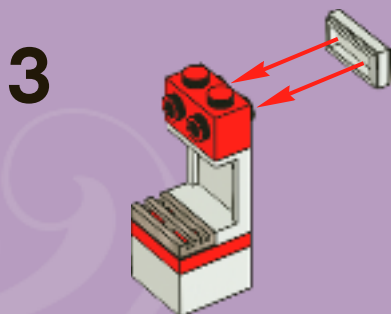
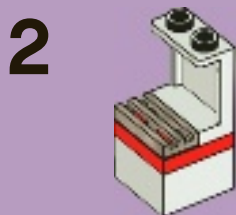
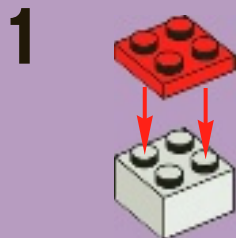

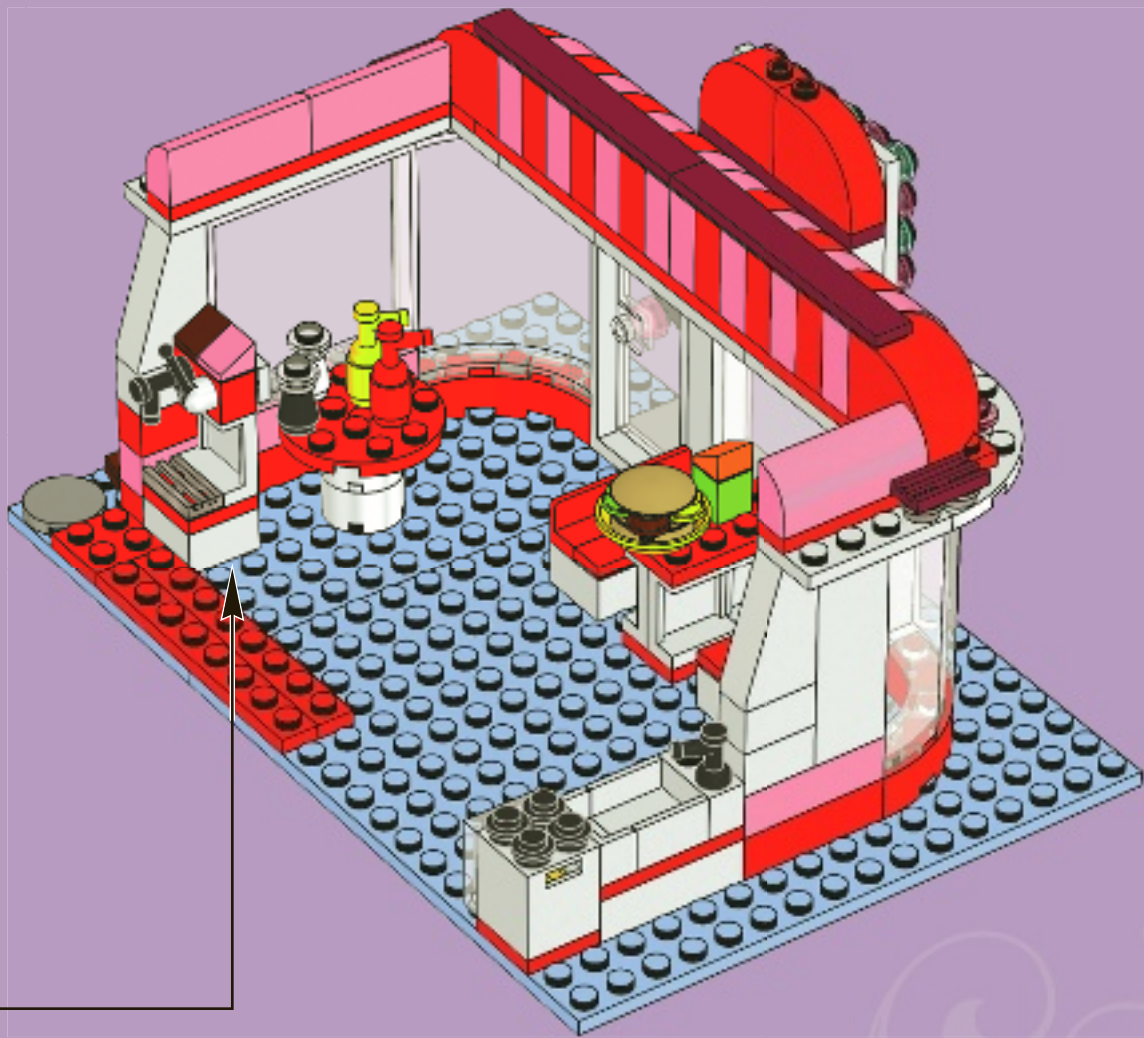

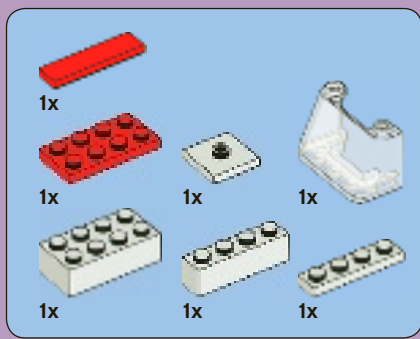

26

1

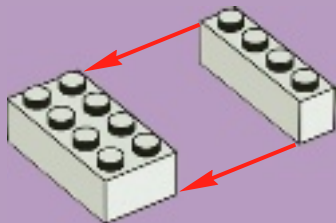

2



3

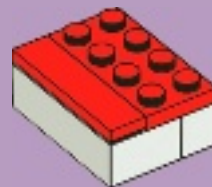

4



5



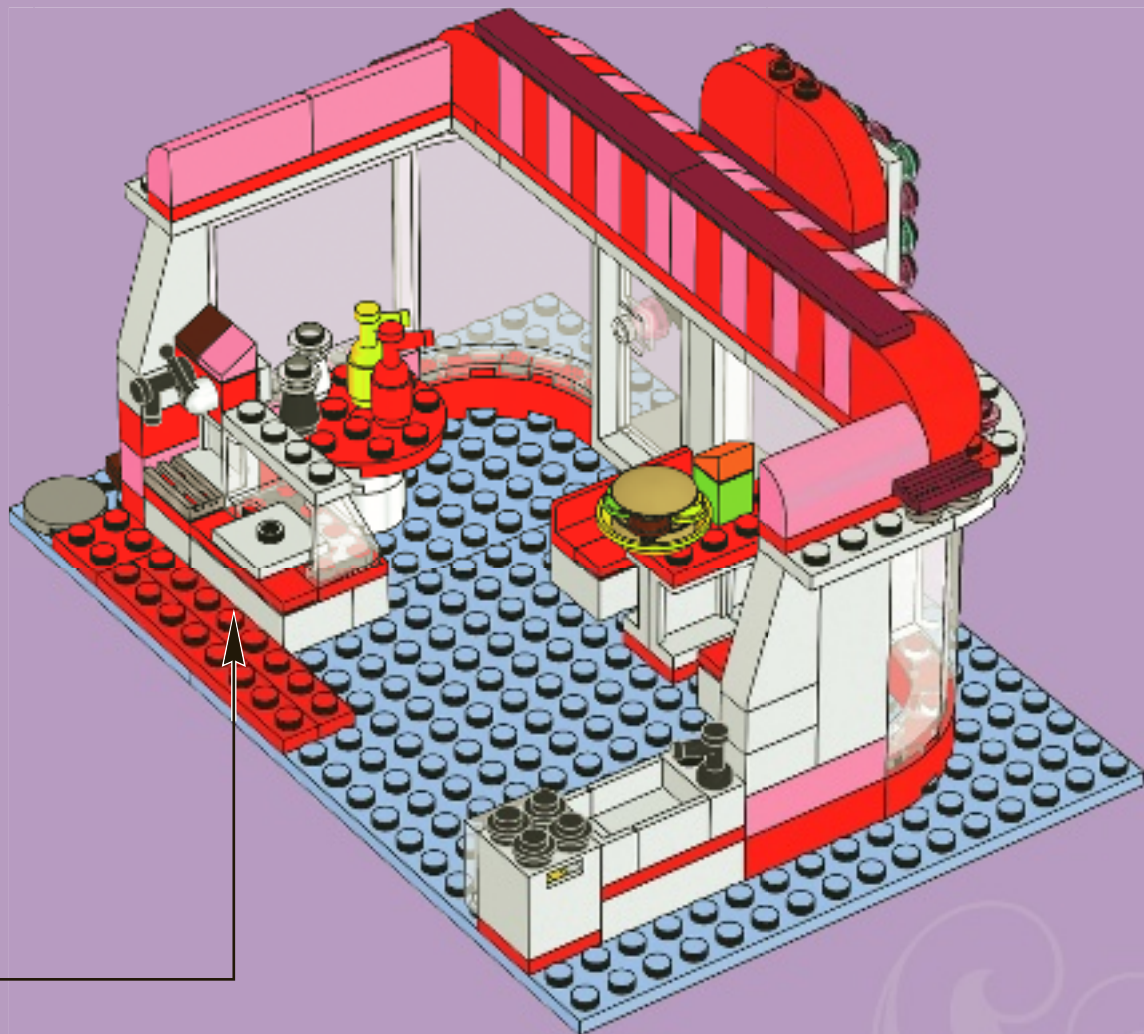

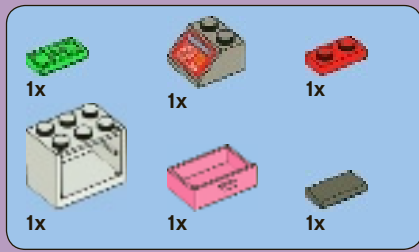

27

1

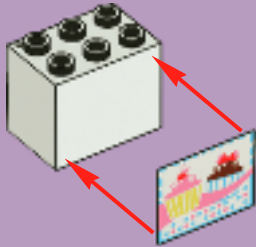

2

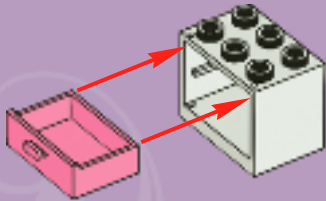

3



4



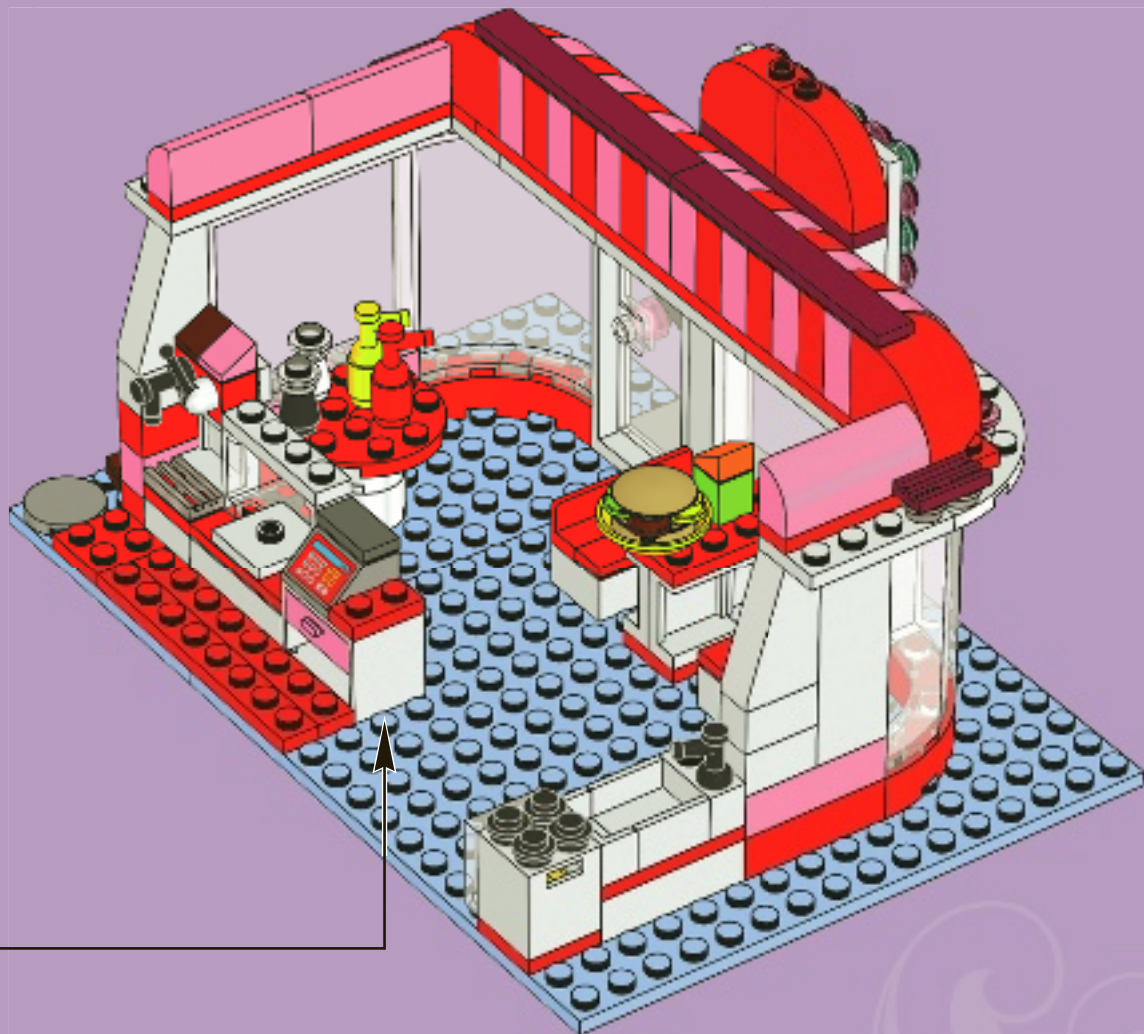

28

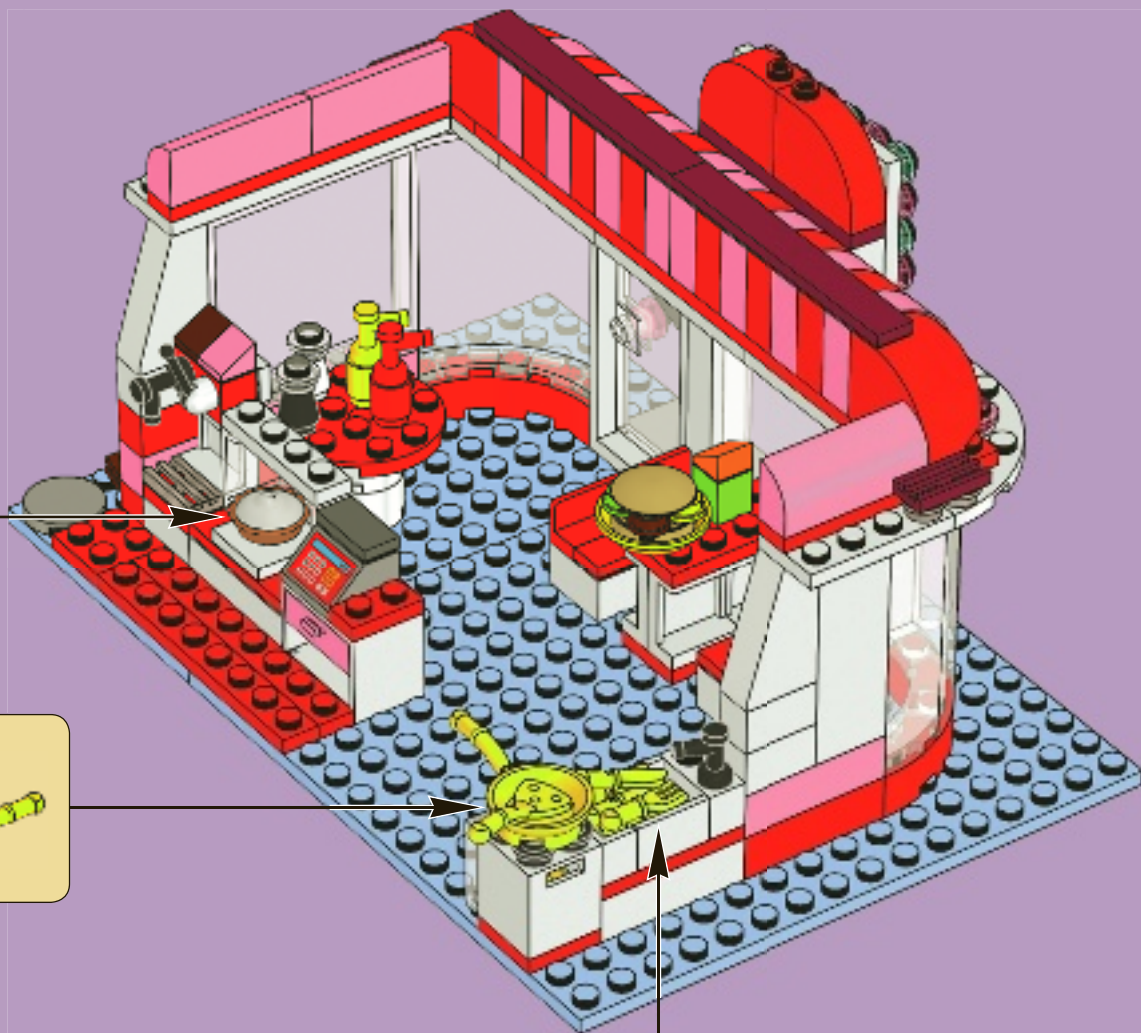



29

1



2



3





2x

30





1x

31





32

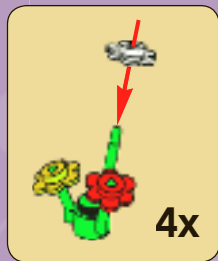



1x



1x

33



1

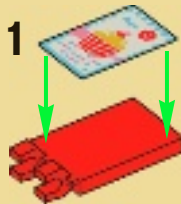

2

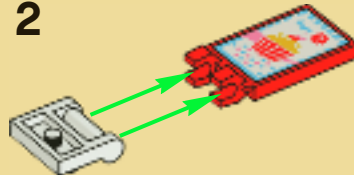

3





2x
245301



6x
300401



1x
245401



1x
300301



1x
4143254



1x
301001



4x
300101



5x
614301



2x
446001



2x
4597131



1x
371001



1x
302001



2x
4243812



1x
346001



2x
4163986



1x
303401



2x
4558952



2x
4178429



1x
4186952



1x
73737



1x
4222017



5x
4585458



1x
4565324



1x
306901



1x
4541956



1x
434501



1x
4619665



2x
4587272



1x
4518400



2x
623101



2x
486501



1x
4609018



2x
4515348



2x
4171662



1x
459921



1x
301021



2x
300821



1x
4113205



1x
4569056



2x
415021



3x
243121



1x
4530734



1x
306221



2x
4215466



8x
4622231



2x
4657913



2x
4290714



1x
4106915



1x
302321



6x
302221



1x
371021



4x
302021



6x
346021



1x
428221



2x
3005740



1x
4521504



2x
4504229



2x
4599452



1x
4219773



2x
3000240



1x
382340



1x
4106556

1x
4211052

1x
4612359

2x
4220631

1x
4129501

1x
306224

4x
4286050

1x
4621334

1x
4527943

1x
4278422

2x
614124

3x
4518890

1x
4612385

2x
4183133

1x
4249040

1x
4256320

1x
4599538

1x
4621988

2x
4539062

4x
4249039

1x
4599537

8x
4599544

1x
4620880

2x
4541506

6x
4163917



1x
4652901

3x
4599830

1x
4600258

2x
4539083

1x
4504371

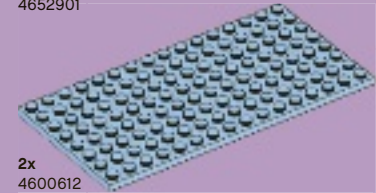

2x
4600612

2x
4517996

1x
4612384

1x
4504376

1x
614123



1x
4600613

1x
4599534

1x
4529236

1x
4211247

1x
4622092

9x
4599535

1x
4621990

4x
614126

4x
4216581

1x
4622060

1x
4622047

2x
459926

1x
4211159

1x
4211480

1x
4295260

1x
4211157

1x
4560183

4x
374128

Customer Service

Kundenservice

Service Consommateurs

Servicio Al Consumidor

www.lego.com/service or dial

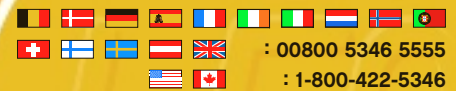

: 00800 5346 5555

: 1-800-422-5346

LEGO club
FREE! GRATIS! GRATUIT!



www.LEGOclub.com



LEGO Club Magazine



LEGO Club Email

VISIT THE WORLD'S
BIGGEST LEGO SHOP!

www.LEGOshop.com

00800 5346 5555

1-866-534-6258 • 1-877-518-5346

US & Canada only

Europe only



- * Freephone. Mobile charges may apply.
- * Numéro sans frais. Des frais peuvent s'appliquer avec des téléphones cellulaires.
- * Gebühnfrei, Kosten für Anrufe aus Mobilfunknetzen können abweichen.
- * Gratis telefonnummer vanaf vaste lijn.
- * Det er gratis nummer, når du ringer fra fasttelefon.
- * Det är gratis, när du ringer från en fast telefon.
- * Numéro sans frais. Des frais peuvent s'appliquer avec les téléphones portables.

BI115

YES! I want to join the LEGO® Club FREE! **OUI!** Je veux m'abonner au LEGO® Club GRATUITEMENT !
Ja! Ich möchte Mitglied im kostenlosen LEGO® Club werden. **Ja!** Ik wil graag GRATIS lid worden van de LEGO® Club.
Ja! Jeg ønsker å melde meg inn i LEGO Club gratis! **Ja!** Jag vill gå med i LEGO® Club GRATIS!

First name • Prénom
Vorname • Voornaam
Name • Achternaam •
Etternavn • Efternavn

Date of Birth • Date de naissance
Geburtsdag • Geboortedatum
Fødselsdato • Födelsedatum

Street • Adresse
Straße, Hausnr.
Straat, huisnr. • Address

City • Ville
Ort • Woonplaats
Poststed • Postort

Zip/Postcode
Code Postal • PLZ
Postcode
Postnummer

Email • Courriel
E-Mail • E-post

Boy • Garçon •
Junge • Jongen •
Gutt • Pojk

Girl • Fille •
Mädchen • Meisje
Jente • Flicka

State
Prov. County

Country
Pays
Land

- Fill in your email address and we will send you a membership confirmation and monthly email newsletters. If you do not wish to receive the newsletters please tick here. Remplis ton adresse e-mail et nous t'enverrons une confirmation d'adhésion ainsi que le bulletin e-mail mensuel. Si tu ne désires pas recevoir le bulletin, coche cette case. Vul je e-mailadres in en we sturen je een bevestiging van je lidmaatschap en maandelijke e-mail nieuwsbrieven. Als je geen e-mail wilt ontvangen, kruis dan dit vakje aan.
- Ich möchte per E-Mail den monatlichen LEGO Club Newsletter erhalten. Ønsker du at vi skal sende en liten hilsen til barnet ditt for å bekrefte medlemskapet, ber vi deg kryss av i feltet, samt oppgi e-postadressen som hilsen skal sendes til. Om du vill att vi ska skicka en bekräftelse på ditt barns medlemskap, ber vi dig sätta ett kryss i rutan och skriva den e-post adress som bekräftelsen ska skickas till.
- If you do not wish to receive additional mailings from the LEGO Club please tick here. Si tu ne désires pas recevoir de courrier supplémentaire du Club LEGO, coche cette case. Als je geen verdere post van de LEGO Club wilt ontvangen, kruis dan dit vakje aan.
- Dersom du ønsker å motta annen informasjon fra LEGO Gruppen, setter du et kryss her.

Mail to: / Poster à: LEGO® Club
P.O. Box 1157
Enfield, CT USA
06083-1157

Per Post an: LEGO® Club
Postfach 14 15
D-36243 Niederaula

Send til: LEGO® Club Norge
Postboks 58
1314 Vøyenenga

Mail to: LEGO® Club
33 Bath Road
Slough SL1 3UF
United Kingdom

Stuur op naar: LEGO® Club
Postbus 40250
3504 AB Utrecht

Skickas till: LEGO® Club Sverige
Ubox 841
202 29 Malmö

Poster à: LEGO® Club
21 rue de la banque
75 002 PARIS
FRANCE

The English language version of the magazine can only be mailed to addresses in the US, Canada, the UK, and Republic of Ireland. Club membership is valid for two years and includes free copies of the LEGO Club Magazine and e-mail newsletters. In the US and Canada please allow up to 6 weeks for delivery of your first magazine. In the UK and Republic of Ireland please allow six to 14 weeks for delivery of your first magazine. By signing this form you consent the LEGO Club to use your child's data for LEGO mailings. The data will only be used for LEGO mailings and will not be sold, rented or otherwise disclosed to any company outside the LEGO Company except for disclosure to companies acting as our agents to help us provide services requested by the child. This coupon is valid for one free membership per person, group or organization. Photocopied coupons are accepted. La version française du magazine peut être postée uniquement au Canada. L'abonnement est valide pour 2 ans et inclut des exemplaires gratuits du Magazine LEGO. Aux É.U. et au Canada, allouer 6 semaines pour la livraison initiale. En remplissant ce formulaire, vous consentez à ce que LEGO utilise les informations de votre enfant pour des envois postaux de LEGO. L'information sera utilisée uniquement pour des envois postaux par LEGO et ne sera en aucun cas, vendue, louée, échangée ou divulguée à d'autres compagnies autres que la compagnie LEGO. À l'exception des compagnies affiliées qui nous procurent des services auxquels l'enfant en a fait la demande. Formulaires photocopiés acceptés. Mit der folgenden Unterschrift erkläre ich, für mein Kind den Betrieb als Mitglied zum kostenlosen LEGO Club, der von der LEGO GmbH, D-85627 Grabbrunn, betrieben wird. Die Mitgliedschaft beinhaltet die Zusendung des LEGO Club Magazine und kann beiderseits jederzeit beendet werden. Wenn der Mitgliedschaft im LEGO Club sind keinerlei Verpflichtungen verbunden. Das deutschsprachige LEGO Club Magazin wird nur an Adressen in Deutschland, Österreich und der Schweiz versendet. Eine Anmeldebestätigung kann nur per E-Mail geschickt werden. Das Magazin erscheint fünfmal jährlich. Daher kann die Zustellung des ersten Heftes bis zu drei Monate dauern. Die Mitgliedschaft ist beidseitig jederzeit kündbar, ohne dass Ihnen Kosten entstehen. Sie können der werblichen Nutzung Ihrer Daten jederzeit widersprechen. Kündigung und Widerspruch können Sie telefonisch erklären (00800 / 5346 5555, Anruf gebührenfrei, Kosten für Anrufe aus dem Mobilfunknetz können abweichen) oder an die LEGO GmbH senden. Het Nederlandse LEGO Club Magazine kan alleen worden gestuurd naar adressen in Nederland. Het lidmaatschap is 2 jaar geldig en geeft recht op toezending van het gratis LEGO Club Magazine en LEGO Club e-mails. Het eerste magazine zal binnen 12 tot 14 weken toegestuurd worden. Het lidmaatschap kan op ieder moment opgezegd worden en kan na 2 jaar gratis worden verlengd, tenzij LEGO met deze activiteit stopt. Uw gegevens worden uitsluitend gebruikt voor mailings van LEGO en zullen niet worden verkocht, verhuurd of op welke wijze dan ook verstrekt aan derden buiten de LEGO Groep, uitgezonderd de organisaties die namens ons optreden om de informatie te sturen waarvoor toestemming is verleend. Den norske utgaven av magasinet sendes kun til adresser i Norge. Medlemskap i klubben gjelder 12 år og inkluderer gratisutgaver av LEGO Club Magazine. Pårøyn minimum oppliks seks uker leveringstid for første magasin. Ved å undertegne dette skjemaet, gir du ditt samtykke til at LEGO Club kan bruke opplysningene om barnet ditt i LEGO forsendelser. Dataene vil utelukkende bli brukt i LEGO forsendelser og vil ikke bli solgt, utleid eller på annen måte gøres tilgjengelig for selskaper utenfor LEGO gruppen, unntatt selskaper som er våre agenter og som hjelper oss å tilby tjenestene barnet ettersper. Dette skjemaet gjelder for ett gratis medlemskap per person, gruppe eller organisasjon. Den svenska versionen av tidningen kan endast skickas till adresser i Sverige. Club-medlemskapet är giltigt i 2 år och innefattar gratis exemplar av LEGO Club Magazine. Vånligen räkna med minimum 6 veckor för leverans av din första tidning. Genom att skicka in det här formuläret godkänner du att LEGO Club använder barnets uppgifter för LEGO utskick. Uppgifterna kommer bara att användas för LEGO utskick och kommer inte att säljas, hyras ut eller vidarebefordras till något företag som inte tillhör LEGO Gruppen, med undantag av företag som agerar som våra ombud för att tillhandahålla tjänster som barnet har begärt. Den här kupongen gäller för ett gratis medlemskap per person, grupp eller organisation. En completant ce bulletin d'adhésion, vous acceptez que LEGO Club utilise les données relatives à votre enfant pour l'envoi de courriers concernant LEGO. Ces données seront utilisées pour l'envoi d'information concernant LEGO et ne seront ni vendues, ni louées, ni utilisées par d'autres sociétés que le groupe LEGO, à l'exception des sociétés agissant pour le compte de LEGO en tant que sous-traitant de services divers. L'abonnement au LEGO Club est valable pour 2 ans. Il inclut l'envoi par courrier du magazine LEGO Club et par email des newsletters. Un délai de 6 à 14 semaines est à prévoir pour la réception de votre premier magazine. Ce bulletin d'adhésion gratuit est valable pour l'inscription d'une seule personne. Les photocopies sont acceptées. ATTENTION! Le bulletin d'adhésion doit être rempli et signé par un parent ou un tuteur.

Parent's signature • Signature d'un parent ou d'un tuteur •
Unterschrift Erziehungsberechtigter • Handtekening ouders •
Foreldres/foresattes underskrift • Förälders/förmyndares underskrift

Date
Datum
Date



Friends

LEGOFriends.com



Emma



Olivia



Stephanie



Mia



Andrea

Heartlake City



LEGO Friends



3183



3061



3065



3931



3187



3935



3932



3930



3933



3936



3934



3942



3188



3315

LEGO Friends



LEGOFriends.com





CREATOR

5766



5771



5770





Win!

Go to www.LEGOsurvey.com/product to fill out a survey for a chance to win a cool LEGO® Product.

No purchase necessary.

Open to all residents where not prohibited.



www.LEGOsurvey.com/product

Gewinne! Win!

Nimm an der Umfrage auf www.LEGOsurvey.com/product teil und hab die Chance ein cooles LEGO® Produkt zu gewinnen!

Die Teilnahme am Gewinnspiel führt zu keinerlei Kaufverpflichtungen. Teilnahme in allen nicht ausgeschlossenen Ländern möglich.

Ga naar www.LEGOsurvey.com/product, vul een enquêteformulier in en maak kans op een cool LEGO® product.

Geen aankoopverplichting, iedereen mag deelnemen, uitgezonderd ingezetenden van landen waar een enquêteverbod geldt.

Gagne! 当てよう!

Visite www.LEGOsurvey.com/product pour répondre à un questionnaire et avoir une chance de gagner un produit LEGO® très cool!

Aucune obligation d'achat. Ouvert à tous les résidents des pays autorisés.

www.LEGOsurvey.com/product にアクセスして、アンケートにご記入ください。当選者にはレゴ製品を差し上げます。

お買い上げの必要はありません。

禁止されていない限り、すべての皆様にご利用いただけます。