



# Architecture

## Villa Savoye

Poissy, France





 Booklet available in English on

 Heft in deutscher Sprache erhältlich auf

 Livret disponible en français sur

 Folleto disponible en español en

 Folheto disponível em português em

 A füzet magyarul ezen a honlapon olvasható: [Architecture.LEGO.com](http://Architecture.LEGO.com)



© Fondation Le Corbusier

*[ The house will stand in the midst of the fields like an object, without  
disturbing anything around it. ]*  
*[ Cette maison sera placée au milieu des champs comme un objet sans déranger ce qui l'entoure. ]*

Le Corbusier

## Contents

Villa Savoye.....	5
Architectural significance.....	6
The design & construction of Villa Savoye.....	10
The interiors.....	12
From 1931 to today.....	18
Le Corbusier.....	20
Facts about Villa Savoye.....	22
A word from the artist.....	148
The 'Scale Model' line - LEGO Architecture in the 1960s.....	150
References.....	155

## Contenu

Villa Savoye.....	5
Importance architecturale.....	6
La conception et la construction de la Villa Savoye.....	11
Les intérieurs.....	12
De 1931 à aujourd'hui.....	19
Le Corbusier.....	21
Informations sur la Villa Savoye.....	22
Un mot de l'artiste.....	148-149
La ligne des "maquettes à l'échelle" - L'architecture LEGO dans les années 1960.....	151
Références.....	155





# Villa Savoye

Lying on the outskirts of Paris, France, and completed in 1931, Villa Savoye was designed as a private country house by the Swiss-born architect, Le Corbusier. It quickly became one of the most influential buildings in the International style of architecture and cemented Le Corbusier's reputation as one of the most important architects of the 20th century.

Située dans les environs de Paris, et terminée en 1931, la Villa Savoye est une maison de campagne privée conçue par l'architecte d'origine suisse Charles-Édouard Jeanneret, plus connu sous le nom de Le Corbusier. Elle est rapidement devenue l'un des plus célèbres bâtiments dans le style international d'architecture et établit la réputation de Le Corbusier comme l'un des architectes les plus importants du vingtième siècle.



© Fondation Le Corbusier

## Architectural significance

When the construction of Villa Savoye began in 1928, Le Corbusier was already an internationally known architect. His book *Vers une Architecture* (Towards a New Architecture) had been translated into several languages, while his work on the Centrosoyuz Building in Moscow, Russia, had brought him into contact with the Russian avant-garde. As one of the first members of the Congrès International d'Architecture Moderne (CIAM), he was also becoming known as an important and vocal champion of modern architecture. Villa Savoye would be the last in a series of white "Purist villas" designed and constructed by Le Corbusier and his cousin Pierre Jeanneret in and around the city of Paris during the 1920s. Encouraged by the Savoye family's open brief, Le Corbusier ensured that the design of the house would become the physical representation of his 'Total Purity' ideals.

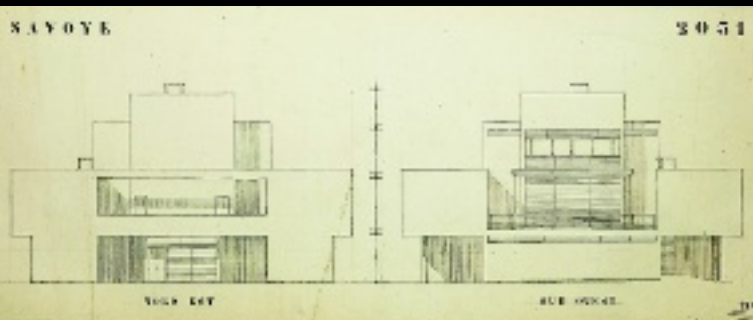

© Fondation Le Corbusier

## Importance architecturale

Lorsque la construction de la Villa Savoye commença en 1928, Le Corbusier était déjà un architecte internationalement célèbre. Son livre *Vers une architecture* avait été traduit en plusieurs langues, et son travail sur le bâtiment Centrosoyuz à Moscou l'avait mis en contact avec l'avant-garde russe. En tant que l'un des premiers membres du Congrès International d'Architecture Moderne (CIAM), il devenait aussi célèbre comme un défenseur important et éloquent de l'architecture moderne.

La Villa Savoye allait être la dernière d'une série de « villas puristes » blanches, conçues et construites par Le Corbusier et son cousin Pierre Jeanneret à Paris et dans les environs dans les années 1920. Encouragé par la liberté donnée par la famille Savoye, Le Corbusier s'est assuré que la conception de la maison devienne la représentation physique de ses idéaux de « pureté totale ».

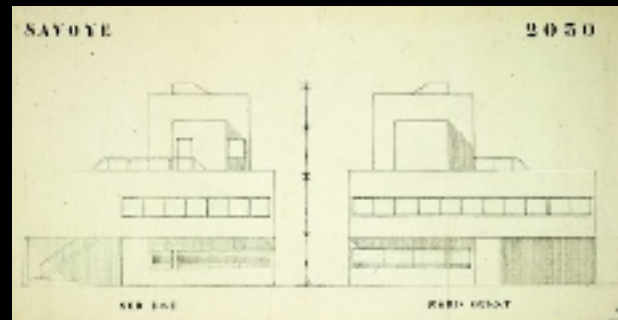

© Fondation Le Corbusier

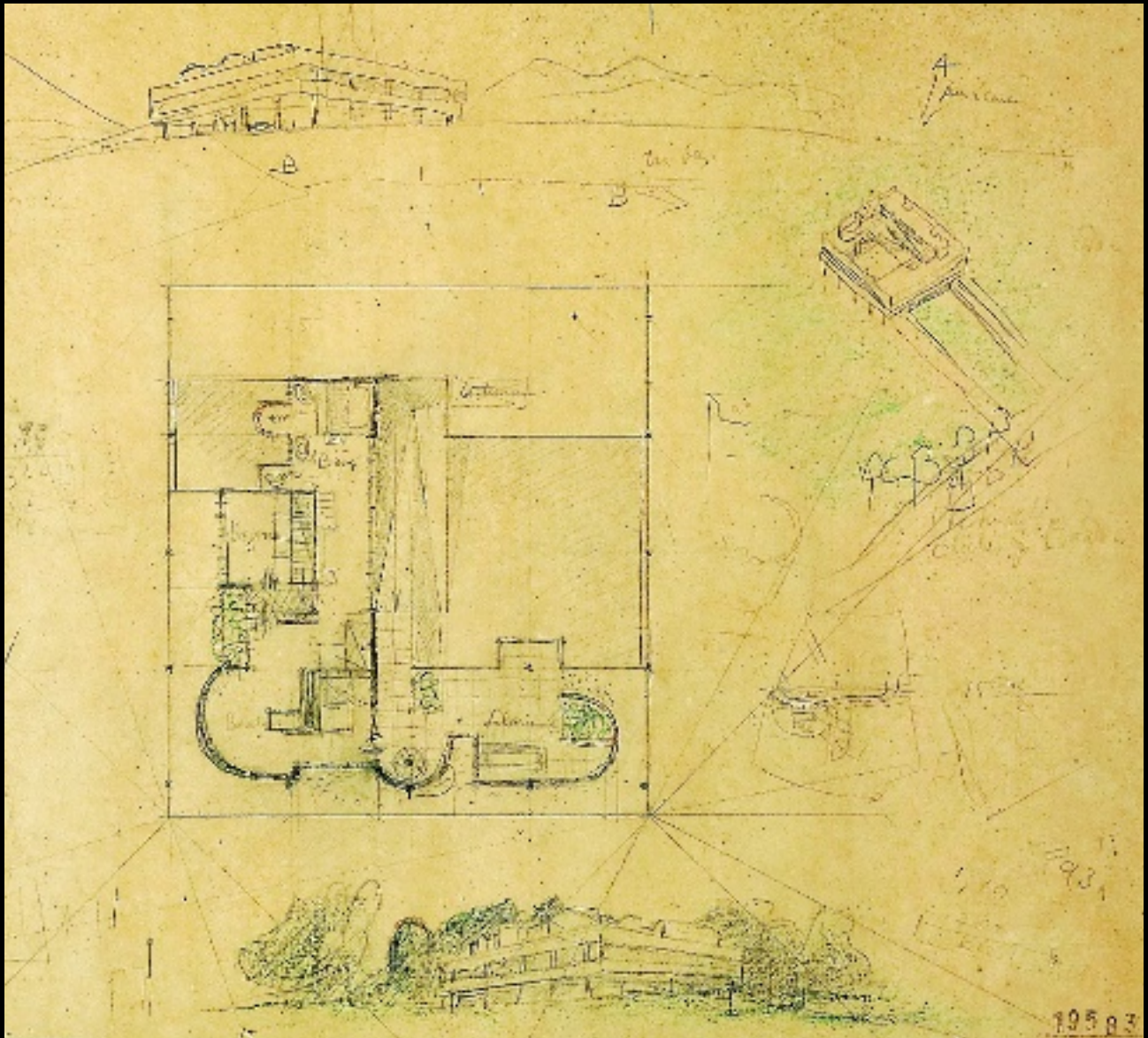

The villa was to be constructed according to the emblematic 'Five Points' Le Corbusier had developed as guiding principles for his modernist architectural style:

1. Pilotis, such as columns or pillars, which elevate the building and allow an extended continuity of the garden beneath.
2. Functional roof, serving as a garden and terrace, reclaiming for nature the land occupied by the building.
3. Open floor plan relieved of load-bearing walls, allowing walls to be placed freely and only where aesthetically needed.
4. Long horizontal windows, providing illumination and ventilation.
5. Freely designed façades, serving as only as a skin of the wall and windows and unconstrained by load-bearing considerations.

While the implementation of Le Corbusier's 'Five Points' would complicate the building process and, later, create a number of practical issues for the Savoye family, the result remains a stunning fusion between modern architecture and the surrounding nature in which it is placed. Villa Savoye became one of the most influential buildings of the 1930s, spawning imitations all over the world, and it continues to be a true architectural icon 80 years later.

La villa allait être construite en accord avec les « cinq points » emblématiques que Le Corbusier avait développés comme principes directeurs pour son style architectural :

1. Pilotis, tels que les colonnes ou les piliers, qui élèvent le bâtiment et permettent une continuité étendue du jardin en dessous.
2. Toit-terrasse, servant de jardin et de terrasse, récupérant pour la nature le terrain occupé par le bâtiment.
3. Plan libre libéré des murs porteurs, permettant aux murs d'être placés librement et uniquement lorsqu'ils sont nécessaires esthétiquement.
4. Fenêtres en longueur, fournissant illumination et ventilation.
5. Façade libre, servant uniquement de peau du mur et des fenêtres et dégagée des considérations de port de charge.

L'application des « cinq points » de Le Corbusier allait compliquer le processus de construction et créer par la suite plusieurs problèmes pratiques pour la famille Savoye, mais le résultat final était une fusion spectaculaire d'architecture moderne et de nature. La Villa Savoye se fondait en harmonie avec son cadre naturel et devint l'un des bâtiments les plus influents des années 1930, imité partout dans le monde. Quarante-vingts ans plus tard, ce bâtiment est toujours considéré comme une icône architecturale.





# The design & construction of Villa Savoye

Villa Savoye was commissioned as a private country residence by Pierre and Emilie Savoye in 1928. They came from a wealthy Parisian family that ran a large and successful insurance company and owned land in the town of Poissy, 30 km (18.6 miles) to the west of Paris. The land upon which they intended to build was a sloping meadow, surrounded by forest and with a magnificent view of the River Seine. Apart from the number of rooms required and the wish for all the latest technical fittings befitting a modern home, Le Corbusier noted that his clients were: 'quite without preconceptions, either old or new' and only had a vague idea of what their future country house should look like.

Le Corbusier and Pierre Jeanneret quickly went to work and by mid-October 1928 were able to present a detailed sketch of their idea. The first scheme underwent several modifications, resulting in four subsequent sets of drawings. Two of these—the second and third—differed from the first, while the final two drawings returned to the initial ideas of the first sketches, but decreased the overall size to reduce costs.

The primary design principles were relatively clear: the building would occupy a strategic position in the centre of the site and the views would be further maximized by means of pillars which would raise the house by one level. Unlike his earlier town villas Le Corbusier was able to carefully design all four sides of the Villa Savoye in response to the view and the orientation of the sun. On the ground floor he placed the main entrance hall, the ramp and the stairs, the garage, and rooms for the

chauffeur and maids. On the first floor were the master bedroom, a bedroom for the Savoyes' child, a guest bedroom, kitchen, living-room and external terraces. The living-room was orientated towards the northwest, while the terrace faced south. The son's bedroom faced southeast, and the kitchen and service terrace were on the northeastern side. On the second floor level there were a series of sculpted spaces that formed a solarium.



© Fondation Le Corbusier

# La conception et la construction de la Villa Savoye

La Villa Savoye fut commandée comme résidence de campagne privée par Pierre et Emilie Savoye en 1928. Ils étaient issus d'une riche famille parisienne qui gérait une grande compagnie d'assurance florissante, et possédaient des terrains dans la ville de Poissy, à 30 km à l'ouest de Paris. Le terrain sur lequel ils souhaitaient construire était une prairie en pente, entourée de forêt et avec une vue magnifique sur la Seine. Hormis le fait de stipuler le nombre de pièces et leur souhait de meubles modernes, Le Corbusier nota que ses clients étaient : « dépourvus totalement d'idées préconçues : ni modernes, ni anciens » et qu'ils n'avaient que de vagues idées sur l'aspect architectural de leur future maison de campagne.

Le Corbusier et Pierre Jeanneret se mirent rapidement au travail et ils purent présenter une illustration détaillée de leurs idées à la mi-octobre 1928. Le premier plan subit plusieurs modifications, avec comme résultat quatre ensembles postérieurs de dessins différents. Deux d'entre eux, le deuxième et le troisième, étaient différents du premier, tandis que les deux derniers dessins revenaient aux idées initiales de la création d'origine, mais diminuaient

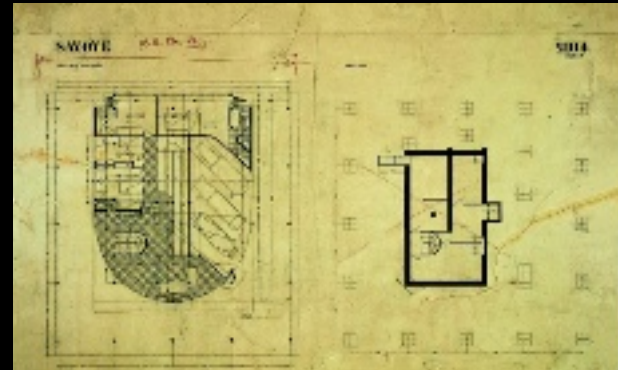
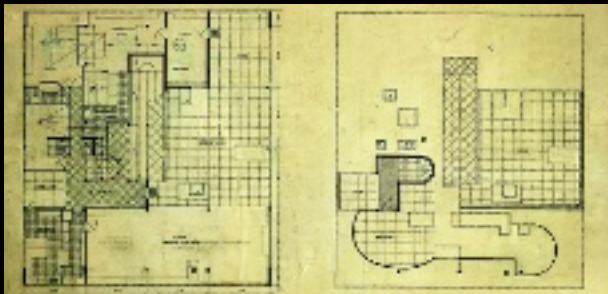

© Fondation Le Corbusier

la taille totale de la structure pour réduire les coûts.

Les principaux principes de création étaient relativement clairs : le bâtiment serait stratégiquement positionné au centre du site et élevé sur des colonnes pour maximiser la vue de la campagne environnante. Contrairement à ses villas urbaines antérieures, Le Corbusier put soigneusement concevoir les quatre côtés de la Villa Savoye en fonction de la vue et de l'orientation du soleil. Au rez-de-chaussée, il plaça le hall d'entrée principal, la rampe et l'escalier, le garage et les chambres du chauffeur et de la femme de chambre. Au premier étage, la chambre principale, la chambre d'enfant pour le fils des Savoye, la chambre d'invités, la cuisine, le salon et des terrasses extérieures. Le salon était orienté vers le nord-ouest, tandis que la terrasse faisait face au sud. La chambre d'enfant faisait face au sud-est et la cuisine et la terrasse de service étaient orientés vers le nord-est. Au deuxième étage, une série d'espaces sculptés formait un solarium.



## The interiors Les intérieurs

### The ramp - La rampe

The visitor enters the house through the glass and white-walled entrance hall. Four columns appear to direct the visitor towards the double-flight ramp that can be seen from almost anywhere in the house.

Le visiteur entre dans la maison par le hall d'entrée en verre et murs blancs. Quatre colonnes semblent diriger le visiteur vers la rampe qui peut être vue pratiquement depuis toute la maison.



### The stair - L'escalier

A circular stair with a solid baluster winds its way up through the core of the building. It also provides access to the villa's two cellars.

Un escalier circulaire avec une solide balustrade s'élève au cœur du bâtiment. Il permet aussi d'accéder aux deux caves de la villa.



© Fondation Le Corbusier



### The kitchen - La cuisine

'The kitchen is not precisely the sanctuary of the house, but it is certainly one of the most important places. The kitchen and living room—these are the rooms which are lived in.'

« La cuisine n'est pas pas précisément le sanctuaire de la maison, mais elle est certainement l'un des endroits les plus importants. La cuisine et le salon, ce sont les pièces où l'on vit. »

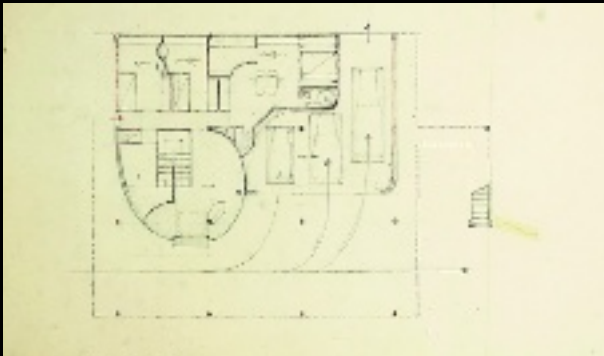

### The living room - Le salon

Conceived as an unbroken space, this 86m<sup>2</sup> (925.7 sq. ft.) area is the main room in the house. Huge glazed panels open out onto the garden terrace.

Conçue comme un espace ouvert, cette pièce de 86 m<sup>2</sup> est la pièce principale de la maison. D'immenses baies vitrées s'ouvrent sur la terrasse jardin.



### The garage - Le garage

The garage, which can accommodate up to three cars, is laid out on a 45° angle - matching the turning circle of a car.

Le garage, qui peut accueillir jusqu'à trois voitures, est disposé avec un angle à 45°, correspondant au cercle de virage d'une voiture.





### The bathroom - La salle de bains

The bathroom in the master apartment contains one of the Villa's special features: a rectangular bath clad in 5 cm x 5 cm (1.96 inches) turquoise blue ceramic tiles. A concrete reclining 'chaise-long' at the edge of the bath is based on earlier furniture designs that Le Corbusier had worked upon.

La salle de bains présente l'une des caractéristiques spéciales de la maison : une baignoire rectangulaire recouverte de carreaux de céramique bleue turquoise de 5 cm x 5 cm. Une "chaise longue" en ciment au bord de la baignoire est basée sur de précédentes créations de meubles sur lesquelles Le Corbusier avait travaillé.

### **The hanging garden - Le jardin suspendu**

'The real garden of the dwelling will not be on ground level, but raised 3.5 m above. This will be the hanging garden (...) it is from this area that we will survey the entire landscape.'

« Le véritable jardin de la maison ne doit pas être au niveau du sol, mais 3,5 mètres au-dessus. Il s'agira du jardin suspendu (...) c'est depuis ce jardin que nous admirerons tout le paysage ».

### **The solarium - Le solarium**

The ramp culminates at the solarium sited atop the house. It offers excellent views of both the architecture of the house below and of the nature that surrounds it. From the solarium, the guest descends the spiral staircase back down to the entrance hall.

La rampe culmine au solarium qui est situé au-dessus de la maison. Il offre des vues excellentes de l'architecture de la maison et de la nature environnante. Depuis le solarium, le client descend l'escalier en spirale jusqu'au hall d'entrée.





### Colour

Although an architectural purist, Le Corbusier was nevertheless a strong supporter of polychromy—the art of combining colors. ‘Man needs color. Color is the immediate, spontaneous expression of life.’ The exterior of Villa Savoye is predominantly white, but two side-walls of the garage and the servant quarters are painted dark green to create empathy with the surrounding lawn.

### Couleur

Puriste architectural, Le Corbusier n’en était pas moins un supporter affirmé de la polychromie, de l’art de combiner les couleurs. « L’homme a besoin de couleurs. La couleur est l’expression immédiate et spontanée de la vie. » L’extérieur de la Villa Savoye est principalement blanc, mais les murs latéraux du garage et des chambres de service ont été peints en vert foncé pour se fondre avec les pelouses environnantes.



Although of seemingly simple design, Villa Savoye proved to be extremely complex from a construction perspective. While Le Corbusier was experimenting with new concepts both on a functional and formal level, those contracted to build the house were still entrenched in traditional skills and techniques. This led to a series of disagreements, delays and cost overruns that would hamper the entire project.

Additional costs were also caused by the fact that although Le Corbusier always advocated the use of standard industry components, almost every element for Villa Savoye had to be customized and created in situ. From an estimated price of 787,000 francs in 1929, the total building costs had risen to approximately 900,000 francs by 1931.

D'une conception apparemment simple, la Villa Savoye se révéla très complexe du point de vue de la construction. Le Corbusier expérimentait avec de nouveaux concepts de fonctionnalité et de forme, mais les personnes engagées pour construire la maison étaient toujours attachées à des compétences et à des techniques traditionnelles. Ceci entraîna une série de désaccords, de retards et de coûts supplémentaires néfastes pour tout le projet.

Alors que Le Corbusier défendait l'utilisation de composants industriels standard, presque chaque élément de la Villa Savoye a dû être adapté ou créé sur place, ce qui entraîna des dépenses excessives. De l'estimation initiale de 787 000 francs, en 1931, les coûts totaux de construction étaient passés à environ 900 000 francs.

*[The house is a box in the air, pierced all around, without interruptions, by a long window.]*

*[ « La maison est une boîte en l'air, percée tout le tour, sans interruption, d'une fenêtre en longueur. » ]*

Le Corbusier

## From 1931 to today

The Savoye family took possession of the house in 1931 but abandoned it during World War II, leaving it to be commandeered by both the German and American armies. At the end of the war, with the Savoyes no longer in a position to maintain it, the town of Poissy took control of the villa. In 1958 they eventually expressed a wish to expropriate the villa completely with a view to demolishing it. Only a vigorous international campaign by the architect fraternity and the intervention of Le Corbusier halted this plan.

In 1965 the villa was added to the French register of historical monuments, the first example of modernist

architecture to be included. Various restoration projects were carried out to safeguard the building, the largest one, a state-funded process, taking place between 1985 and 1997, which reinstated many of the original fittings.

It is impossible to ignore the influence Villa Savoye has had on modern international architecture, and the house, which is open to the public, continues to be a magnet for those wishing to experience at first hand the work of Le Corbusier.

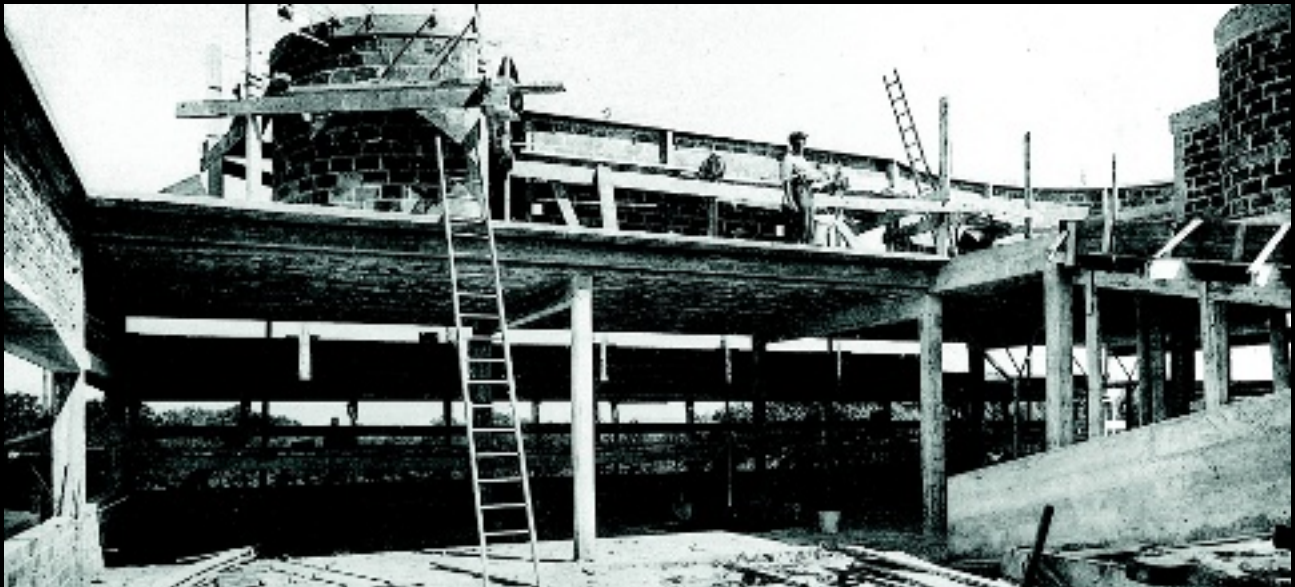

© Fondation Le Corbusier

## De 1931 à aujourd'hui



© Fondation Le Corbusier

La famille Savoye prit possession de la maison en 1931 mais l'abandonna pendant la Deuxième guerre mondiale et le bâtiment fut par la suite réquisitionné par les armées allemande et américaine. À la fin de la guerre, les Savoye n'étant plus en mesure de maintenir la villa, la ville de Poissy en prit le contrôle. En 1958, ils exprimèrent le souhait d'exproprier la villa en vue de la démolir. Seule une vigoureuse campagne internationale de la communauté architecturale et l'intervention de Le Corbusier arrêta ce plan.

En 1965, la villa fut inscrite à l'annuaire français des monuments historiques, le premier exemple d'architecture moderniste à être inclus. Plusieurs

projets de restauration furent entrepris pour préserver la longévité du bâtiment. Le plus vaste, un projet financé par l'État qui eut lieu entre 1985 et 1997, restaura de nombreuses caractéristiques d'origine.

Il est impossible d'ignorer l'influence que la Villa Savoye eut sur l'architecture moderne internationale. Cette maison, désormais ouverte au public, demeure un aimant pour ceux qui souhaitent découvrir de près le travail de Le Corbusier.

# Le Corbusier

Though a pioneer of modern architecture, Le Corbusier was more than just an architect. He was also a famous writer, painter and urbanist, and the designer of some of the most iconic furniture of the 20th century. In a career that spanned five decades he created a body of work that is still revered and respected today.

He was born Charles-Édouard Jeanneret on October 6, 1887 in La Chaux-de-Fonds, a small city in northwestern Switzerland only five kilometers (3.1 miles) from the French border. His father, Georges Edouard Jeanneret, was a watch engraver and enameller, while his mother, Marie Charlotte Amélie Jeanneret-Perret, was a music teacher. From an early age Le Corbusier was attracted to the visual arts and studied at the local Art School.

In 1907 he traveled to Paris, France, and worked in the office of Auguste Perret, the French pioneer of reinforced concrete. By 1908 he was studying architecture in Vienna, Austria, with Josef Hoffman, before moving to Berlin, Germany, in 1910 to work for the architect Peter Behrens. It is believed that during his stay in Berlin Le Corbusier met both Mies van der Rohe and Walter Gropius.

At the outbreak of World War I, Le Corbusier returned to Switzerland to teach at his old school. It was during this period that he also worked on the theoretical architectural studies that would become the foundation for his future work. On returning to Paris he opened his own architectural practice with his cousin Pierre Jeanneret, and by 1920 had adopted his pseudonym

of Le Corbusier. Over the next decade, Le Corbusier further refined his theories on Purism, including his famous “Five Points” of architecture, and would put them into practice building a series of modernist villas in and around Paris. This period culminated in the design and construction of Villa Savoye.

Throughout the 1930s and after World War II, Le Corbusier expanded his ideas on urban planning, and attempted to realize his work on projects in Marseilles, France and in a new capital city that was being built for the states of Punjab and Haryana in India.

When Le Corbusier died on August 27, 1965, he left behind a substantial body of work that spanned five decades, including journals, books, iconic furniture designs and ground-breaking architecture such as Villa Savoye.



© Fondation Le Corbusier



# Le Corbusier

Pionnier de l'architecture moderne, Le Corbusier n'était pas seulement architecte. Il était aussi un écrivain, peintre, urbaniste et designer célèbre, créant certains des meubles les plus emblématiques du vingtième siècle. Dans une carrière qui a couvert cinq décennies, il a créé un ensemble d'œuvres toujours admirées et respectées aujourd'hui.

Il naquit sous le nom de Charles-Édouard Jeanneret le 6 octobre 1887 à La Chaux-de-Fonds, une petite ville du nord-ouest de la Suisse, à seulement cinq kilomètres de la frontière française. Son père, Georges Edouard Jeanneret, était graveur et émailleur de montres et sa mère, Marie Charlotte Amélie Jeanneret-Perret, professeur de musique. Le Corbusier fut attiré très jeune par les arts visuels et étudia à l'école d'art locale.

En 1907, il se rendit à Paris et travailla dans le bureau d'Auguste Perret, le pionnier français du béton armé. En 1908, il étudia l'architecture à Vienne, en Autriche, avec Josef Hoffman, avant de se rendre à Berlin, en Allemagne, en 1910, pour travailler avec l'architecte Peter Behrens. On pense que pendant son séjour à Berlin, Le Corbusier rencontra Mies van der Rohe et Walter Gropius.

Au début de la Première guerre mondiale, Le Corbusier est retourné en Suisse, pour enseigner dans son ancienne école. C'est pendant cette période qu'il travailla également sur les études théoriques d'architecture qui allaient constituer les bases de son travail futur. À son retour à Paris, il a ouvert son propre cabinet d'architecture avec son cousin Pierre Jeanneret, et en 1920 il adopta le pseudonyme de Le Corbusier. Au cours de la décennie suivante, Le Corbusier raffina encore ses théories sur le Purisme, notamment ses célèbres « cinq points » d'architecture, et les mit en pratique en construisant une série de villas modernistes à Paris et dans les environs. Cette période culmina avec la conception et la construction de la Villa Savoye.

Pendant les années 1930 et après la Deuxième guerre mondiale, Le Corbusier développa ses idées de planification urbaine et essaya de réaliser ses ambitions dans le cadre de projets, à Marseille et dans une nouvelle capitale en cours de construction pour les états du Punjab et d'Aharyana en Inde.

À sa mort le 27 août 1965, Le Corbusier laissa derrière lui un ensemble important d'œuvres qui s'étendait sur cinq décennies, notamment des journaux, des livres, des meubles emblématiques et une architecture pionnière telle que celle de la Villa Savoye.

## Facts about Villa Savoye

Location:..... 82, Rue de Villiers, 78300 Poissy,  
France  
Architects:..... Le Corbusier & Pierre Jeanneret  
Style: ..... Modernist, International  
Date: ..... 1928-1931  
Construction type:.... Country residence  
Materials:..... Post/beam structure in reinforced  
concrete  
Original cost: ..... Approximately 900,000 Francs  
Surface area: ..... 408 m<sup>2</sup> (1338 ft.)

## Informations sur la Villa Savoye

Situation:..... 82 rue de Villiers, 78300 Poissy,  
France  
Architecte: ..... Le Corbusier et Pierre Jeanneret  
Style: ..... Moderniste, international  
Date: ..... 1928-1931  
Type de construction: Maison de campagne  
Matériaux:..... Structure des piliers/poutres en  
béton armé  
Coût d'origine: ..... Environ 900 000 francs  
Superficie: ..... 408 m<sup>2</sup>.

## Fondation Le Corbusier

[www.fondationlecorbusier.fr](http://www.fondationlecorbusier.fr)

Address: 8-10, square du Docteur Blanche 75016 Paris; Tel: +33 142 884153; E-mail: [info@fondationlecorbusier.fr](mailto:info@fondationlecorbusier.fr)

[www.fondationlecorbusier.fr](http://www.fondationlecorbusier.fr)

Adresse : 8-10 square du Docteur Blanche 75016 Paris, France; Téléphone : + 33 (0)1.42.88.41.53; E-mail : [info@fondationlecorbusier.fr](mailto:info@fondationlecorbusier.fr)

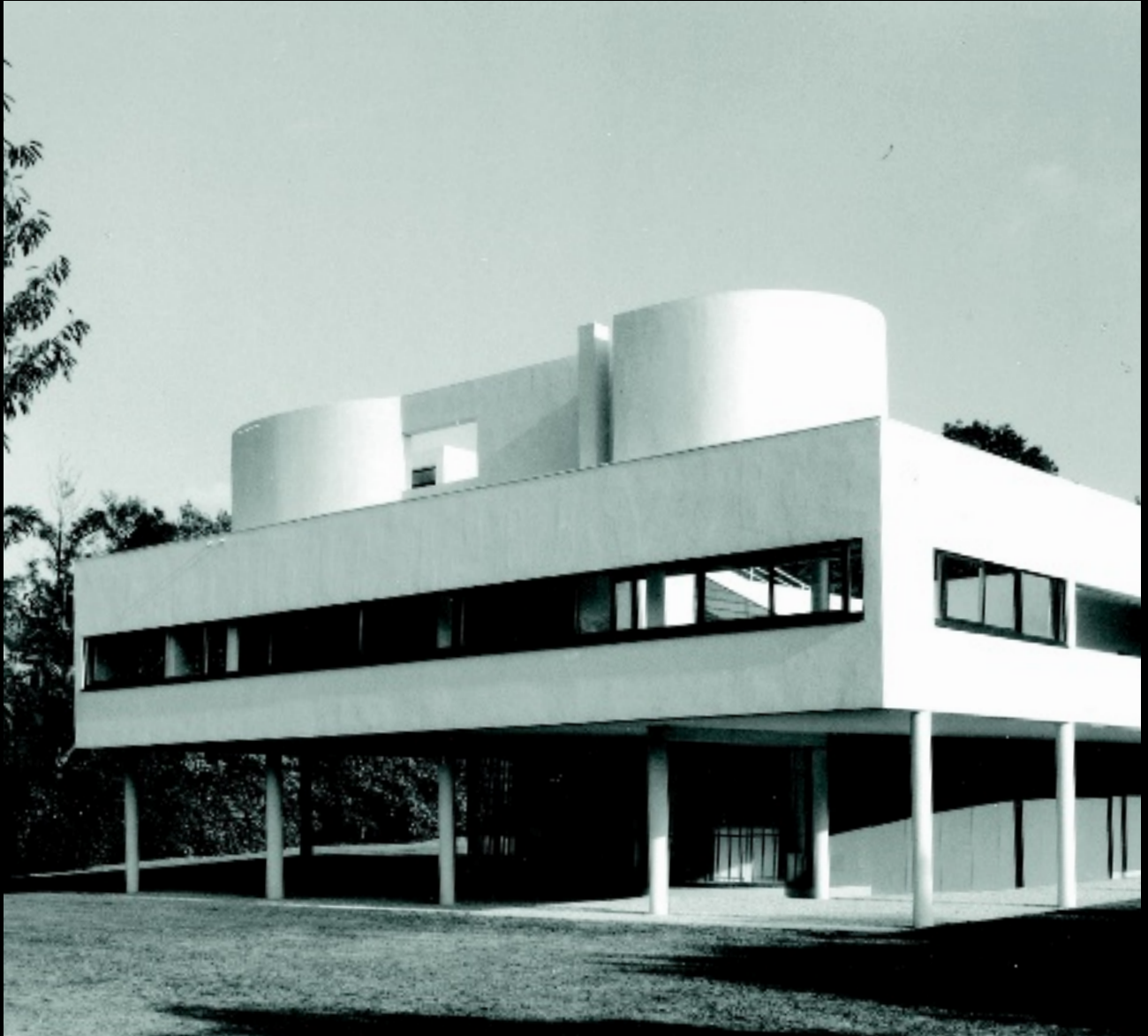

© Fondation Le Corbusier

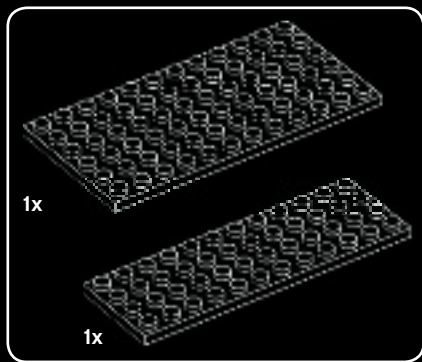

1

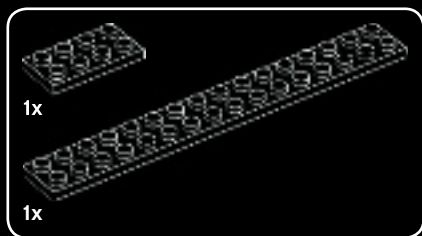
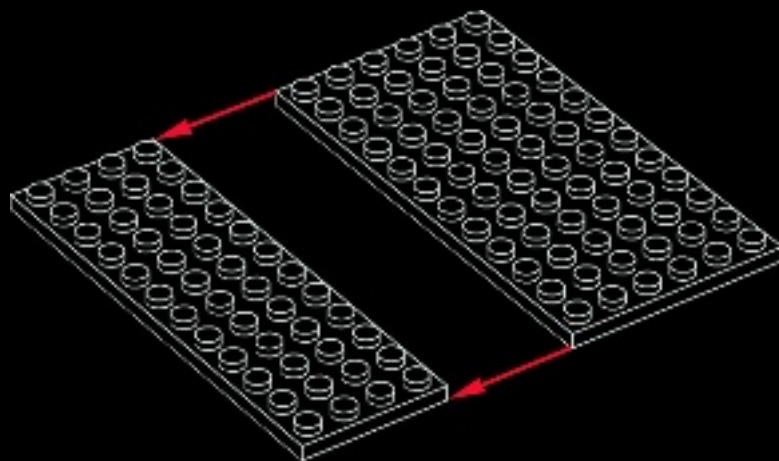

2

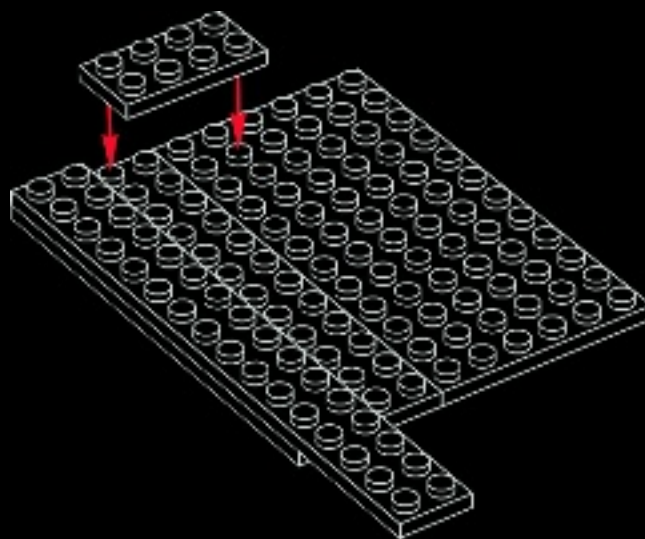



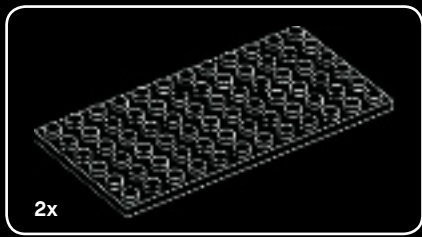

3

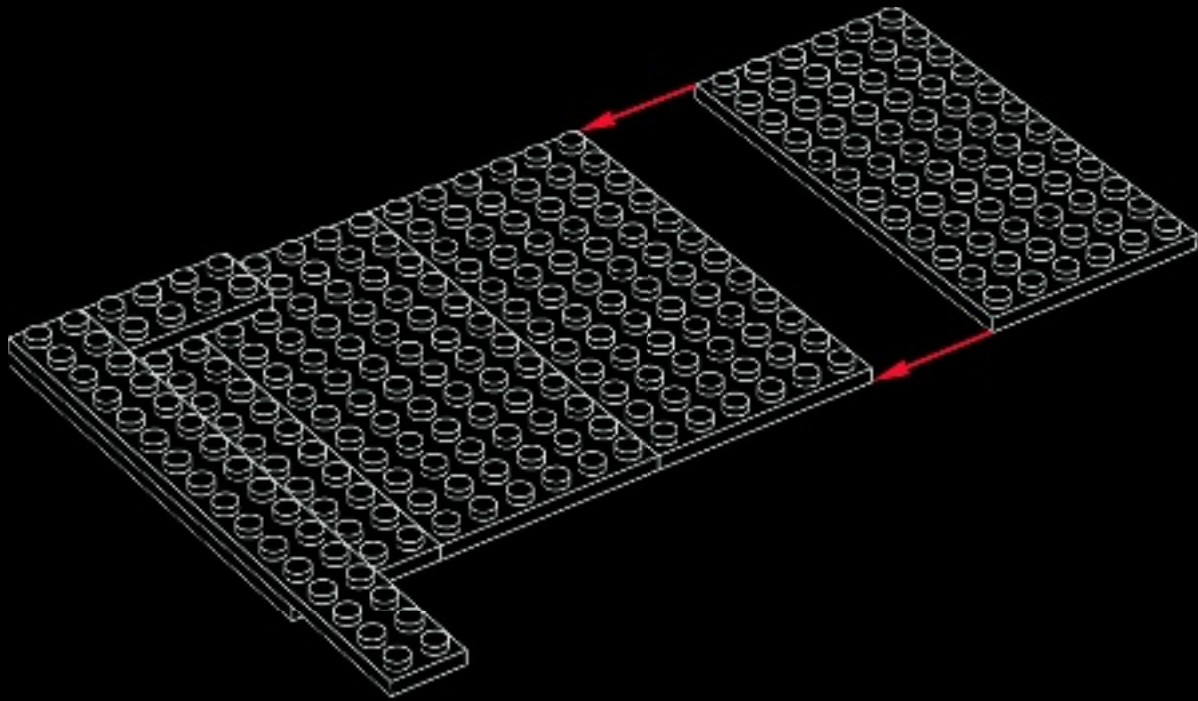

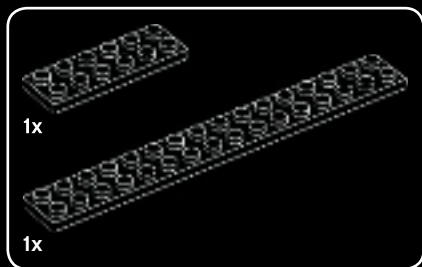

4

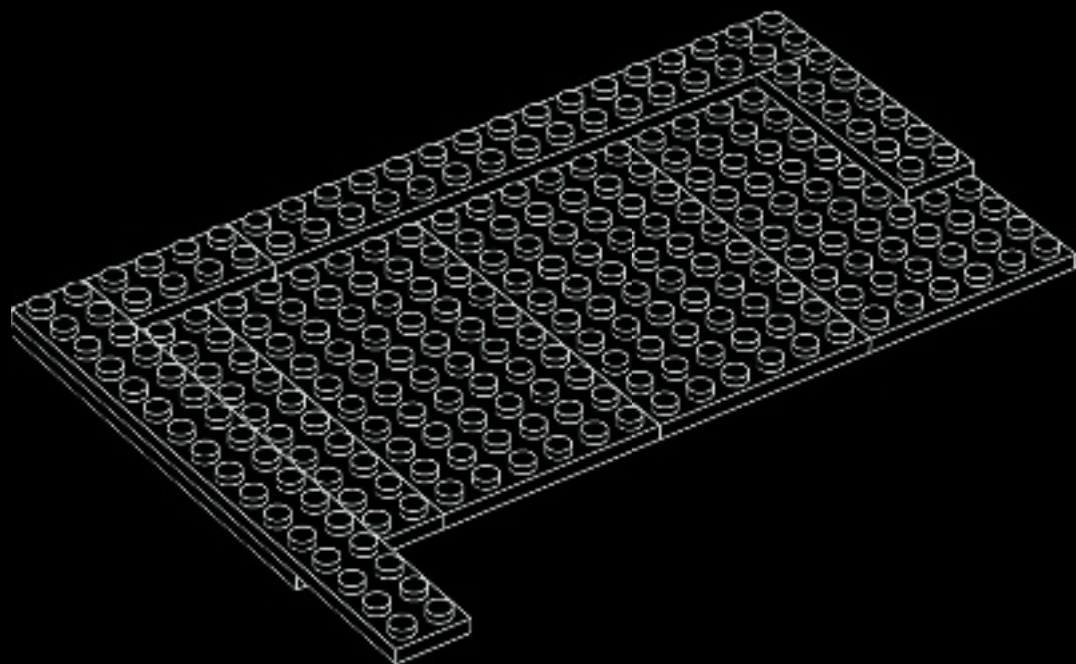

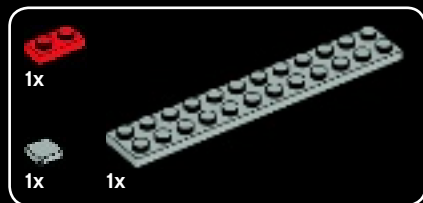

5

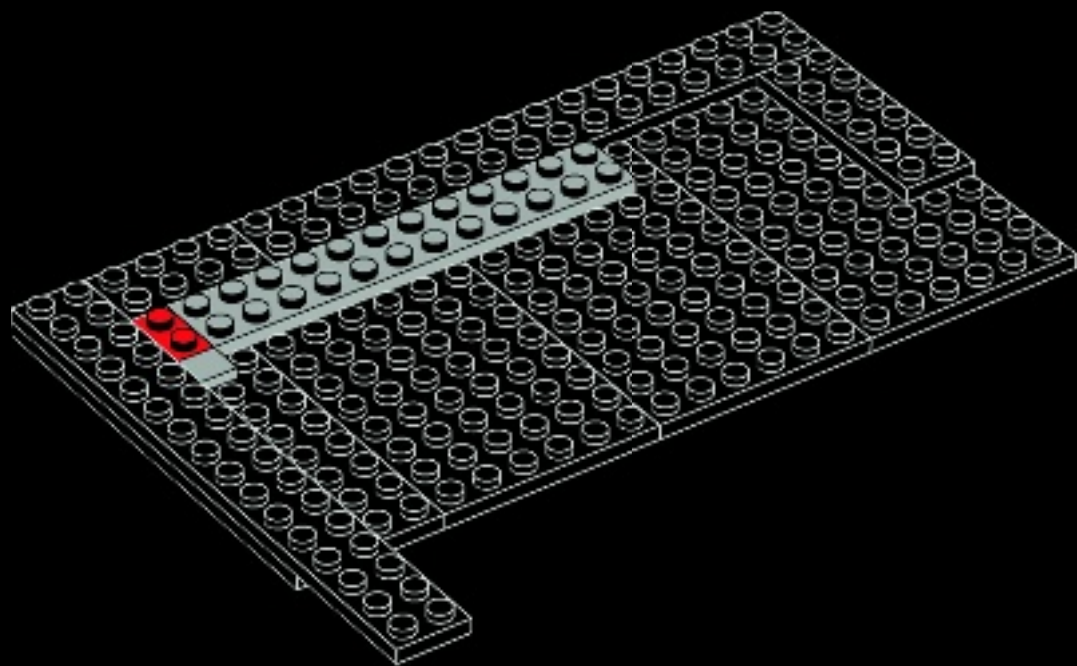

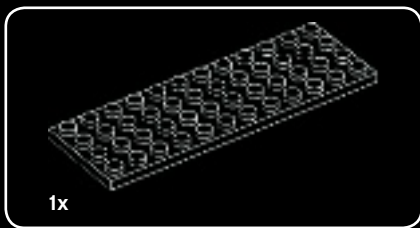

6

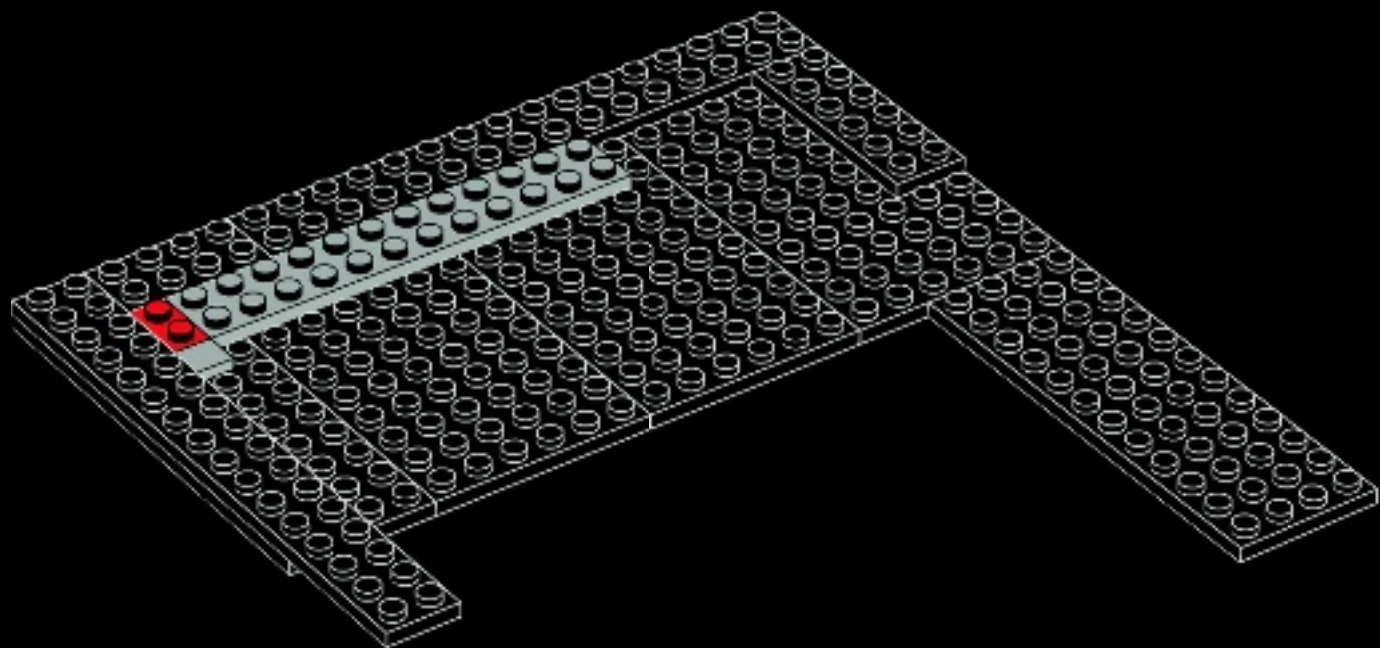



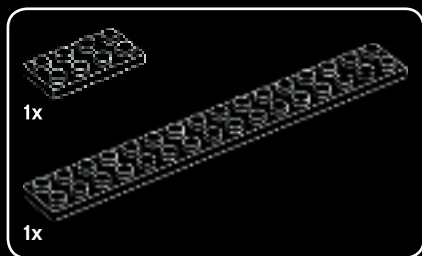

7

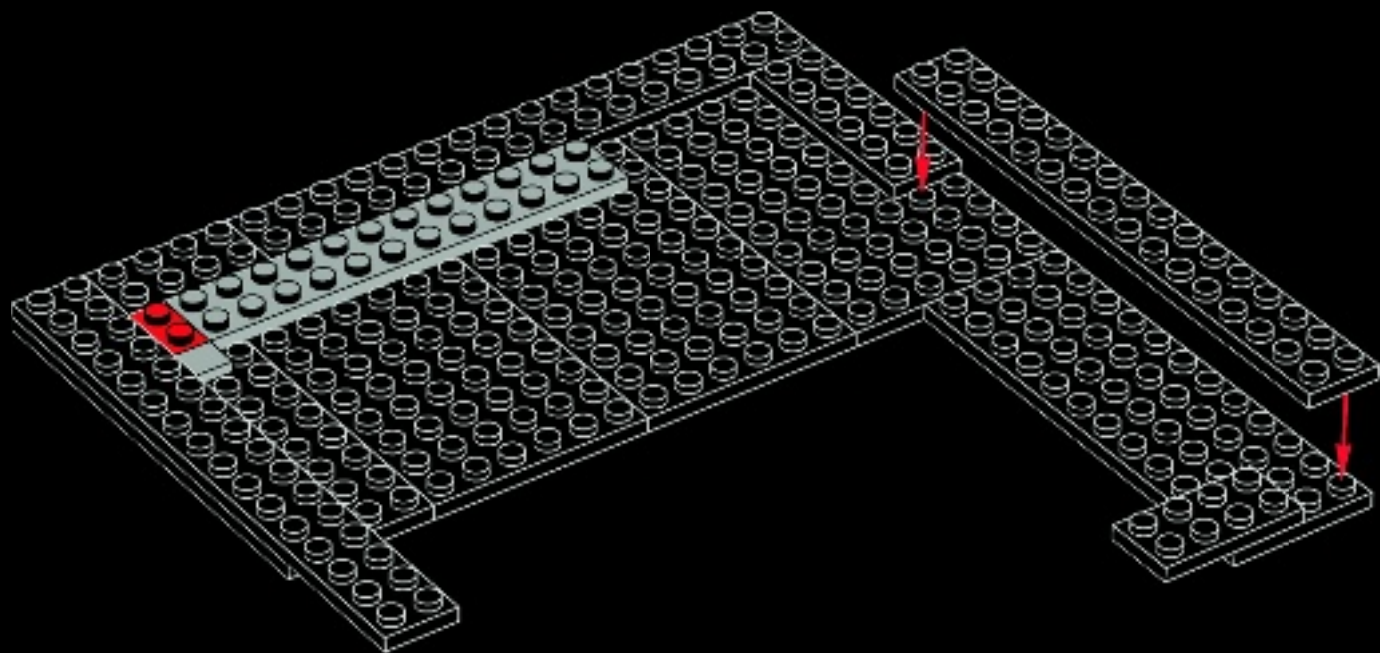

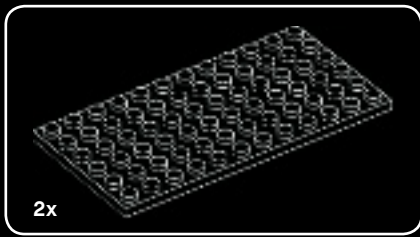

8

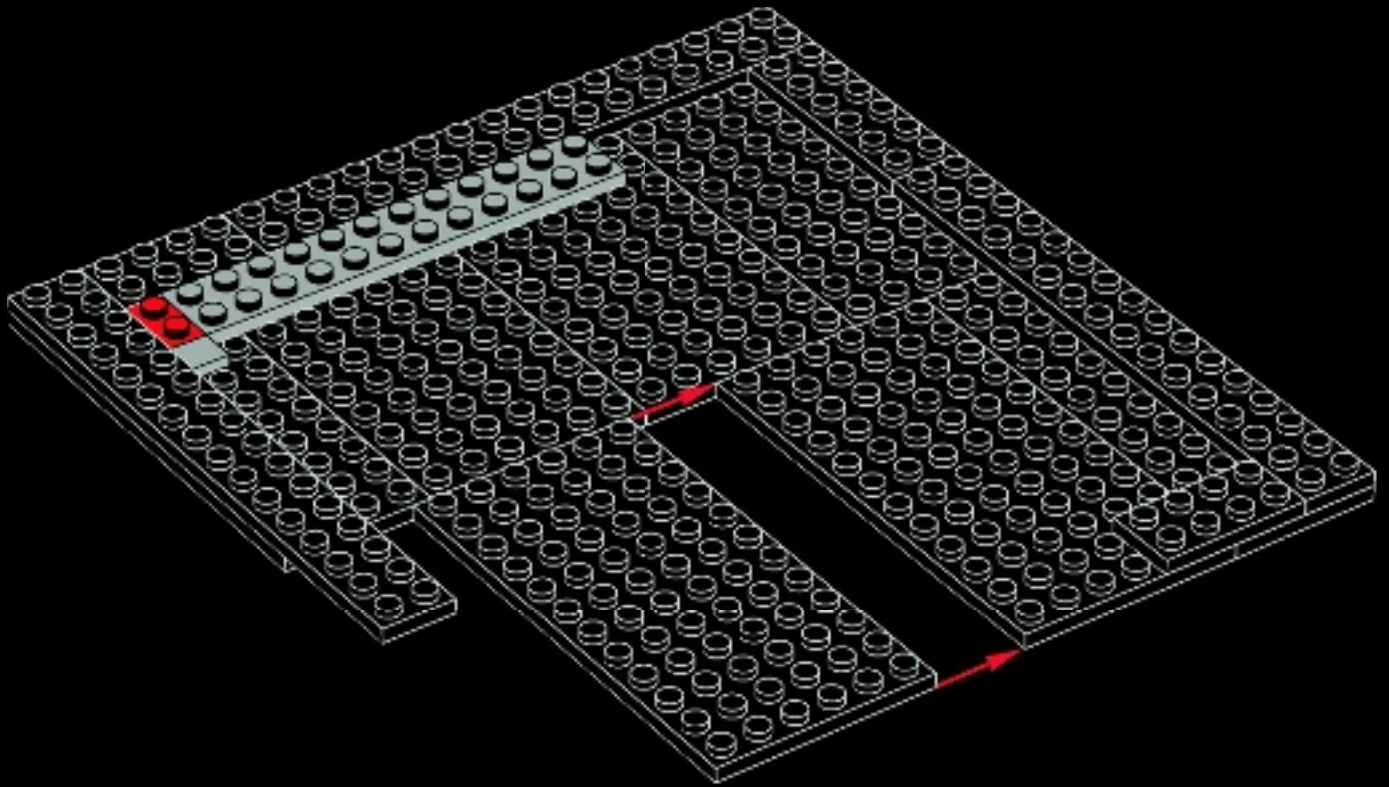

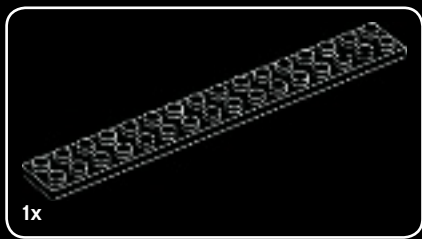

9

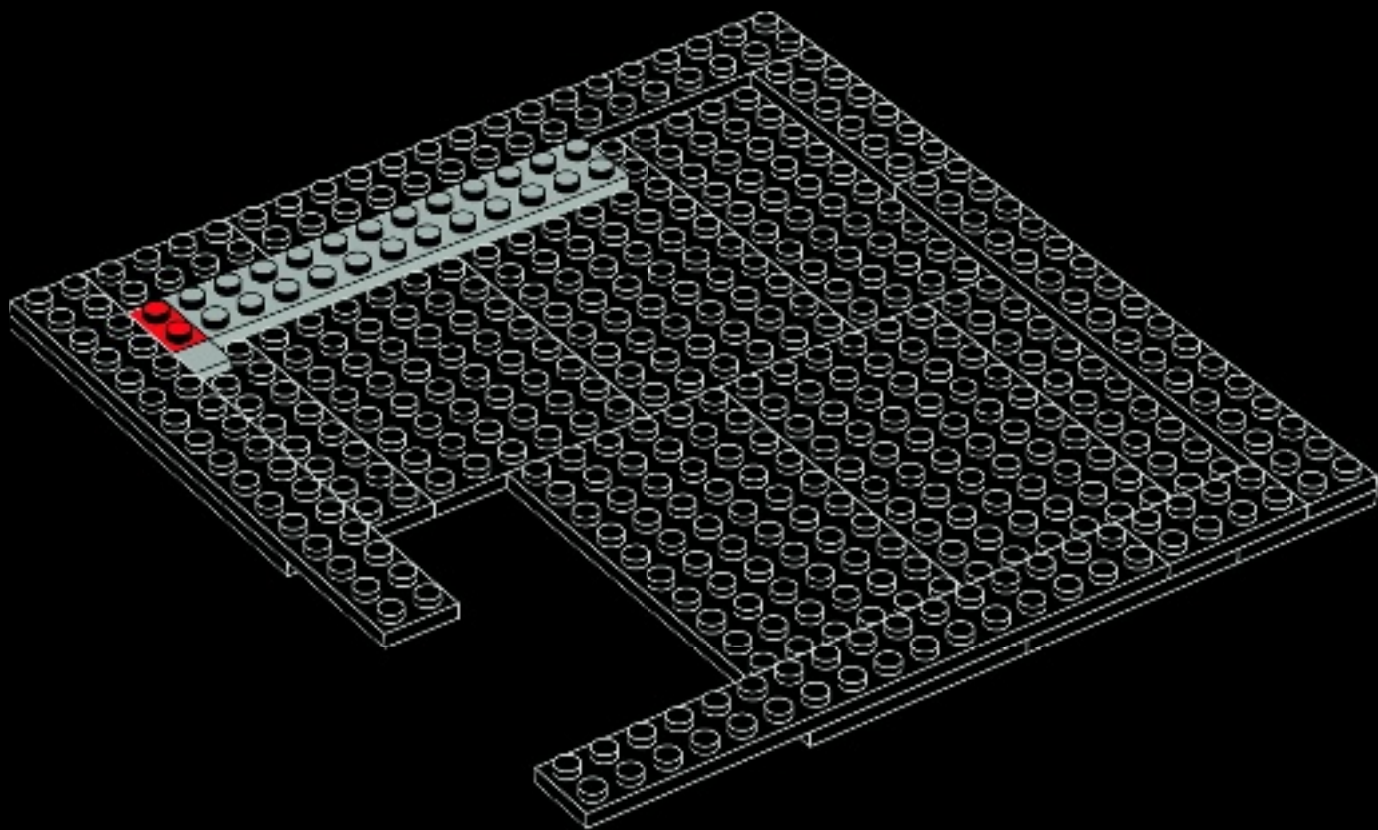

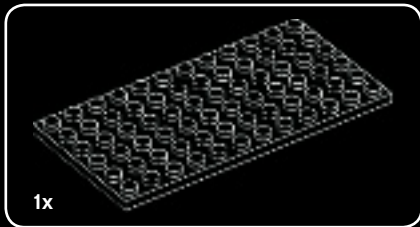

10

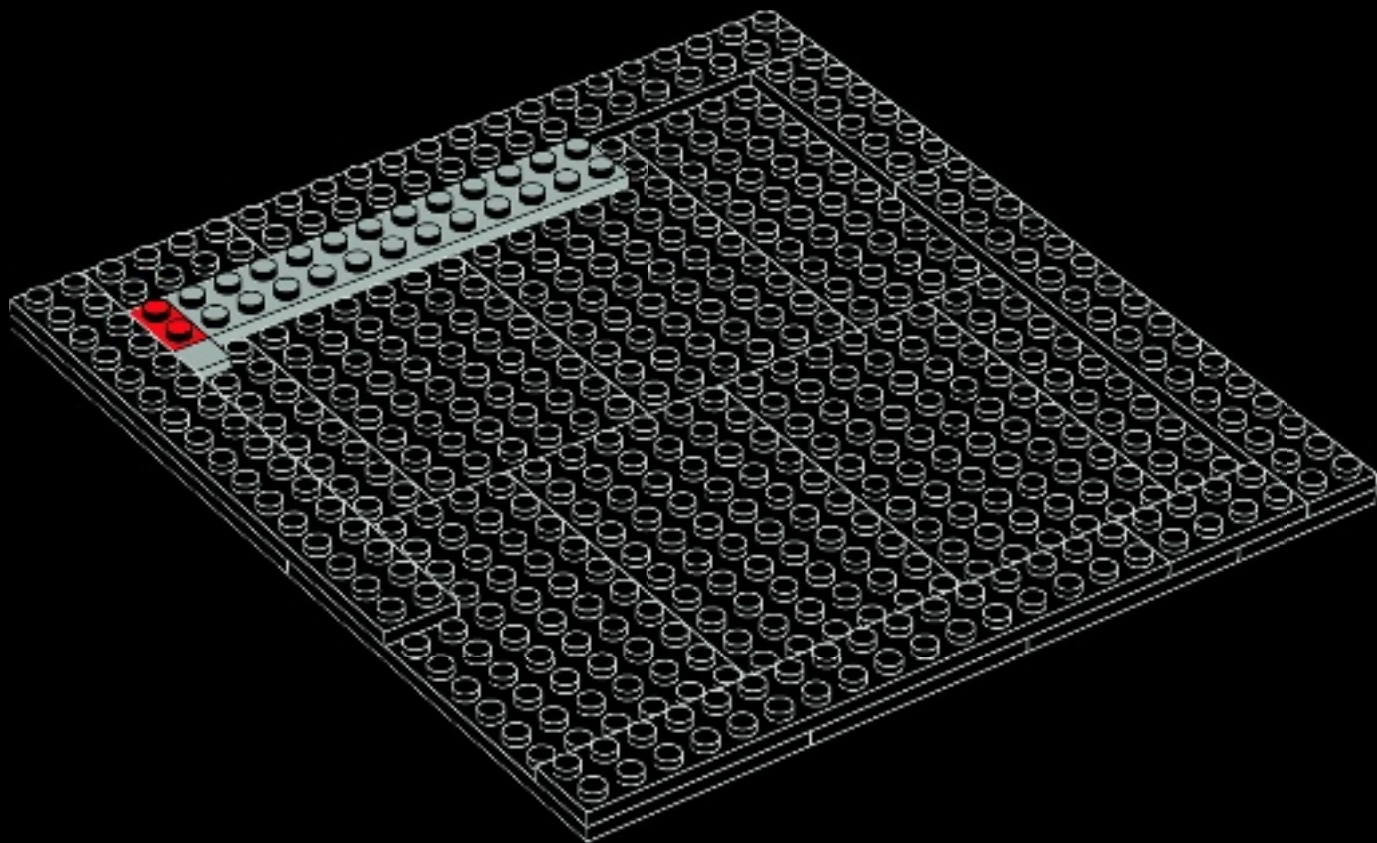



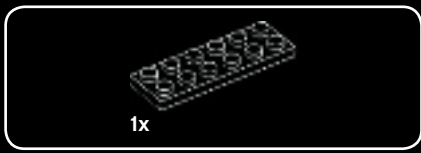

**11**

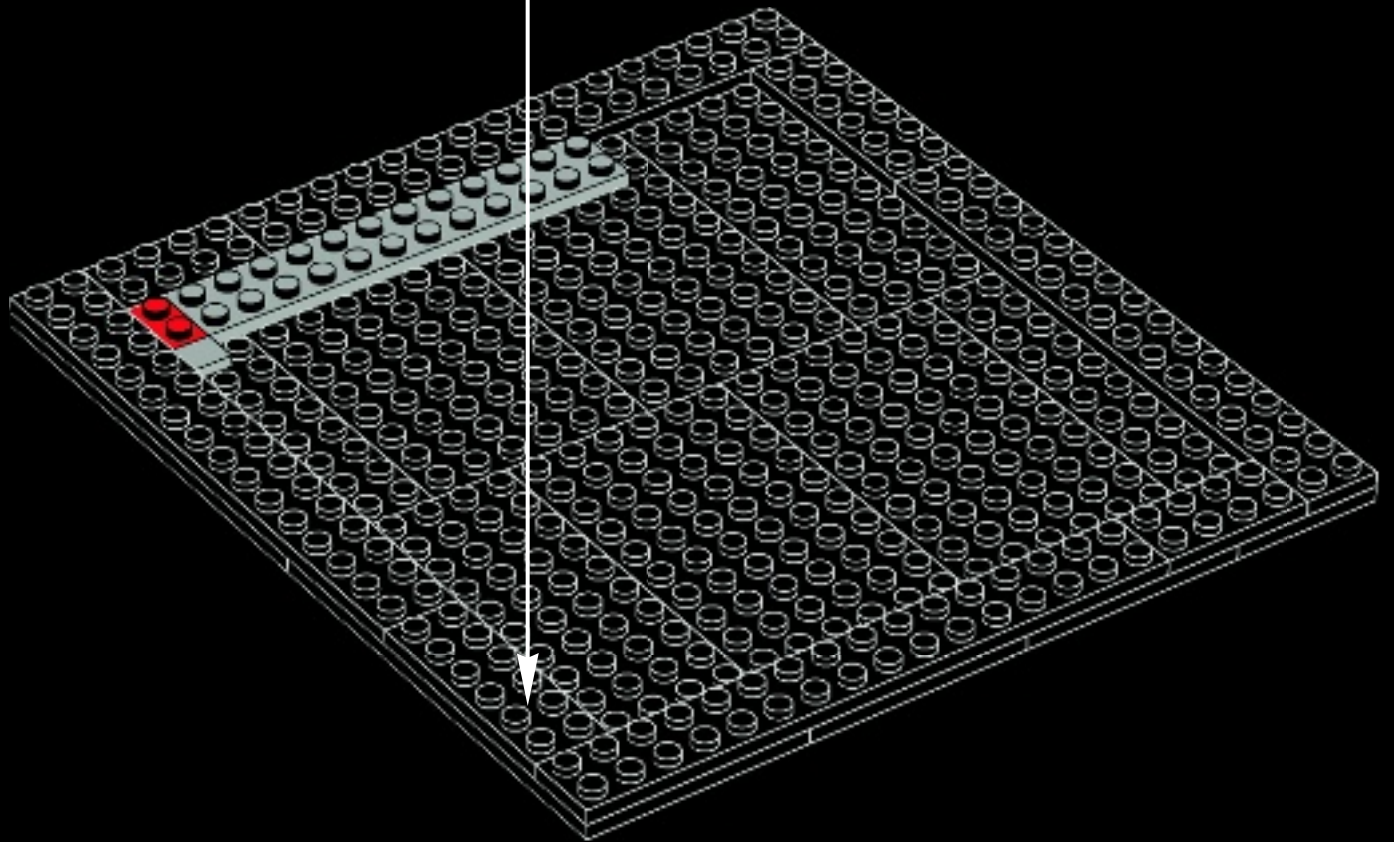
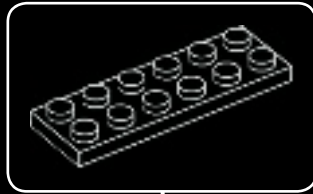



5x



5x

# 12

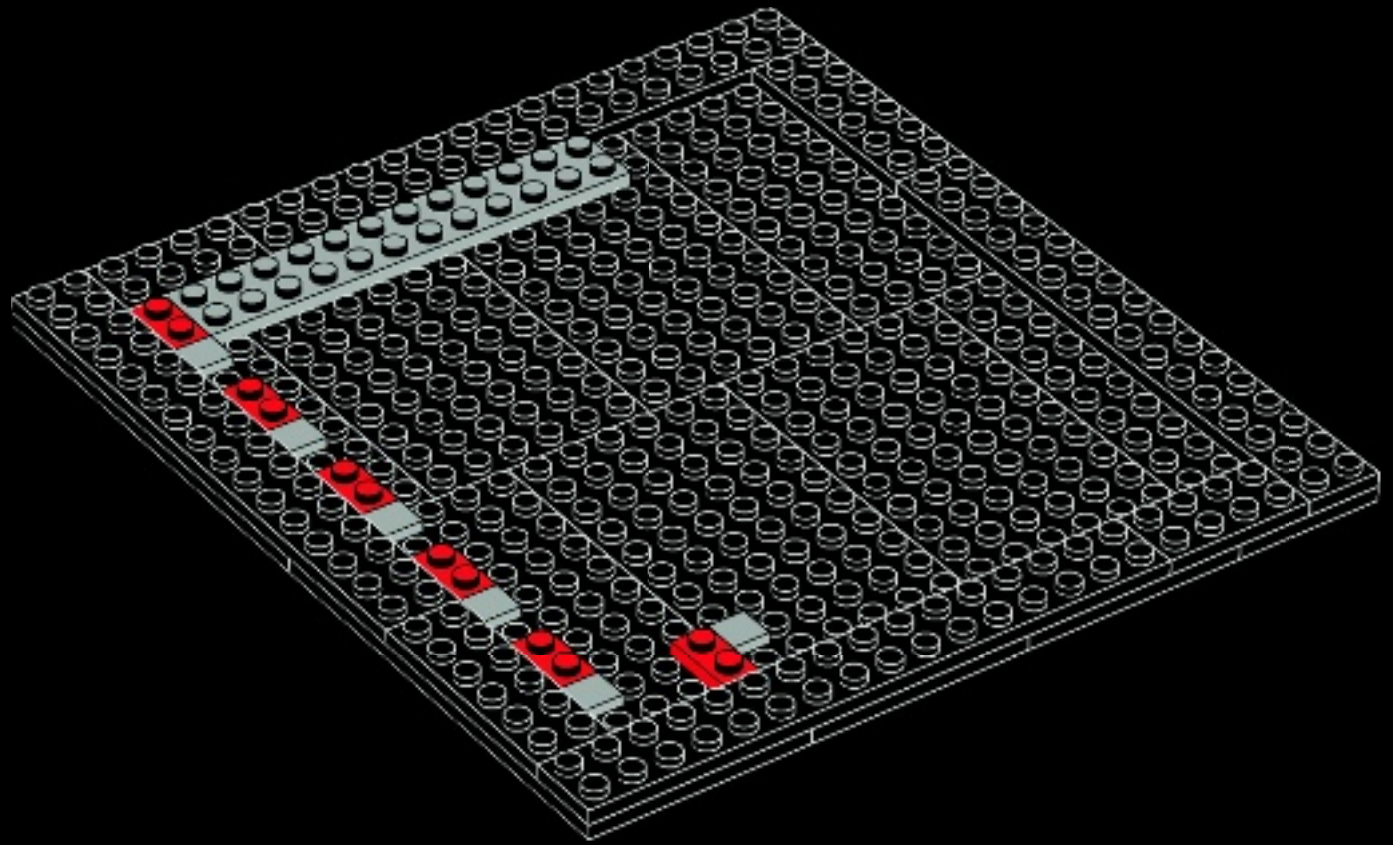

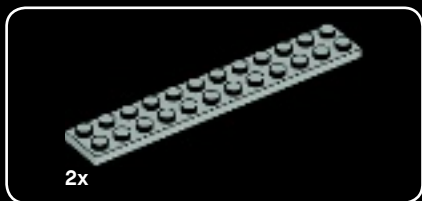

13

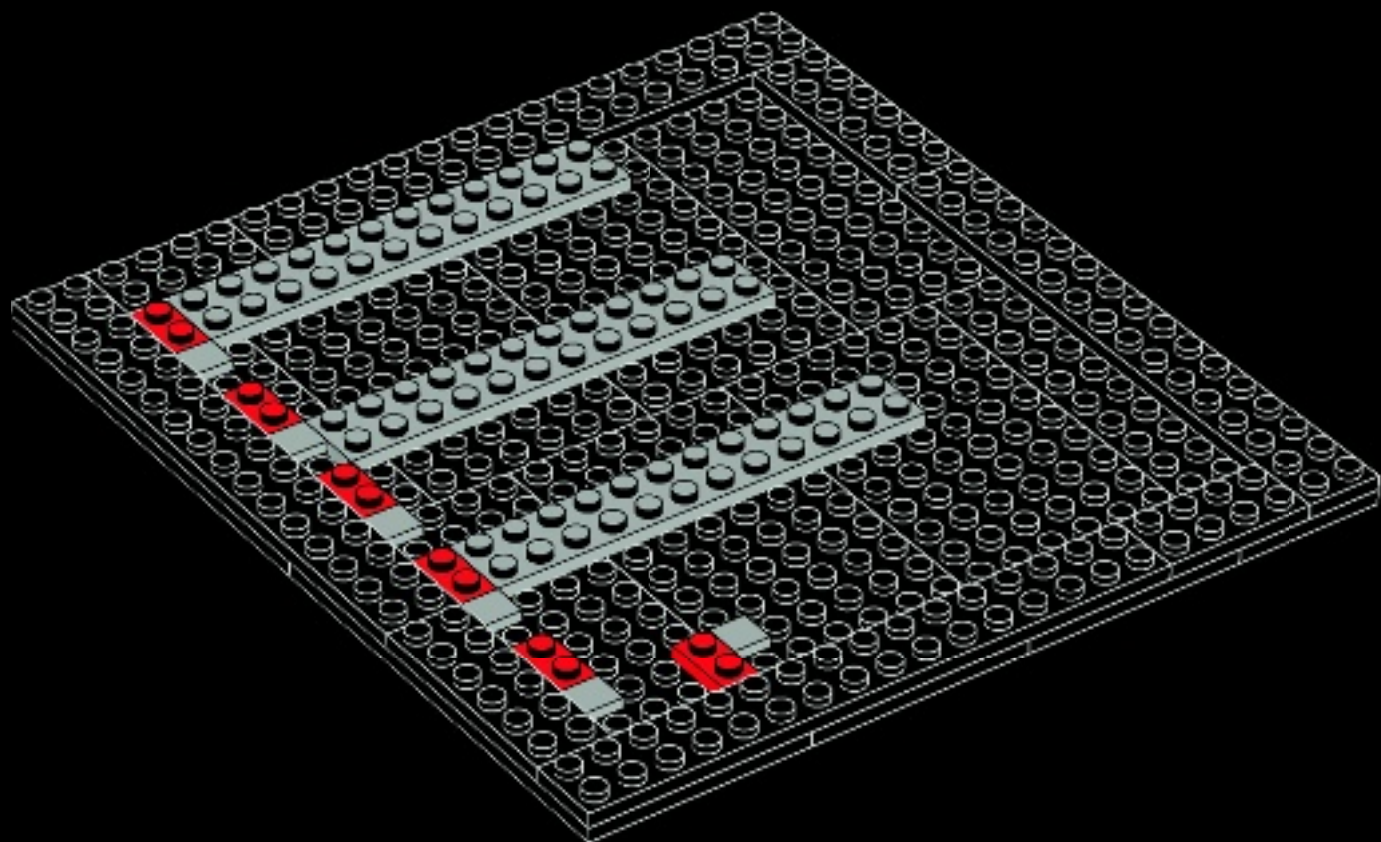

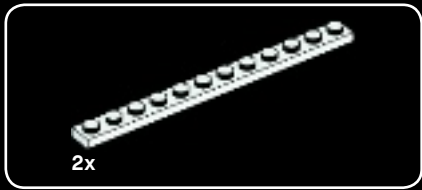

14

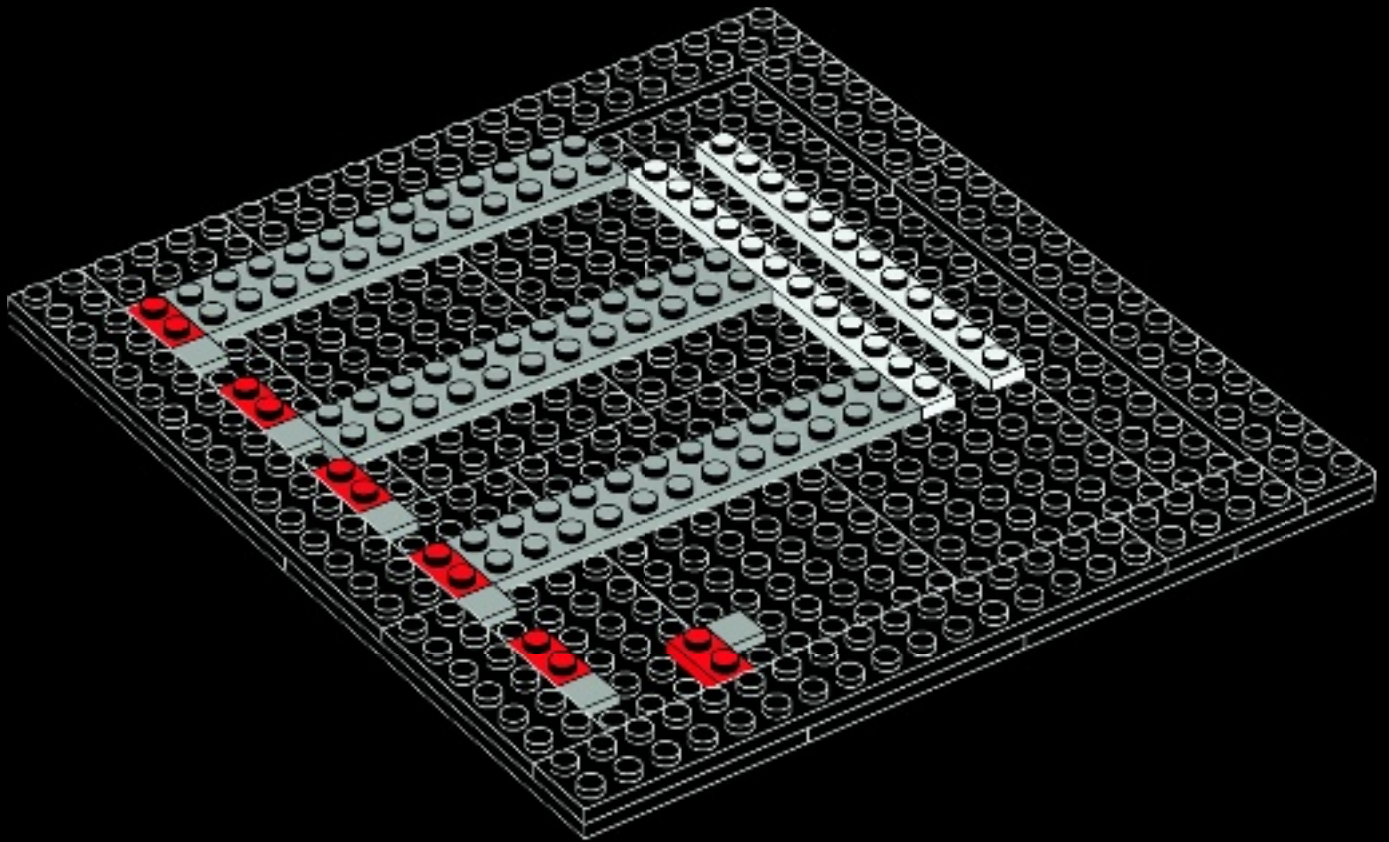





3x



2x

# 15

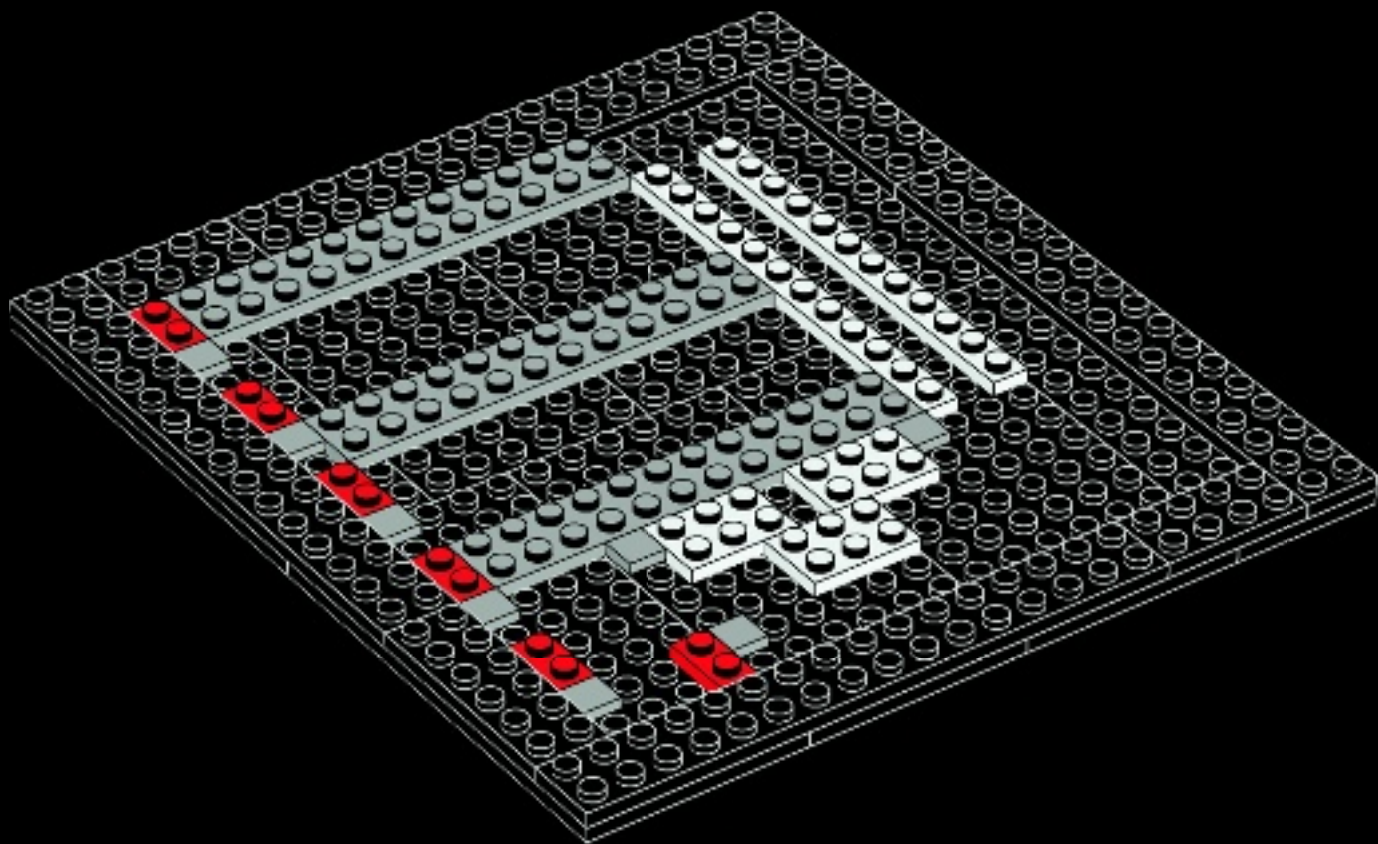

7x

1x

7x

# 16

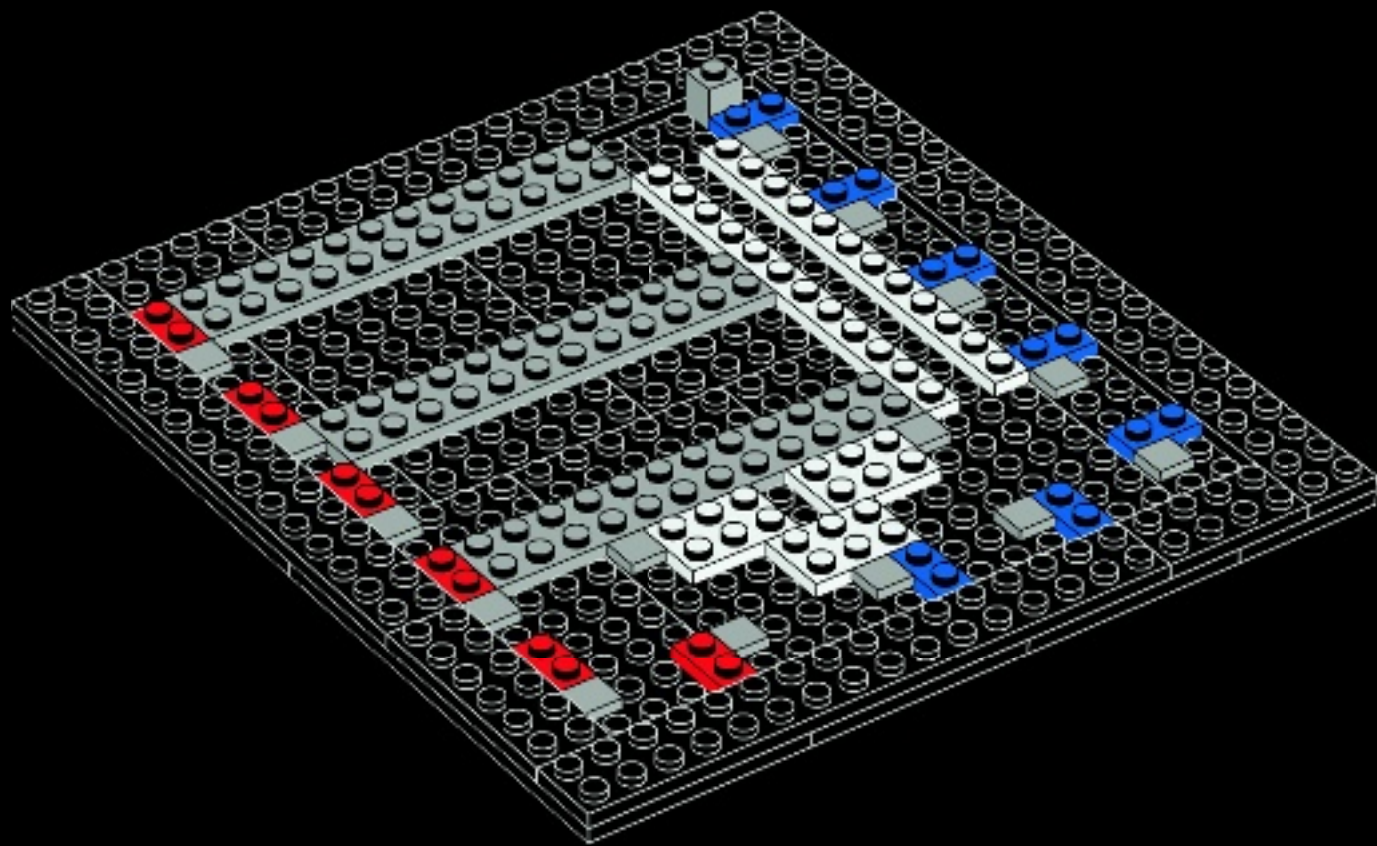



8x

17

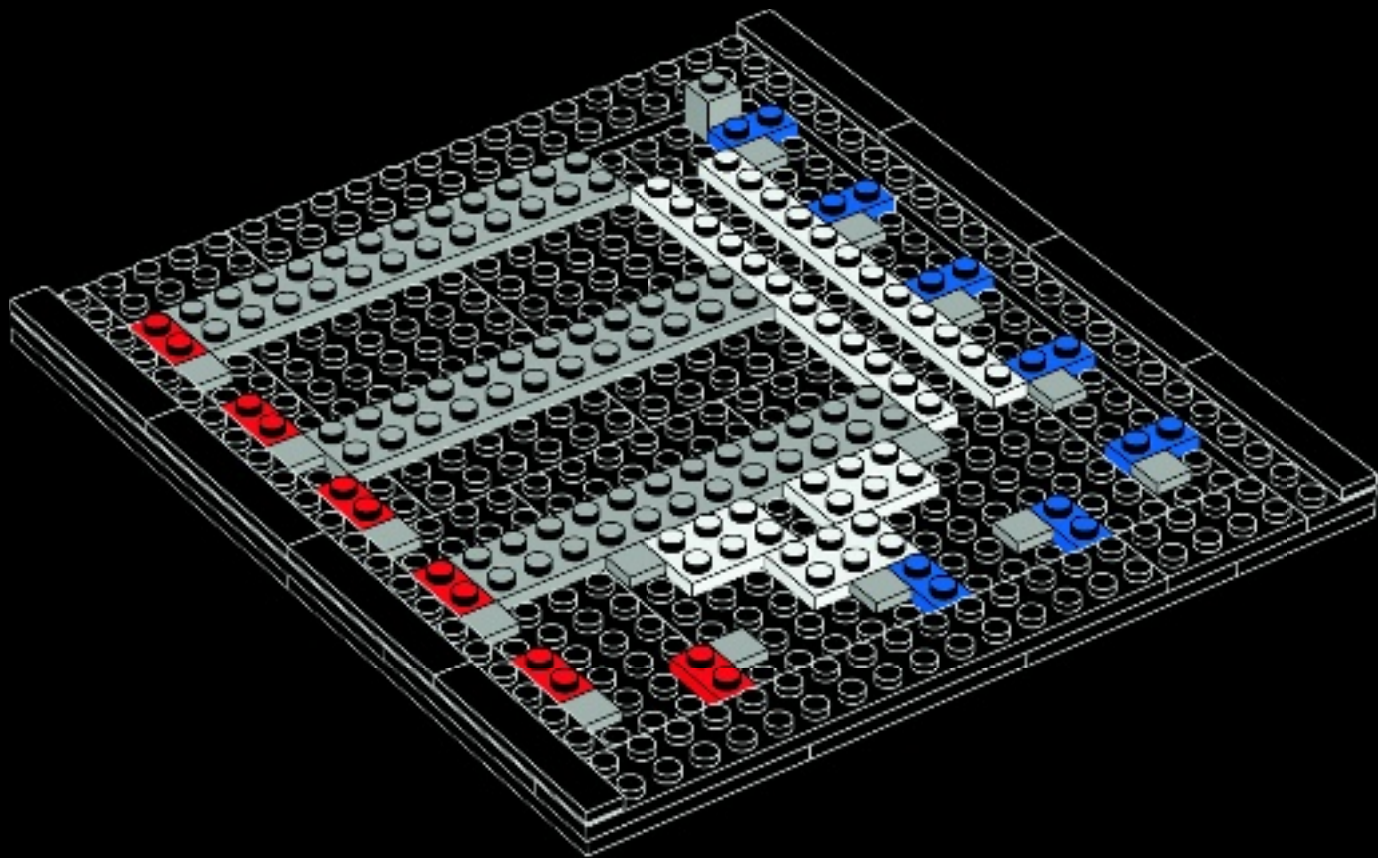



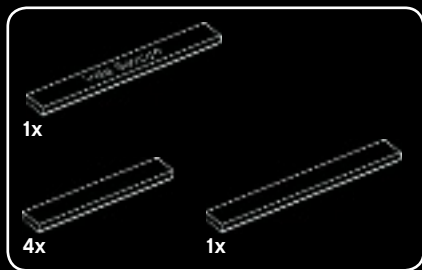

18

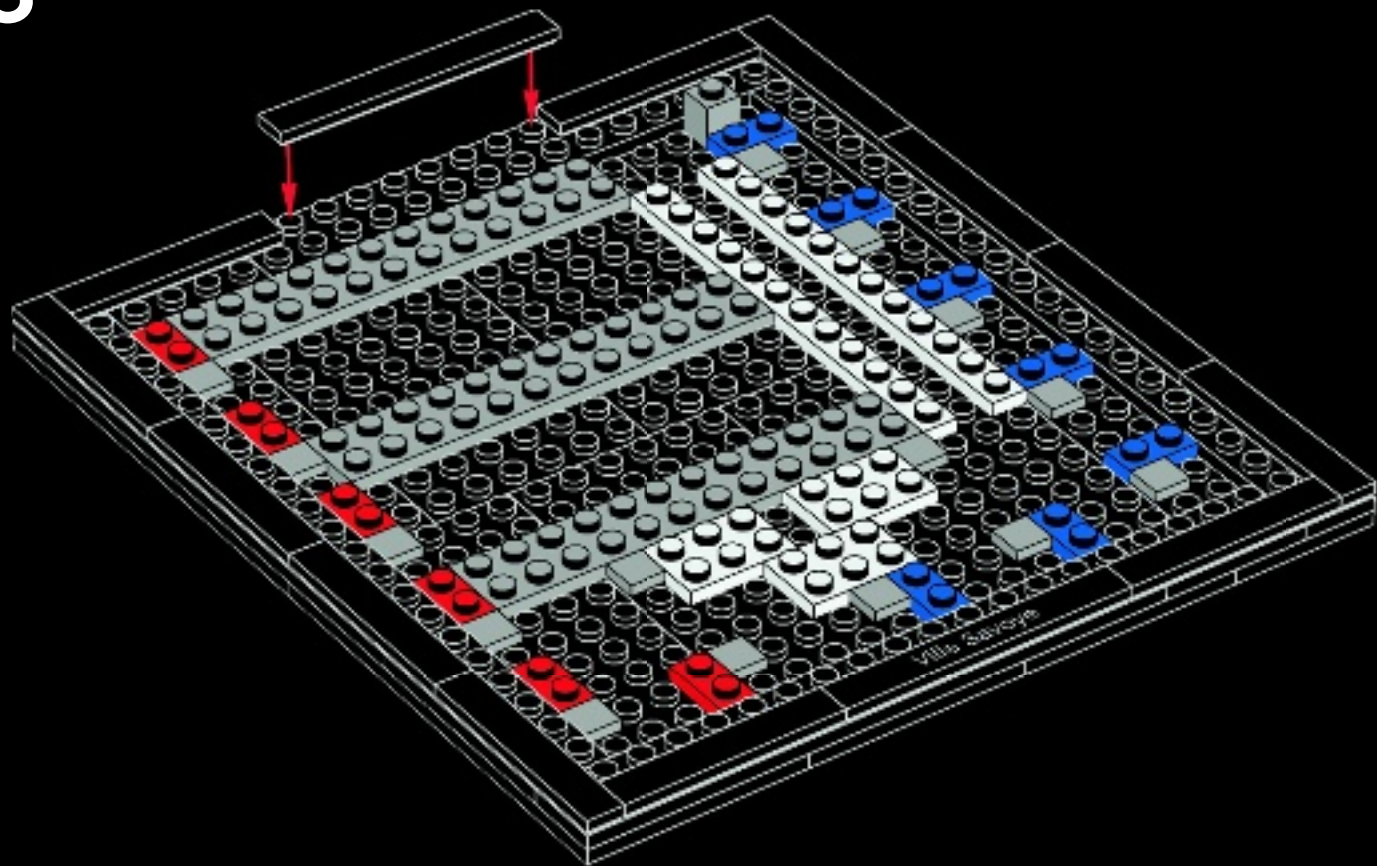



# 19

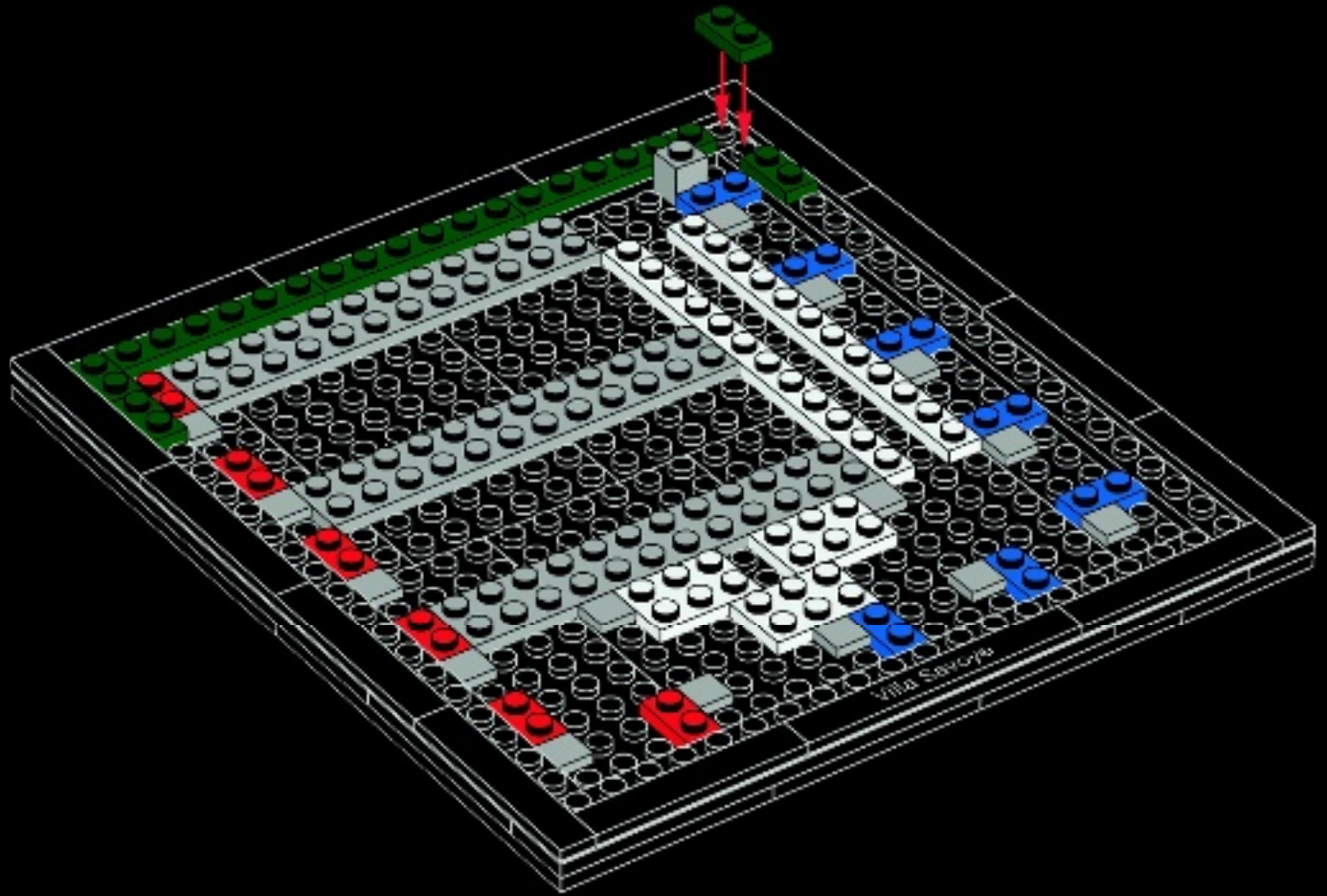





9x

# 20

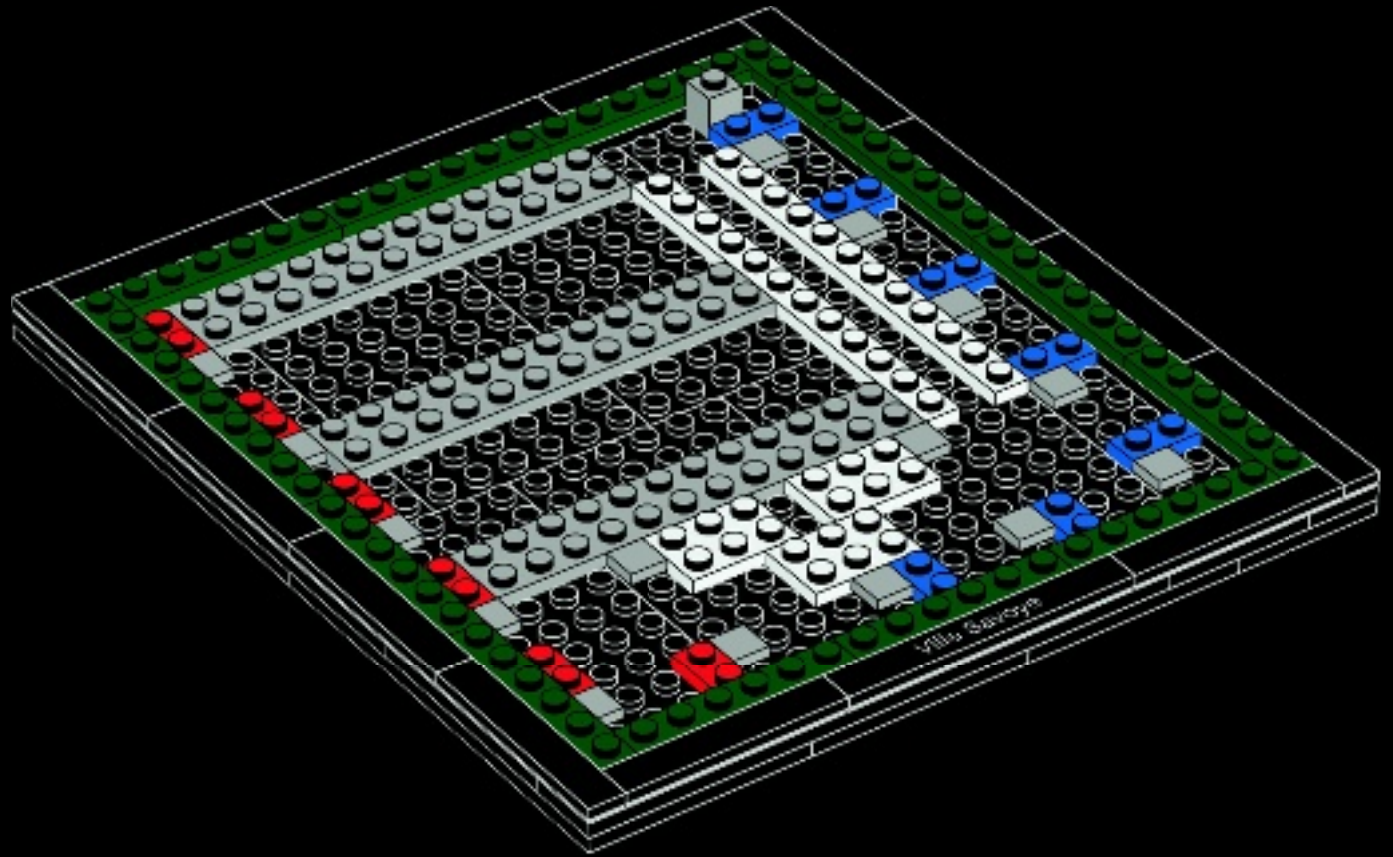



6x

# 21

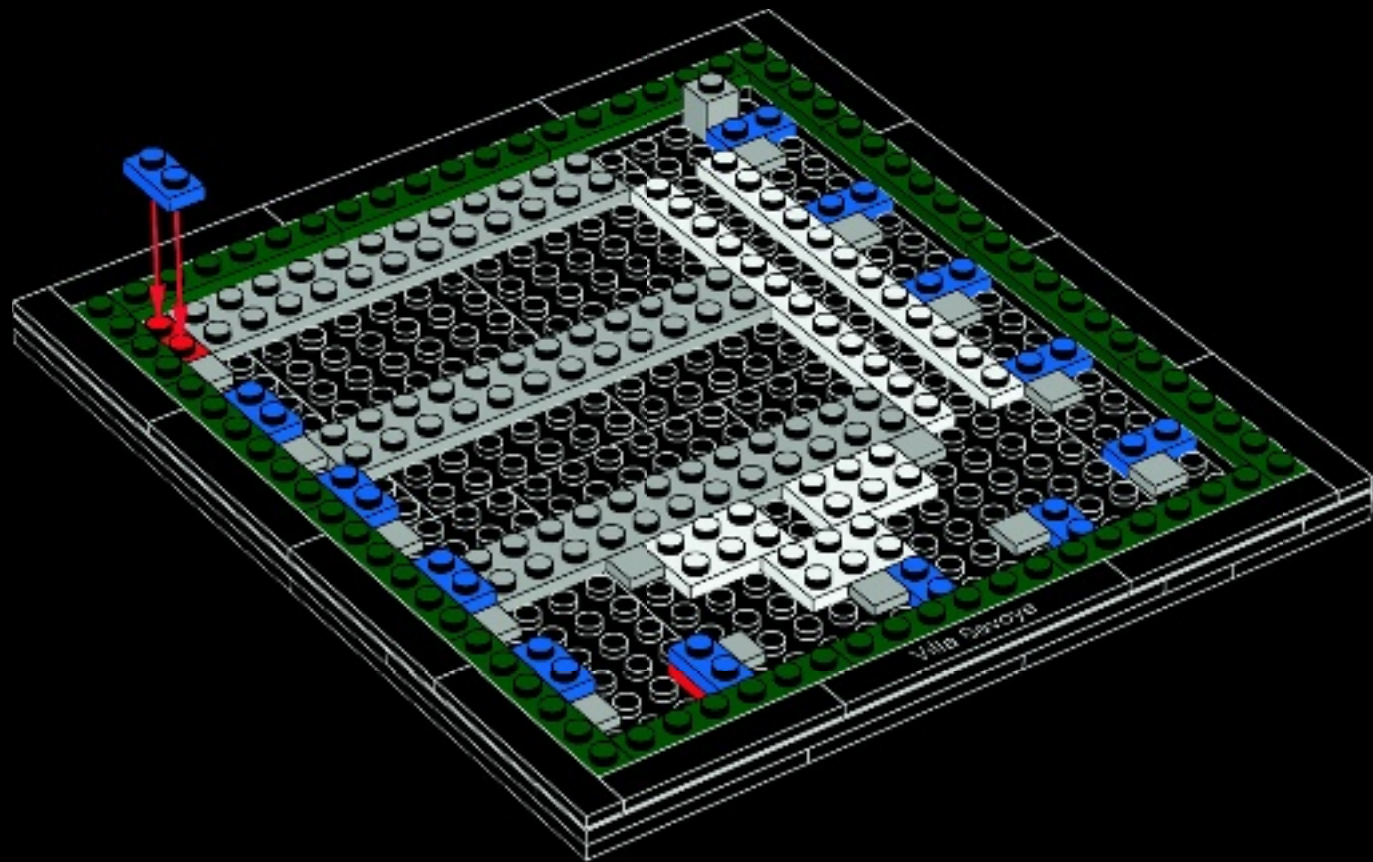



7x

22

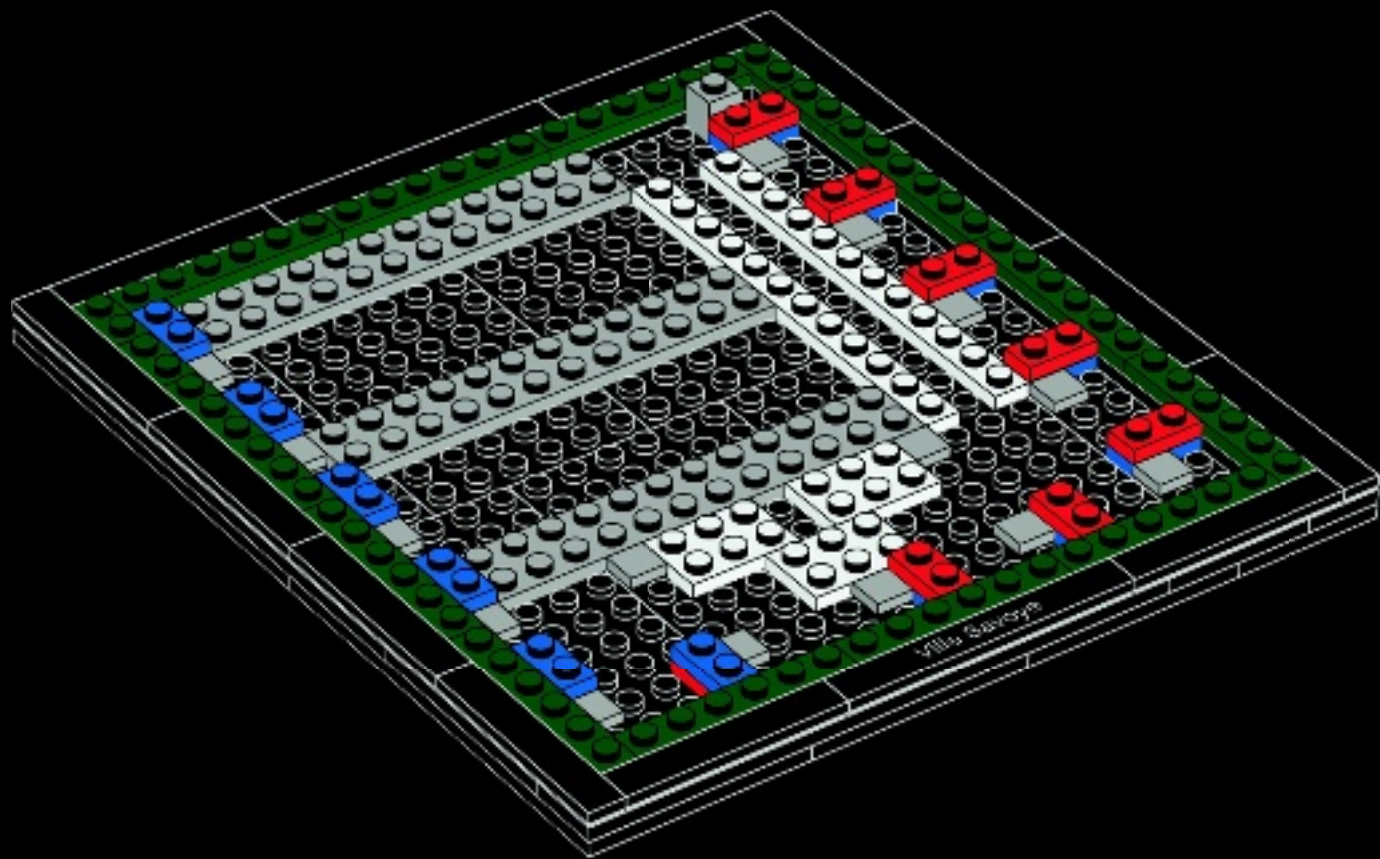





5x

# 23

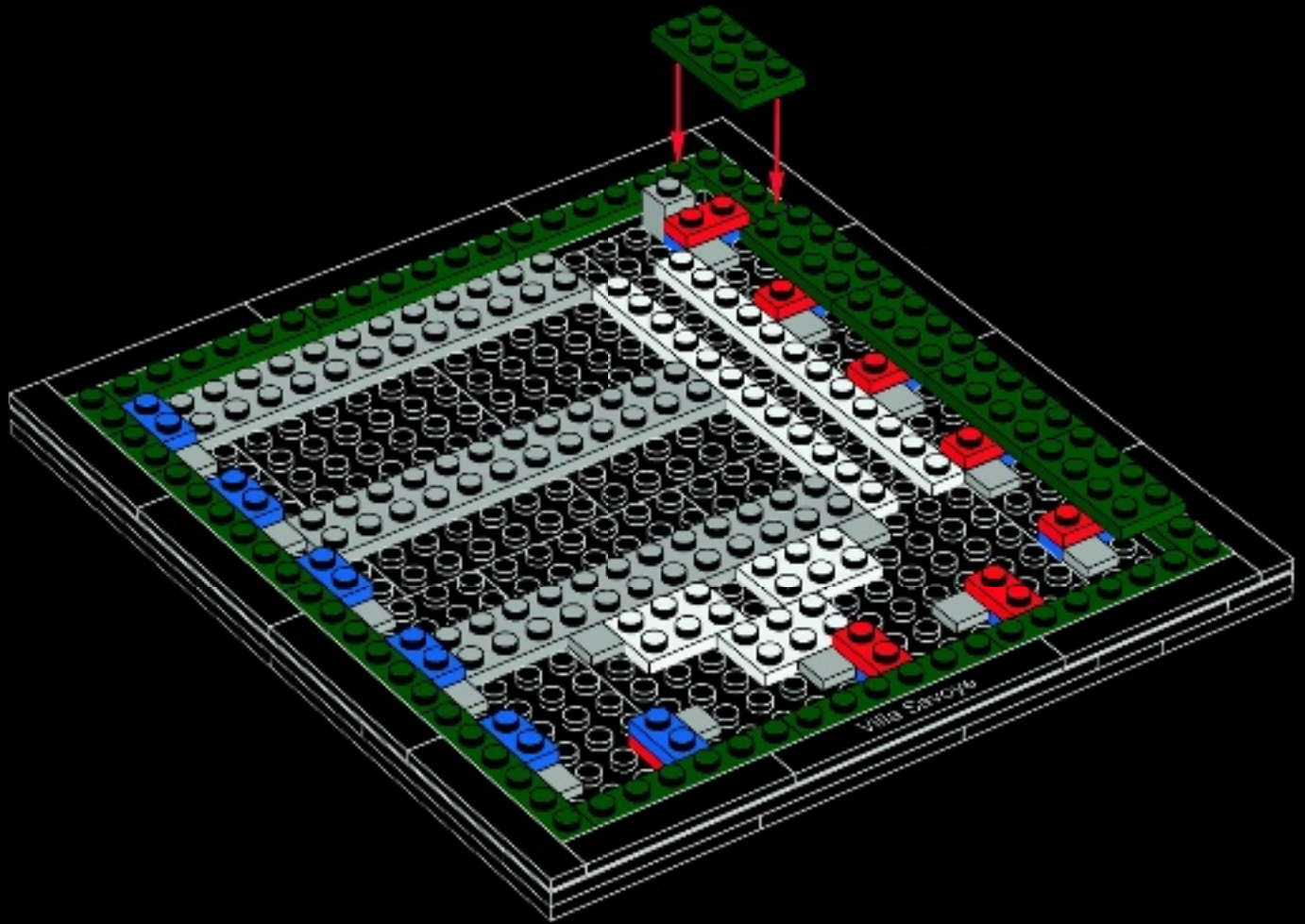





24

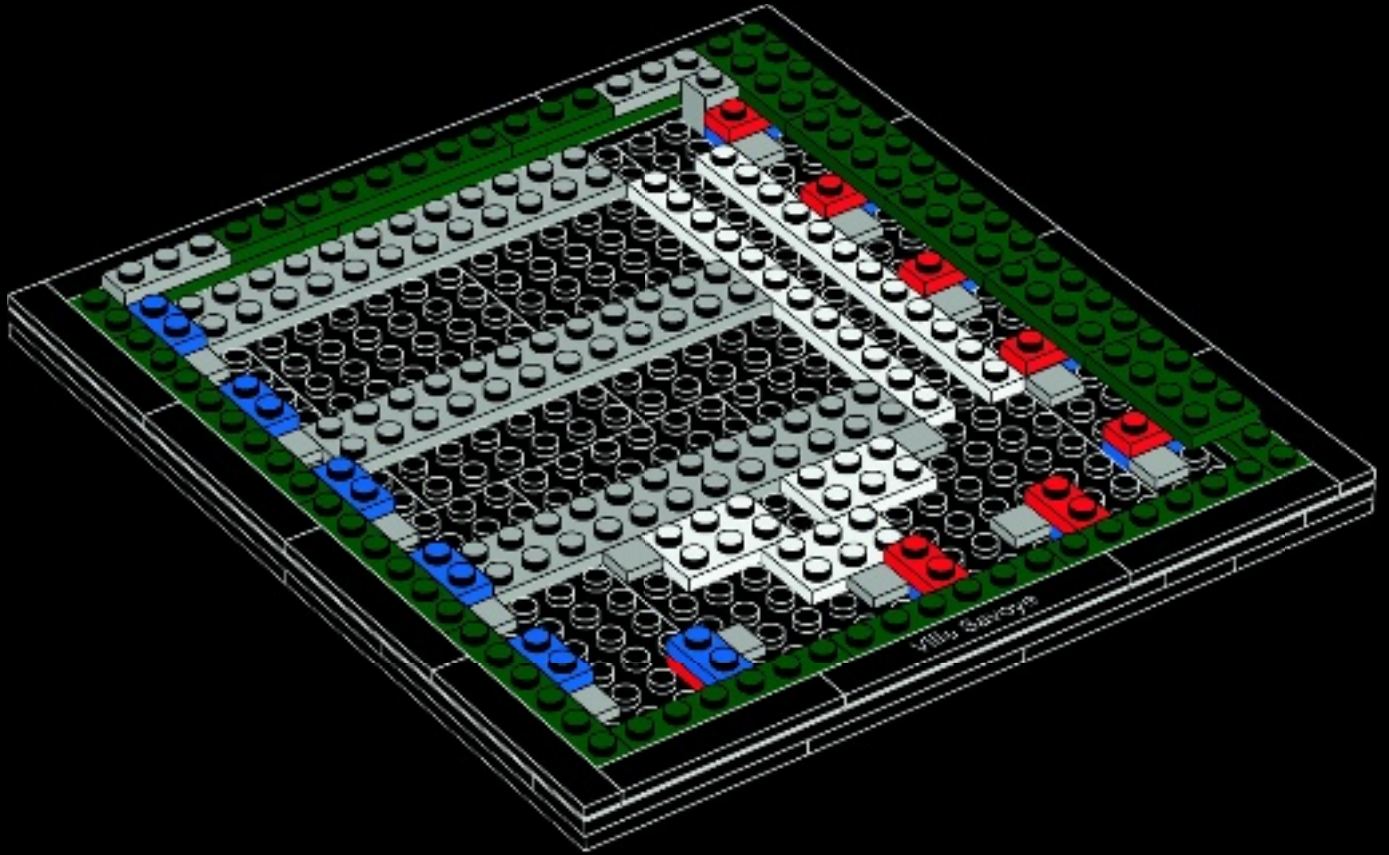

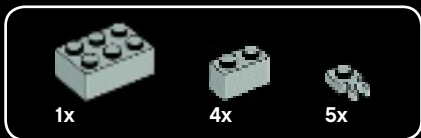

# 25

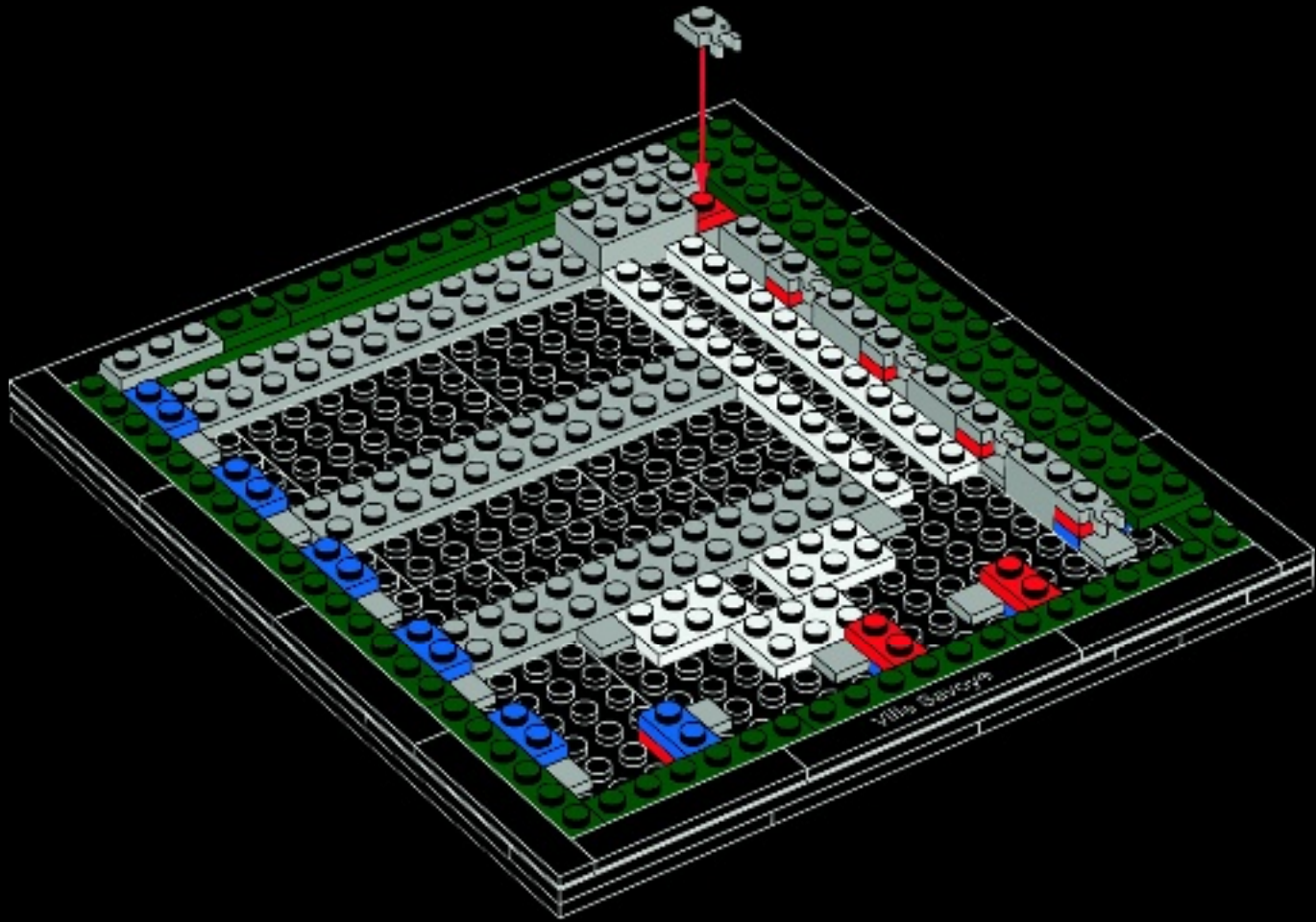

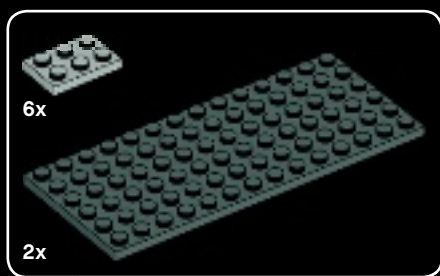

26

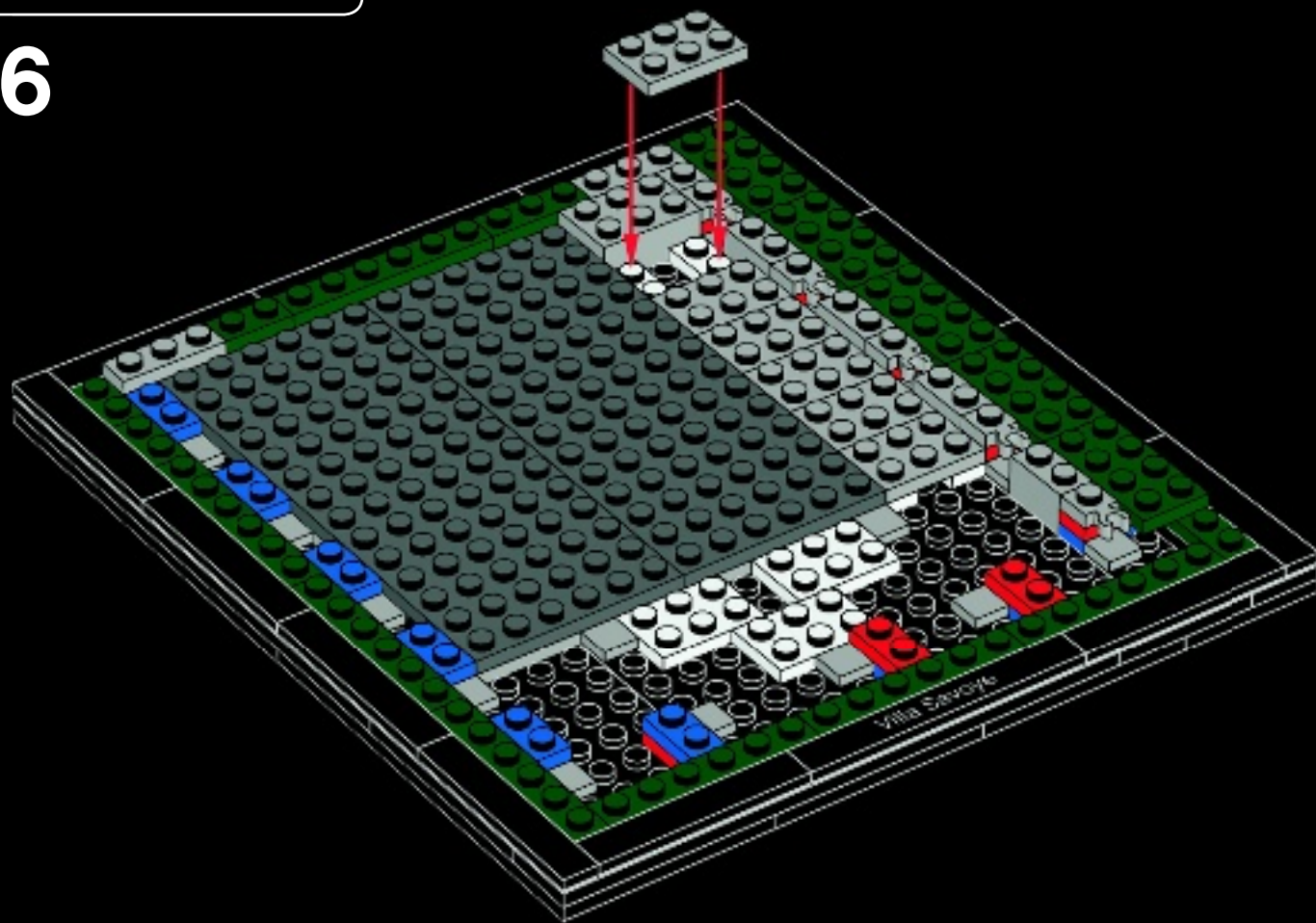





6x

# 27

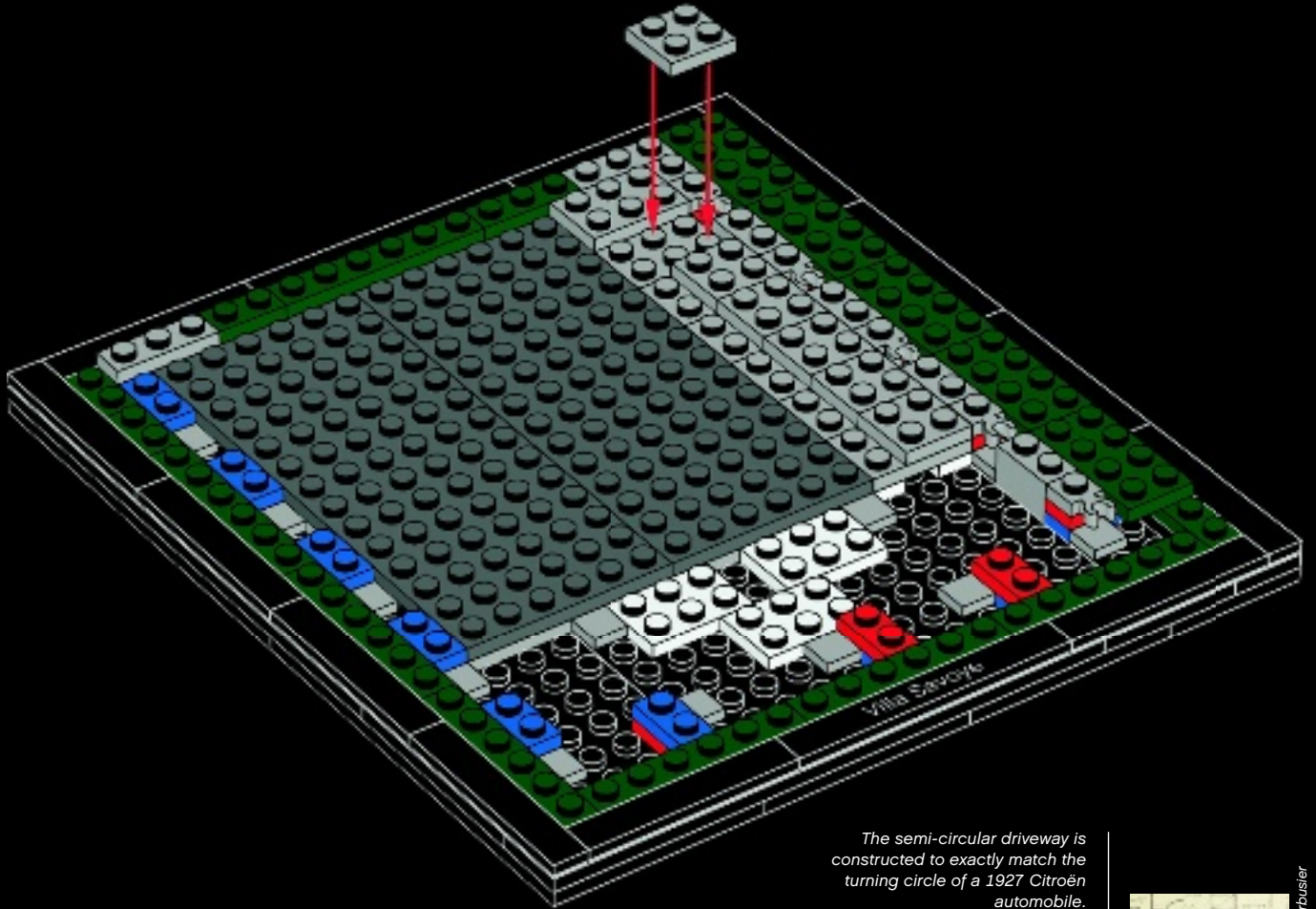

The semi-circular driveway is constructed to exactly match the turning circle of a 1927 Citroën automobile.

L'allée autour du rez-de-chaussée, avec son chemin semi-circulaire, reproduit exactement l'angle de virage pour une automobile Citroën de 1927.



© Fondation Le Corbusier





# 28

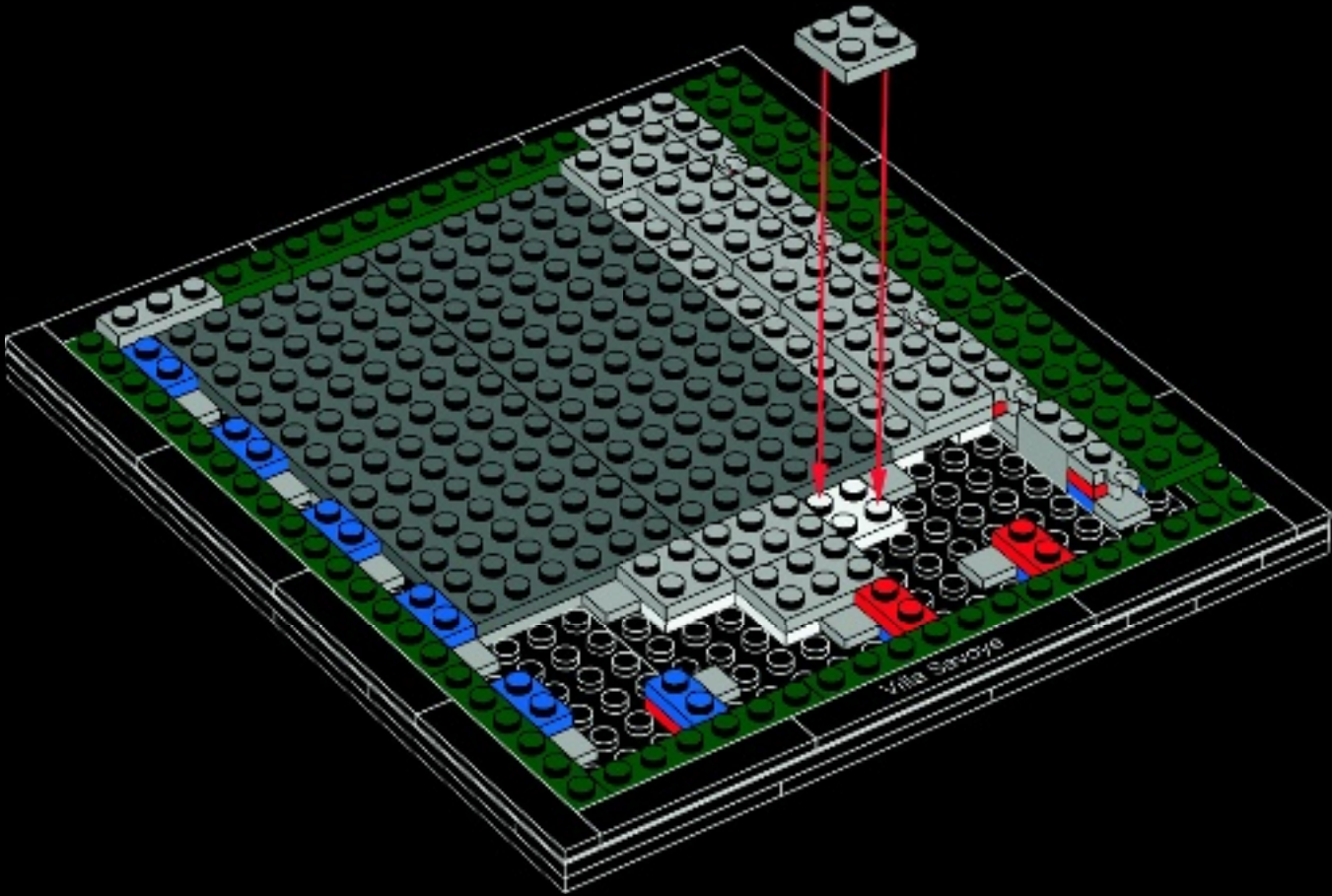



# 29

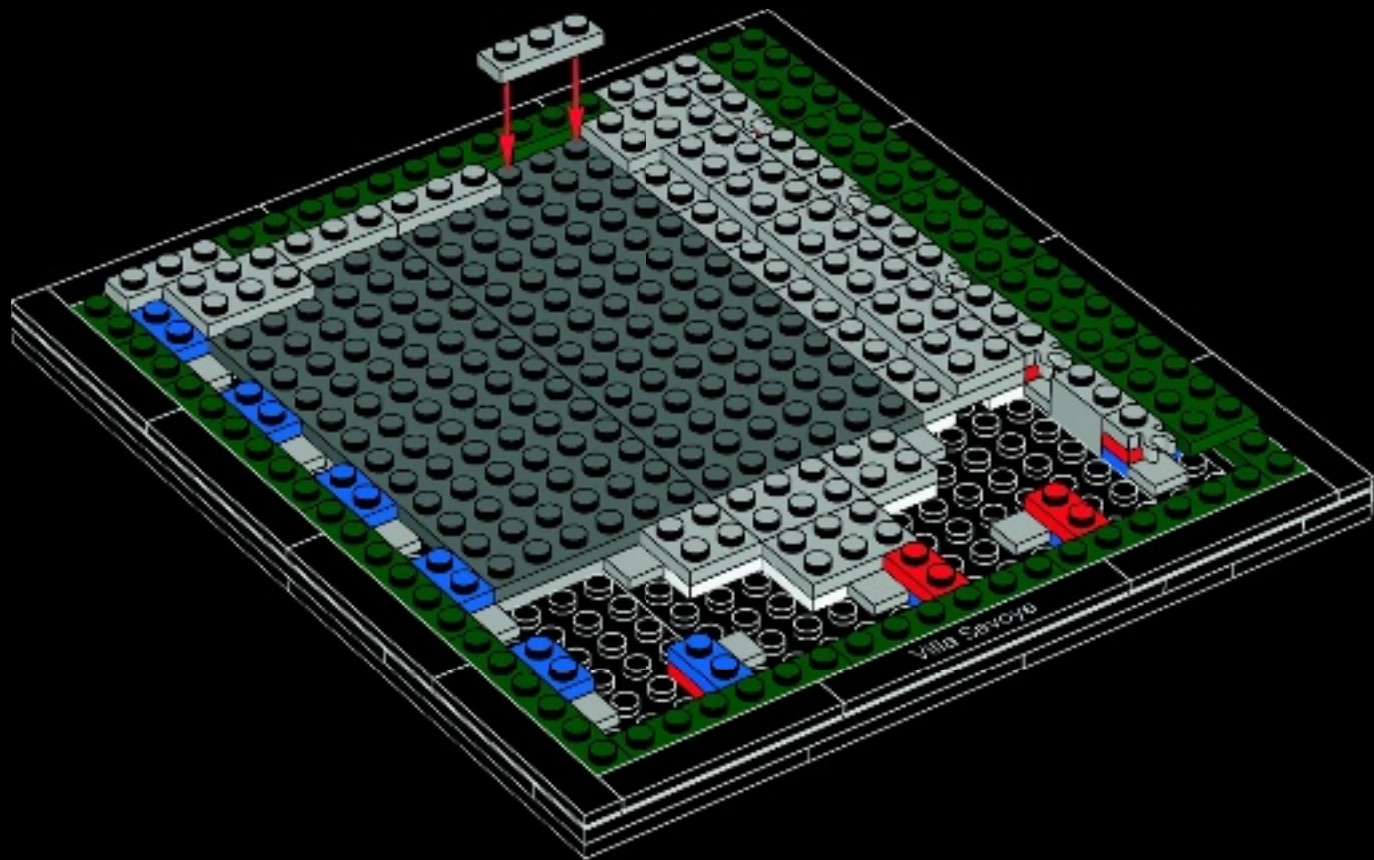



2x



4x



1x

# 30

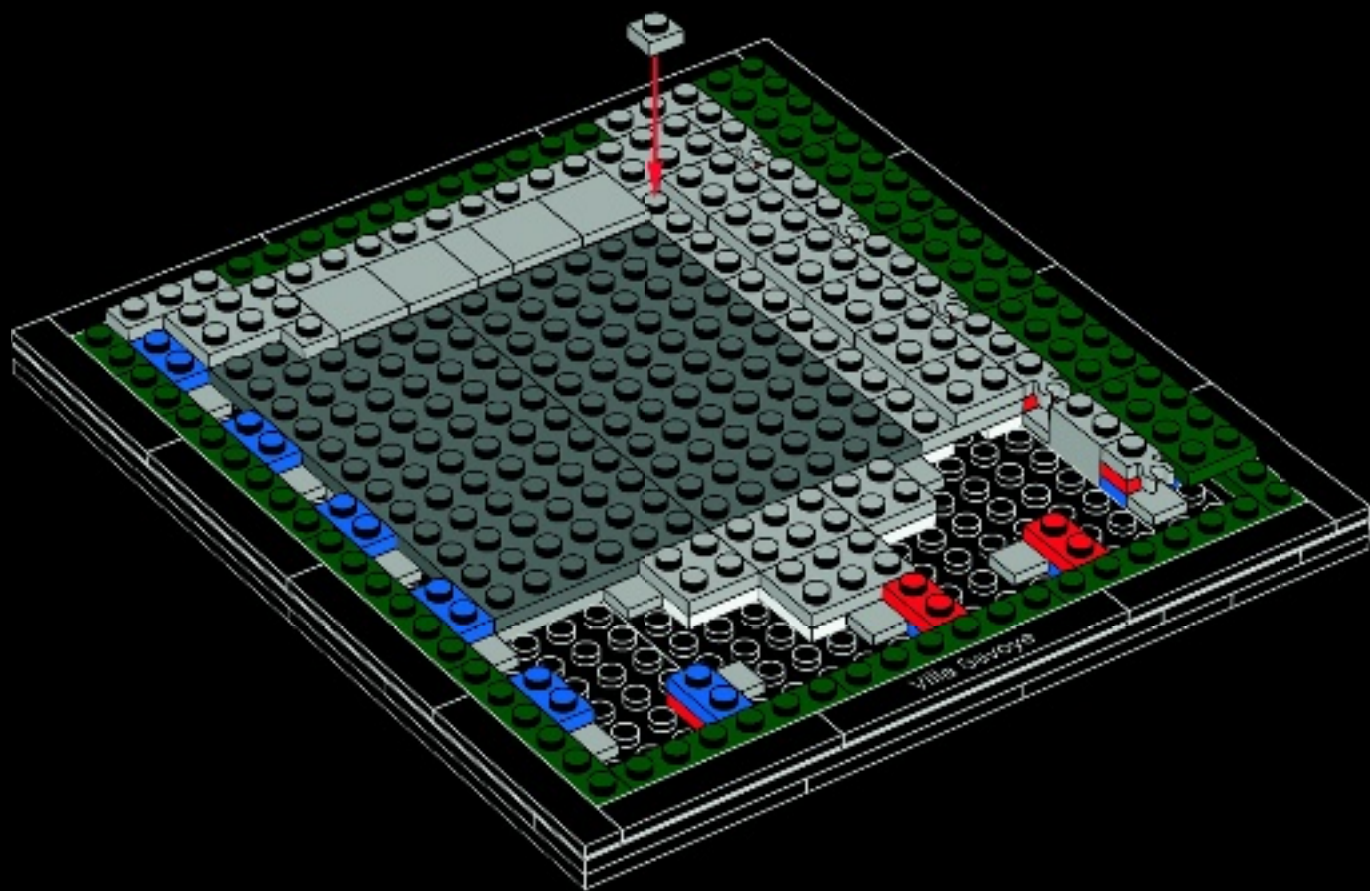



6x

# 31

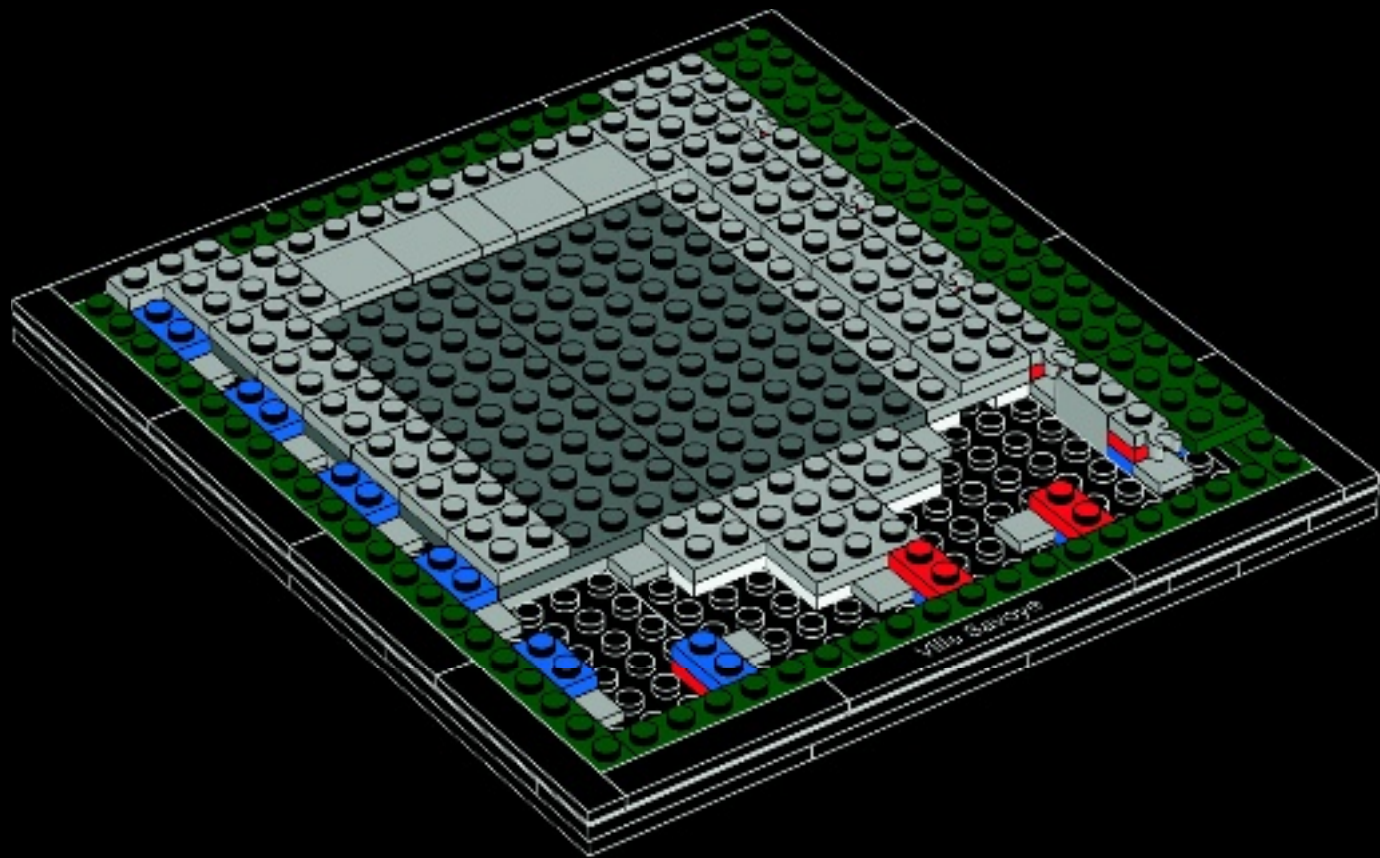





2x



4x

# 32

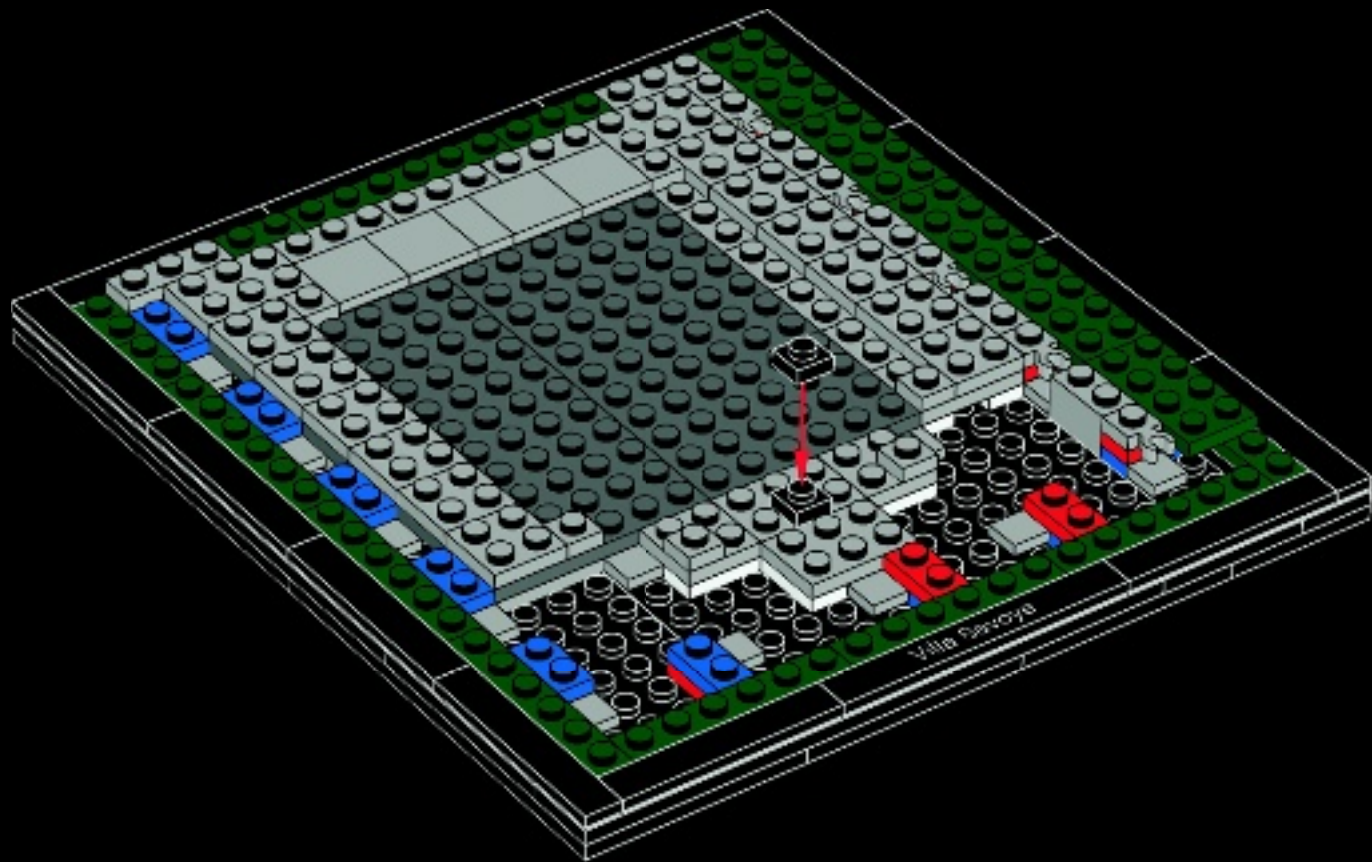



5x



5x

# 33

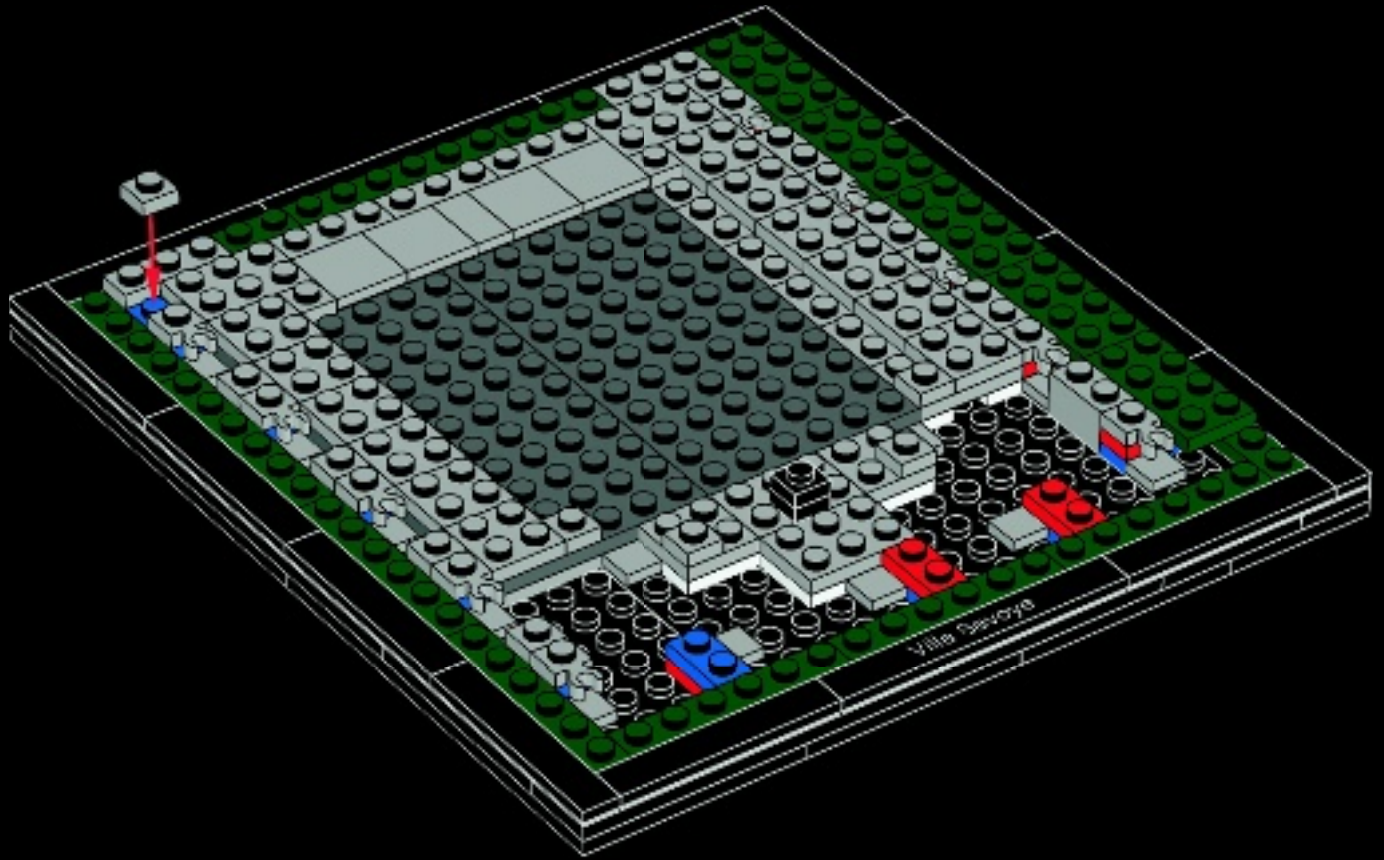



4x

# 34

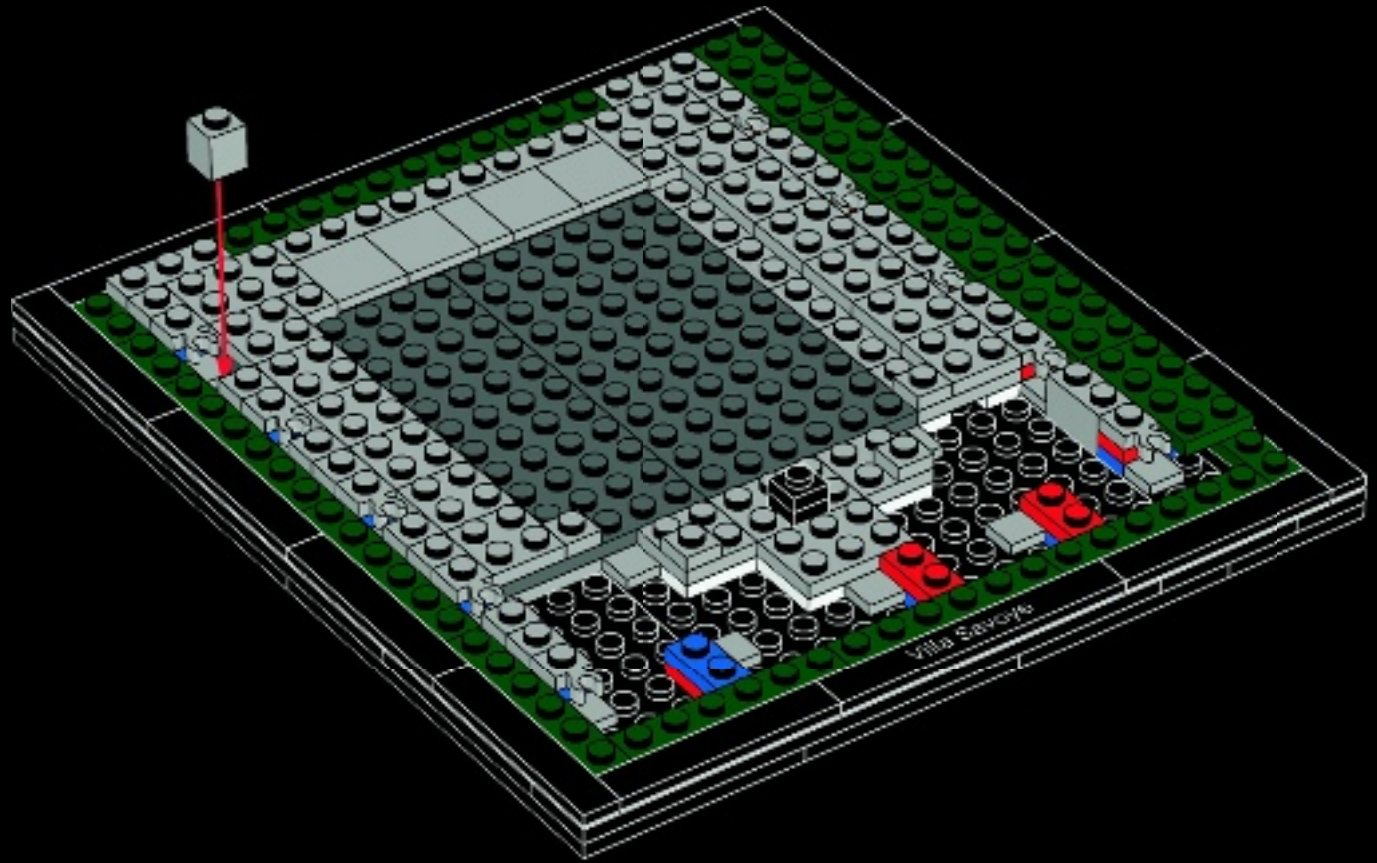





2x



2x

# 35



2x

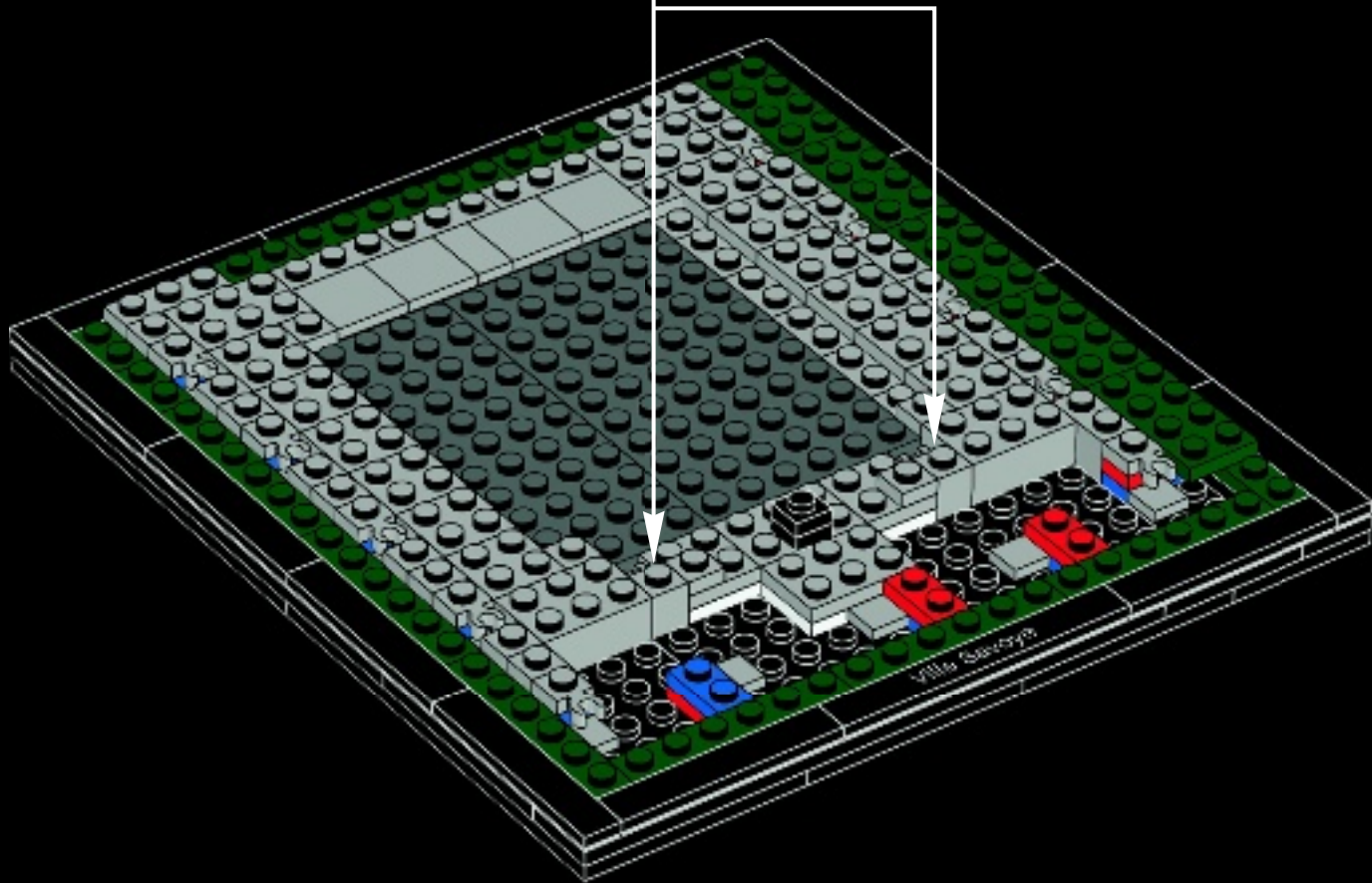





# 36

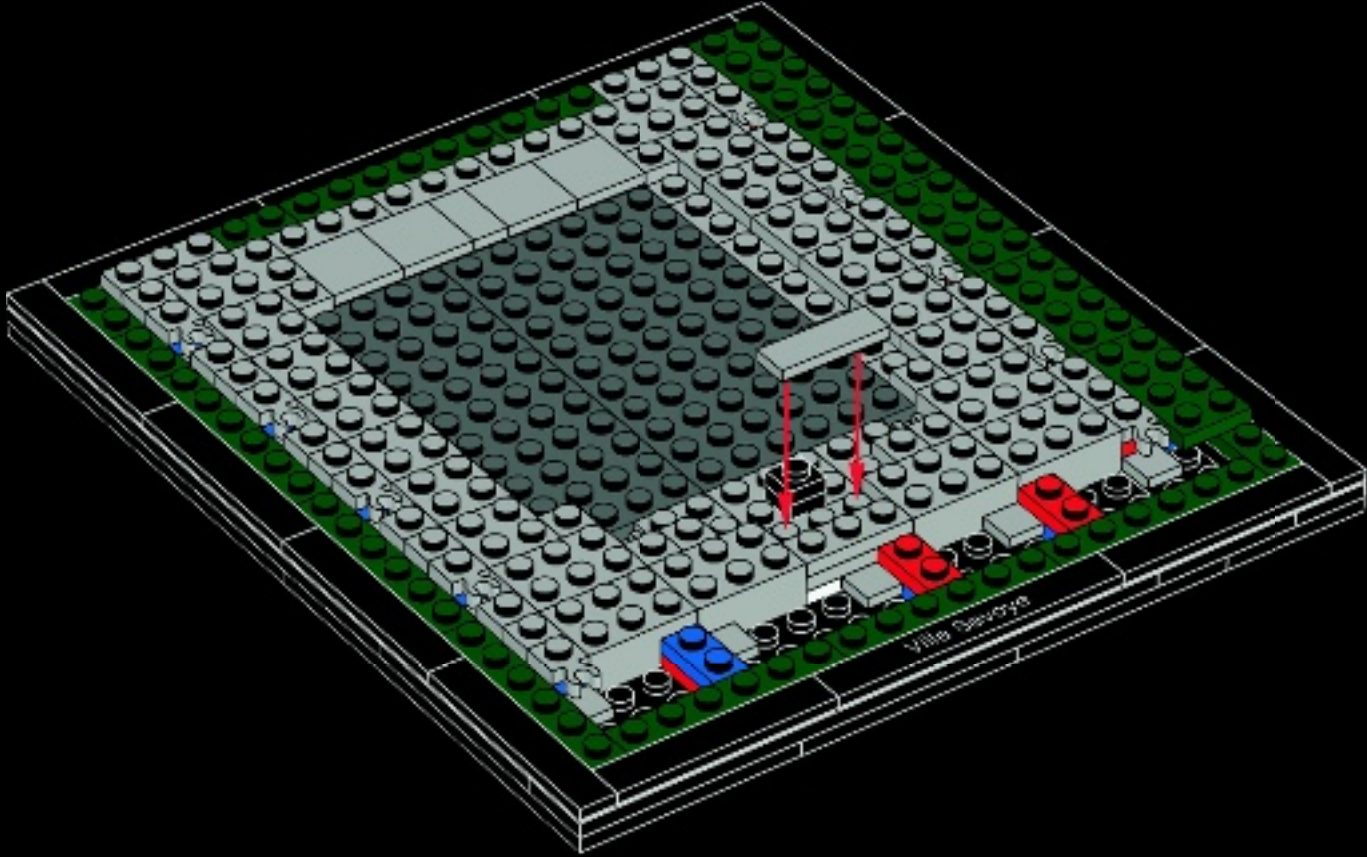



4x



1x



3x

# 37

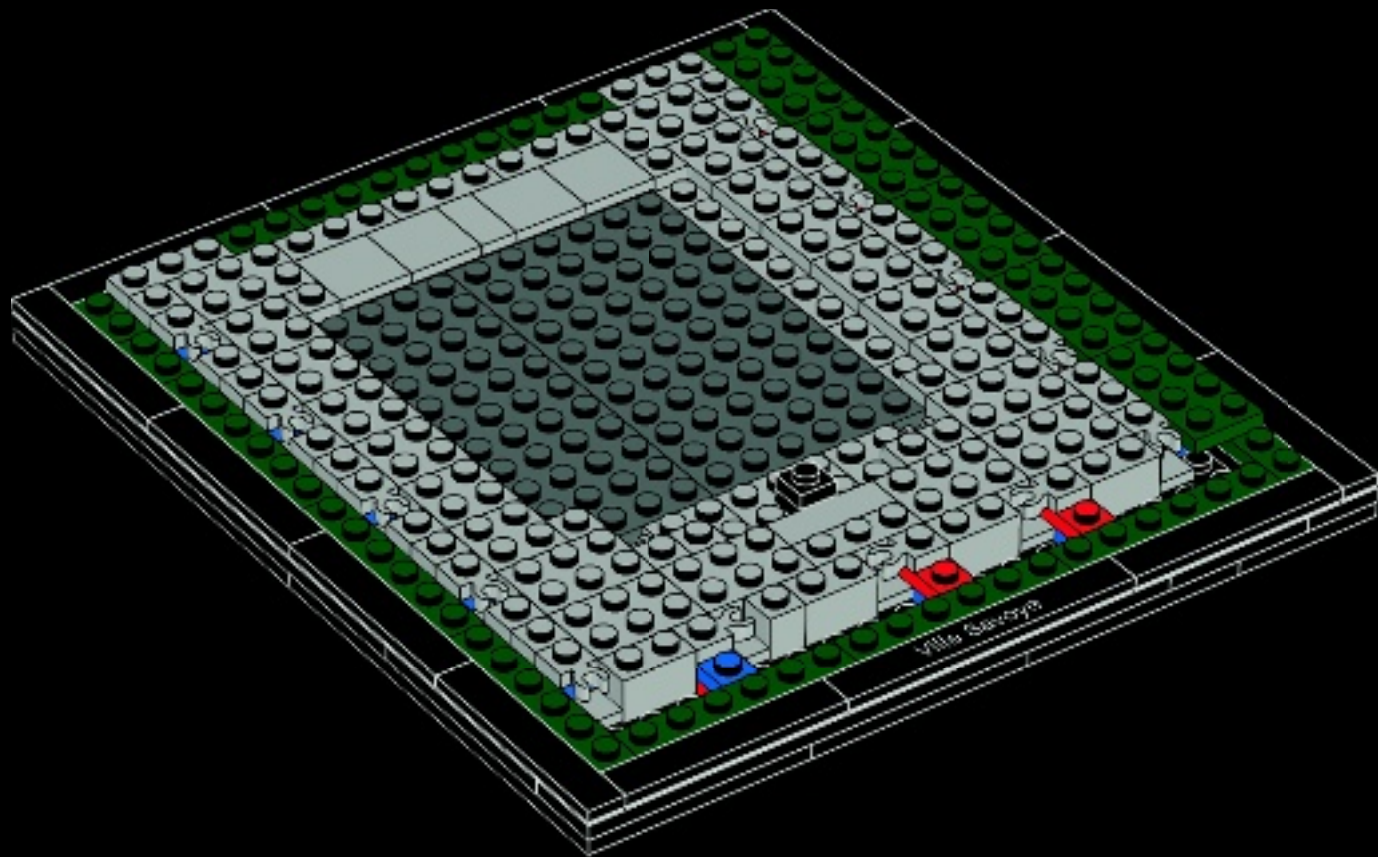

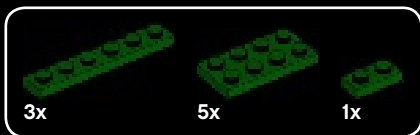

38

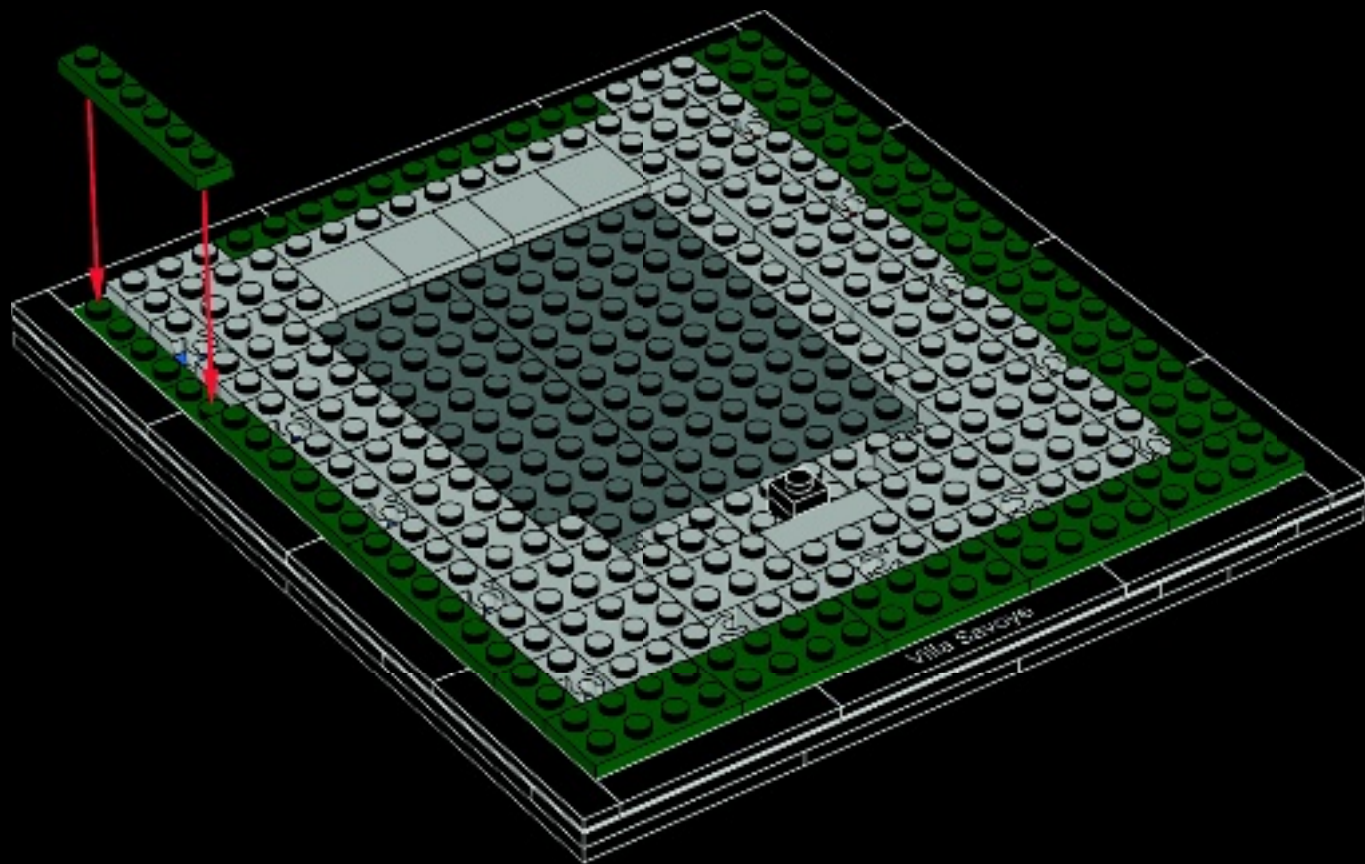



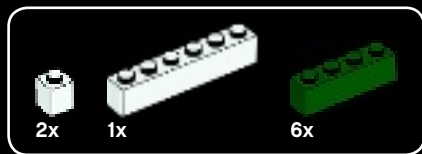

39

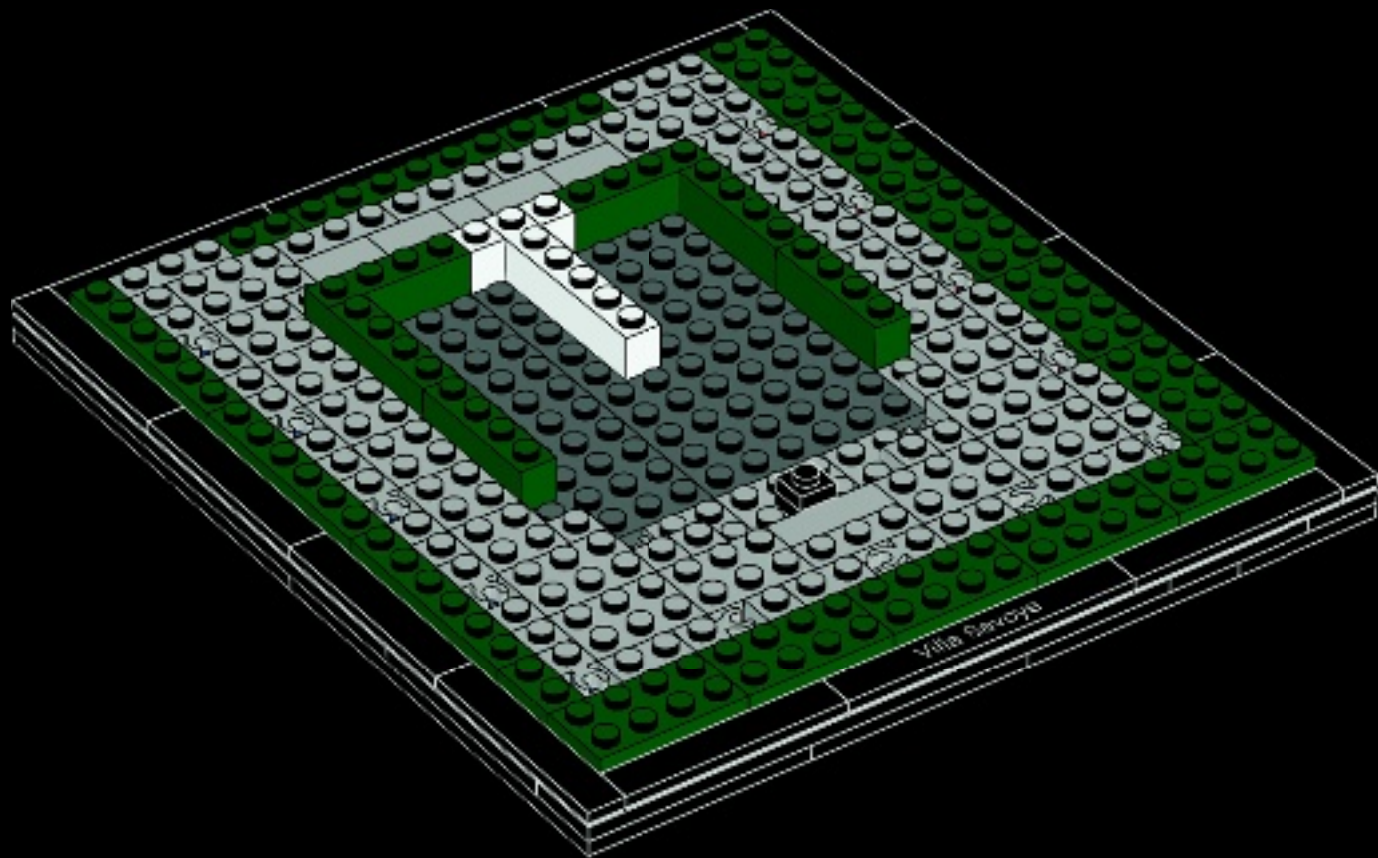





40

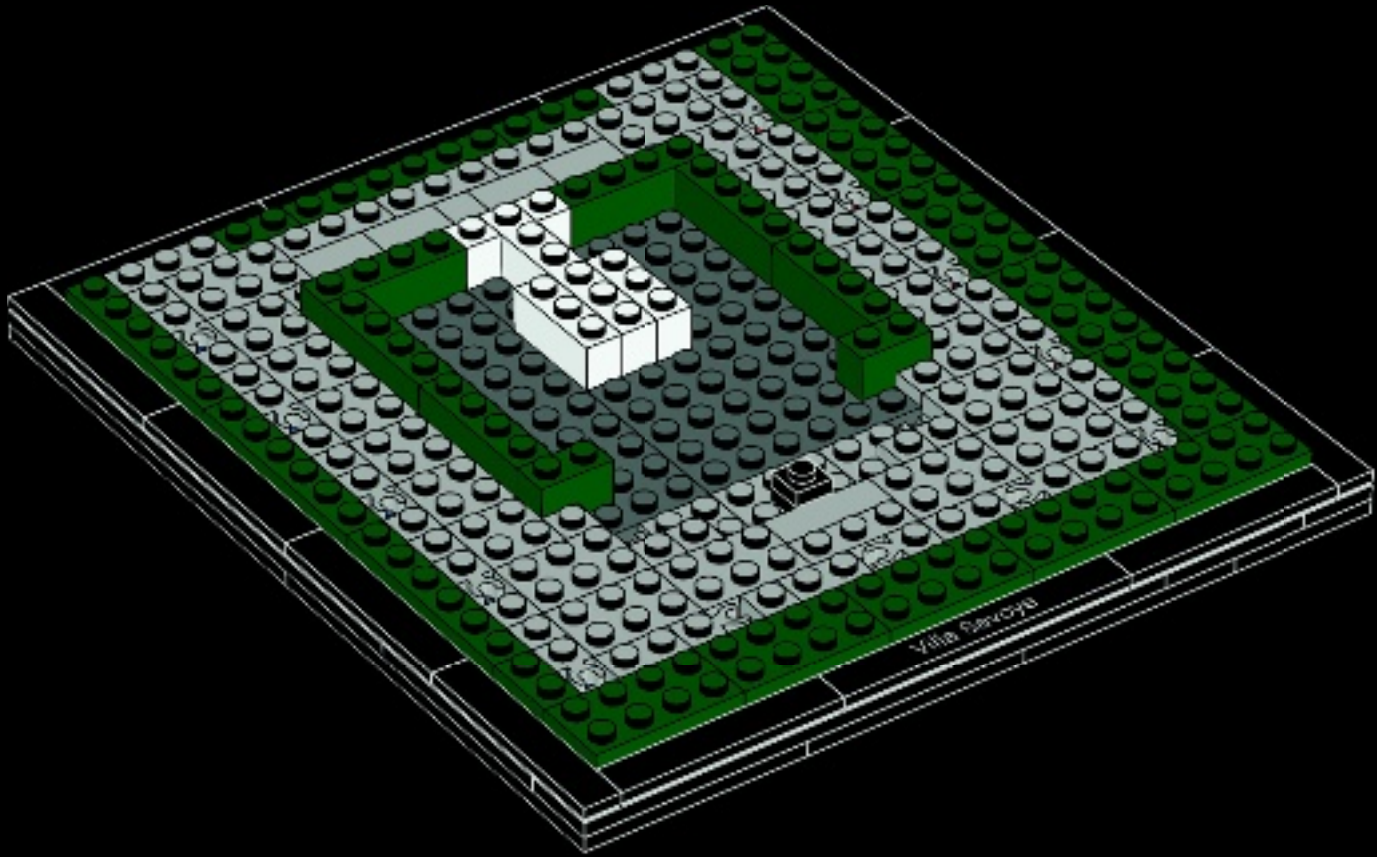



6x

# 41

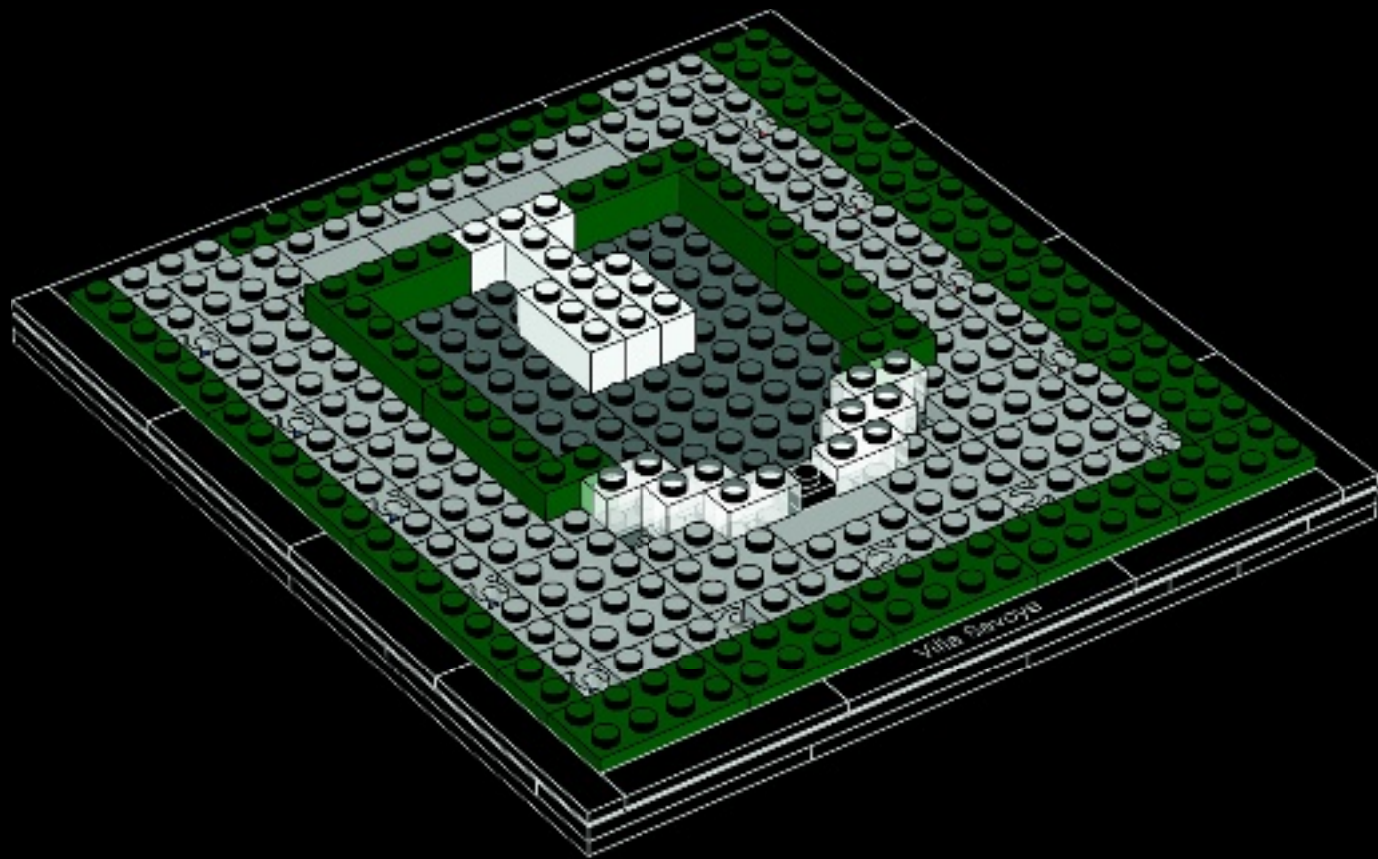

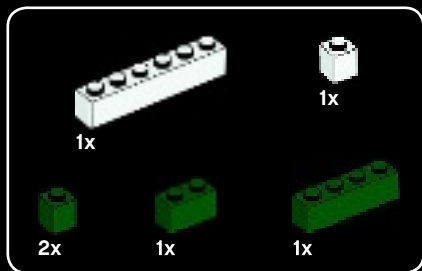

42

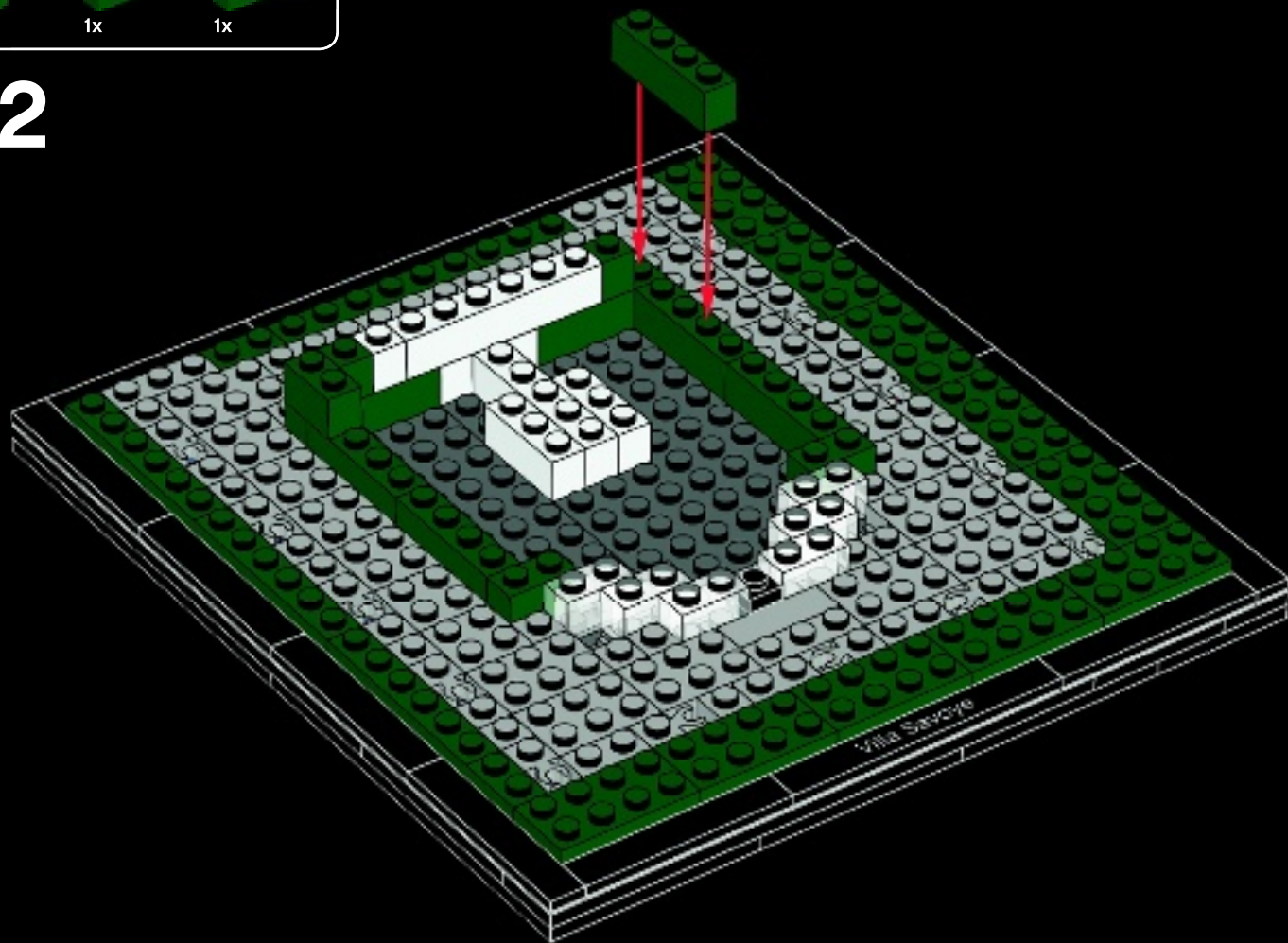



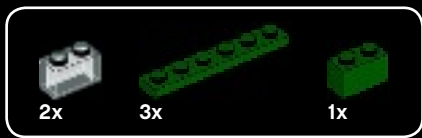

# 43

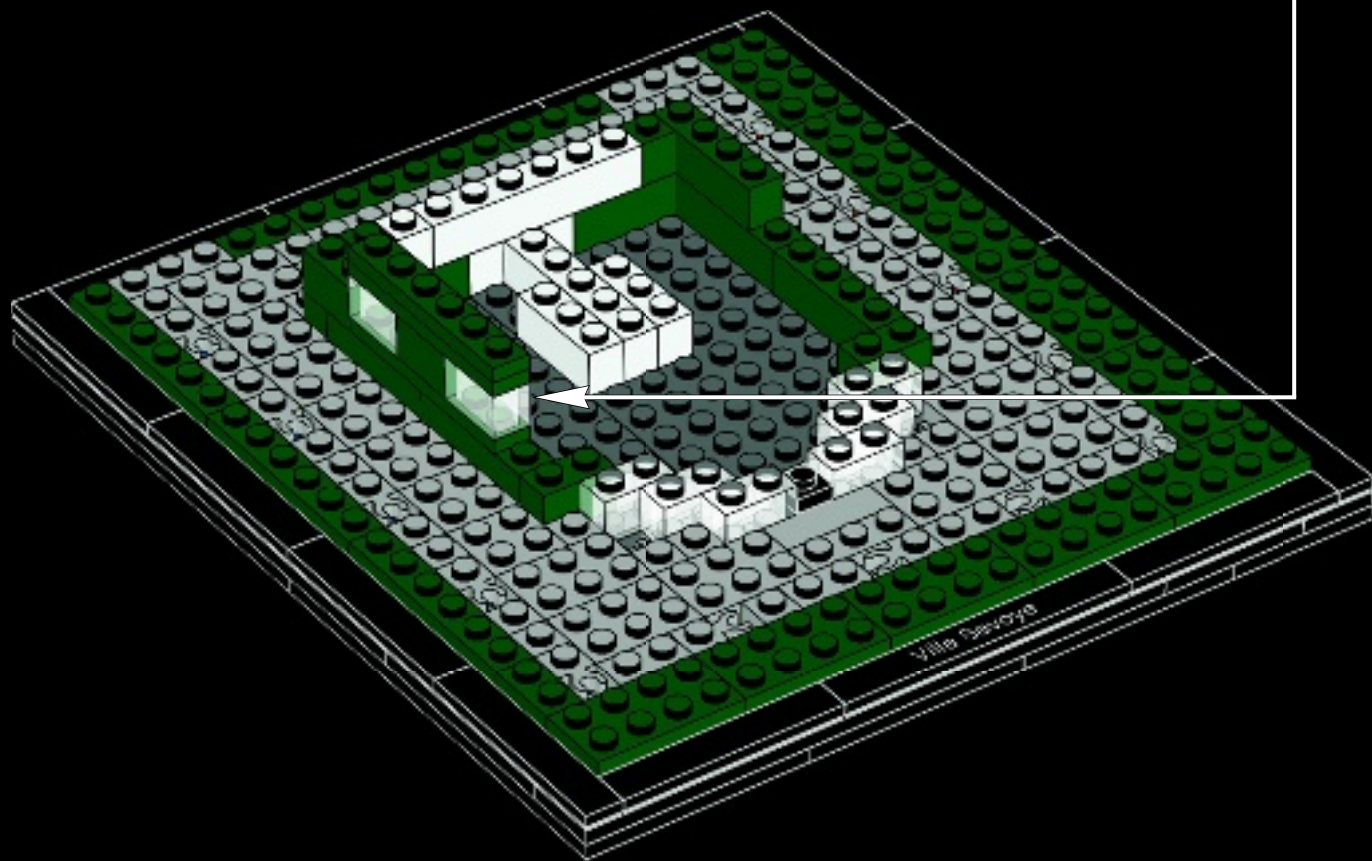
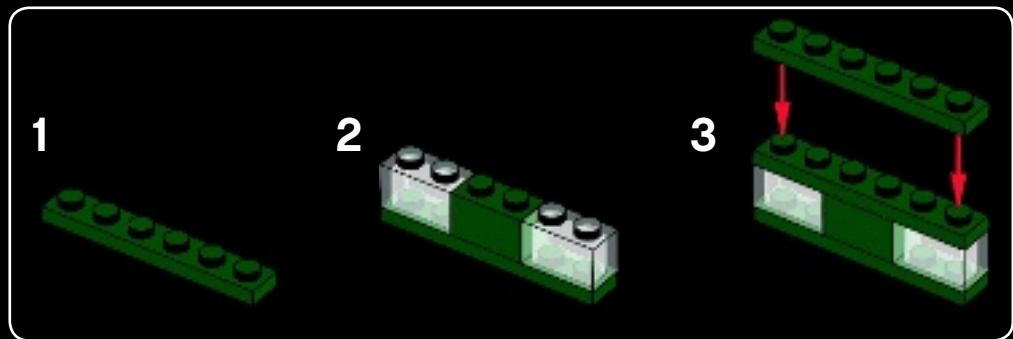



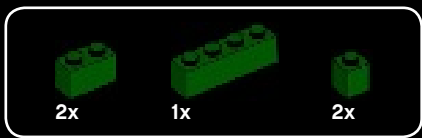

44

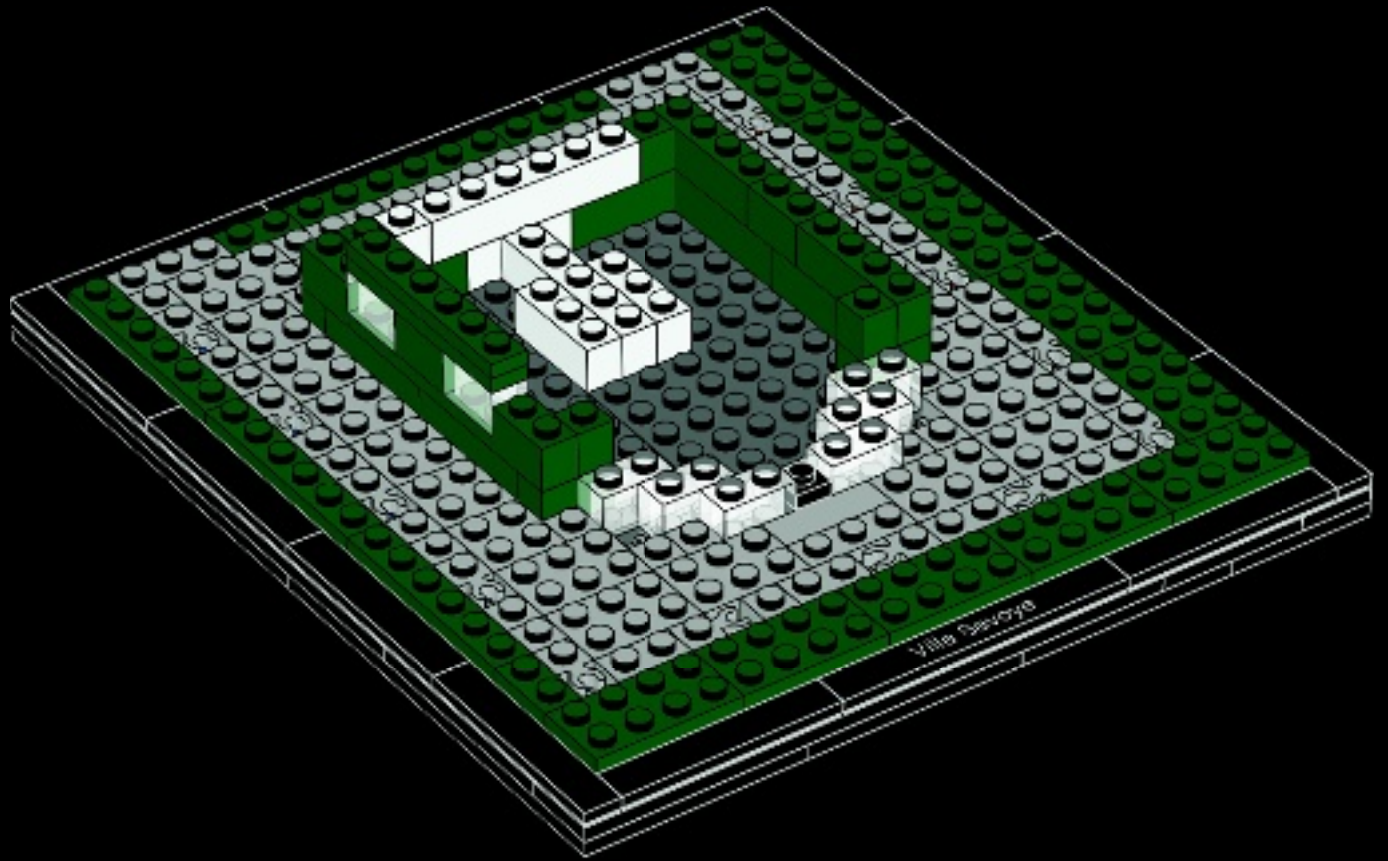



1x



6x



1x

# 45

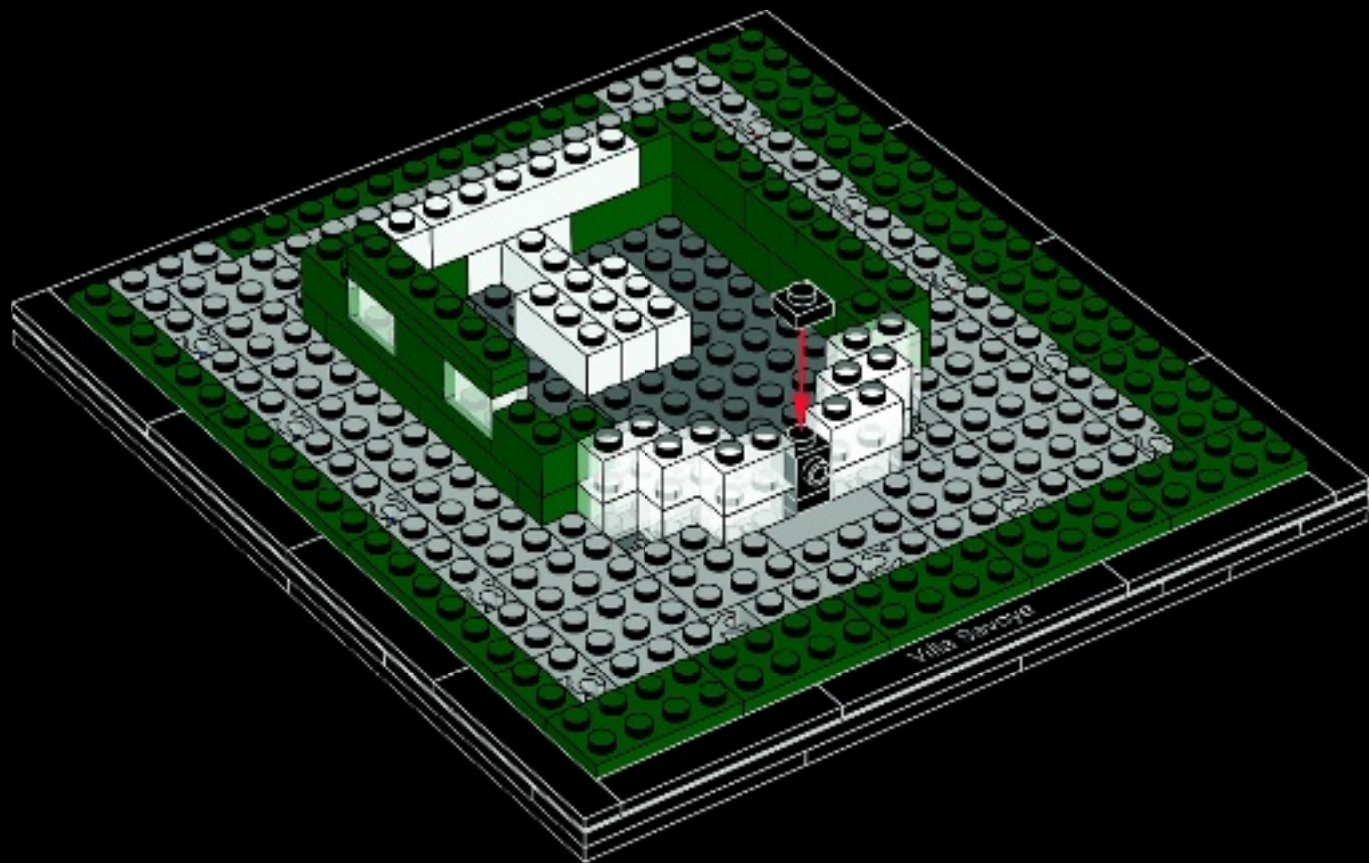



1x



1x

# 46

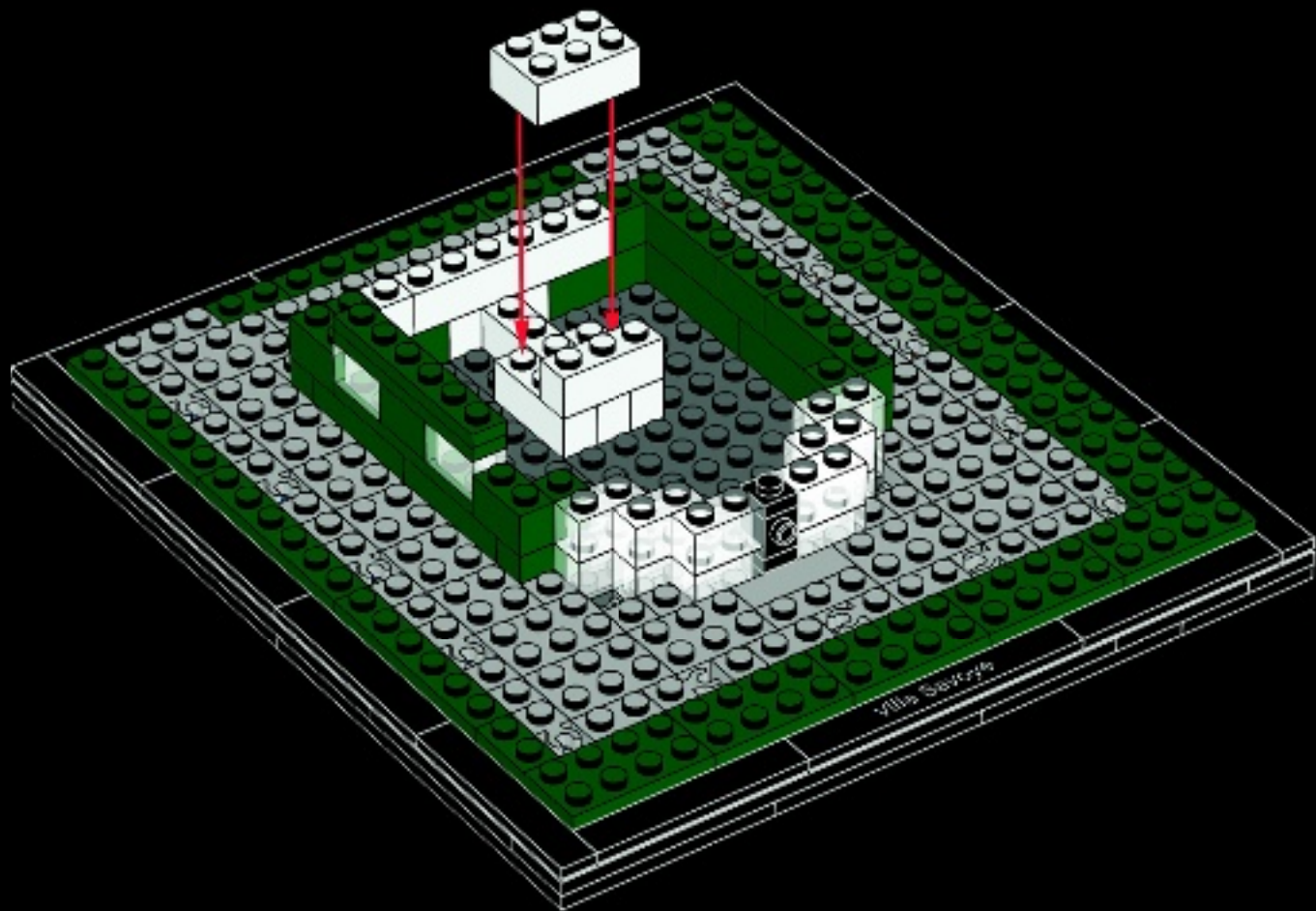

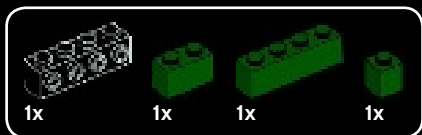

47

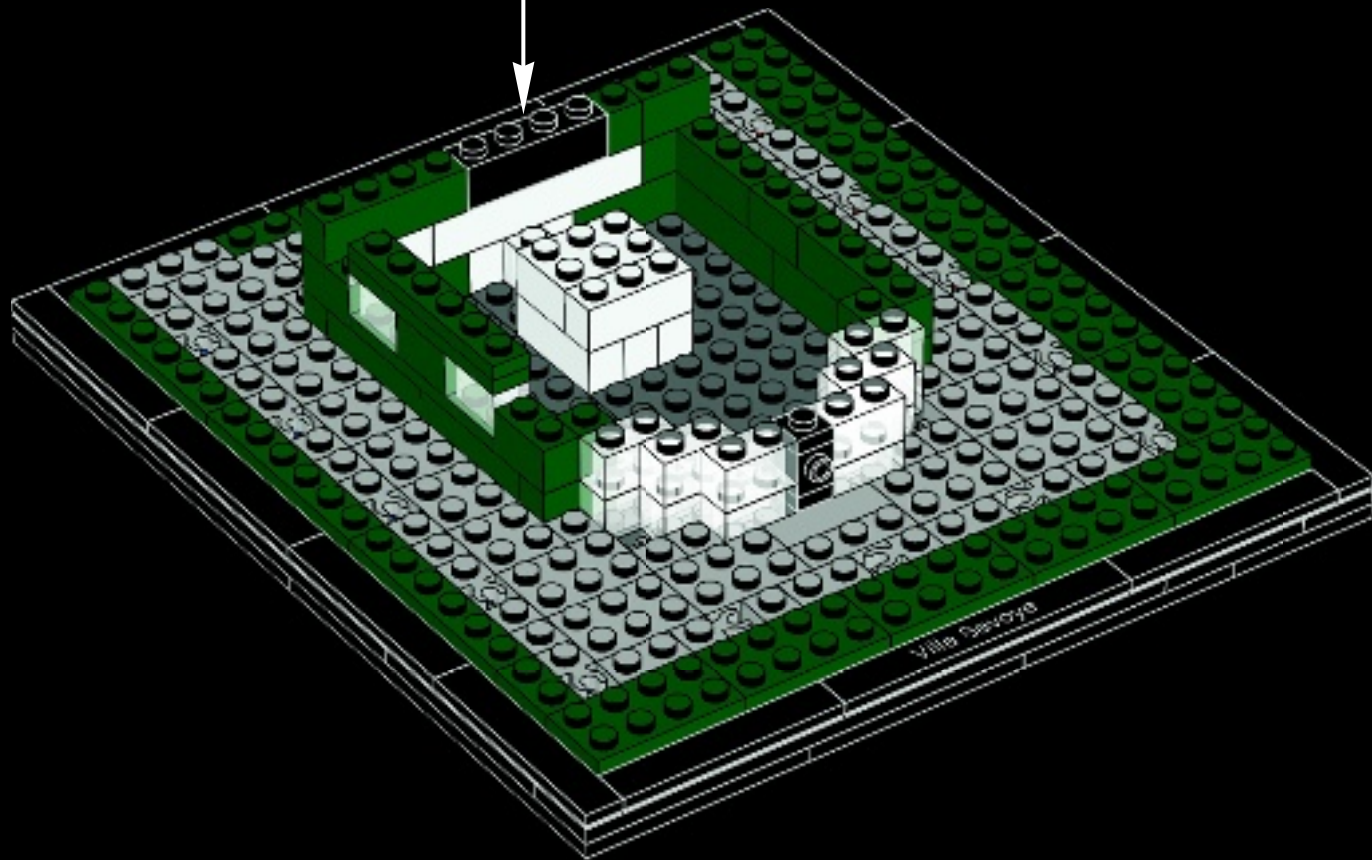
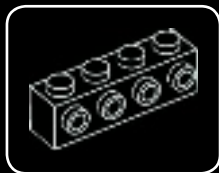





# 48

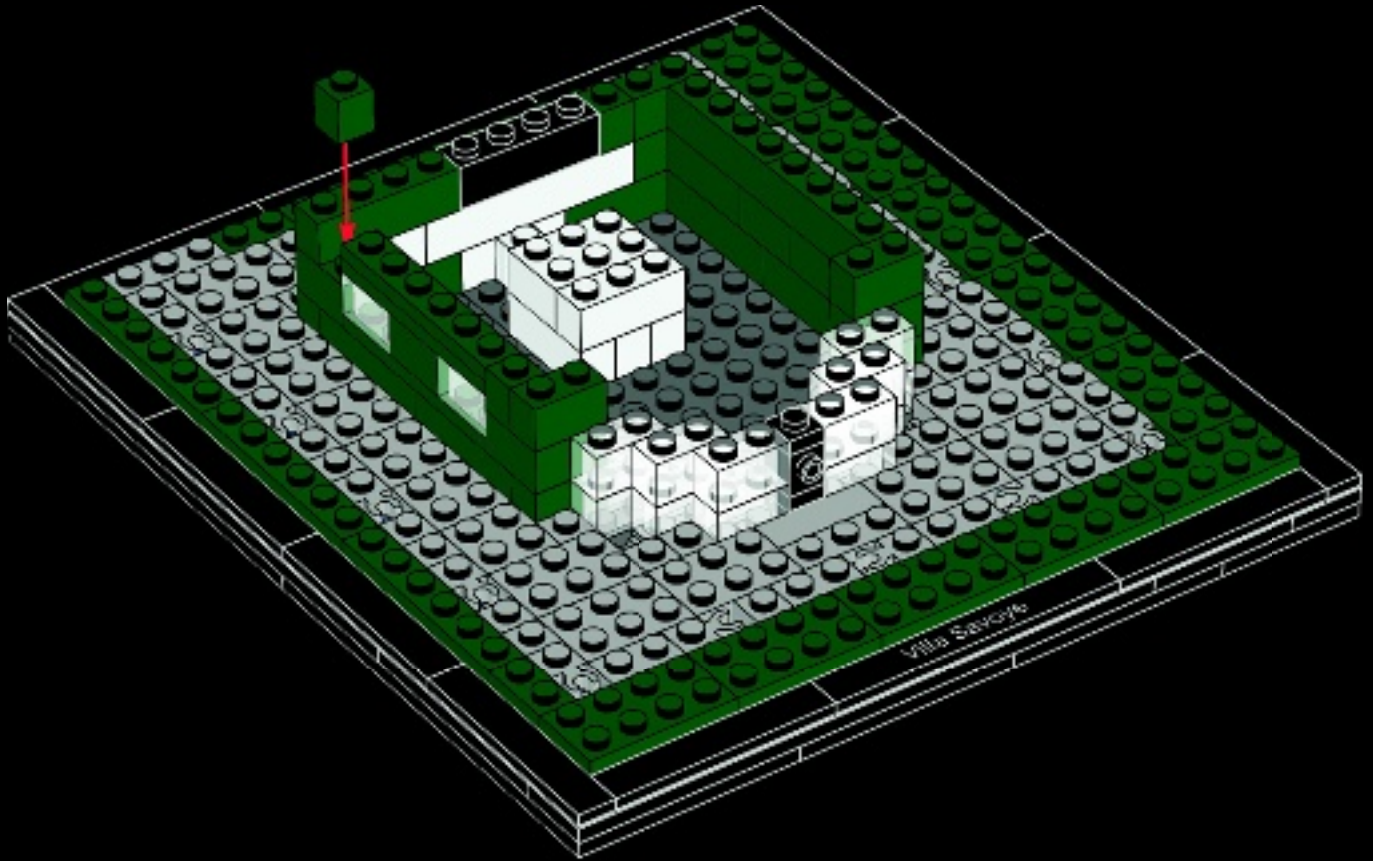



6x



1x

# 49

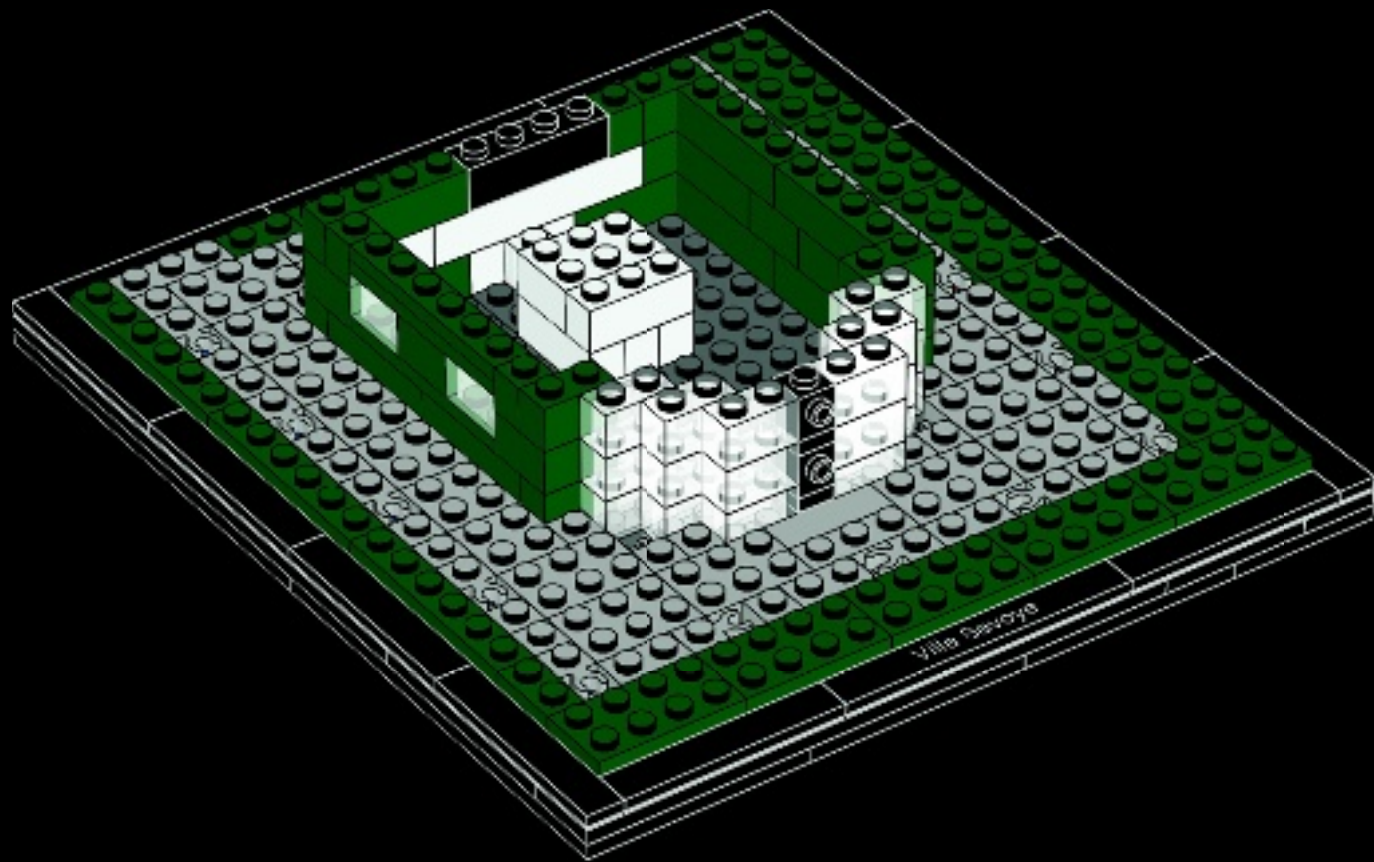



50

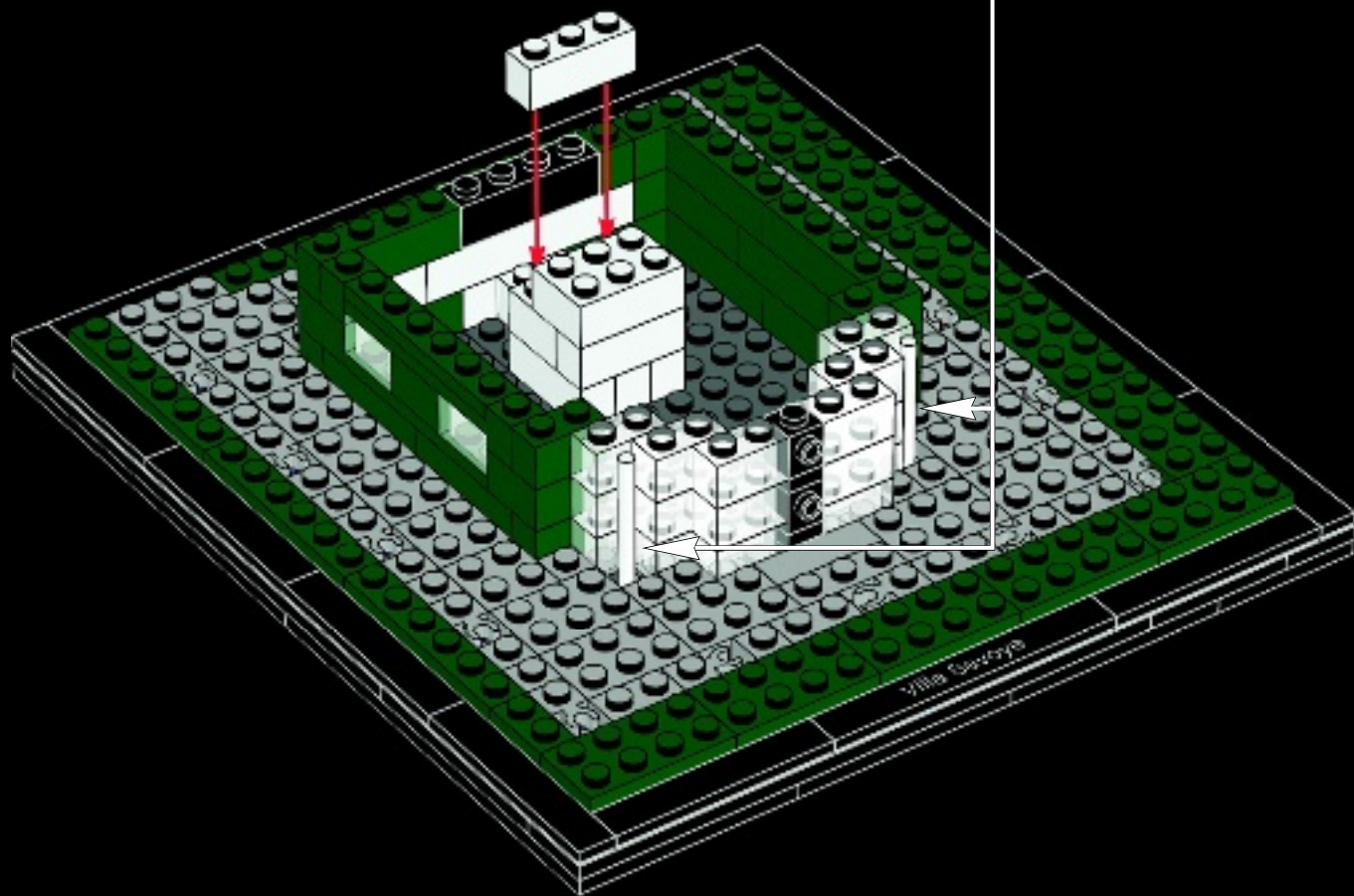
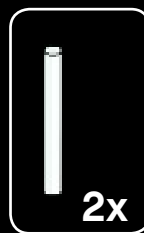

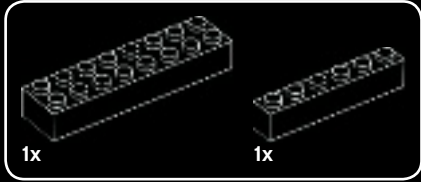

1

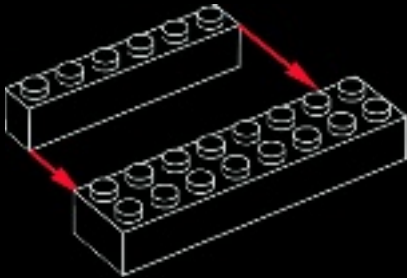

2

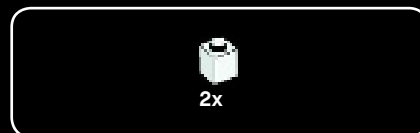
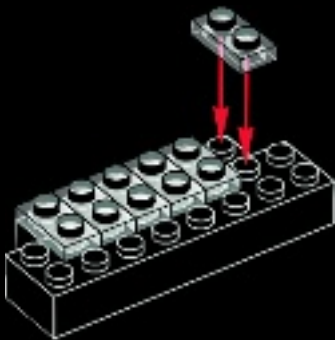

3

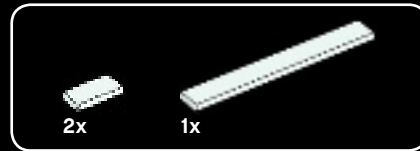
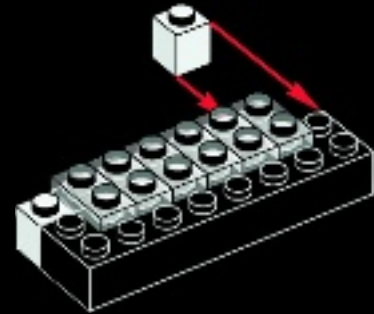

4

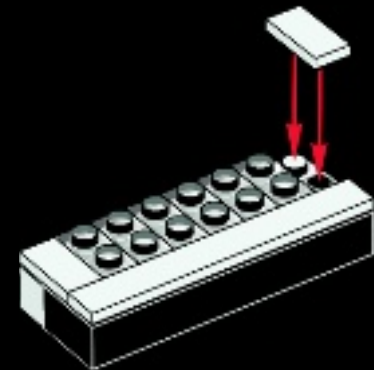



6x

5

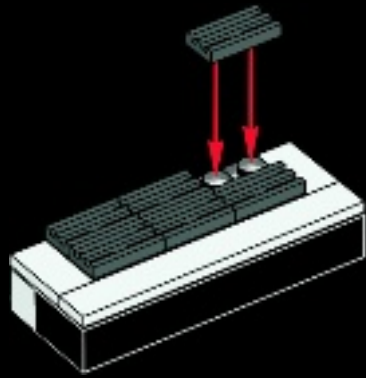

51

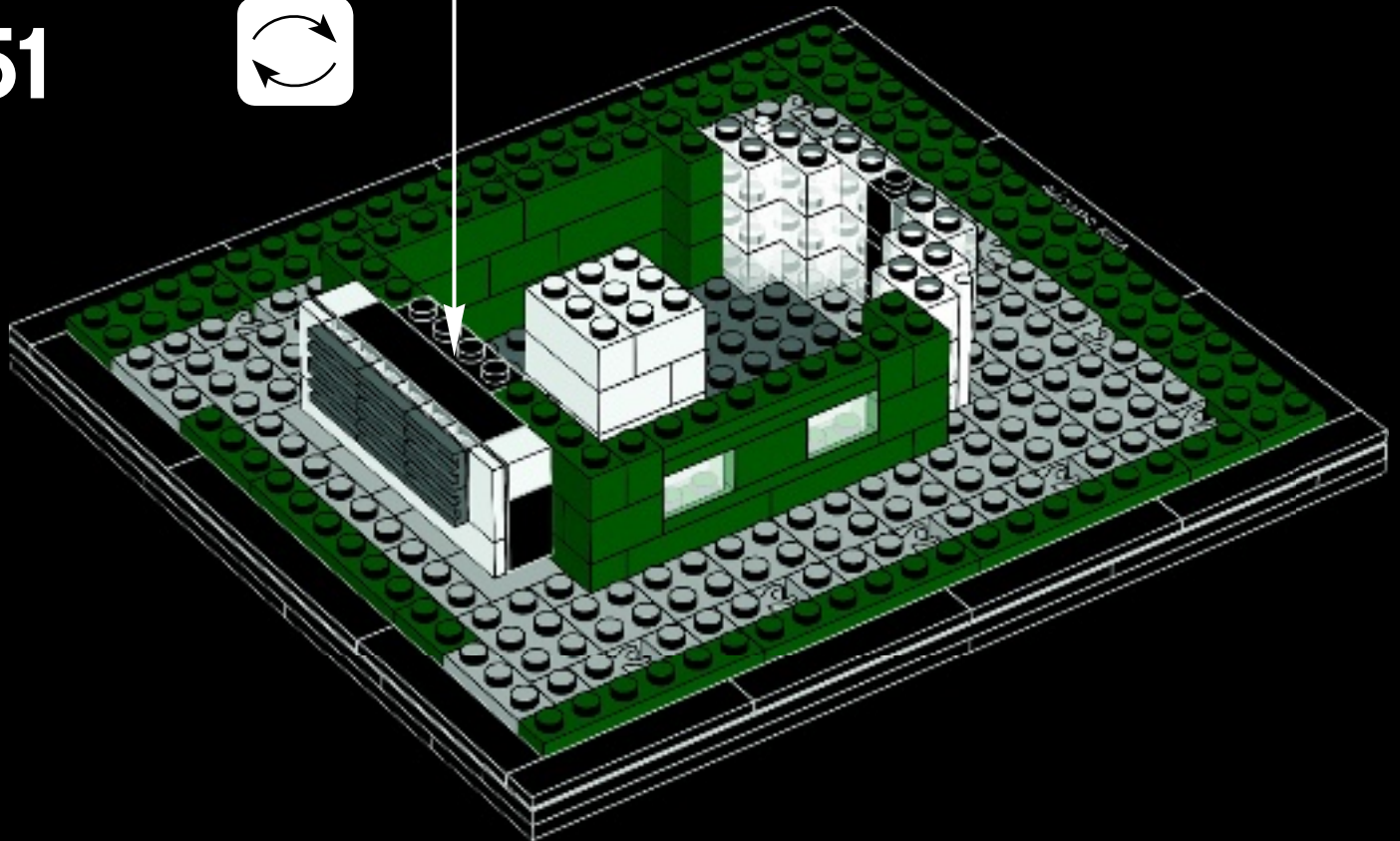



52

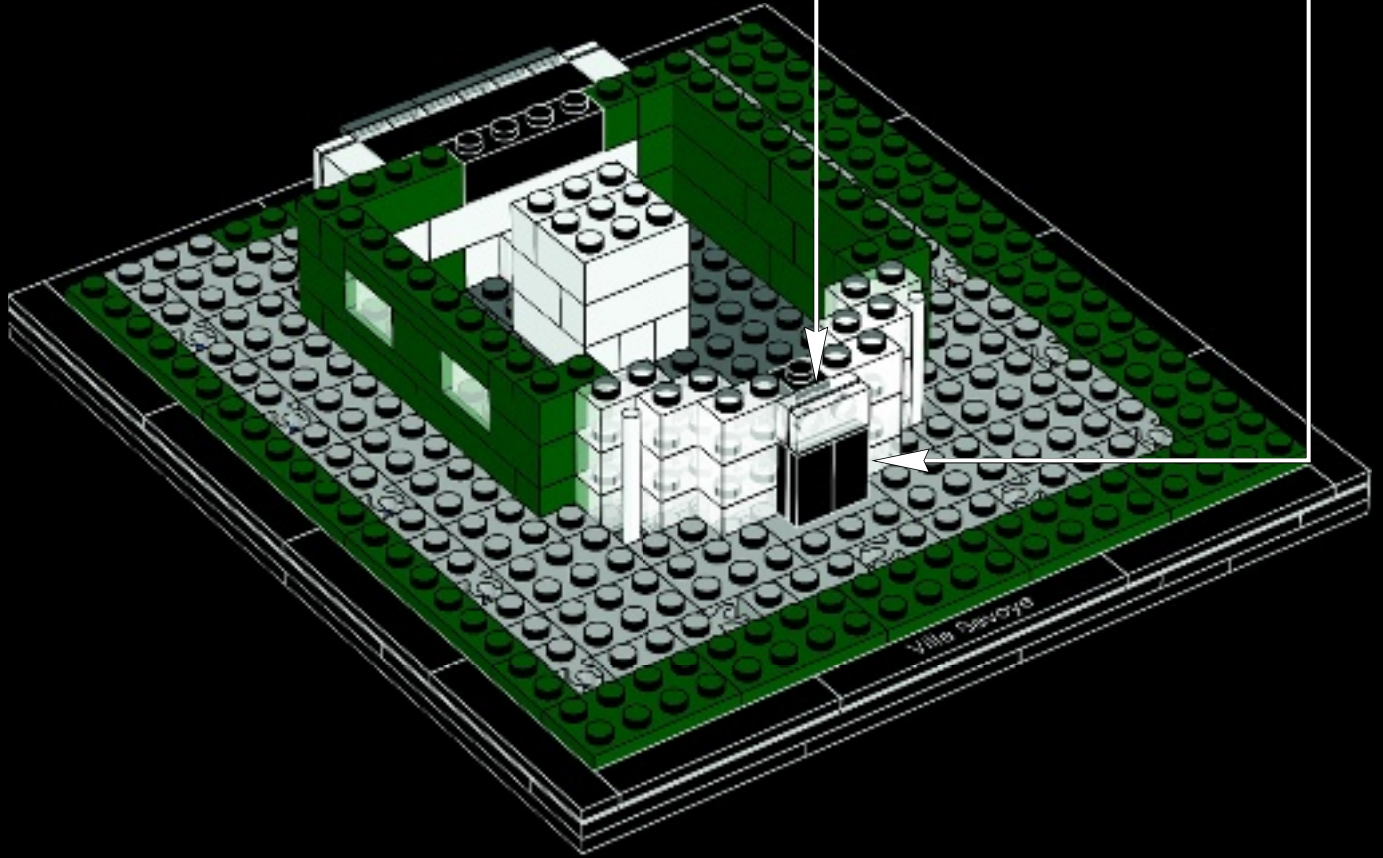
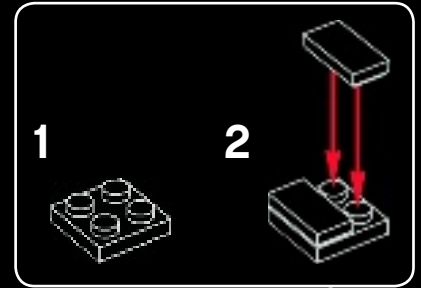
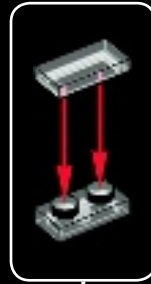



1x



1x



13x

# 53

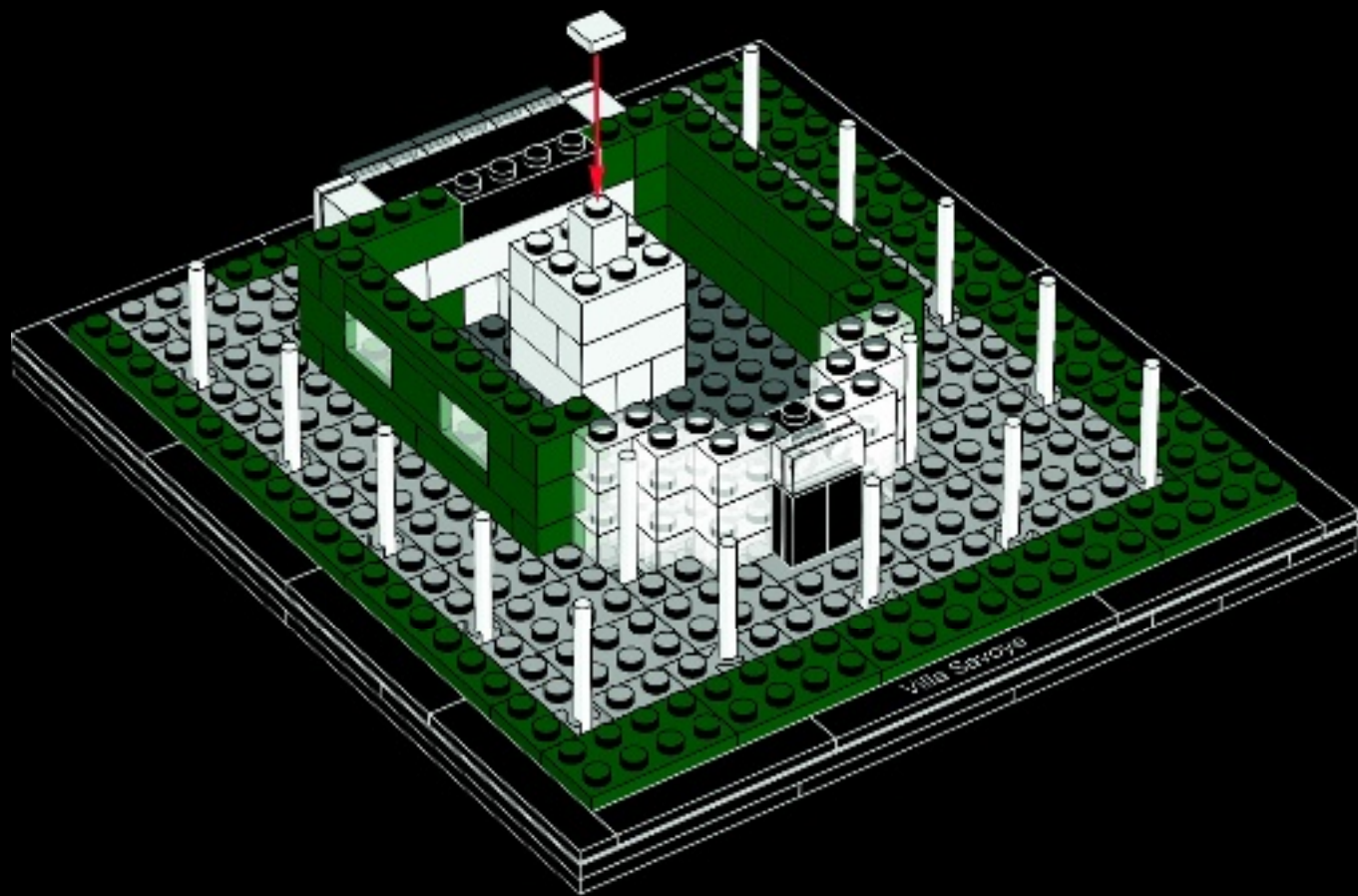

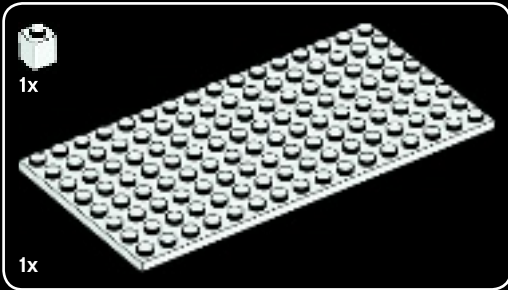
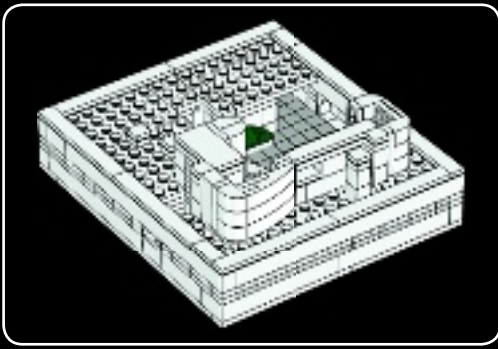

1

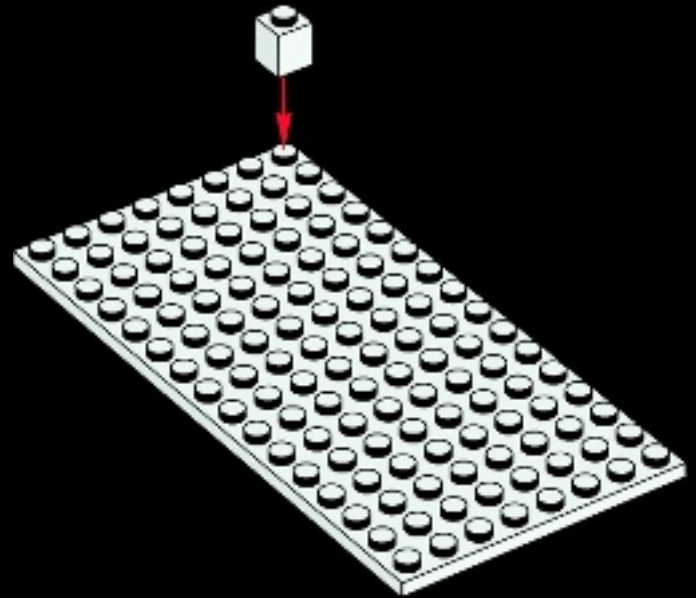

*Villa Savoye appears to be lifted into the air by 15 cylindrical pillars. Each has a radius of 30 cm (11.8 inches) and reaches 2.87 m (9.5 ft.) in height.*

*La Villa Savoye semble soulevée dans les airs par 15 colonnes cylindriques. Elles ont chacune un rayon de 30 cm et une hauteur de 2,87 m.*



© Fondation Le Corbusier





2

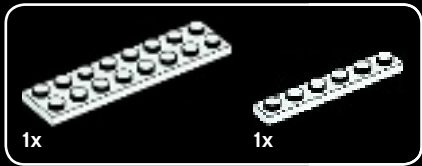
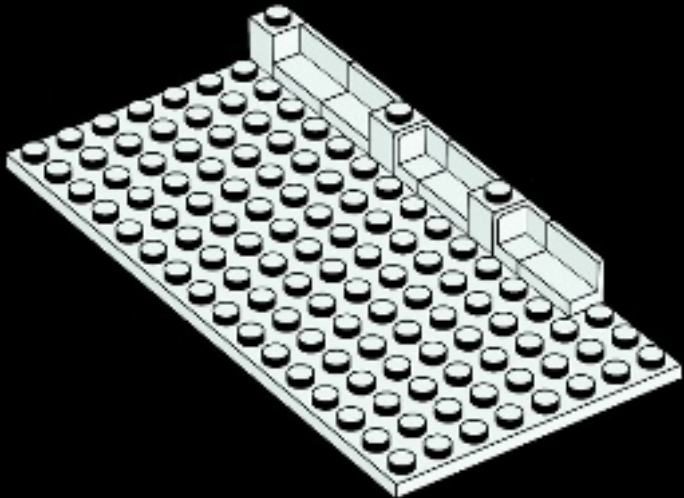

3

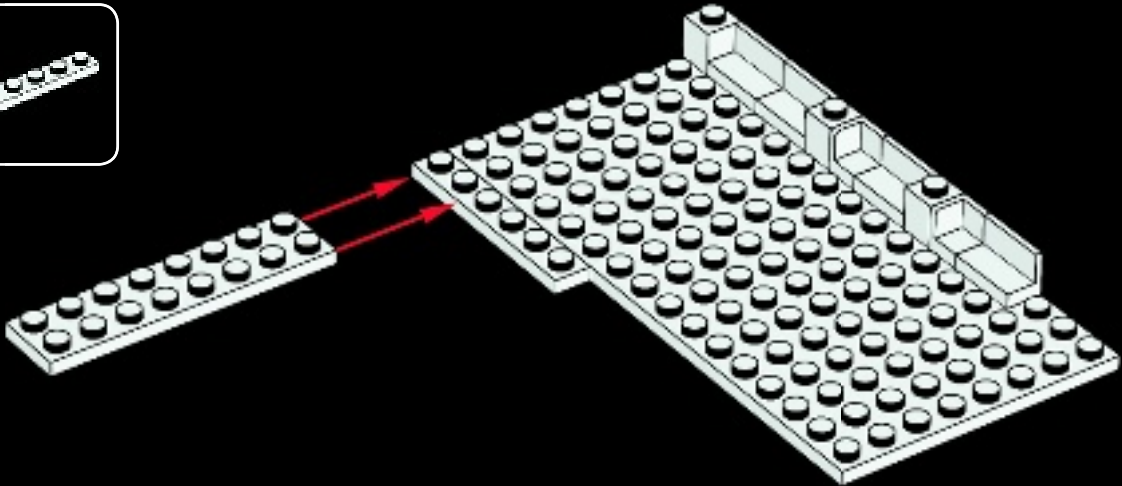

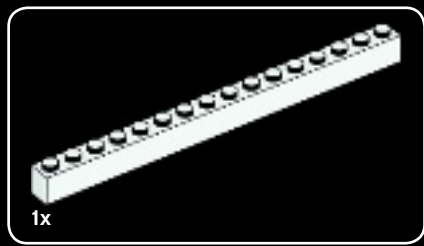

4

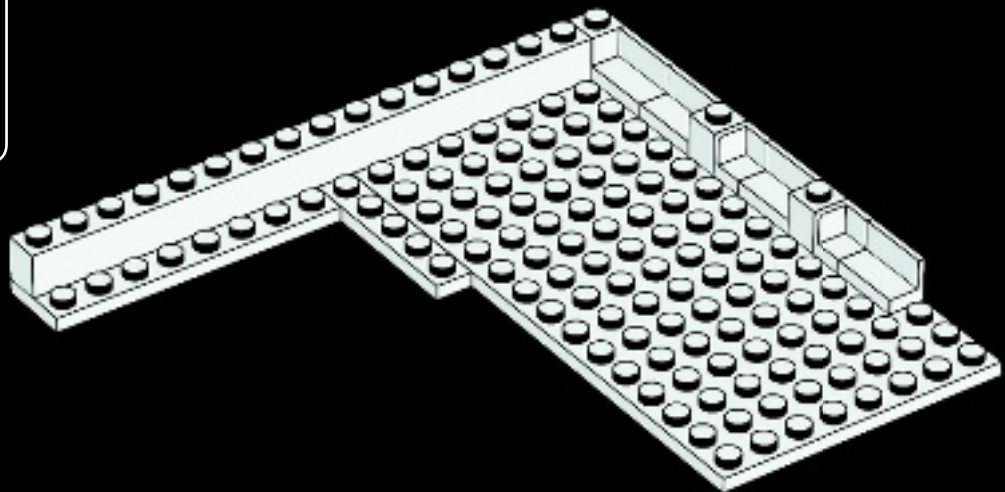

5

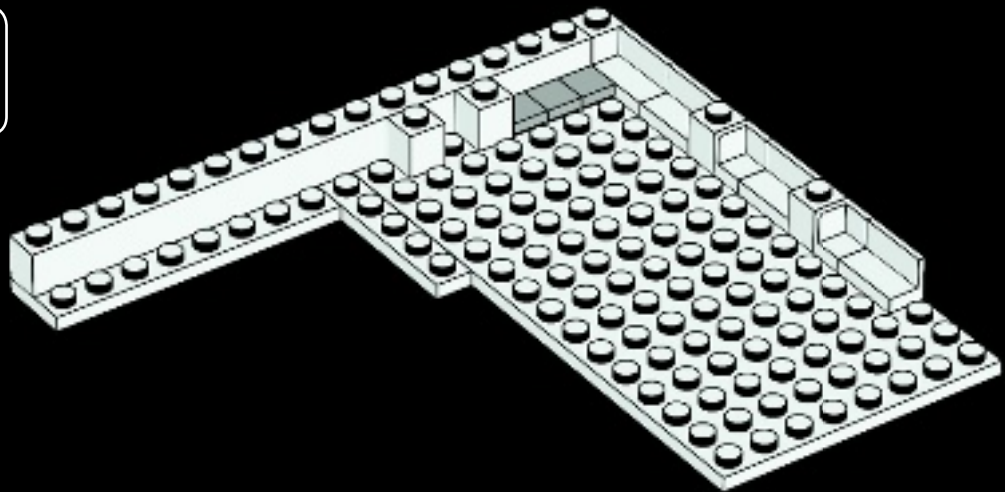



12x

6

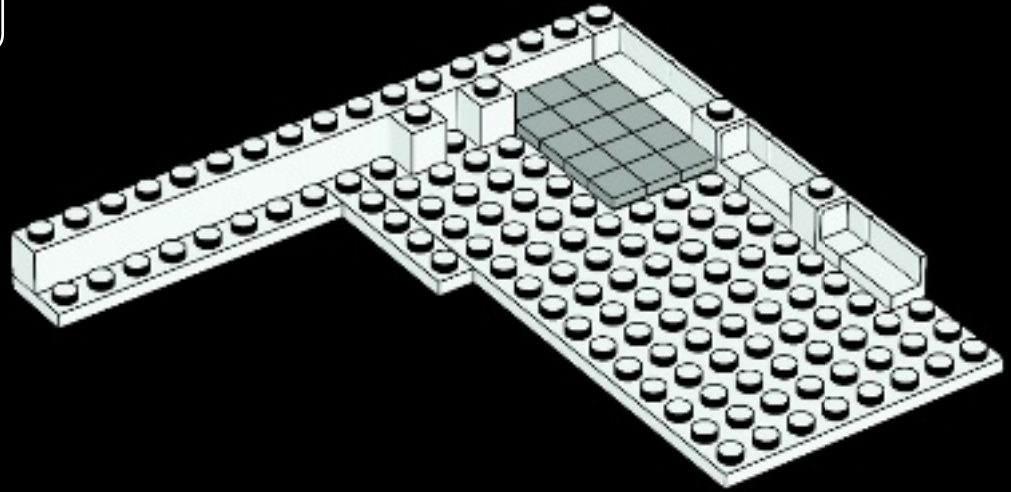

2x



1x



1x

7

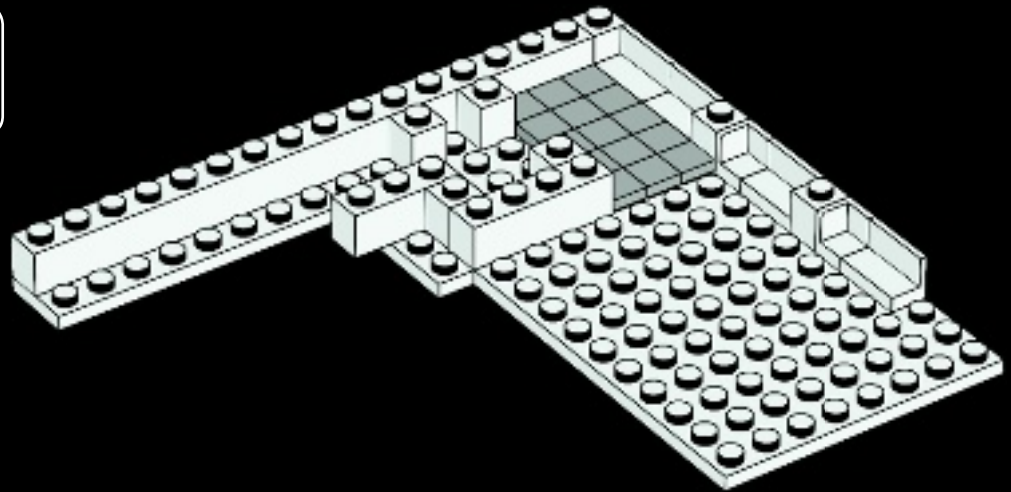



1x



19x

8

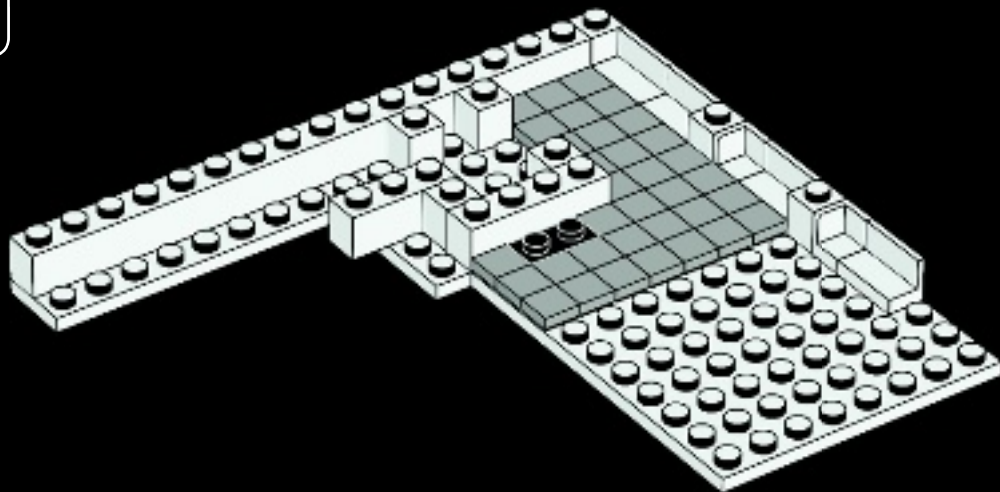

1x



24x



1x

9

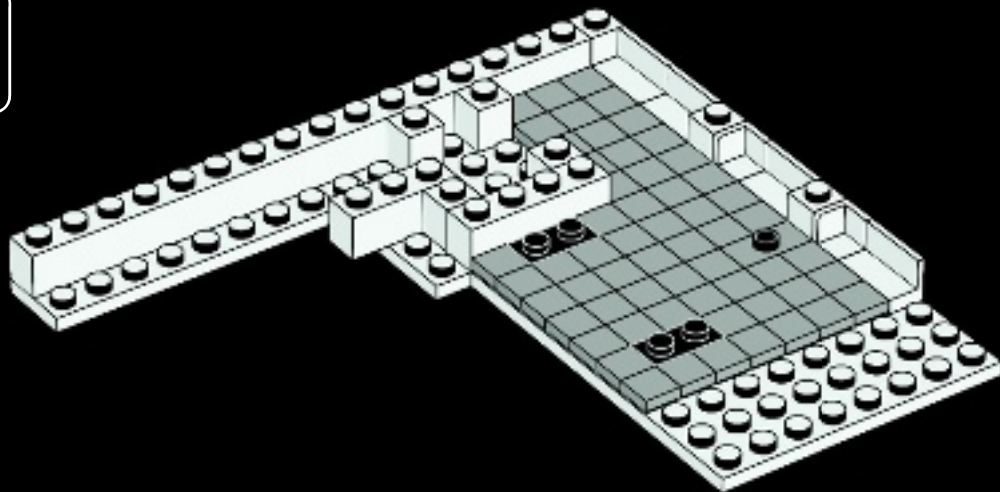



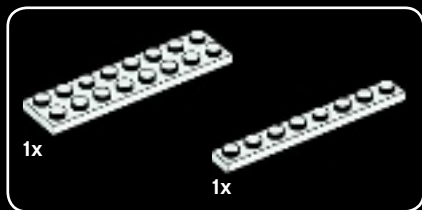

10

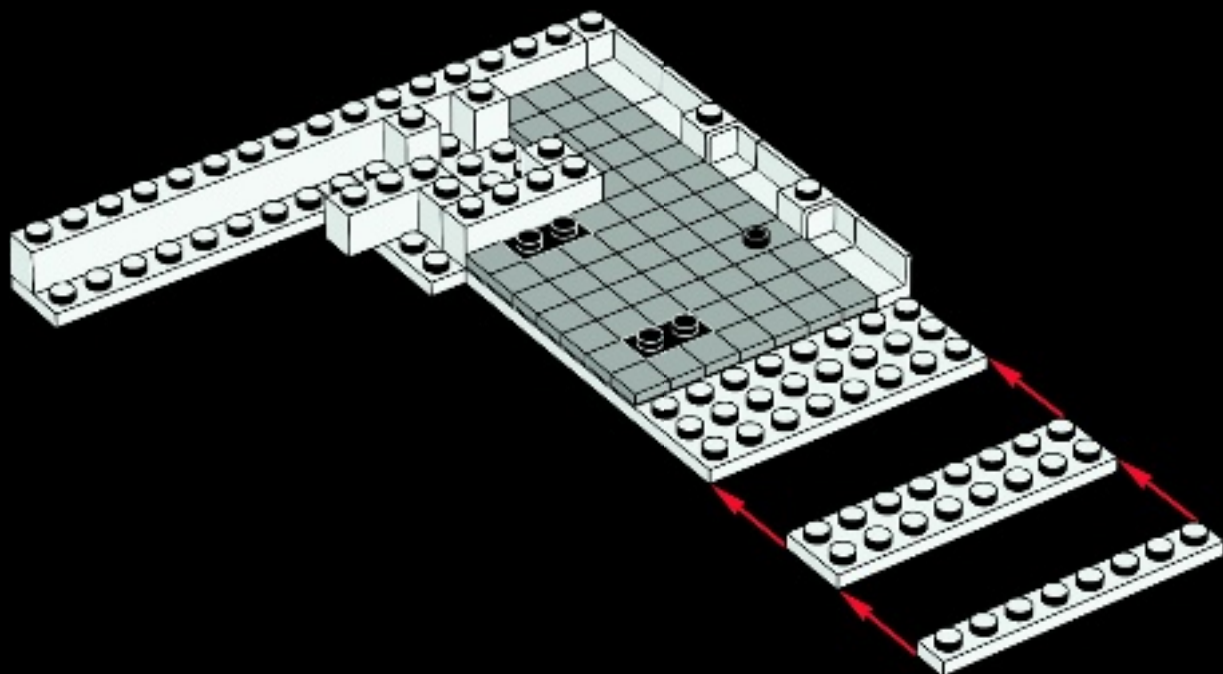

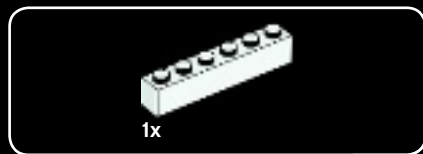

11

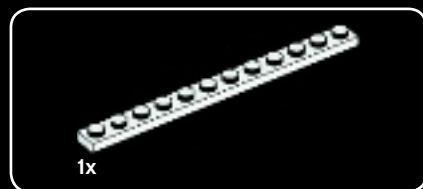
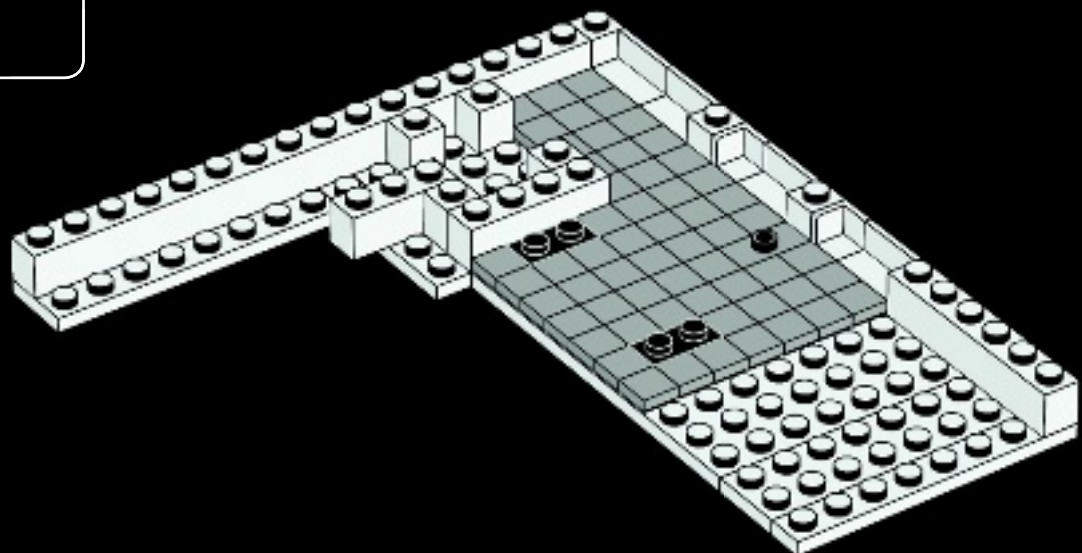

12

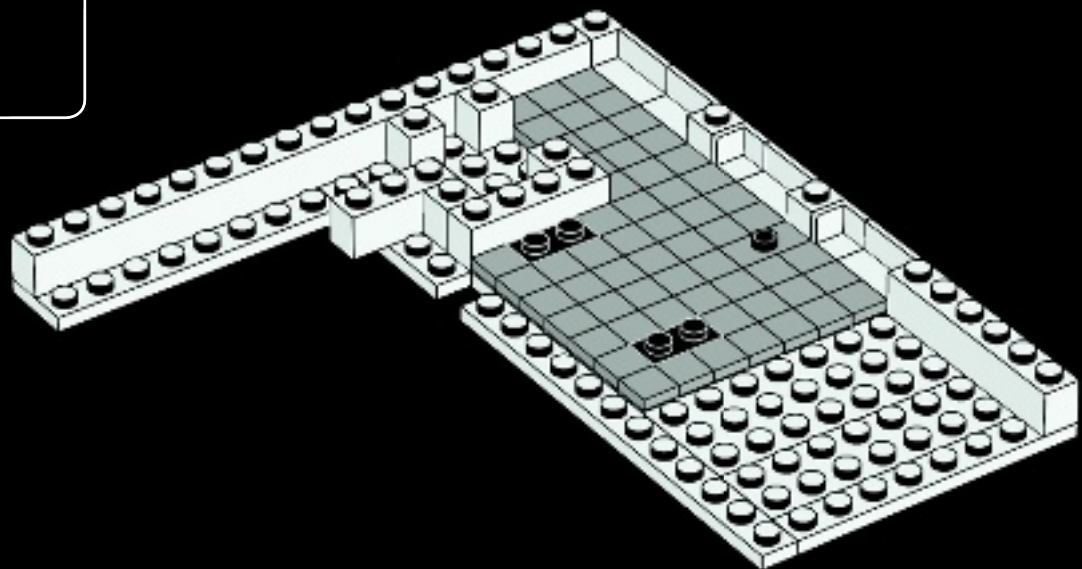

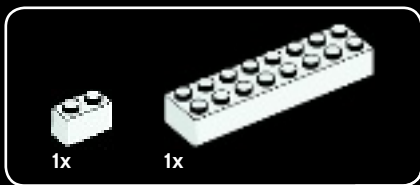

13

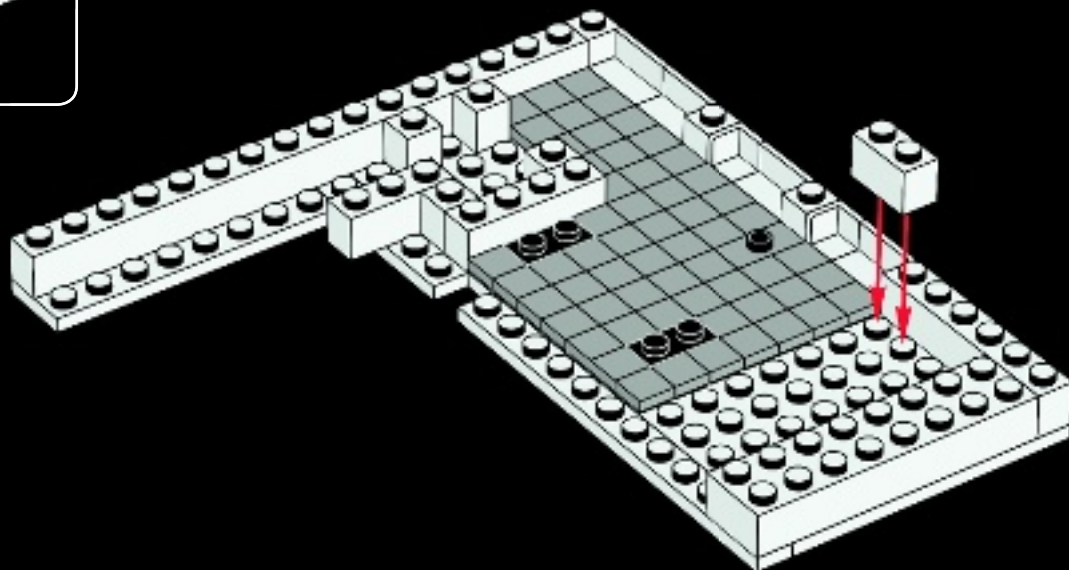

14

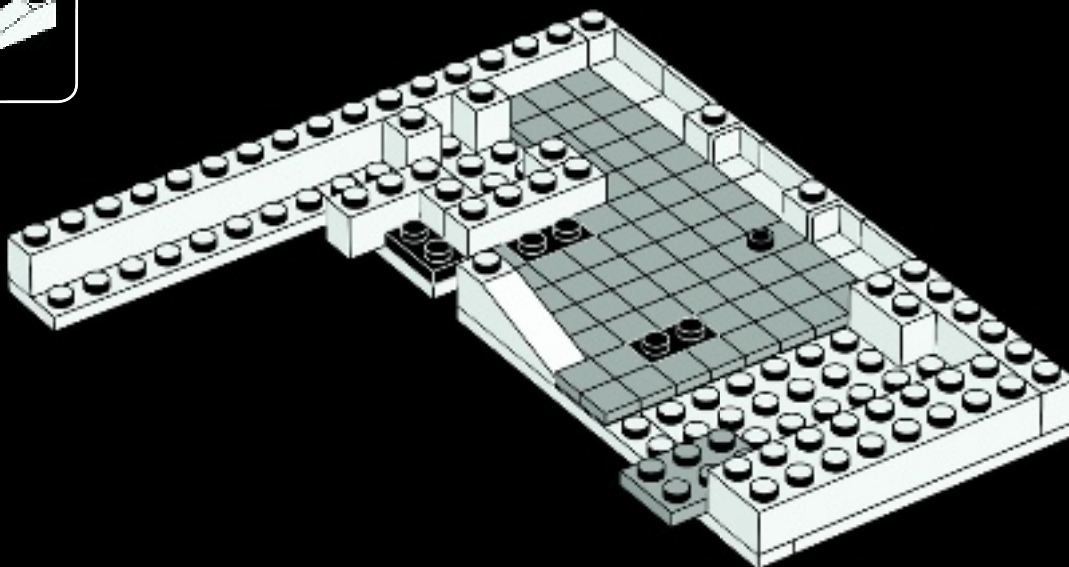

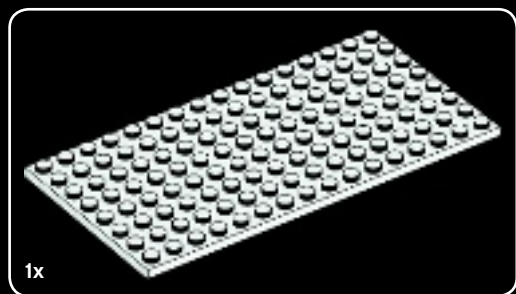

15

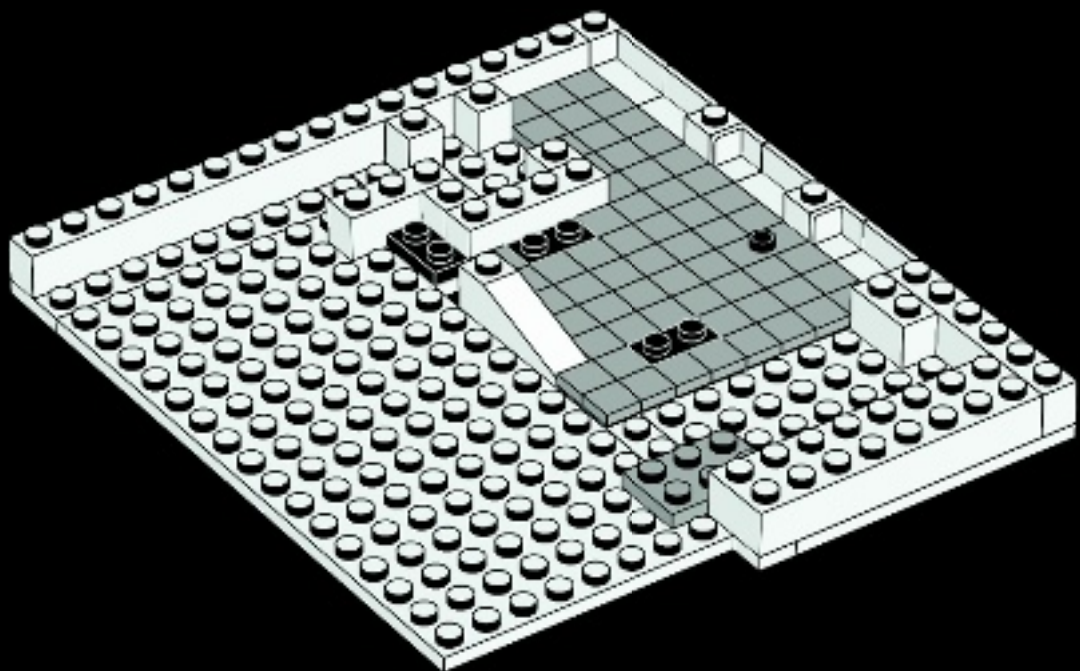





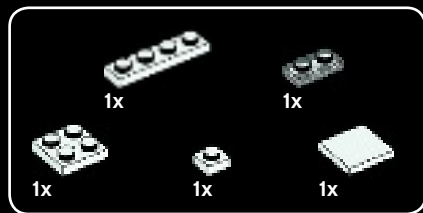

17

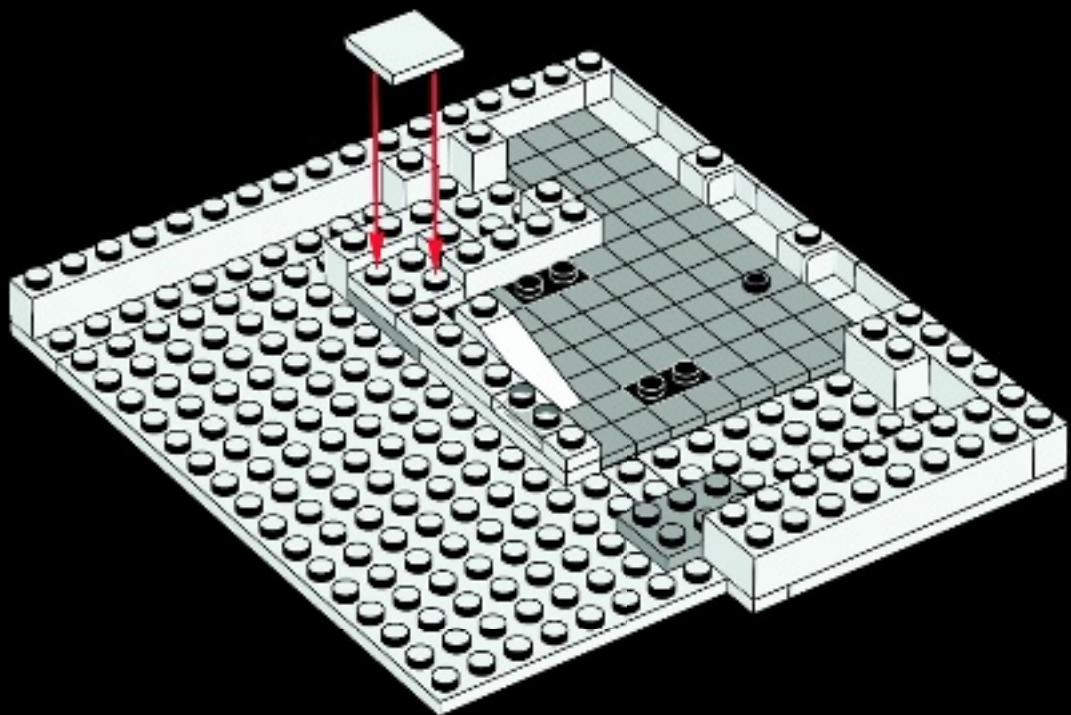



18

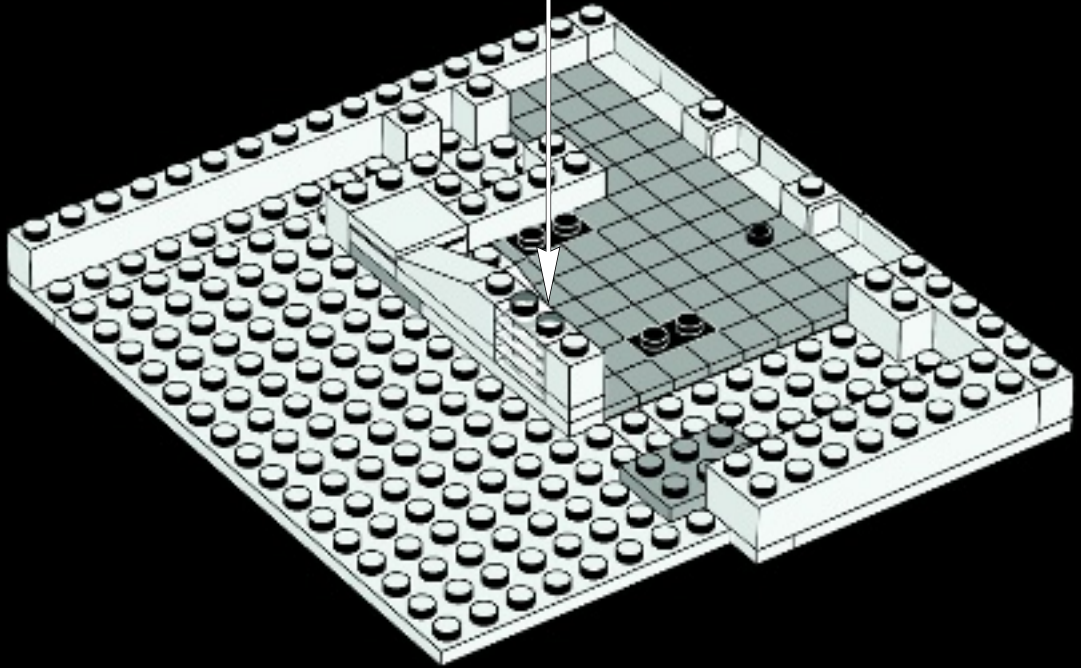
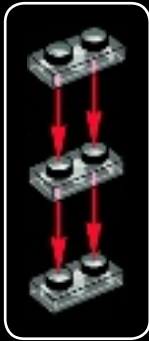



19

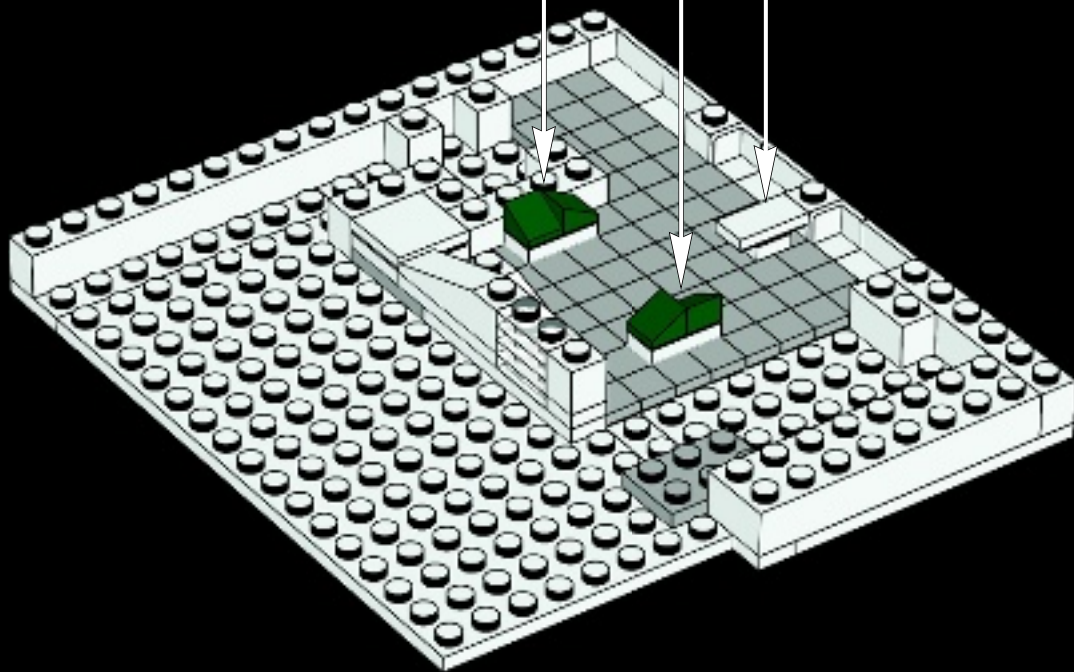
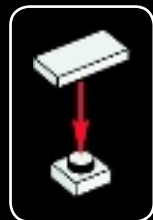
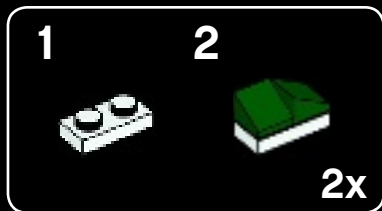





20

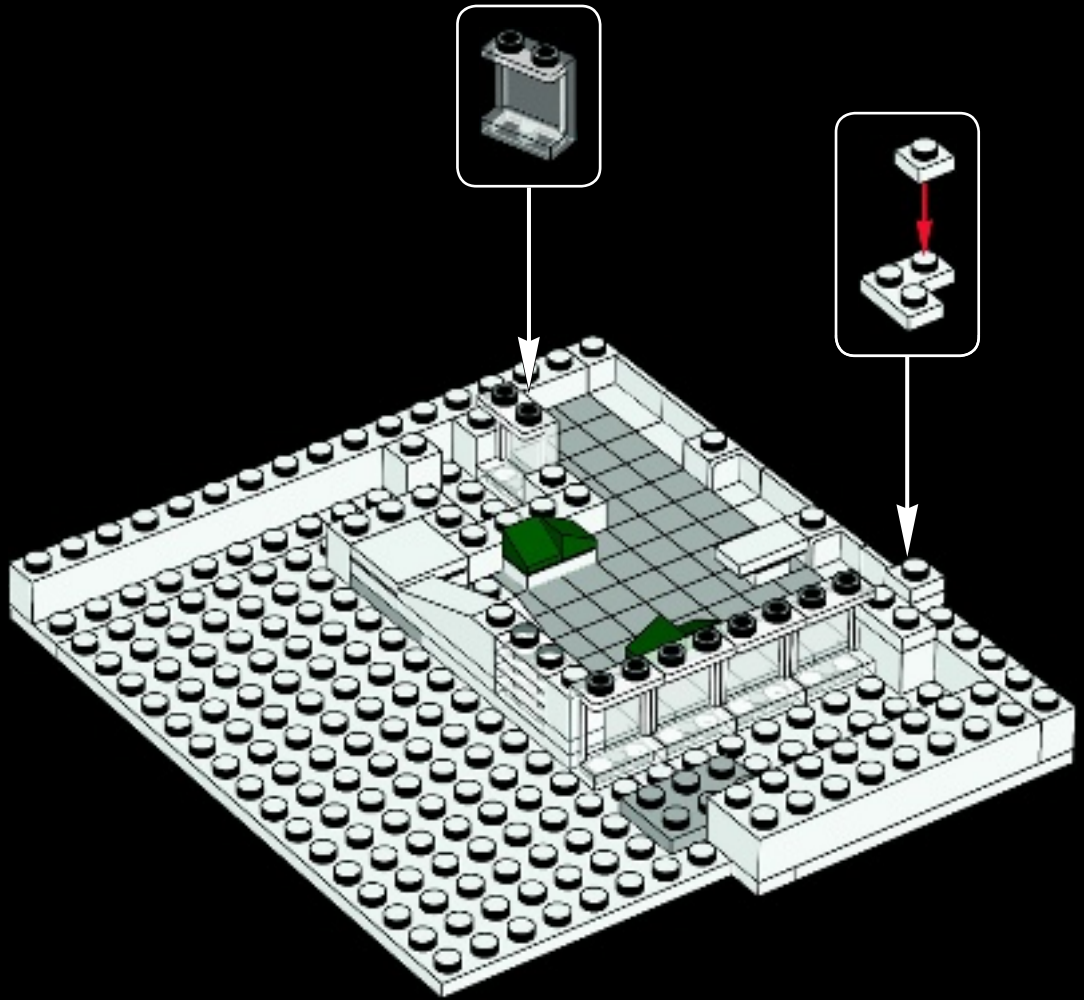

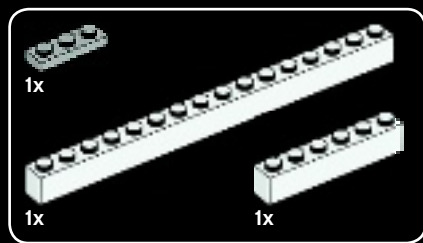

21

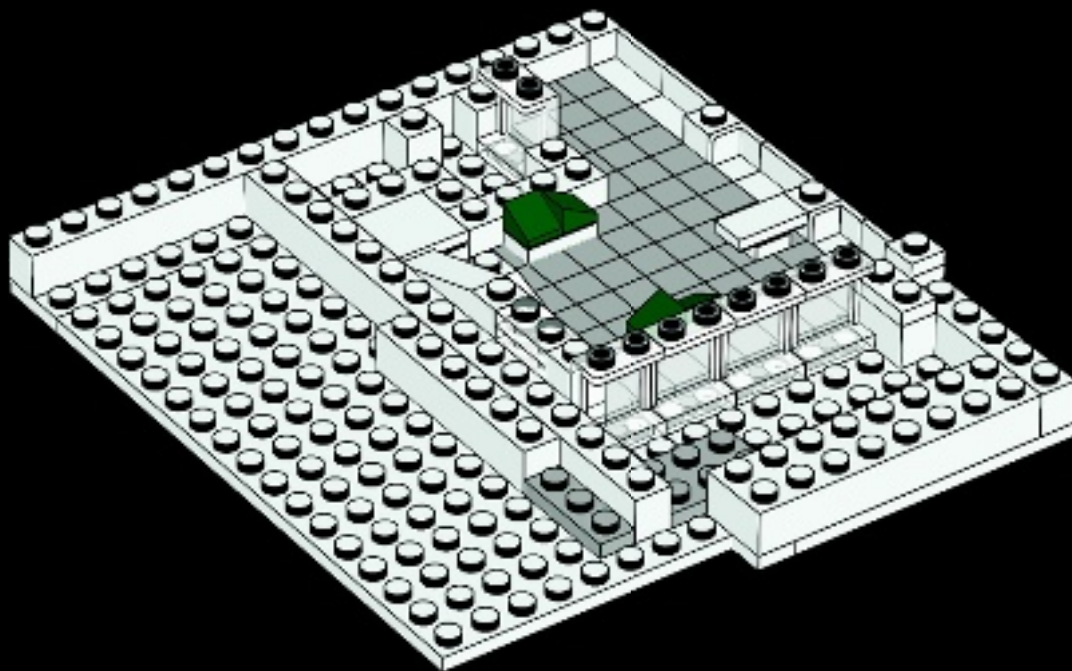

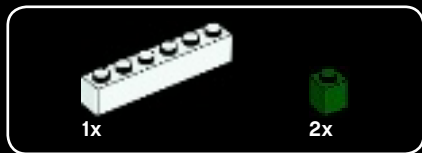

22

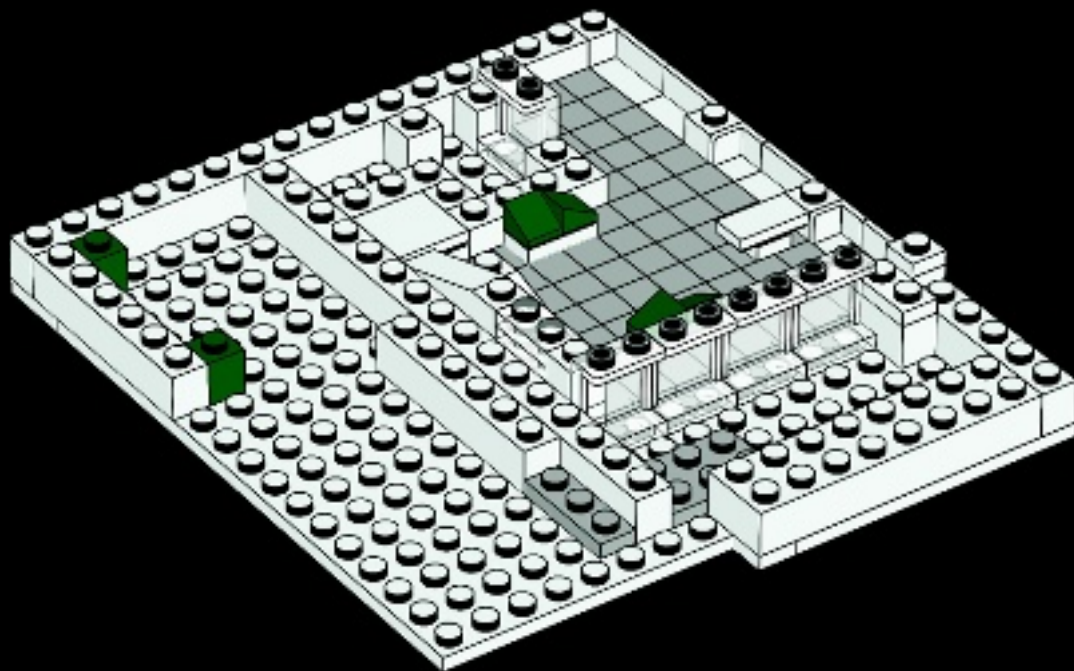



23

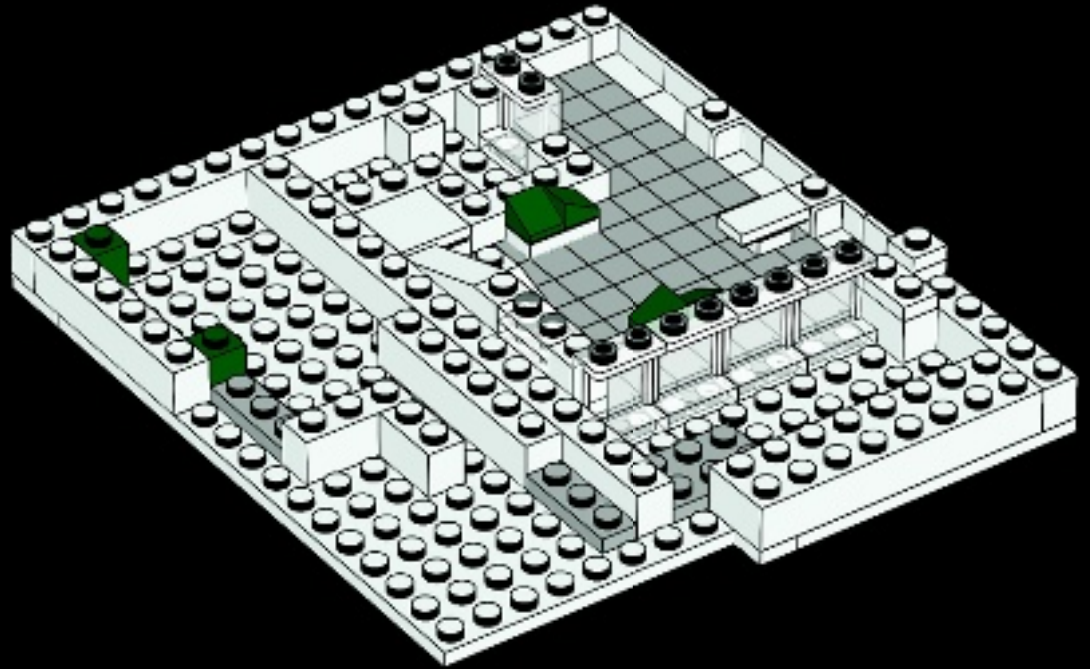



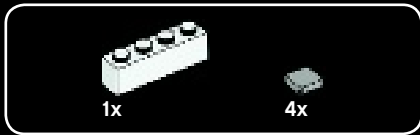

24

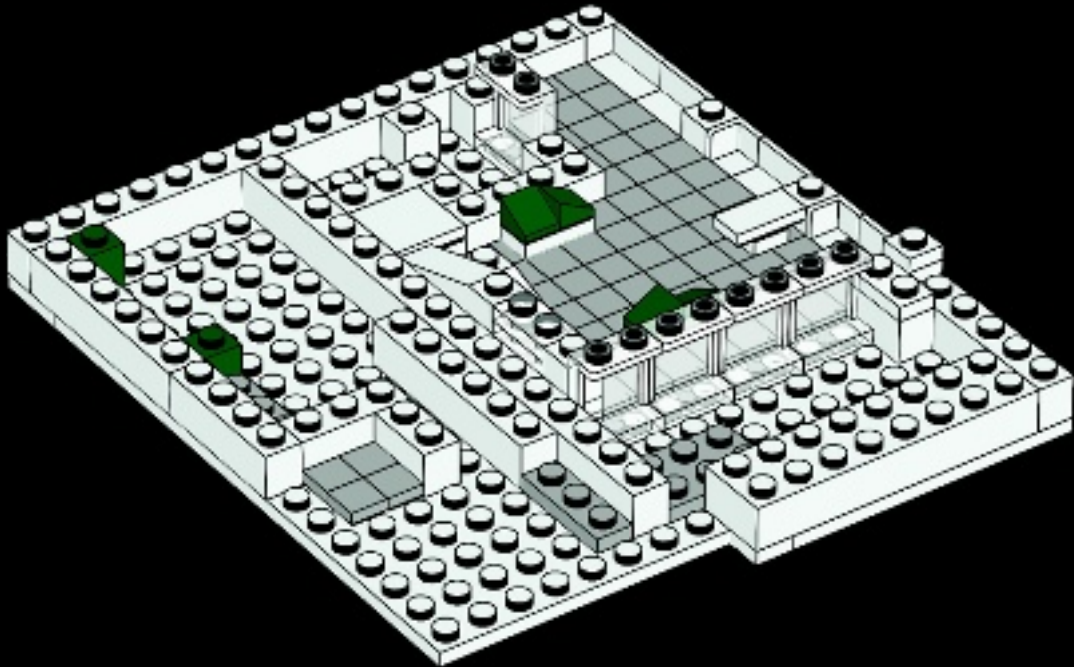

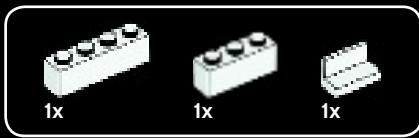

25

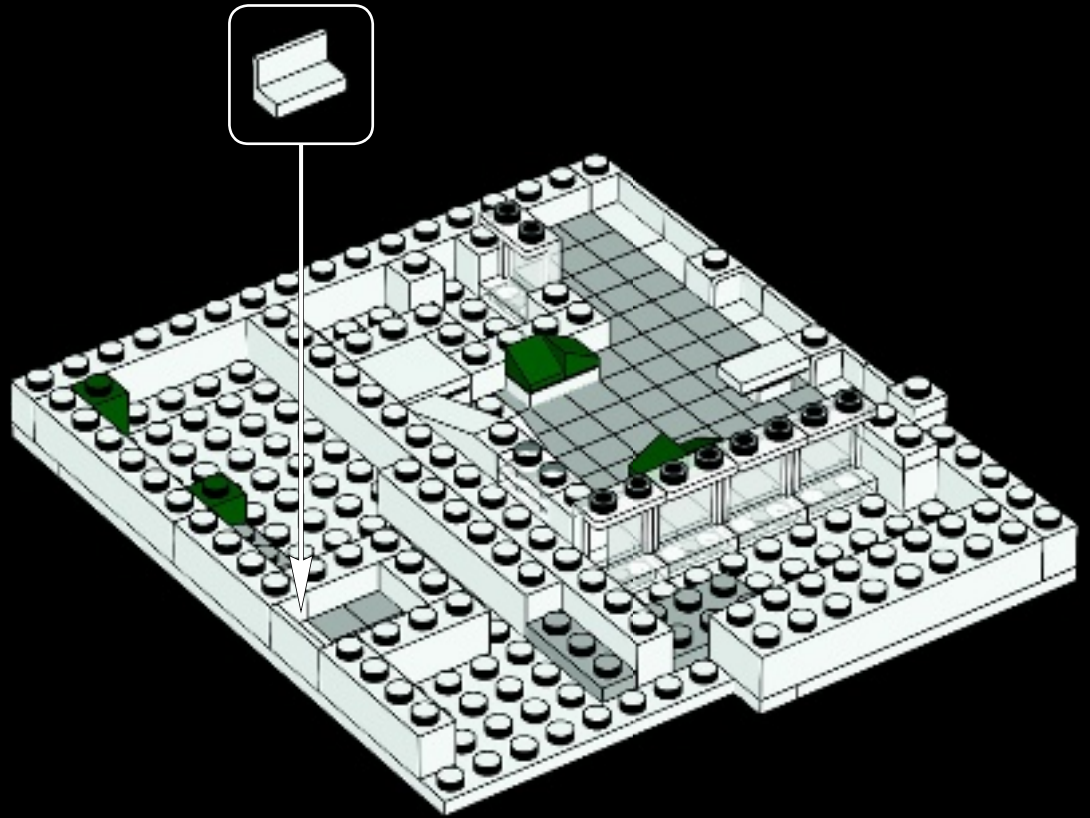

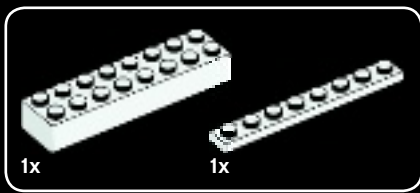

26

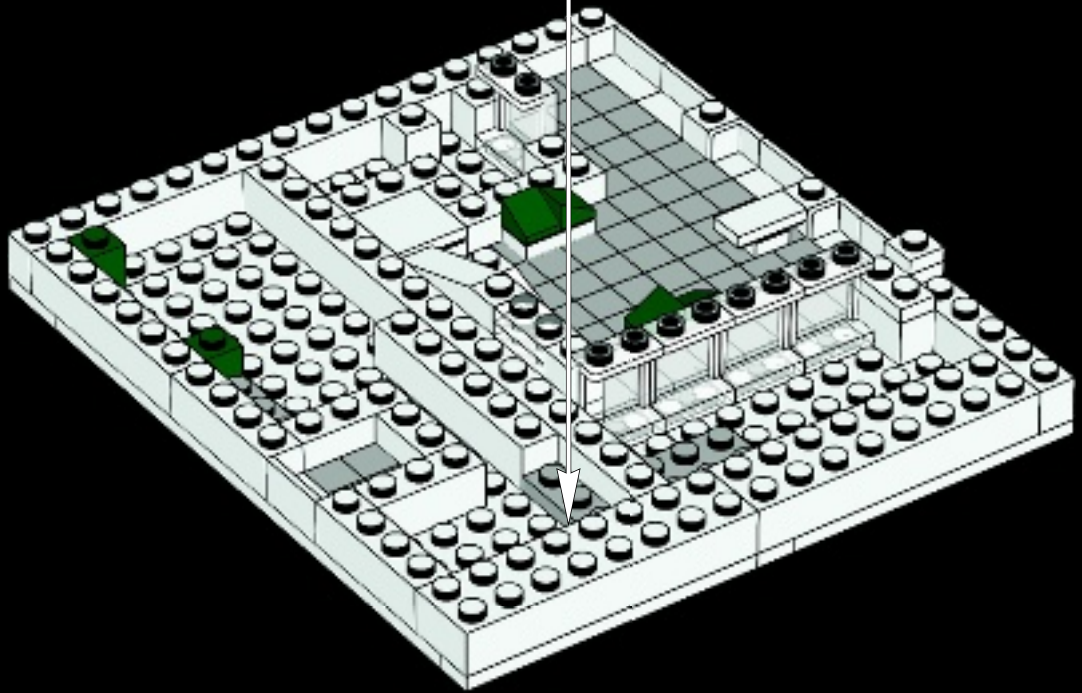
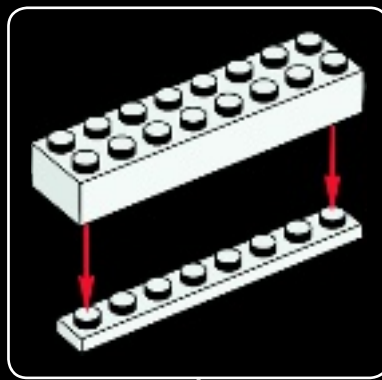



12x

27



6x

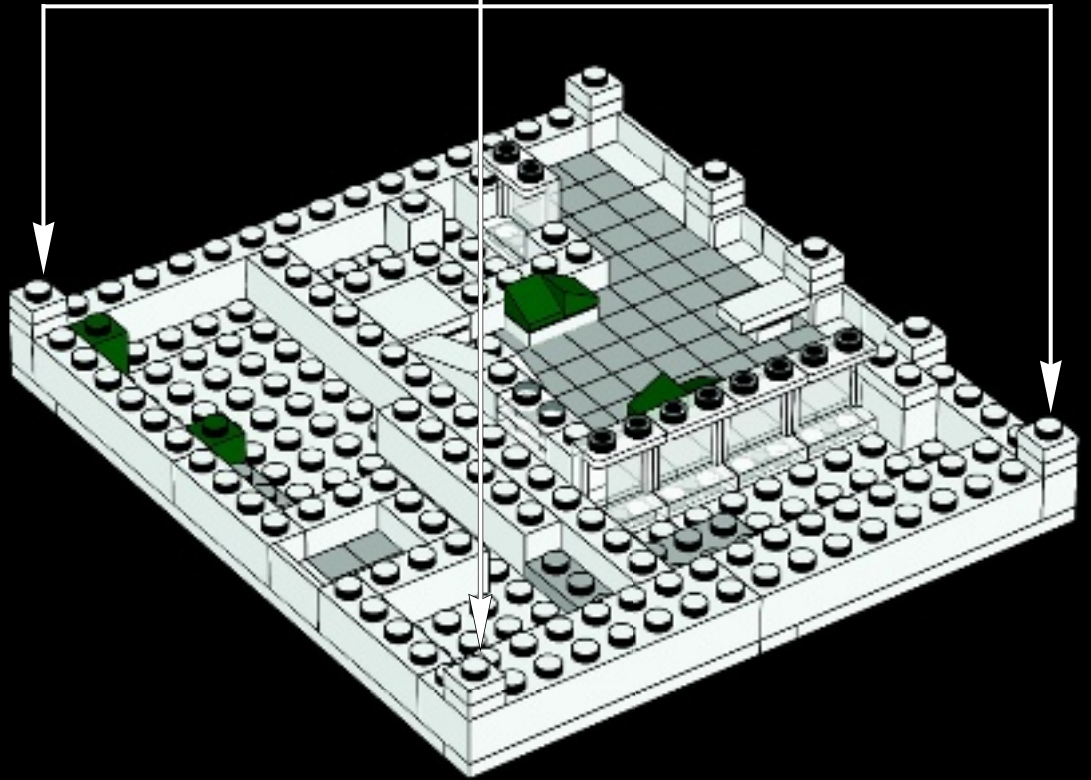





6x

28



3x

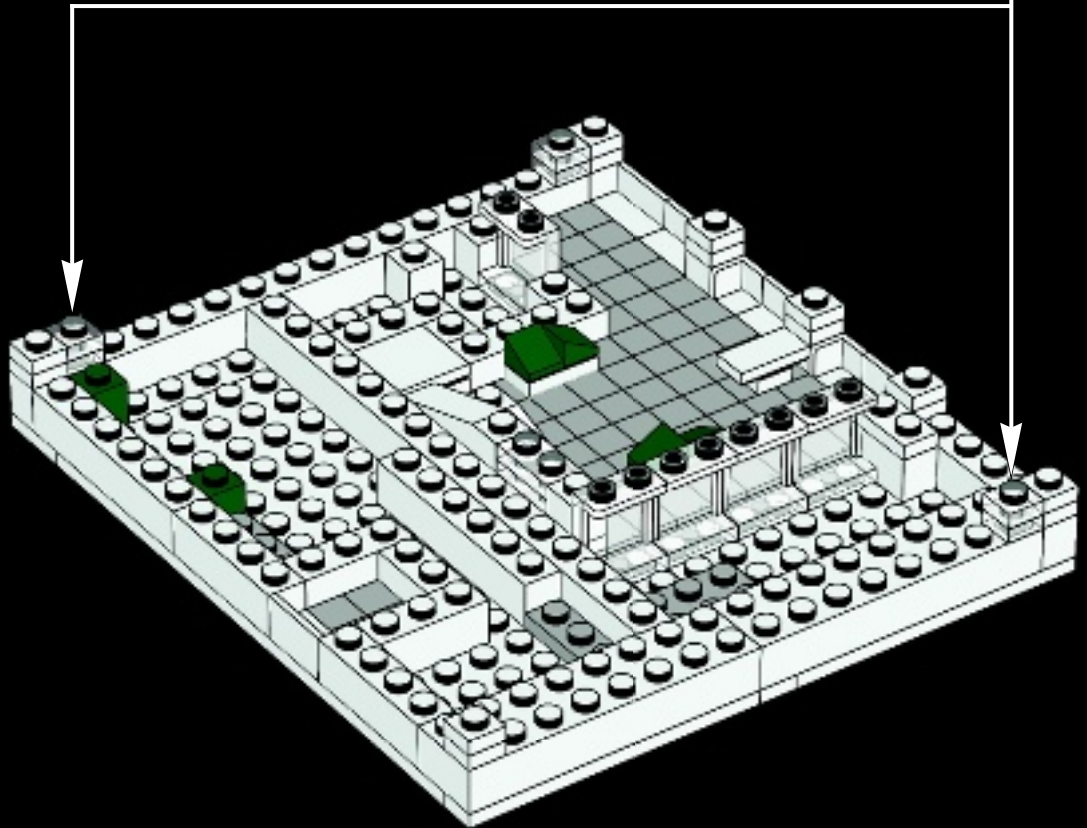



16x

29

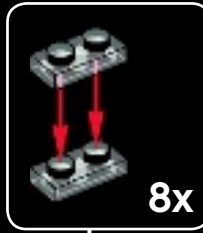

8x

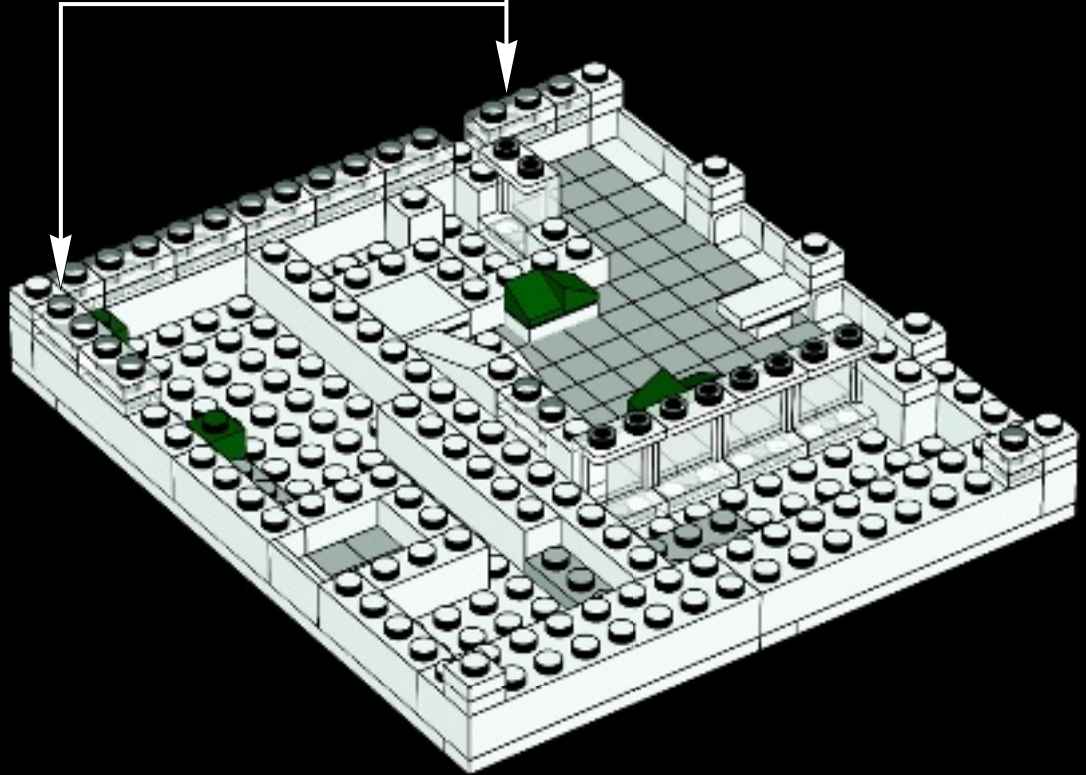

*The Villa Savoye uses horizontal ribbon windows. Unlike many of his modernist contemporaries, Le Corbusier often chose to use timber windows rather than metal ones.*

*La Villa Savoye est dotée de fenêtres rubans horizontales. Contrairement à ses contemporains modernistes, Le Corbusier choisit souvent des fenêtres avec des châssis en bois plutôt qu'en métal.*



© Fondation Le Corbusier



30

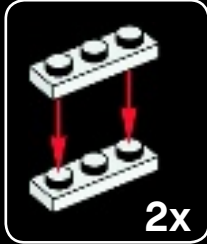
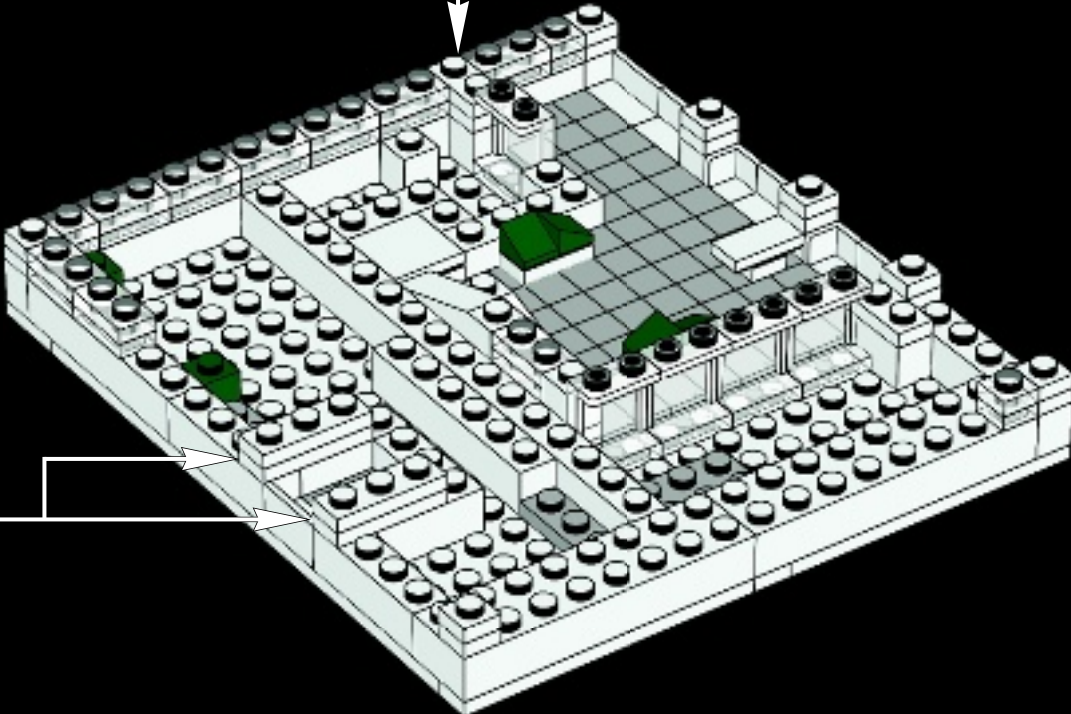
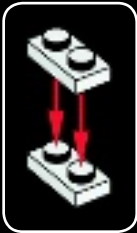



2x



8x

# 31

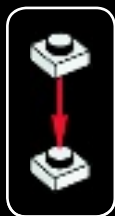

4x

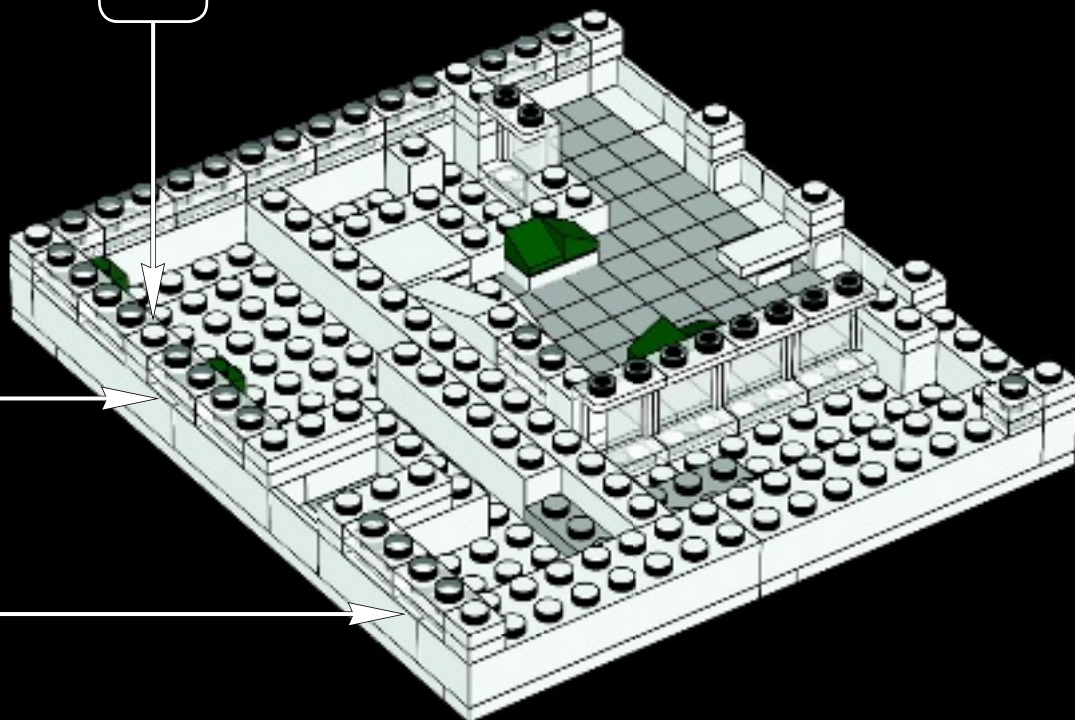





3x

32



3x

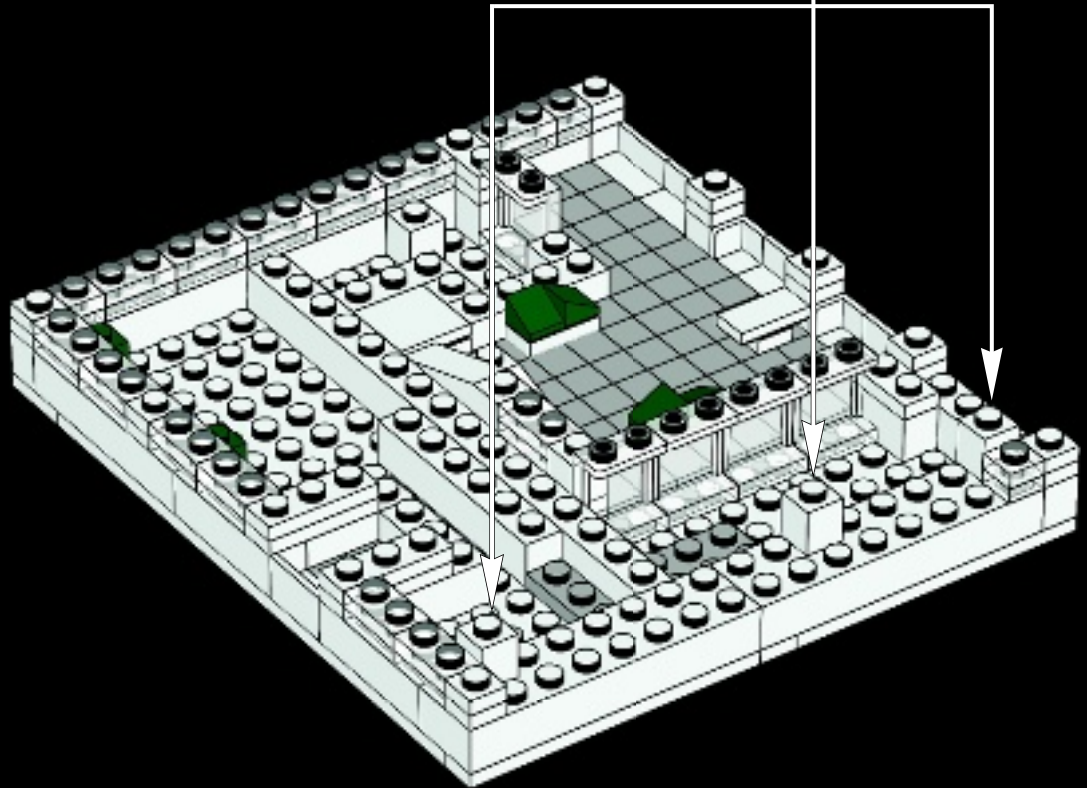



18x

33



9x

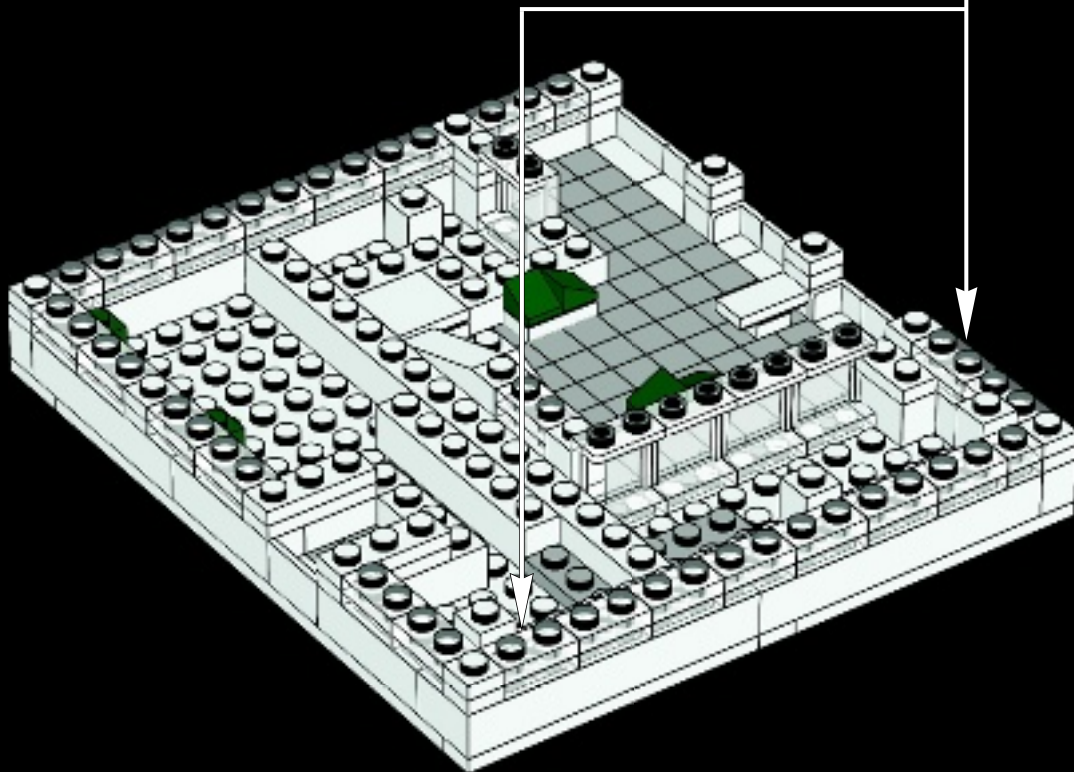



2x



1x

# 34

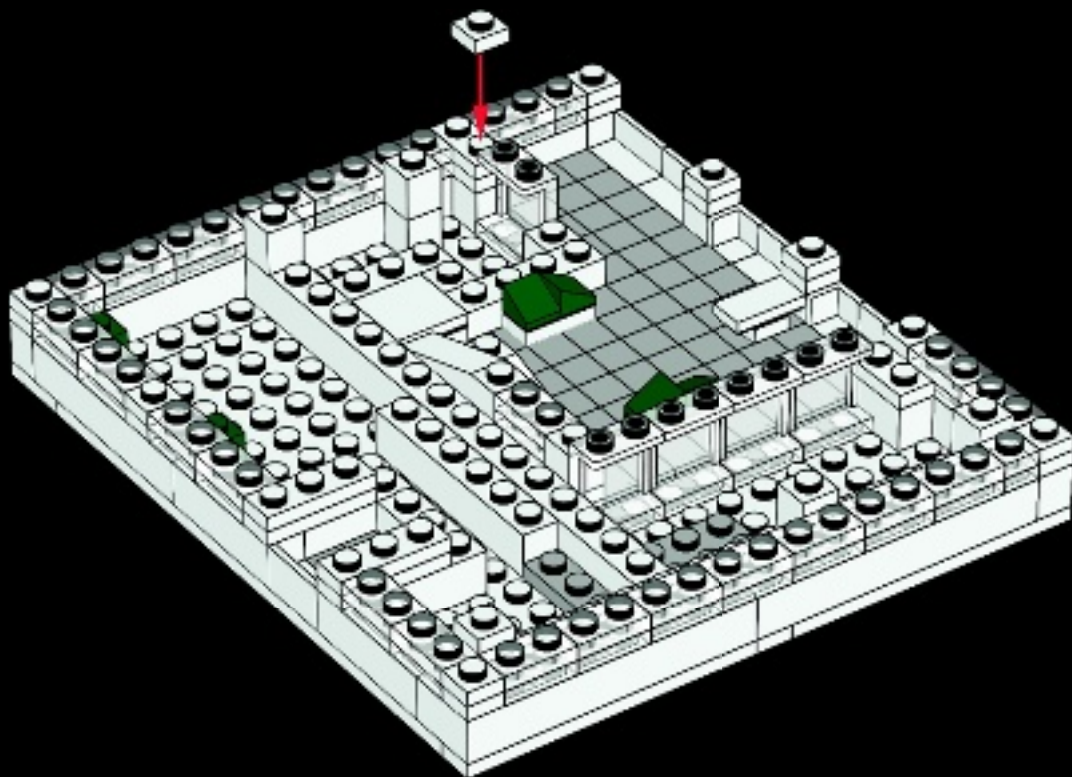

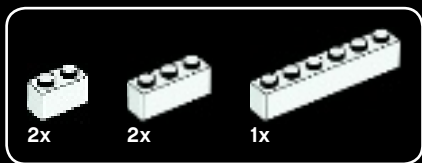

35

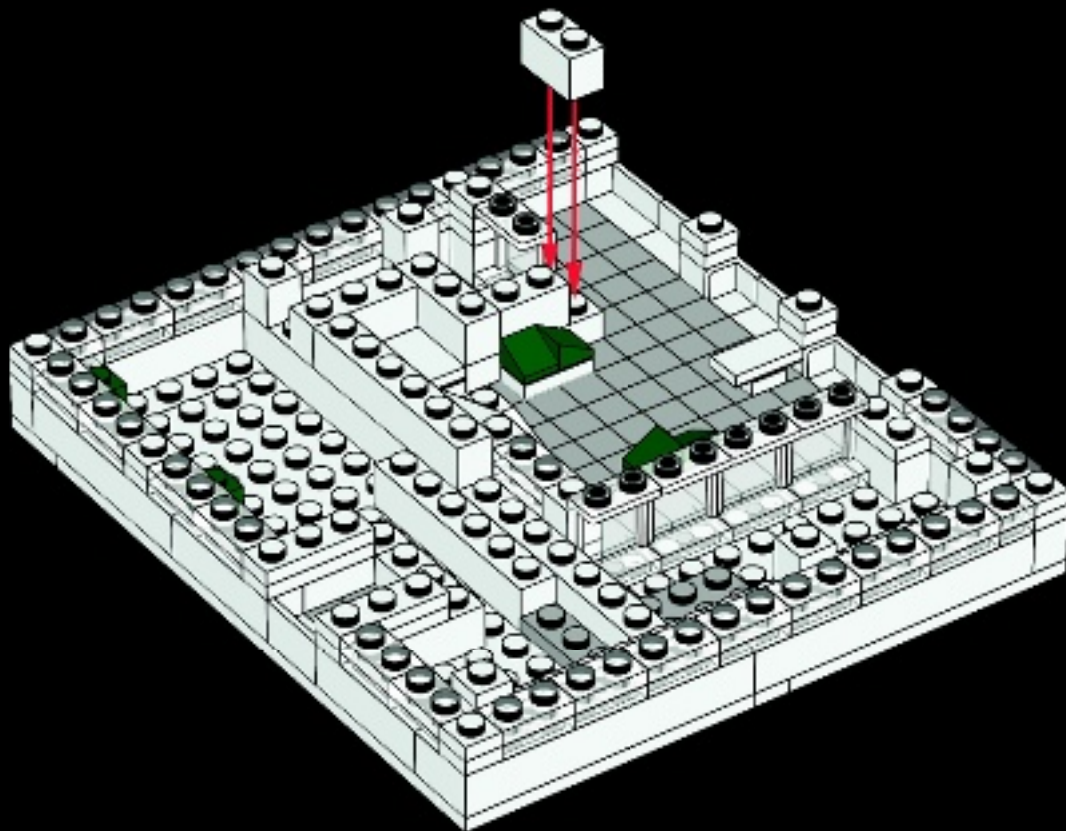





36

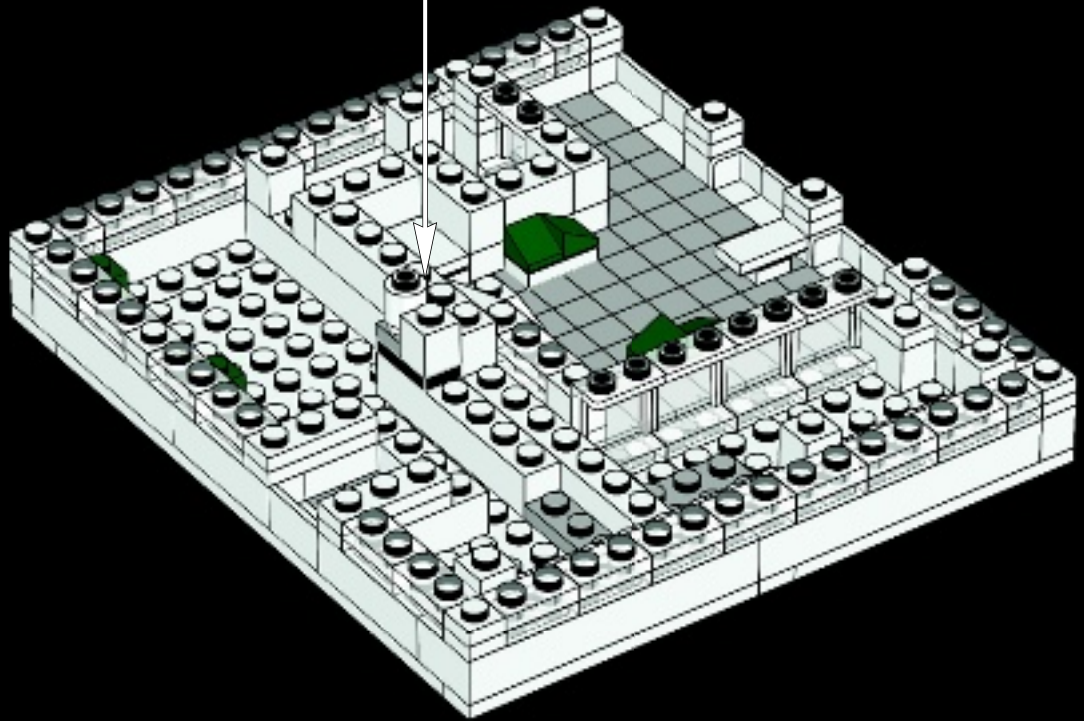
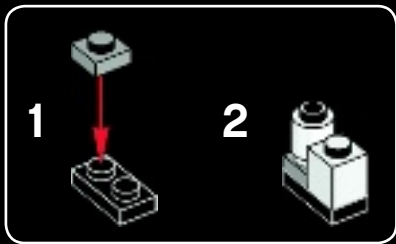



37

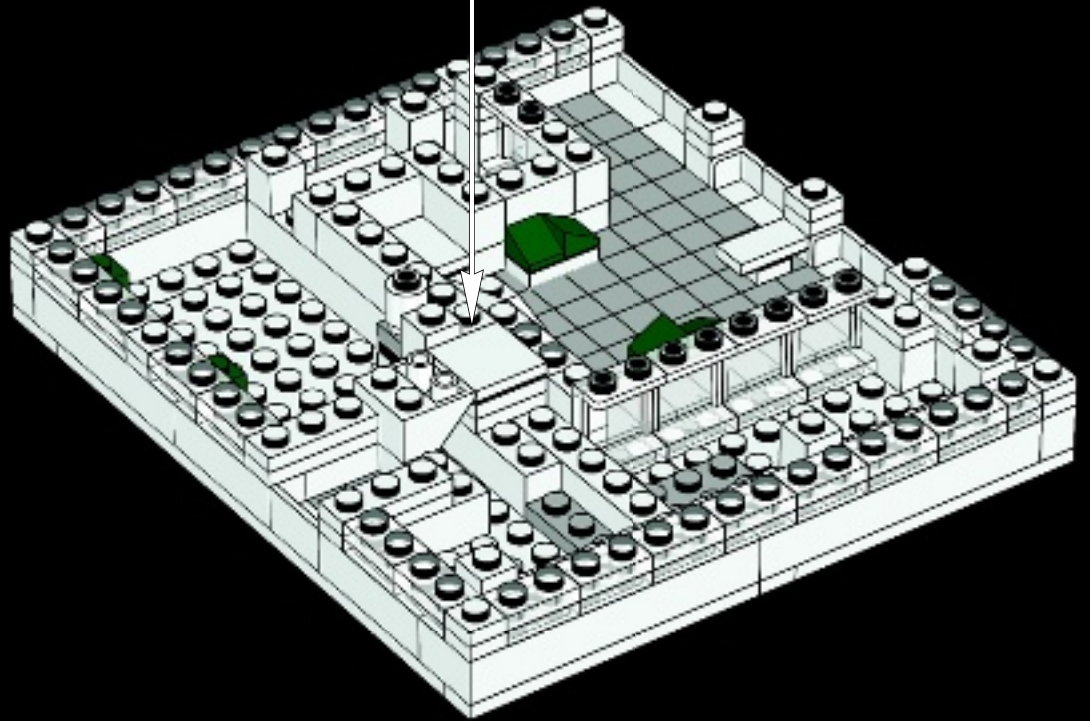
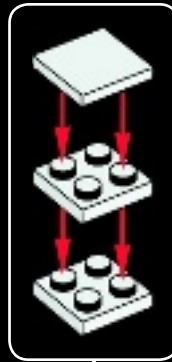



1x



1x

# 38

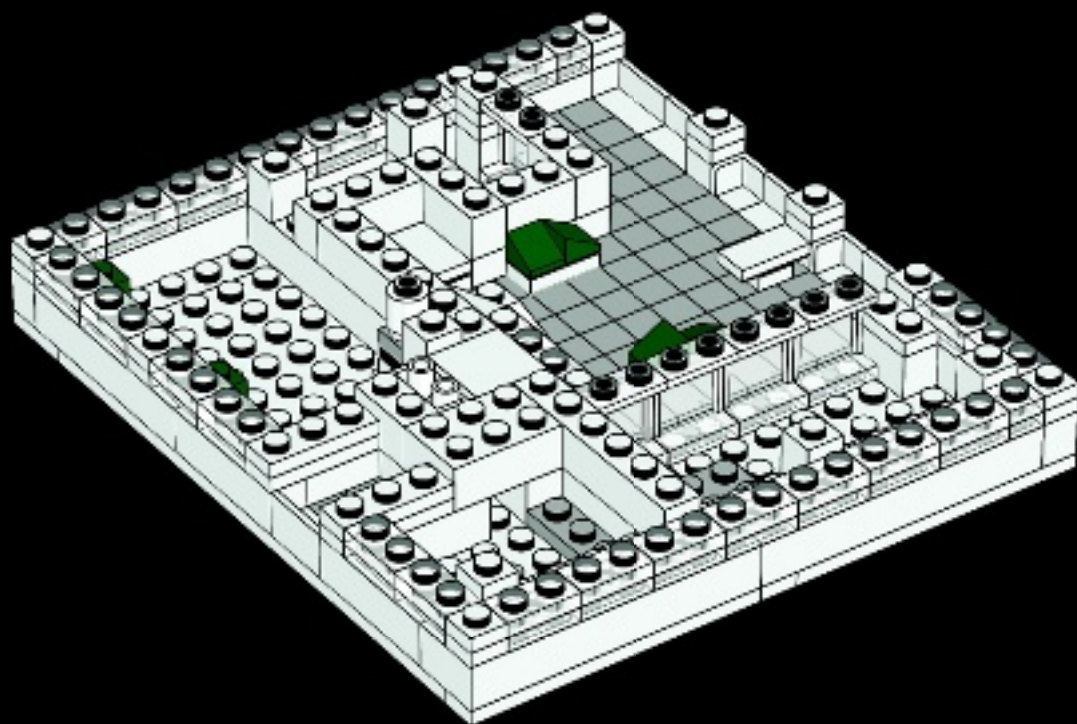

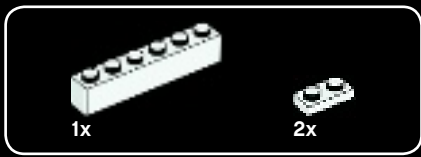

39

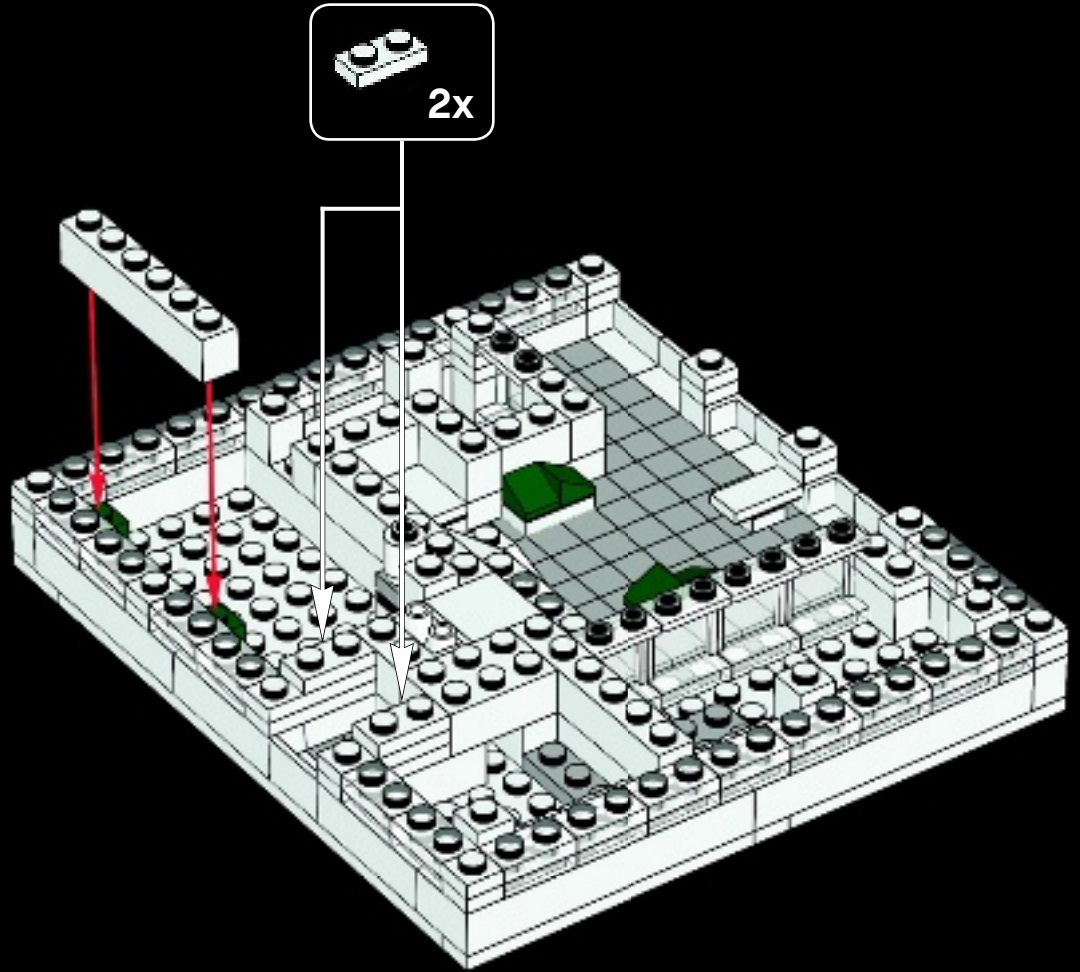



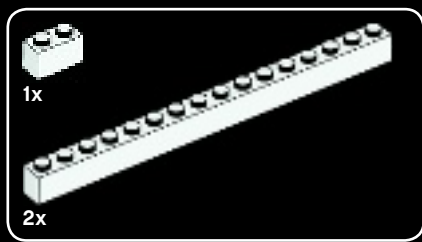

40

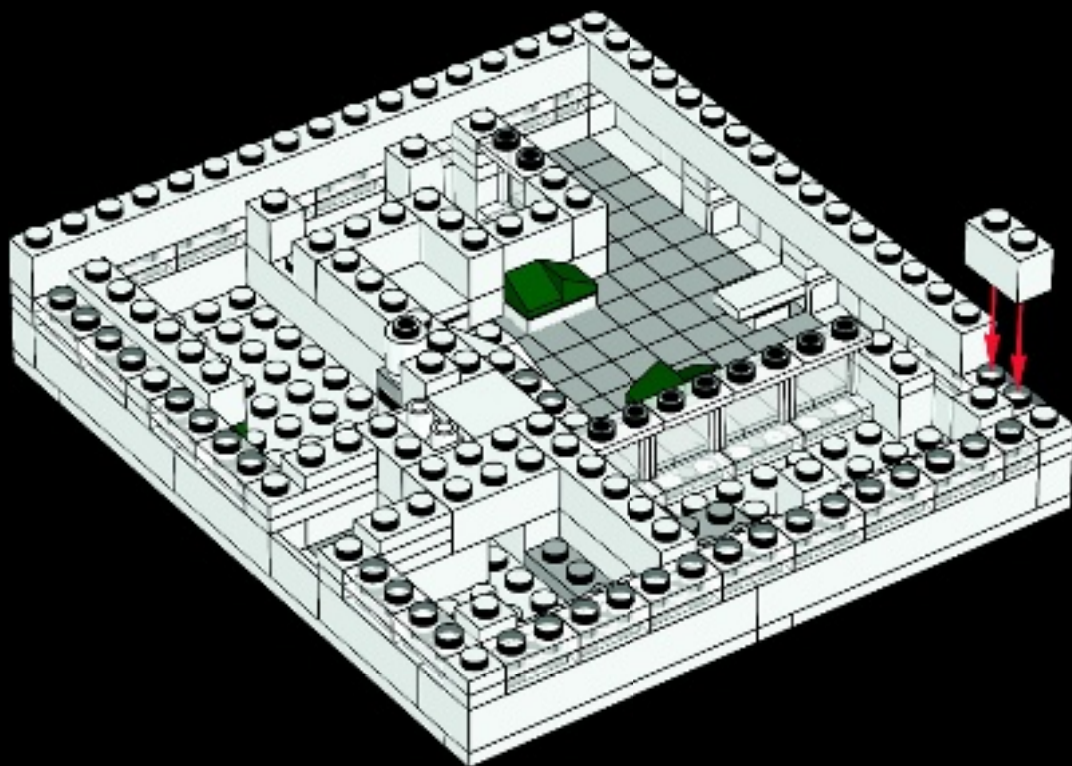



2x

41

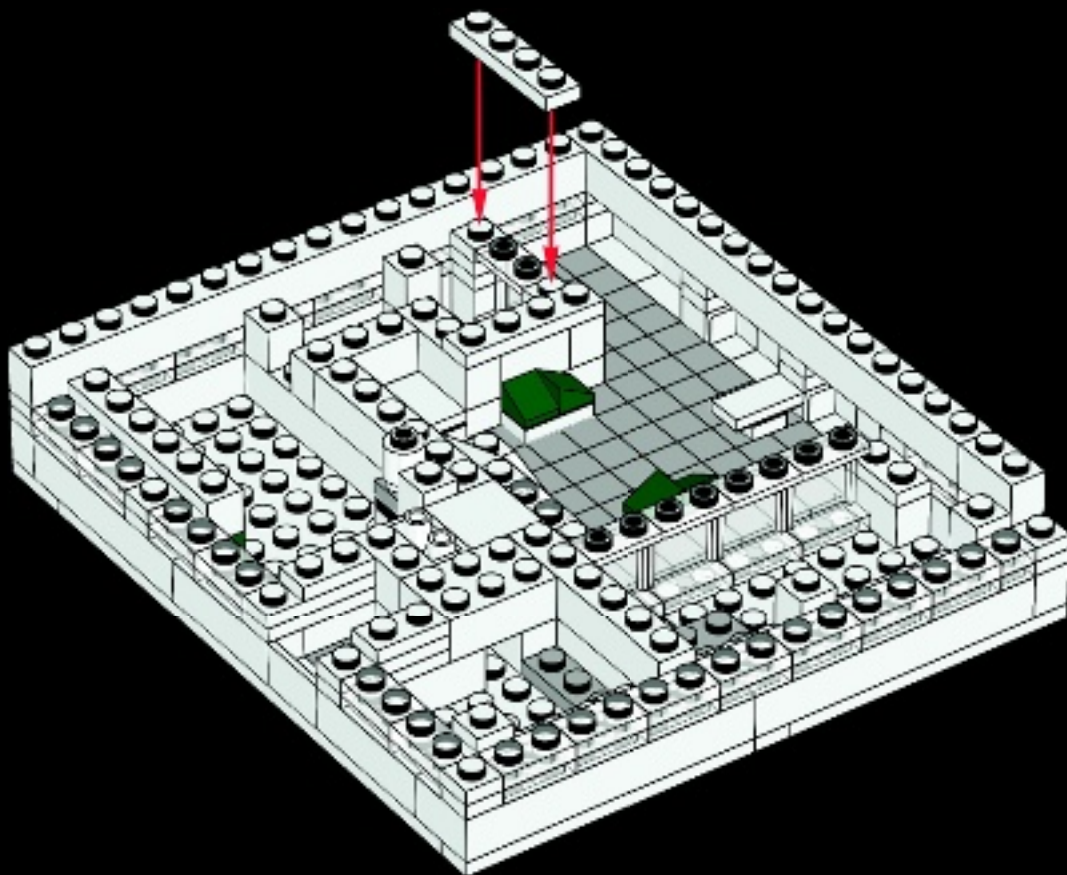

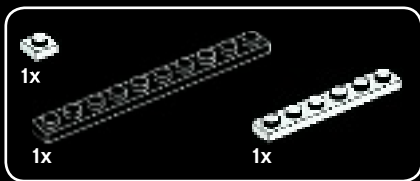

42

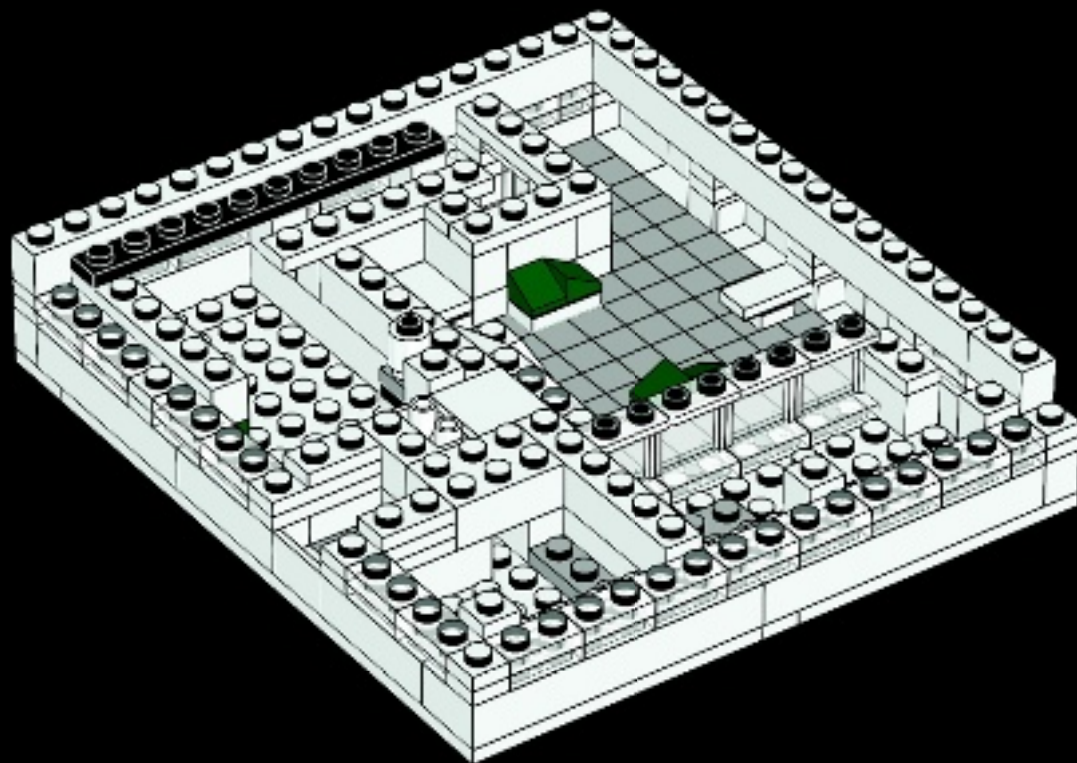

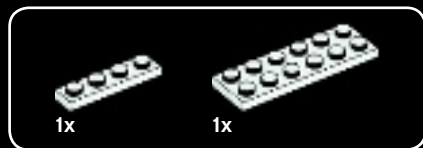

43

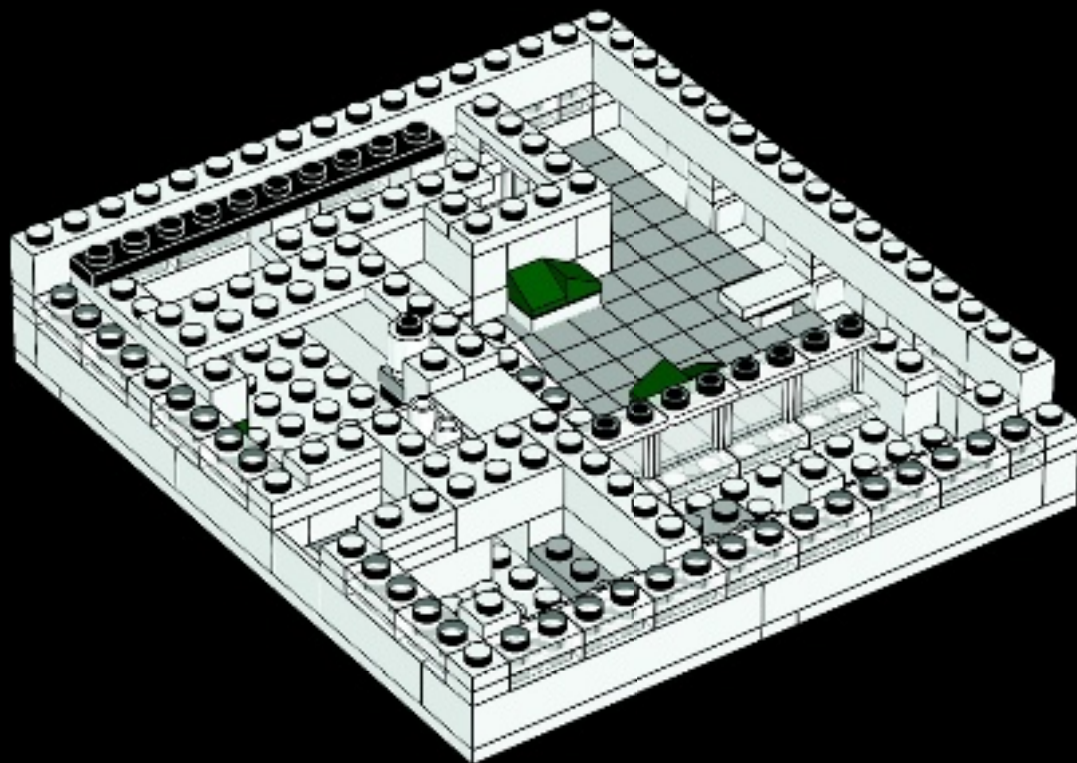



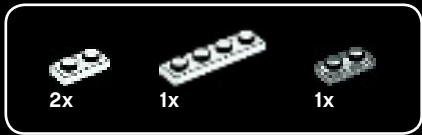

44

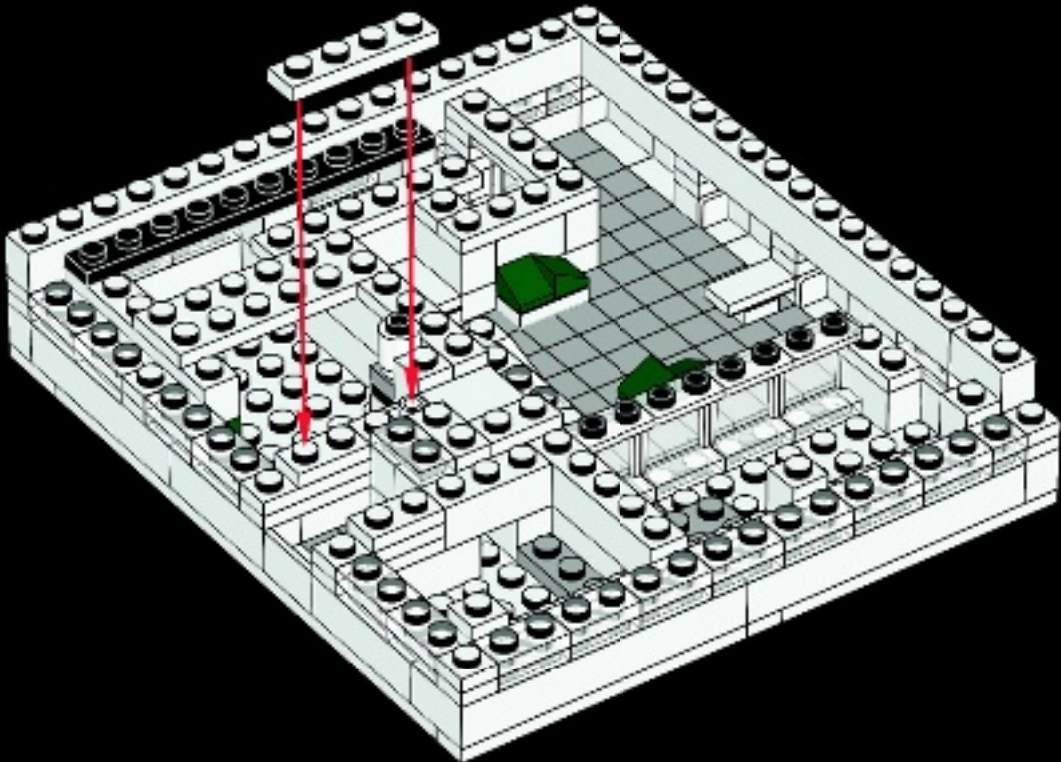

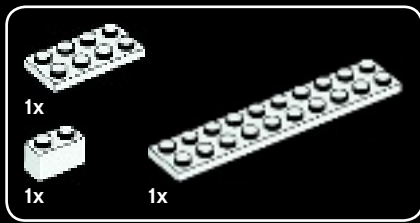

45

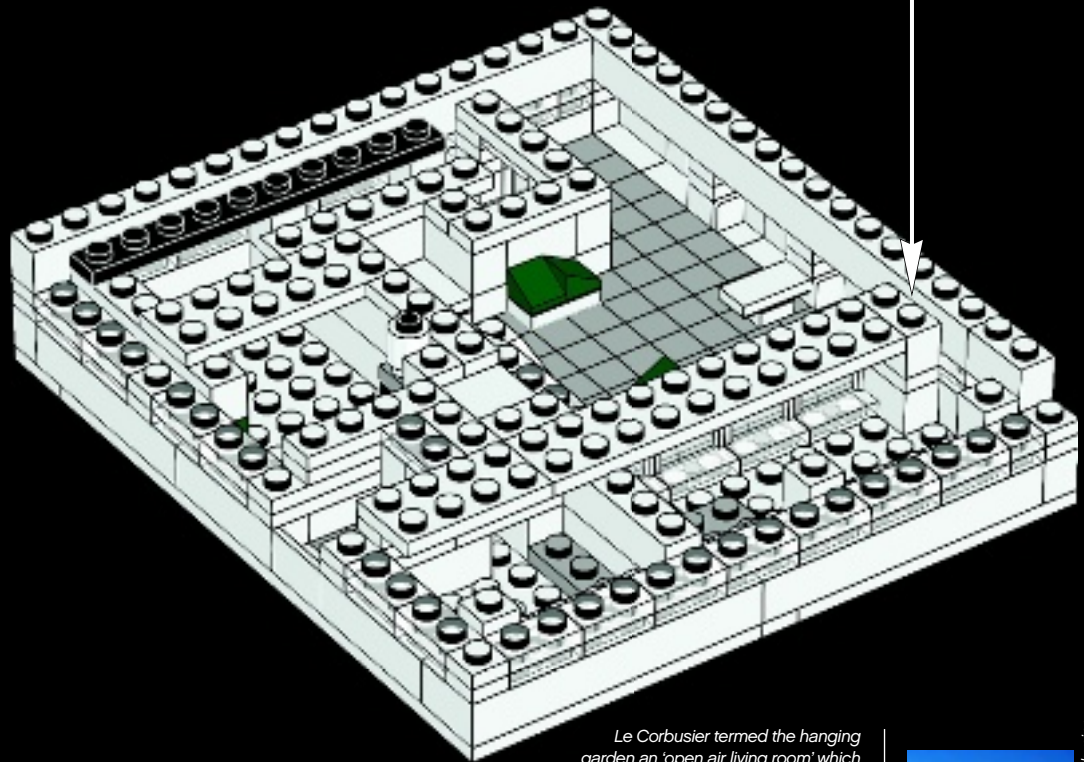

*Le Corbusier termed the hanging garden an 'open air living room' which could be used for summer receptions.*

*Le Corbusier appela le jardin suspendu un « salon en plein air » qui pouvait être utilisé pour des réceptions l'été.*



© Fondation Le Corbusier



46

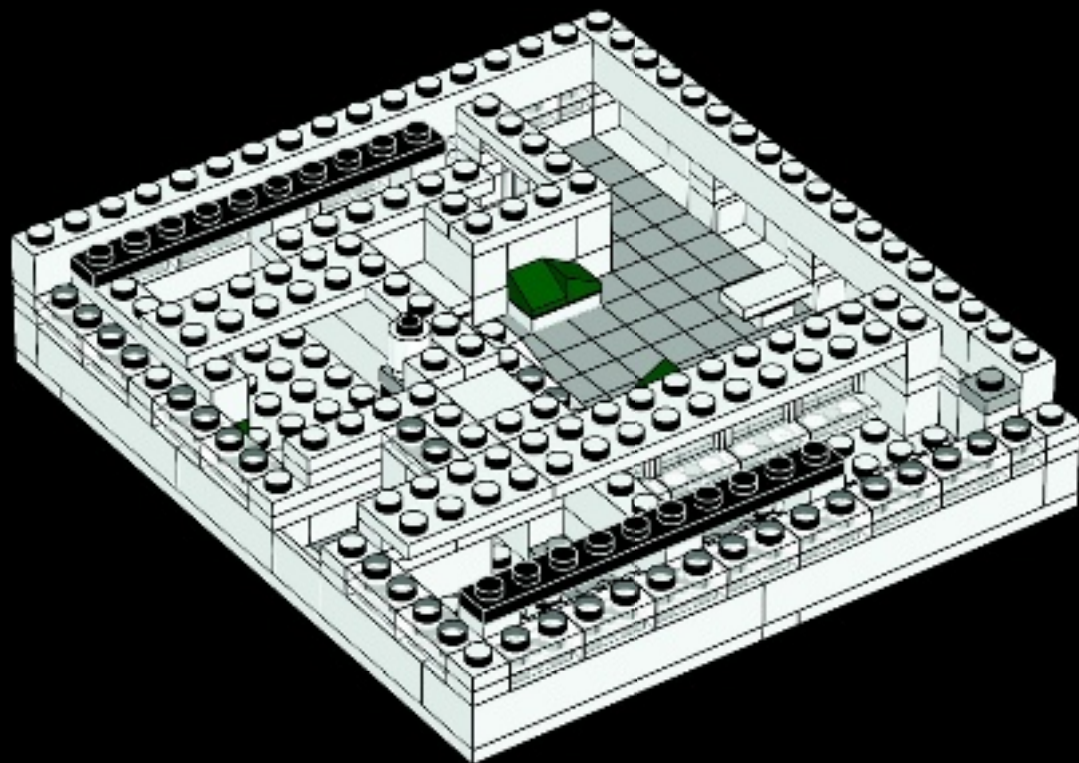

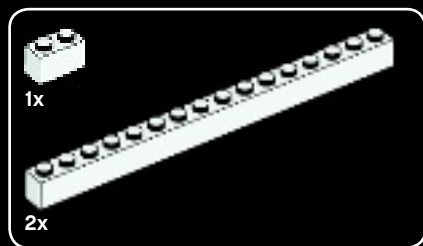

47

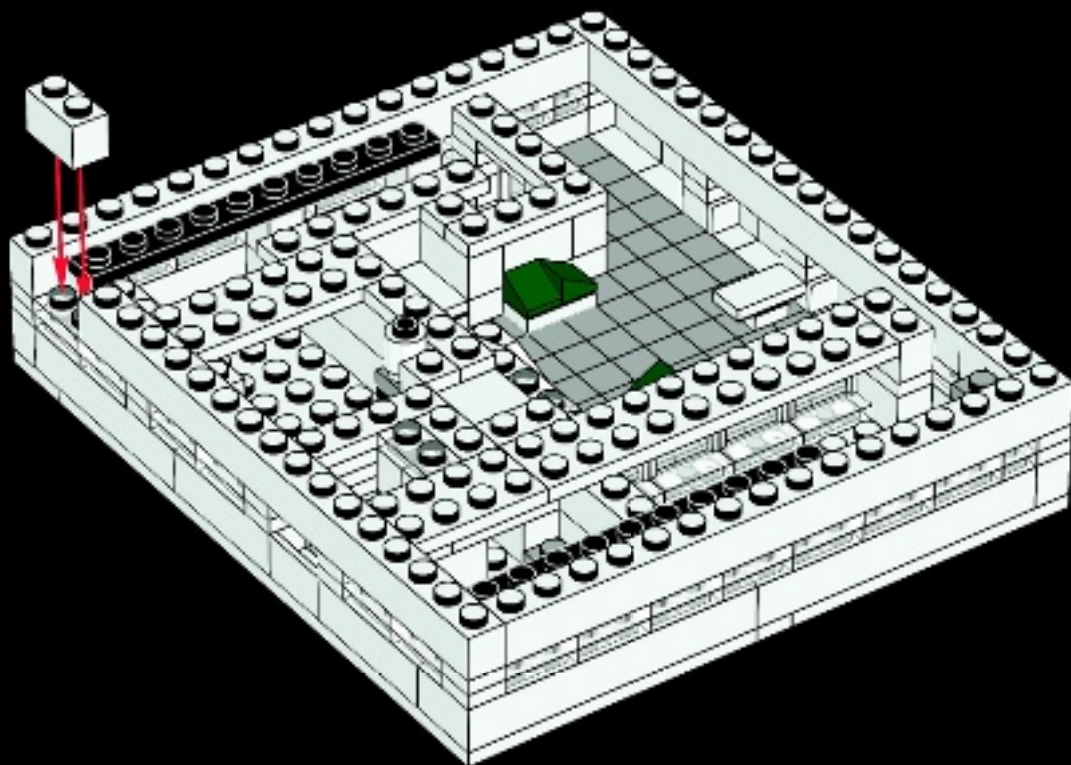



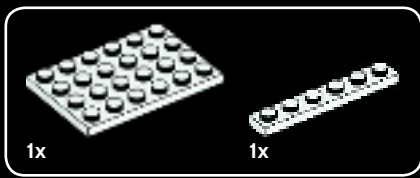

48

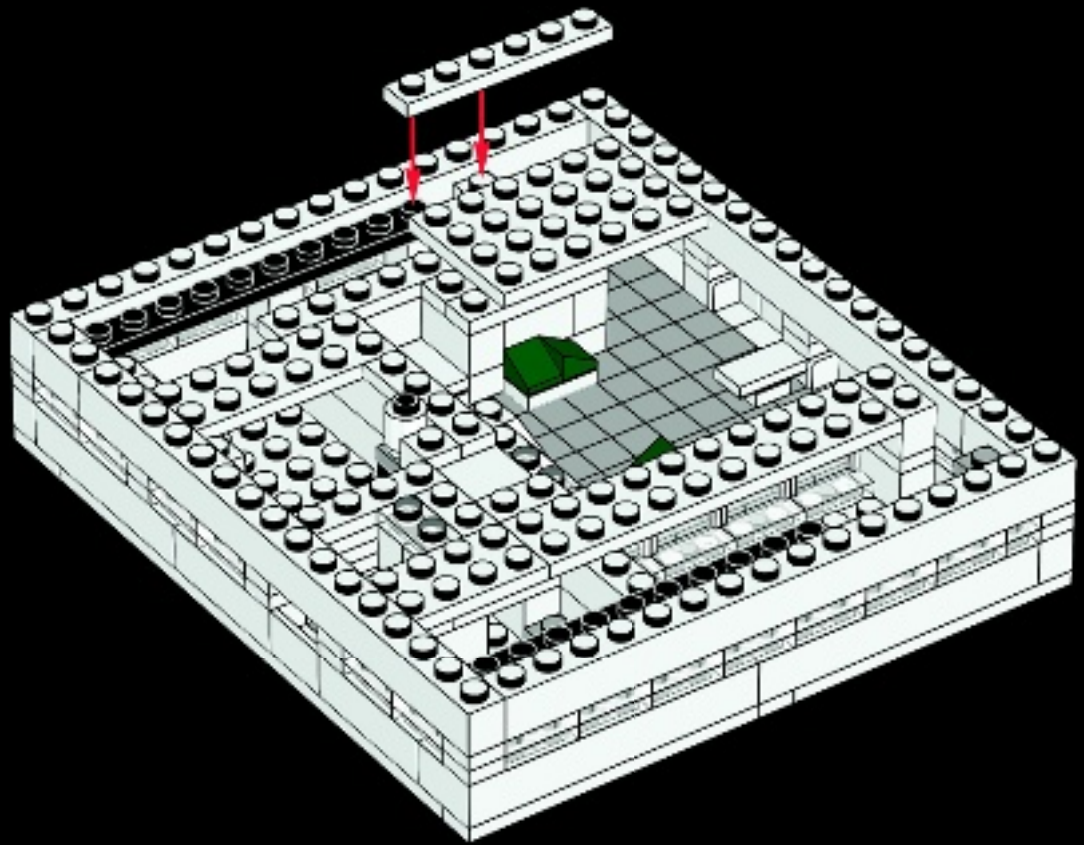

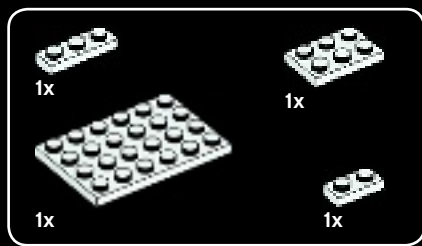

49

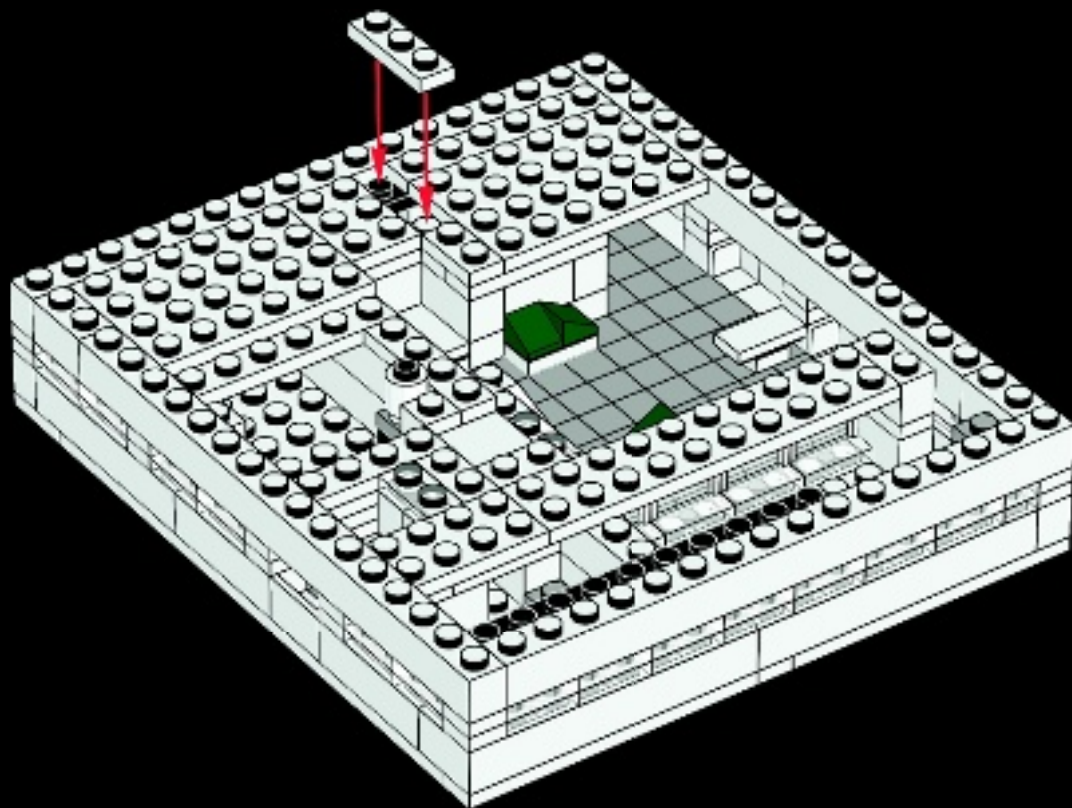

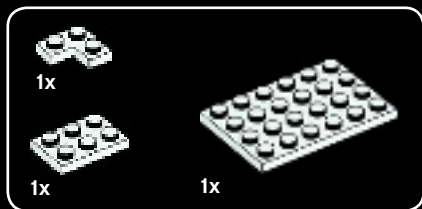

50

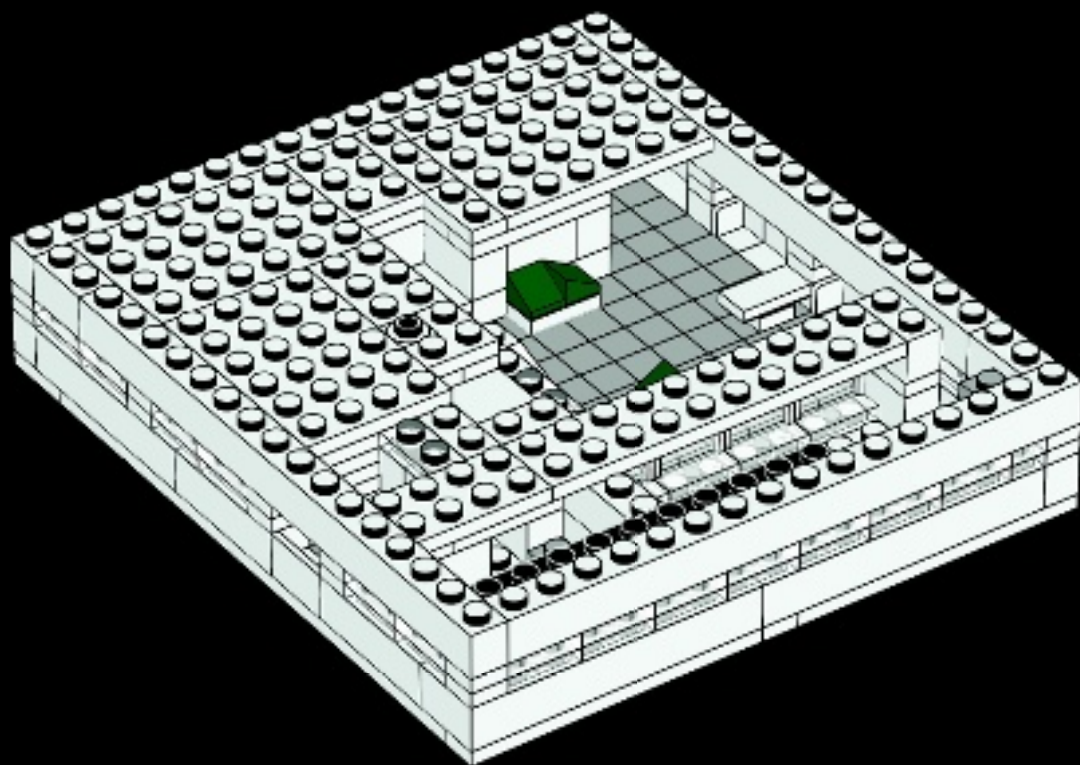



51

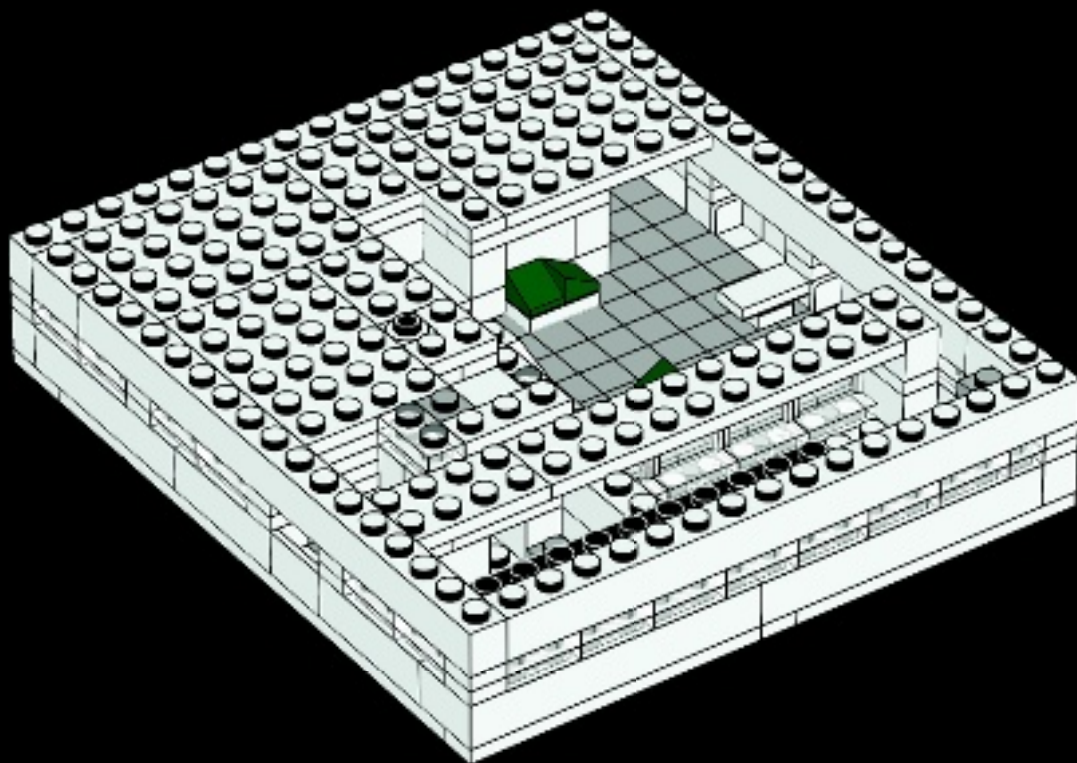



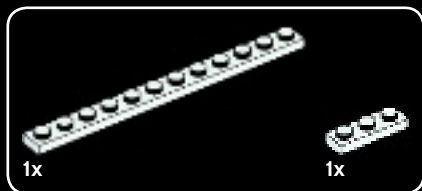

52

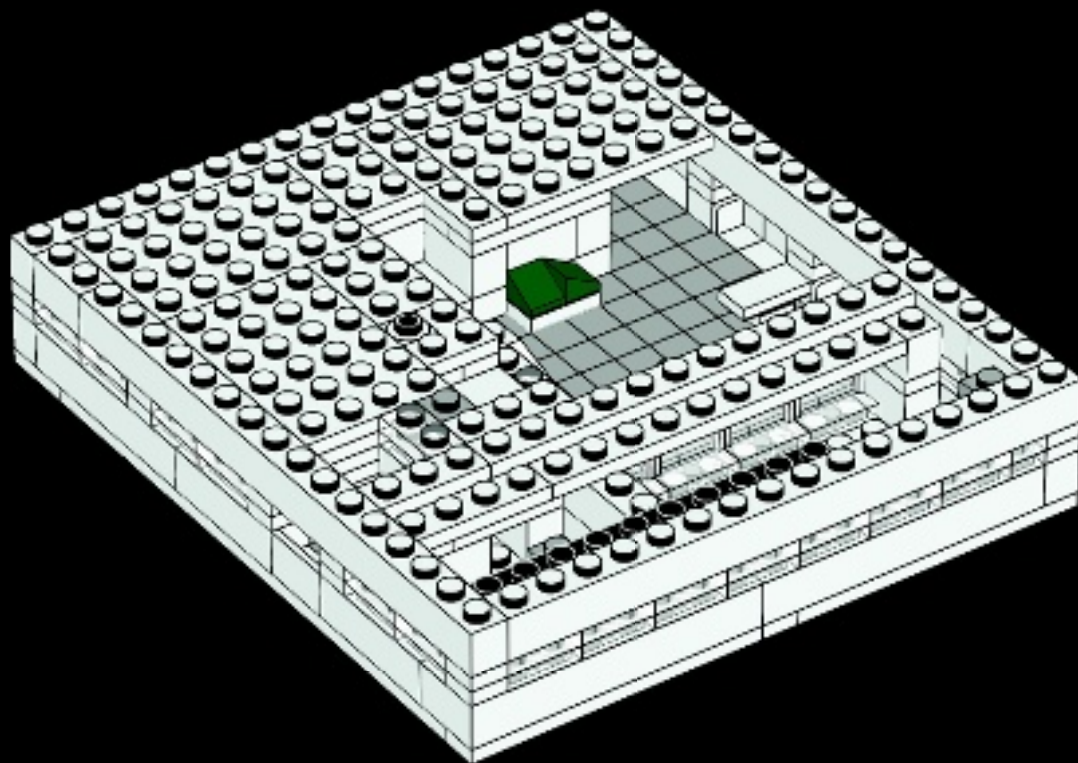

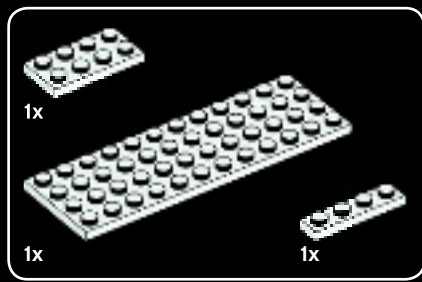

53

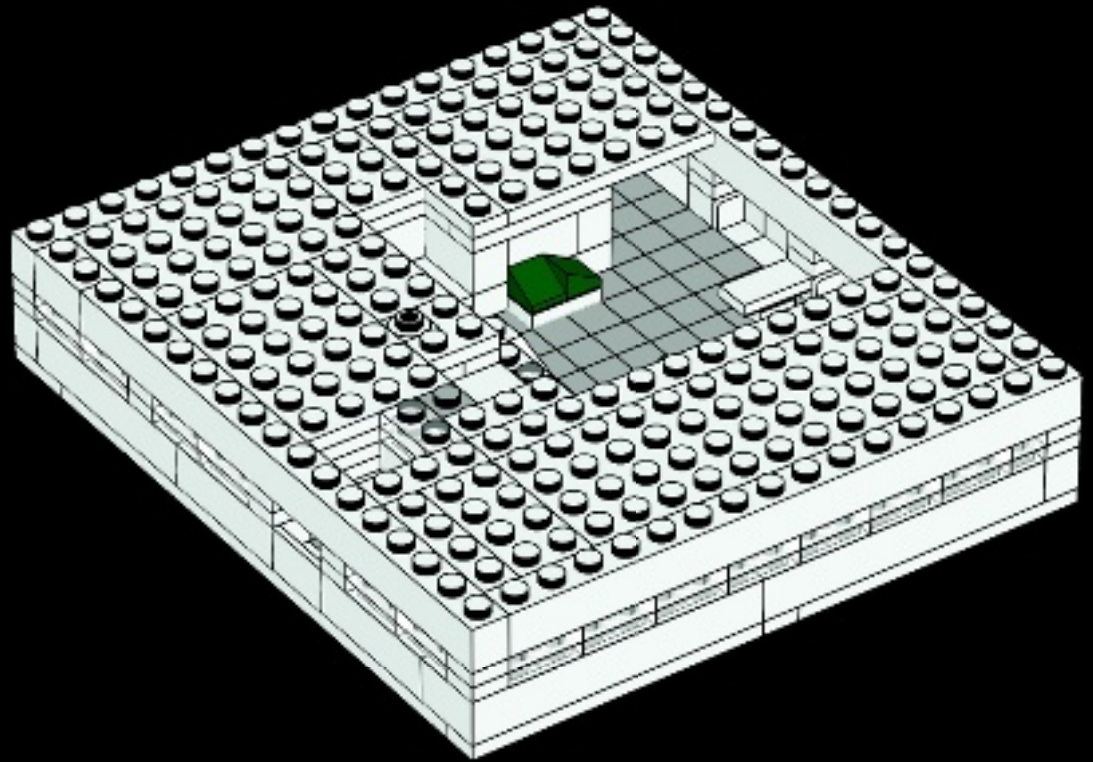

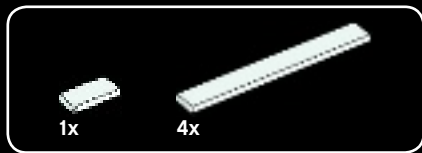

54

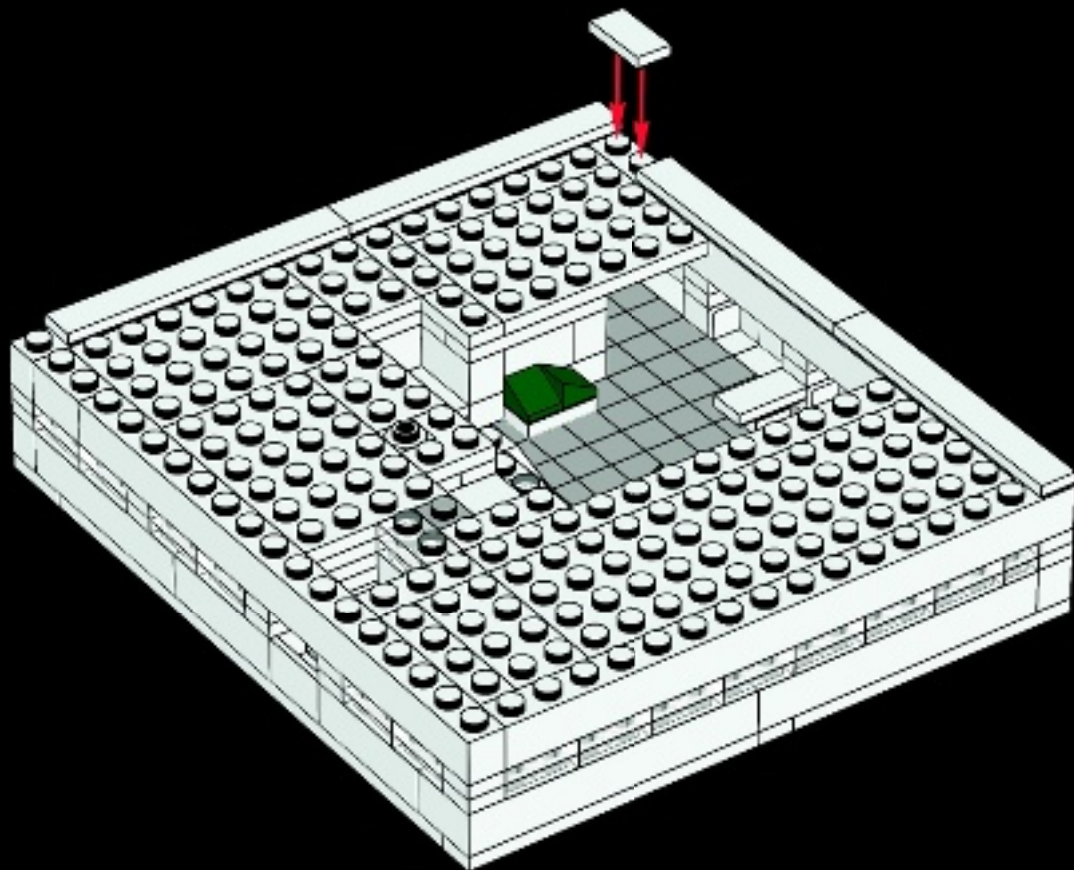

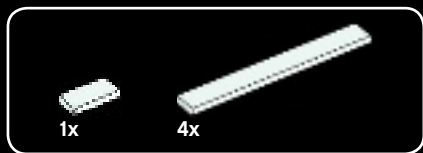

55

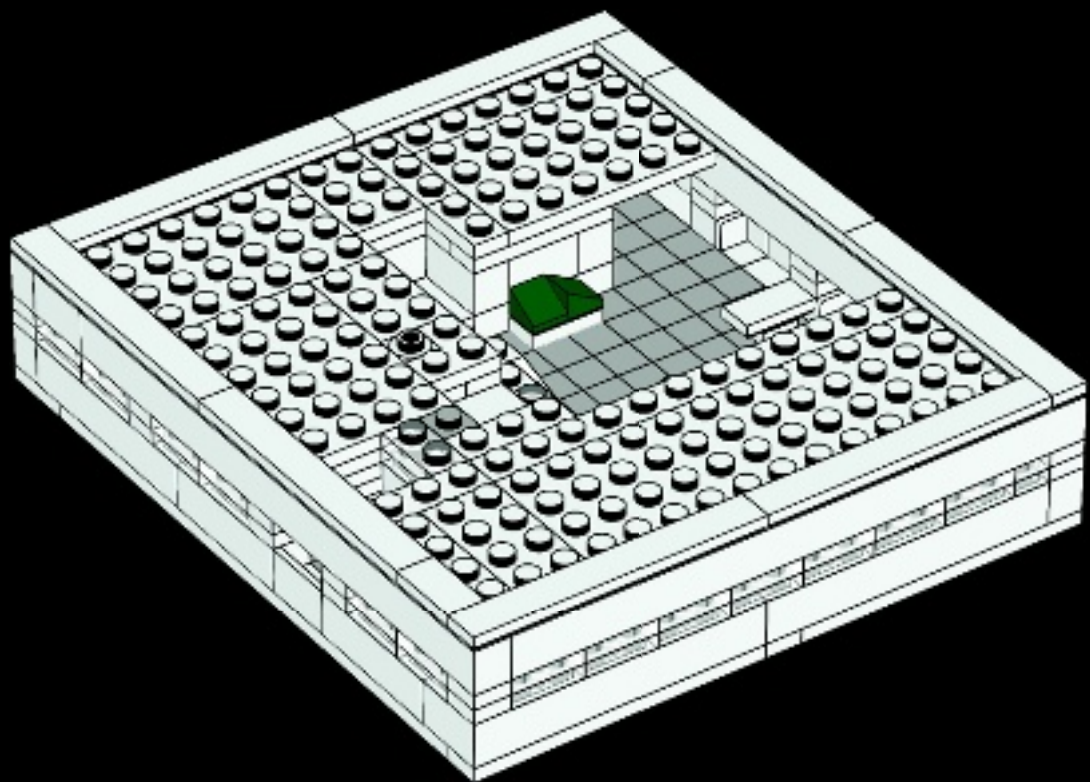





56

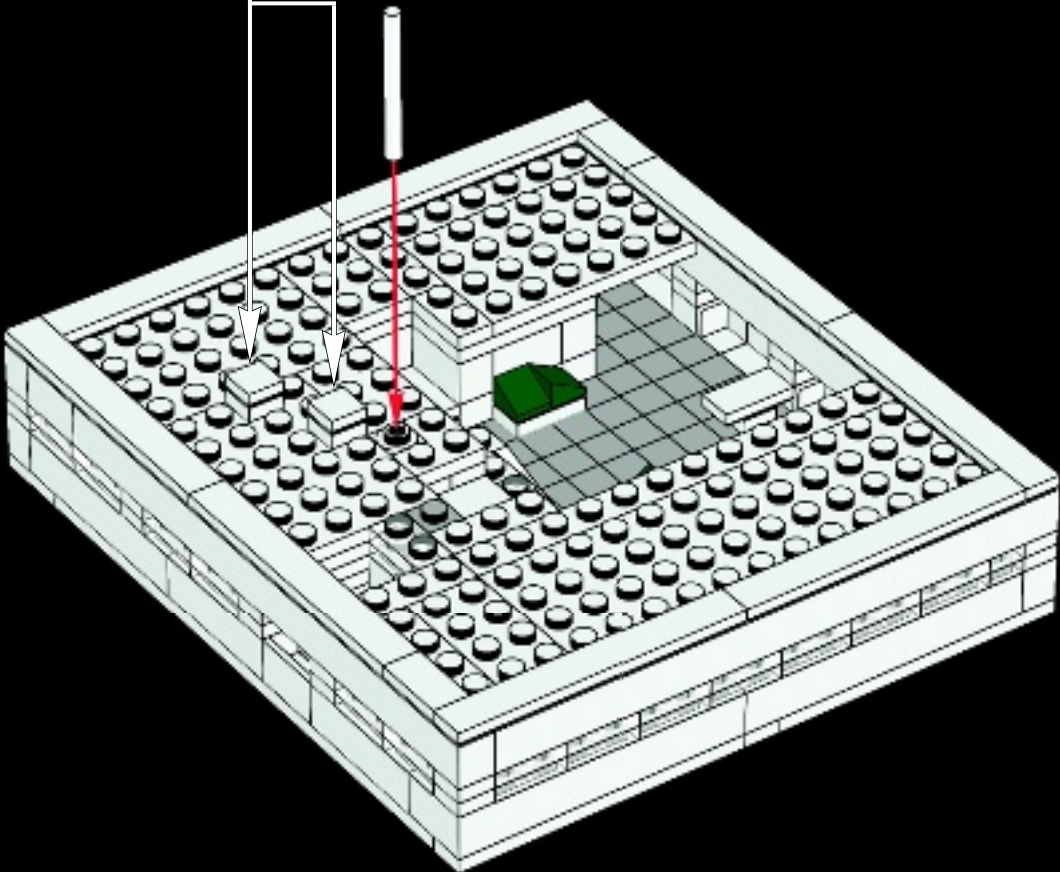
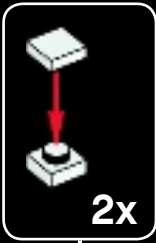



2x

57



2x

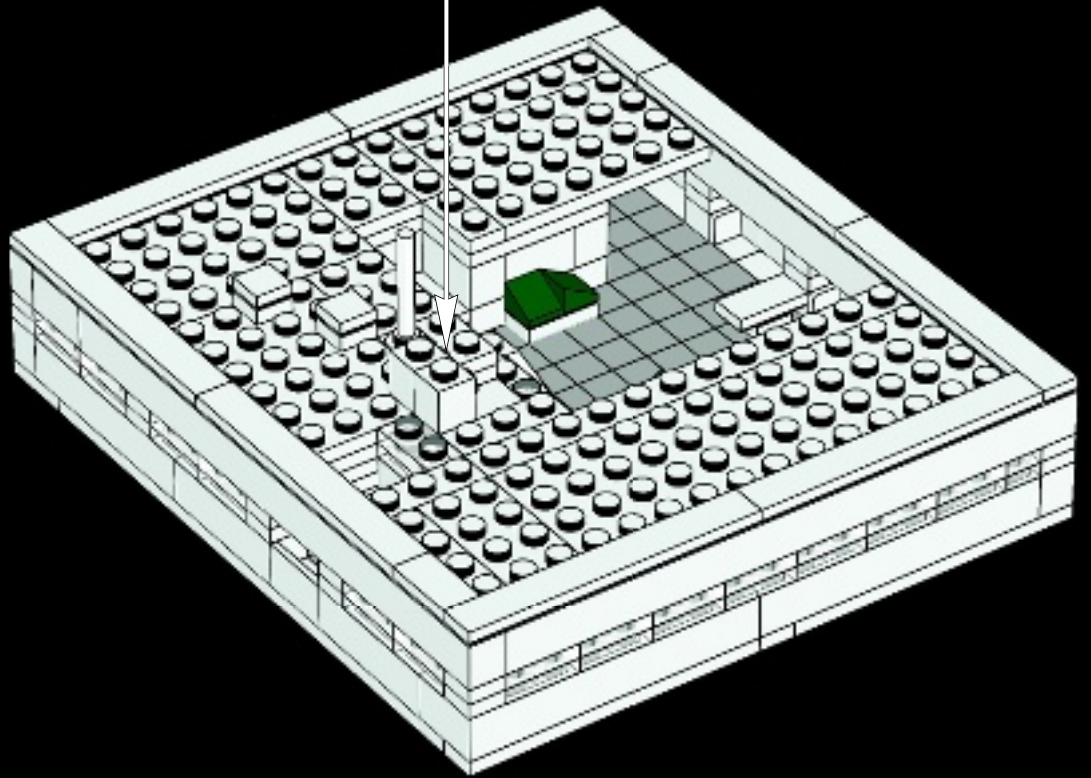



1x



2x

# 58

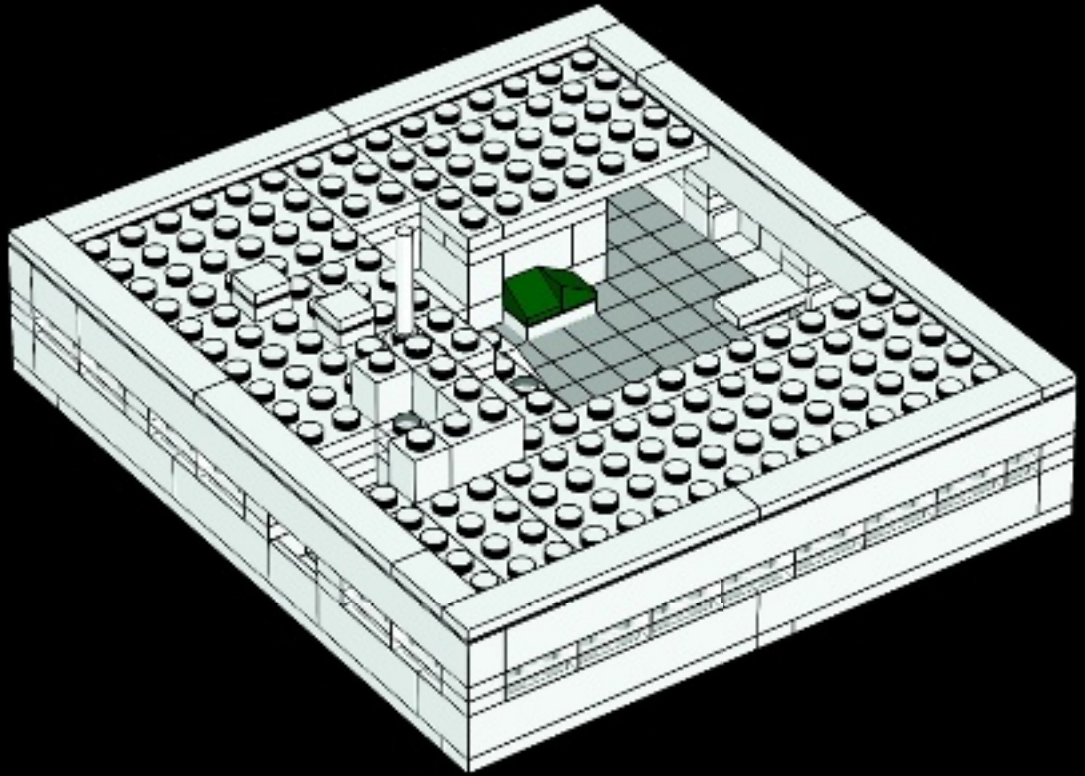



2x



1x

# 59

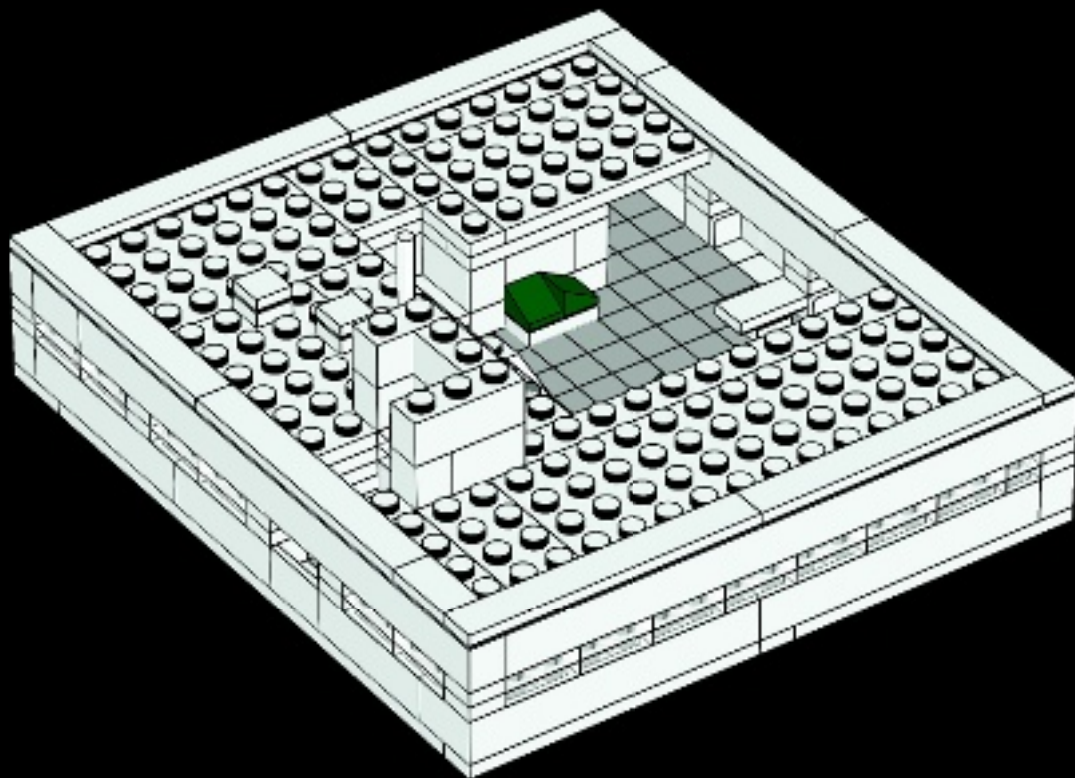





6x

60

1



2

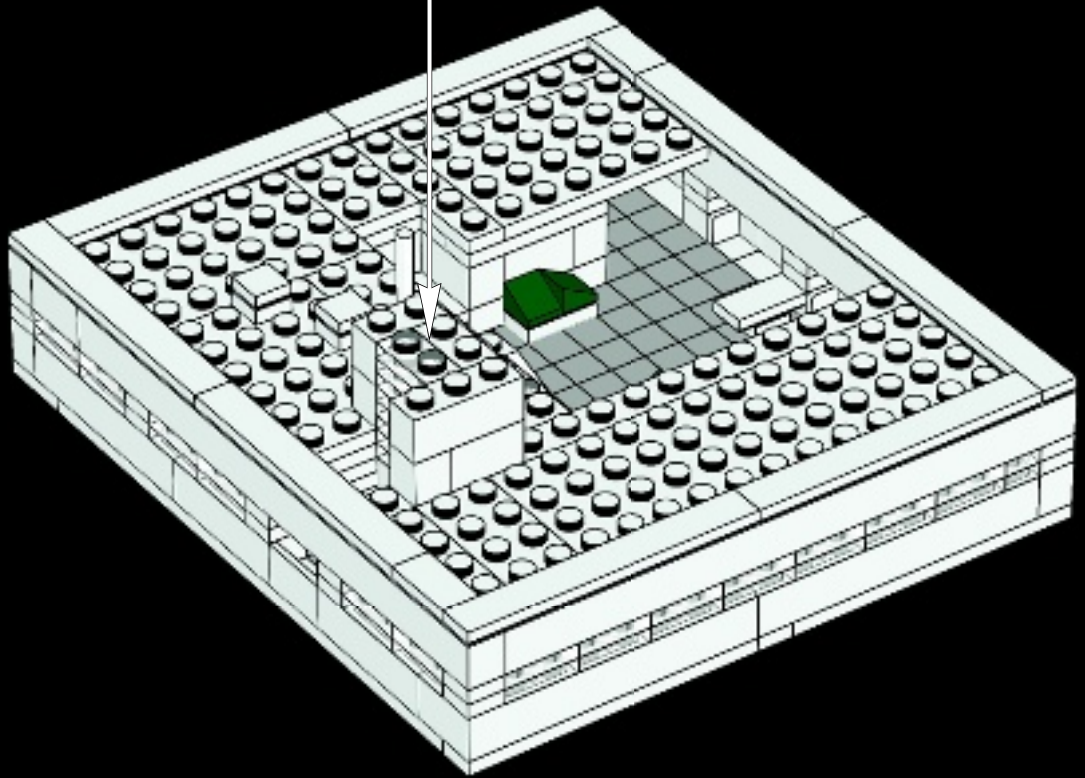



61

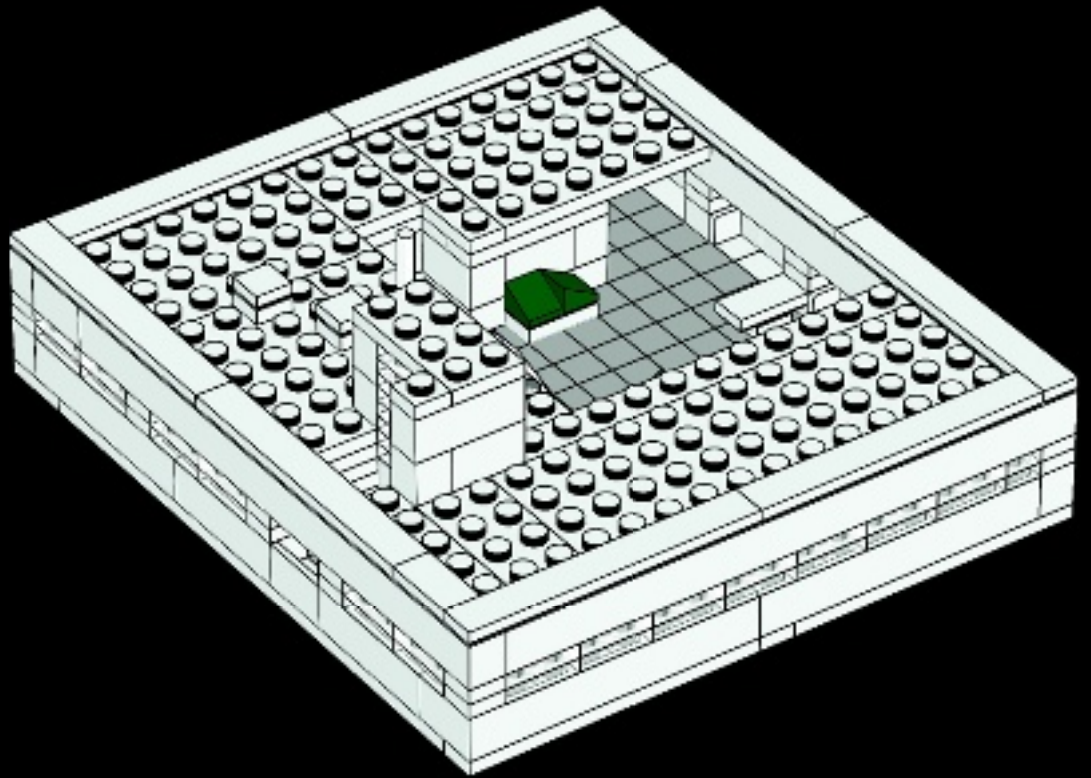



62

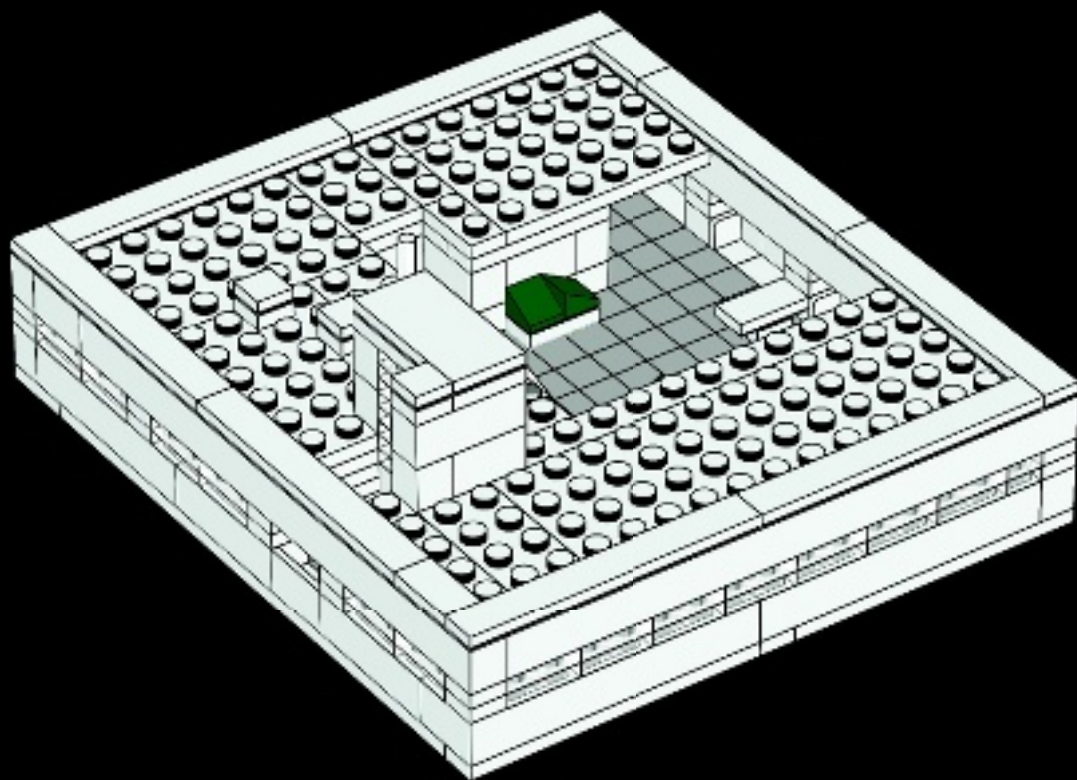



63

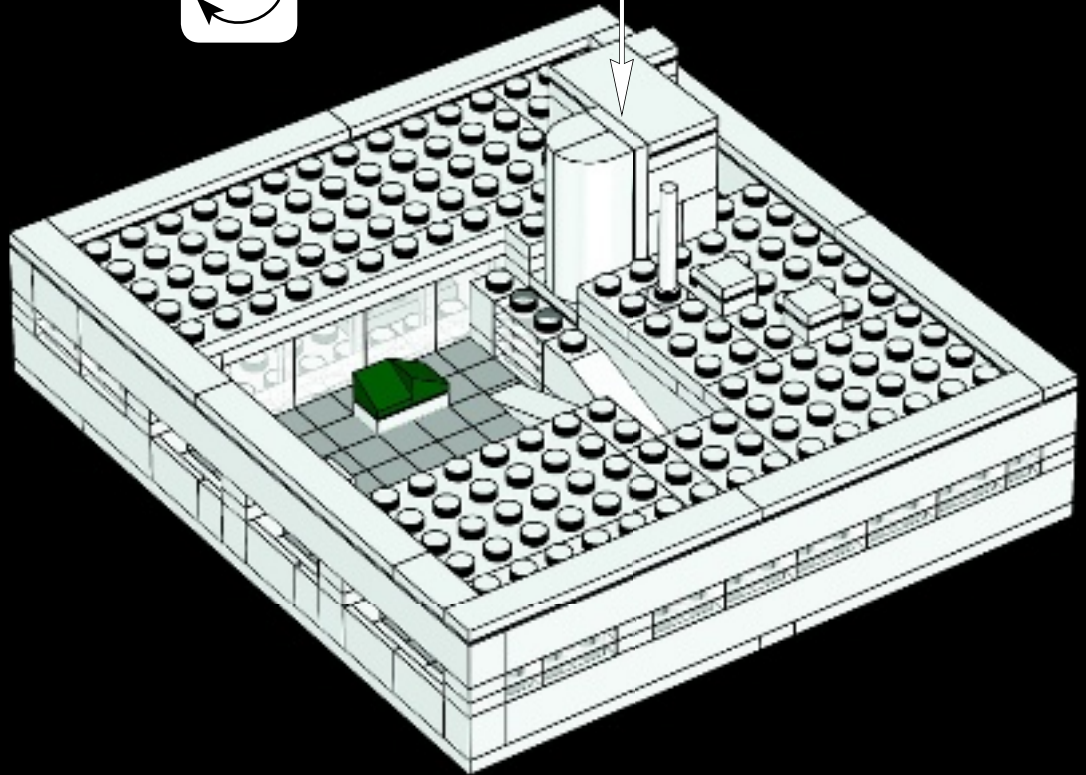
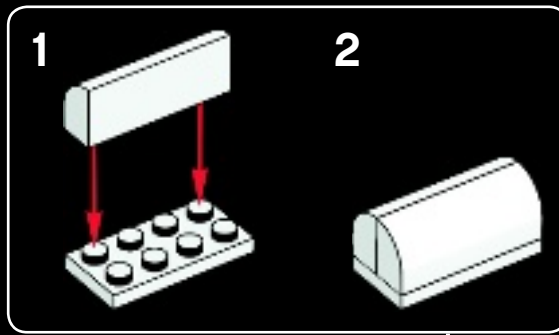





1x

64

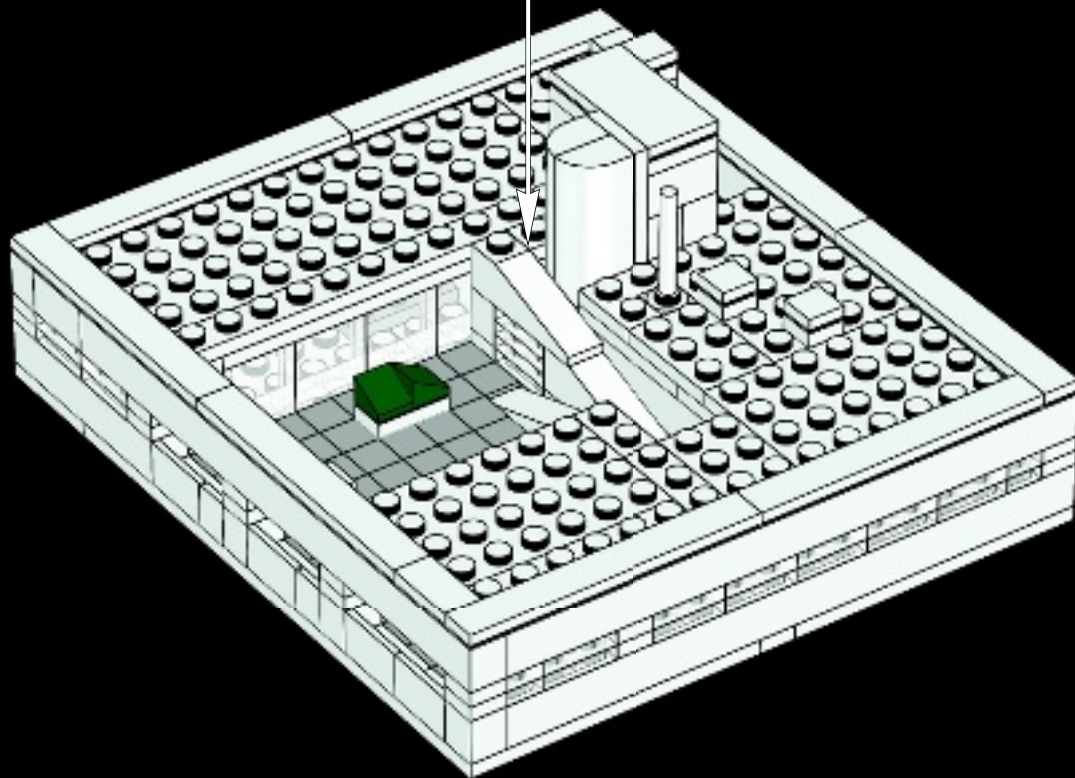



65

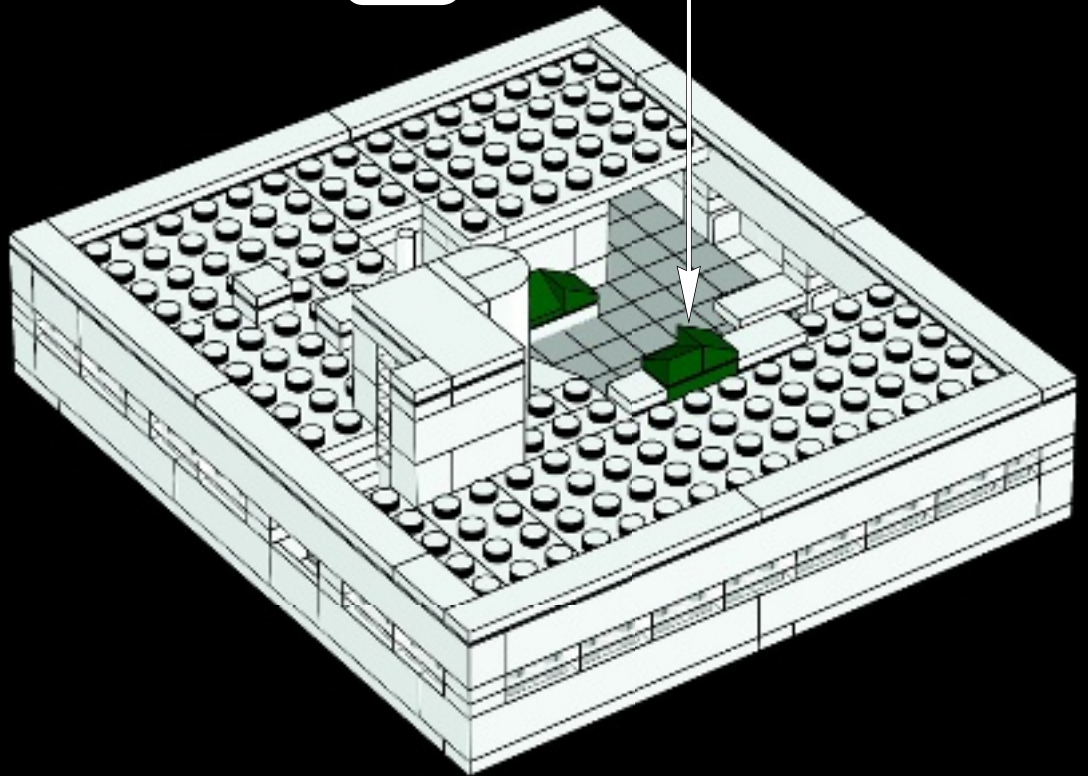
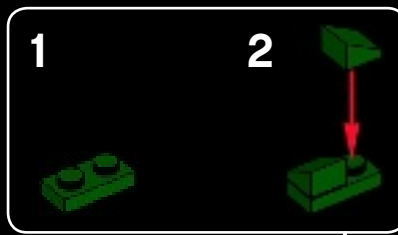



66

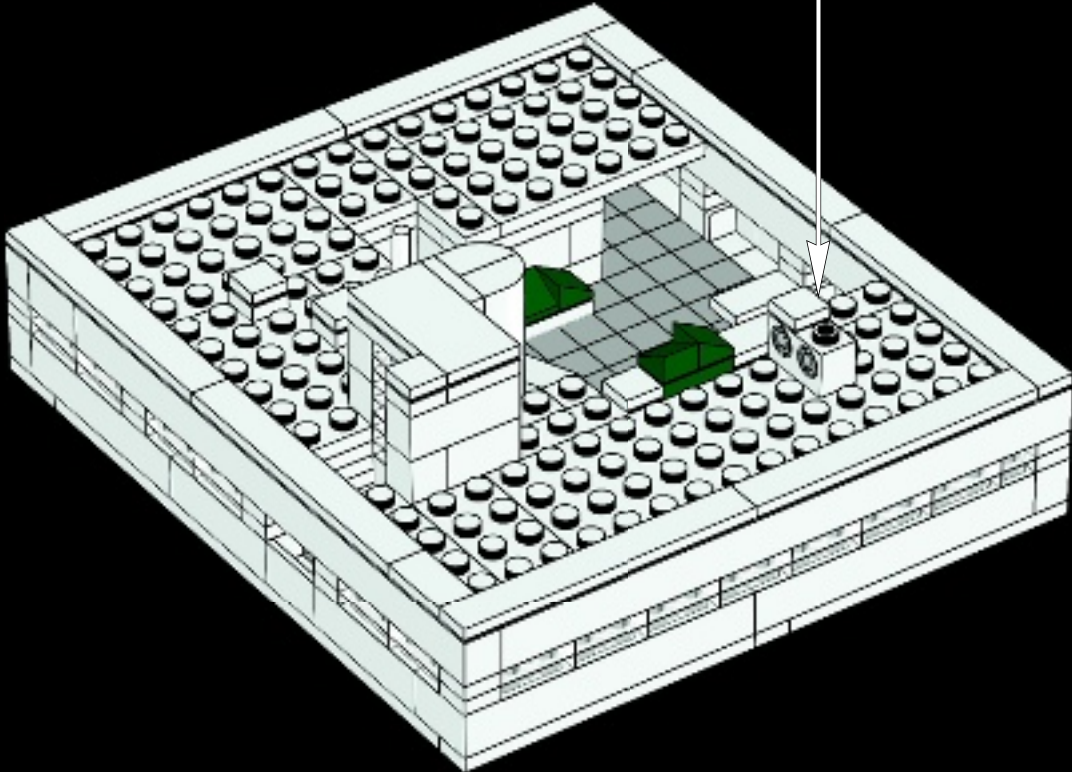
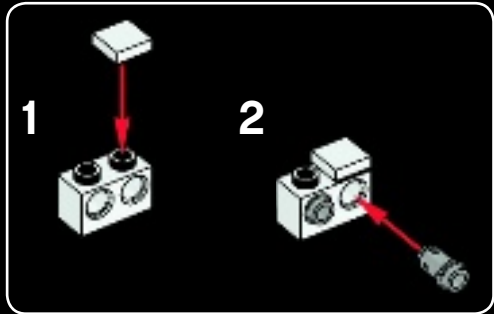



67

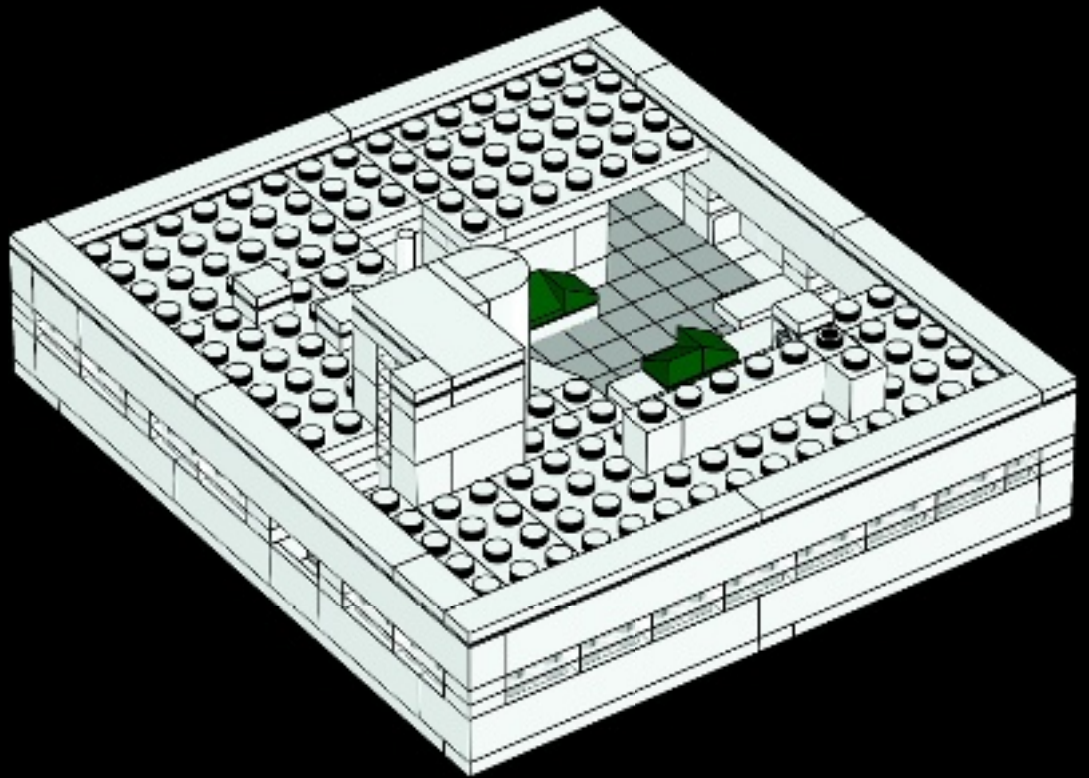





1x



1x



1x

# 68

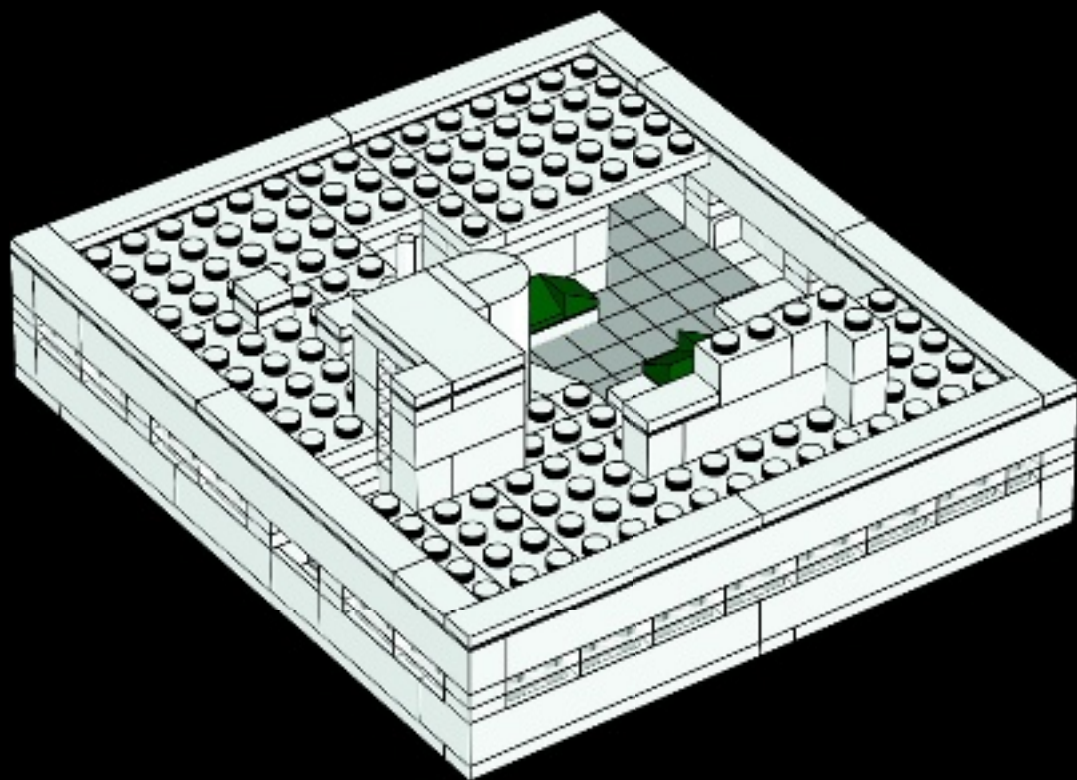



69

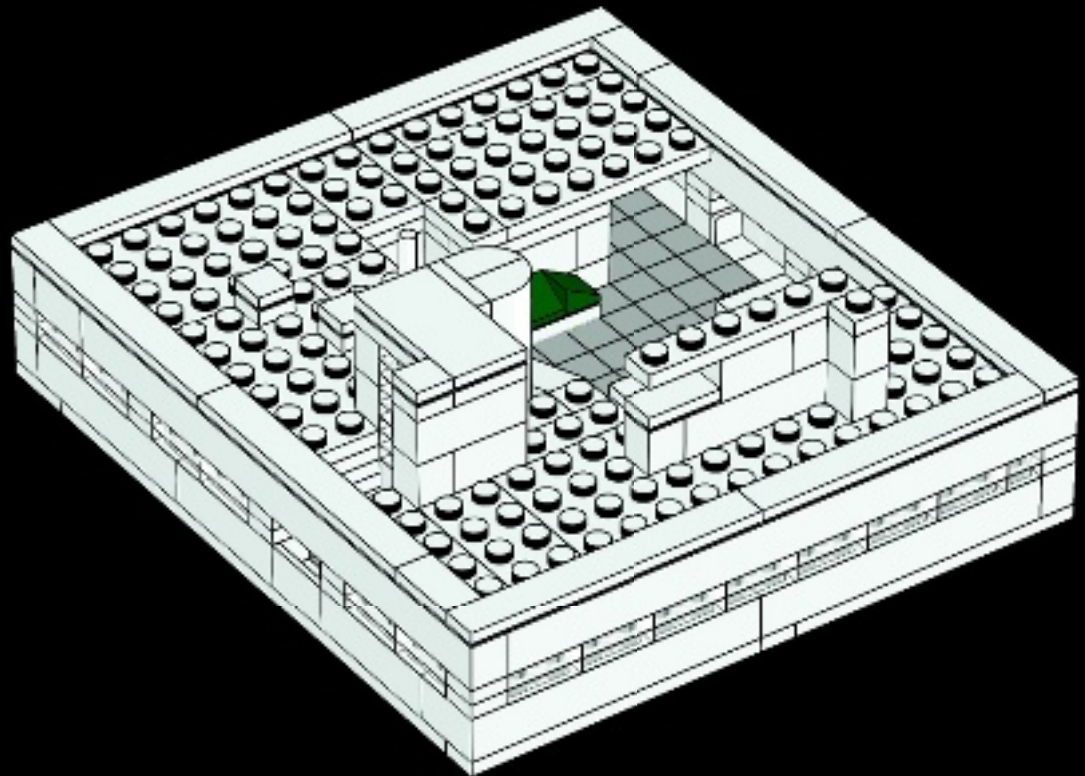

*Le Corbusier's ground plan for the villa was designed using the ratios of the golden section - a geometrical system of harmony and proportion first described by the ancient Greeks.*

*Le plan de Le Corbusier pour la villa fut élaboré en utilisant les principes de rapport du nombre d'or, un système géométrique d'harmonie et de proportion, décrit pour la première fois par les Grecs anciens.*

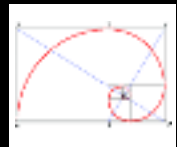

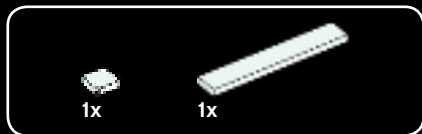

70

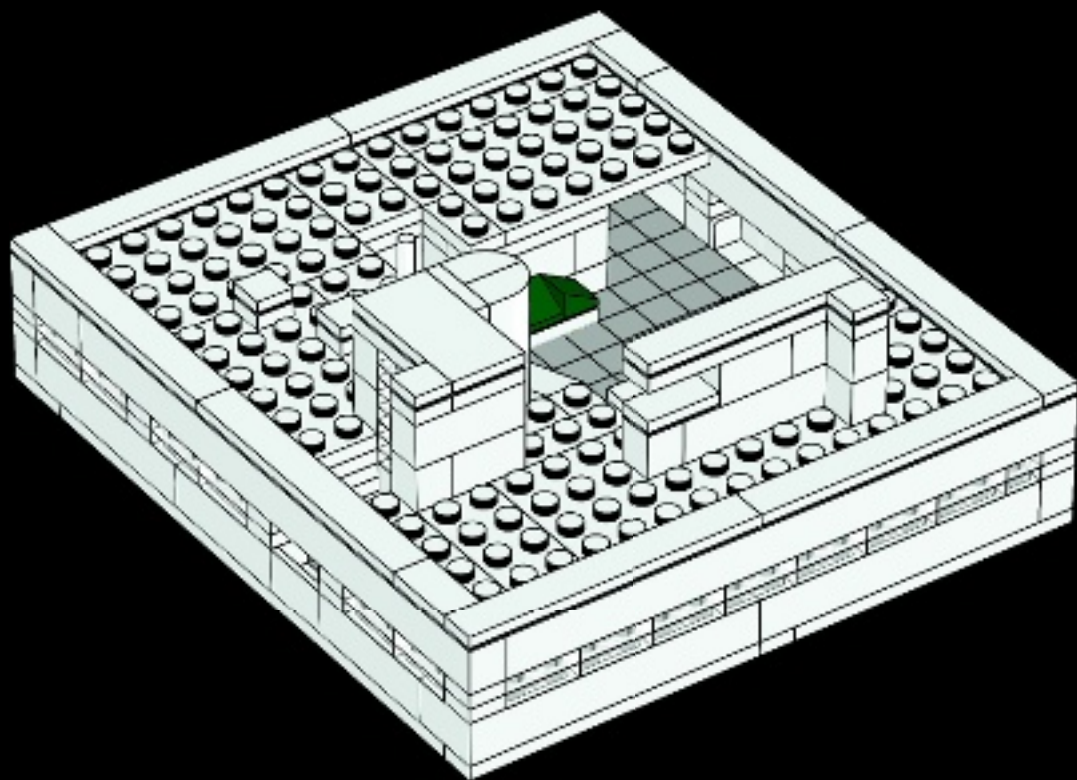

2x 1x 1x

71

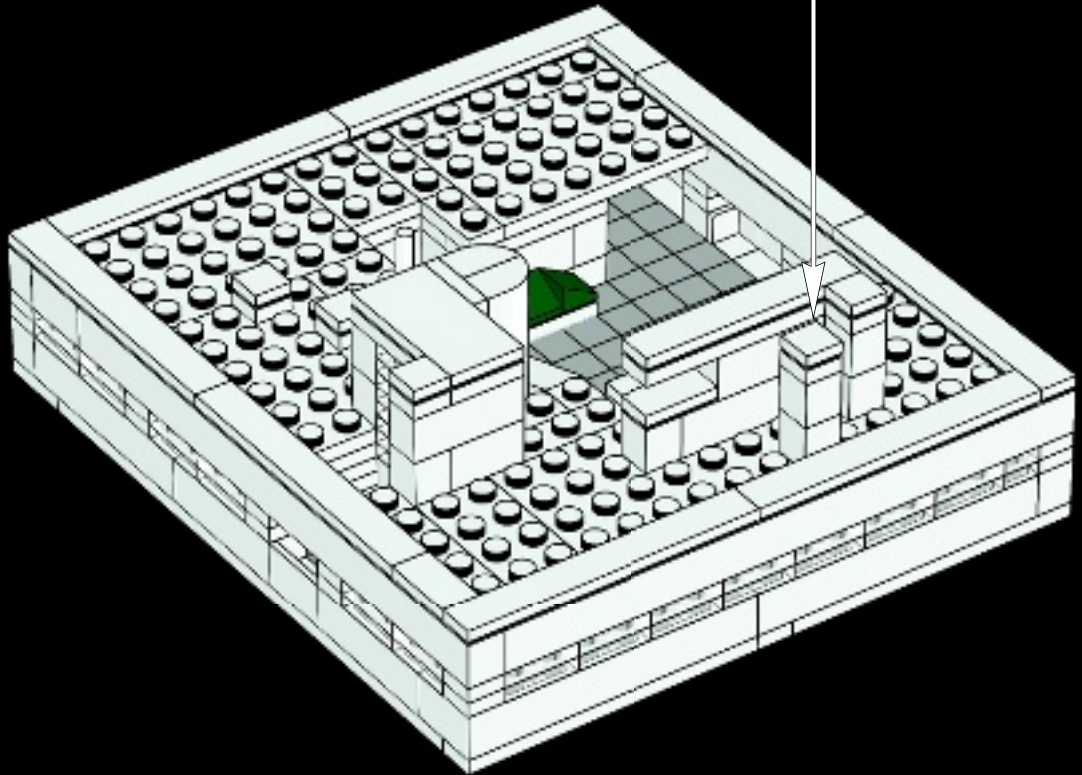
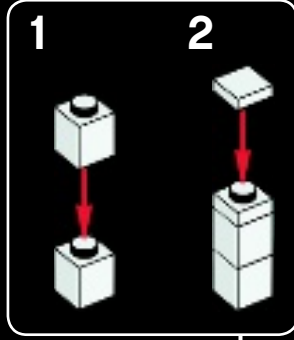





72

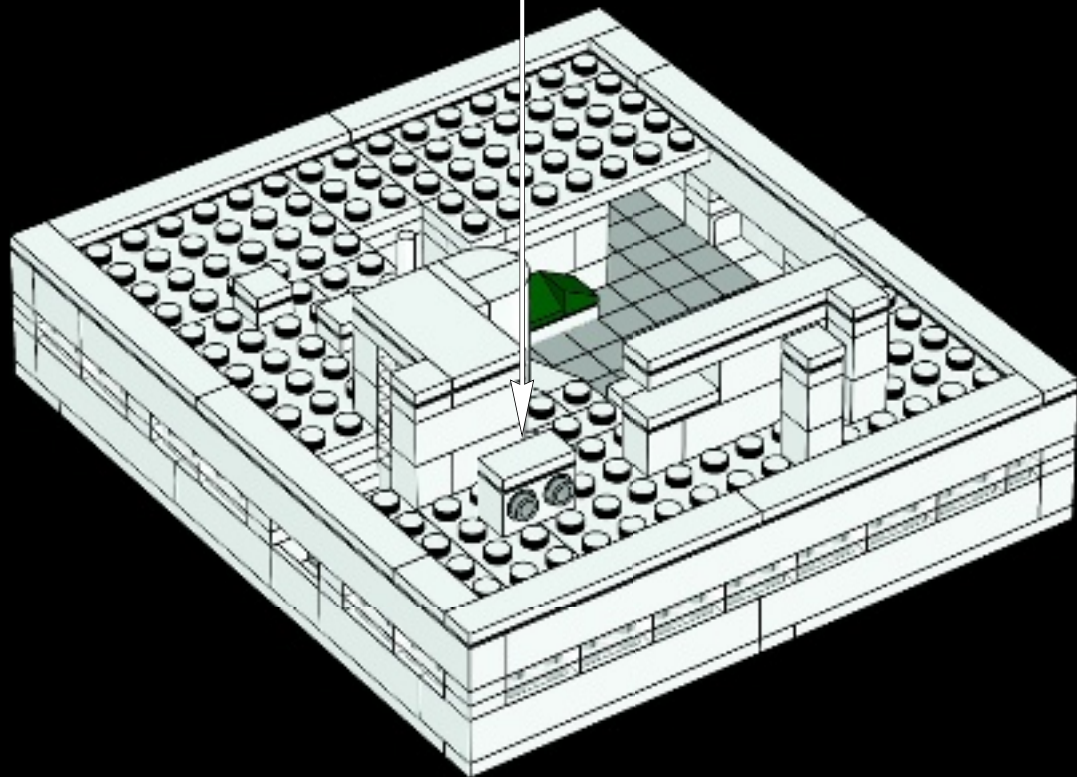
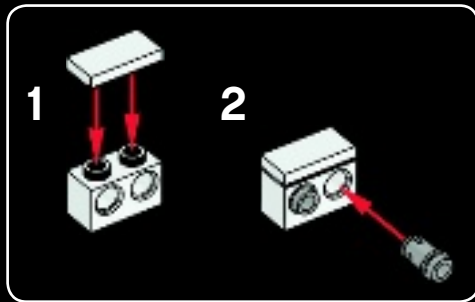



1

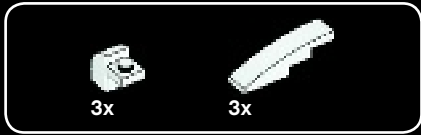

2

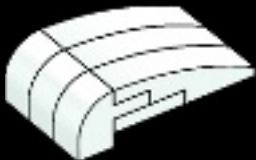
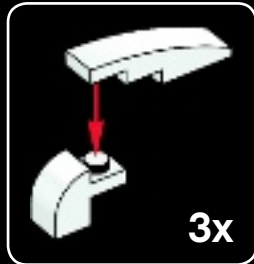

3

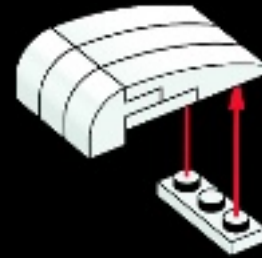

4

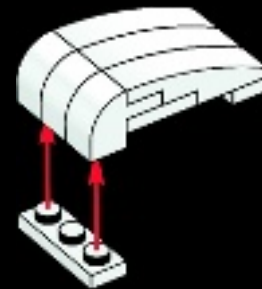



5

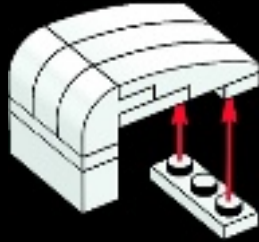

73

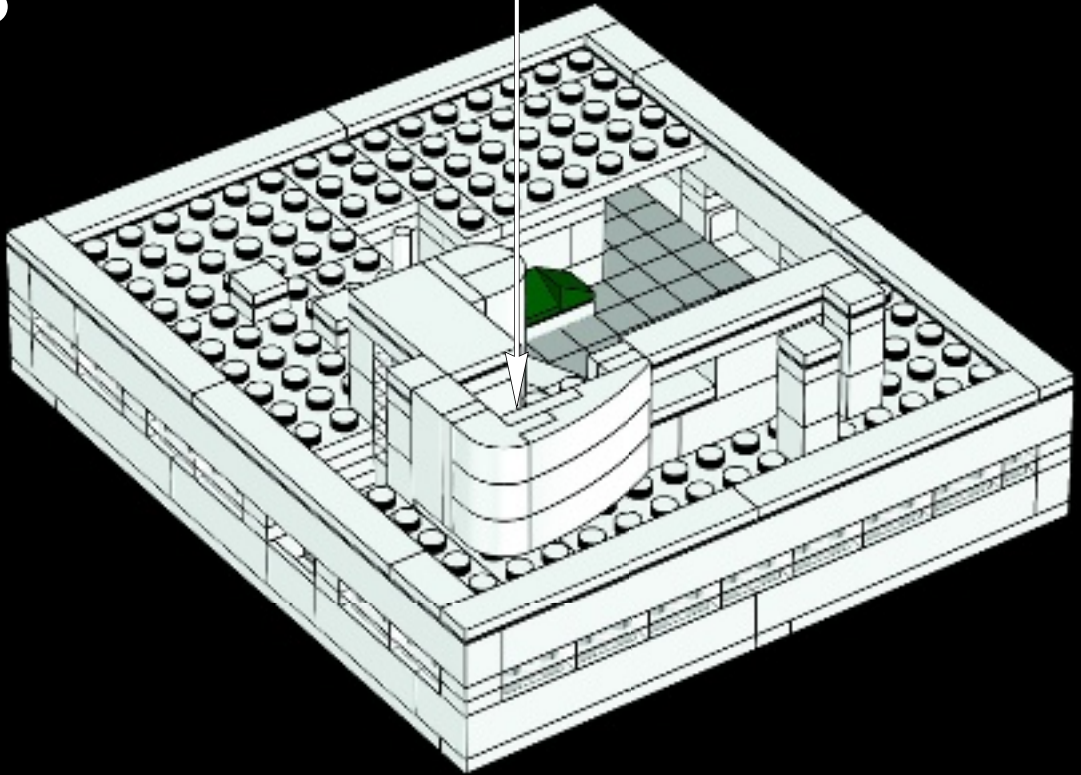



1



2

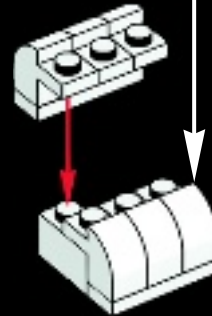
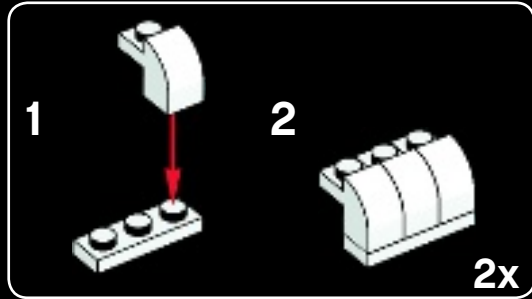





3

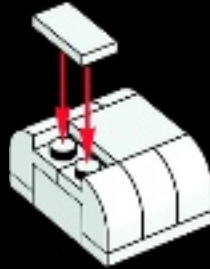

74

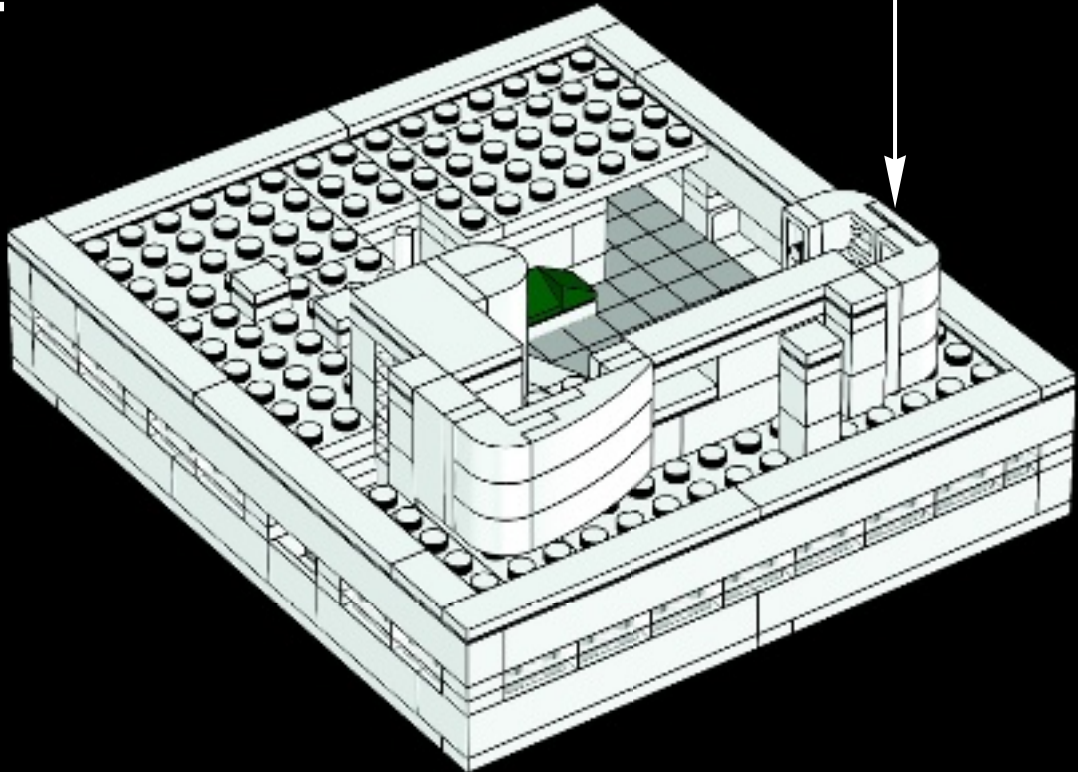

# 75

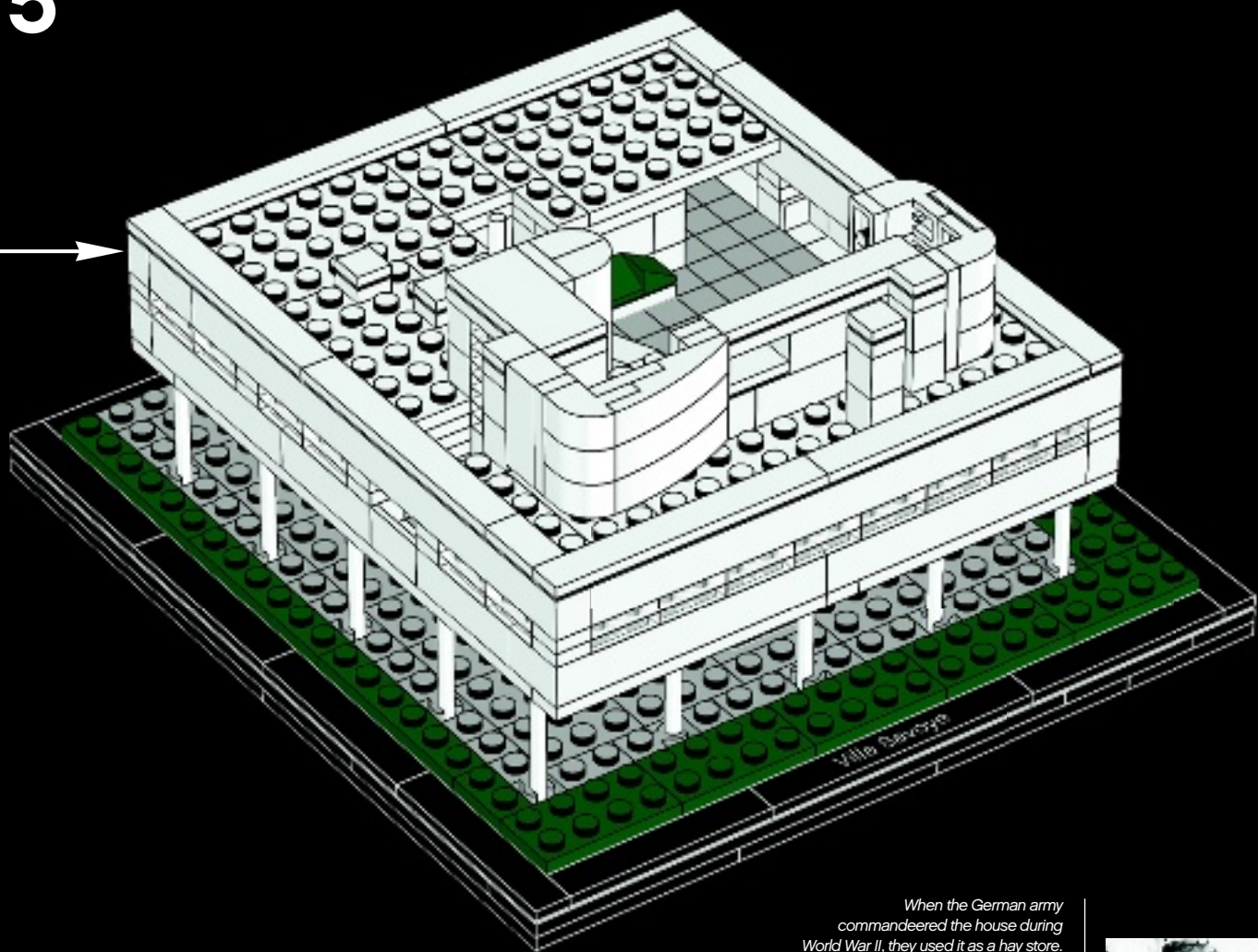

*When the German army commandeered the house during World War II, they used it as a hay store.*

*Lorsque la maison fut réquisitionnée par l'armée allemande pendant la Deuxième guerre mondiale, ils l'utilisèrent pour stocker du foin.*



© Fondation Le Corbusier

## A word from the artist

'Le Corbusier has always been an inspiration to me. His architecture is harmonious, well-balanced and coherent. His philosophy and his opus are timeless and yet still far ahead of his time at the same time.

One of the great examples of this work - and one of my favorites - is Villa Savoye: closed and seemingly impregnable from the exterior, open and organic from the interior. With this building he reached two contradicting characteristics at the same time: isolation from and relation to nature.

The biggest challenges of the LEGO model construction - which took more than 15 versions to reach its final state and included the help of most experienced designers from the LEGO team - were the pillars and the complex roof design.

At first I constructed the pillars from 1x1 round bricks, but they always seemed oversized. In the final version, after consulting with the LEGO design team, I used the blades from LEGO light sabers, which in turn presented another challenge when it came to anchoring them to the base plate. When attempting to construct the roof elements, I was amazed yet again by Le Corbusier's art: nothing is coincidental and every change in his design principals led to imbalance and disharmony in the model.'

## Un mot de l'artiste

« Le Corbusier a toujours été une inspiration pour moi. Son architecture est harmonieuse, bien équilibrée et cohérente. Sa philosophie et son ensemble d'œuvres sont novateurs et intemporels.

L'un des grands exemples de son travail, et l'un de mes préférés, est la Villa Savoye. Fermée et apparemment imprenable depuis l'extérieur, ouverte et organique depuis l'intérieur. Il réunit dans ce bâtiment deux caractéristiques contradictoires : l'isolation et la connexion avec la nature. »

Les plus grands défis pour la construction du modèle LEGO, qui demanda plus de 15 versions pour atteindre son état final et fit appel à l'aide des designers les plus expérimentés de l'équipe LEGO, ont été les colonnes et le design complexe du toit.

« J'ai d'abord construit les colonnes avec des briques rondes 1 x 1, mais elles semblaient toujours surdimensionnées. Dans la version finale et après avoir consulté l'équipe de design LEGO, j'ai utilisé les lames des sabres laser LEGO. Ceci présentait un autre défi lorsqu'il fallut les attacher à la plaque de base. Lorsque j'essayais de construire les éléments du toit, je fus une nouvelle fois frappé par l'art méticuleux de Le Corbusier : Rien n'est une coïncidence et tout changement dans ses principes de design entraînait

un déséquilibre et un manque d'harmonie du modèle. »

Le modèle de la Villa Savoye fut créé en collaboration étroite avec l'équipe de design LEGO. Ils purent examiner le modèle depuis le point de vue d'un bâtiment LEGO et s'assurer que le processus de construction est simple et logique. Ceci en fait une expérience positive pour l'utilisateur.





## The 'Scale Model' line - LEGO Architecture in the 1960s

The history of the current LEGO Architecture series can be traced back to the beginning of the 1960s when the LEGO brick's popularity was still steadily increasing. Godtfred Kirk Christiansen, the then owner of the company, began looking for ways to further expand the LEGO system, and asked his designers to come up with a set of new components that would add a new dimension to LEGO building.

Their answer was as simple as it was revolutionary: five elements that matched the existing bricks, but were only one third the height. These new building "plates" made it possible to construct more detailed models than before.

This greater LEGO flexibility seemed to match the spirit of the age; modernist architects were redefining how houses looked, and people were taking an active interest in the design of their dream homes. It was from these trends that the LEGO 'Scale Model' line was born in early 1962.

The name itself was a direct link to the way architects and engineers worked and it was hoped that they and

others would build their projects "to scale" in LEGO elements. As with LEGO Architecture today, the original sets were designed to be different from the normal brightly colored LEGO boxes, and also included 'An Architectural Book' for inspiration.

Though the five elements remain an integral part of the LEGO building system today, the 'Scale Model' line was phased out in 1965—it would be over 40 years before its principles would be revived in the LEGO Architecture series we know today.

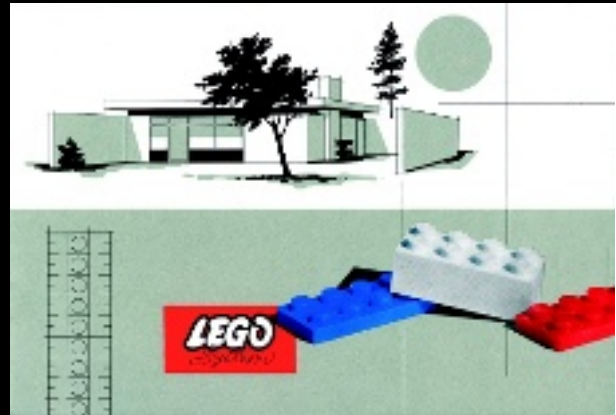

# La ligne des “maquettes à l'échelle” - L'architecture LEGO dans les années 1960

Le développement de la série LEGO Architecture actuelle remonte au début des années 1960 alors que la popularité de la brique LEGO augmentait régulièrement. À ce moment, l'entreprise appartenait à Godtfred Kirk Christiansen. Il recherchait des moyens d'étendre le système LEGO et demanda à ses designers de créer un ensemble de composants nouveaux qui pourraient ajouter une nouvelle dimension à la construction LEGO.

Leur réponse fut aussi simple que révolutionnaire : cinq éléments qui correspondaient aux briques actuelles, mais ne mesuraient qu'un tiers de la hauteur. Ces nouvelles « plaques » de construction permirent la construction de modèles avec plus de détails.

Cette plus grande flexibilité LEGO semblait correspondre aux tendances actuelles ; les architectes modernistes redéfinissaient la conception de l'habitation et les gens prenaient un rôle actif dans la conception de la maison de leurs rêves. Ces tendances conduisirent à l'introduction de la ligne de « maquettes à l'échelle » LEGO, née début 1962.

Le nom était lui-même un lien direct avec la façon dont

les architectes et les ingénieurs travaillaient et on espérait qu'ils allaient construire leurs projets « à l'échelle » avec des éléments LEGO.

Comme avec LEGO Architecture aujourd'hui, les ensembles originaux étaient conçus pour être différents des boîtes LEGO normales aux couleurs vives, et incluaient aussi « Un livret d'architecture » comme source d'inspiration.

Les cinq éléments font toujours partie du système de construction LEGO actuel, mais la ligne « Maquette à l'échelle » fut interrompue en 1965. Il fallut plus de 40 ans pour que ses principes reprennent vie dans la série LEGO Architecture que nous connaissons aujourd'hui.

# Architect series

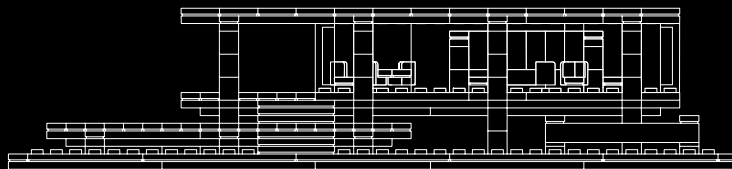
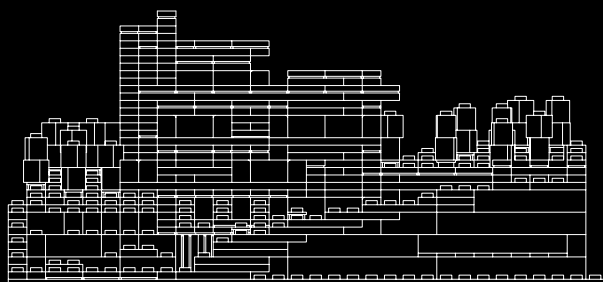
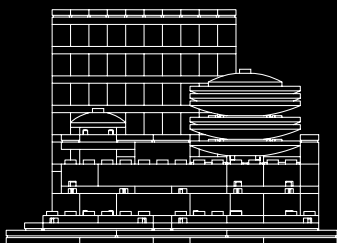

# Landmark series

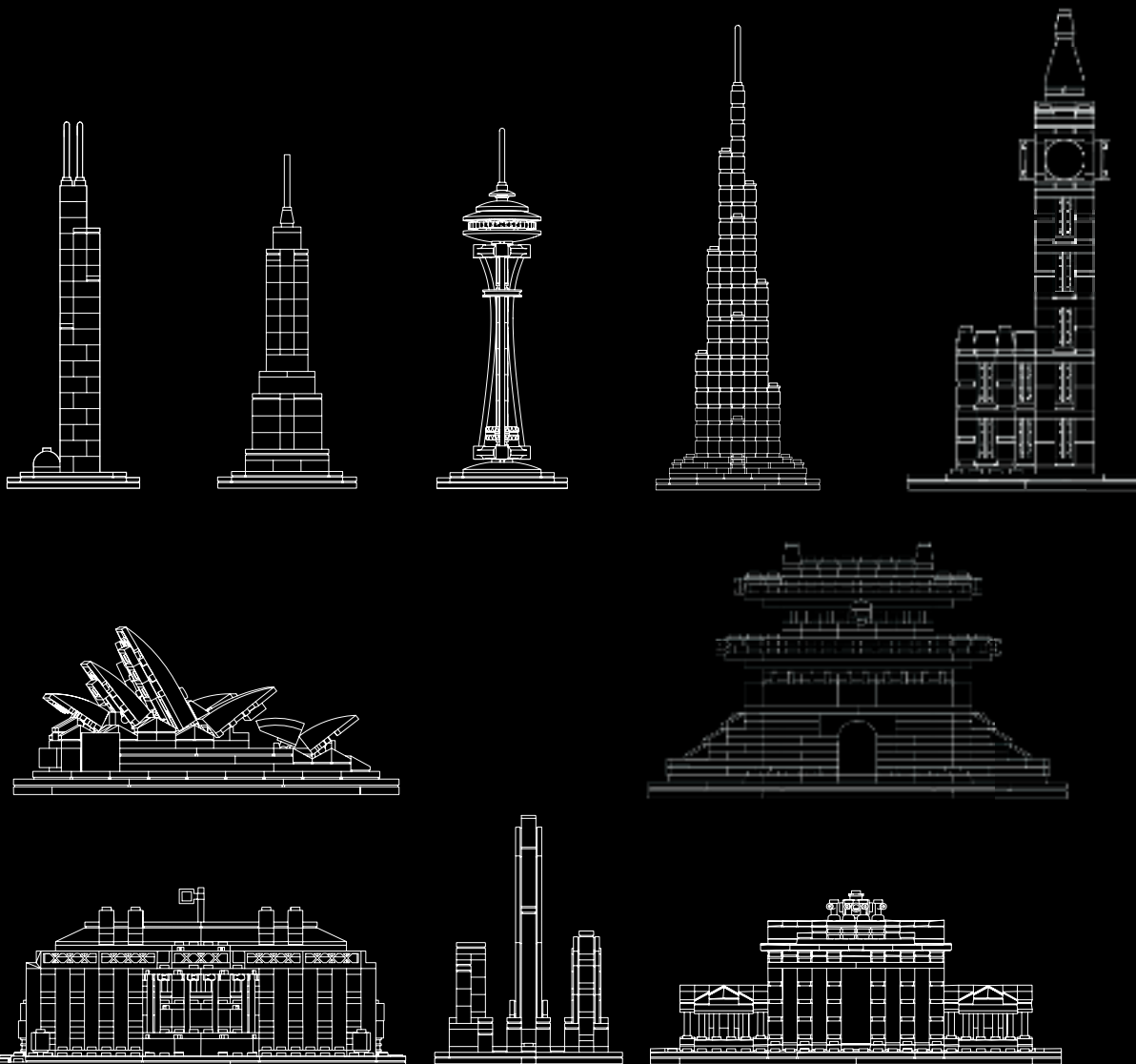



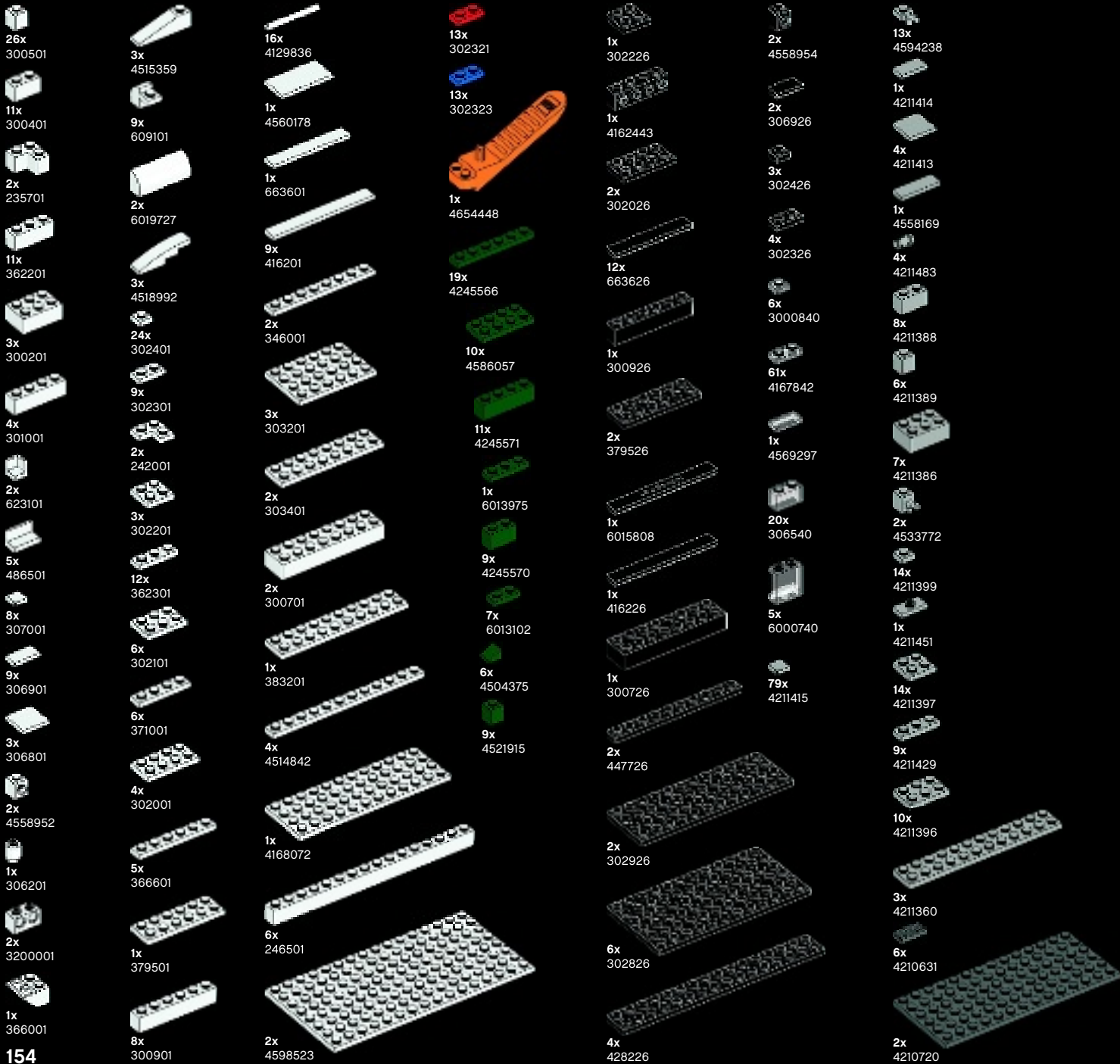

26x 300501  
 11x 300401  
 2x 235701  
 11x 362201  
 3x 300201  
 4x 301001  
 2x 623101  
 5x 486501  
 8x 307001  
 9x 306901  
 3x 306801  
 2x 4558952  
 1x 306201  
 2x 3200001  
 1x 366001

3x 4515359  
 9x 609101  
 2x 6019727  
 3x 4518992  
 24x 302401  
 9x 302301  
 2x 242001  
 3x 302201  
 12x 362301  
 6x 302101  
 6x 371001  
 4x 302001  
 5x 366601  
 1x 379501  
 8x 300901

16x 4129836  
 1x 4560178  
 1x 663601  
 9x 416201  
 2x 346001  
 3x 303201  
 2x 303401  
 2x 300701  
 1x 383201  
 4x 4514842  
 1x 4168072  
 6x 246501  
 2x 4598523

13x 302321  
 13x 302323  
 1x 4654448  
 19x 4245566  
 10x 4586057  
 11x 4245571  
 1x 6013975  
 9x 4245570  
 7x 6013102  
 6x 4504375  
 9x 4521915

1x 302226  
 1x 4162443  
 2x 302026  
 12x 663626  
 1x 300926  
 2x 379526  
 1x 6015808  
 1x 416226  
 1x 300726  
 2x 447726  
 2x 302926  
 6x 302826  
 4x 428226

2x 4558954  
 2x 306926  
 3x 302426  
 4x 302326  
 6x 3000840  
 61x 4167842  
 1x 4569297  
 20x 306540  
 5x 6000740  
 79x 4211415

13x 4594238  
 1x 4211414  
 4x 4211413  
 1x 4558169  
 4x 4211483  
 8x 4211388  
 6x 4211389  
 7x 4211386  
 2x 4533772  
 14x 4211399  
 1x 4211451  
 14x 4211397  
 9x 4211429  
 10x 4211396  
 3x 4211360  
 6x 4210631  
 2x 4210720

## References: Références :

*Sbriglio, Jacques, (1999) Le Corbusier: La Villa Savoye/The Villa Savoye, Fondation Le Corbusier, Paris. Birkhäuser.*

*Benton, Tim (1987). The Villas of Le Corbusier. New Haven and London: Yale University Press.*

*Curtis, William J R (2006). Le Corbusier - Ideas and Forms. London & New York: Phaidon Press.*

[www.wikipedia.org/wiki/Villa\\_Savoye](http://www.wikipedia.org/wiki/Villa_Savoye)

Customer Service  
Kundenservice  
Service Consommateurs  
Servicio Al Consumidor  
[www.lego.com/service](http://www.lego.com/service) or dial



00800 5346 5555 :

1-800-422-5346 :



Architecture

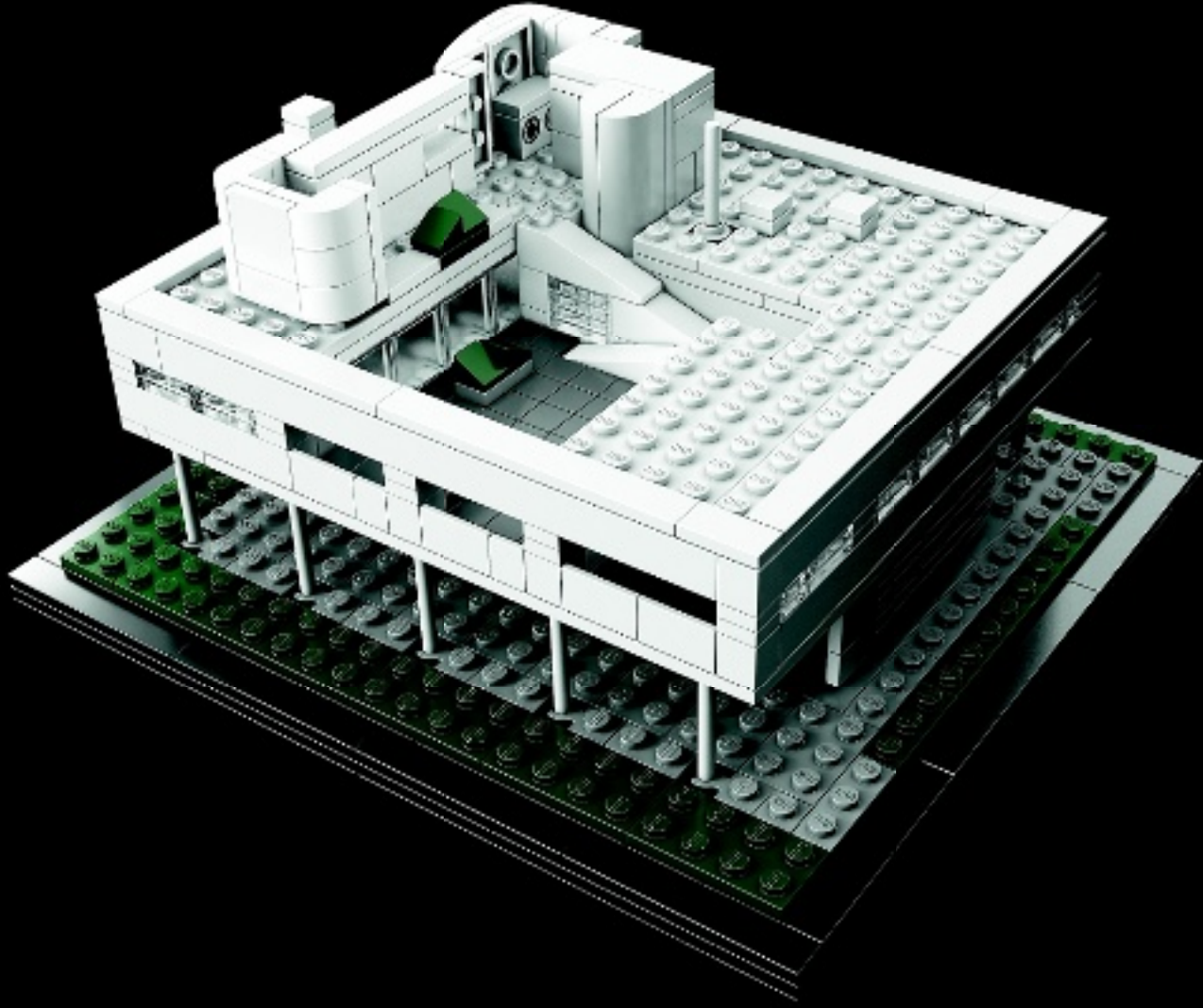

LEGO and the LEGO logo are trademarks of the LEGO Group. ©2012 The LEGO Group. 6039461