



# THE HOBBIT™

THE BATTLE OF THE FIVE ARMIES

79018



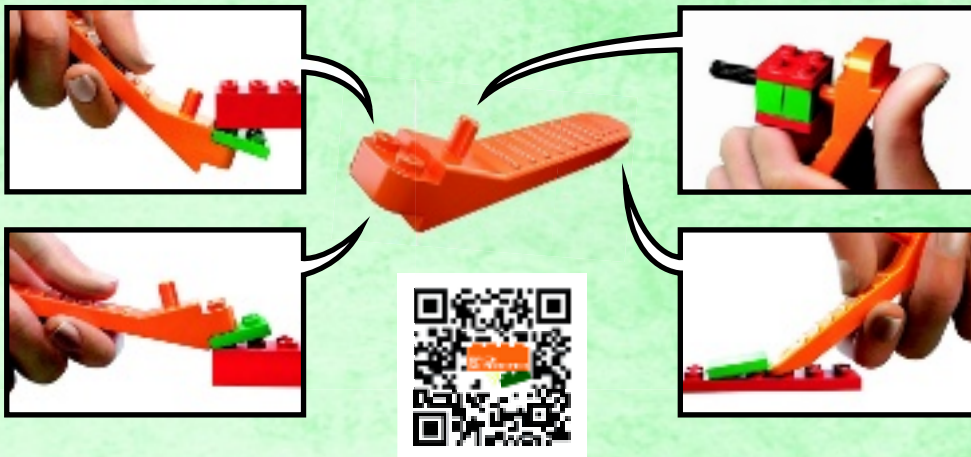



1

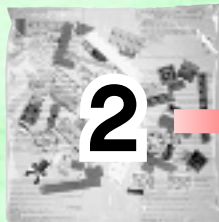

2

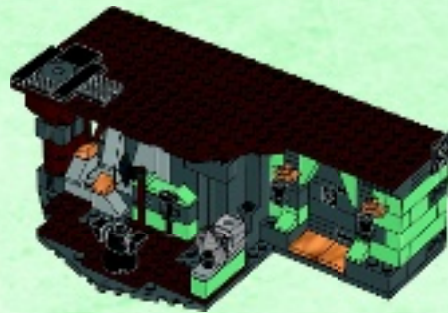

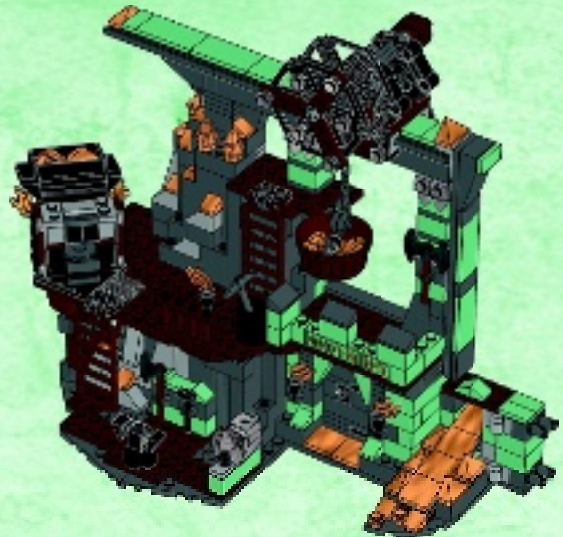
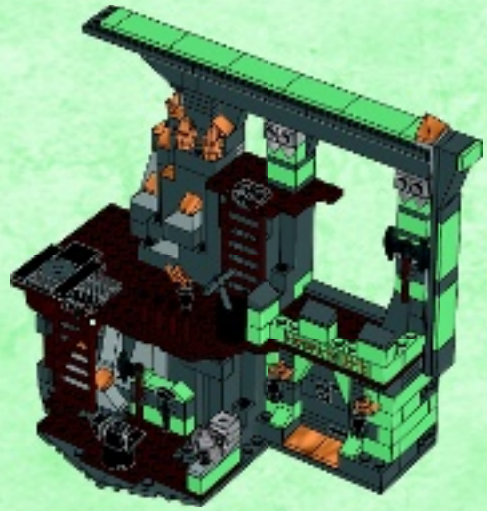

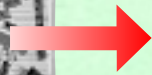
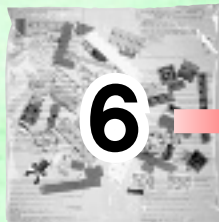
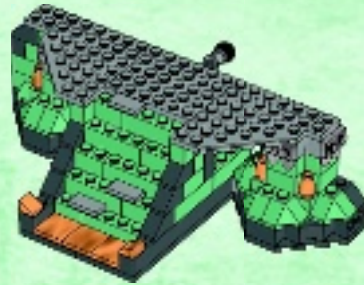

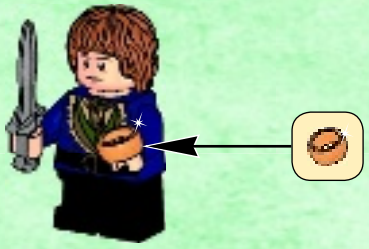
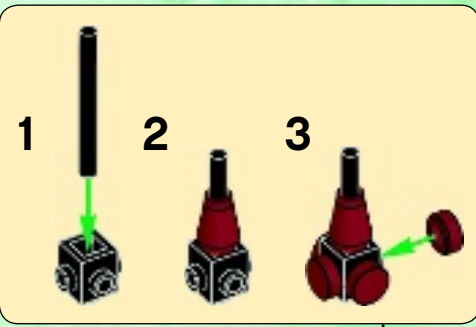

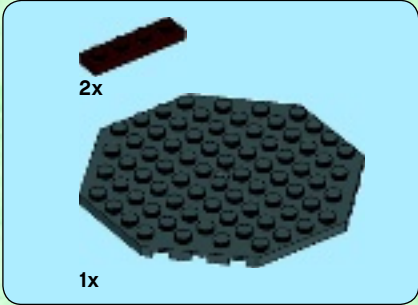

1



2

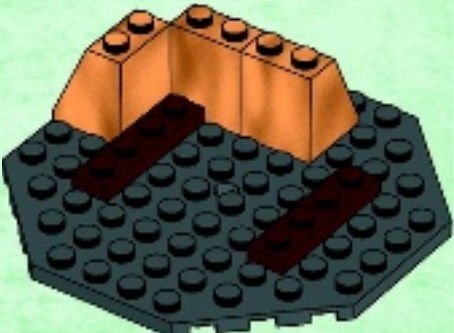

3

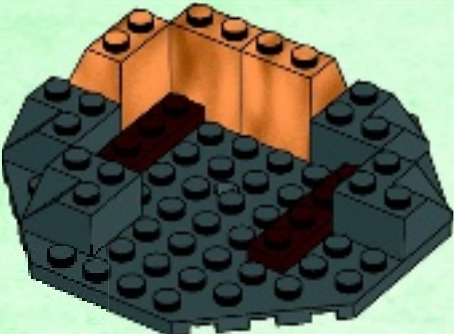

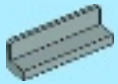

2x

4

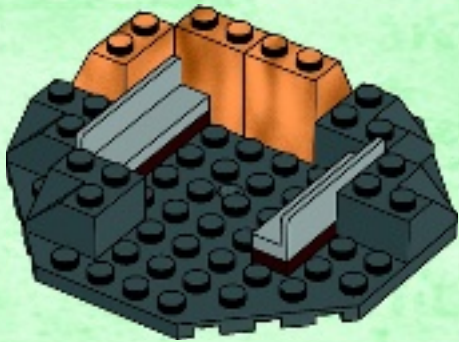

3x

5

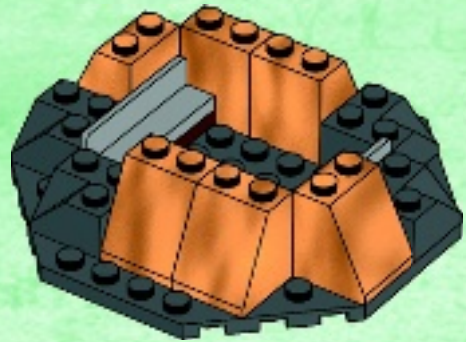





6x

6



6x

7





6x

8



1x



1x

9





1x



1x

1



1x

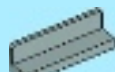

2x

2

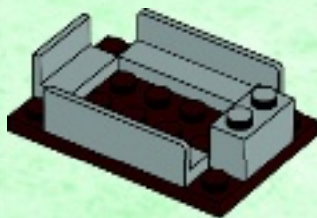

4x



1x



1x



1x

3



1x

4





4x

5

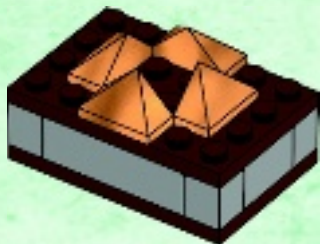

1x



1x

6



10



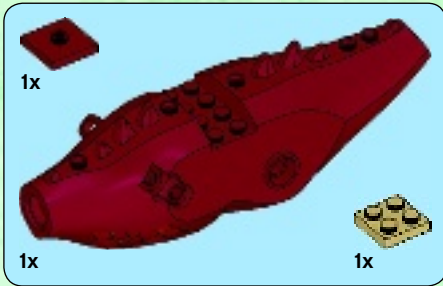
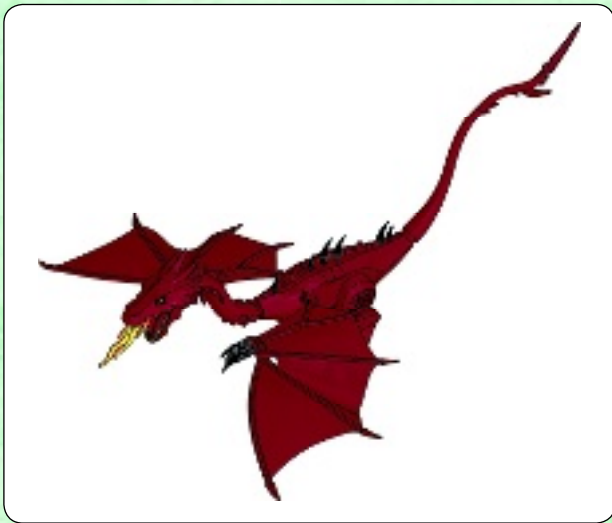

1

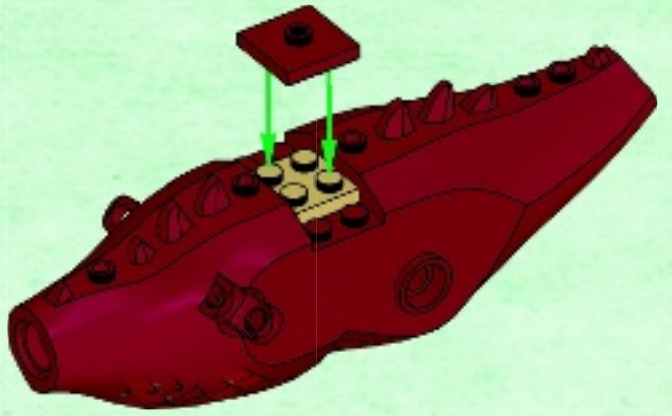



4x

2

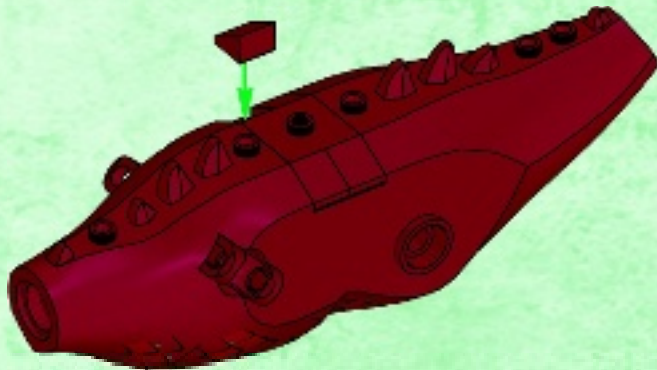

3x



3x

3



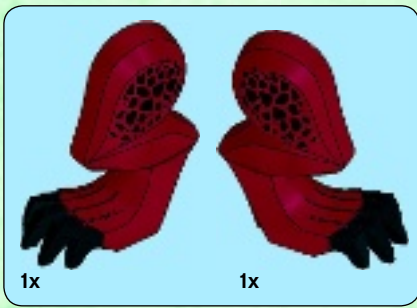

4

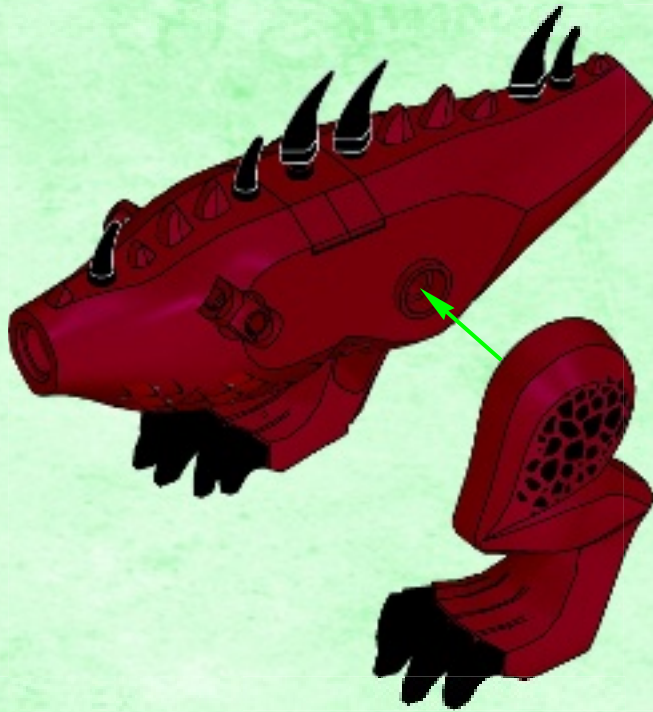



5







6





7

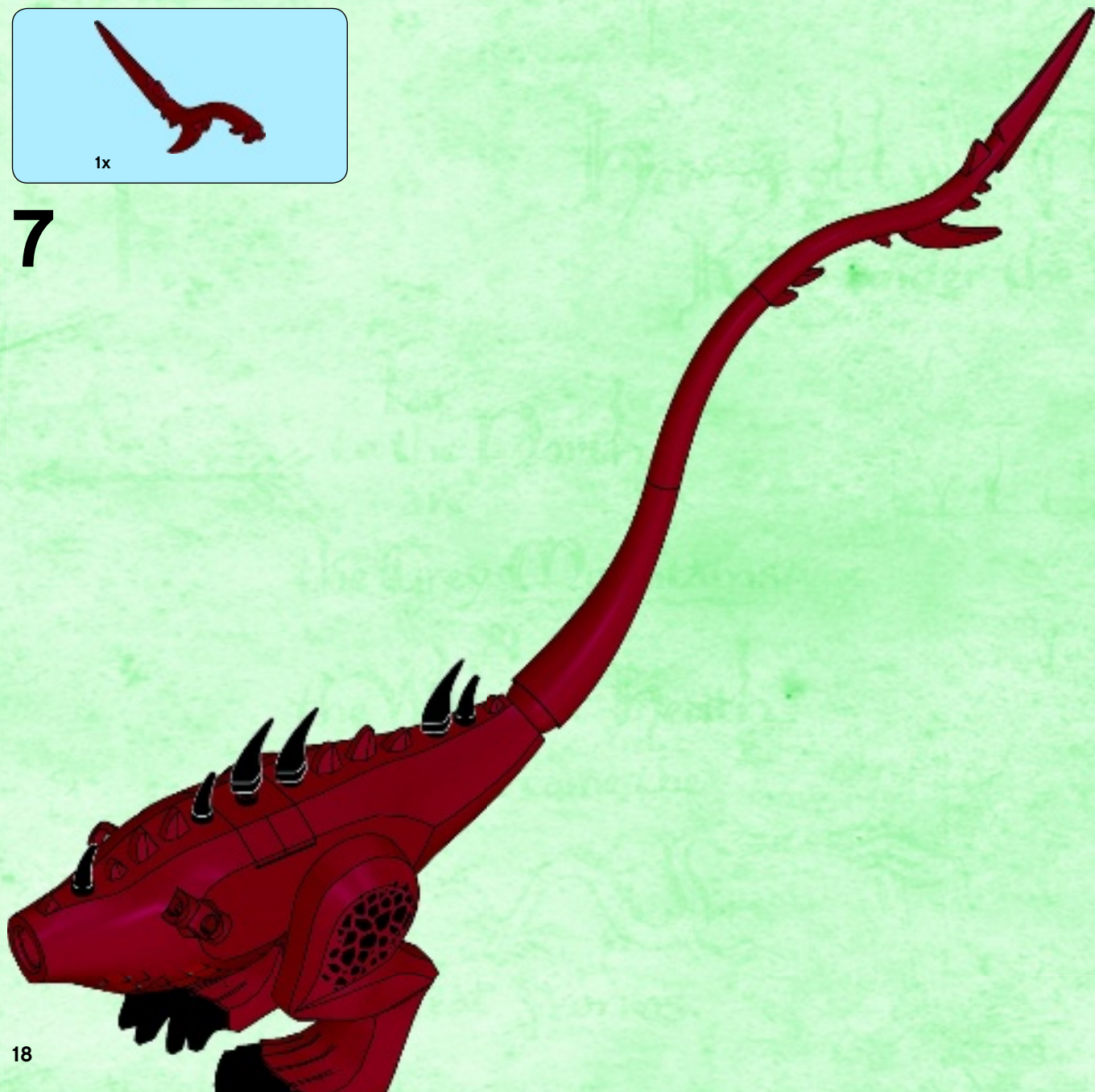

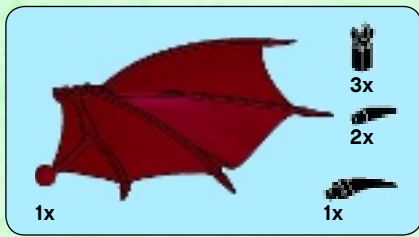

8

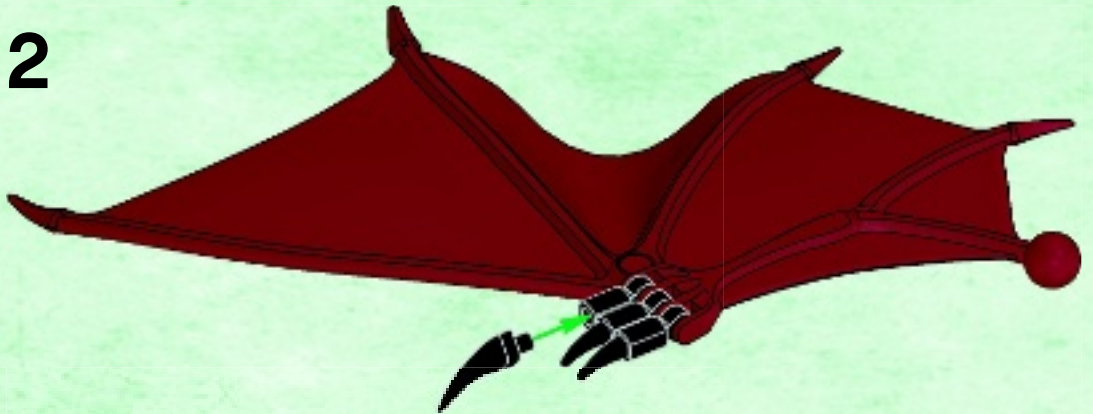
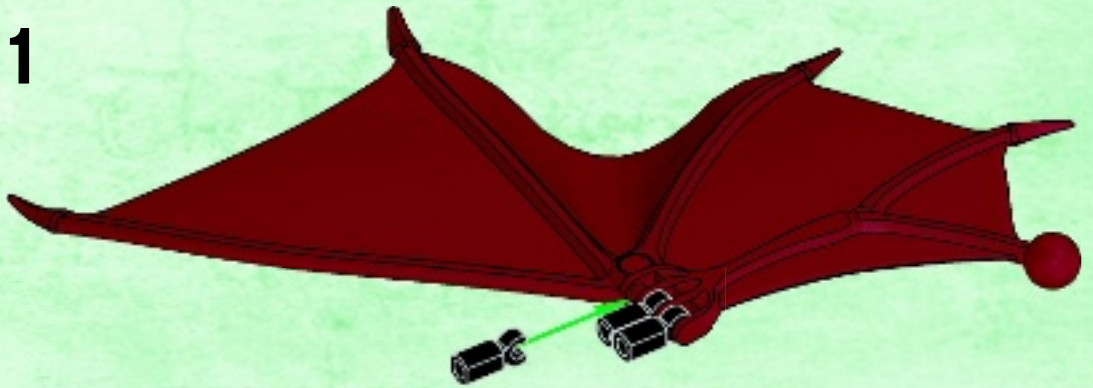

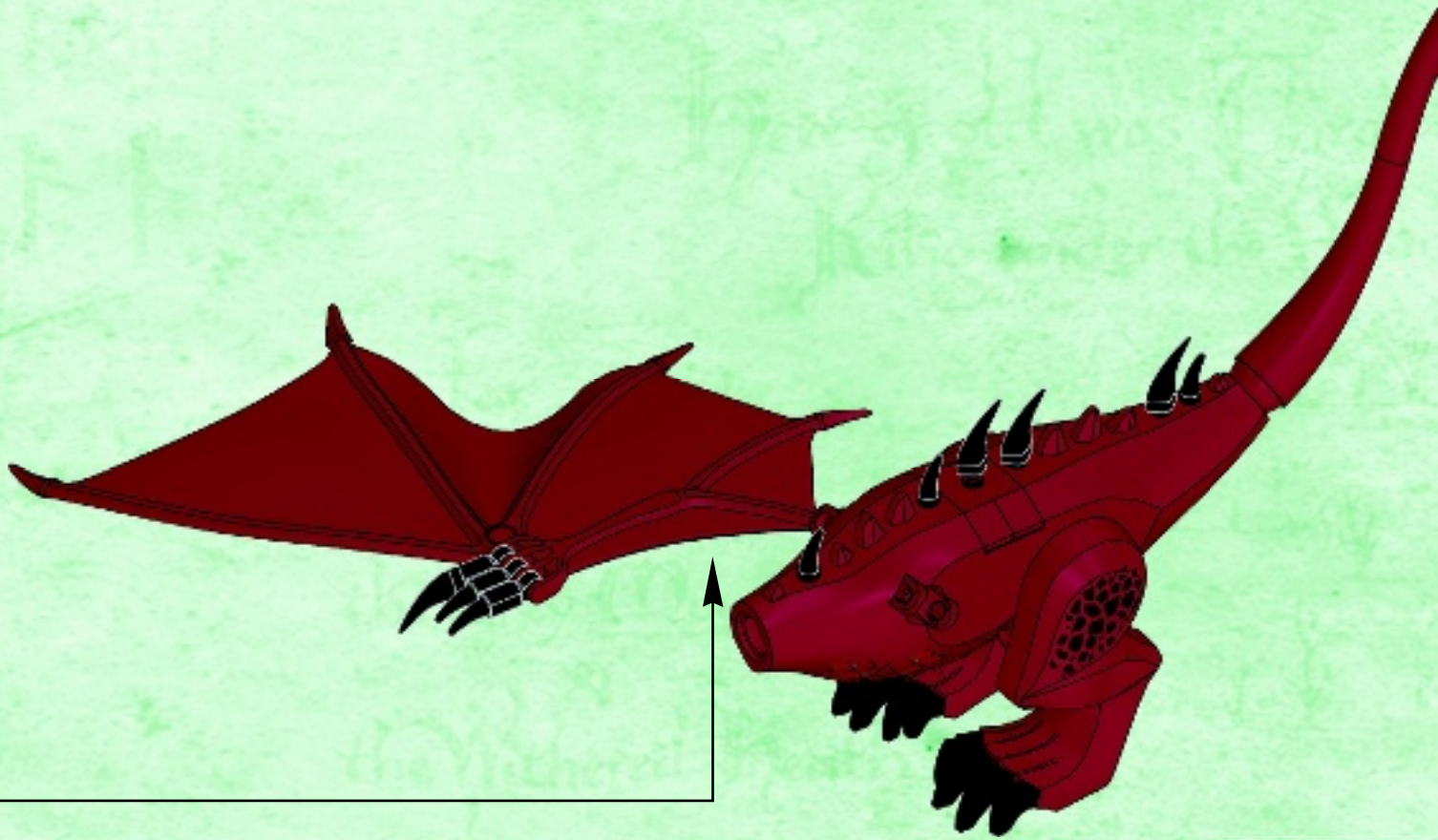

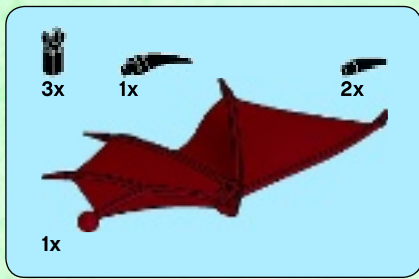

9

1

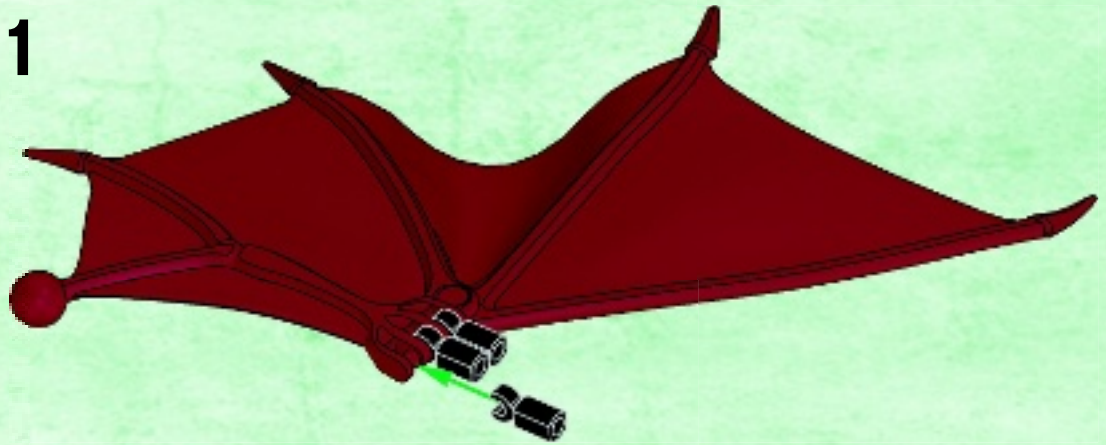

2



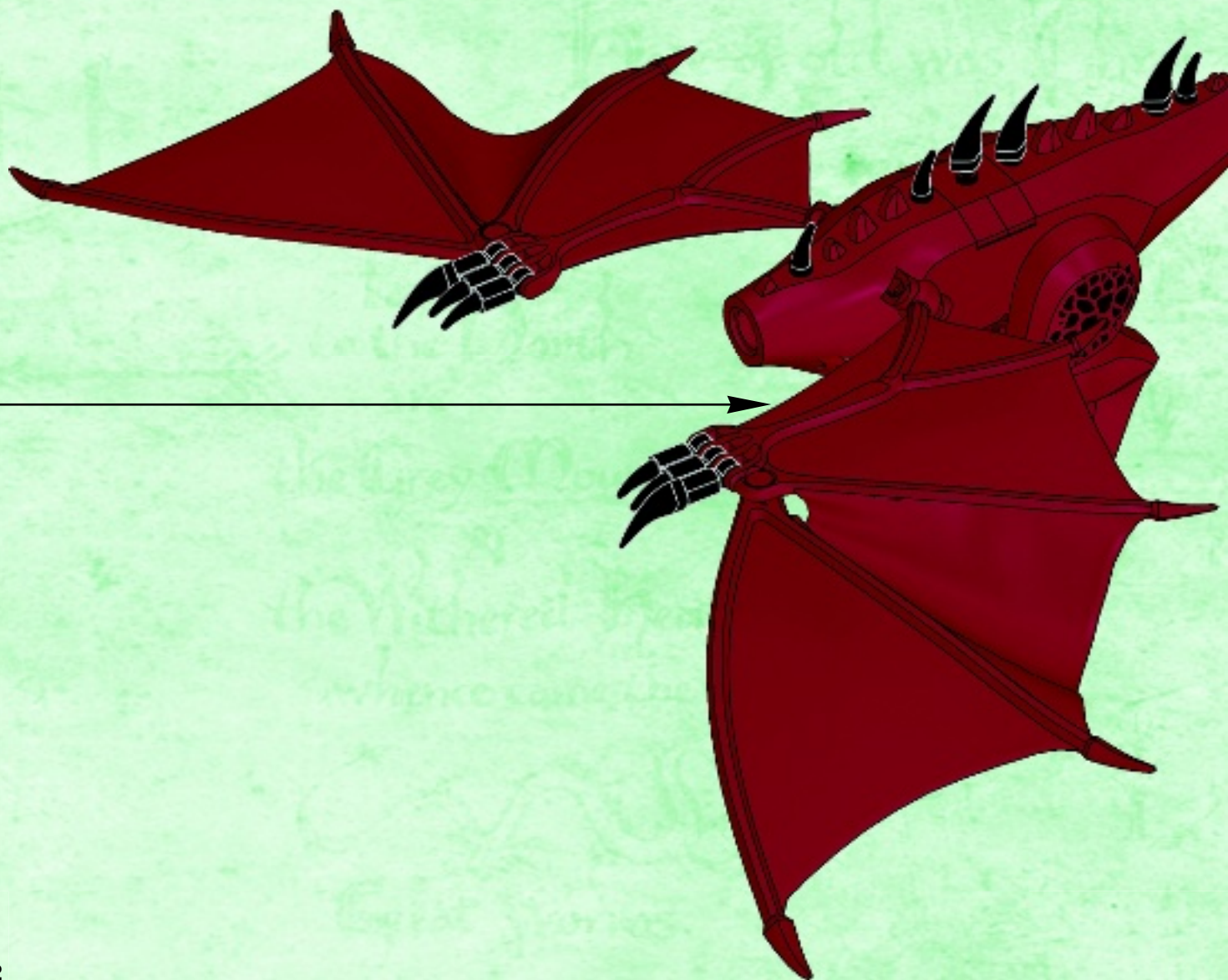

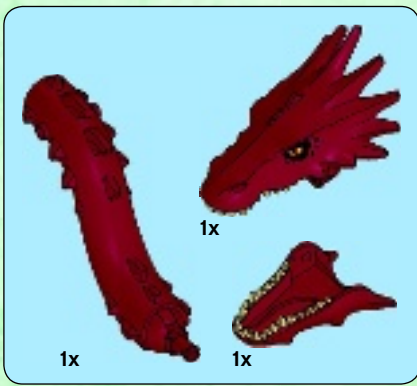

10

1



2



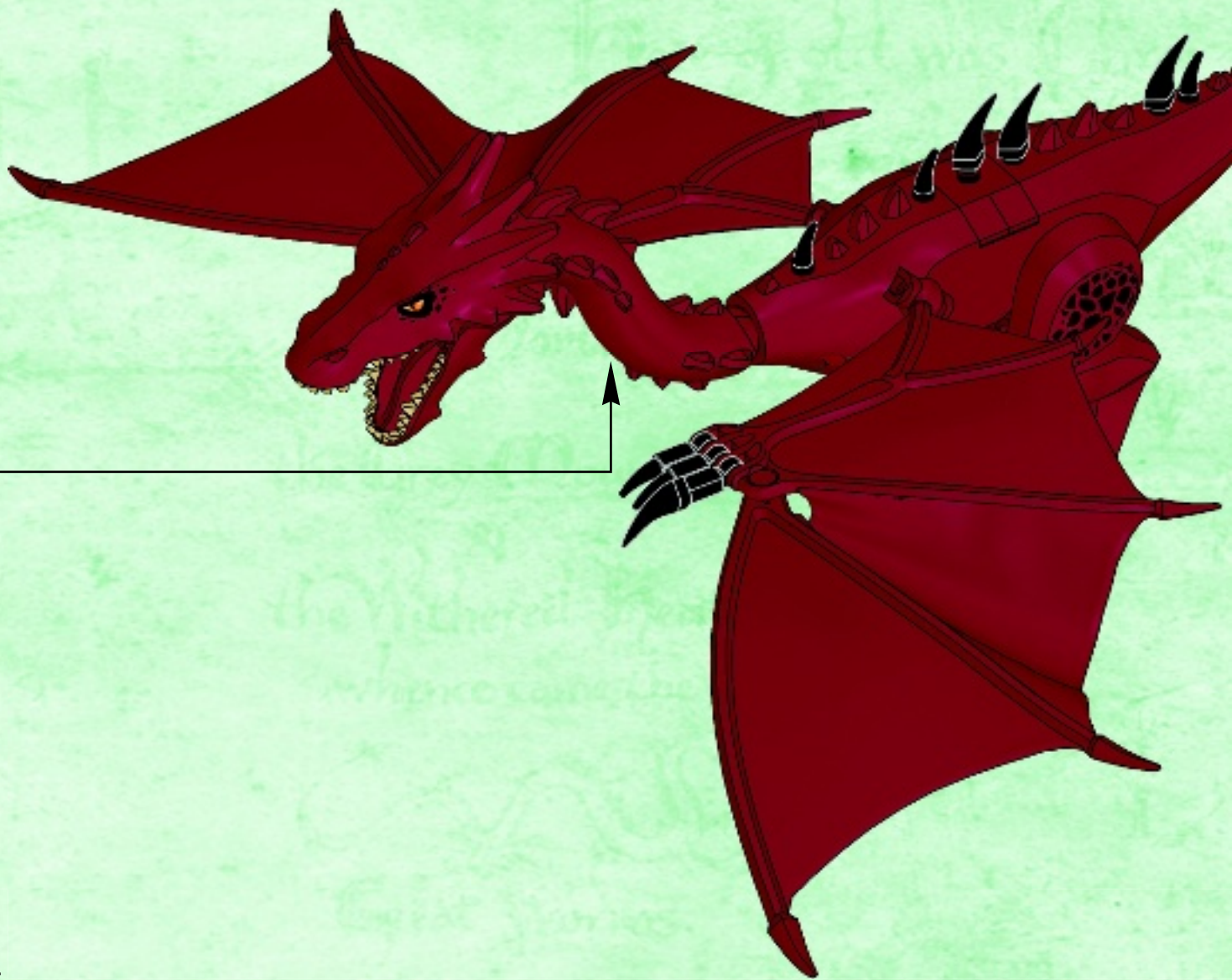





1x

11



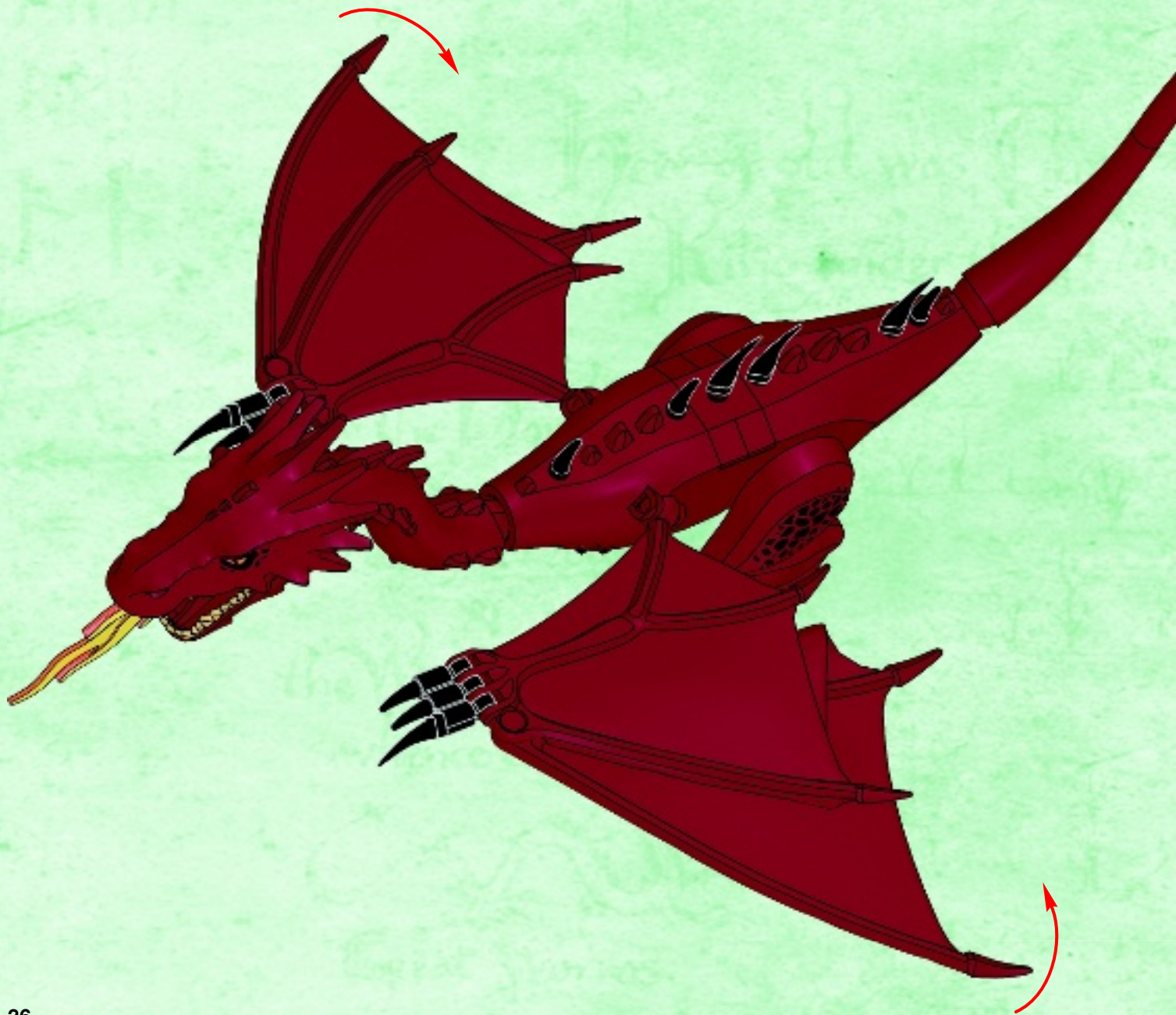

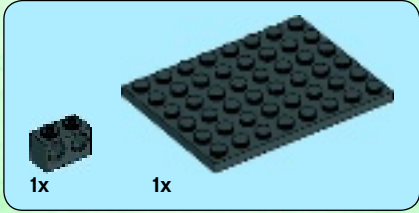
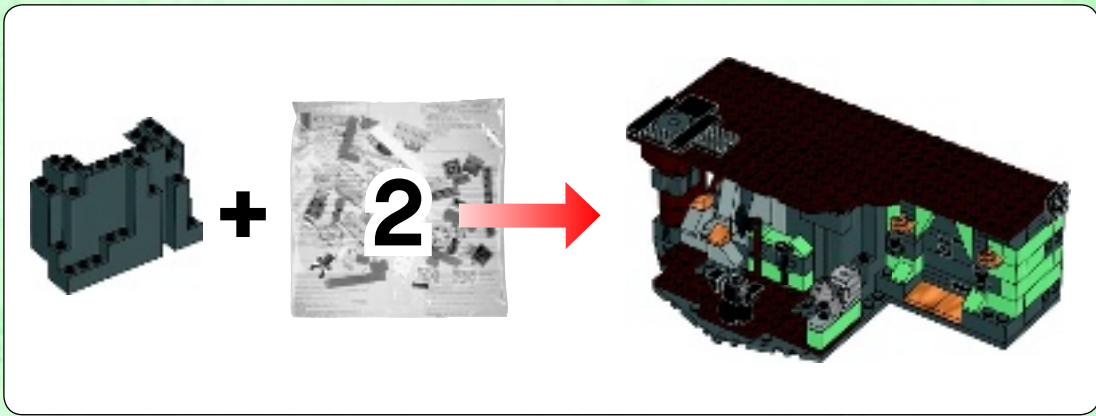

1

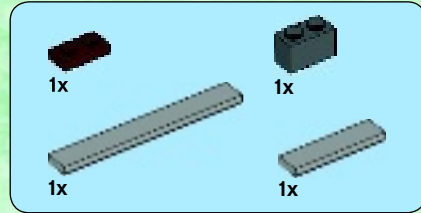

2

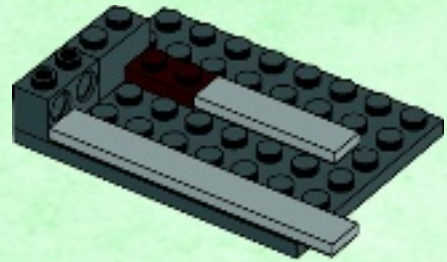

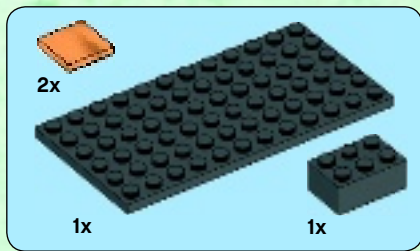

3

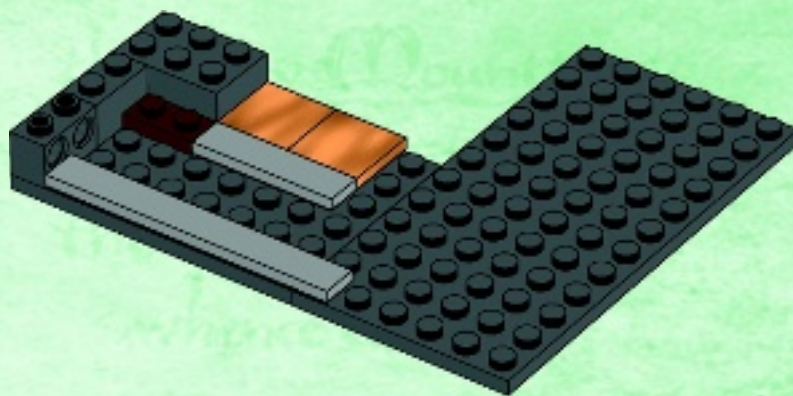

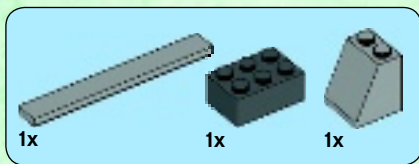

4

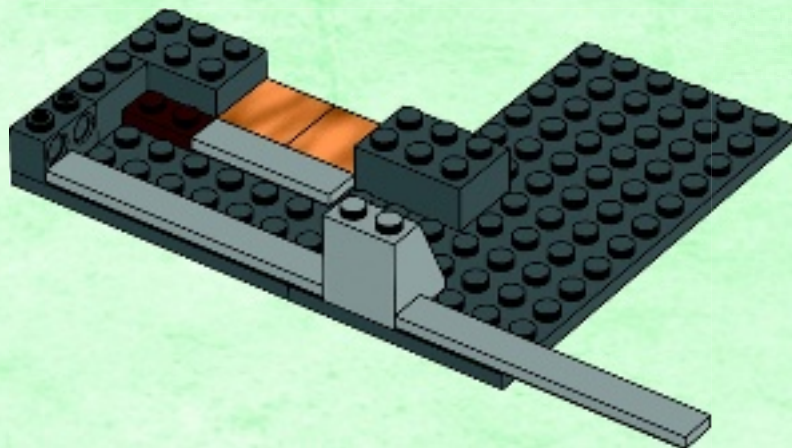



5

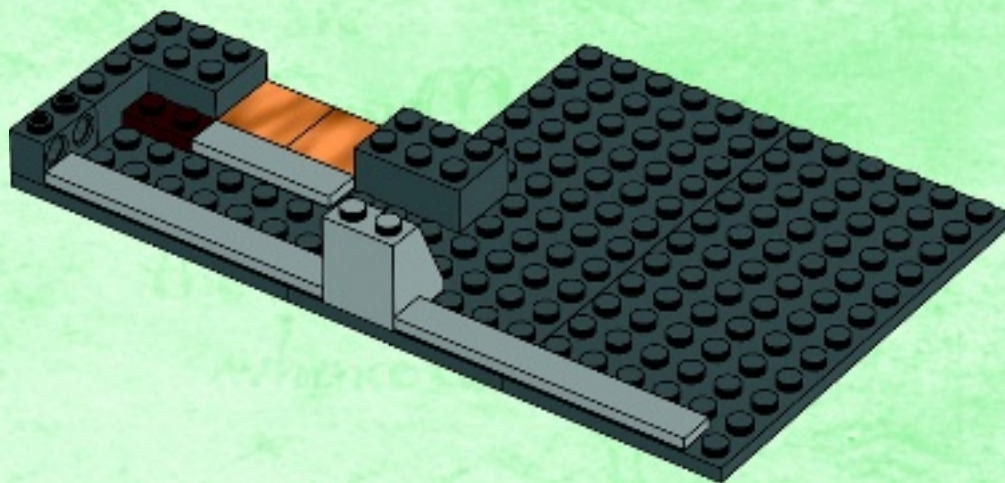

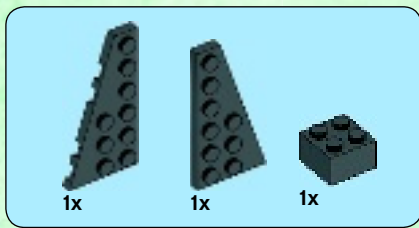

6

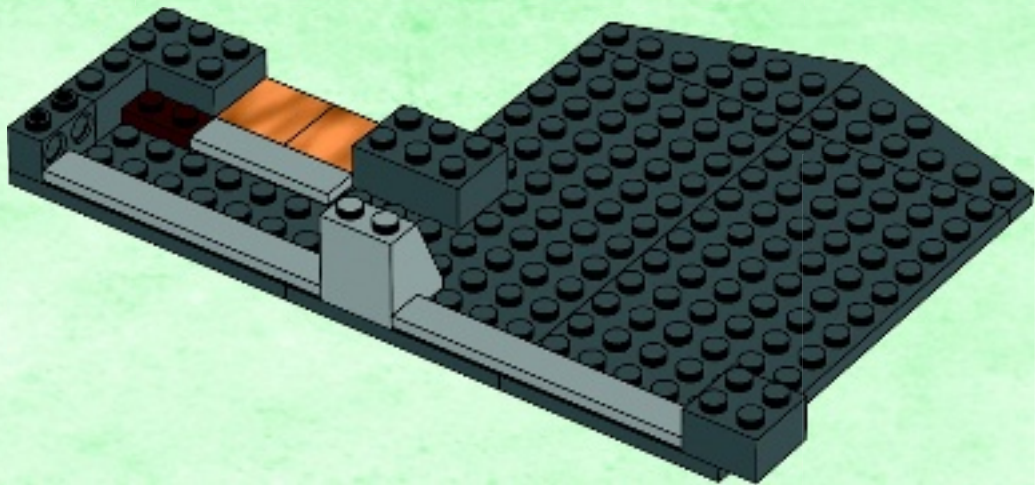

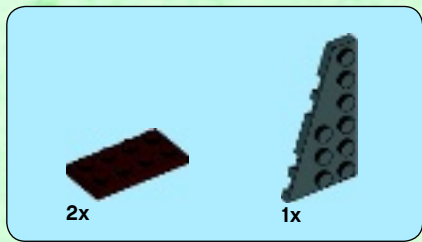

7

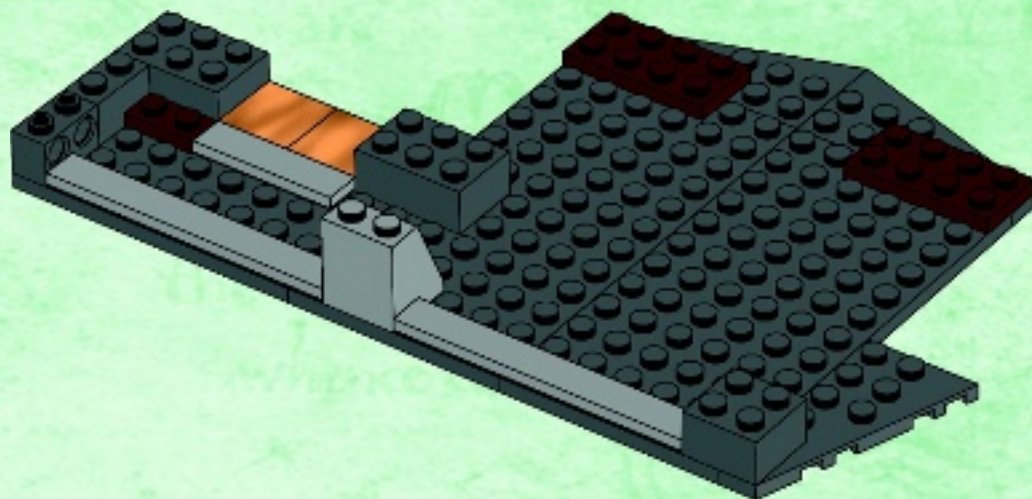



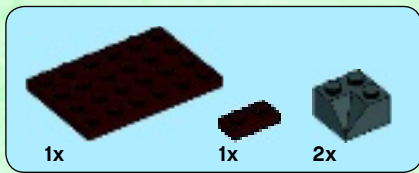

8

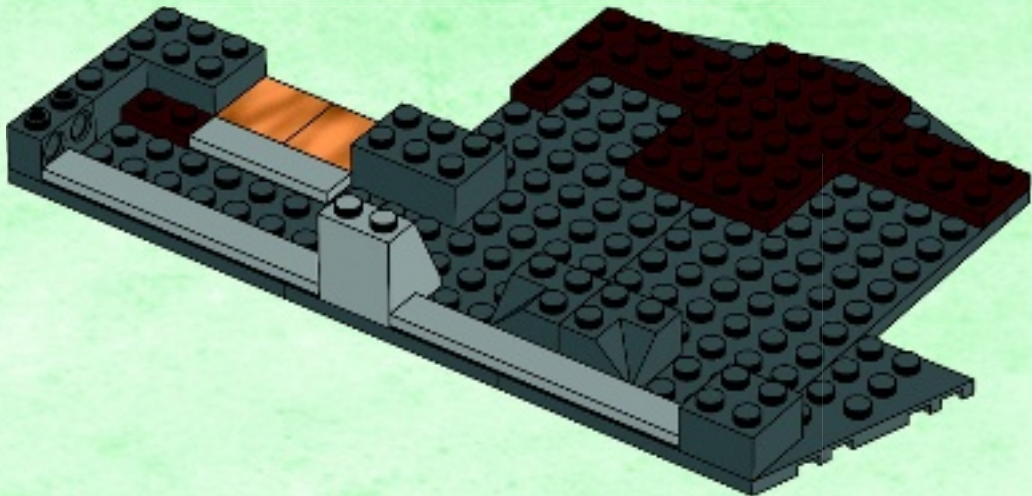



2x



1x

9

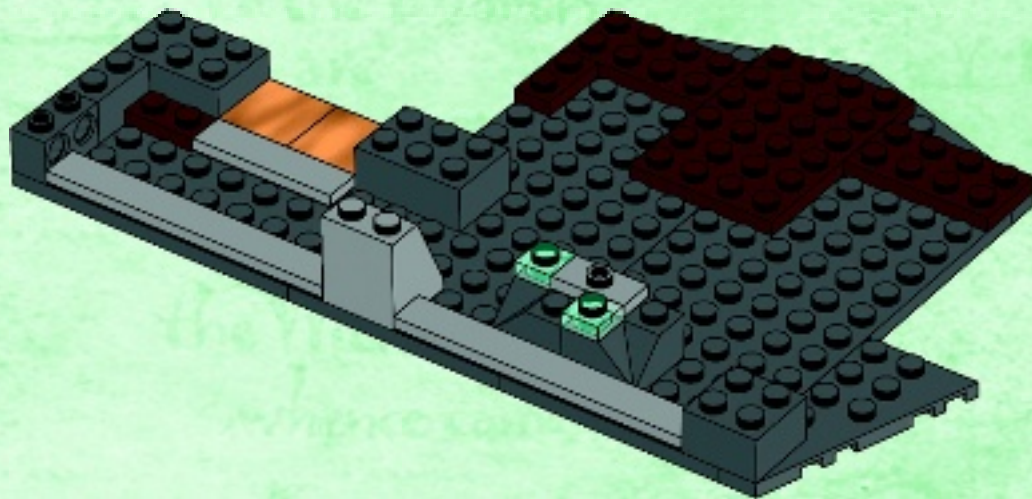



1x



1x



3x

# 10



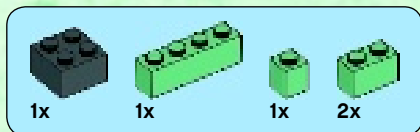

11

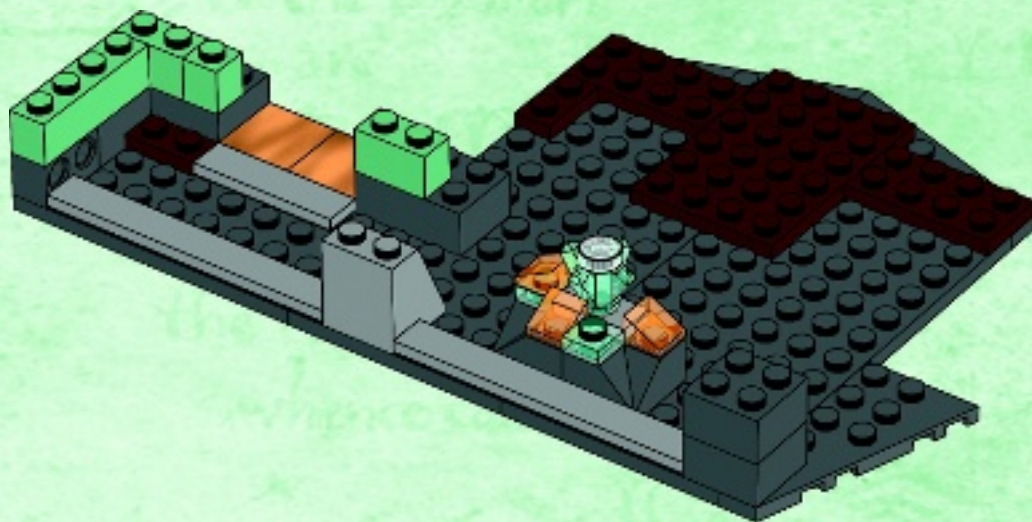



3x

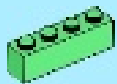

1x



1x

# 12

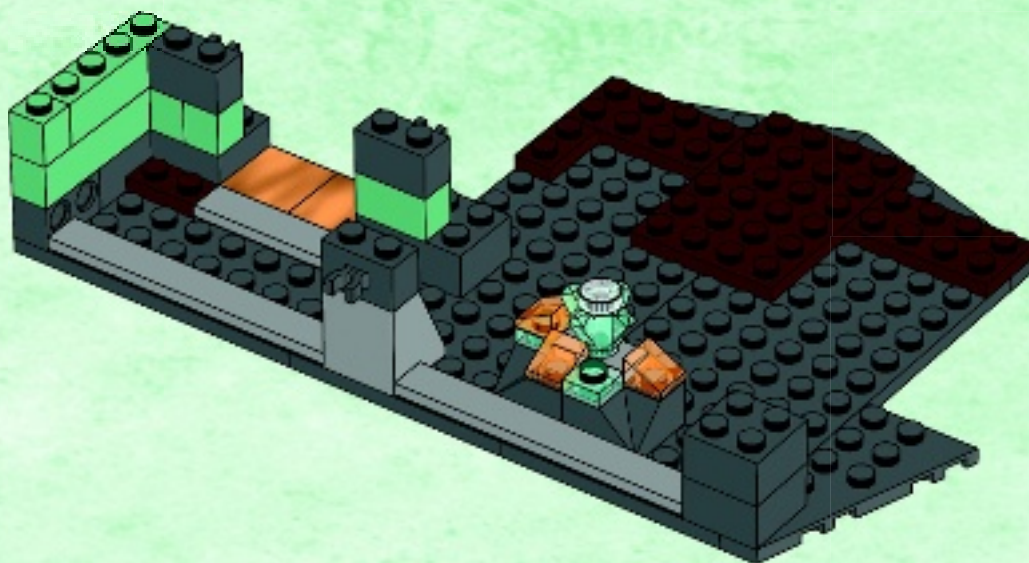



1x



1x



2x

# 13

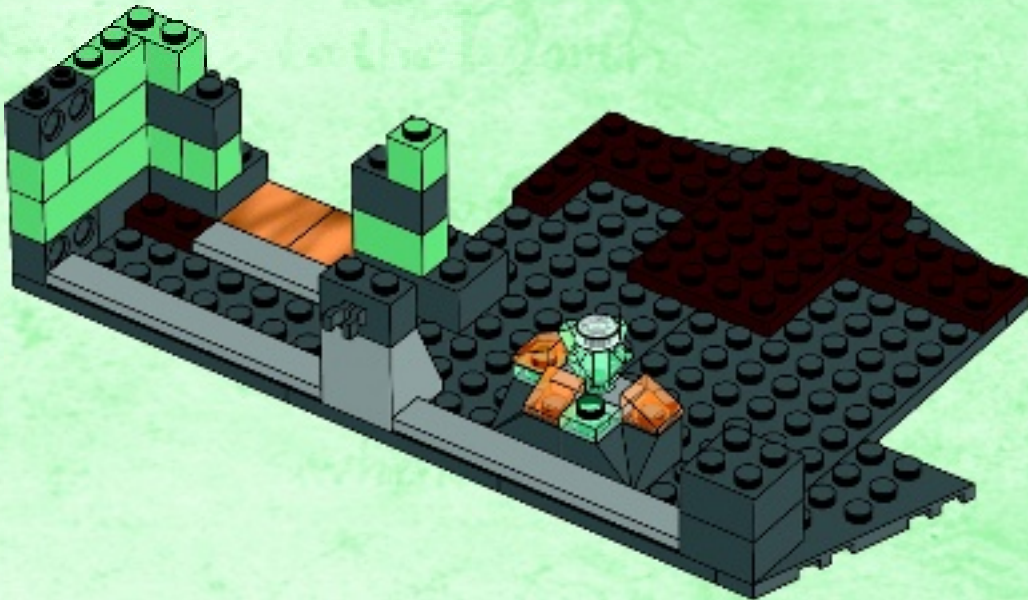

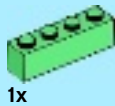

1x



3x

# 14

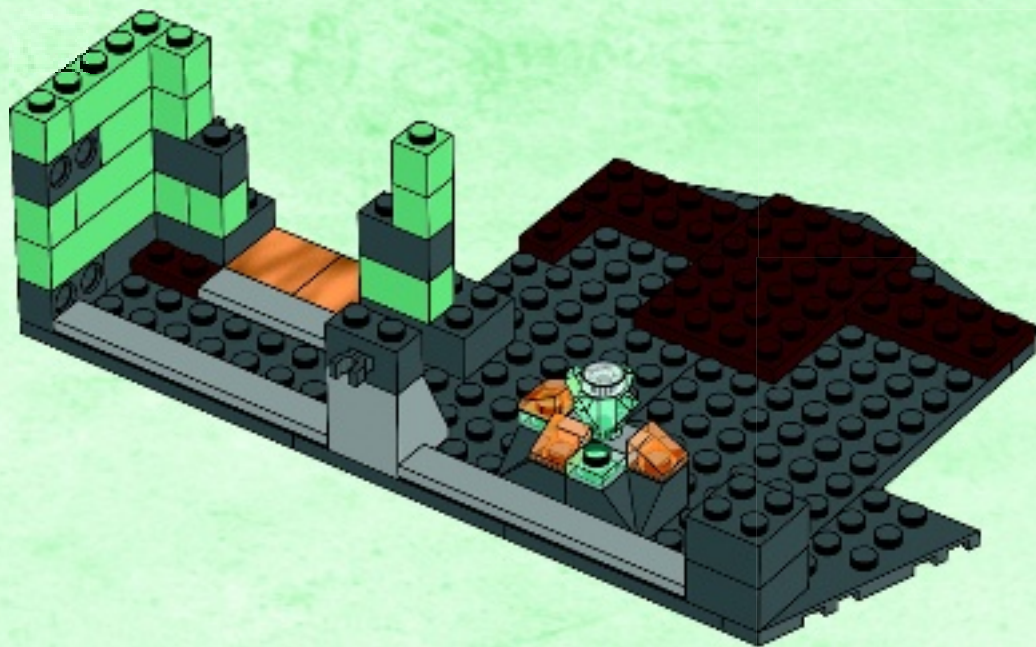



15

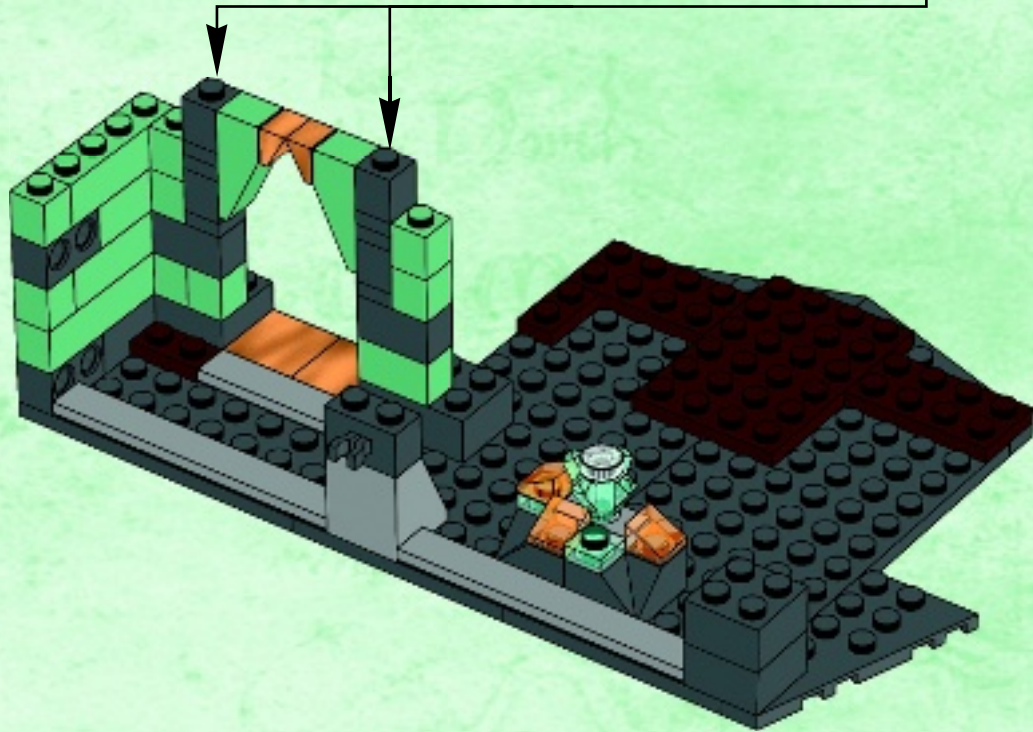
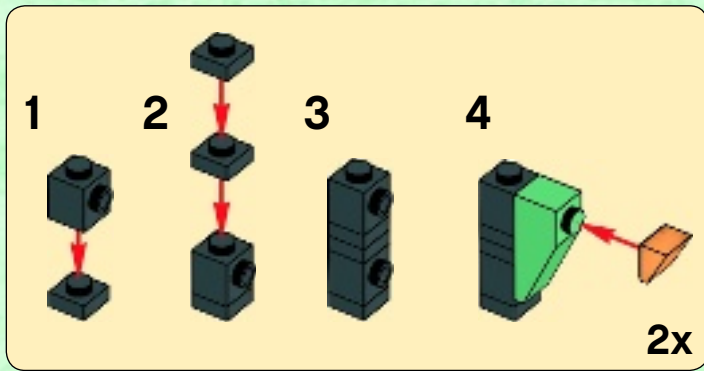





16

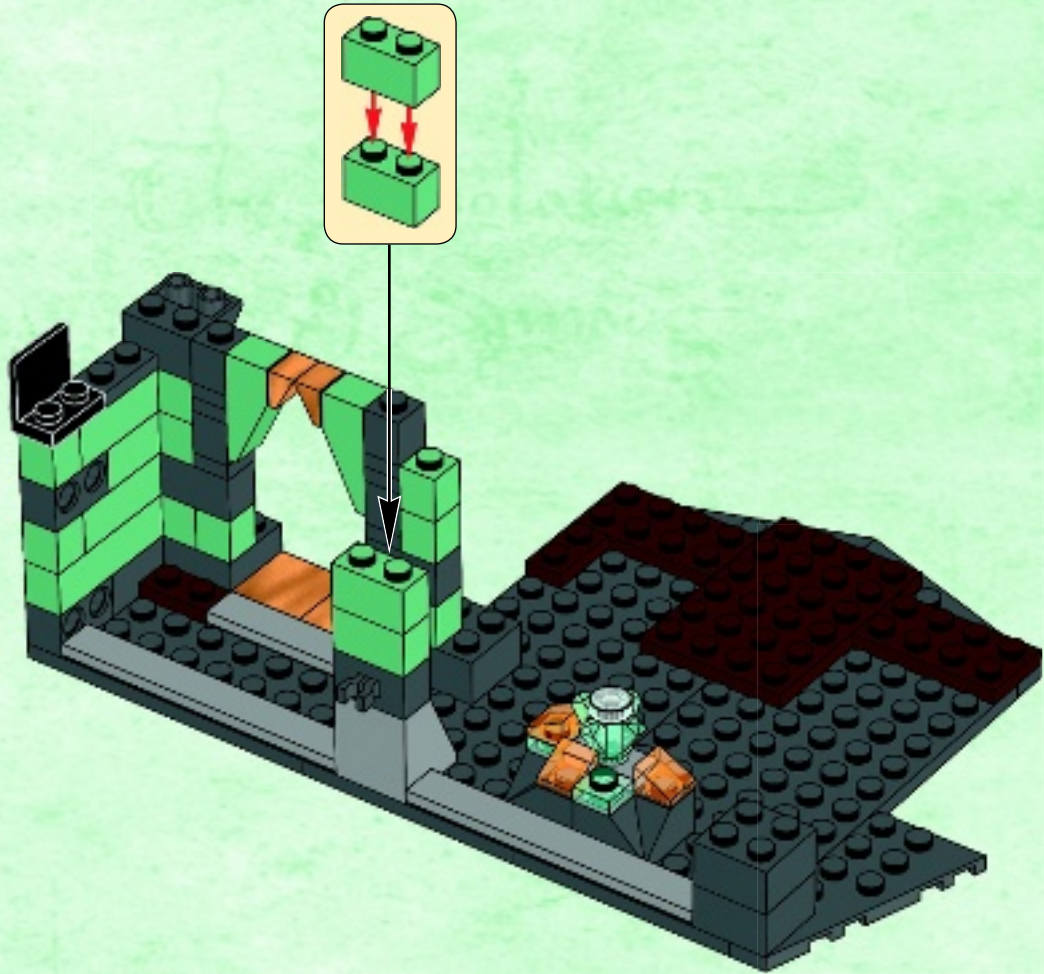

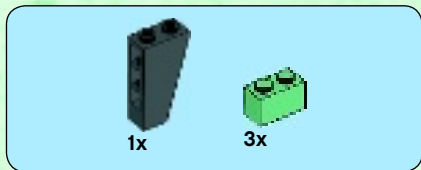

17

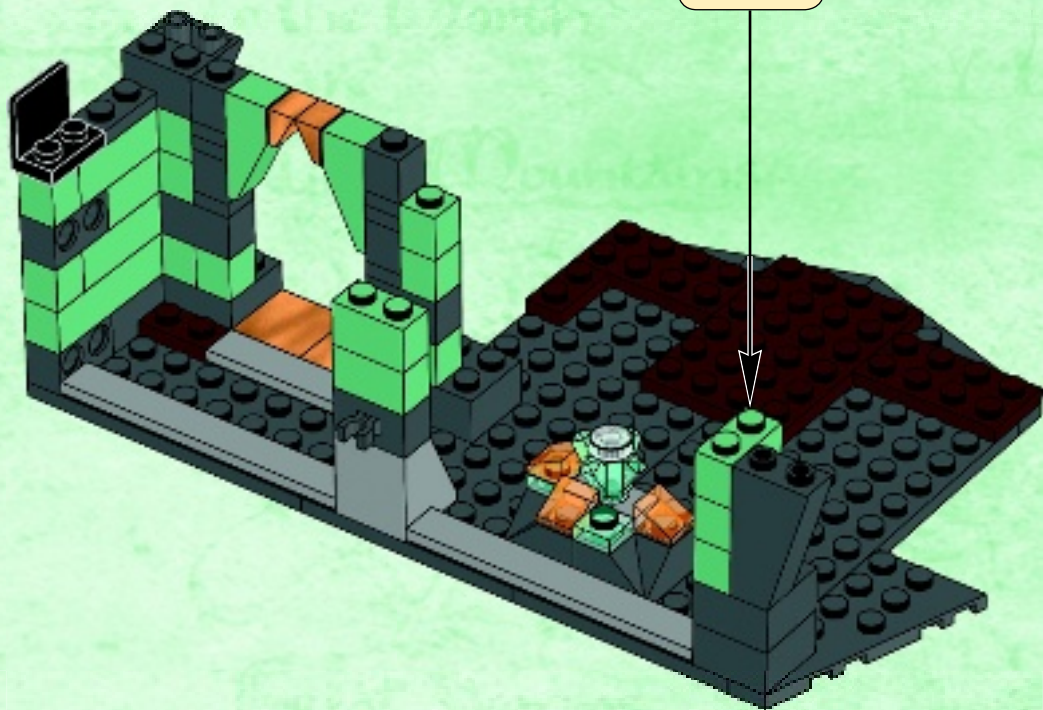
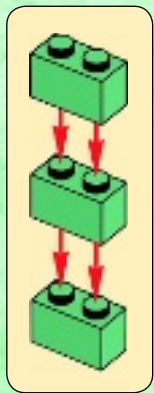

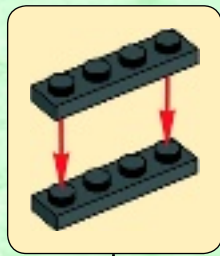
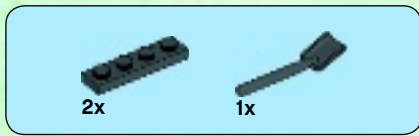

18

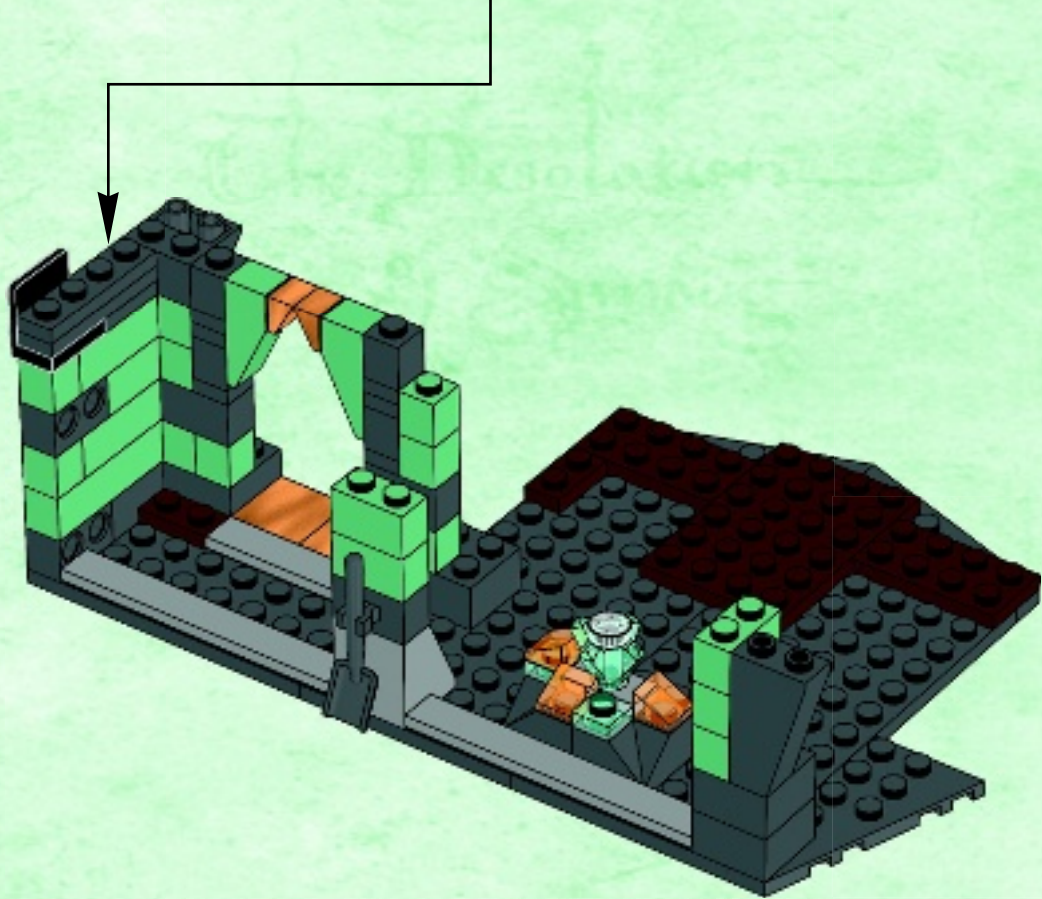

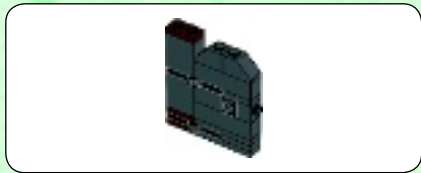

1

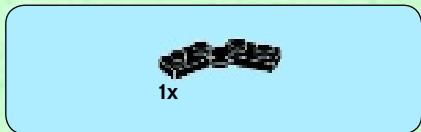
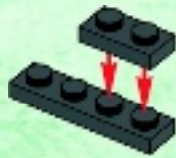

2



3

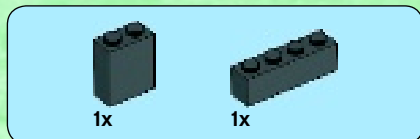
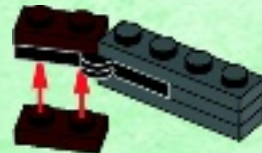

4

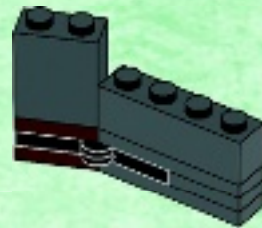



5

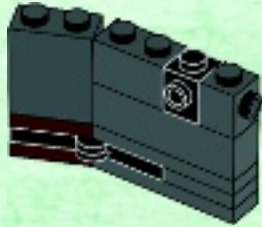

6

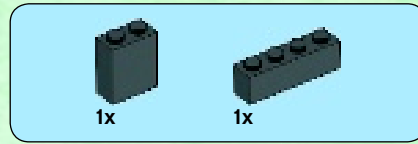
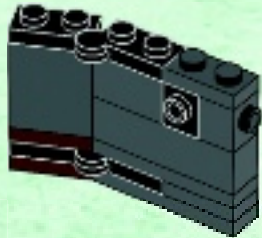

7

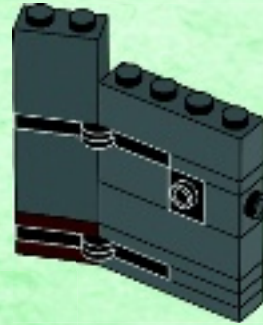

8

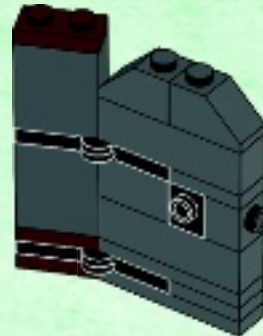

19

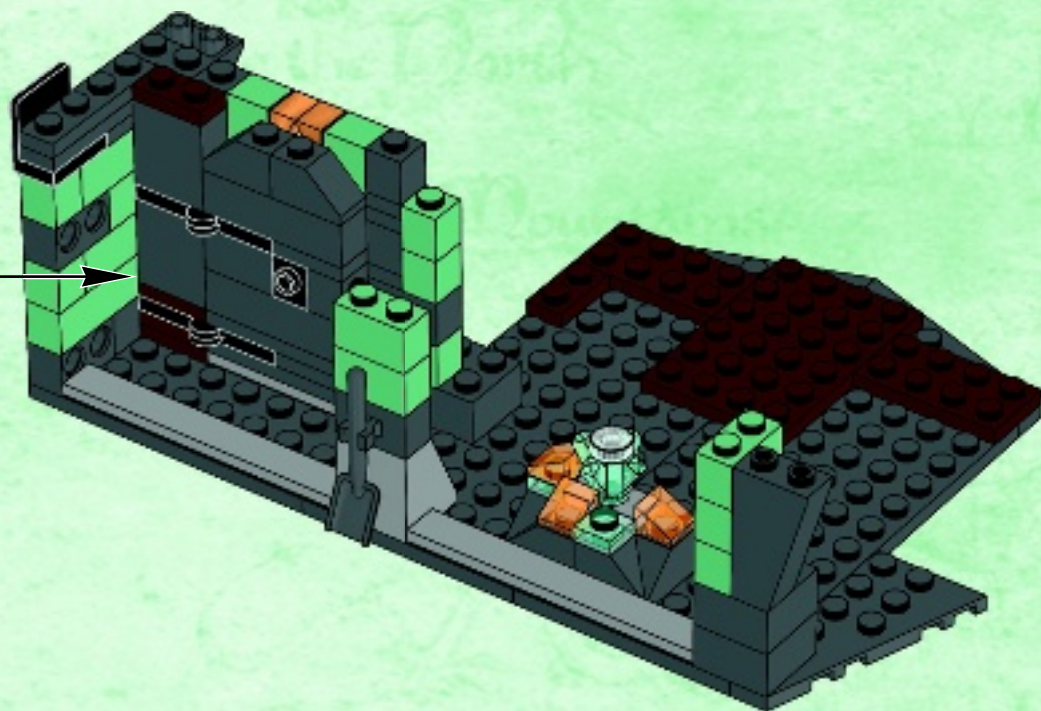

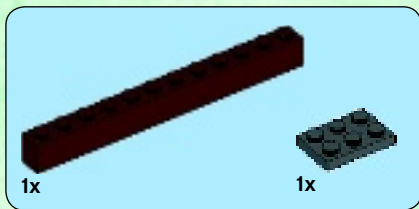

20

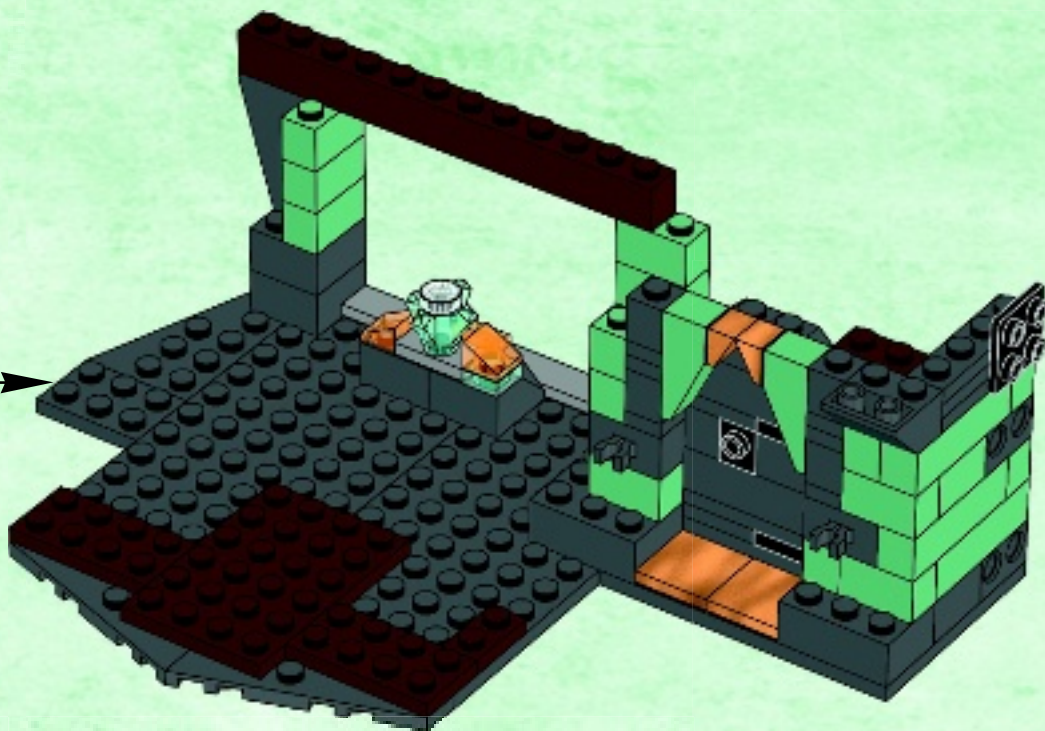



1x

21

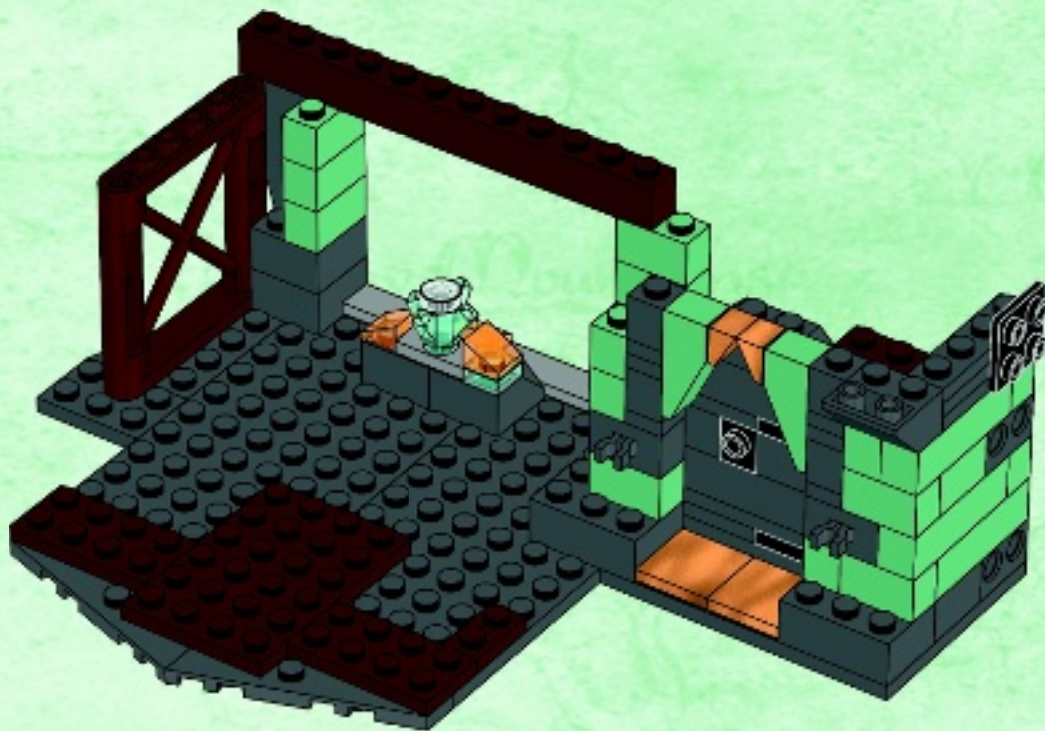



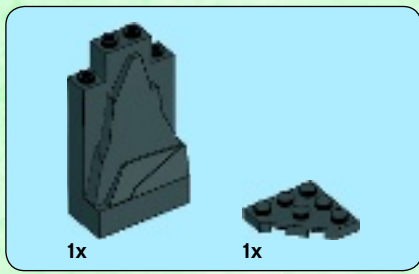

22

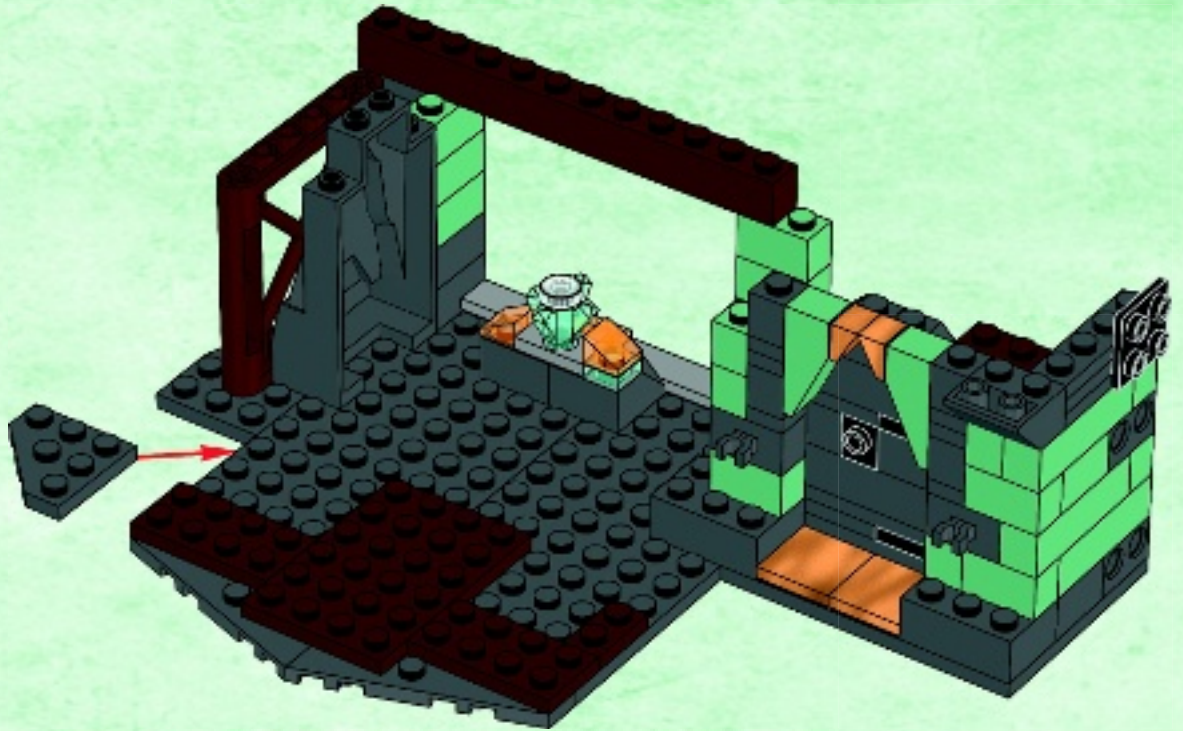



23

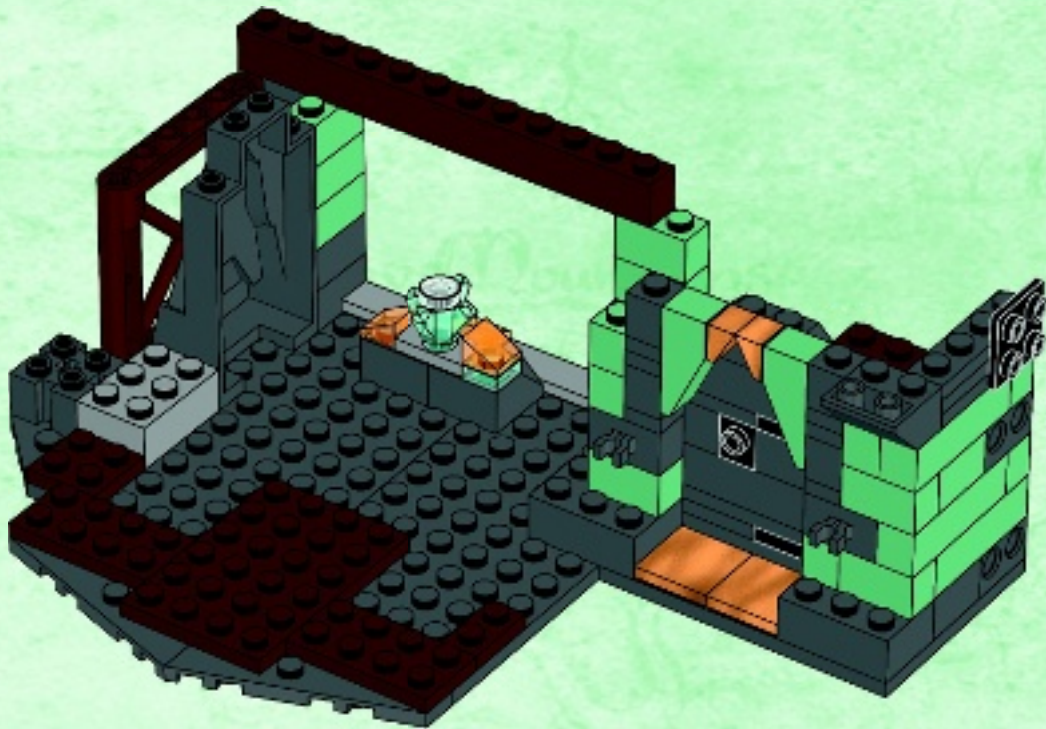

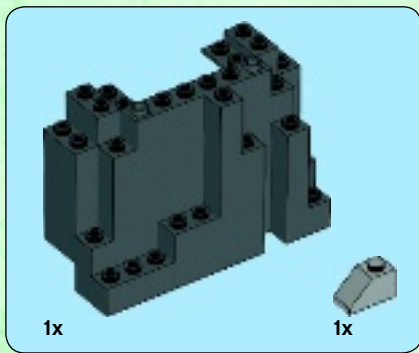

24

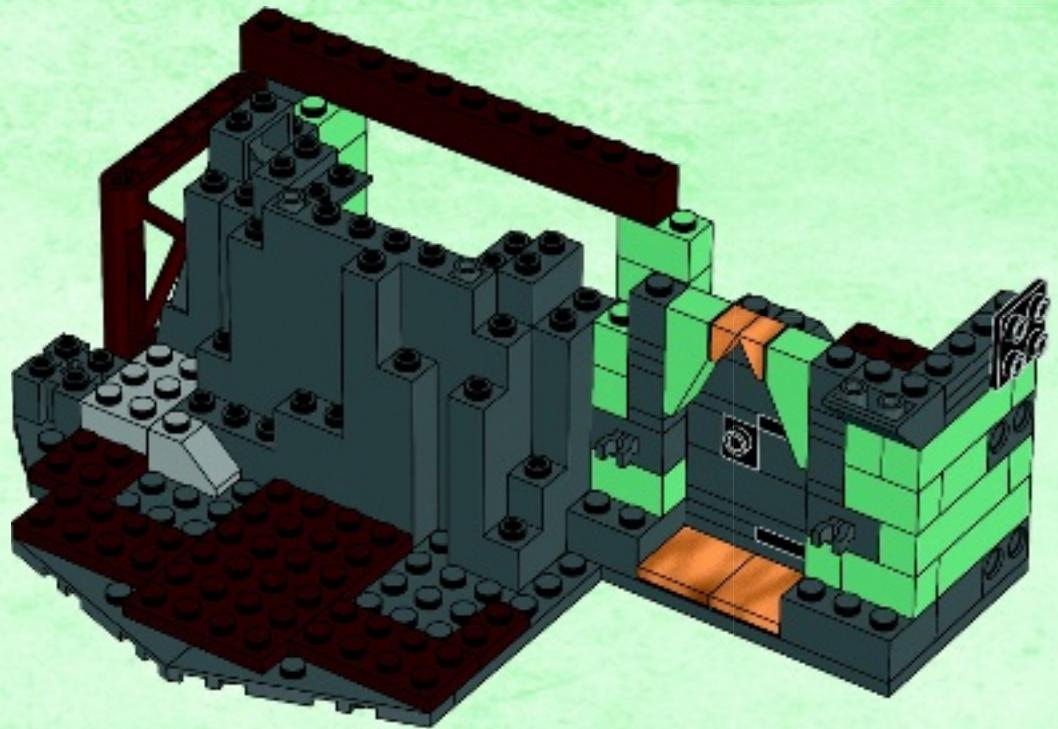

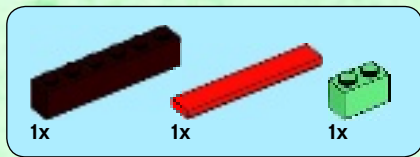

# 25

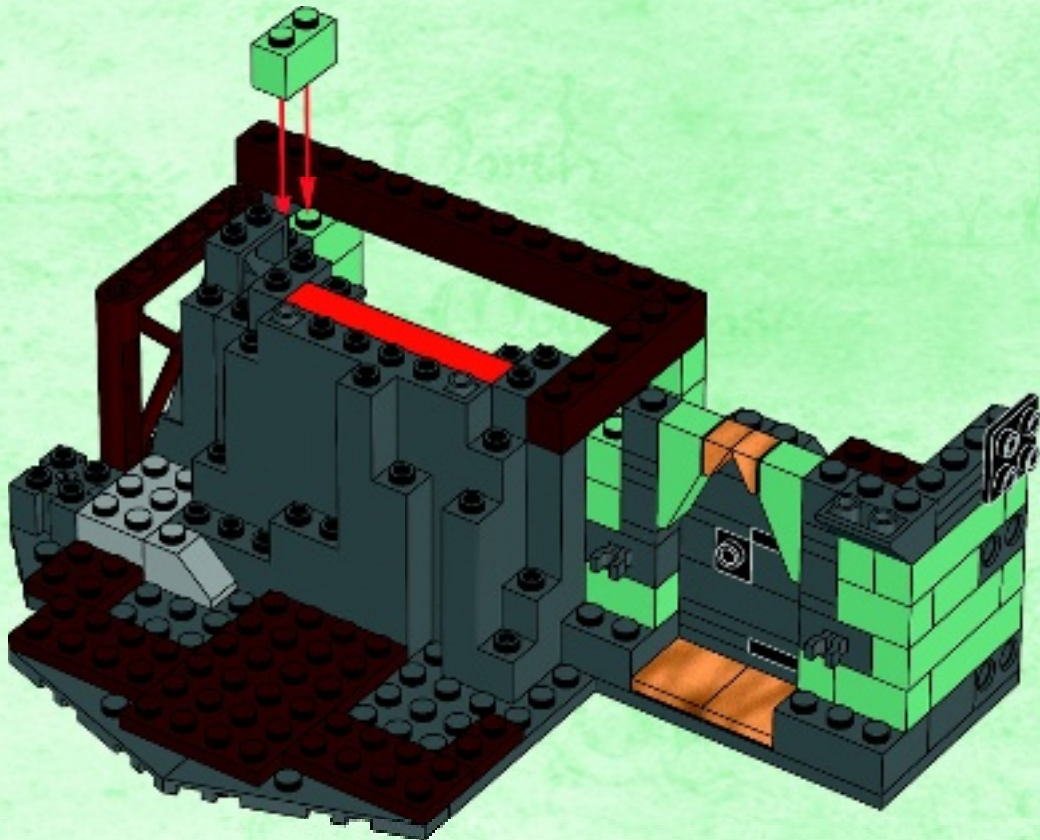



2x



3x

# 26

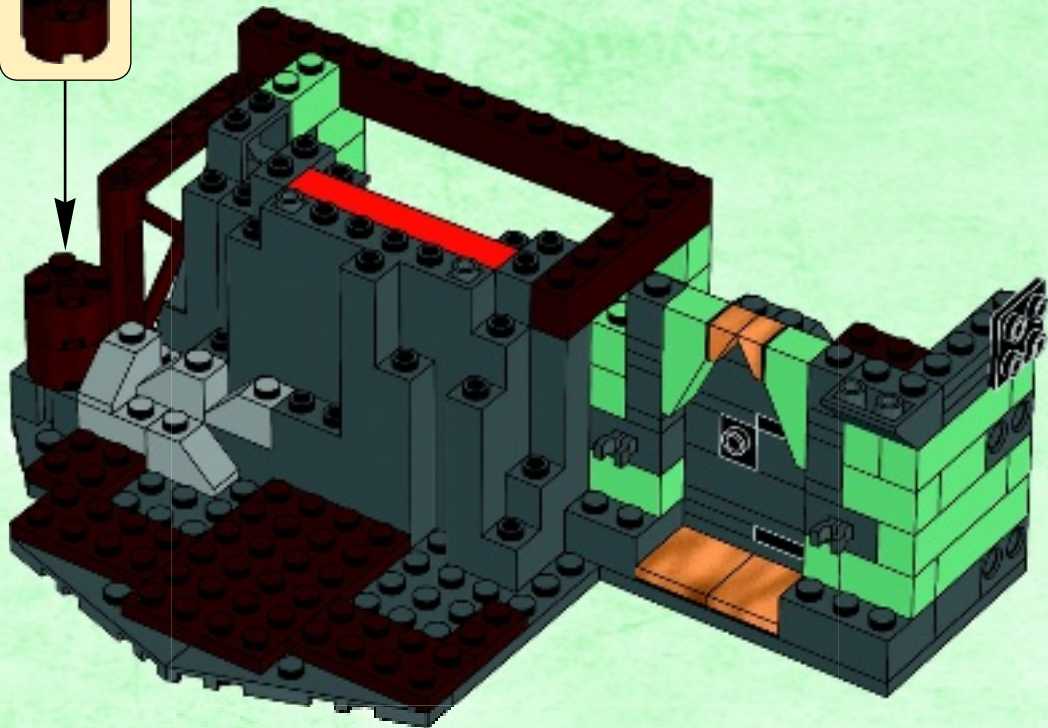
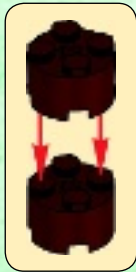



27

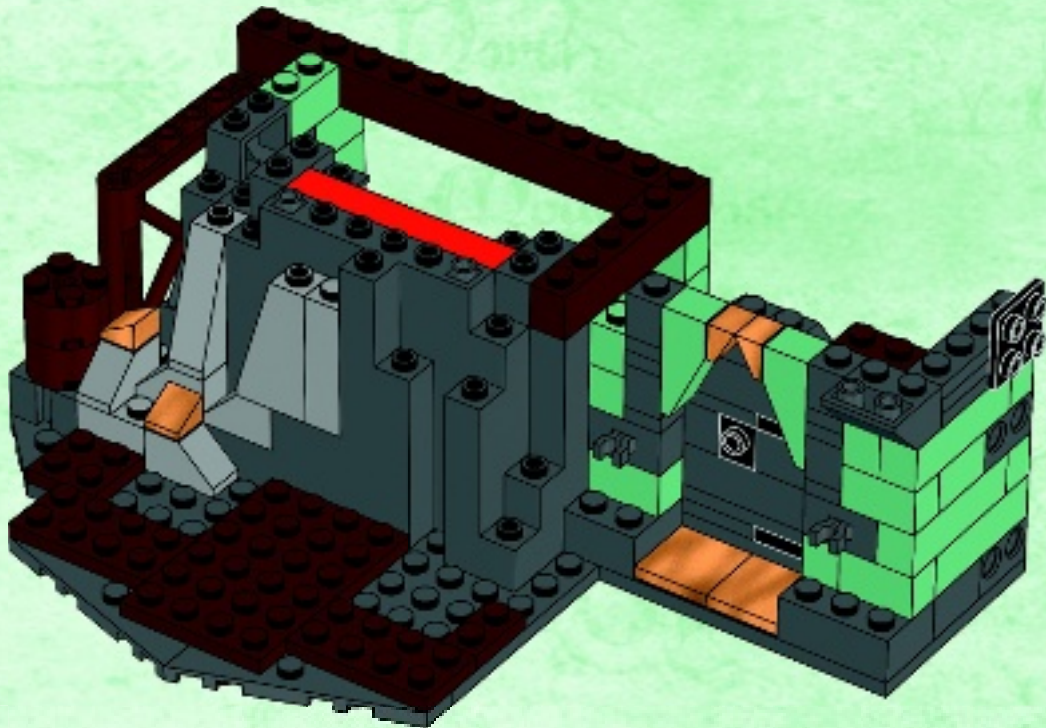

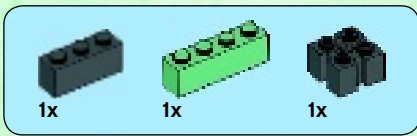

# 28

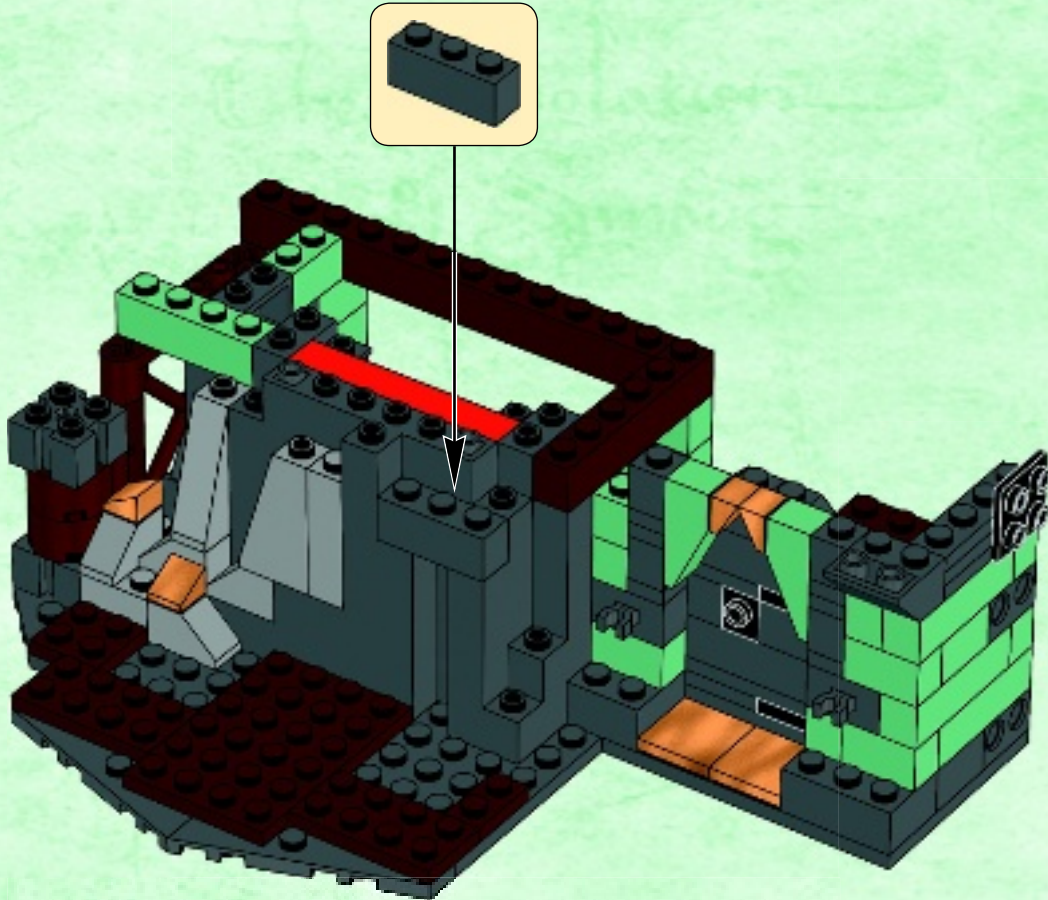



1x



2x

# 29

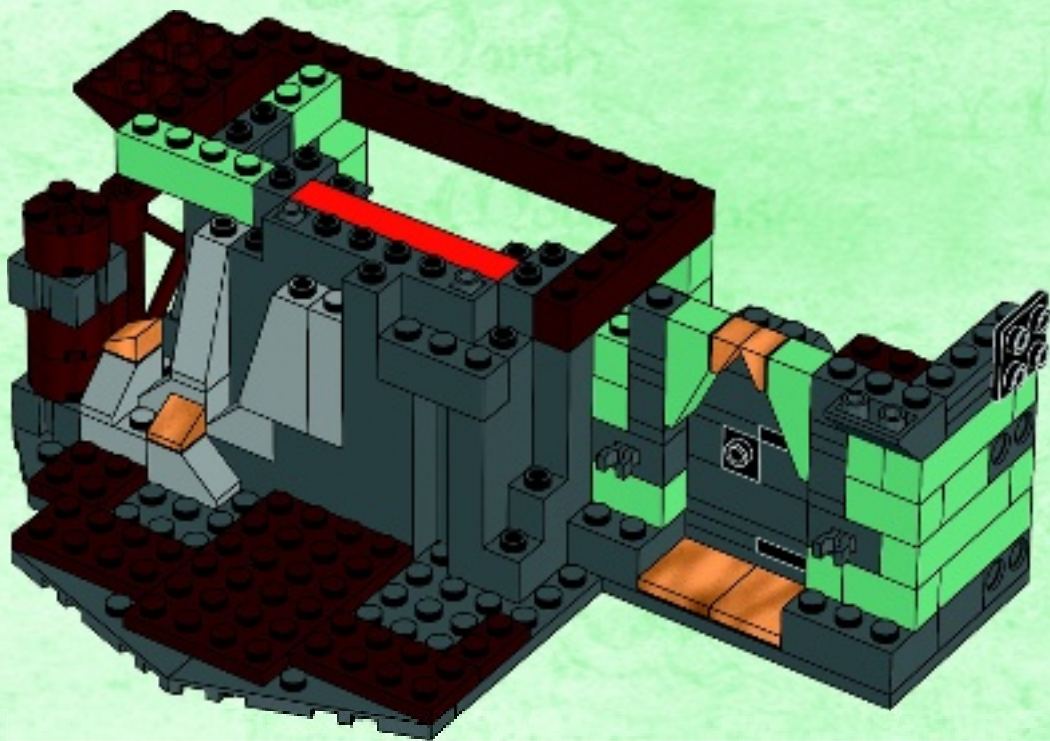





30

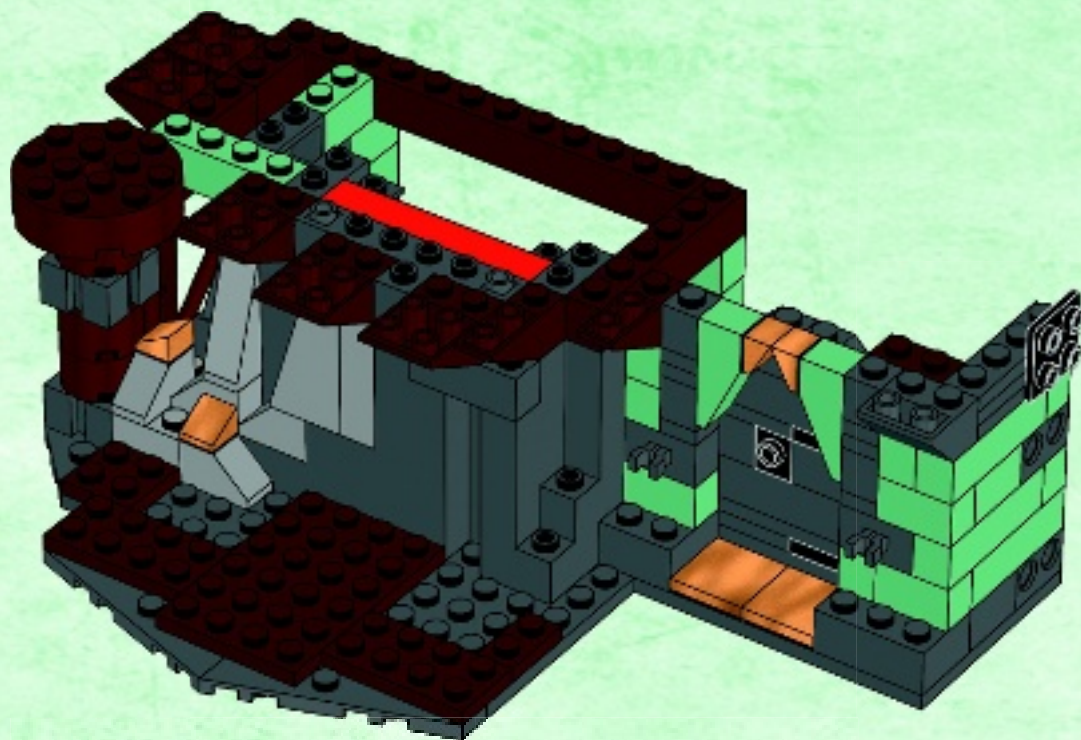

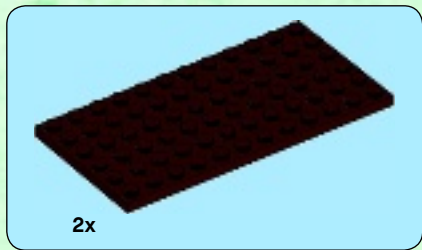

31

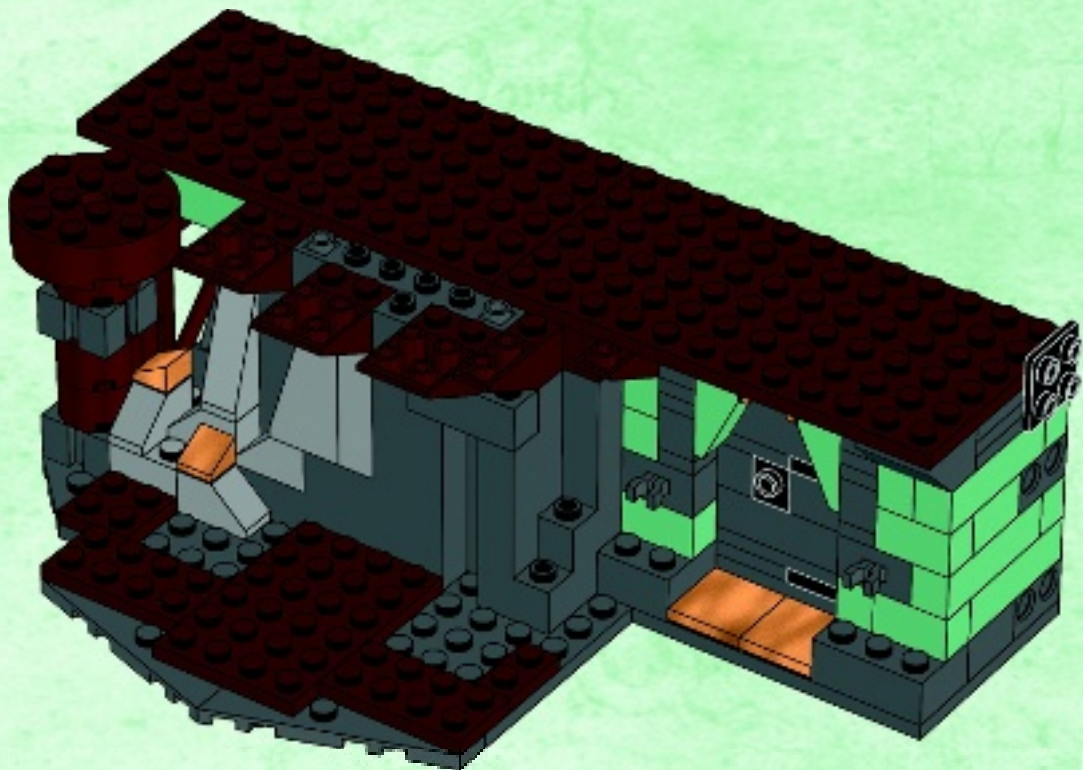

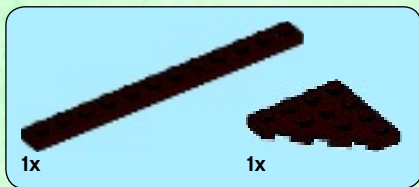

32

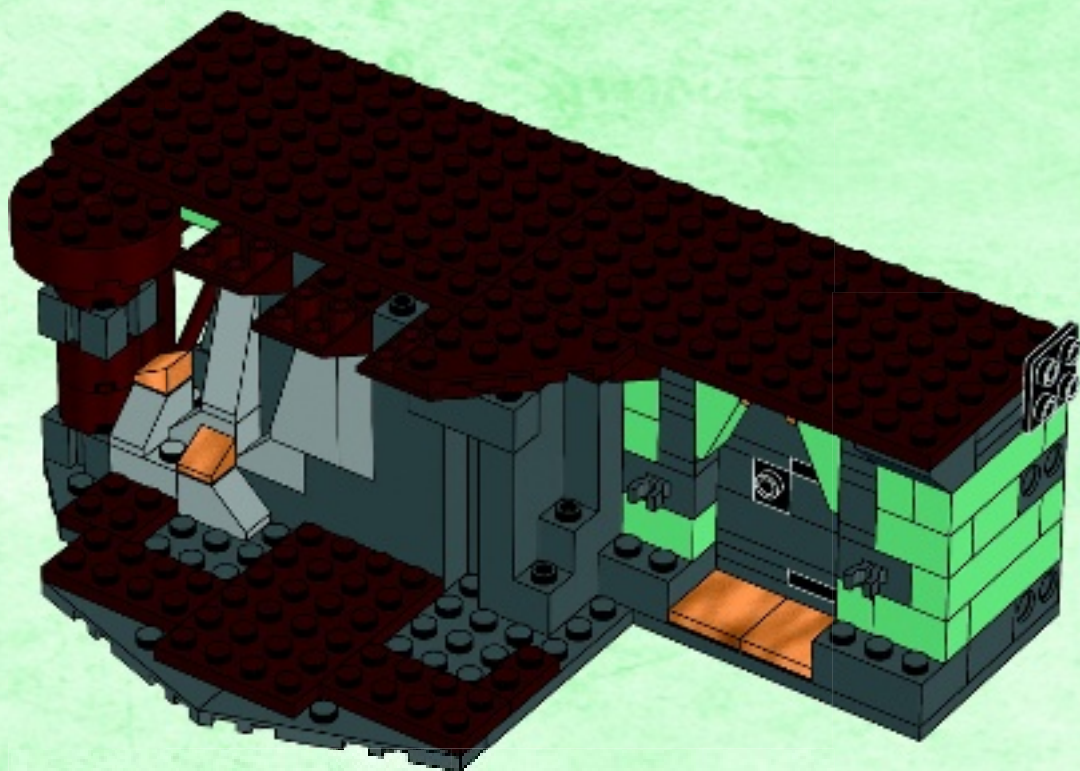

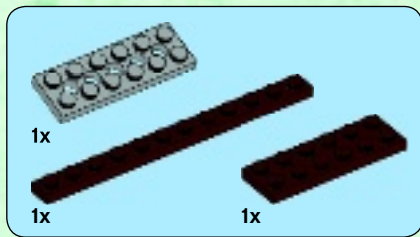

33

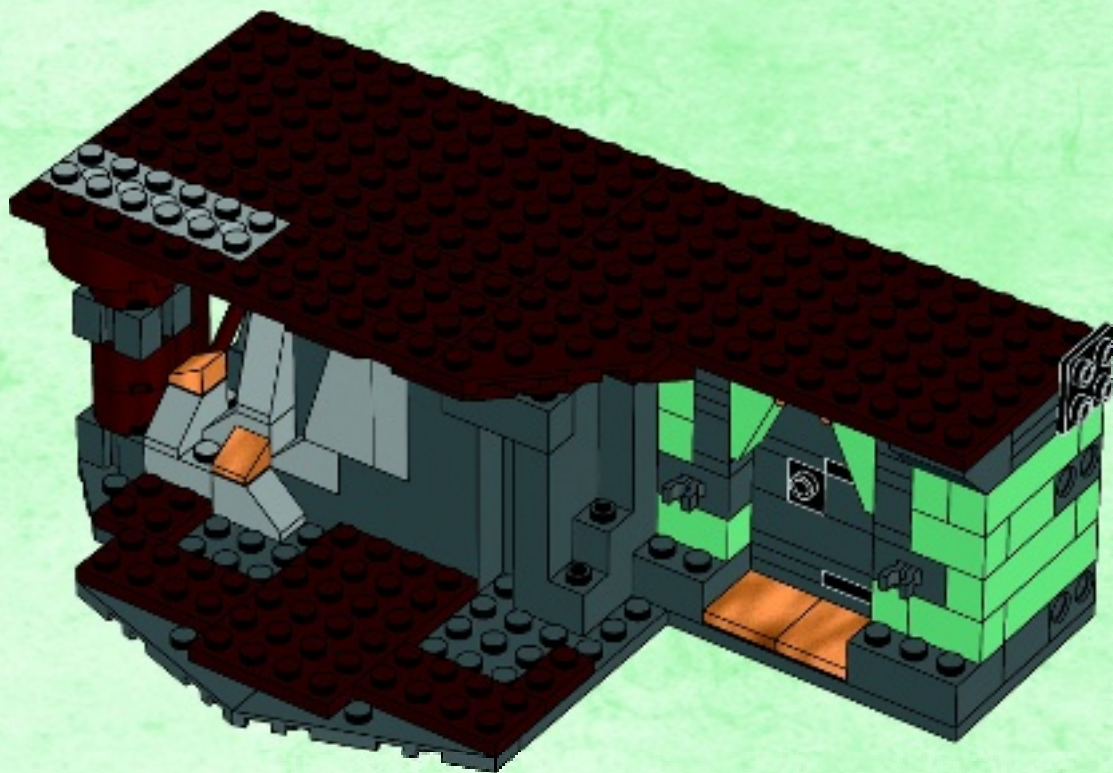

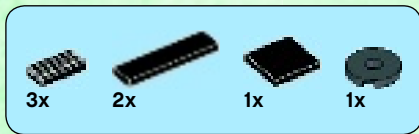

# 34

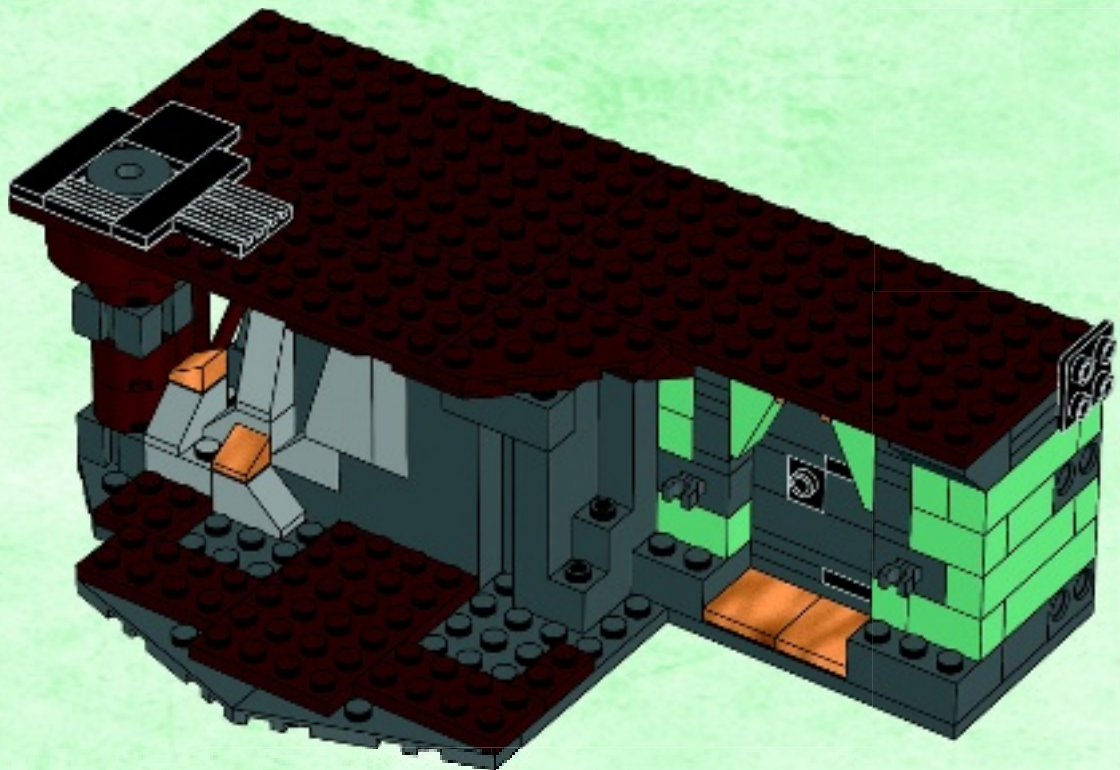

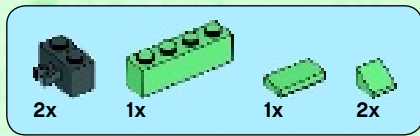

35

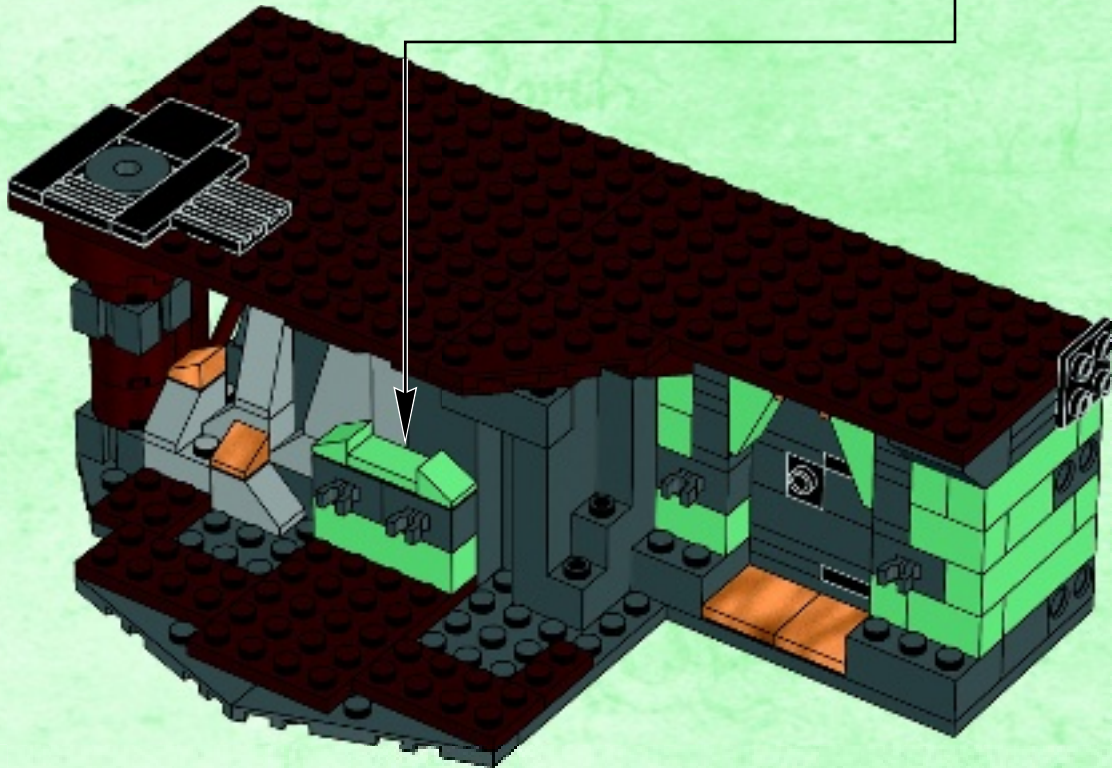
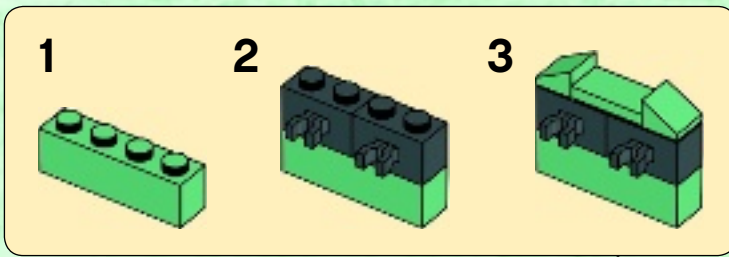



# 36

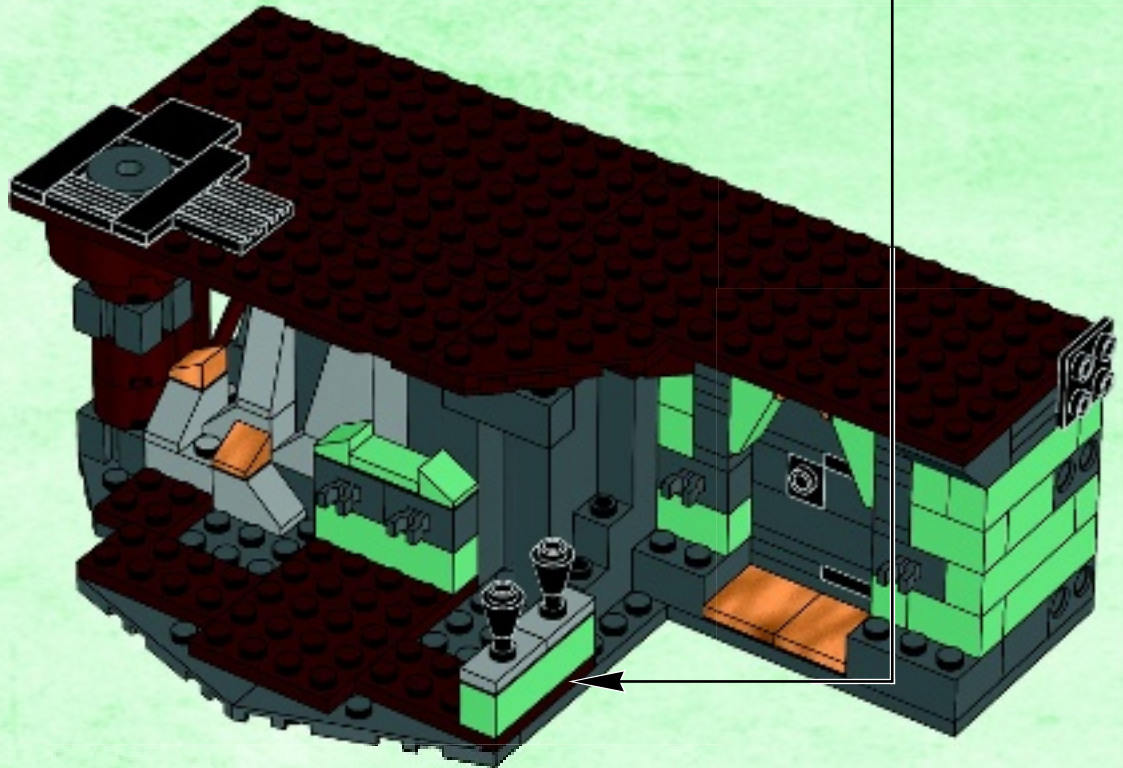
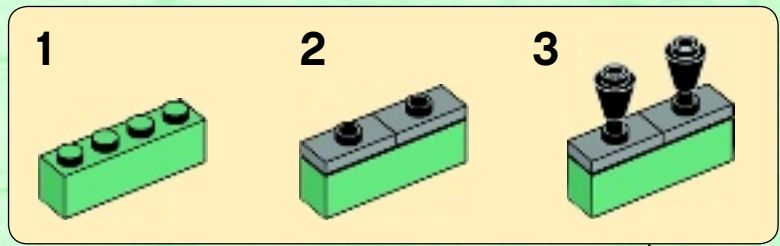



# 37

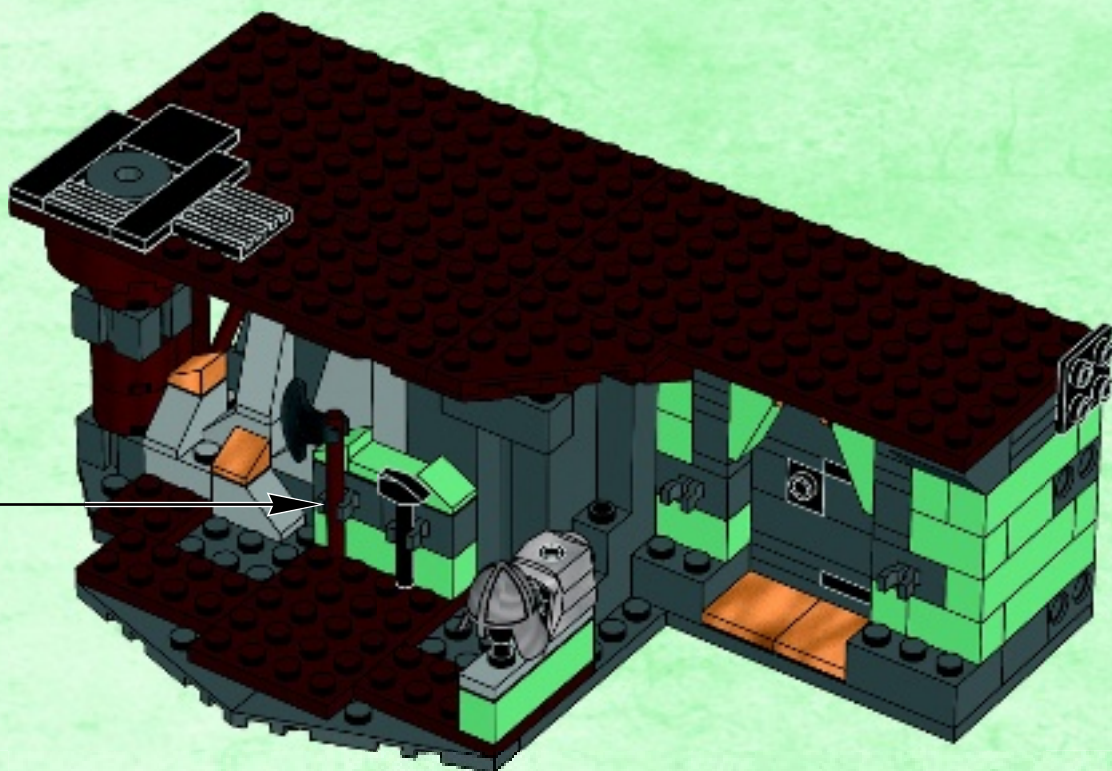





1x



1x



2x



2x

# 38

1



2



3

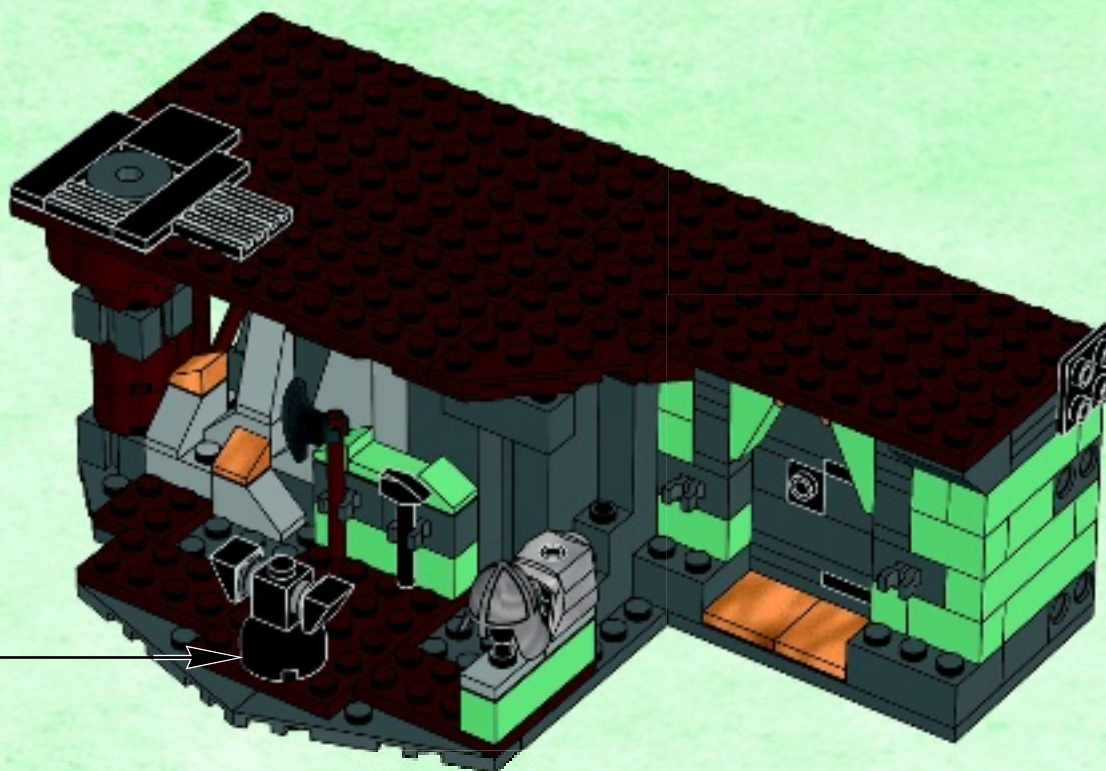



2x



2x



2x

# 39

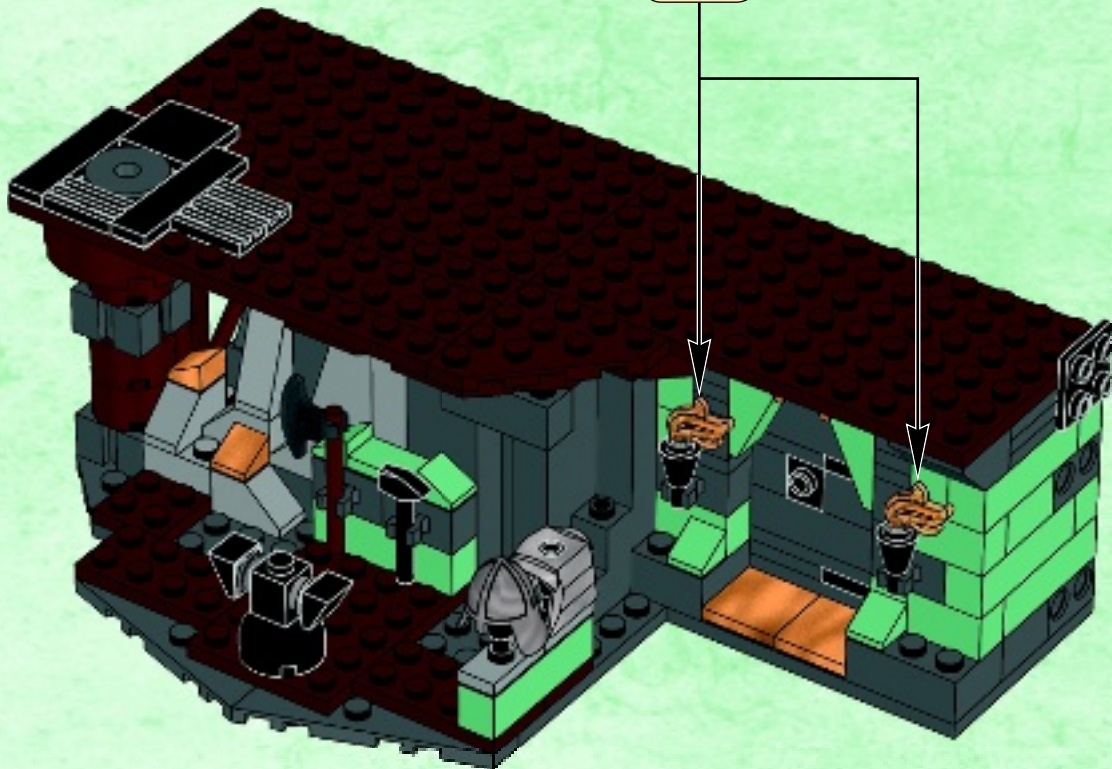

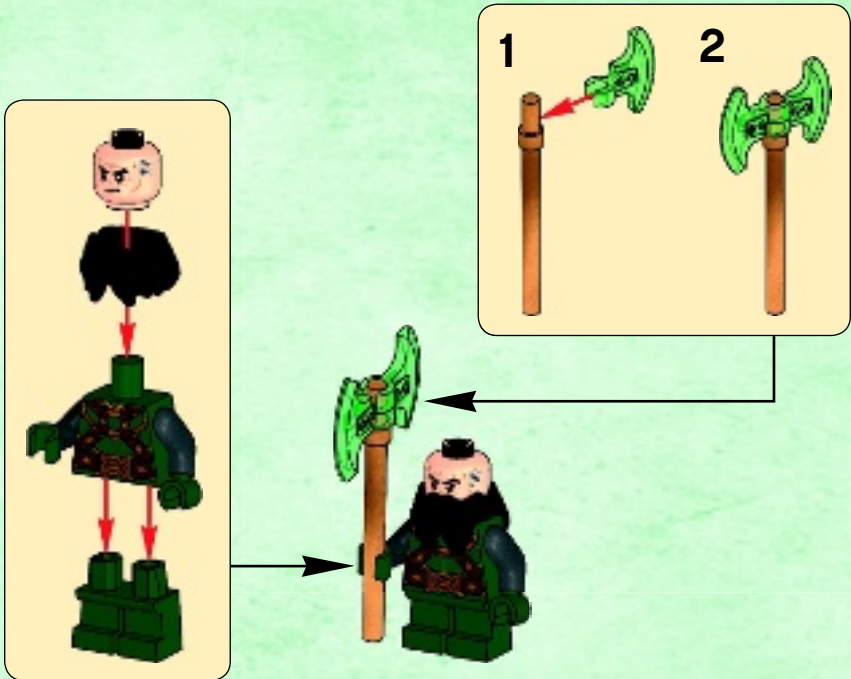
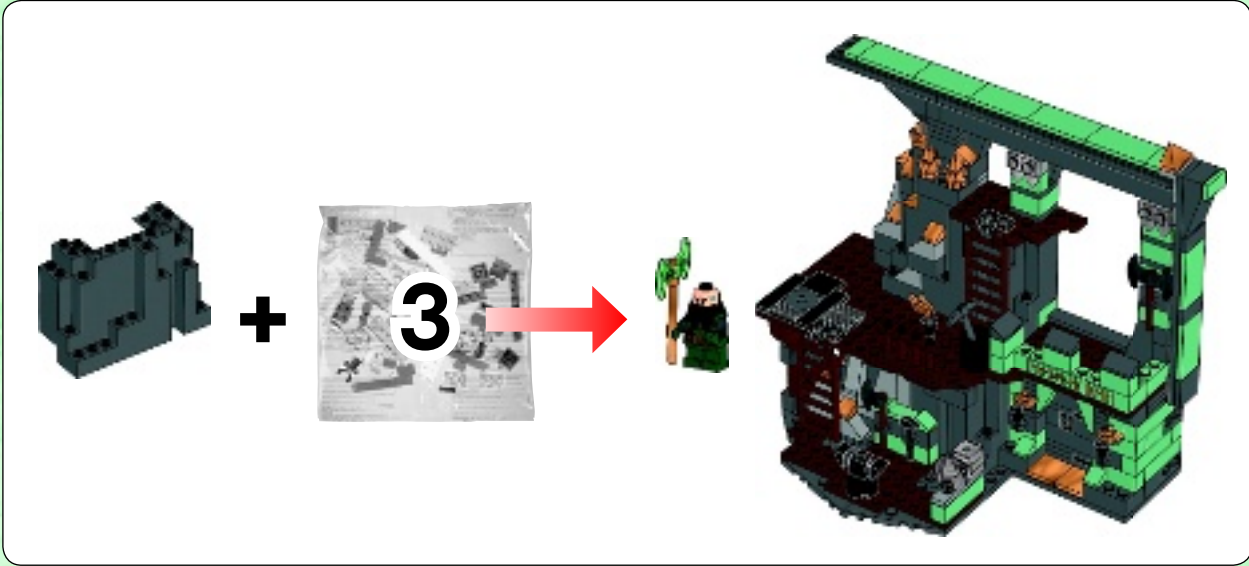



2x



1x



3x

# 40

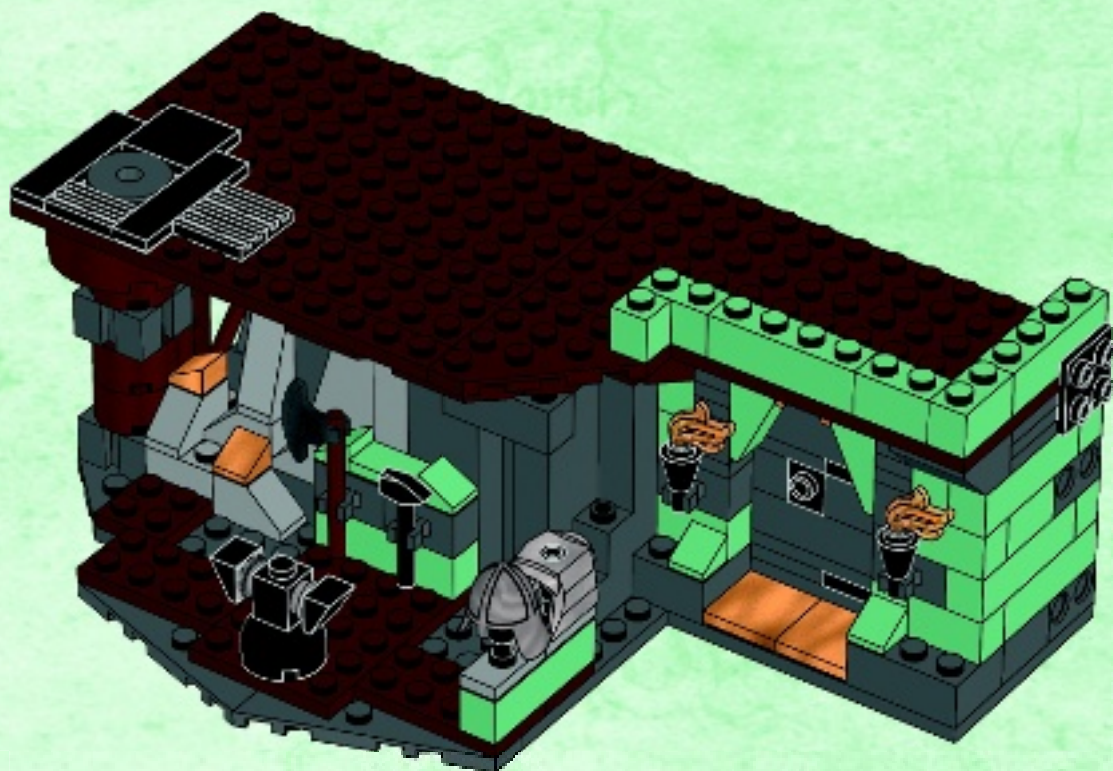

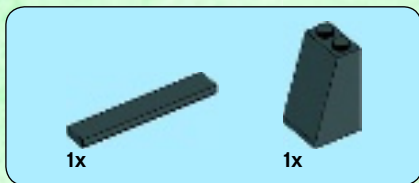

# 41

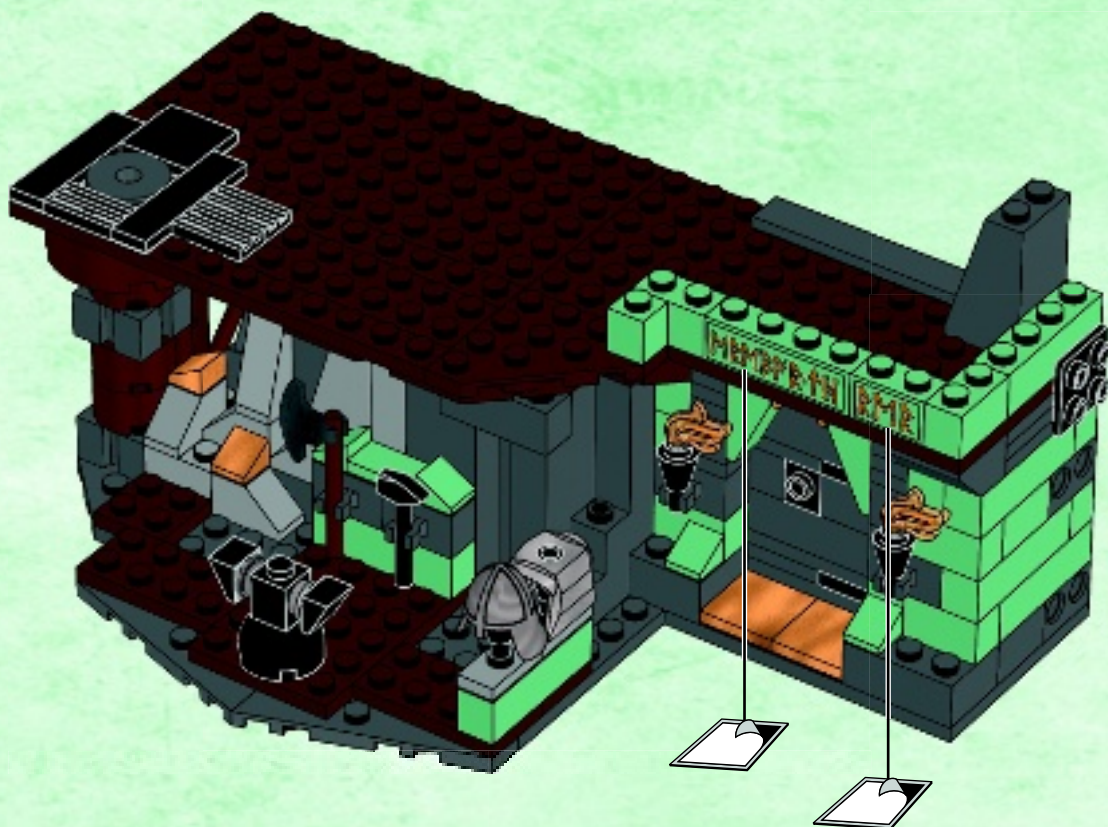



2x



3x



3x

# 42

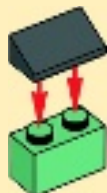

3x

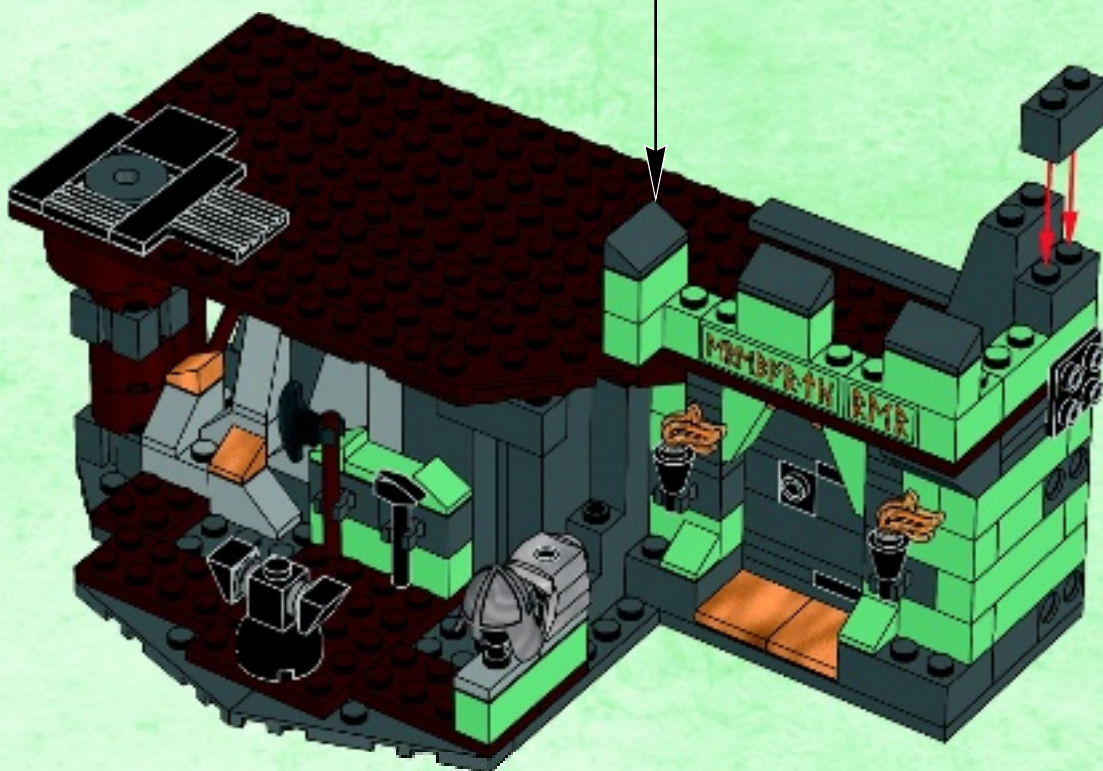

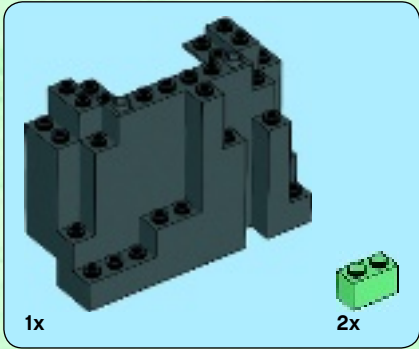
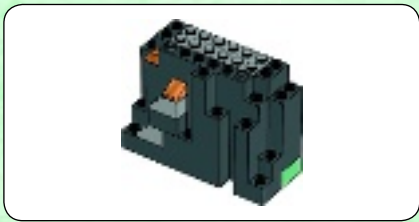

1

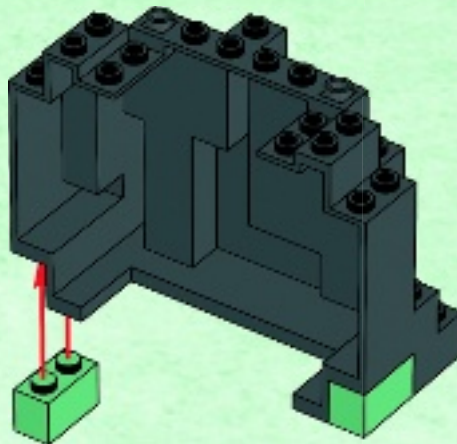

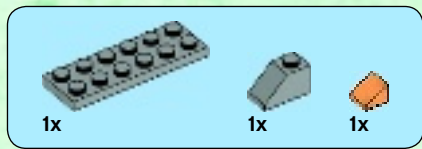

2

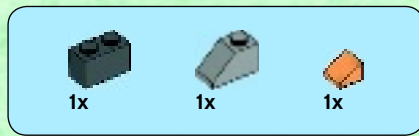
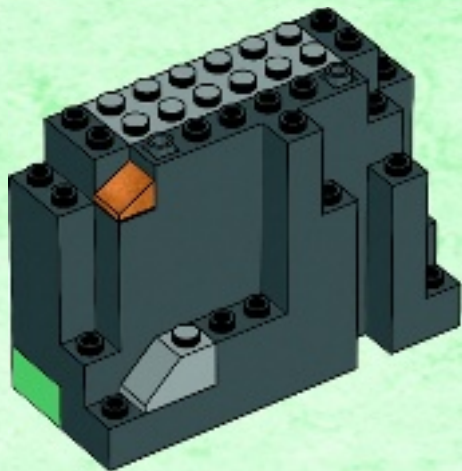
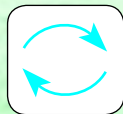

3

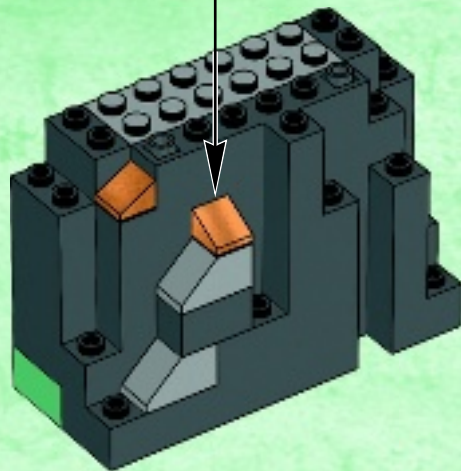
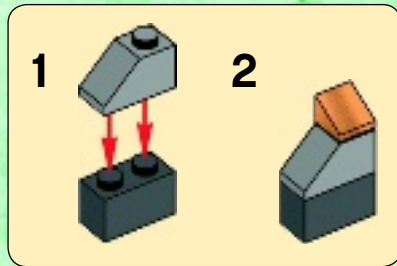



43

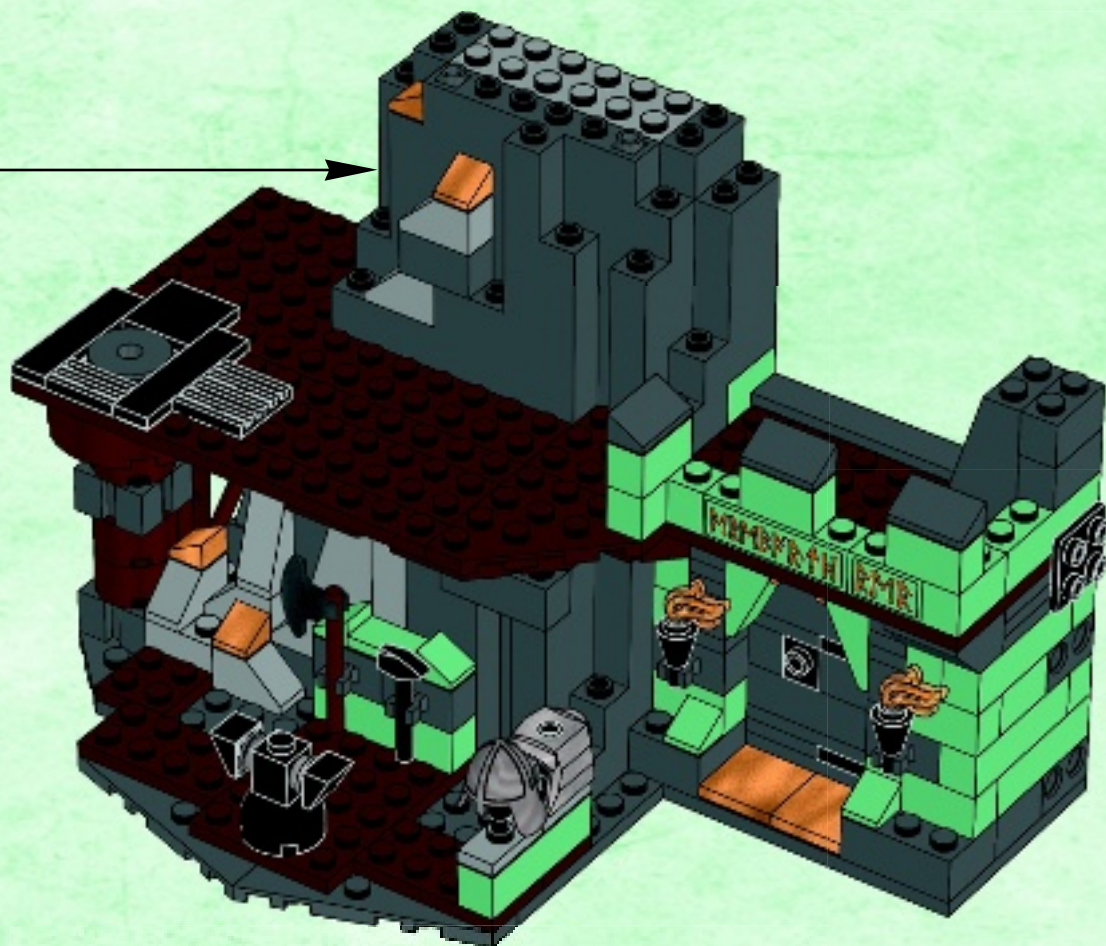

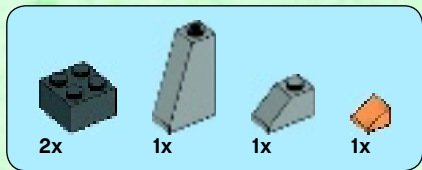

# 44

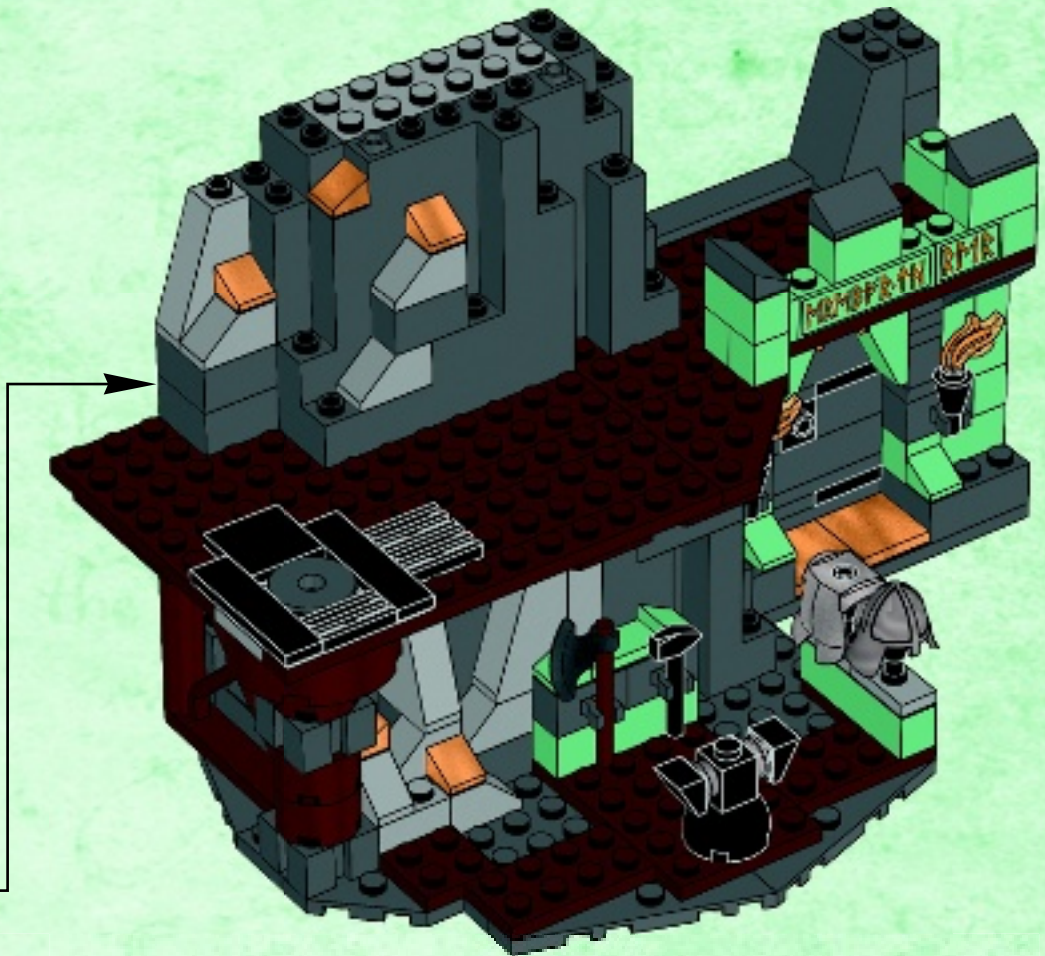
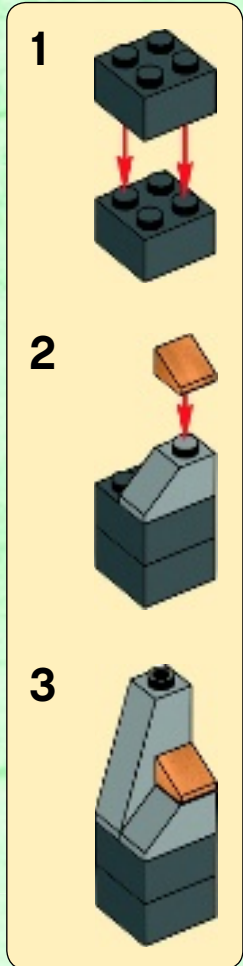



1x



3x

# 45

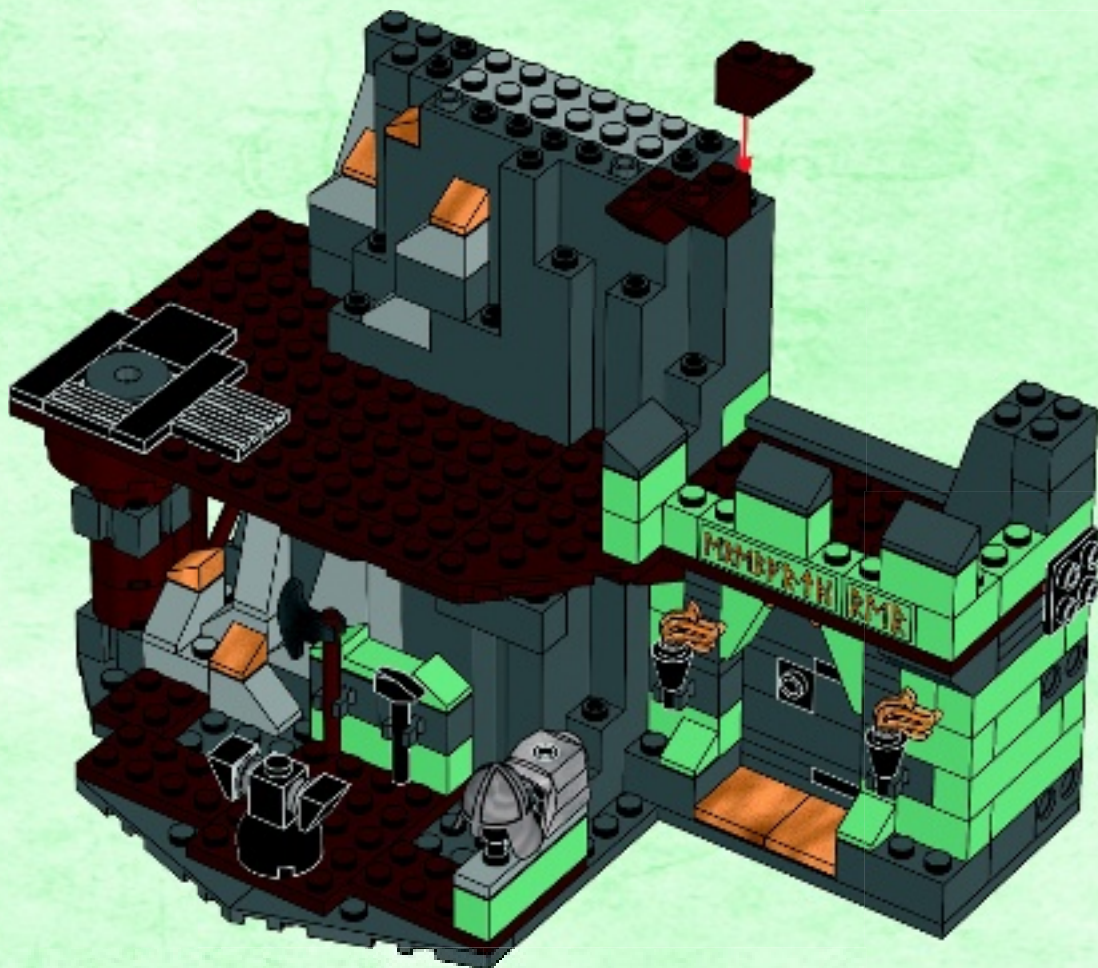

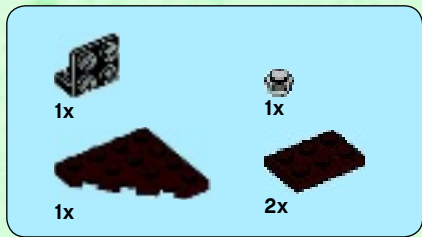

46

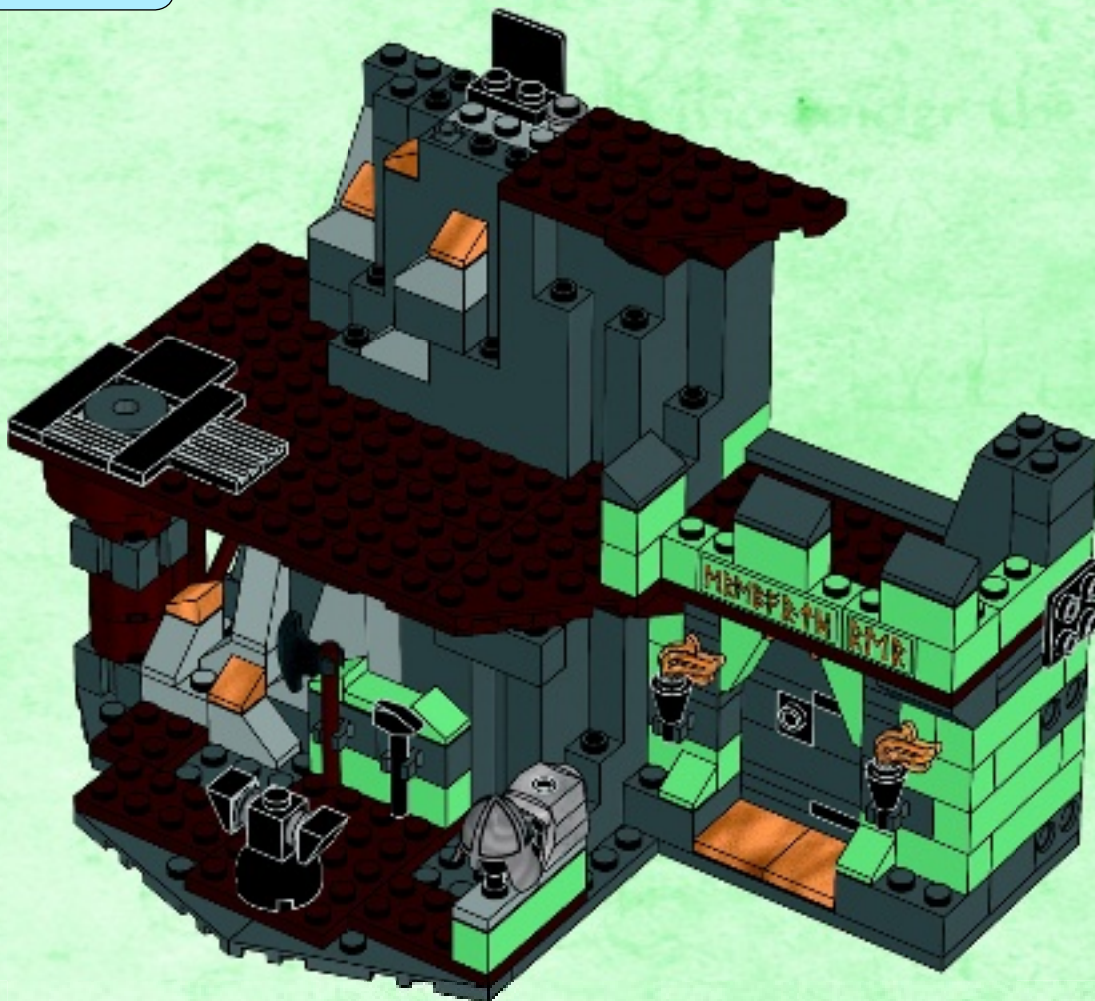



1x



1x



2x

# 47

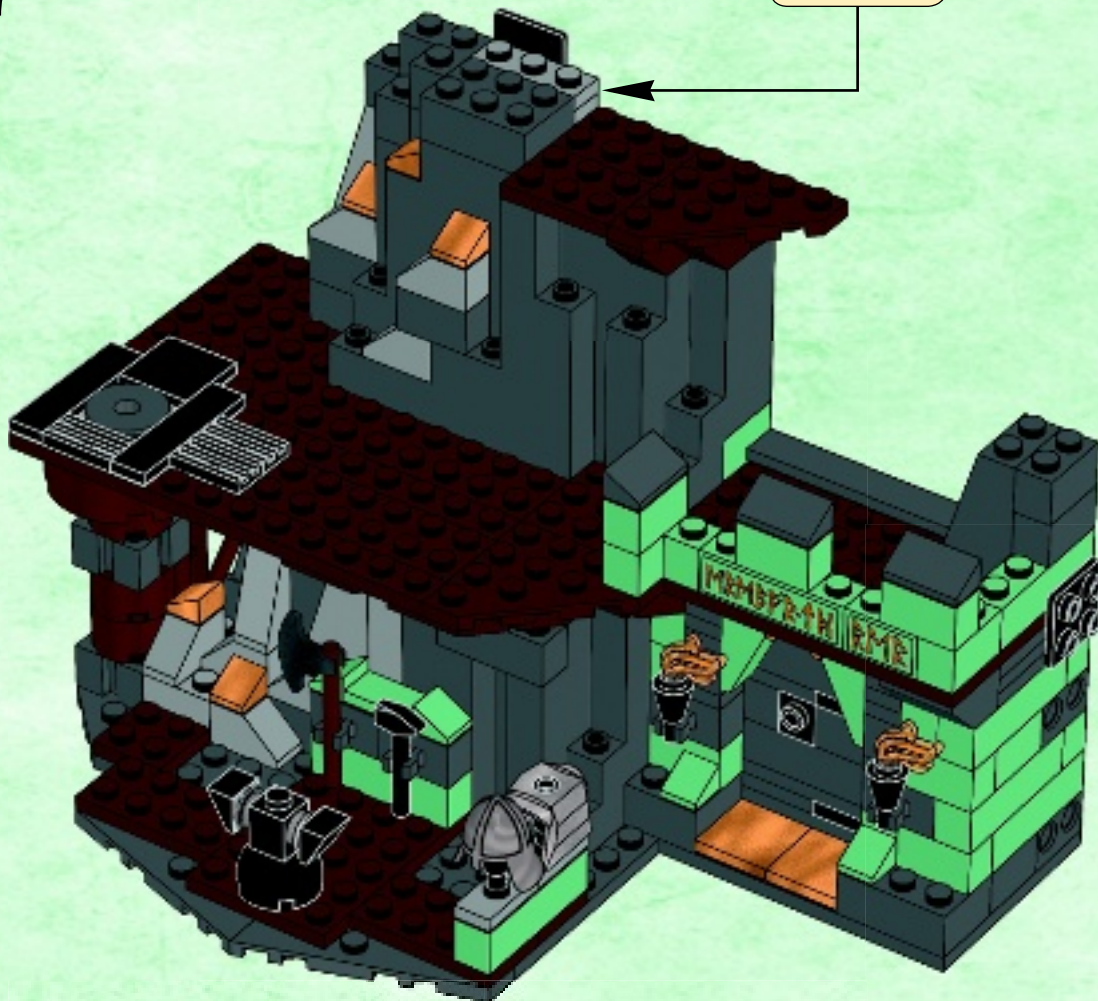
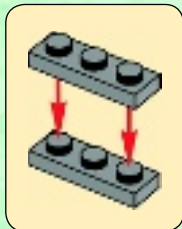

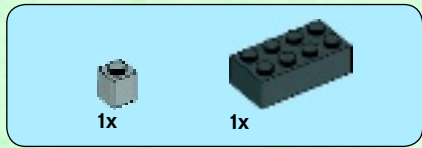

1

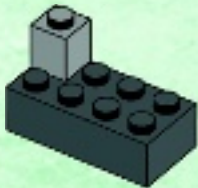

2



3

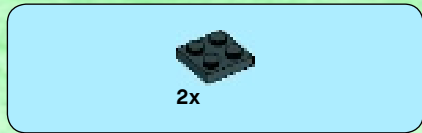
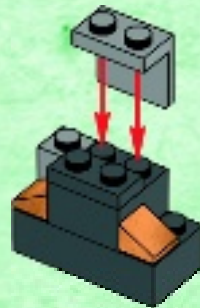

4

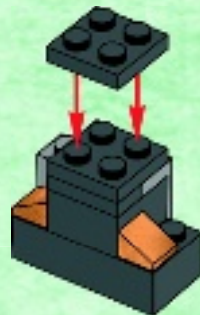

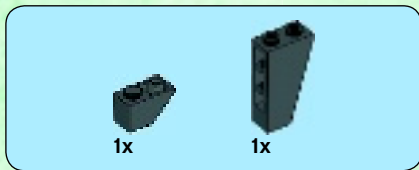

5

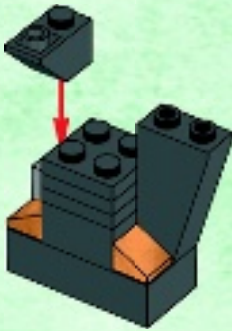

6



7

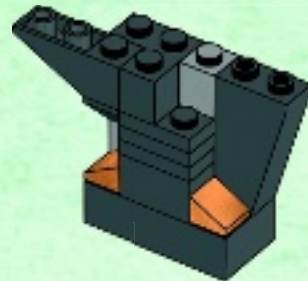

48

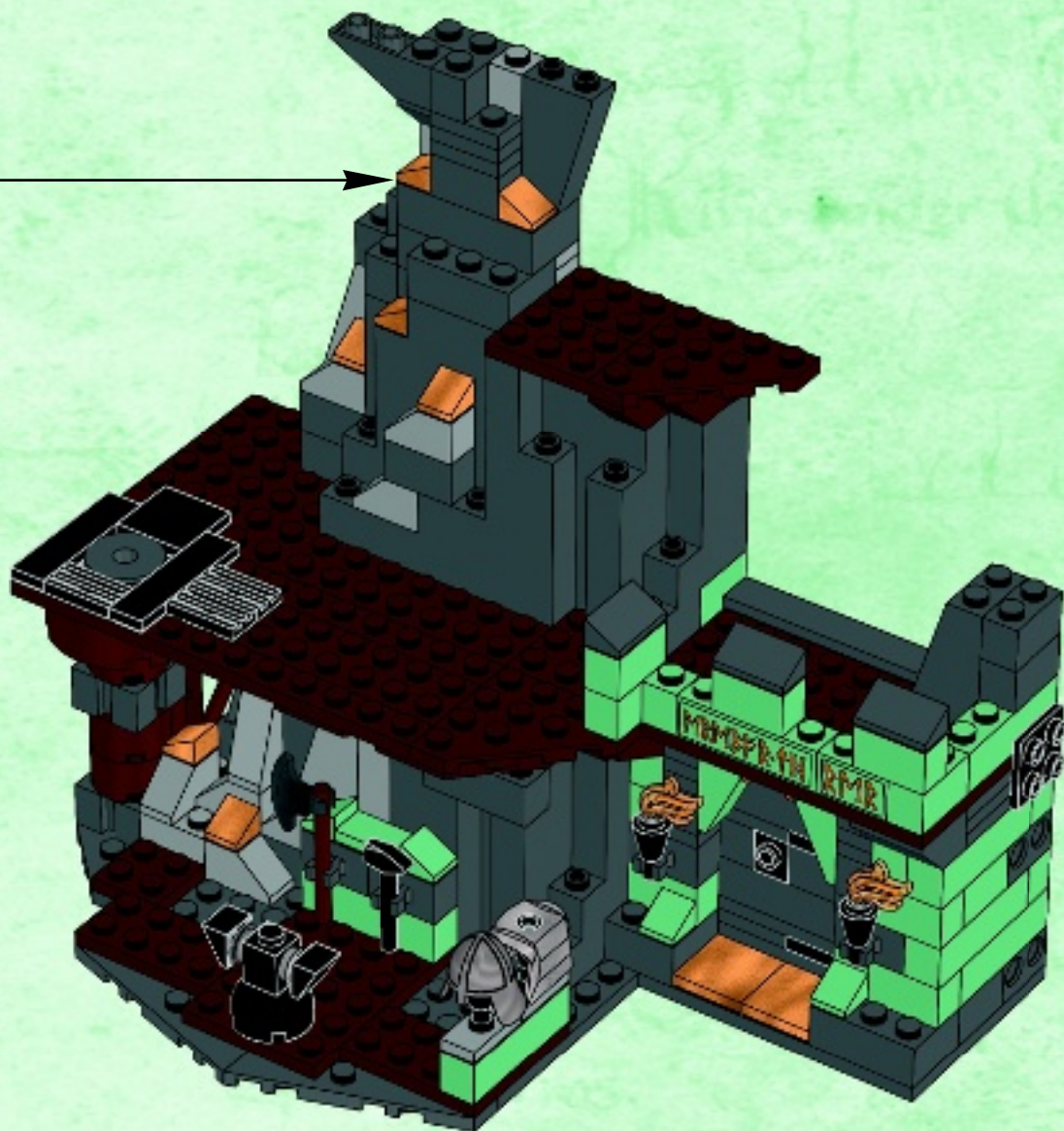



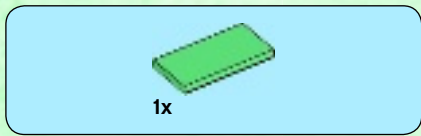

49

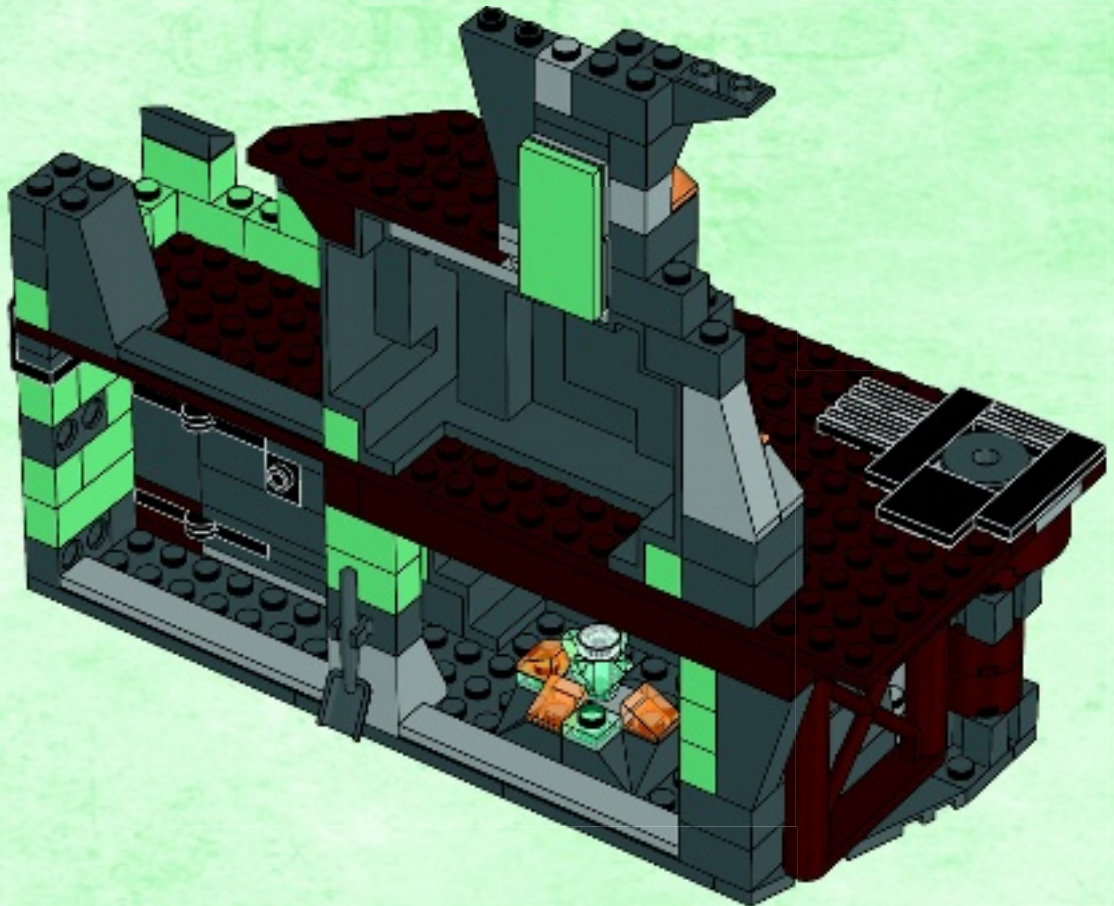
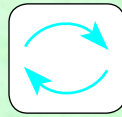



1

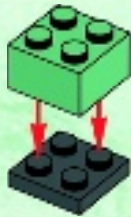

2

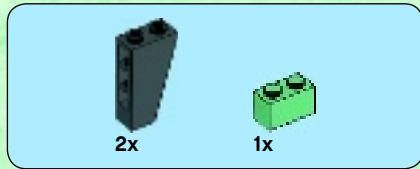
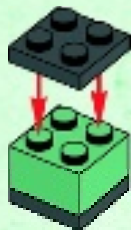

3



4

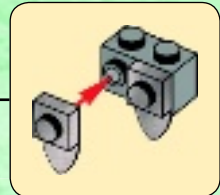
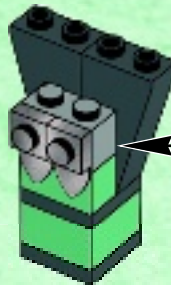

50

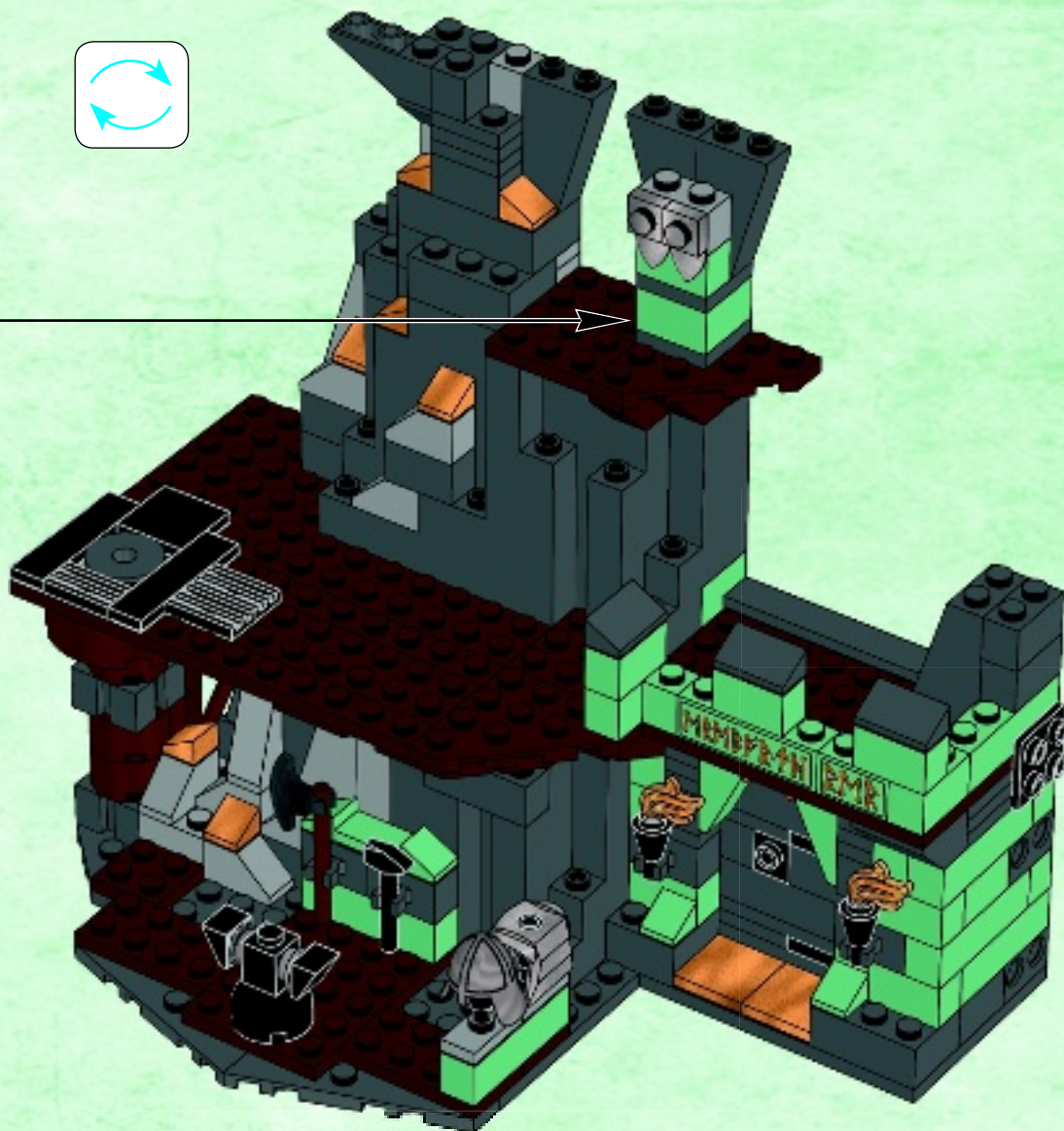
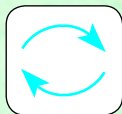

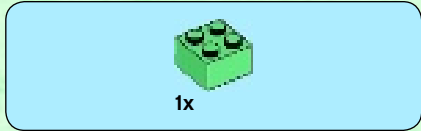

1

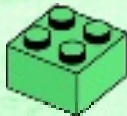

2

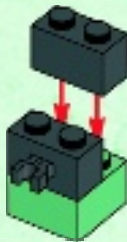

3



4





5

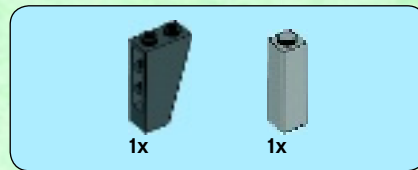

6





1x

7

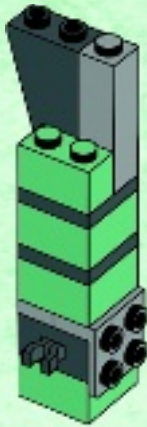

2x



1x

8

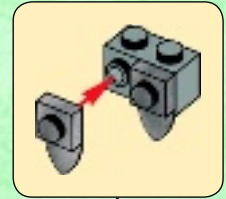

51

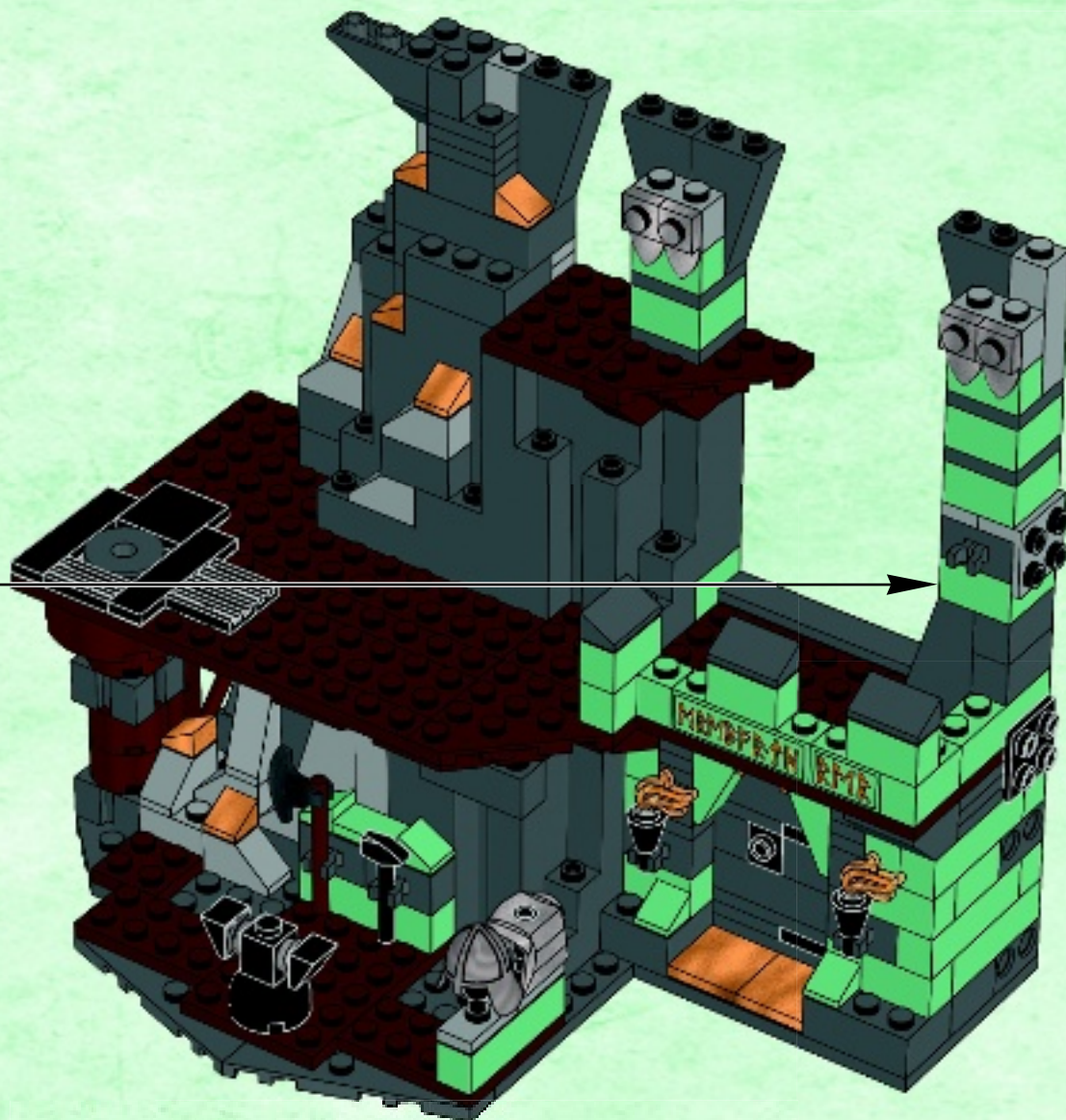

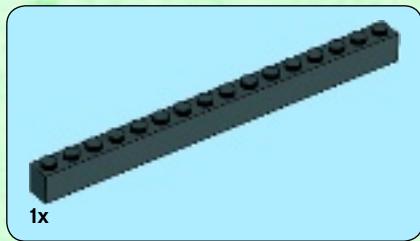

52

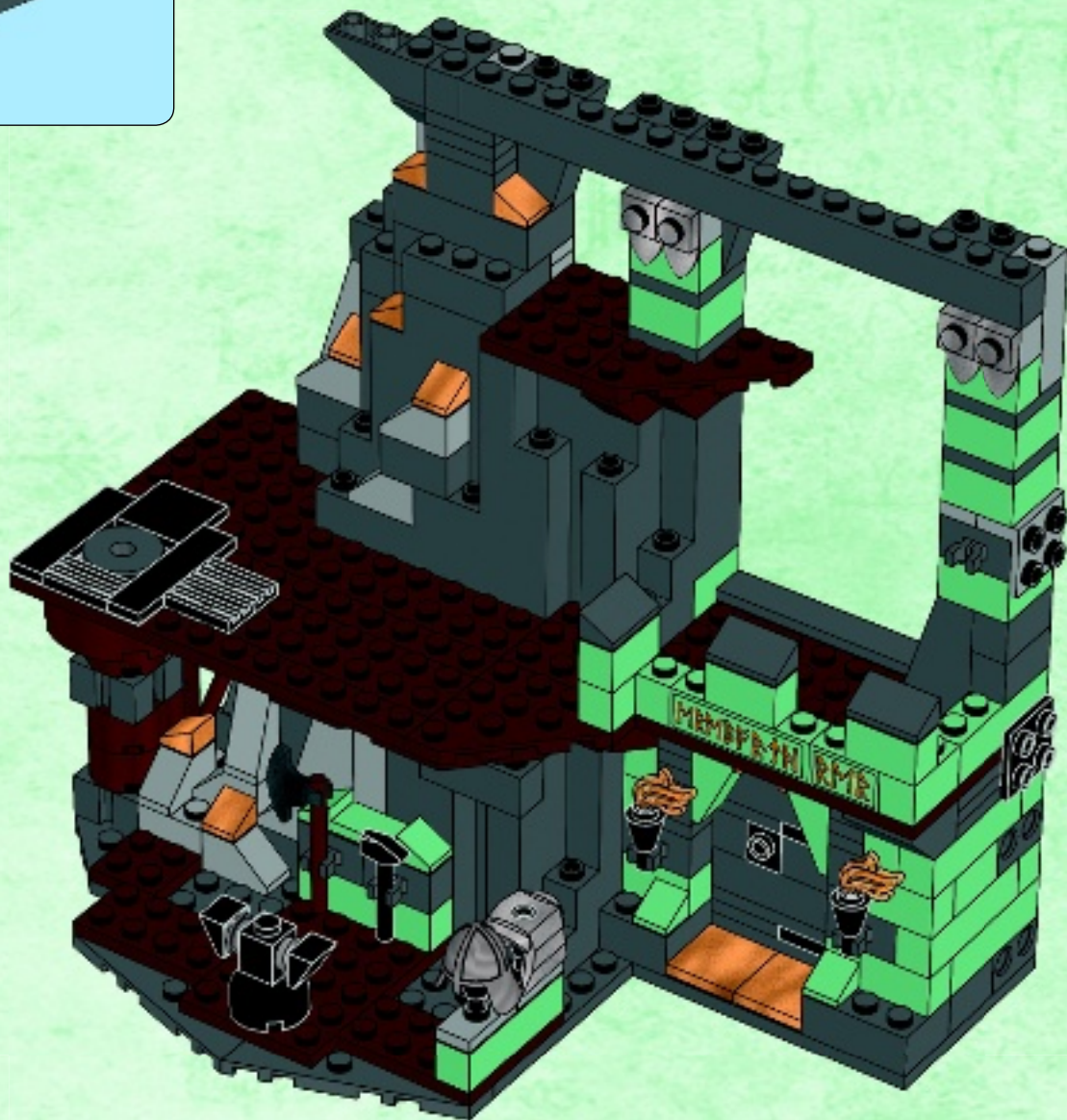





2x

53

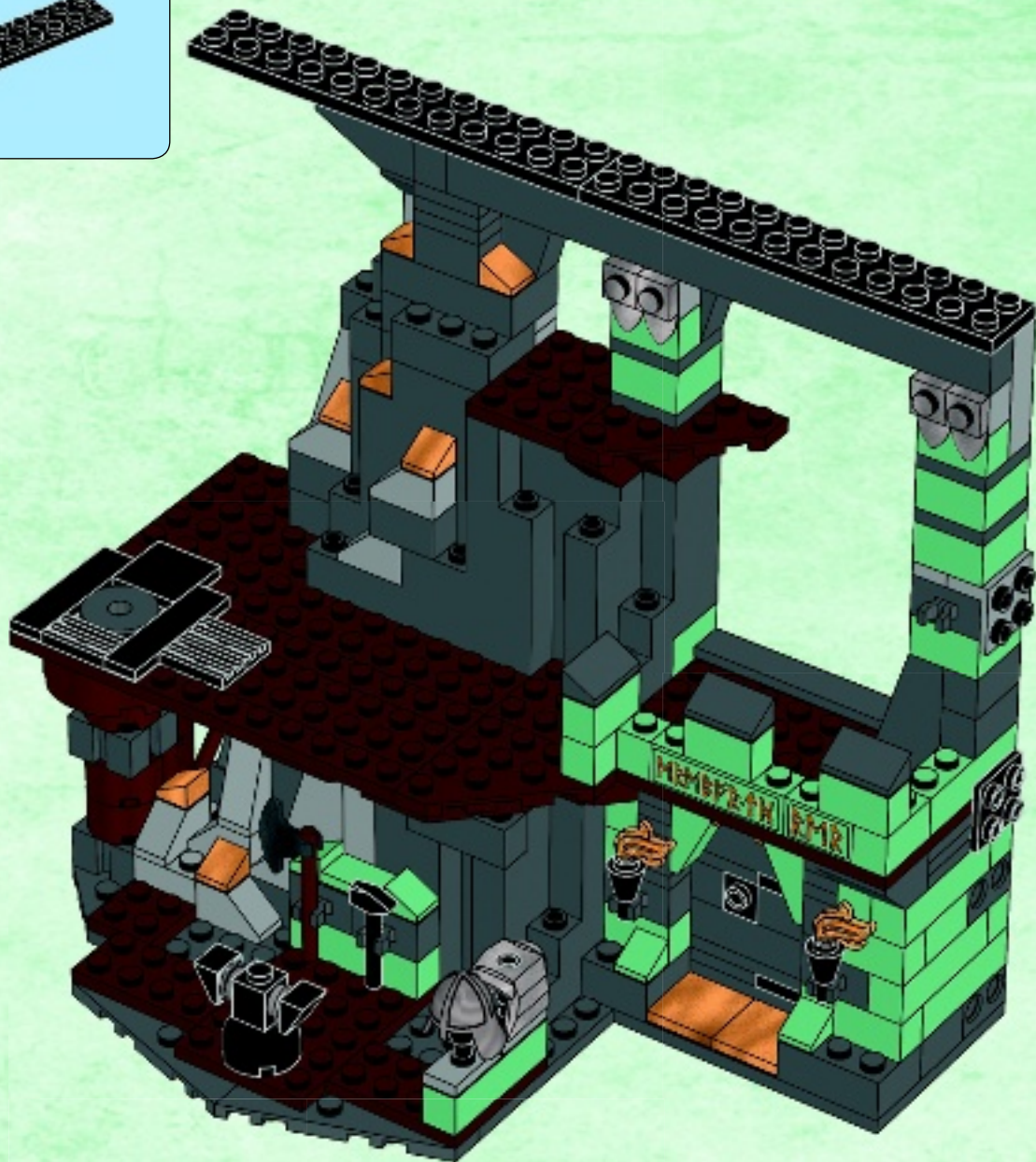

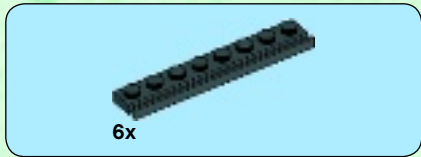

54

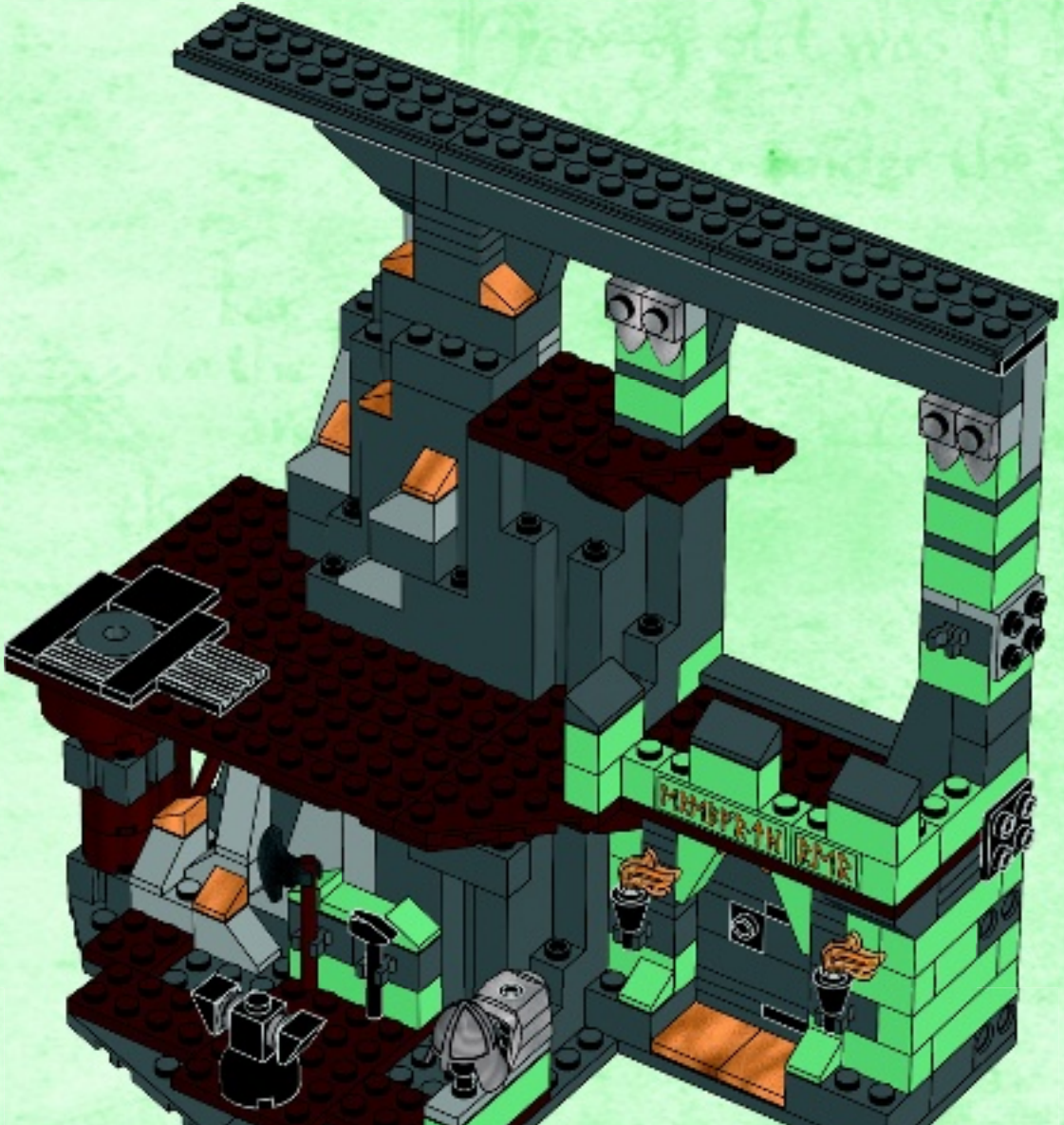



2x

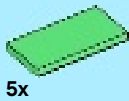

5x



1x

# 55

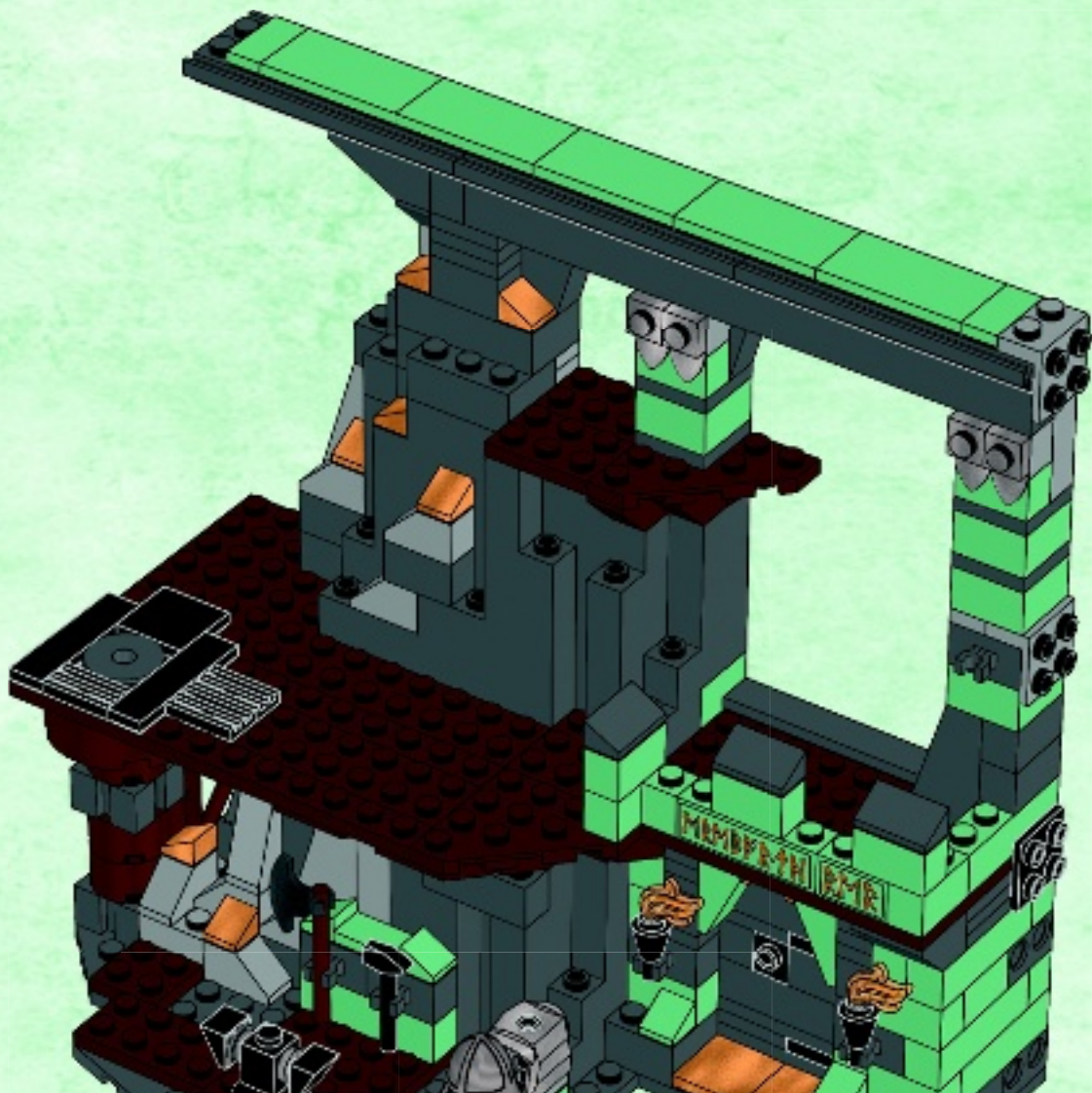

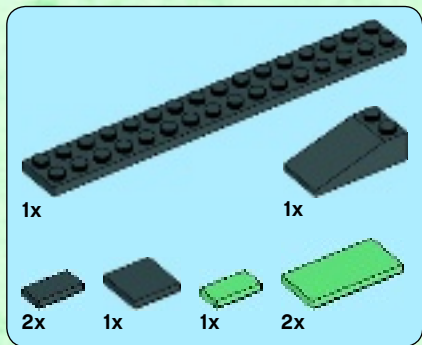

56

1

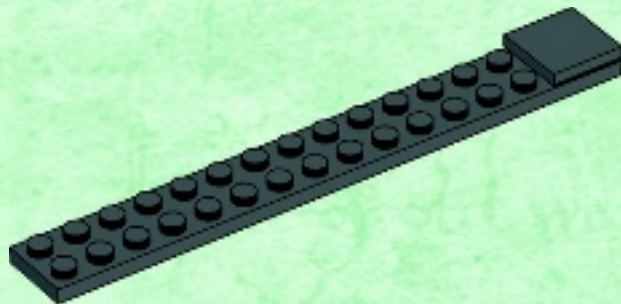

2

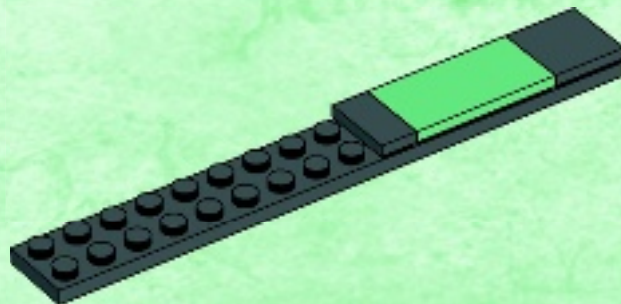

3

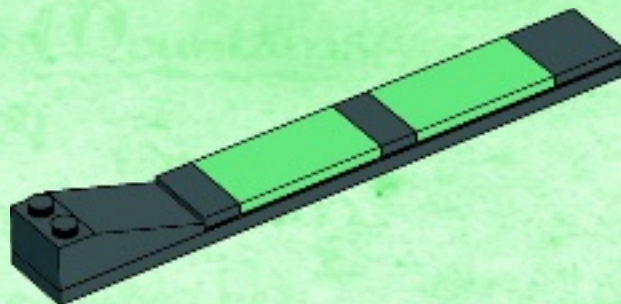

4

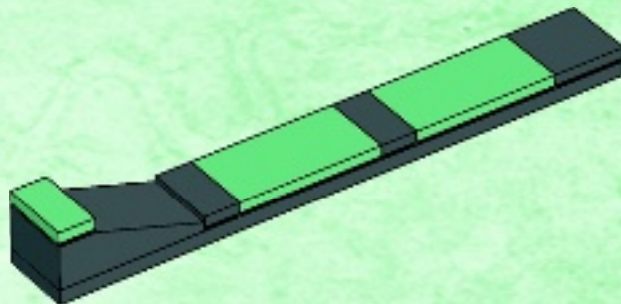

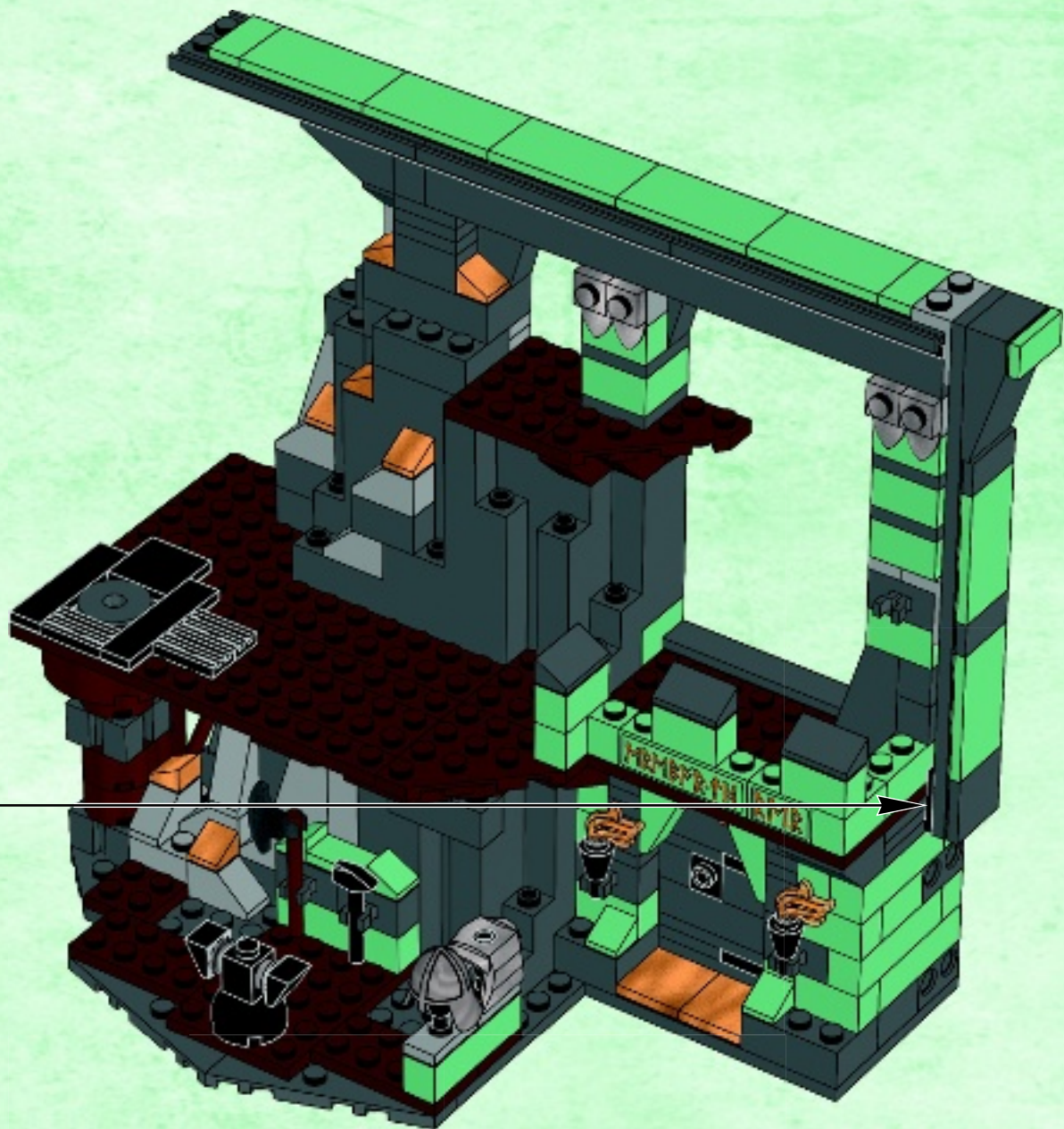



3x



2x



1x

# 57

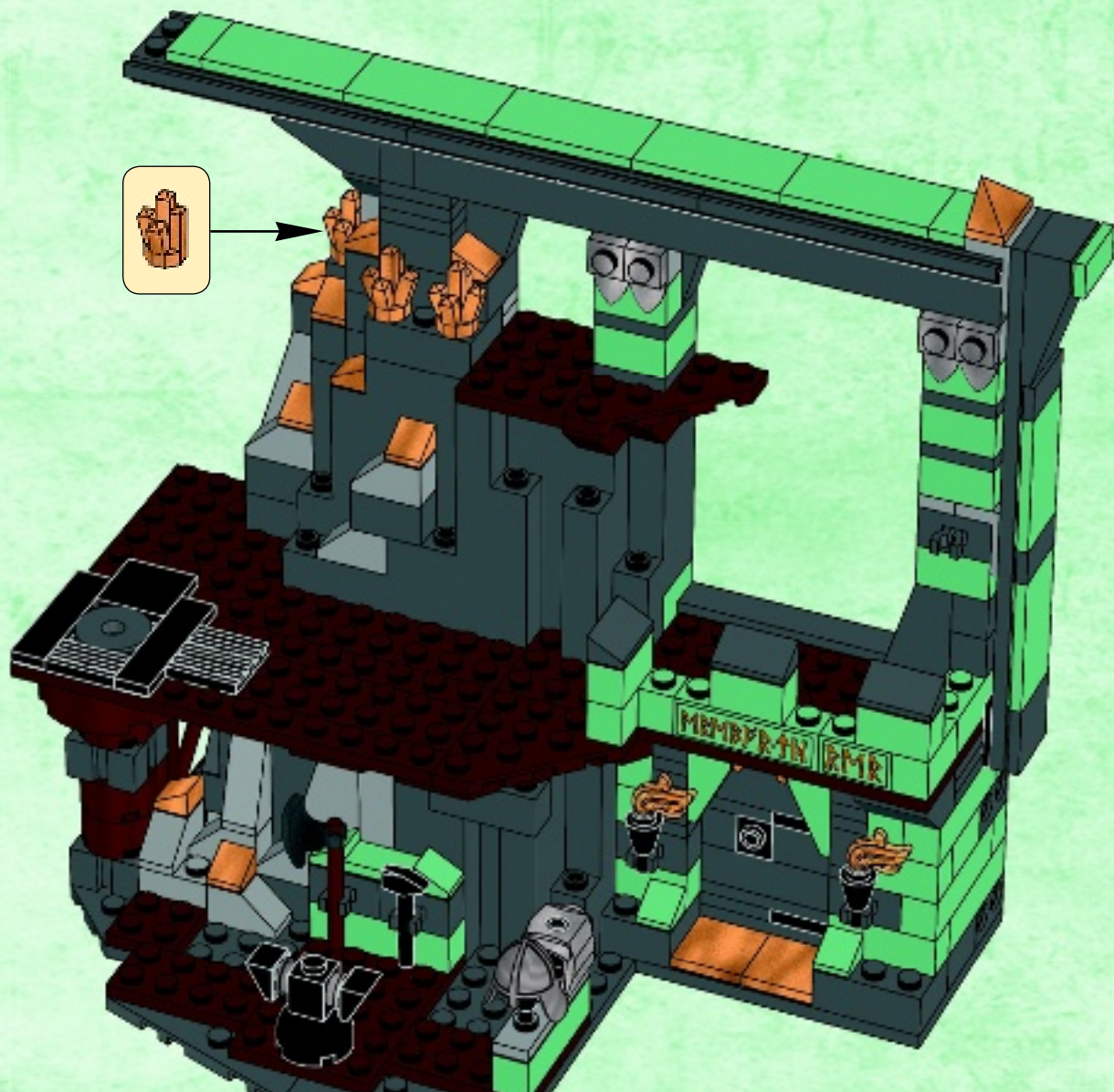

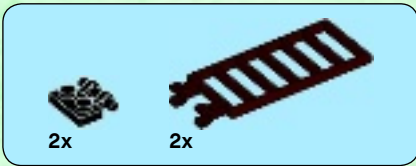

# 58

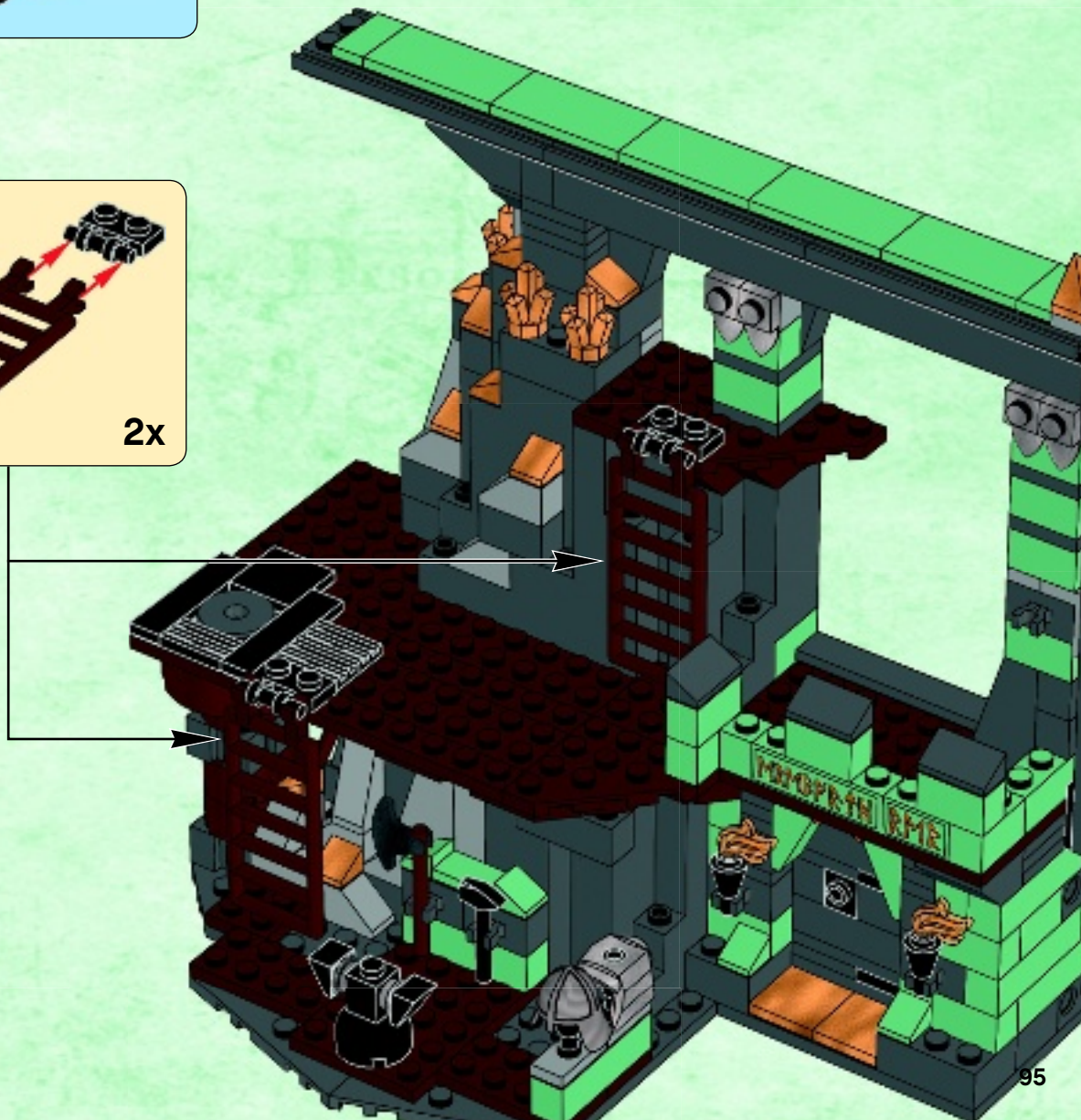
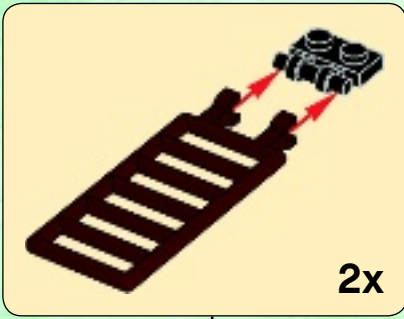



# 59

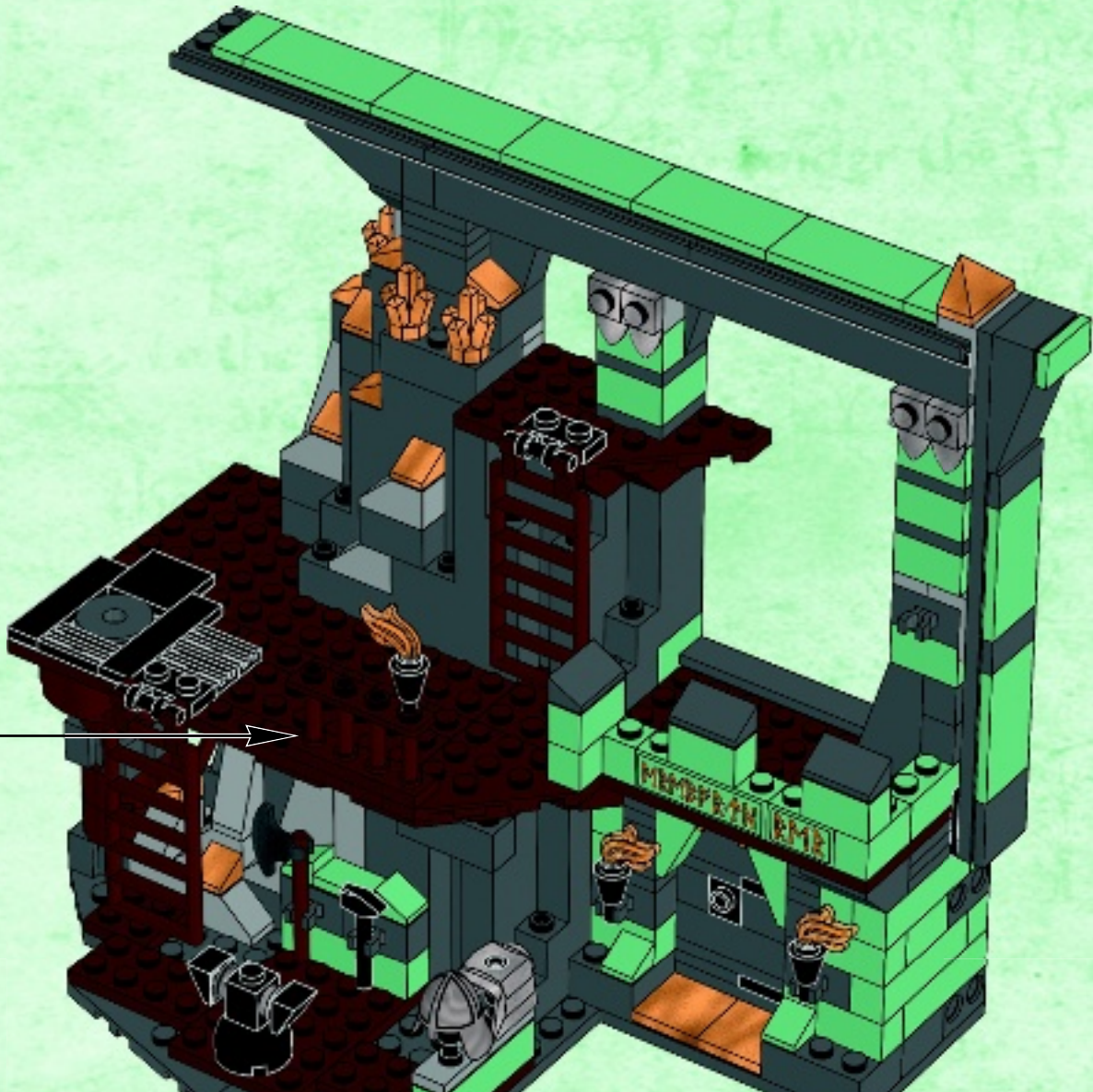
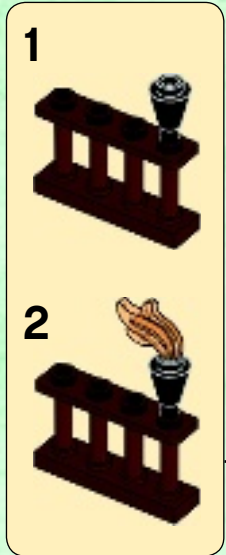



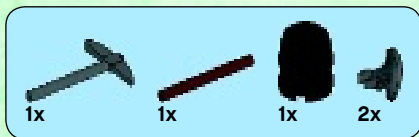

60

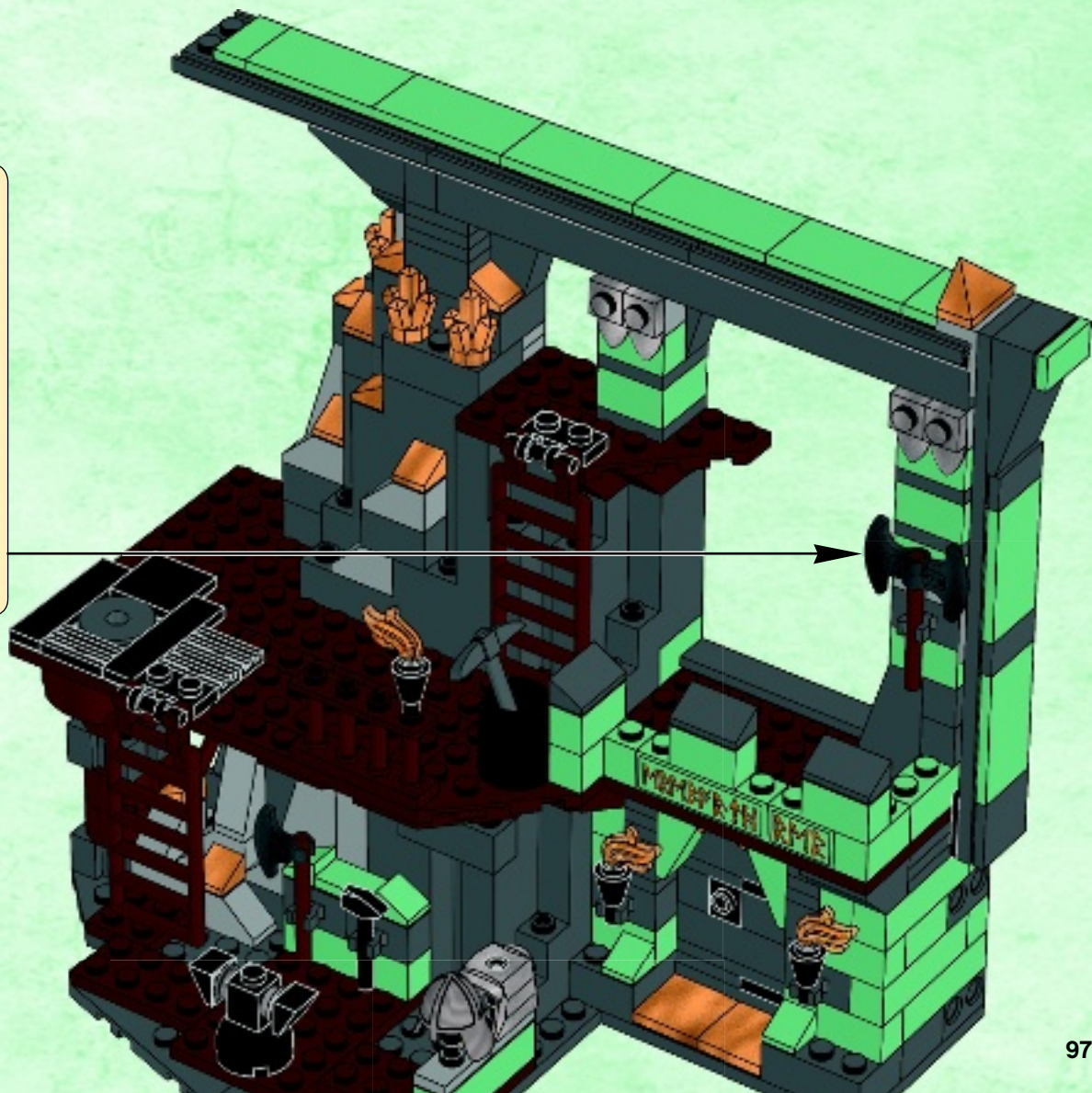
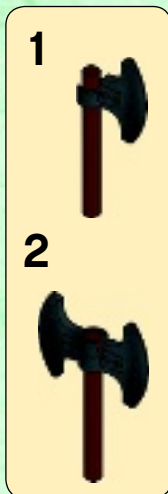

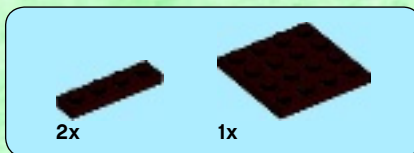

1

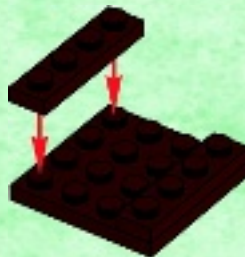

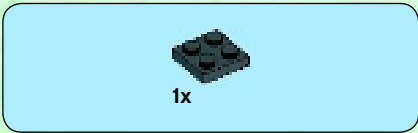

2

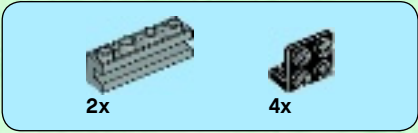

3

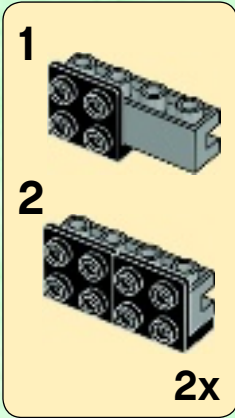
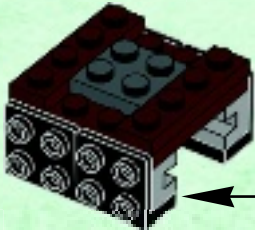

4

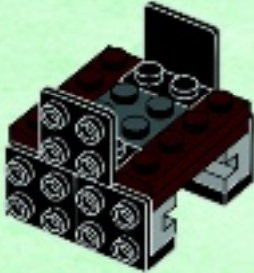



5

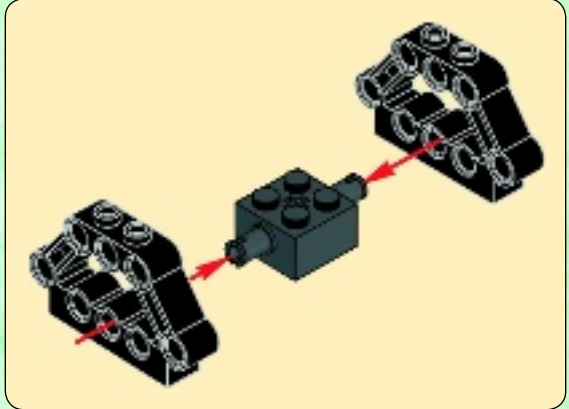

6



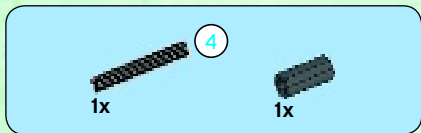

7

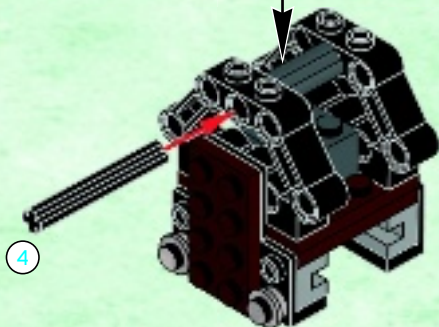

8

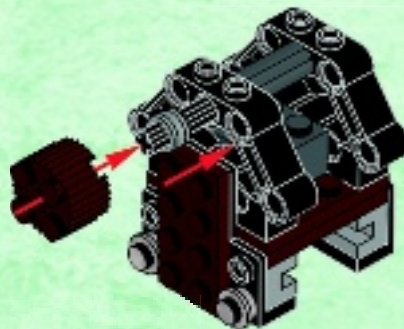

9

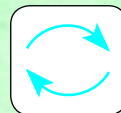



1x



1x

# 10

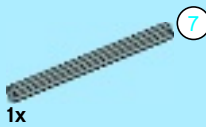
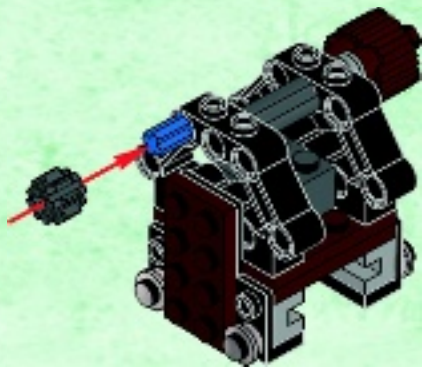

1x

7

# 11

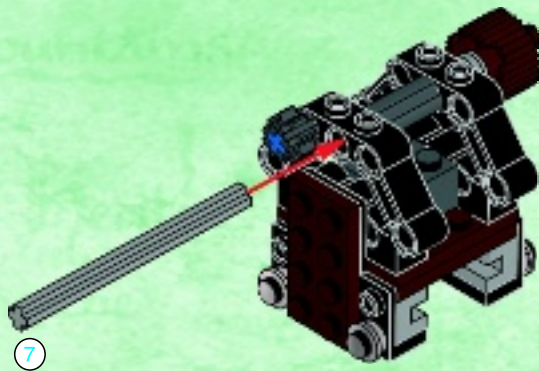

7

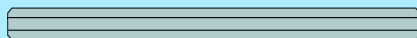

7

# 1:1

1x



1x

# 12

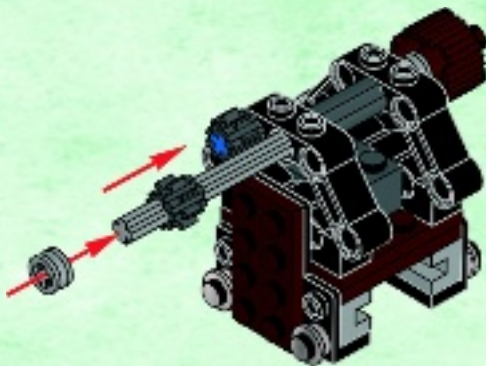

1x



1x

# 13

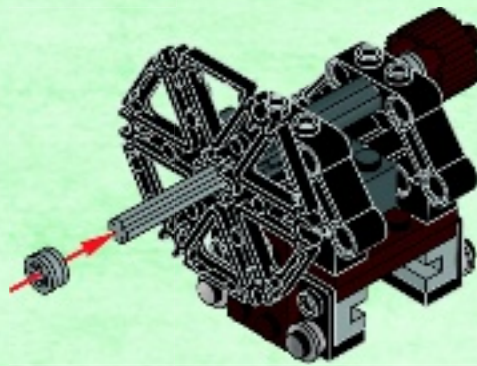



1x



1x

14

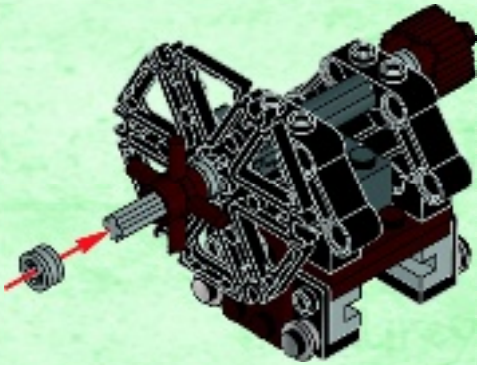

1x

15

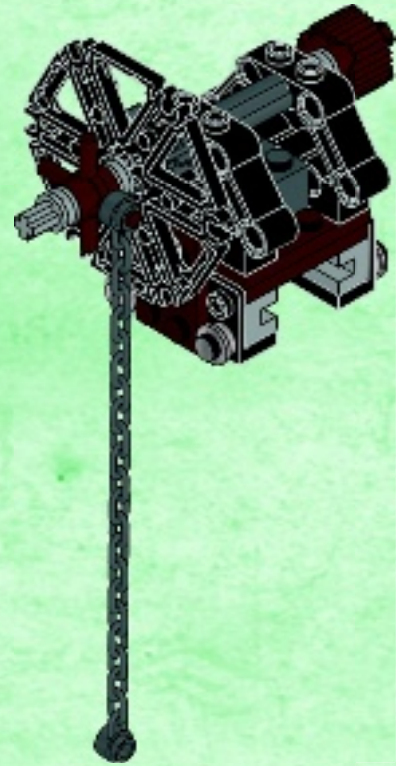





# 16

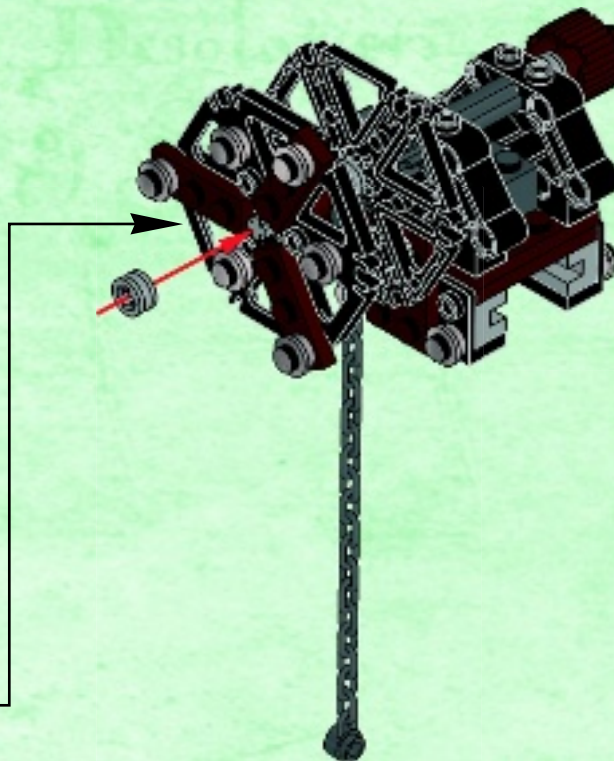
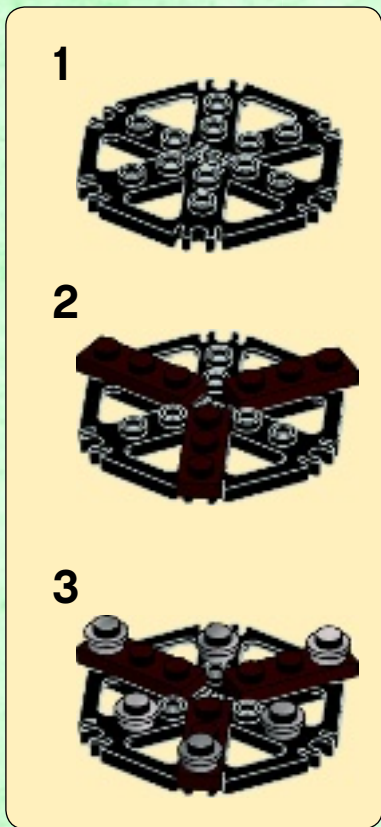

61

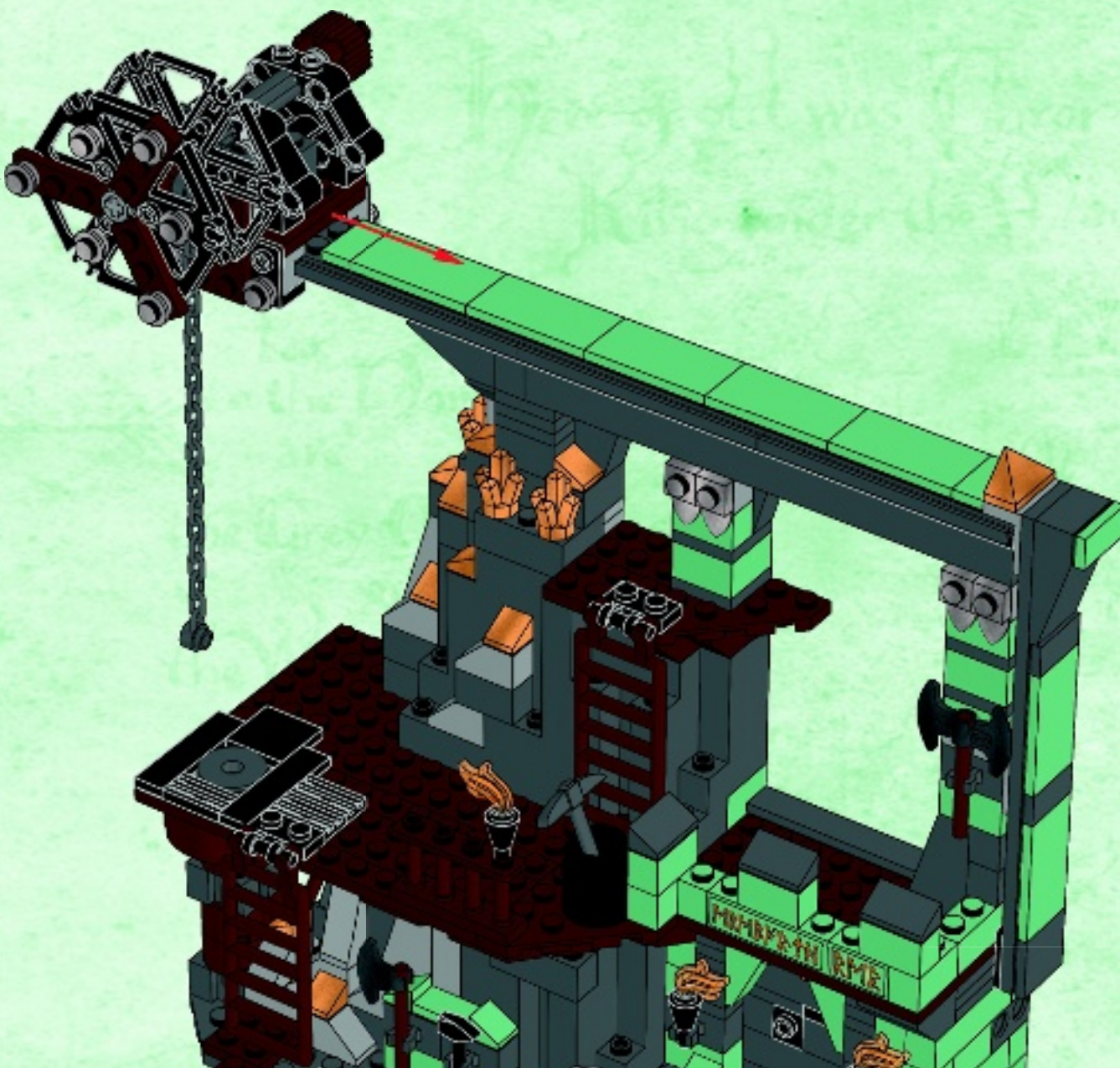
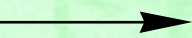



1x

62

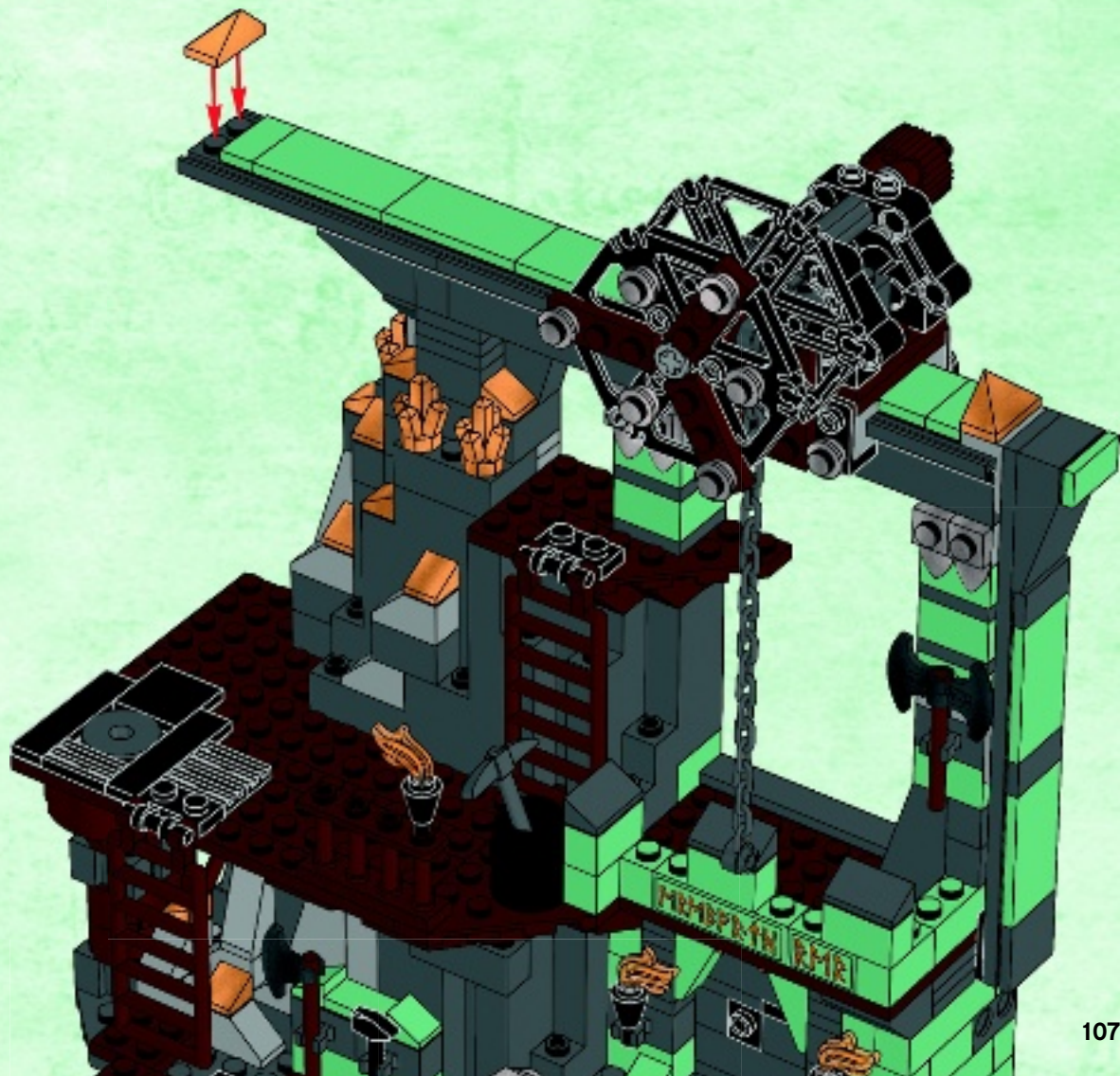

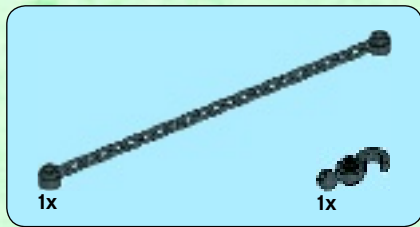

63

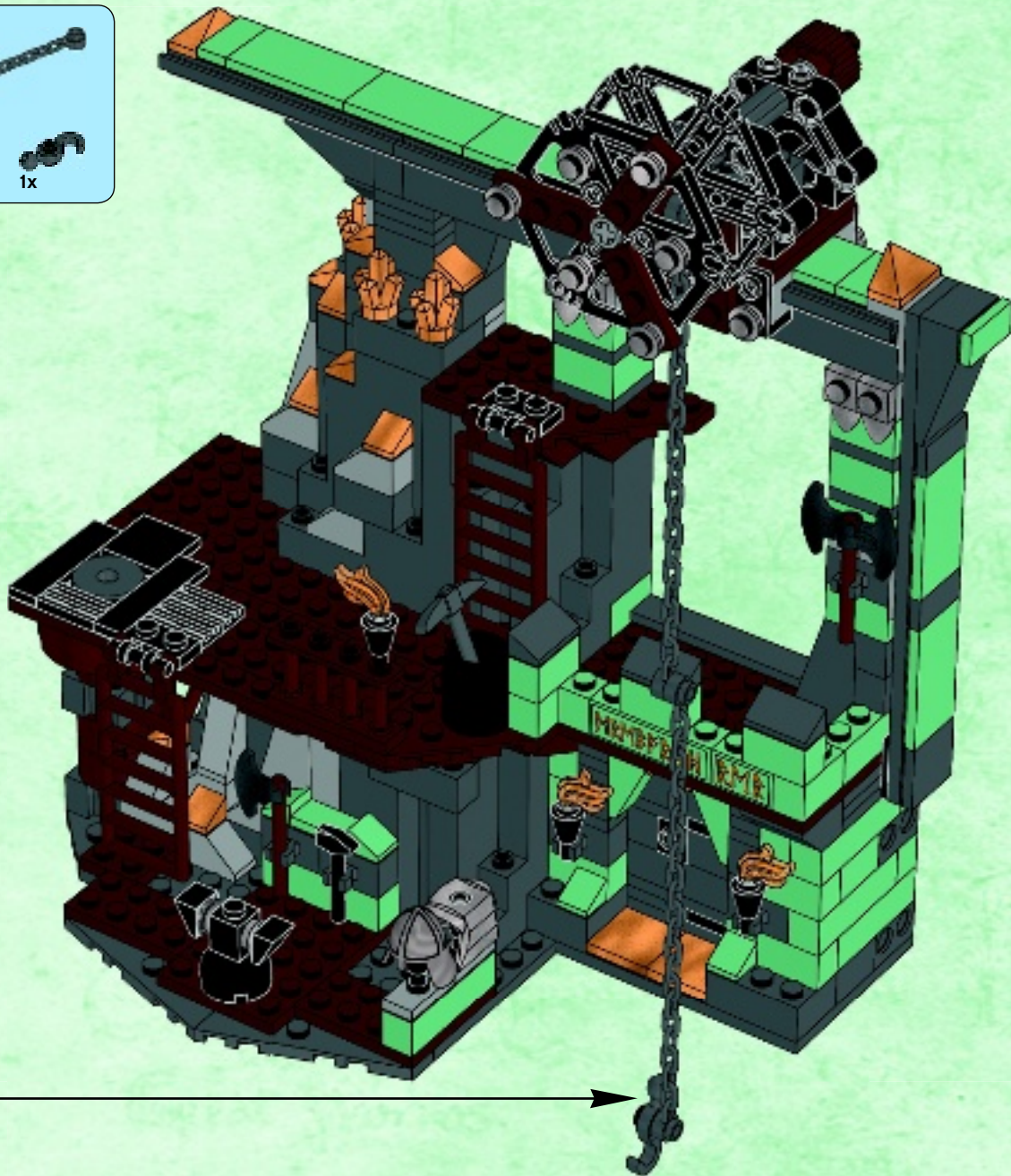
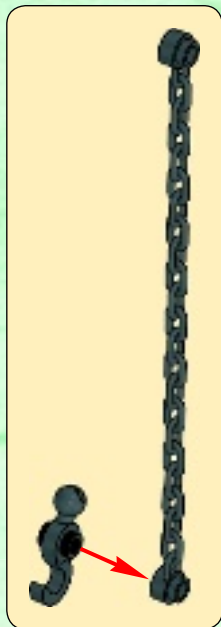



1x



2x



1x

# 64

1



2

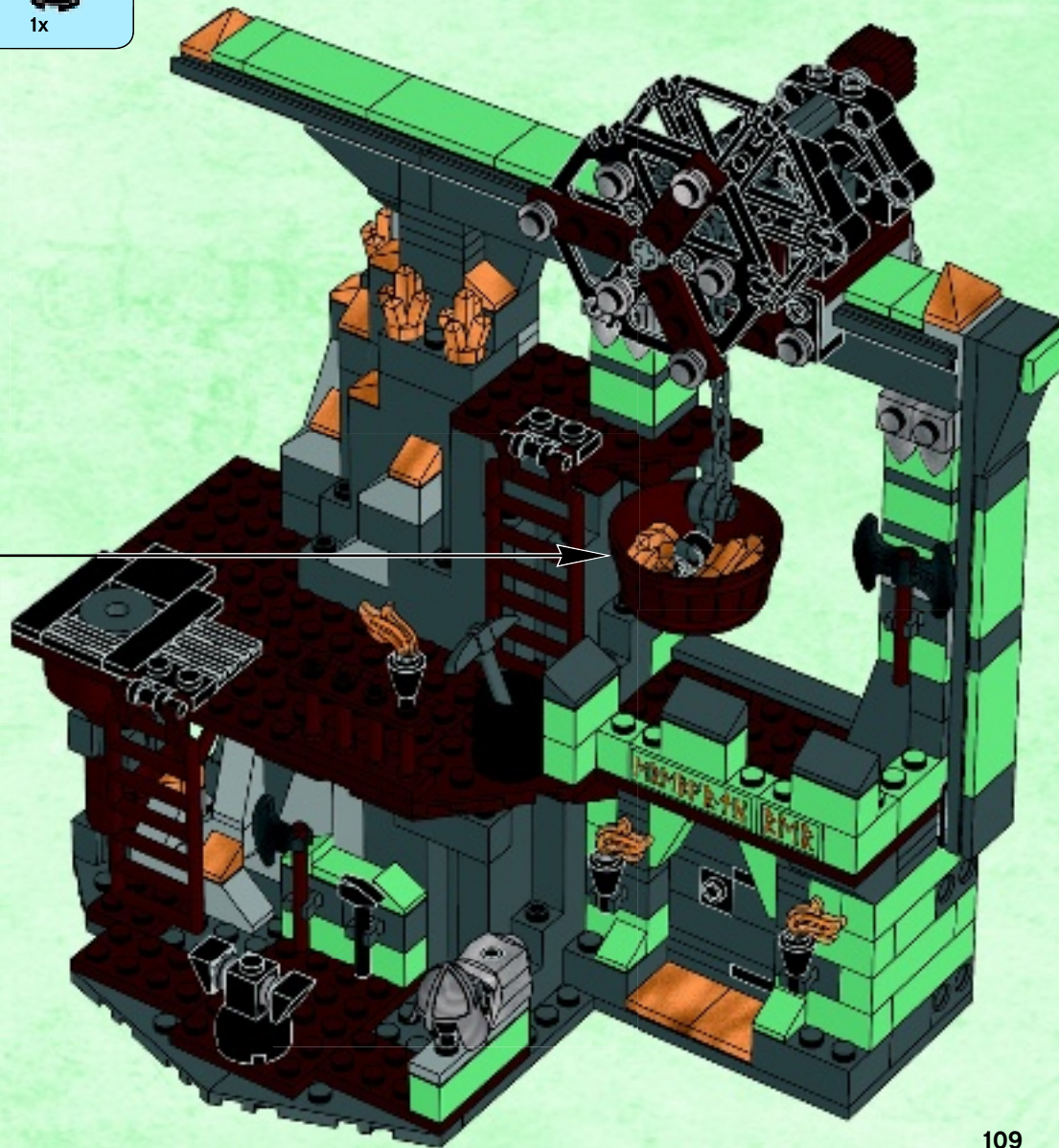

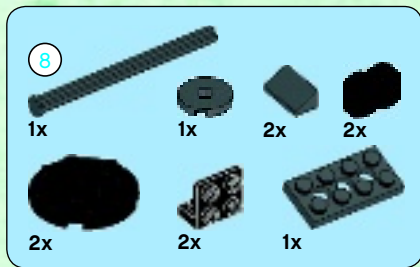

65

1



2



3



4

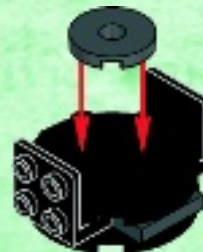

5



6

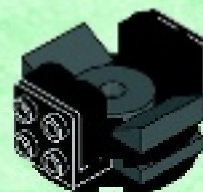

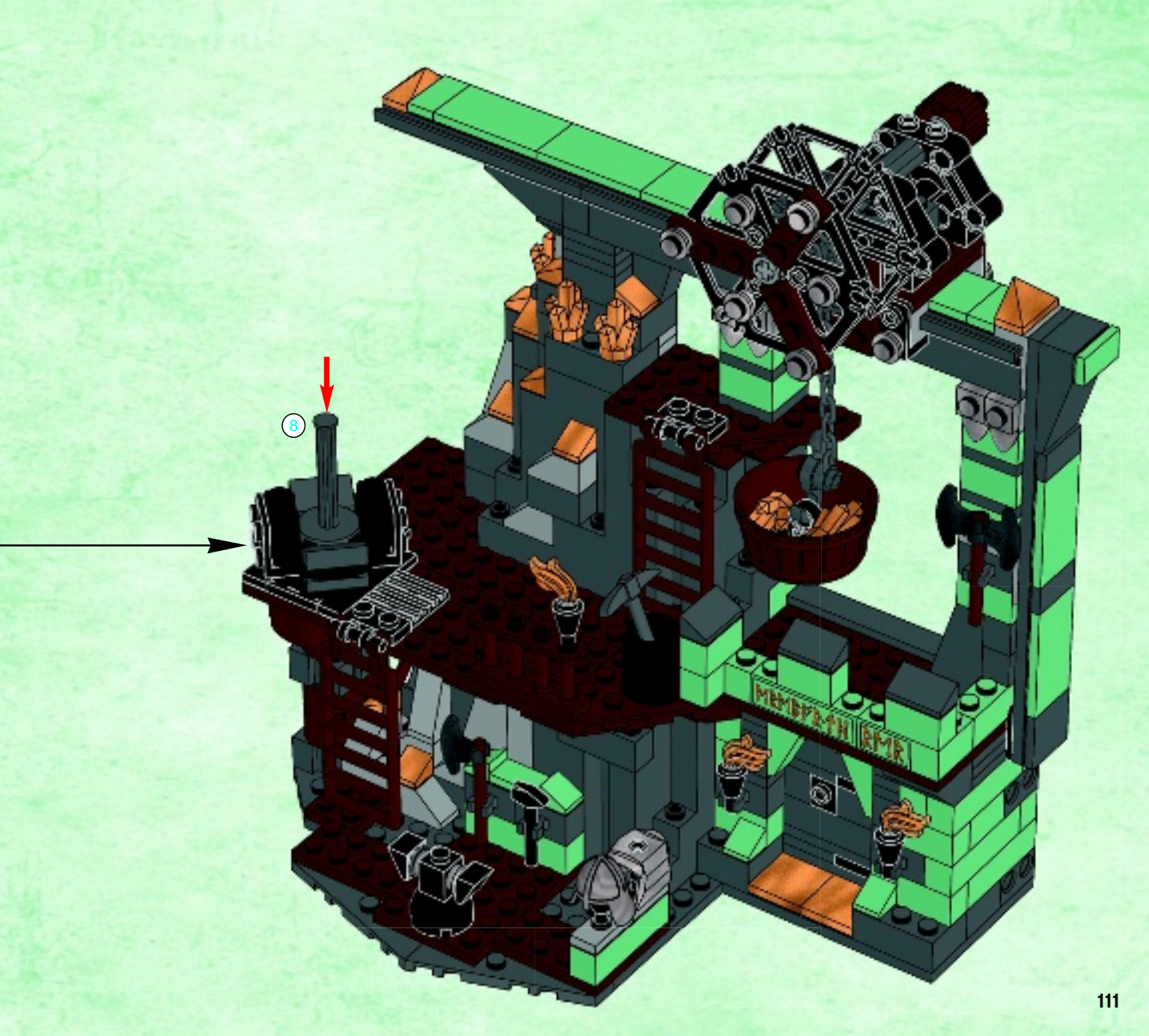



1x



2x

1



1x

2

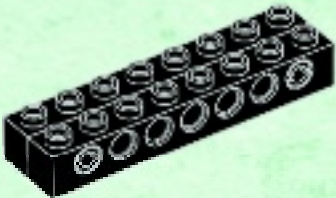

2x

3

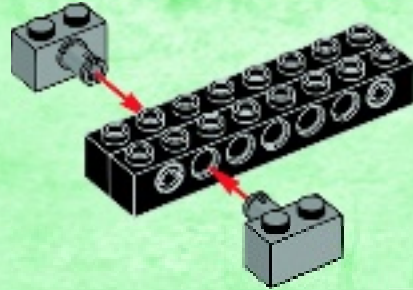

2x



1x

4

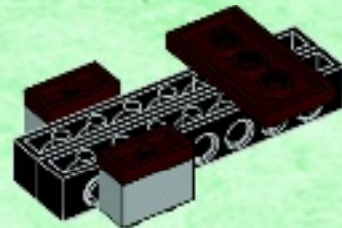
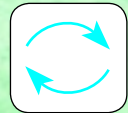





4x



4x

5

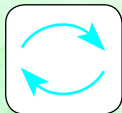

4x



1x



2x

6

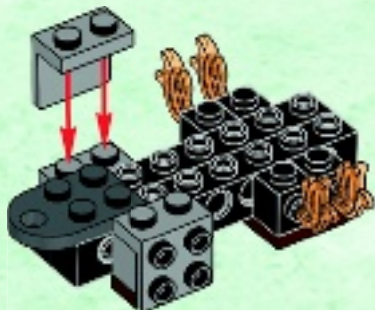

1x



1x

7

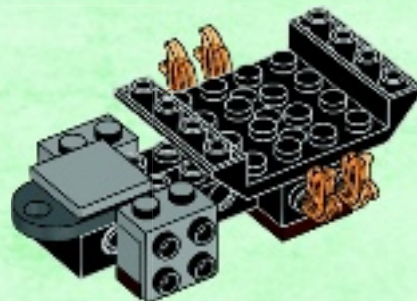



8

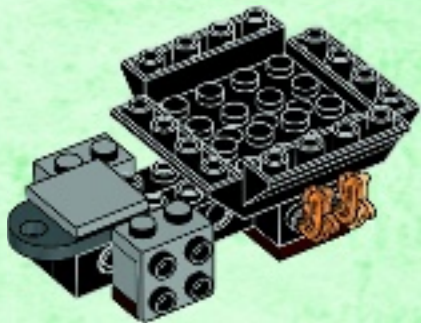

9

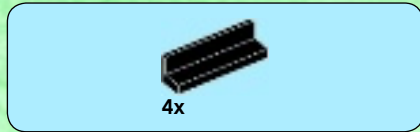
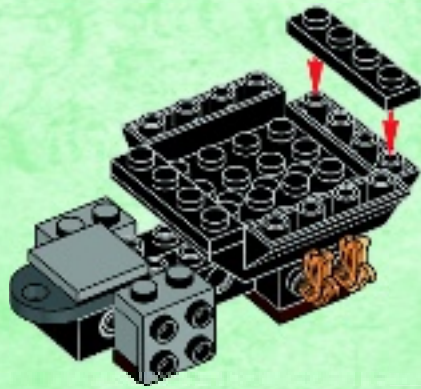

10

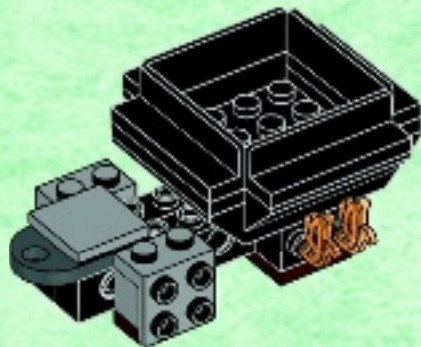

66

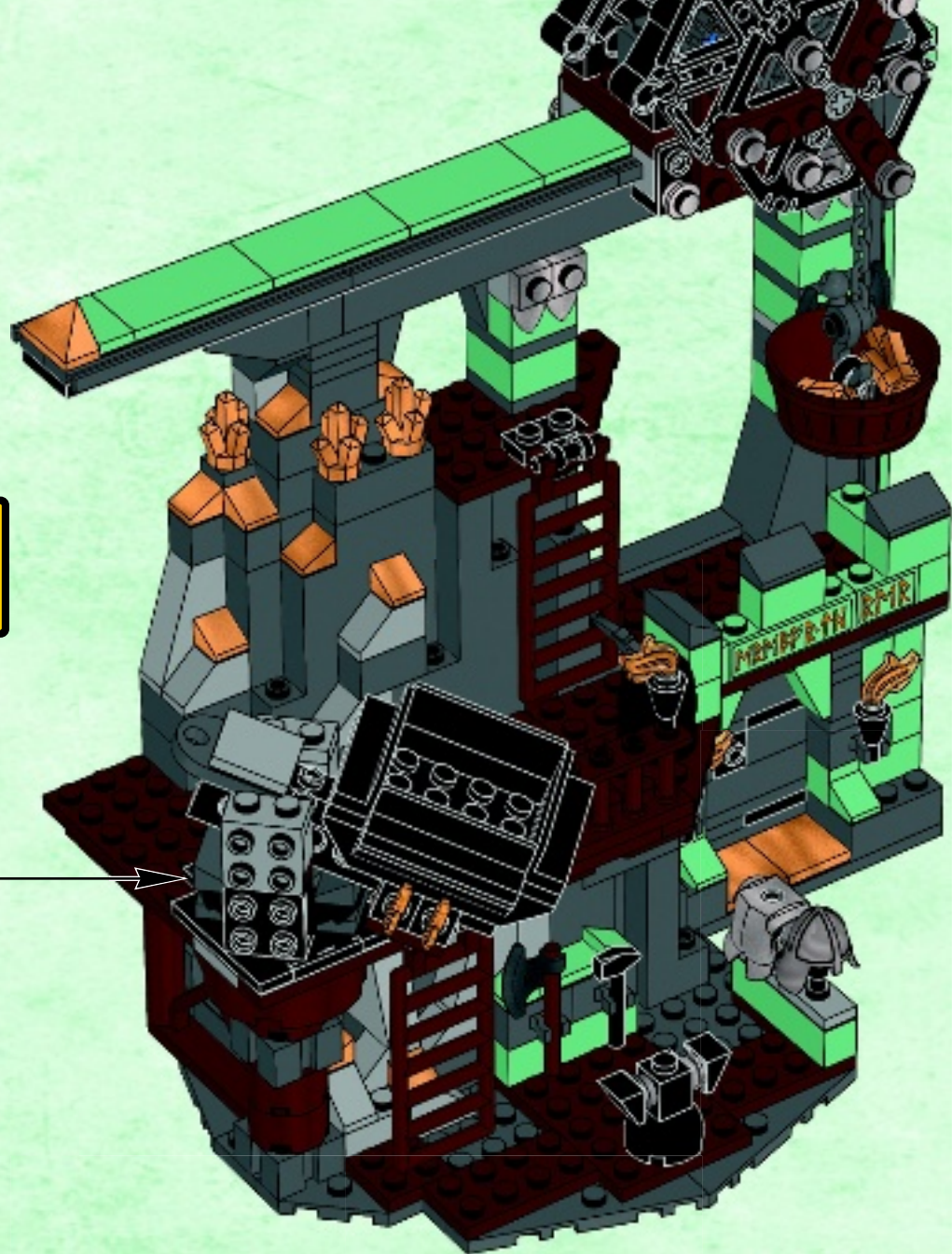

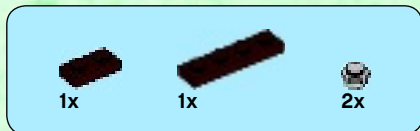

67

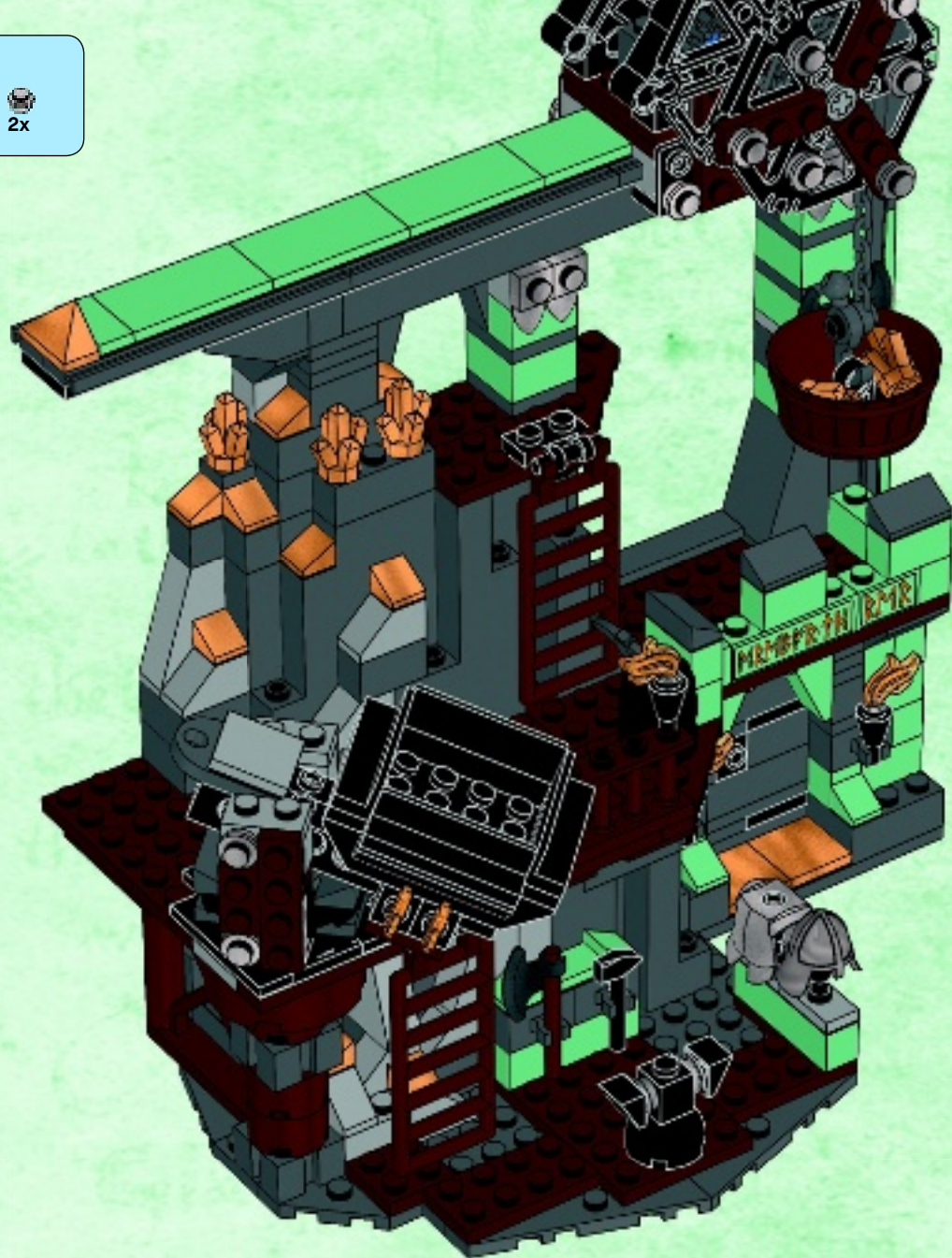



68

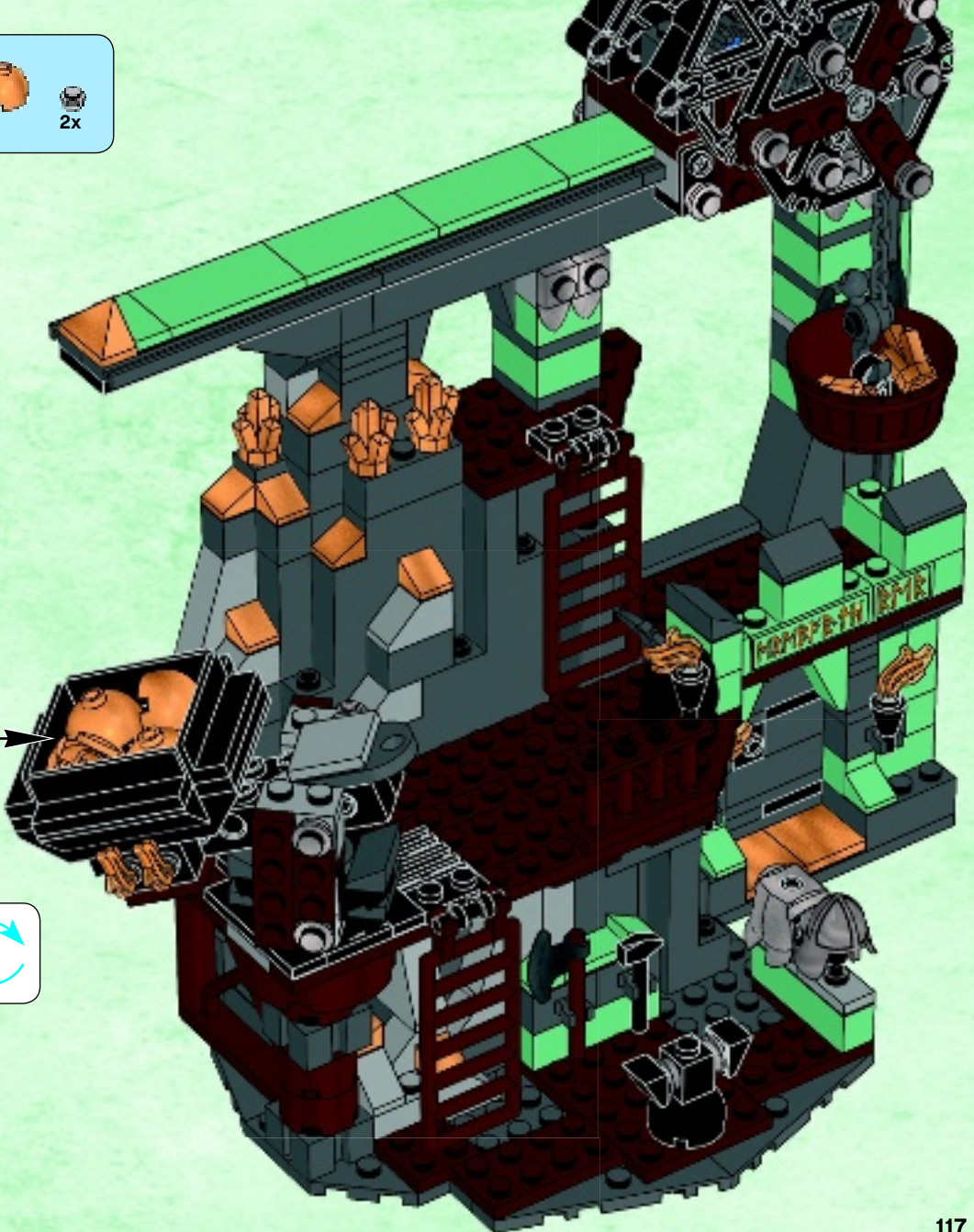
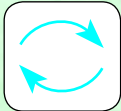

69

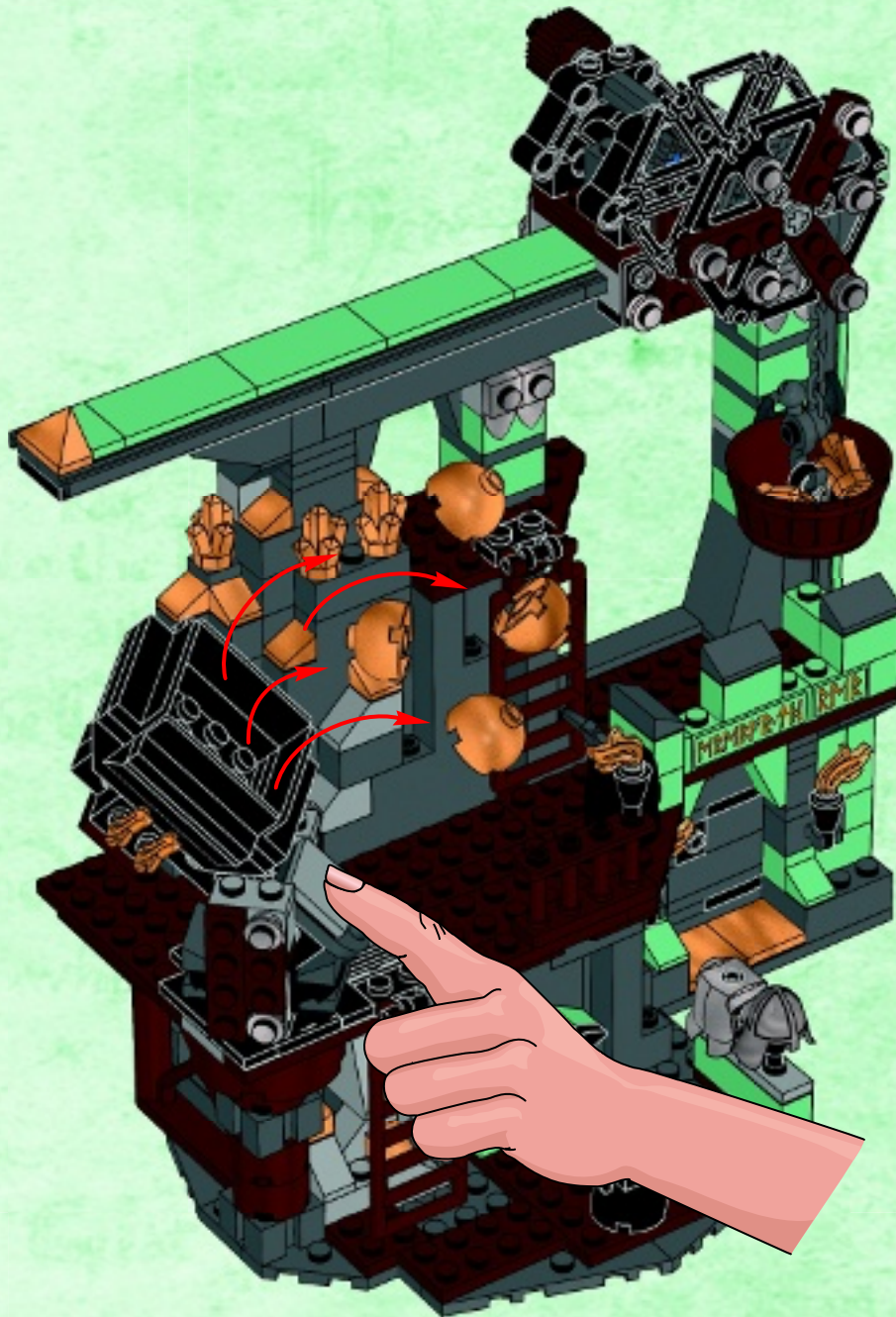

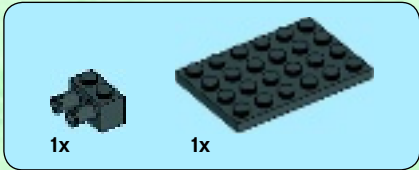

**1**



**2**

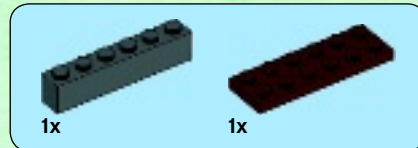
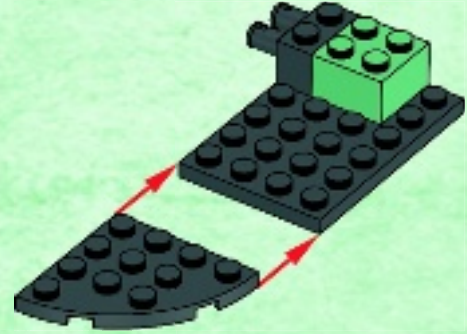

**3**

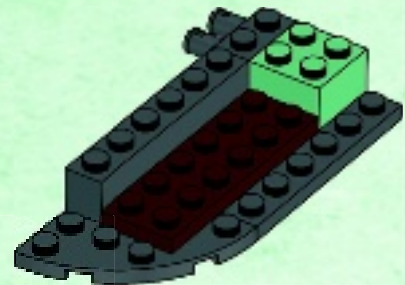



4

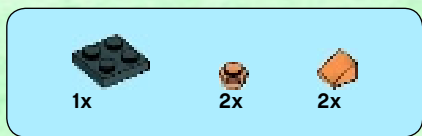
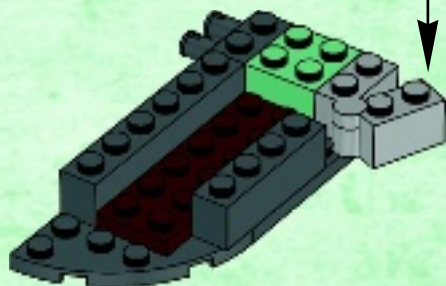
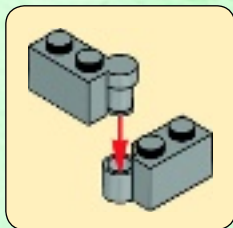

5

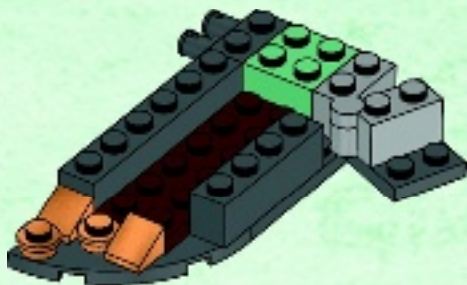

6

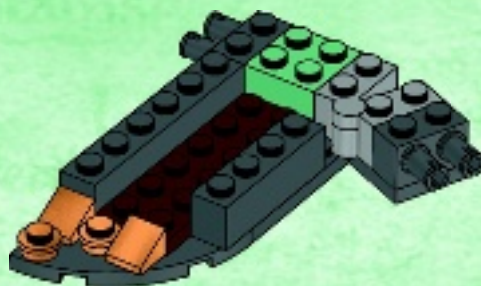





2x



1x



1x

# 7

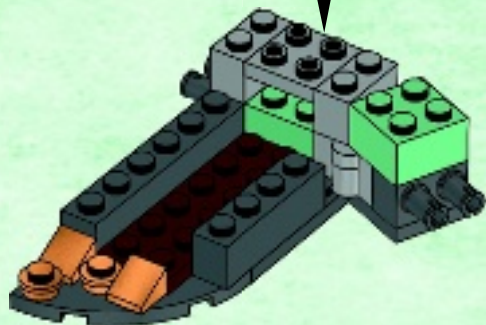
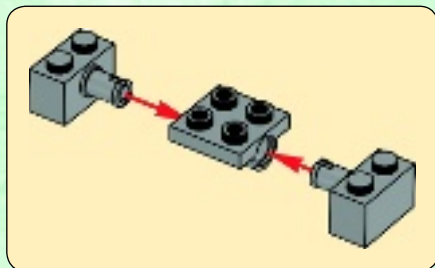

8x

# 8

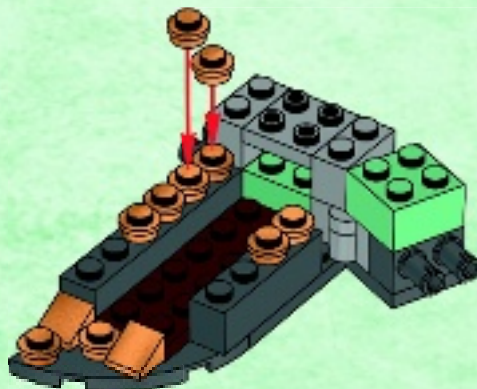

5x

# 9

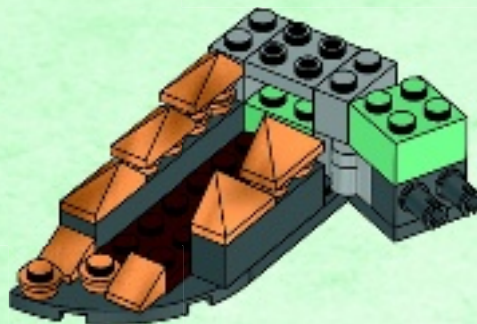

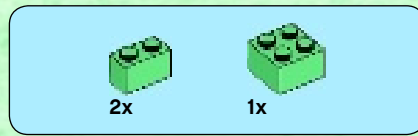

10

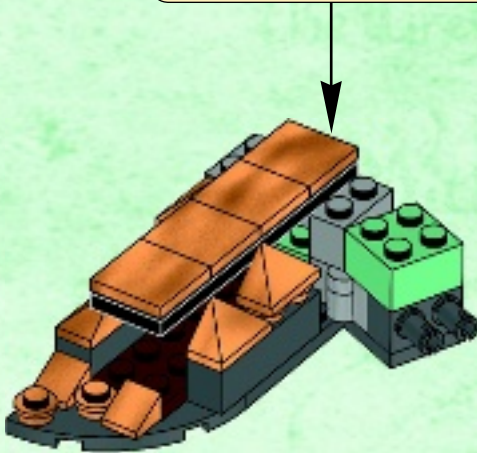
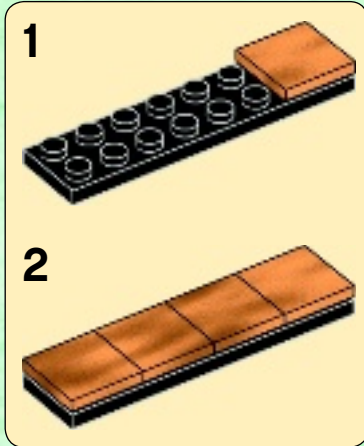

11

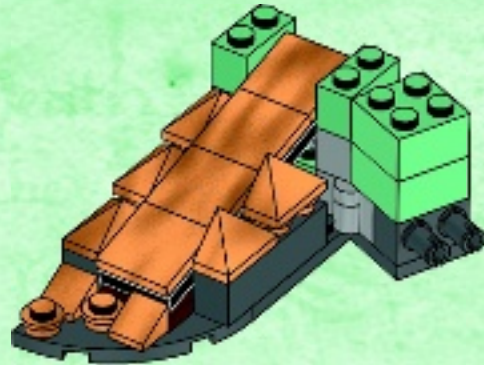



2x



1x



1x

# 12

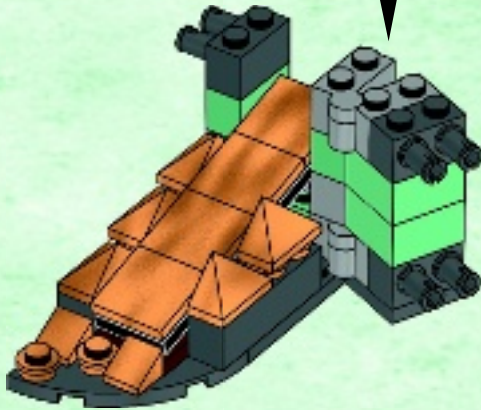
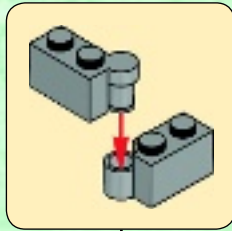

1x



2x



2x

# 13

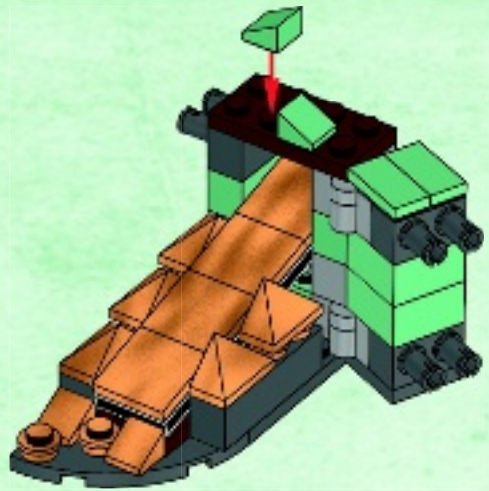

70

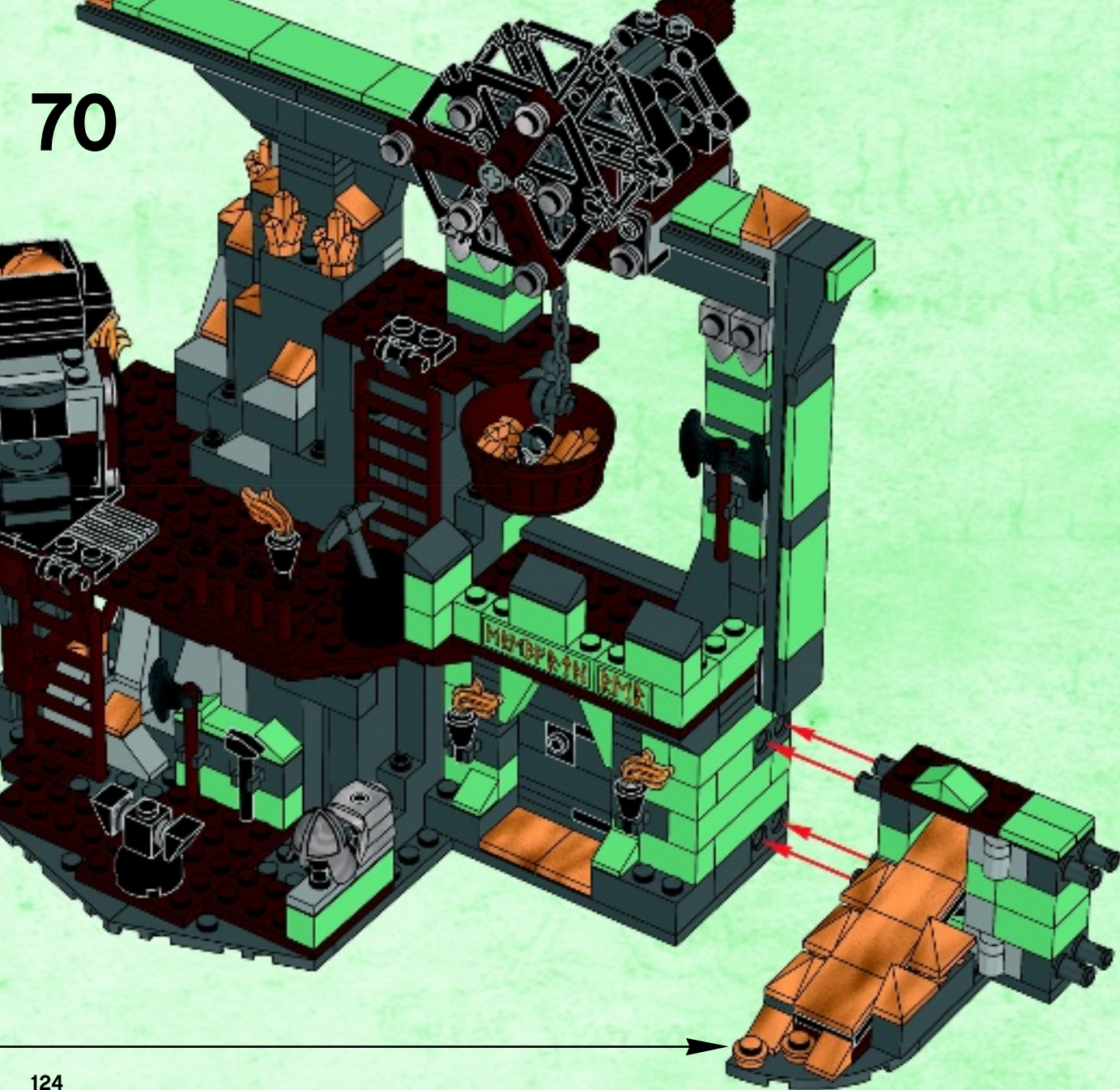

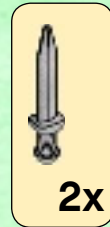
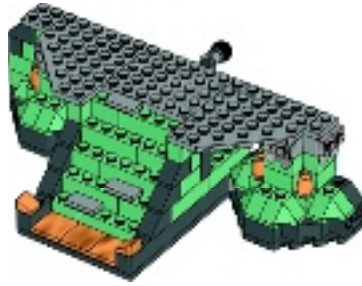

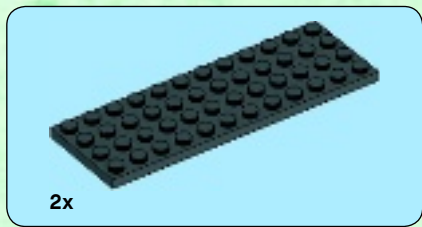

1

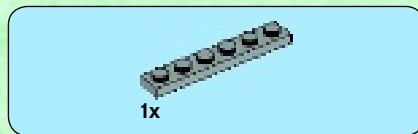
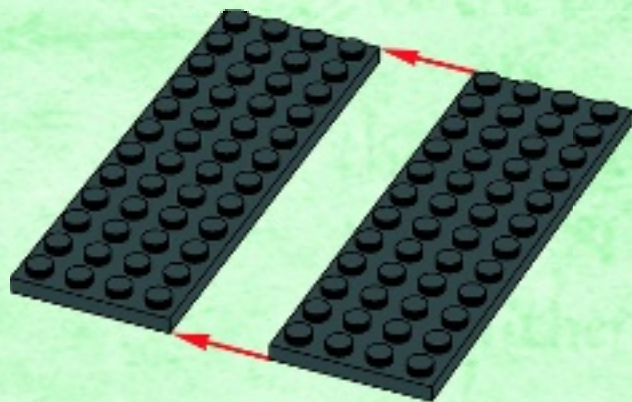

2

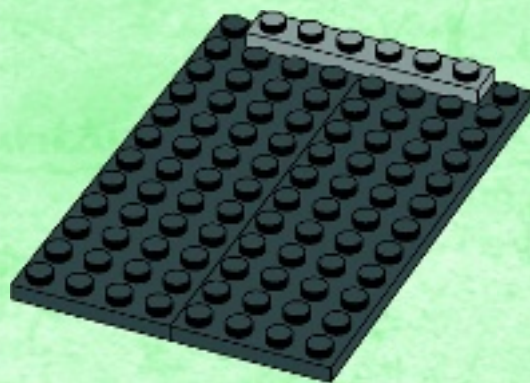

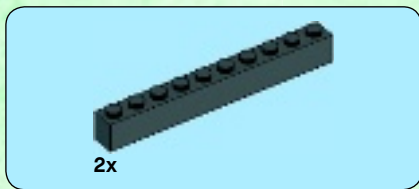

3

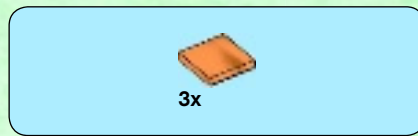
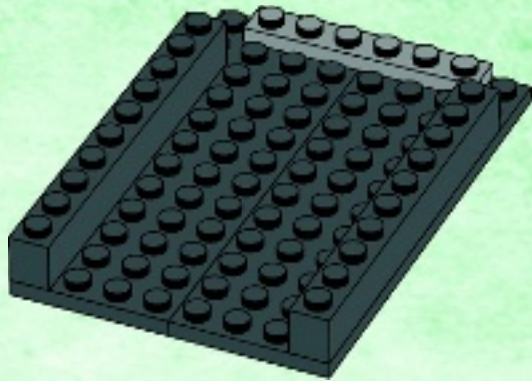

4

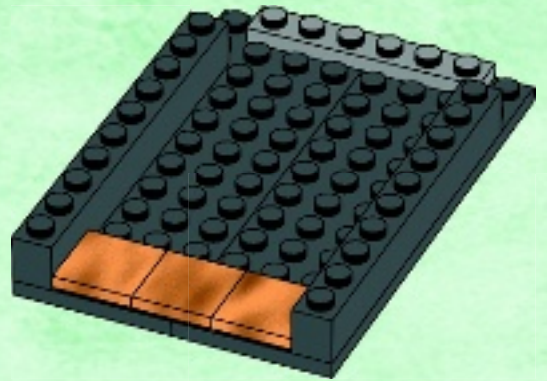

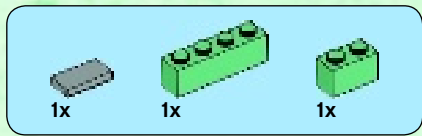

5

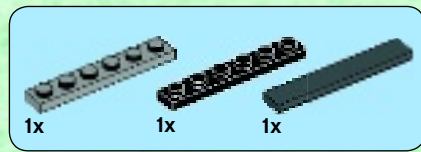
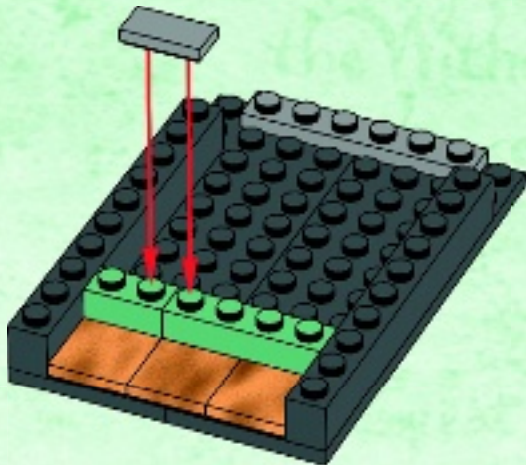

6

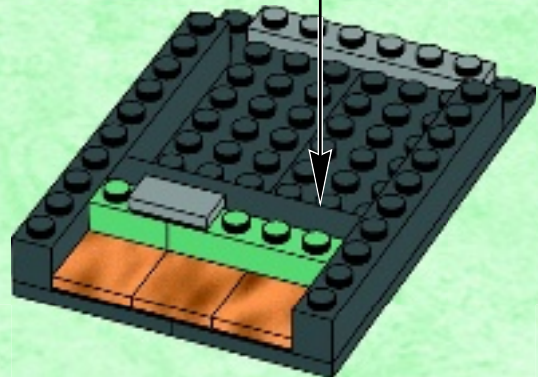
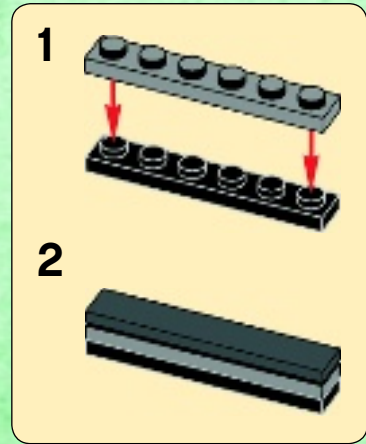



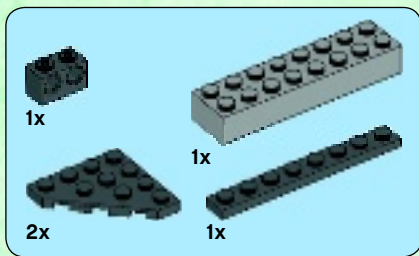

# 7

## 1

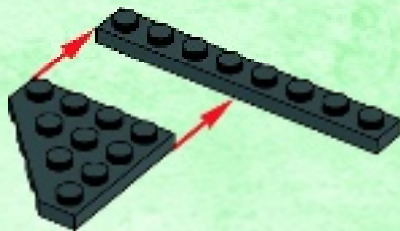

## 2



## 3

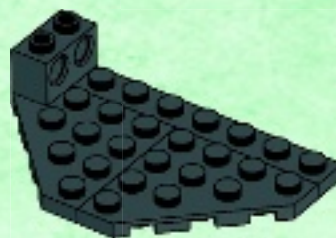

## 4

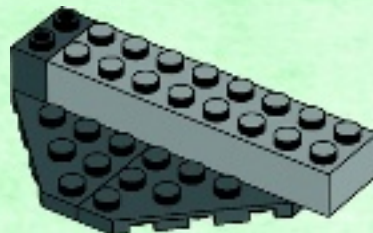

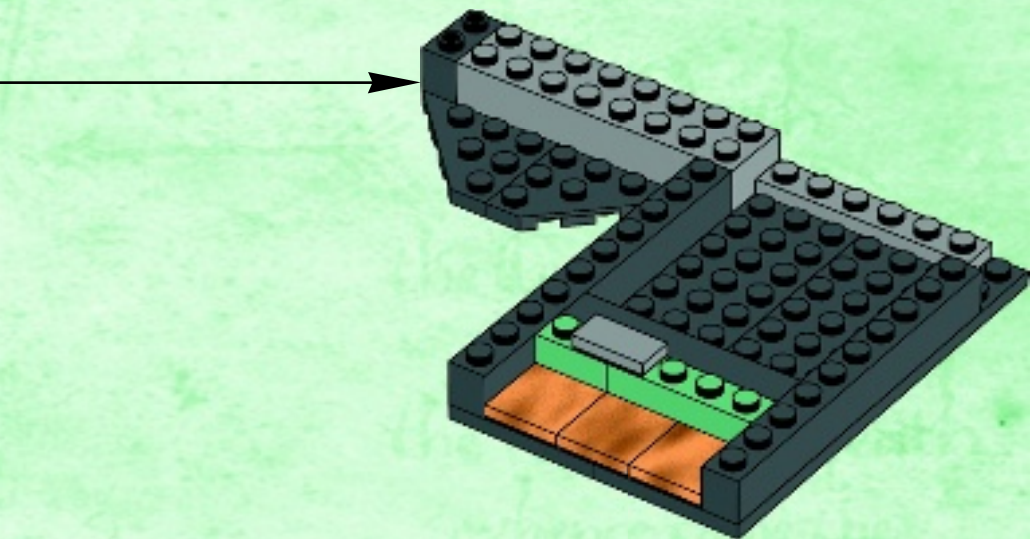

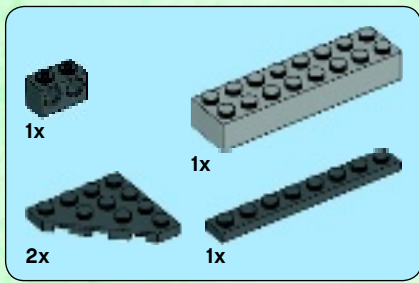

**8**

**1**

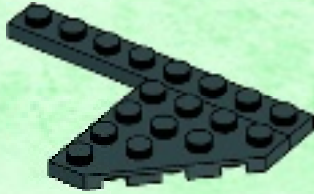

**2**

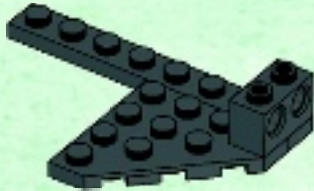

**3**

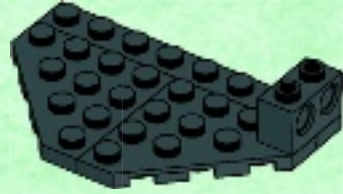

**4**

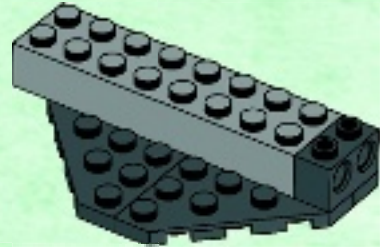

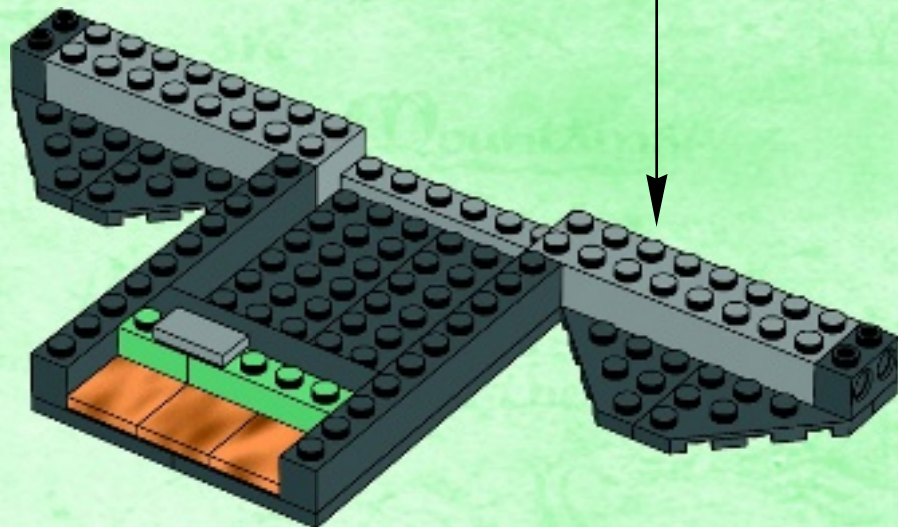



2x



4x

9

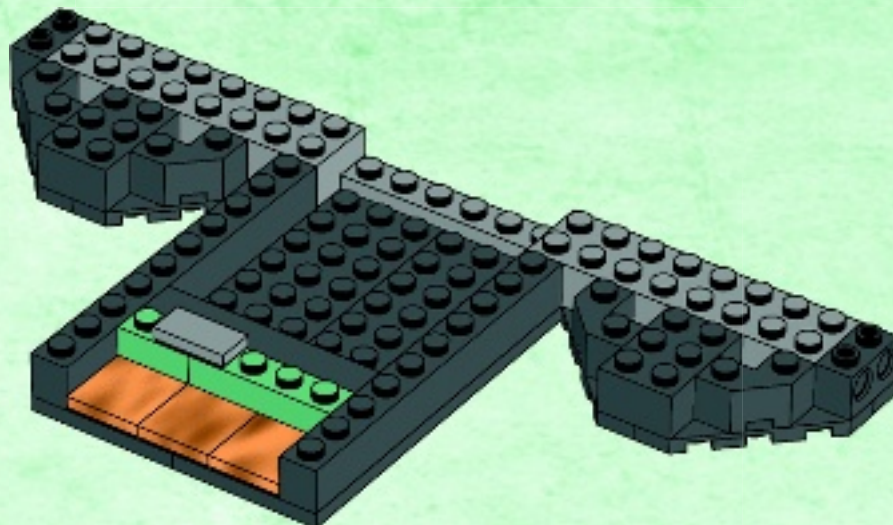

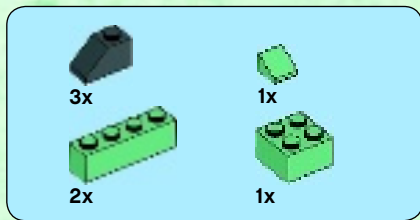

10

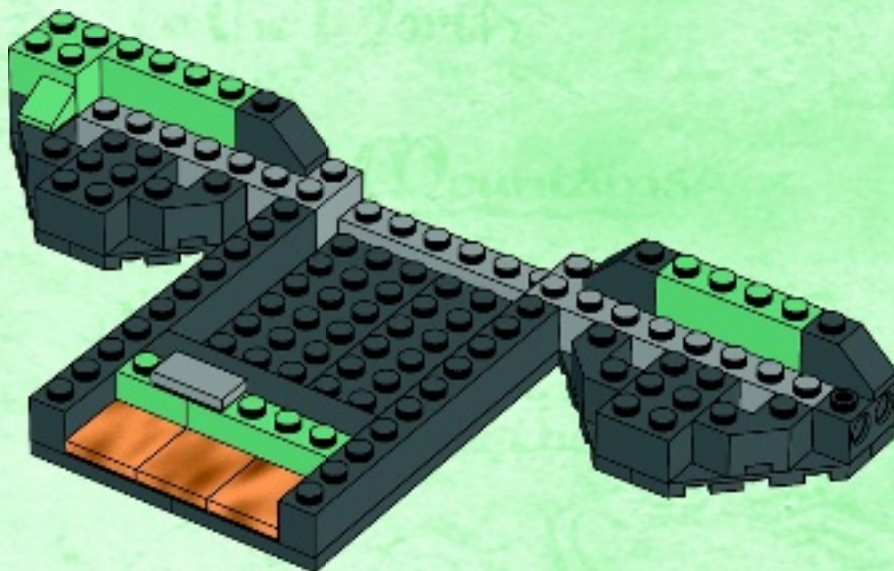

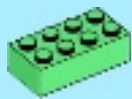

2x



3x

# 11

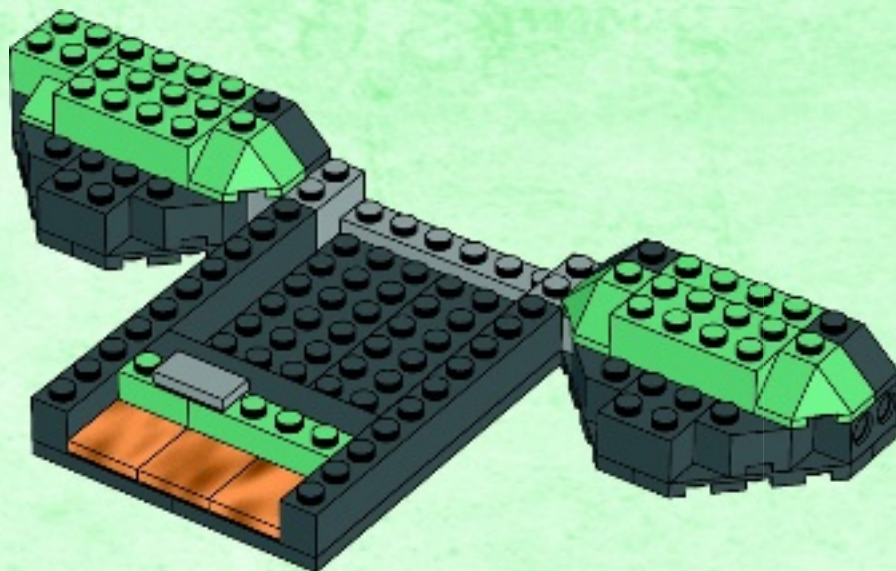



4x

# 12

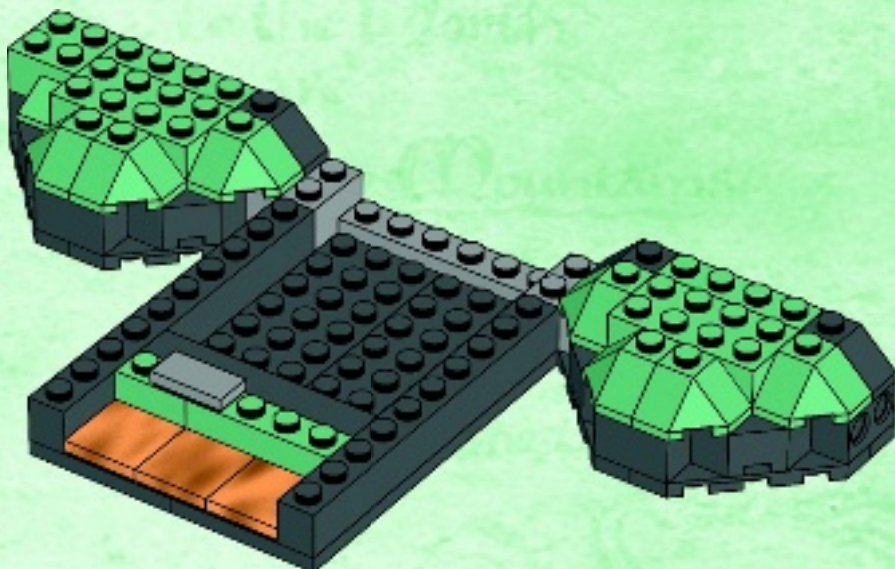



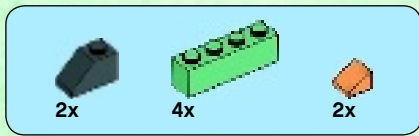

13

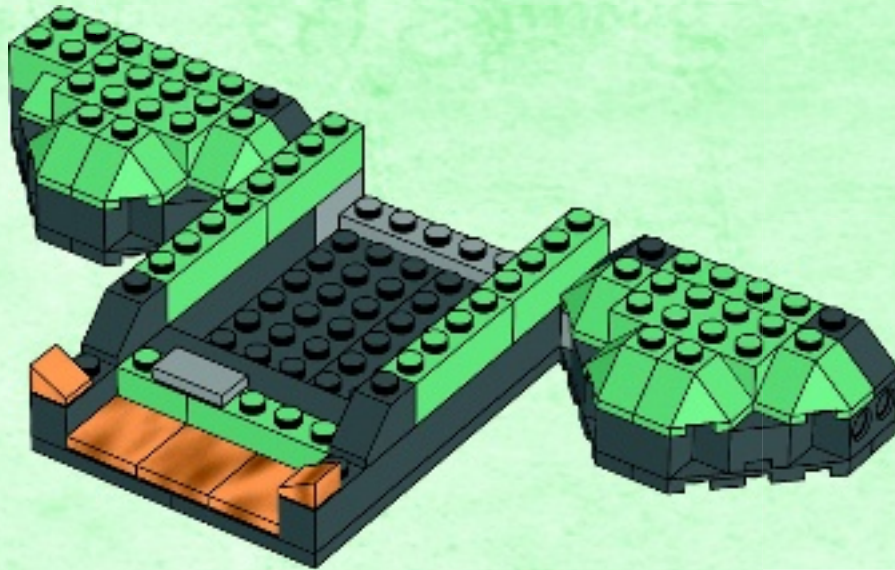

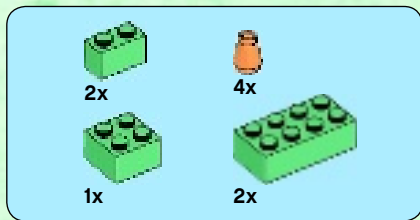

14

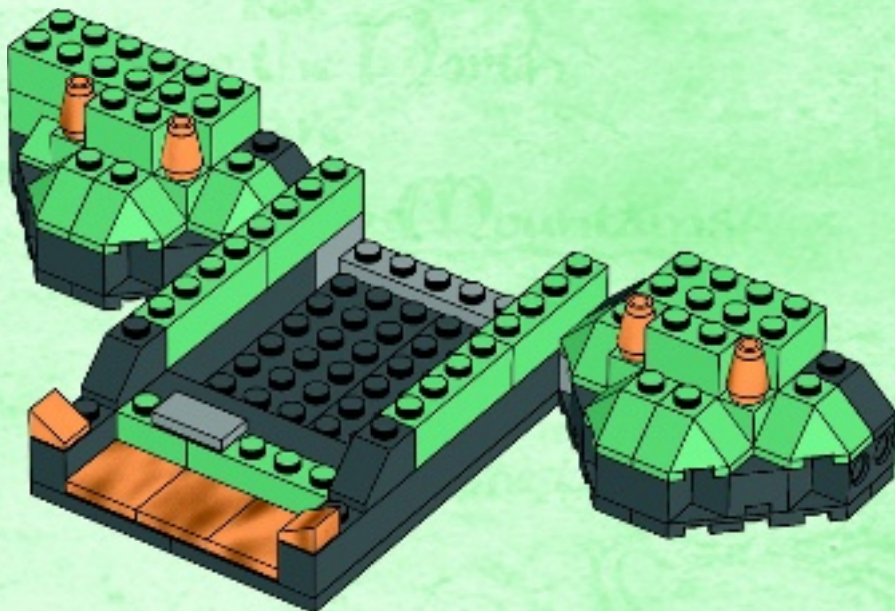



15

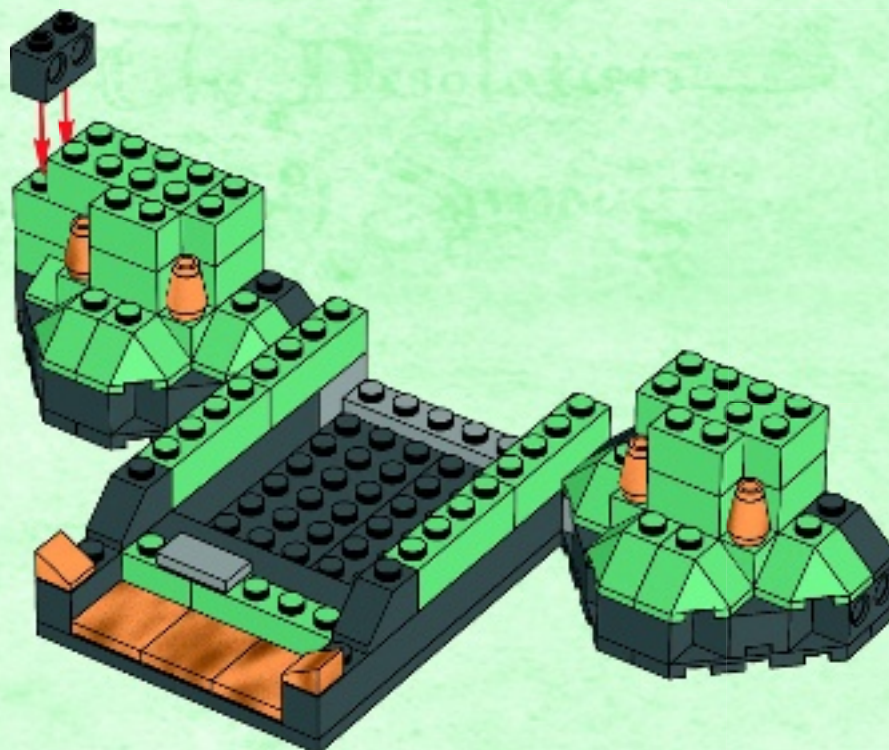

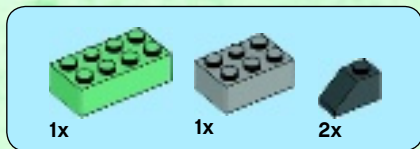

16

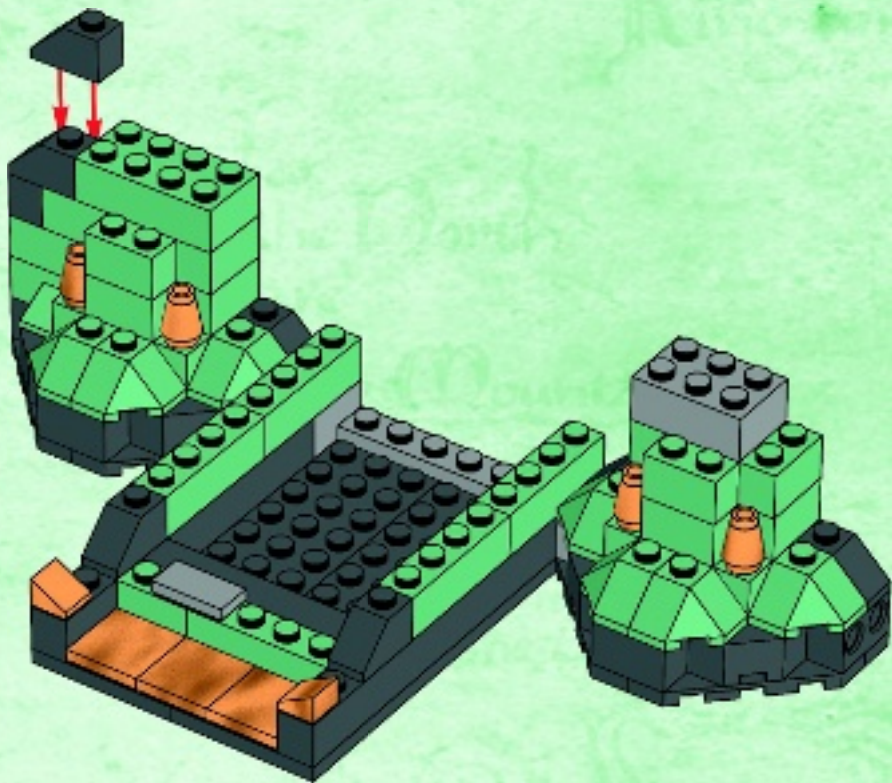



6x



3x

# 17

1

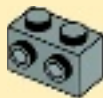

2

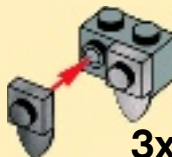

3x

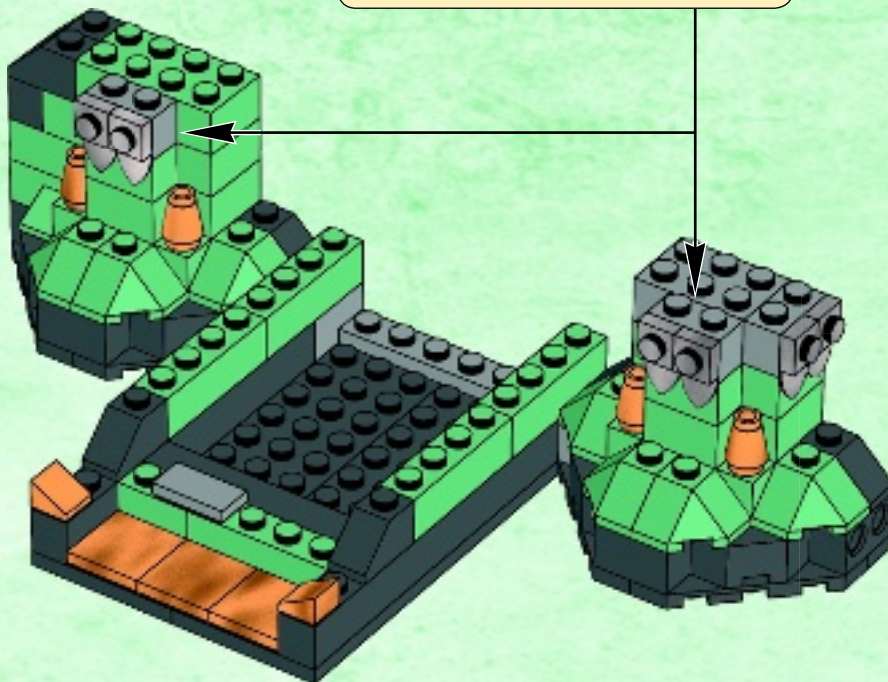

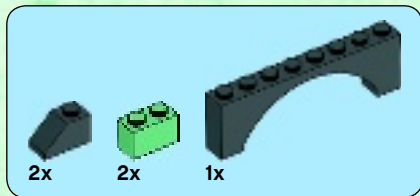

18

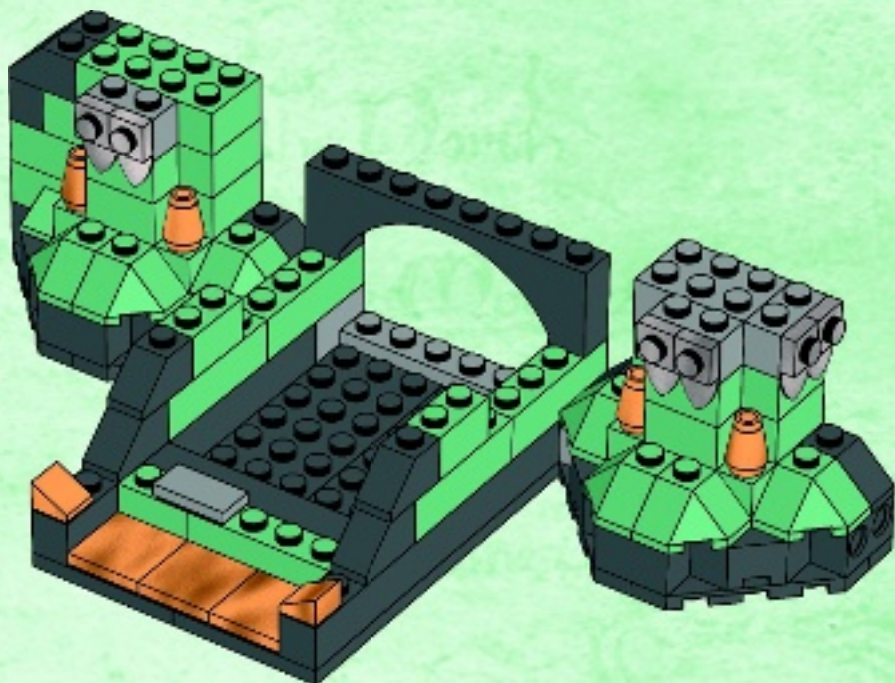

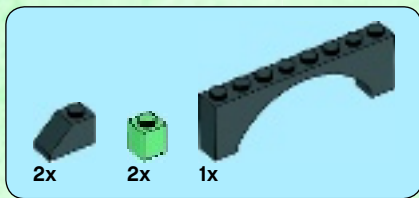

19

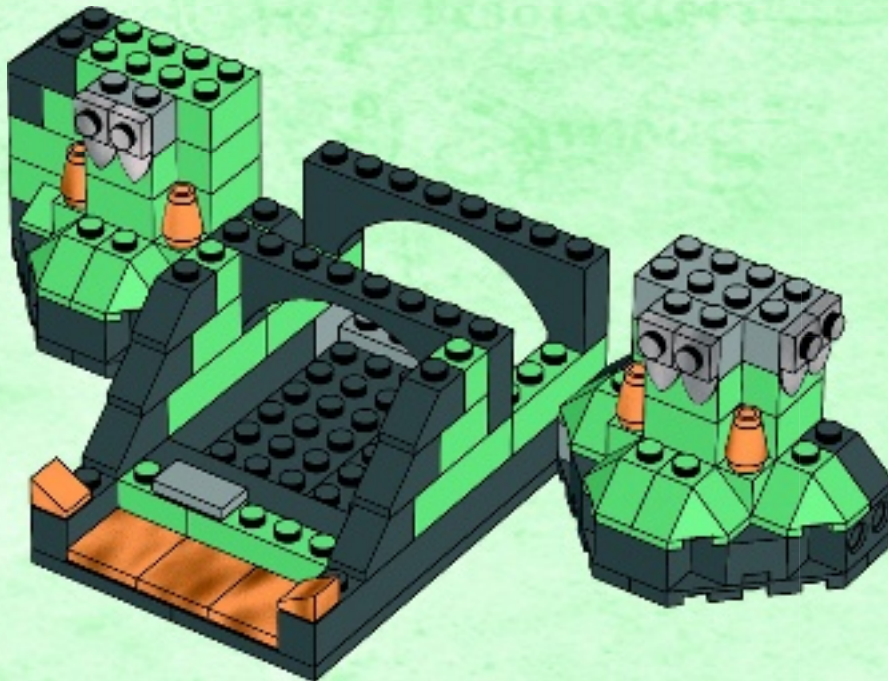

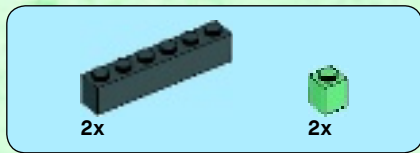

20

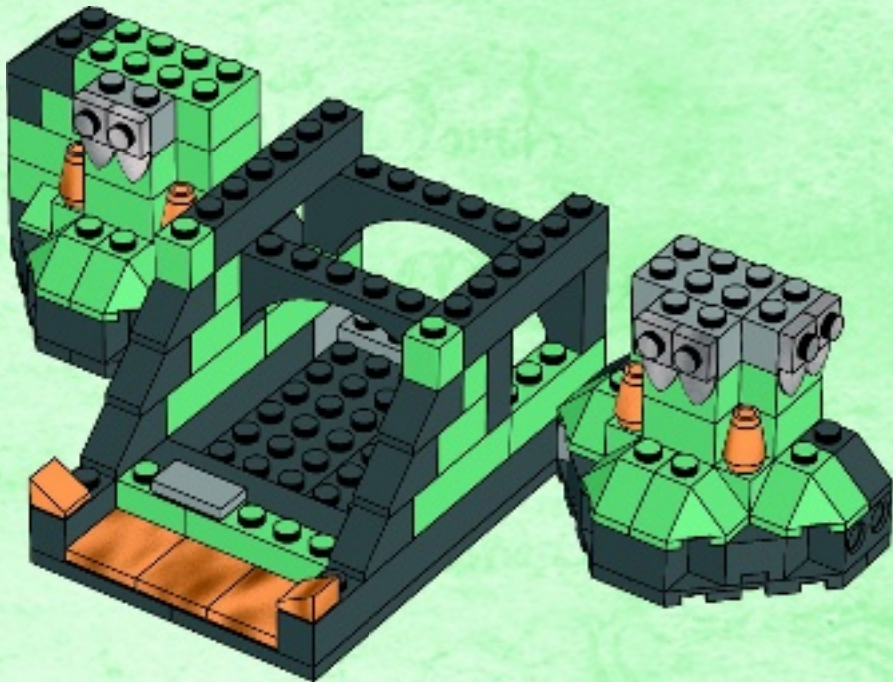





21

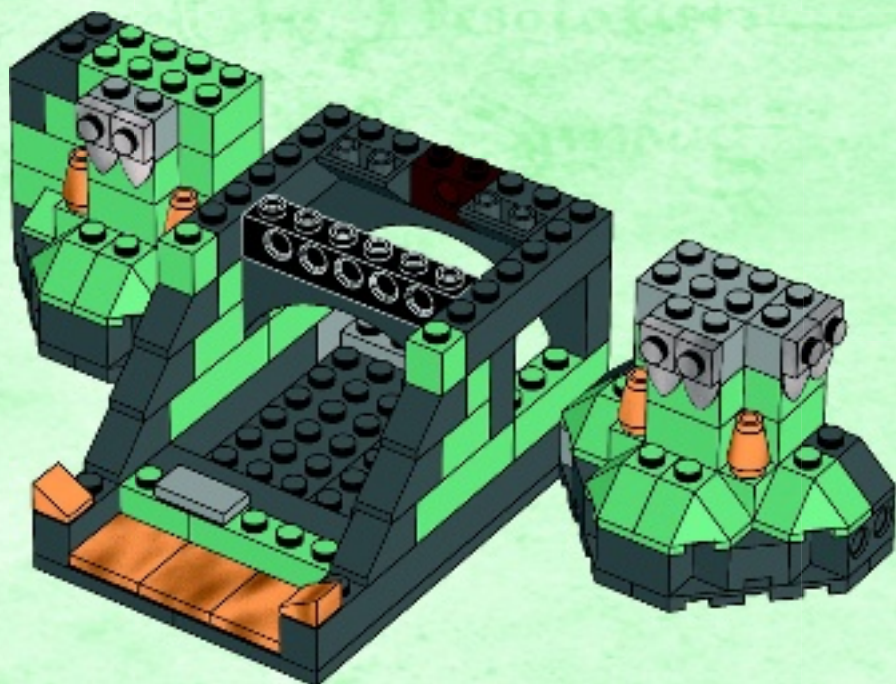

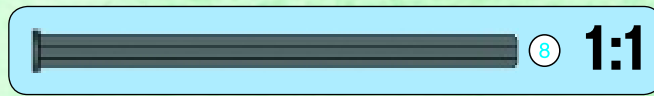
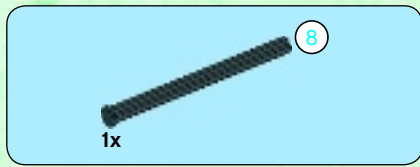

22

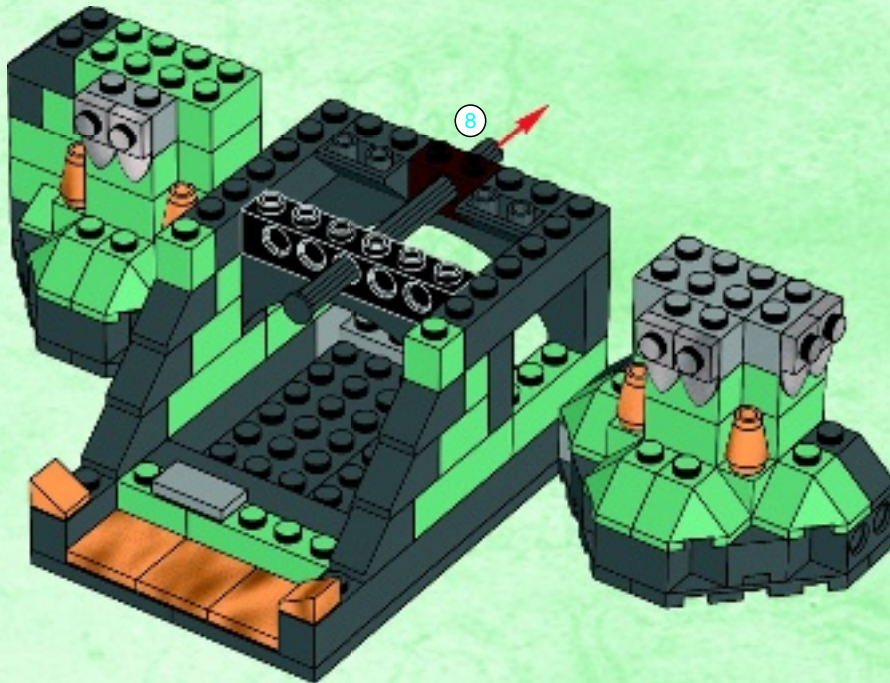



1x



1x

# 23

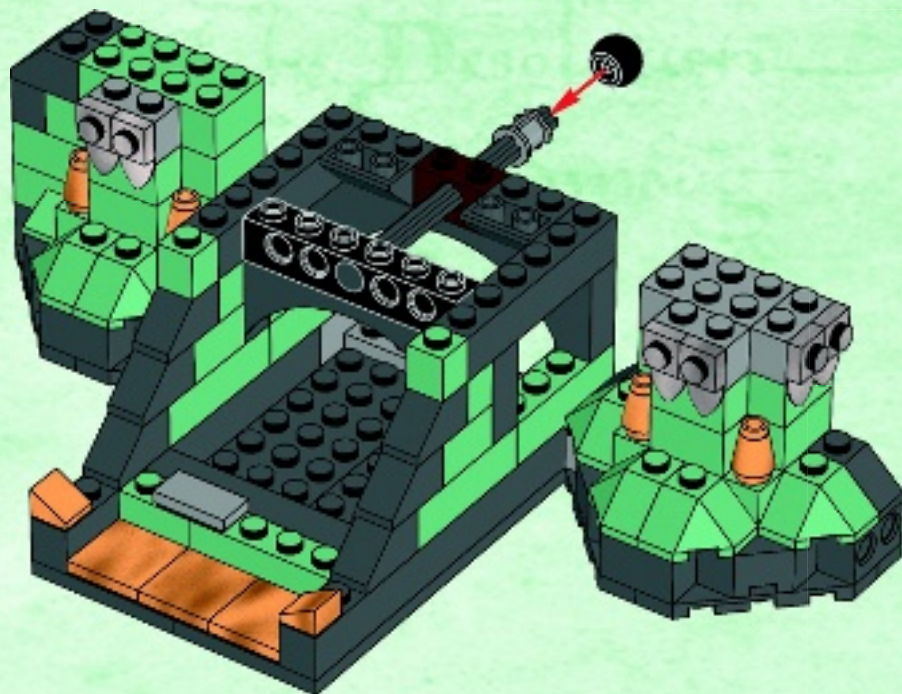

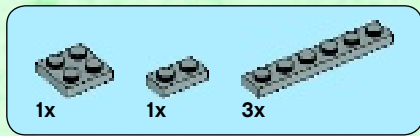

24

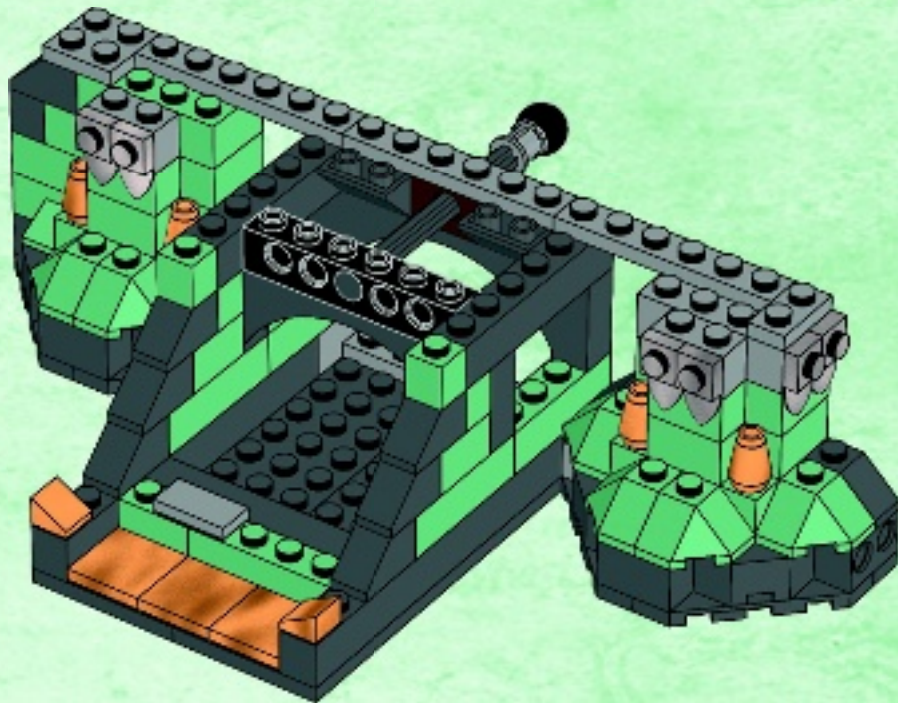

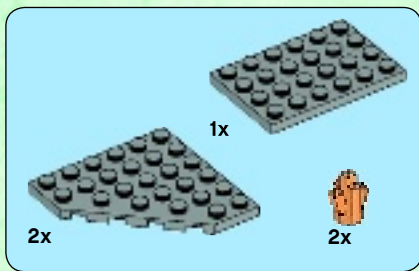

# 25

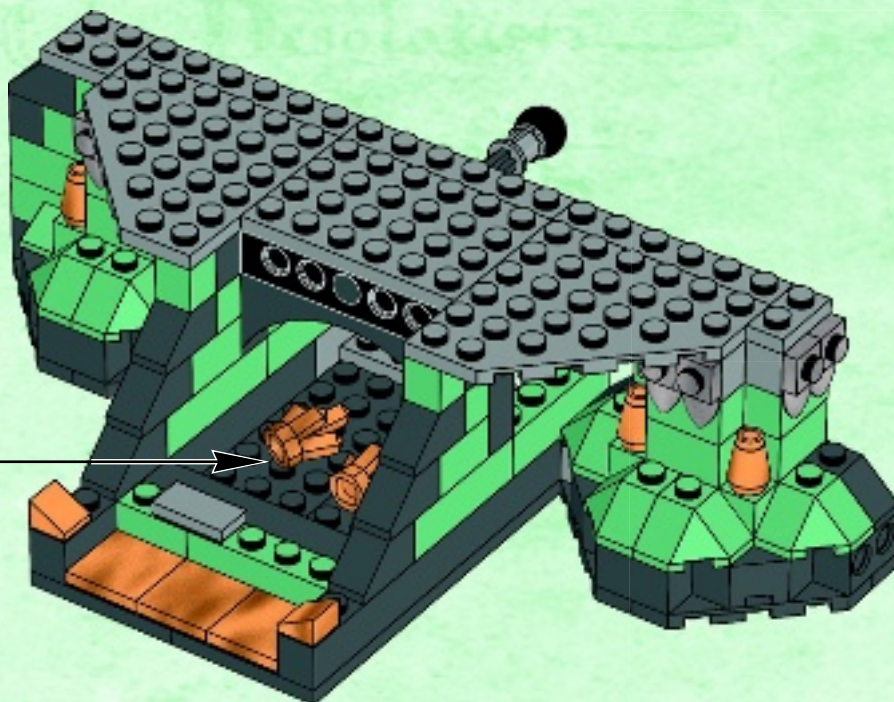

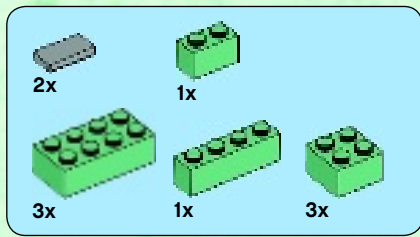

# 26

1

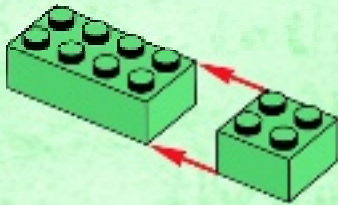

2

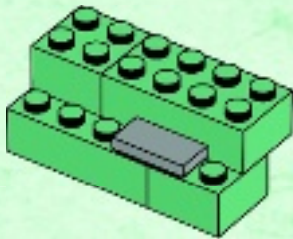

3

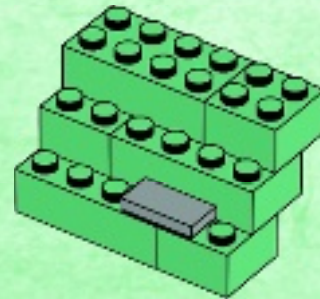

4

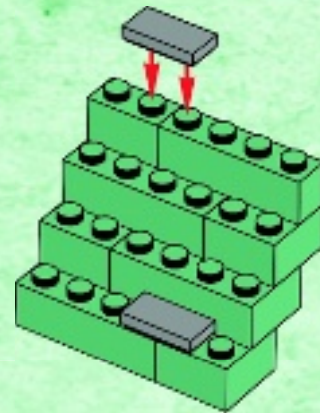

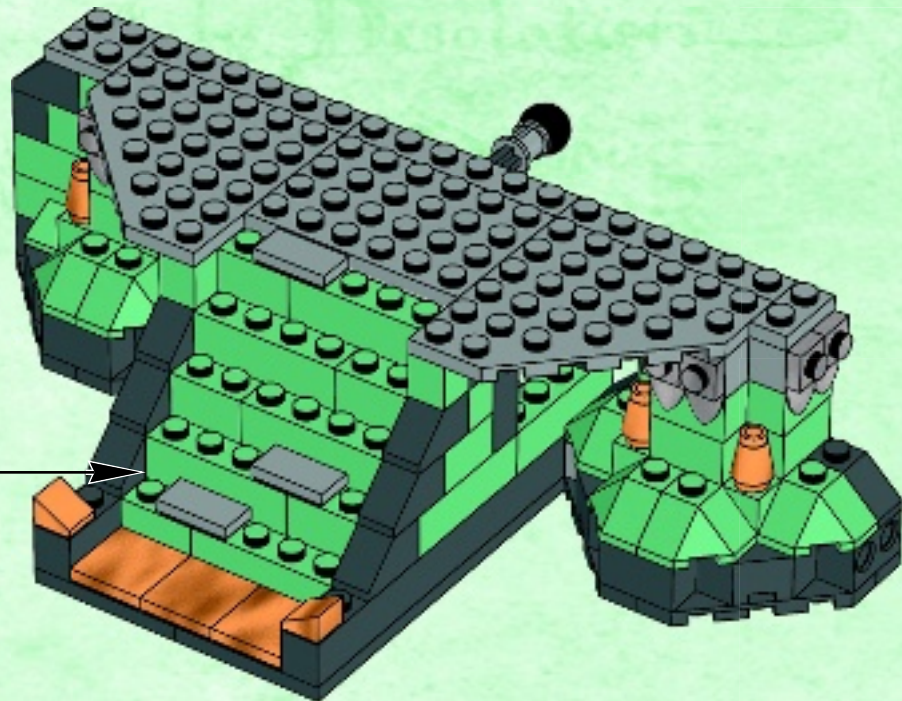

27

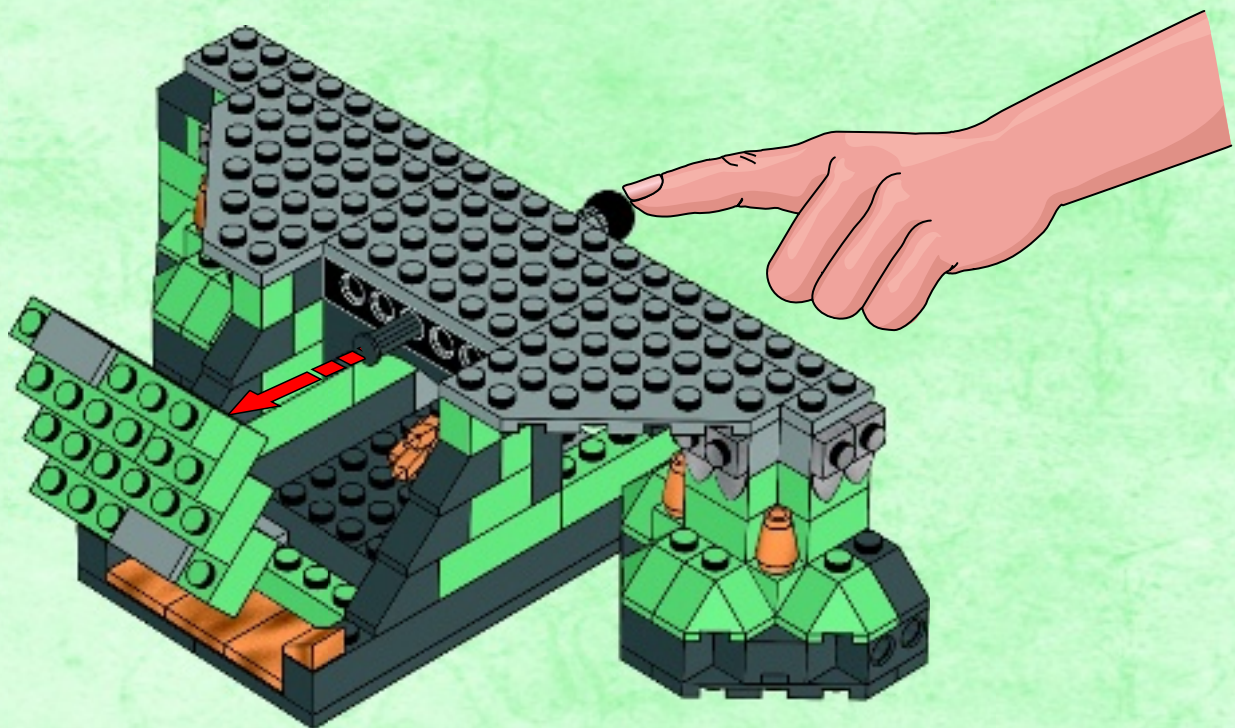





6



2x



1x



1x



1x

28

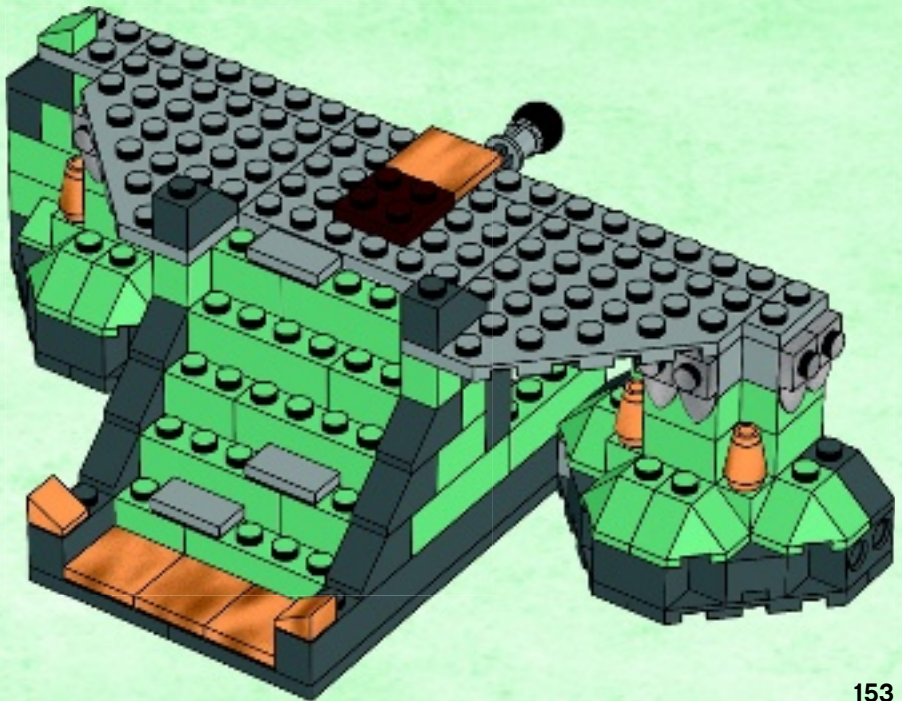

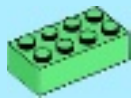

4x

# 29

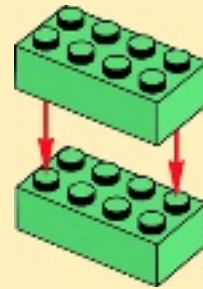

2x

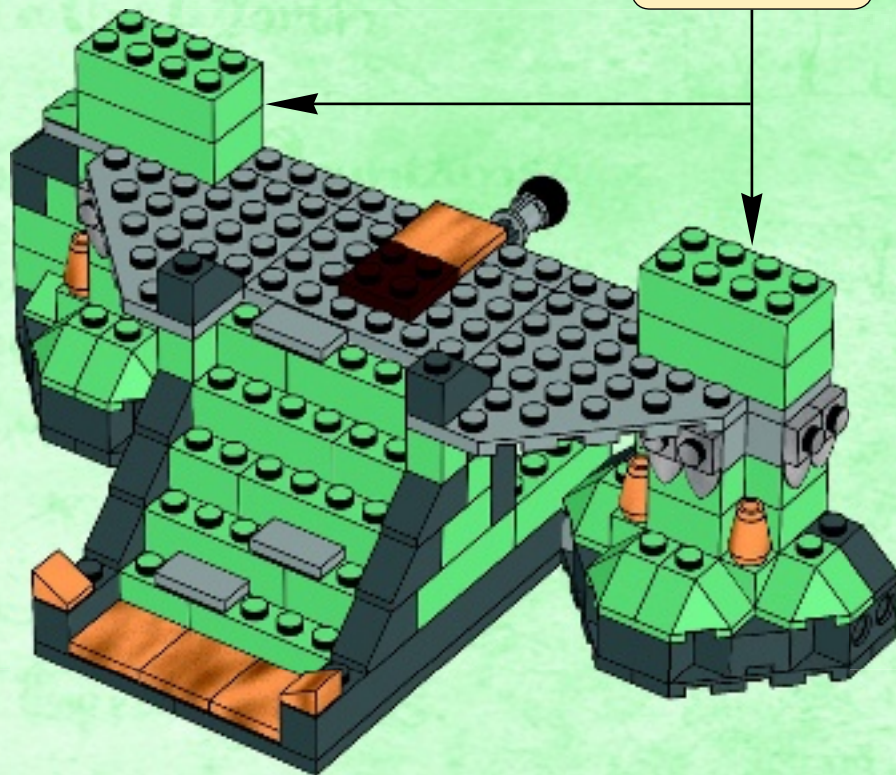



2x



2x

# 30



2x

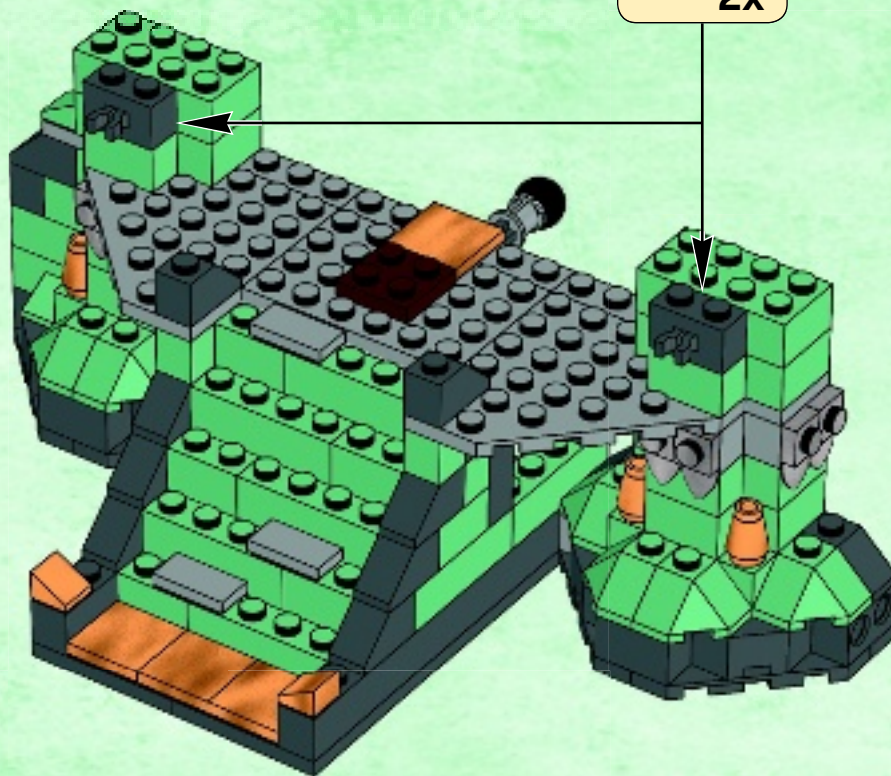



2x



4x

# 31

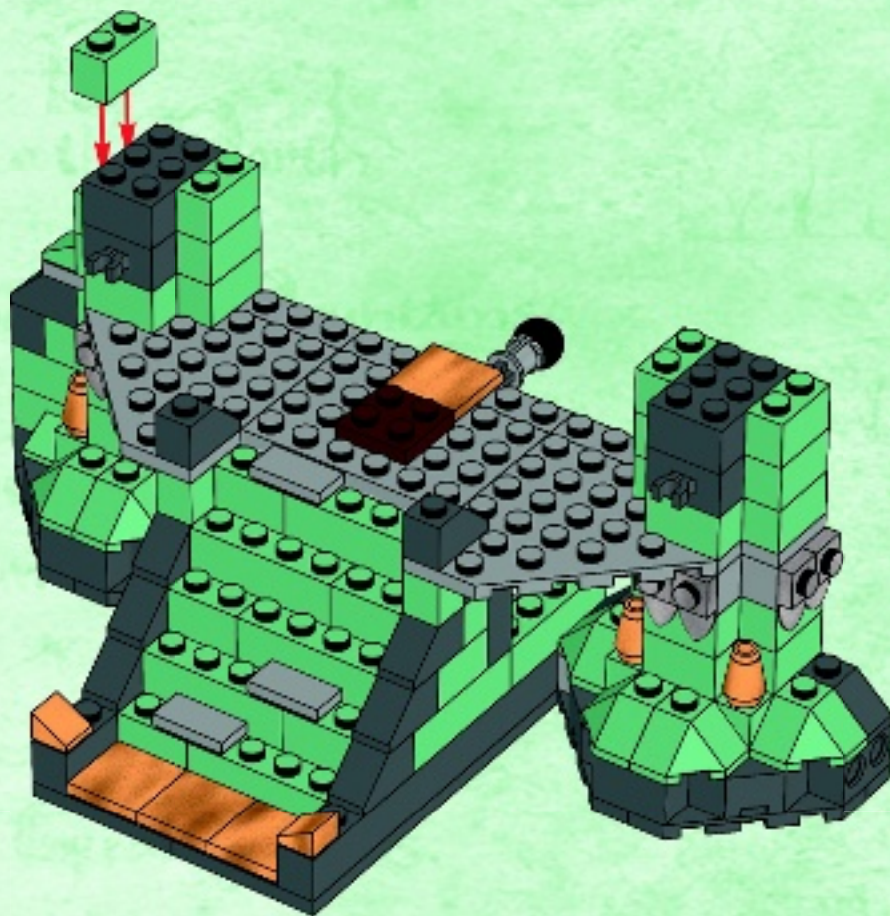

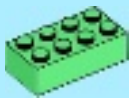

6x

# 32

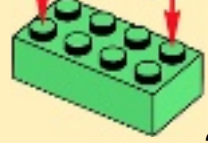
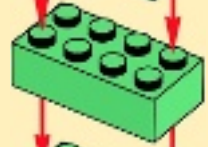
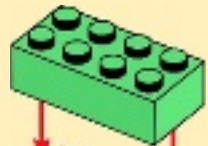

2x

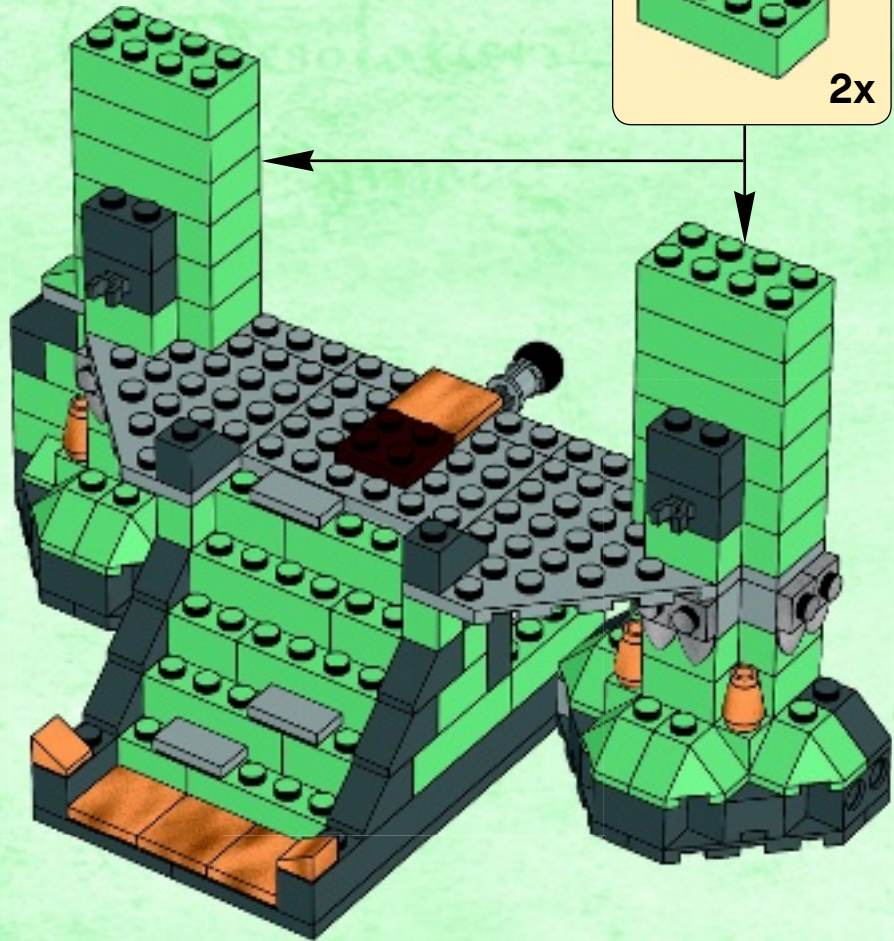



6x

# 33

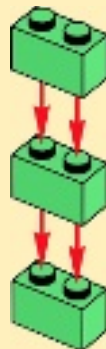

2x

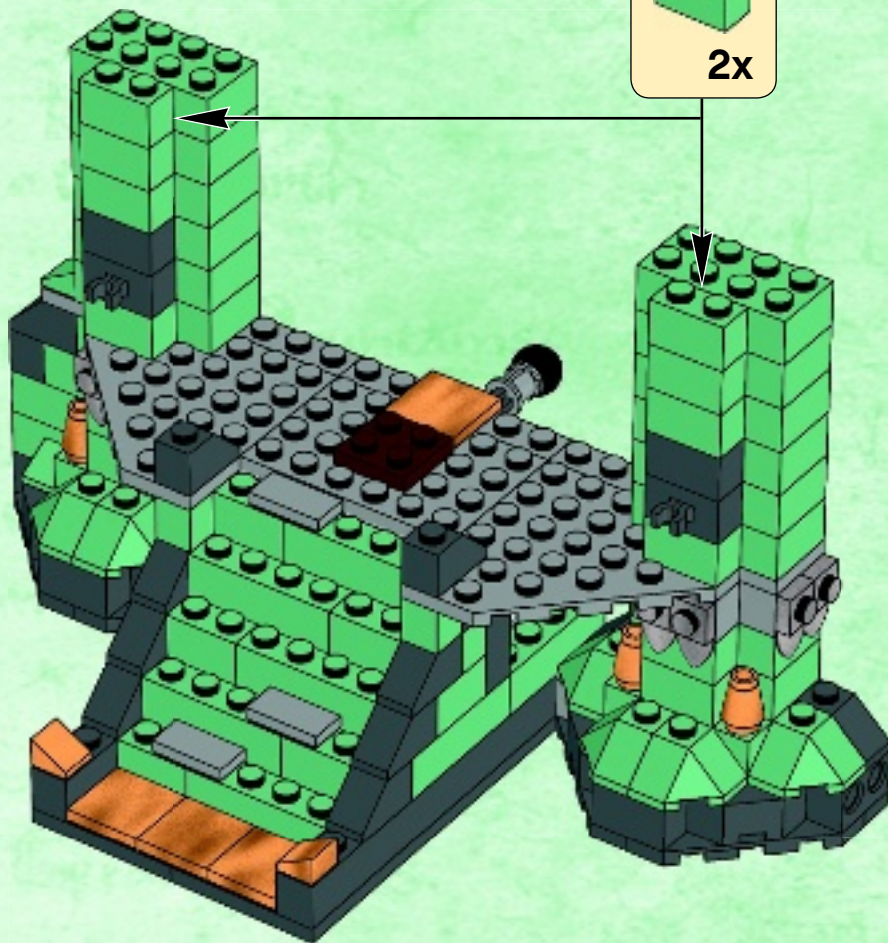



4x



2x



4x

# 34

1

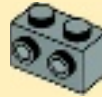

2

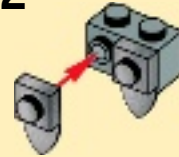

2x

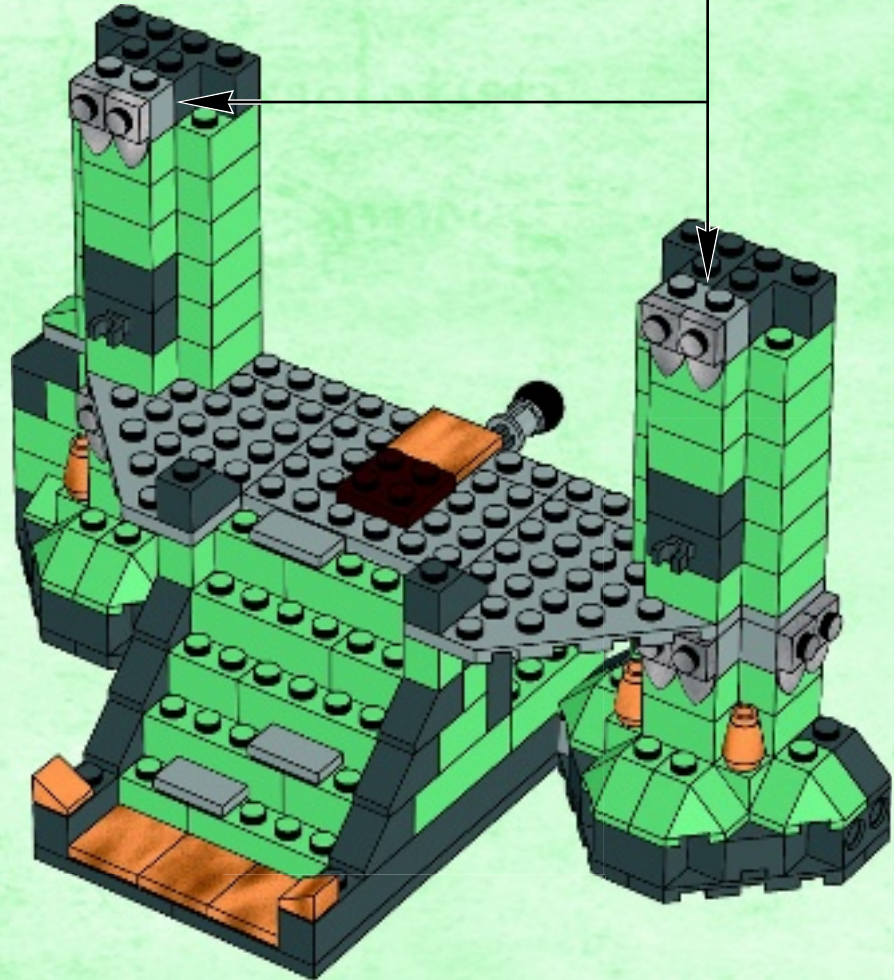

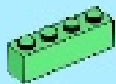

4x

# 35

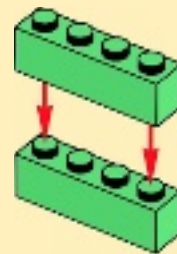

2x

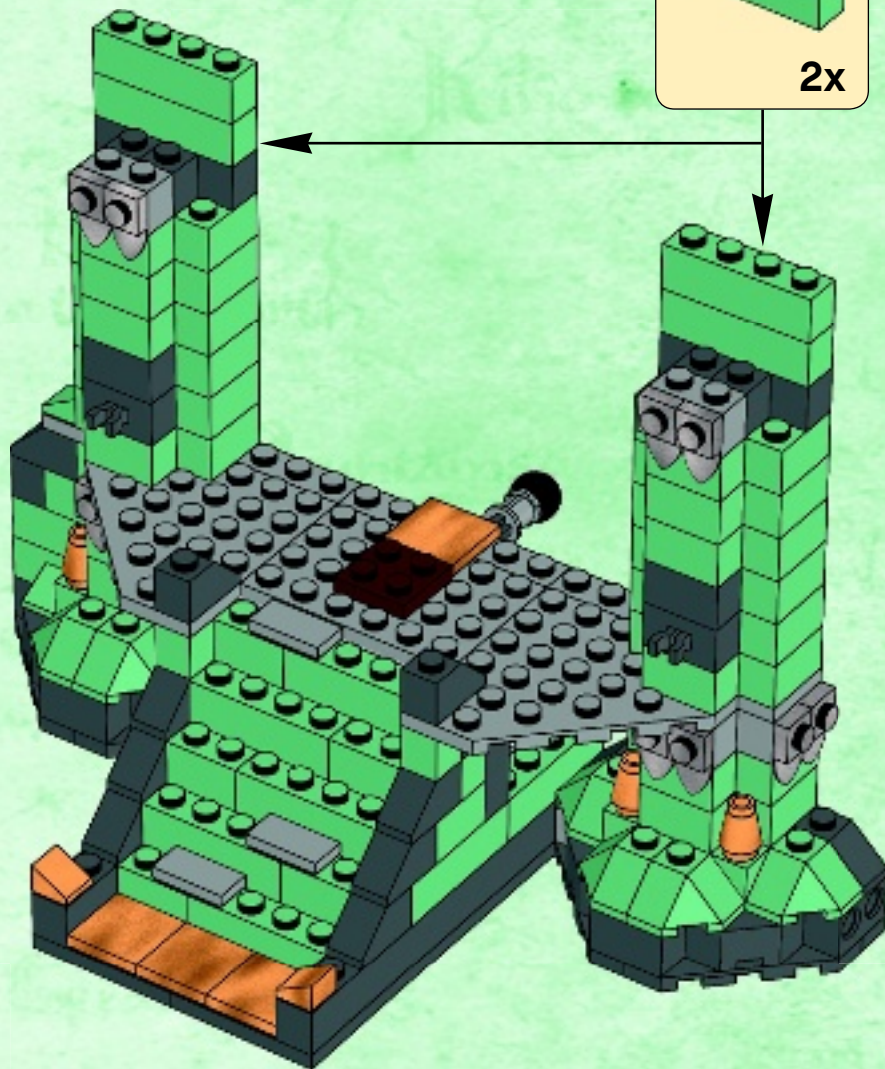





4x

# 36

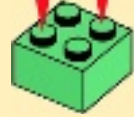
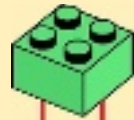

2x

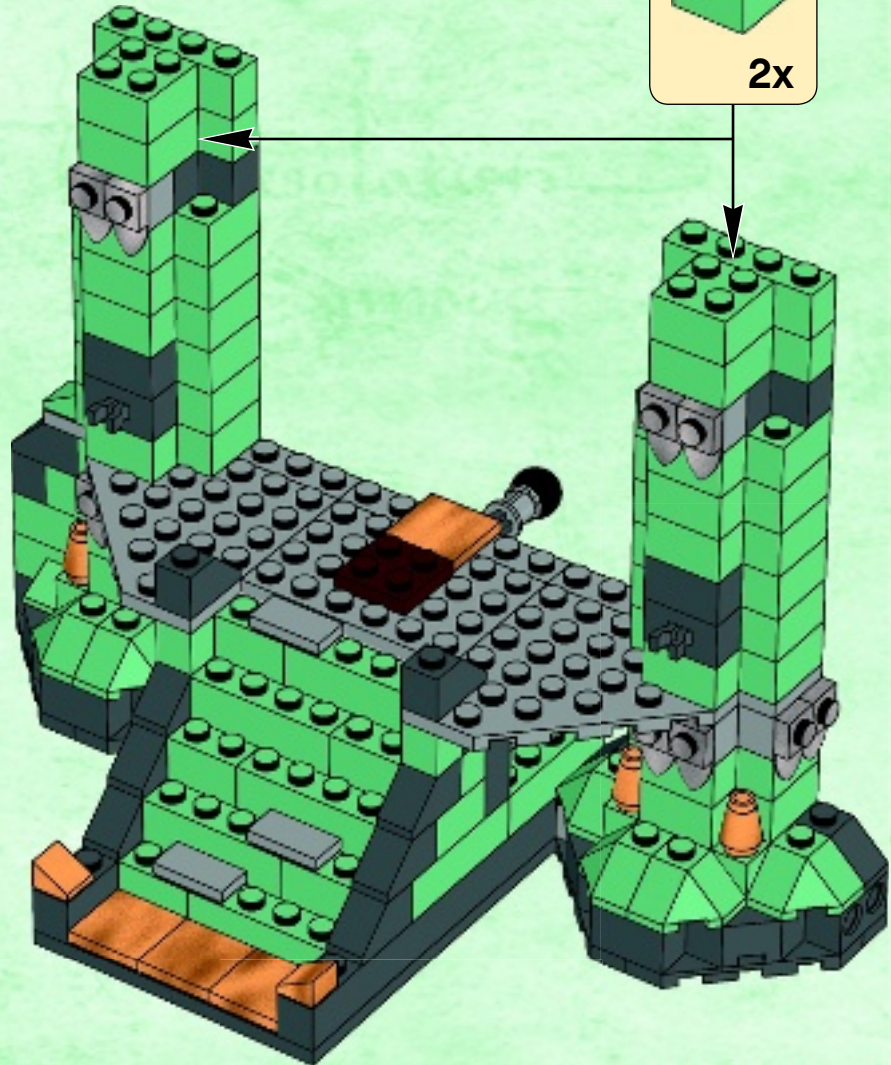



4x

37

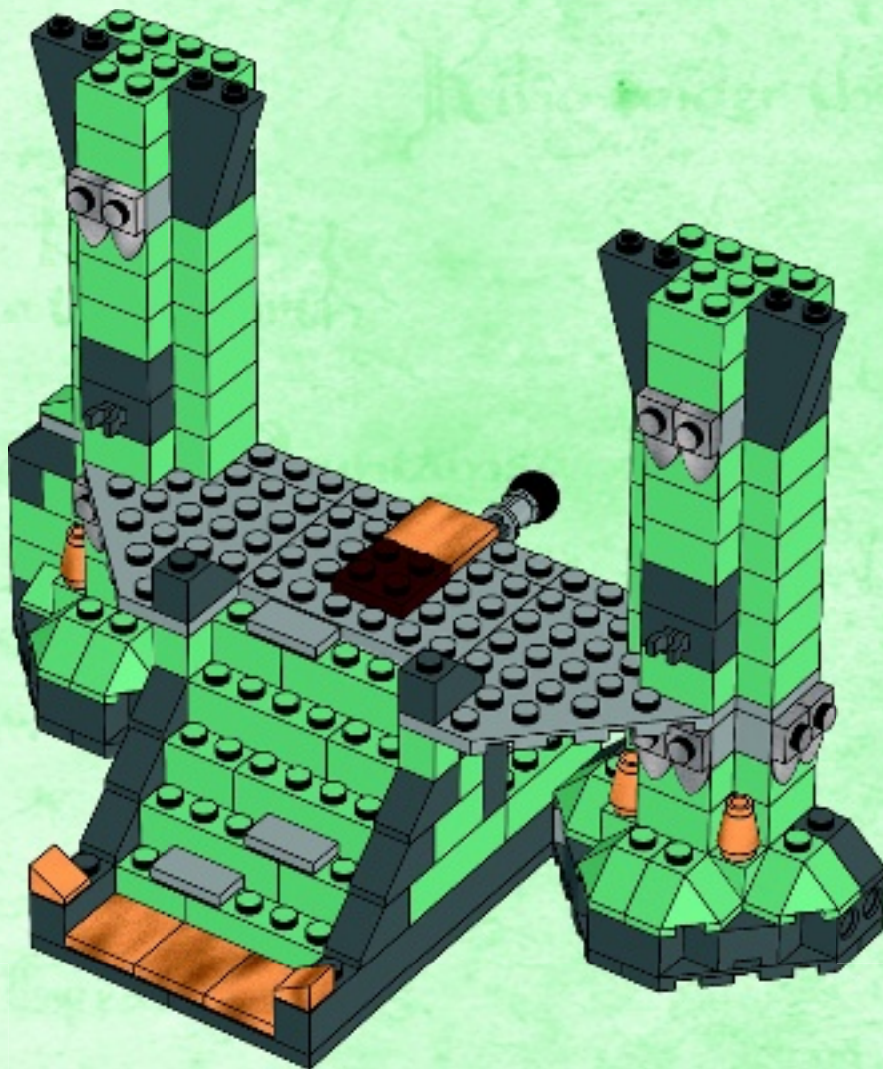



4x

38

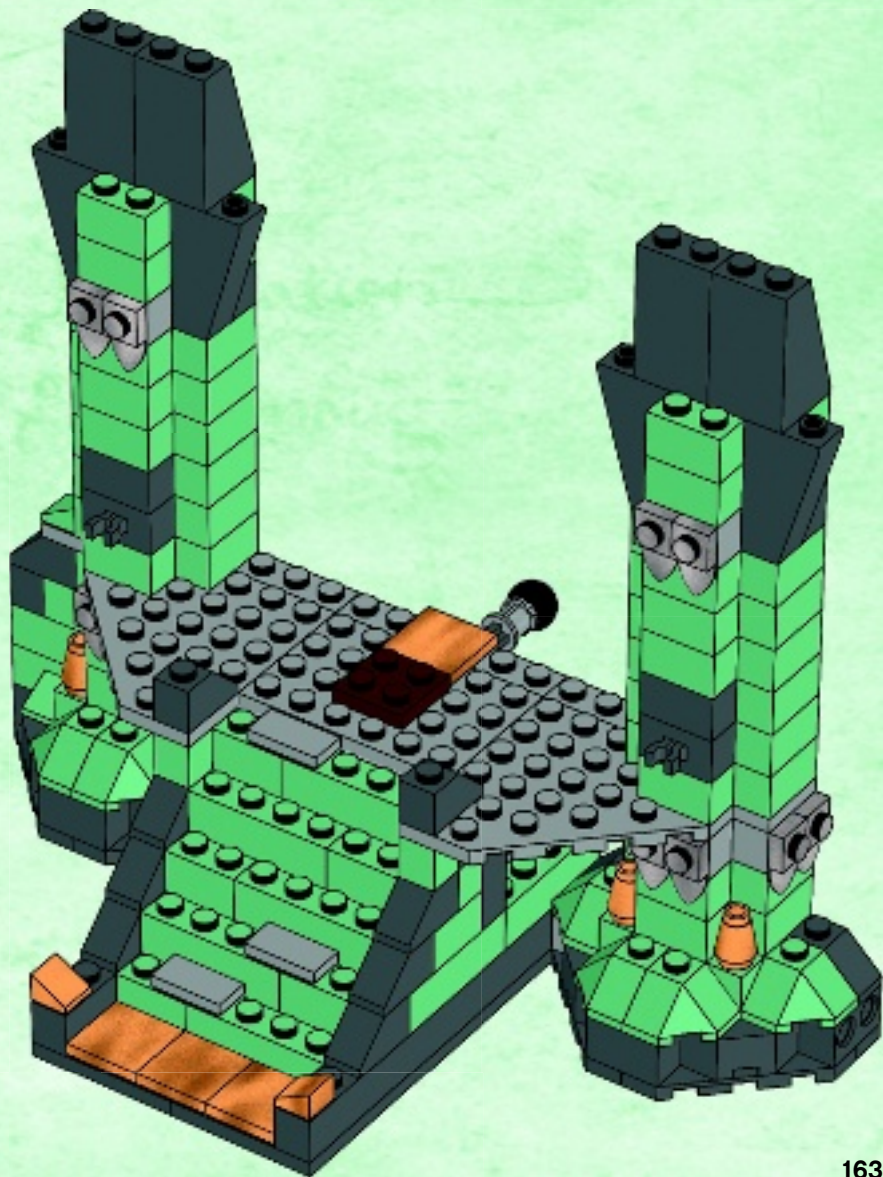



4x

39

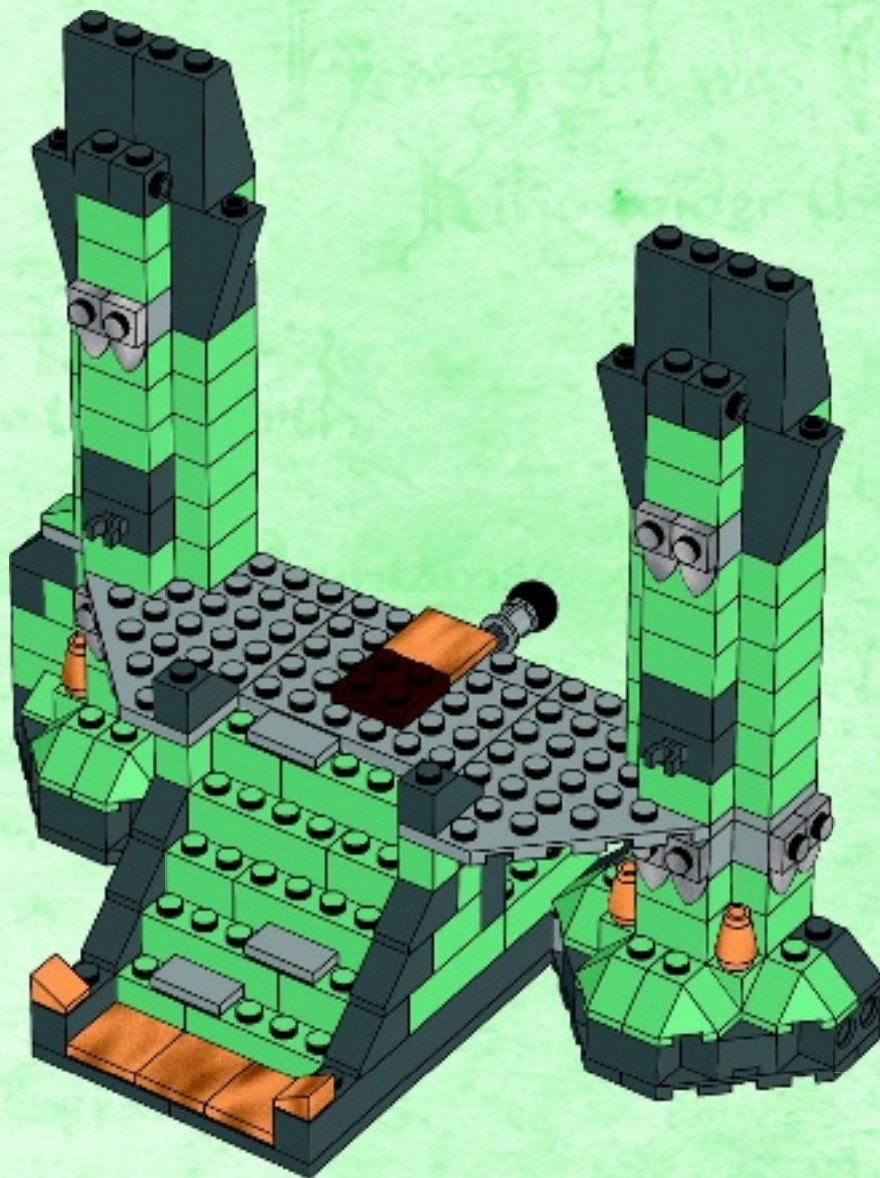

4x

4x

2x

2x

# 40

1

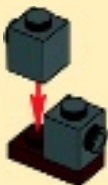

2



3



4



2x

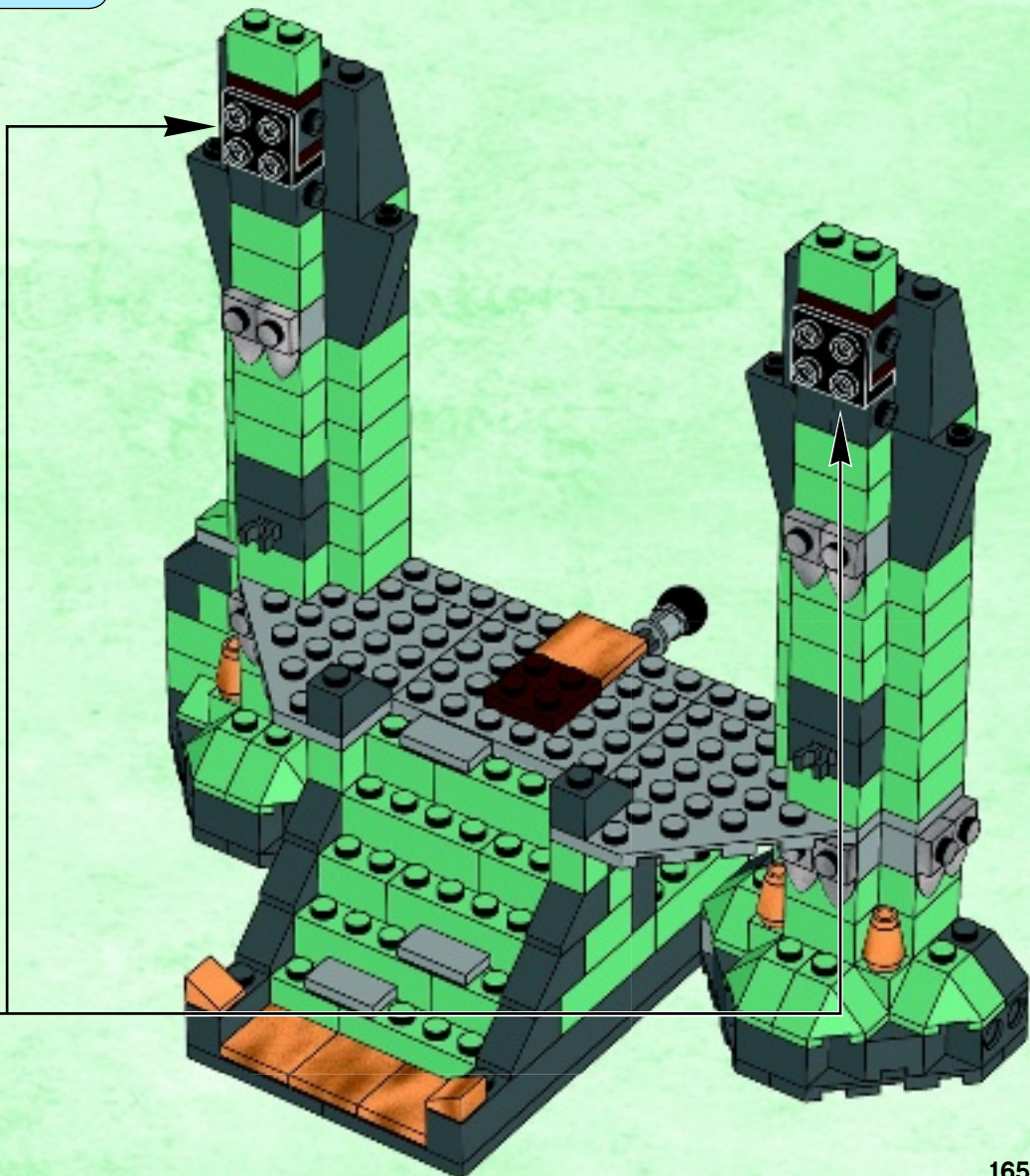



4x

41

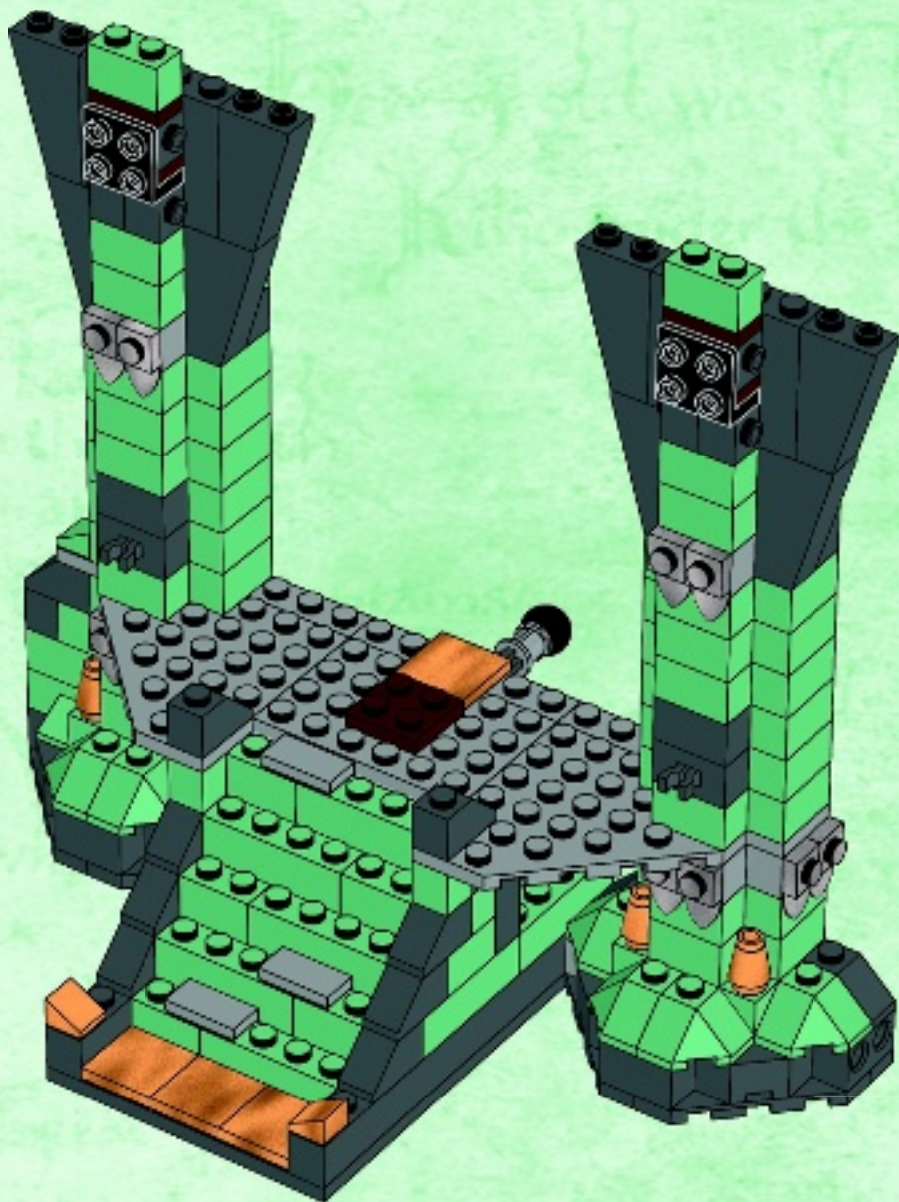

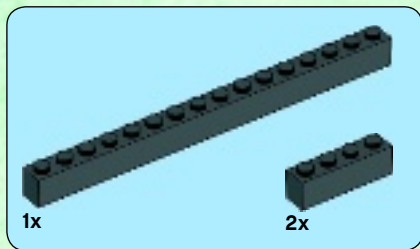

42

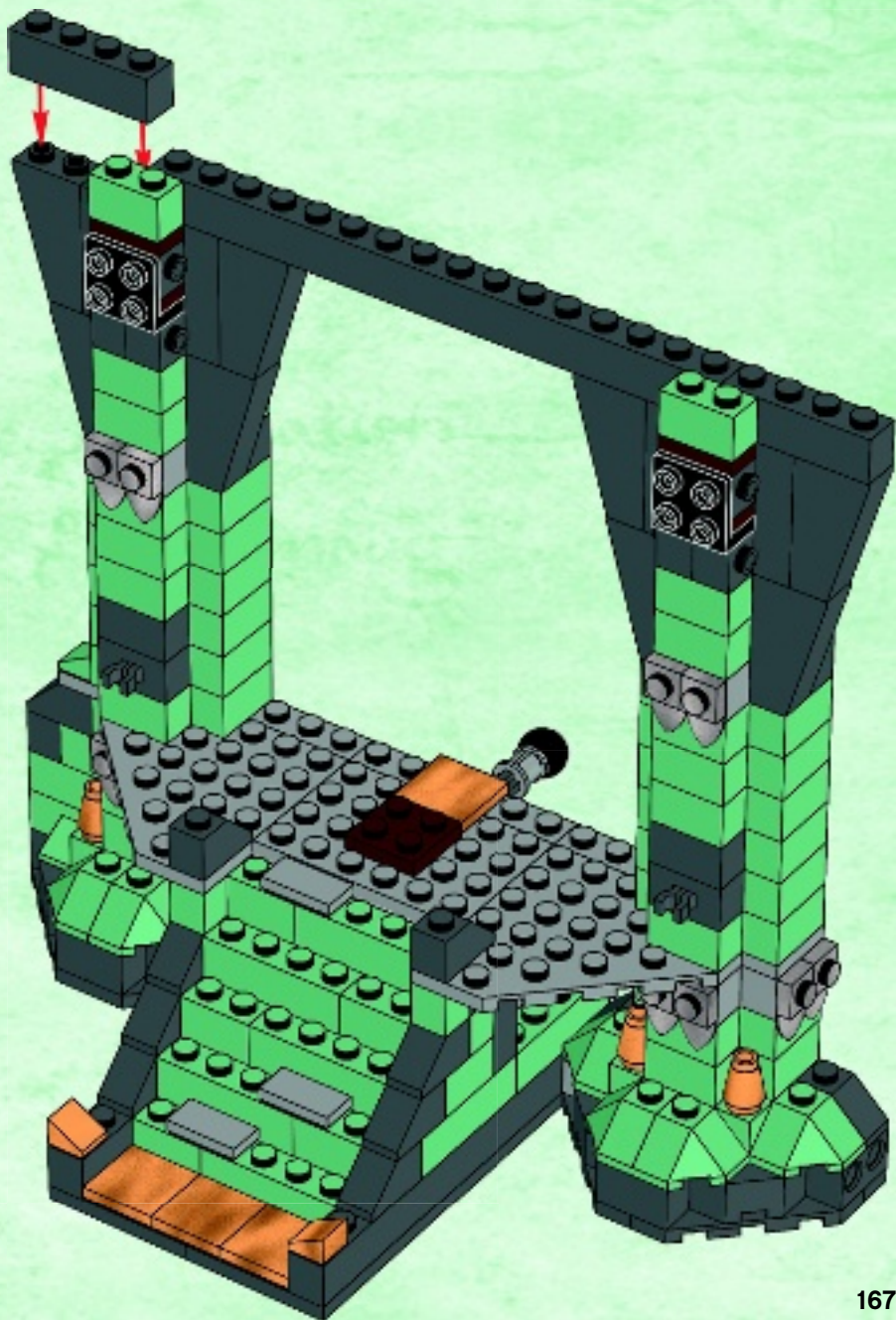



2x

43

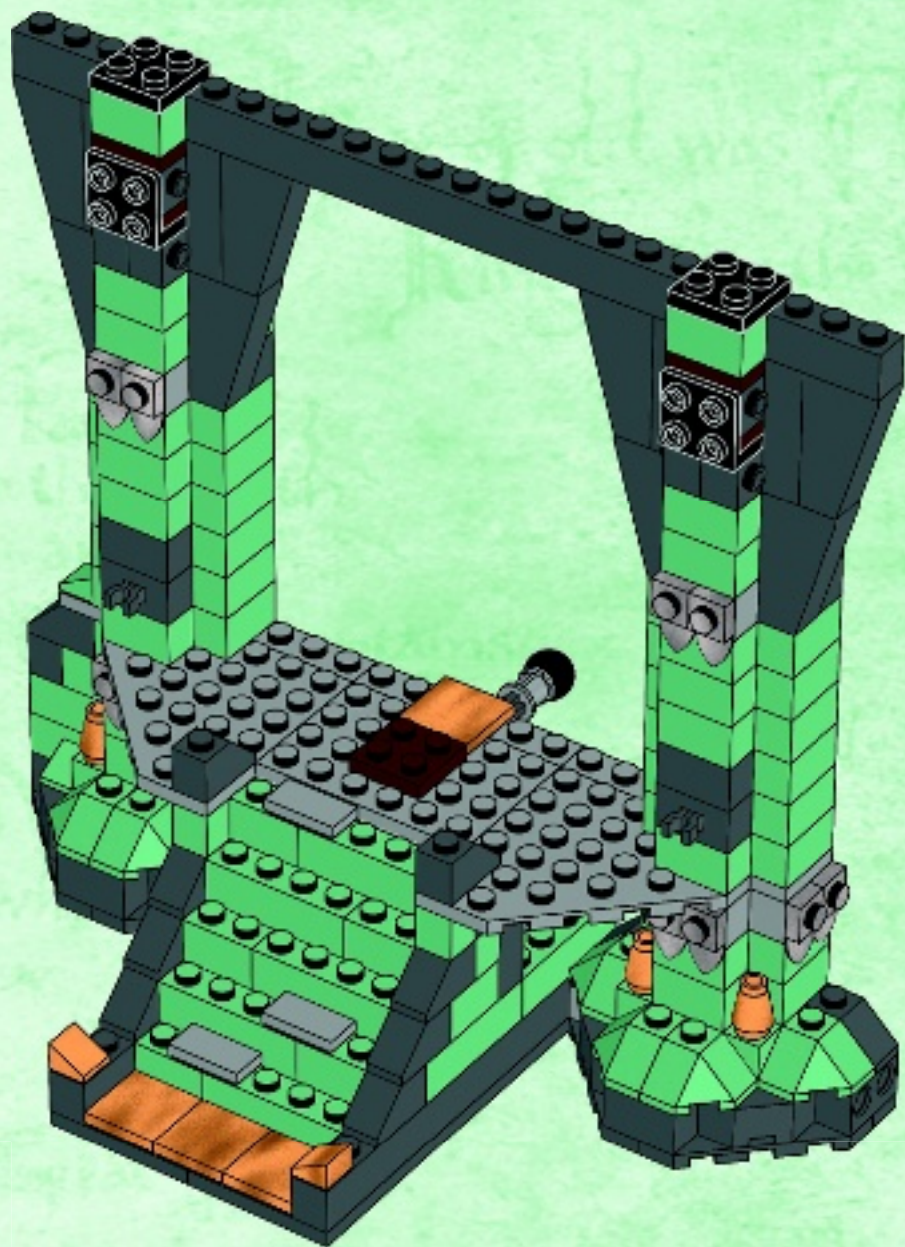





4x



8x



4x

# 44

1

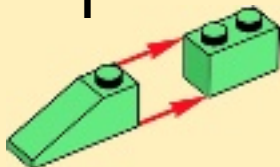

2

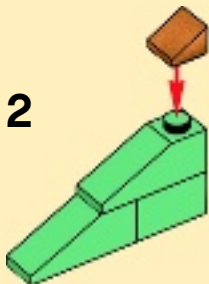



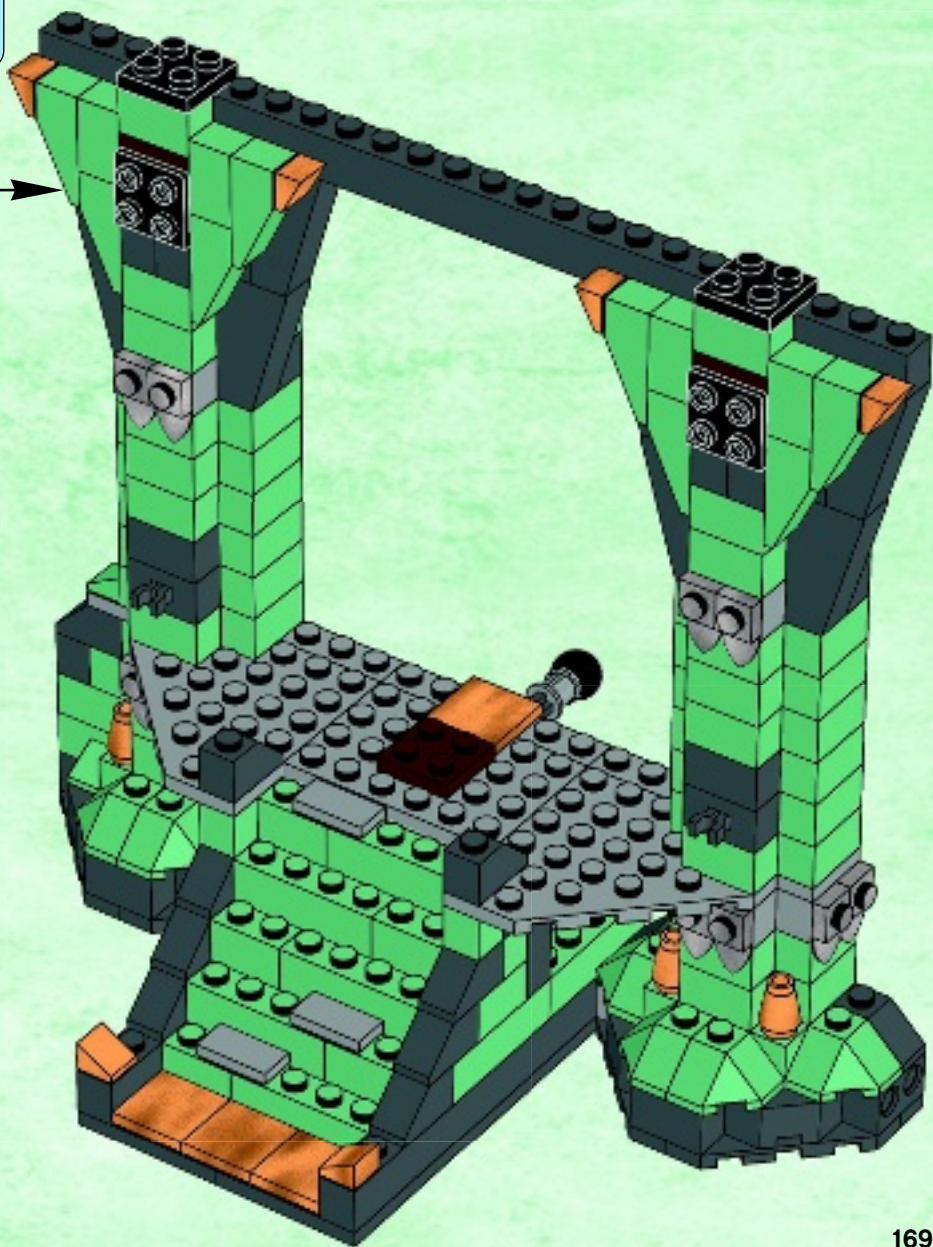

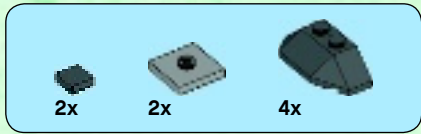
4x



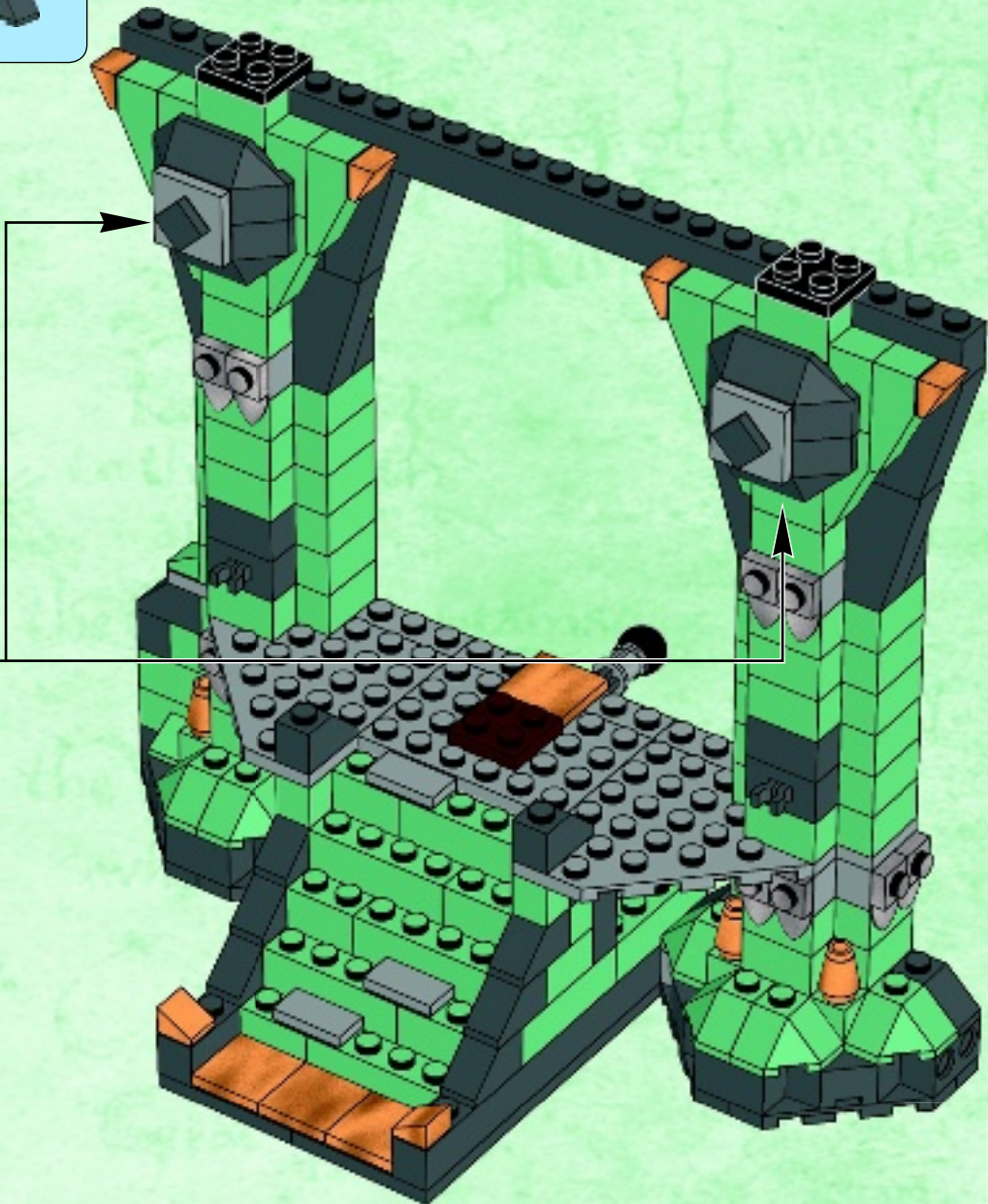
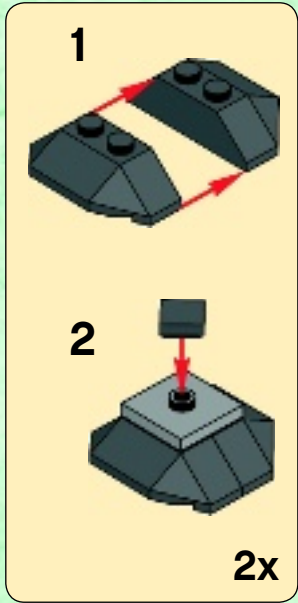

# 45

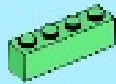

			
2x	1x	2x	2x

# 46

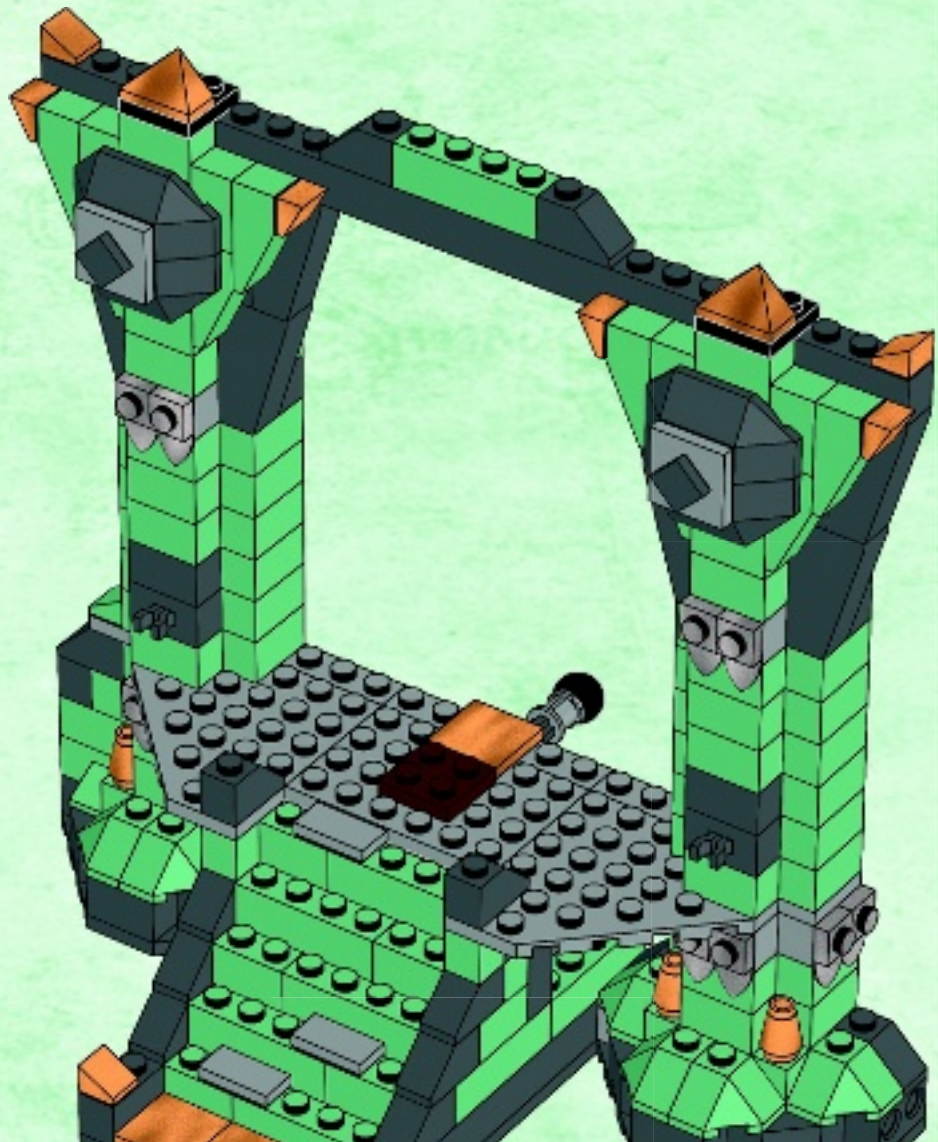



2x



2x

47

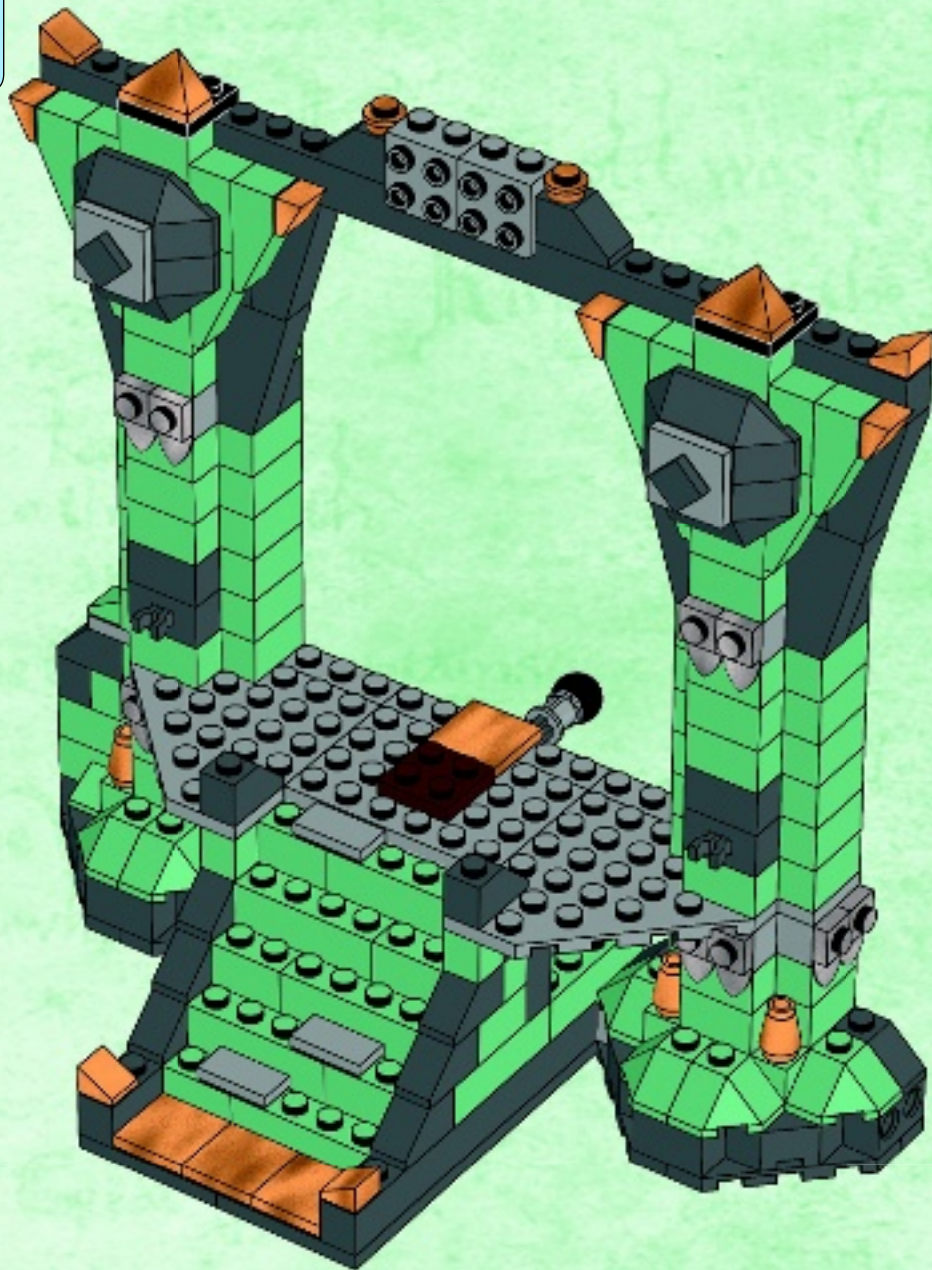

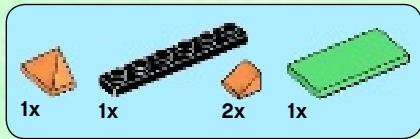

# 48

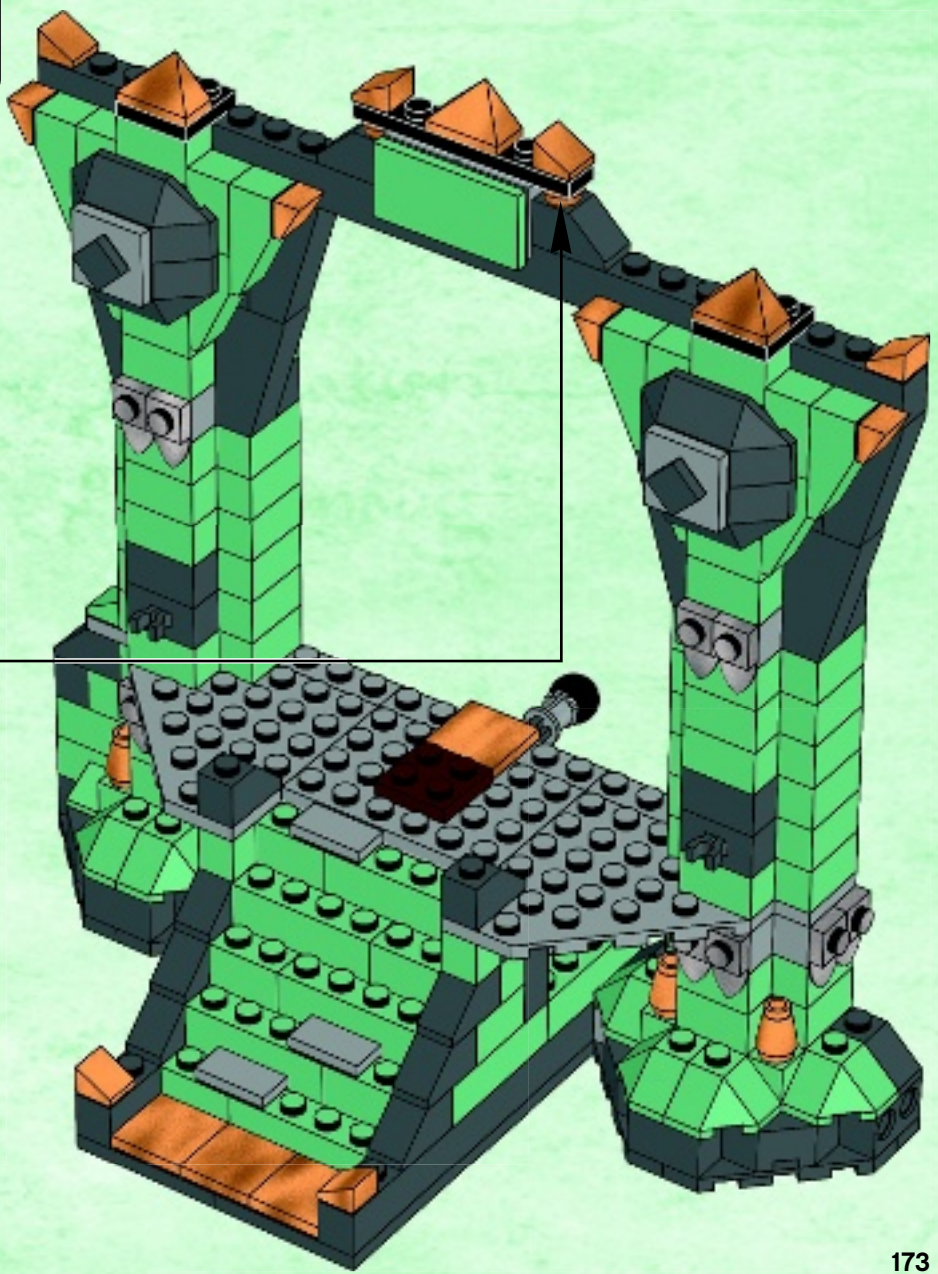
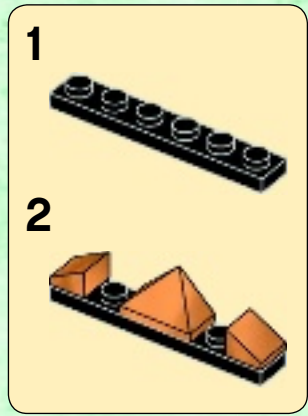

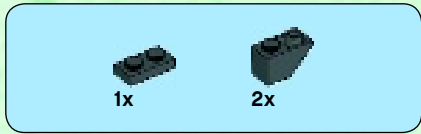

49

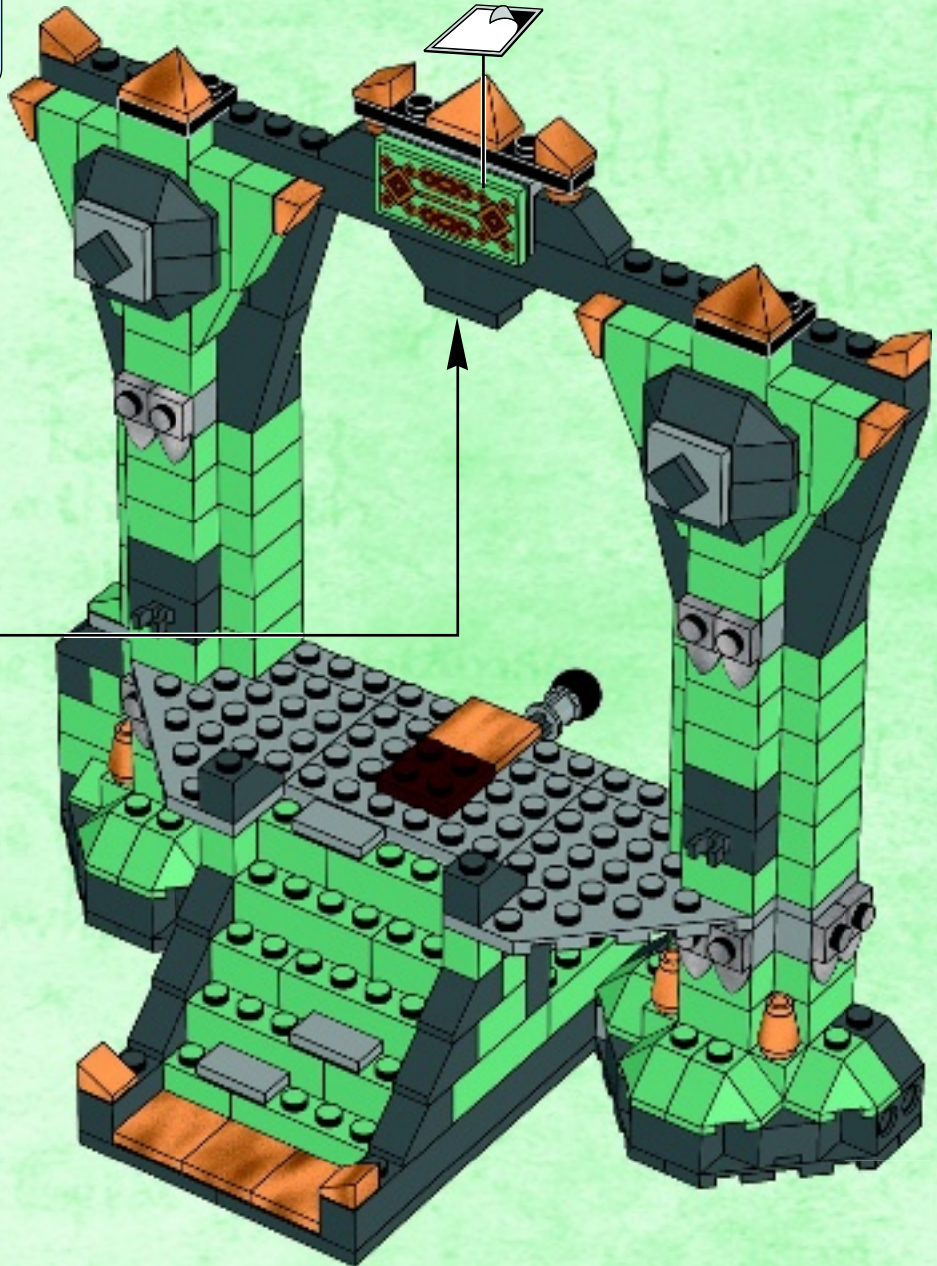
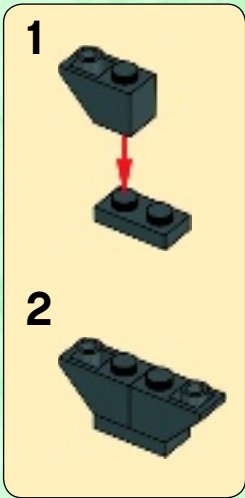



2x



2x



2x

# 50



2x

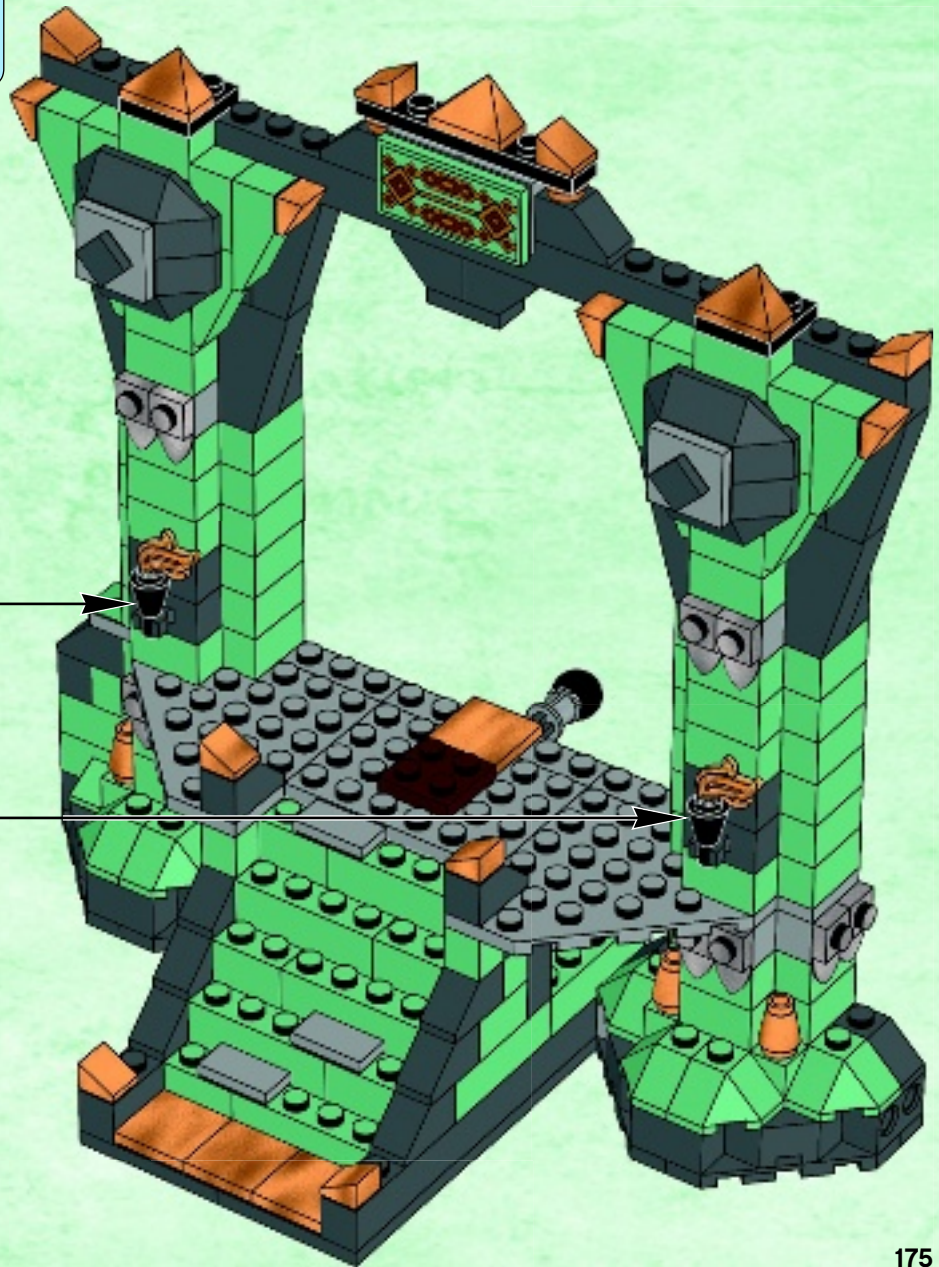

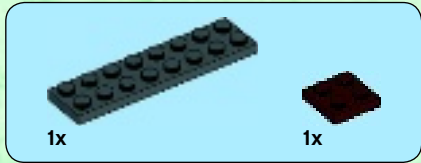

1

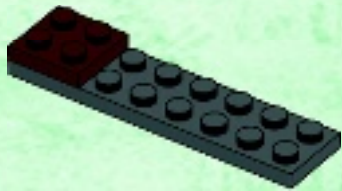

2

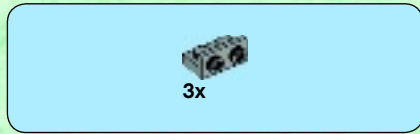
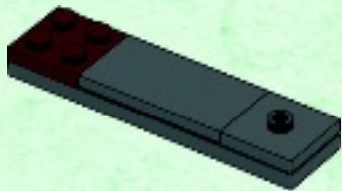

3

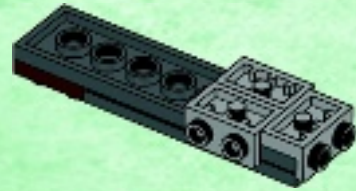
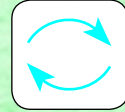

4

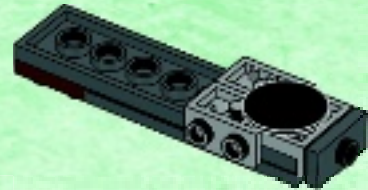





5

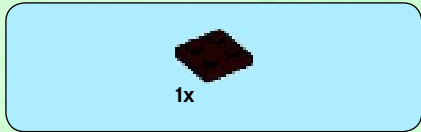
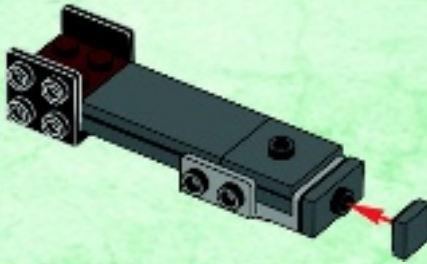
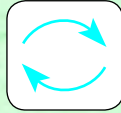

6

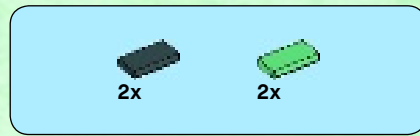
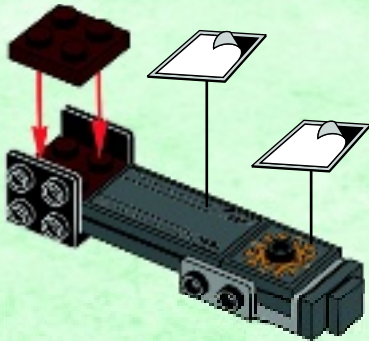

7

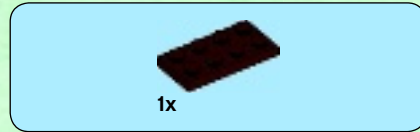
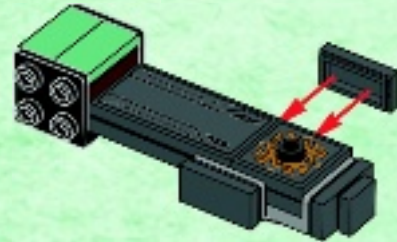

8

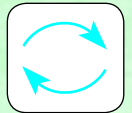



2x



1x

9

1



2



1x

10



2x

11

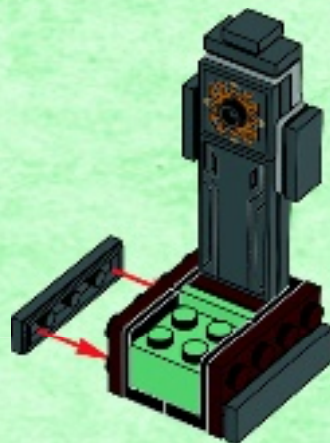



4x

# 12



2x



2x



2x

# 13



51

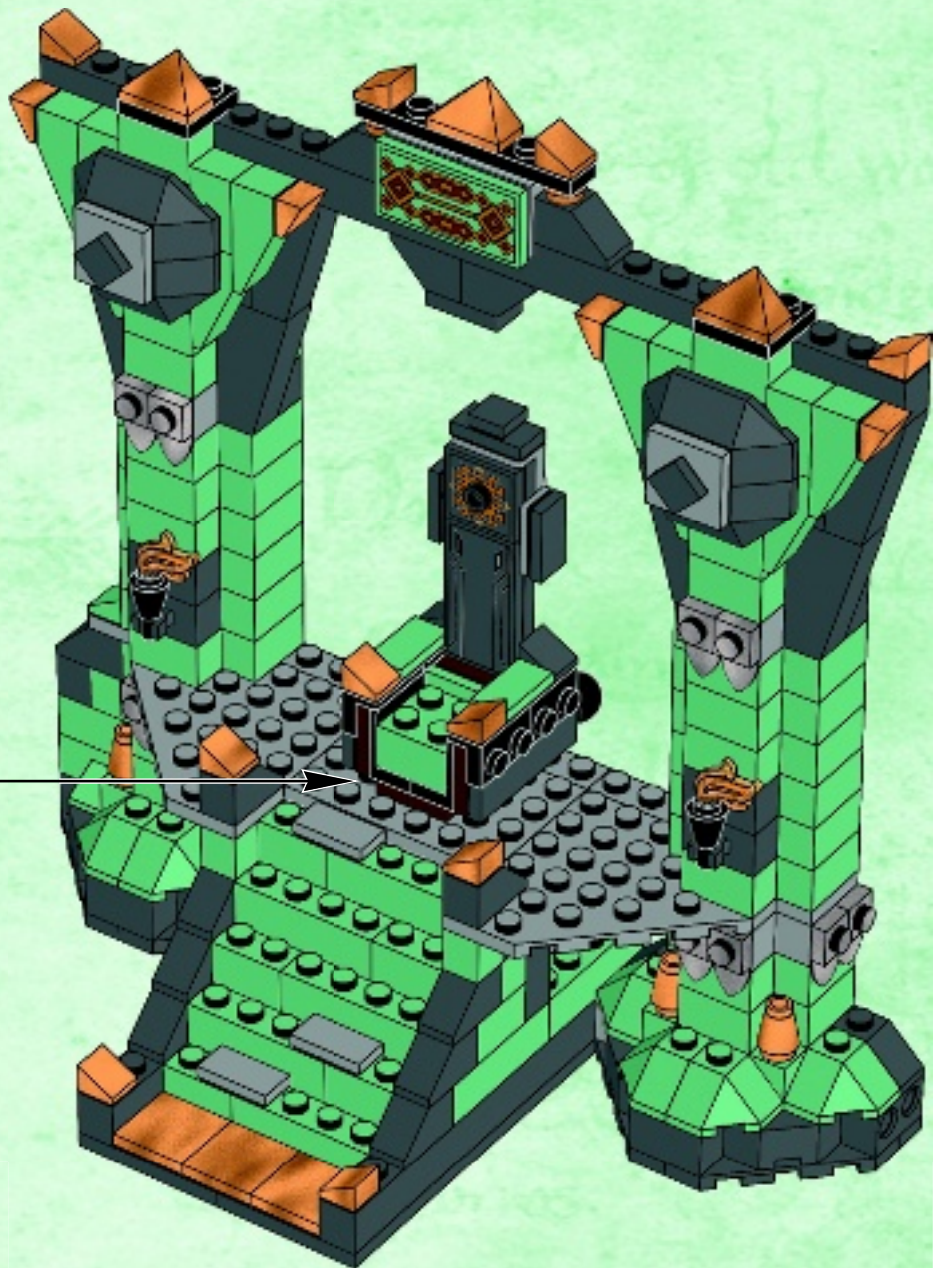

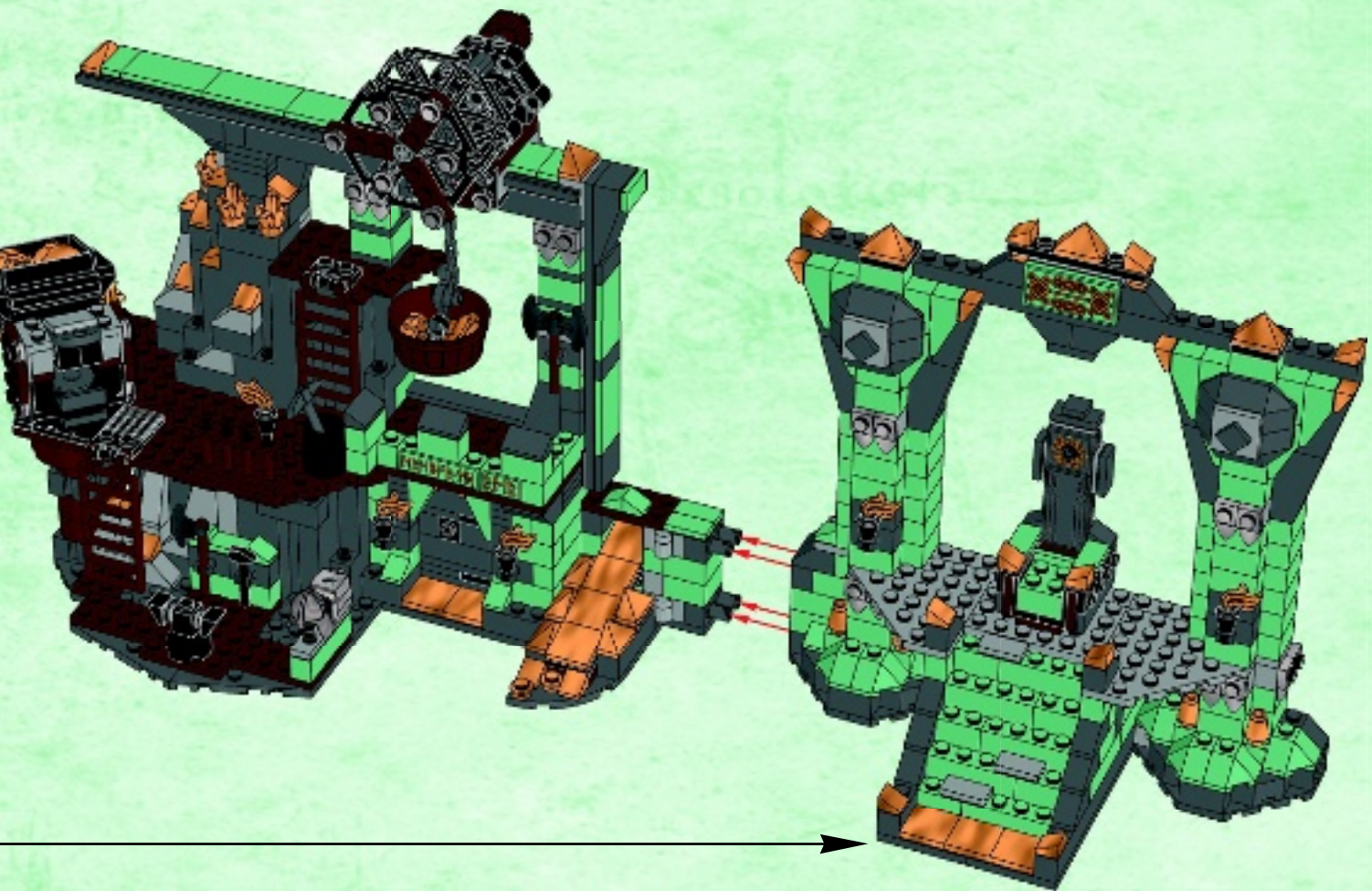





1x 6021611  
 1x 4114084  
 1x 4113858  
 1x 4206482  
 4x 4558954  
 2x 4214559  
 1x 473326  
 1x 4216660  
 2x 4141810  
 1x 389426  
 2x 370226  
 2x 4504382  
 2x 4541984  
 3x 241226  
 2x 302226  
 1x 306826  
 2x 243126  
 2x 371026  
 2x 366626  
 1x 303426  
 2x 244526  
 16x 6000650  
 4x 6016172  
 2x 4140588  
 2x 4539442  
 1x 6010831

1x 4278359  
 4x 6092570  
 1x 4140303  
 1x 6086754  
 1x 6021616  
 1x 452226  
 7x 6056234  
 7x 4568385  
 5x 4563477  
 6x 6015891  
 2x 74011  
 1x 4290713  
 2x 4121715  
 1x 370526  
 1x 6091590  
 1x 4113954

1x 6056842  
 2x 6051920  
 1x 6019570  
 1x 4119483  
 1x 4113955  
 1x 4184851  
 2x 6083877  
 1x 4654448  
 1x 4530129  
 1x 6084272  
 1x 6086769  
 1x 6088409  
 1x 6086749

11x 4521948  
 49x 4616581  
 17x 6075624  
 21x 4521947  
 20x 6075626  
 8x 4652205  
 10x 4598531  
 7x 6083973  
 10x 4616578  
 9x 4633693  
 1x 4541498  
 4x 4531415  
 1x 4613761  
 4x 6028132

1x 6088406  
 1x 6086726  
 1x 6083979  
 1x 6083978  
 3x 4244369  
 9x 4649066  
 3x 4211222  
 2x 4211195  
 5x 4508616  
 13x 4211150  
 1x 6036503  
 3x 4211166  
 1x 4211252



3x  
4211152



1x  
6034334



4x  
4216695



2x  
4224732



1x  
4541875



1x  
6066114



2x  
6030812



2x  
4262974



1x  
6002837



1x  
4252456



2x  
6061702



2x  
4211189



6x  
4211190



8x  
4211186



1x  
4243838



2x  
4211247



3x  
4271874



1x  
4211193



1x  
4222627



2x  
6055145

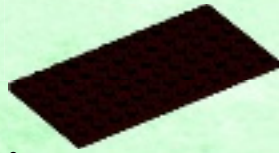

2x  
4264669



2x  
4211389



1x  
4211388



2x  
4211386



2x  
6037399



7x  
6015344



2x  
4211613



4x  
4211364



7x  
4211614



3x  
4211494



1x  
4234535



3x  
4211414



3x  
6066097



2x  
4211398



2x  
4565393



1x  
4211397



1x  
4211413



2x  
4211429



1x  
4211356



5x  
4211438



1x  
4211452



2x  
4211481



1x  
4211404



7x  
6009014



3x  
6004990



1x  
4211376



1x  
4211542



2x  
4211520



4x  
4215513



1x  
4211515



4x  
6071299



2x  
6011459



2x  
4211461



5x  
4211573



1x  
4211622



1x  
4211805



13x  
4558955



8x  
4265794



2x  
4583879

7



186

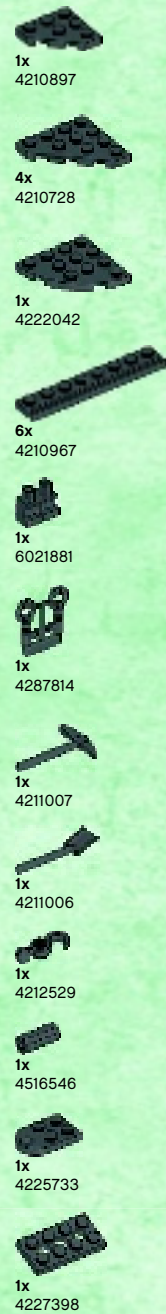
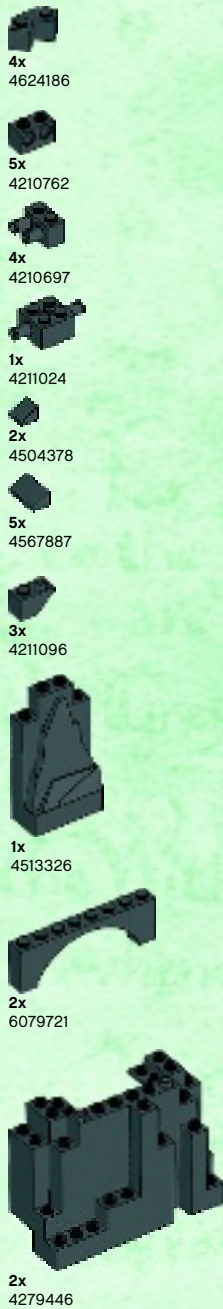



1x  
4211115



1x  
4210997



1x  
4210794



1x  
4583688



2x  
4210706



2x  
4256149



1x  
4210796



2x  
4516456



2x  
4499858



2x  
6012451



1x  
6020744



1x  
6015922



1x  
6023982



1x  
6020766



1x  
6020741



4x  
4529247



4x  
4569316



33x  
4587002



20x  
6075079



6x  
6019252



10x  
6005488



19x  
4523159



1x  
6081992



1x  
6081992

8



1x  
6009771



1x  
4505990



7x  
4516816



2x  
4519970



2x  
6005030



1x  
4536677



1x  
6005225



1x  
6021619



1x  
6002750



1x  
6021617



17x  
4633691



2x  
6093532



1x  
6002763



1x  
6021362



14x  
4625146



1x  
6093534



3x  
4613958



1x  
6078446



1x  
6051870



1x  
6088977



1x  
6088977



1x  
6088988



1x  
6088993



1x  
6088995



1x  
6088995



1x  
6088995



1x  
6088995



1x  
6088995



1x  
6088348



1x  
6088344



1x  
6088986



1x  
6088317



1x  
6088316

Customer Service  
Kundenservice  
Service Consommateurs  
Servicio Al Consumidor

LEGO.com/service or dial



: 00800 5346 5555

: 1-800-422-5346



□ 79018  
Smaug™



□ 79017  
Gundabad Orc



□ 79017  
Dain Ironfoot



□ 79018  
Bilbo Baggins™



□ 79018  
Kili the Dwarf



□ 79017  
Bard the Bowman™



□ 79018  
Fili the Dwarf



□ 79017  
Thorin Oakenshield™



□ 79017  
Azog™



□ 79015  
Witch-king



□ 79015  
Elrond™



□ 79016  
Bard the Bowman™



□ 79016  
Bain son of Bard



□ 79016  
Hunter Orc



□ 79017  
Legolas Greenleaf™



□ 79016  
Tauriel™



□ 79016  
Hunter Orc



□ 79018  
Balin the Dwarf



□ 79017  
Gwaihir™



□ 79015  
Galadriel™



□ 79017  
Gundabad Orc



□ 79018  
Dwalin the Dwarf

79017



79016





# THE HOBBIT™

## AVAILABLE NOW



[LEGO.com/TheHobbit](http://LEGO.com/TheHobbit)



PS3 PS4 PSVITA XBOX ONE XBOX 360 PC WiiU Nintendo 3DS Nintendo eShop



©2014 The LEGO Group. TM & © Warner Bros. Entertainment Inc. © New Line.™ & © SZC lic. to WBIE. LEGO, the LEGO logo and the Minifigure are trademarks and/or copyrights of the/sont des marques de commerce et/ou copyrights du/son marcas registradas, algunas de ellas protegidas por derechos de autor, de LEGO Group. (s14)  
Nintendo trademarks and copyrights are properties of Nintendo. "PlayStation" and the "PS" Family logo are registered trademarks and the PlayStation Network logo is a trademark of Sony Computer Entertainment Inc. The "PSVITA" logo is a trademark of the same company. All other trademarks and copyrights are the property of their respective owners. All rights reserved.

# WIN

GO TO [WWW.LEGO.COM/PRODUCTFEEDBACK](http://WWW.LEGO.COM/PRODUCTFEEDBACK) AND  
GIVE US YOUR SHORT **FEEDBACK** ABOUT THIS  
LEGO® SET FOR A CHANCE TO WIN  
A COOL LEGO PRIZE.



## LEGO.com/productfeedback

### GEWINNE



Erzähle uns auf  
[www.LEGO.com/productfeedback](http://www.LEGO.com/productfeedback)

*etwas über die Erfahrungen, die du mit  
diesem LEGO® Set gemacht hast, und  
sichere dir die Chance auf einen coolen  
LEGO Preis!*

### GAGNE



Rends-toi sur  
[www.LEGO.com/productfeedback](http://www.LEGO.com/productfeedback)

*et donne-nous quelques commentaires  
sur ce produit LEGO® pour avoir une  
chance de gagner un prix LEGO !*

### GANAN



Visita  
[www.LEGO.com/productfeedback](http://www.LEGO.com/productfeedback)

*y envíanos tu opinión acerca de este set  
LEGO®. ¡Participarás en el sorteo de un  
premio LEGO!*

### 获取奖品



登录  
[www.LEGO.com/productfeedback](http://www.LEGO.com/productfeedback)

*给出关于此乐高®套装的简短反馈，  
就有机会获得炫酷乐高奖品*