

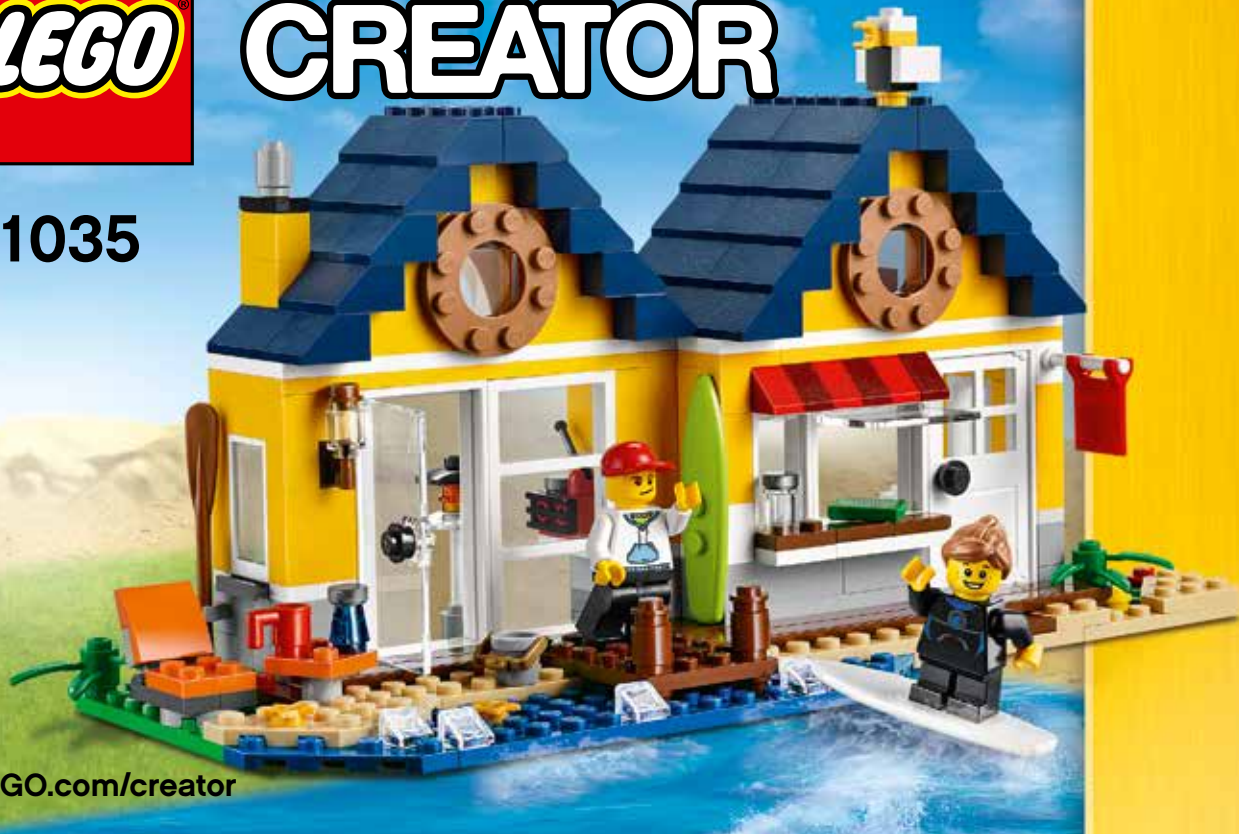

CREATOR

31035



LEGO.com/creator

1



2



3



4



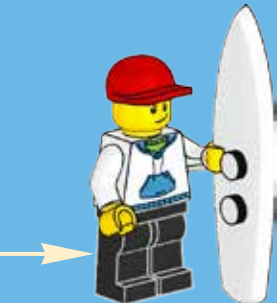
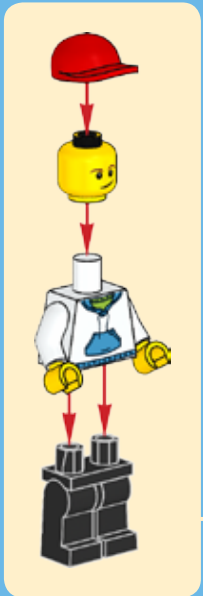

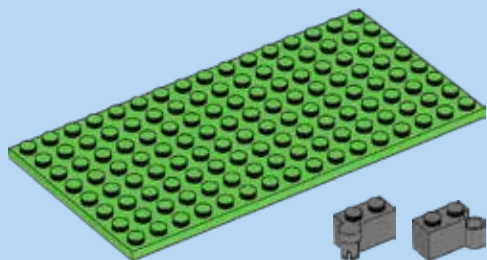

1x

1x

1x

1

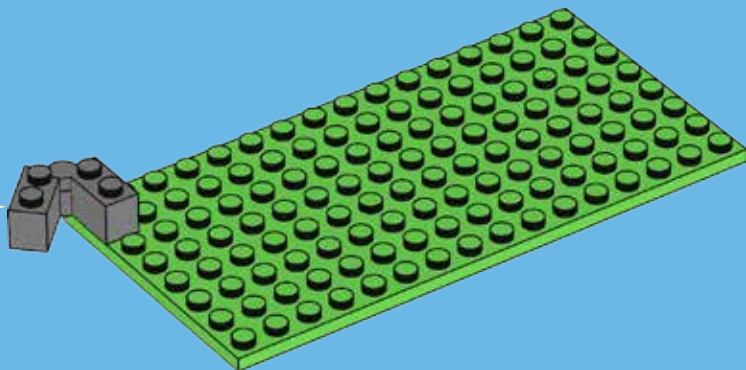
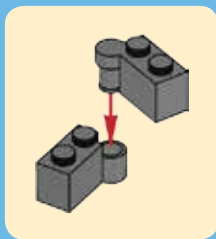



1x



1x

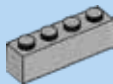

2x



1x

2

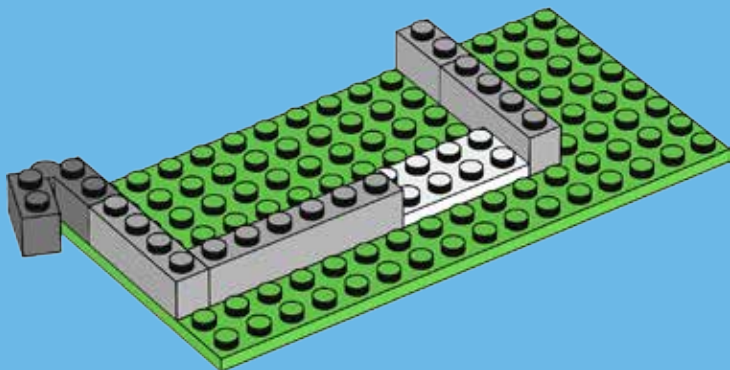



2x



1x

3

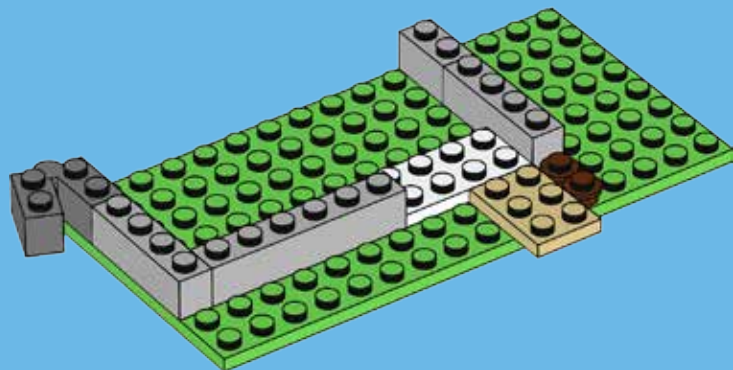



2x

4

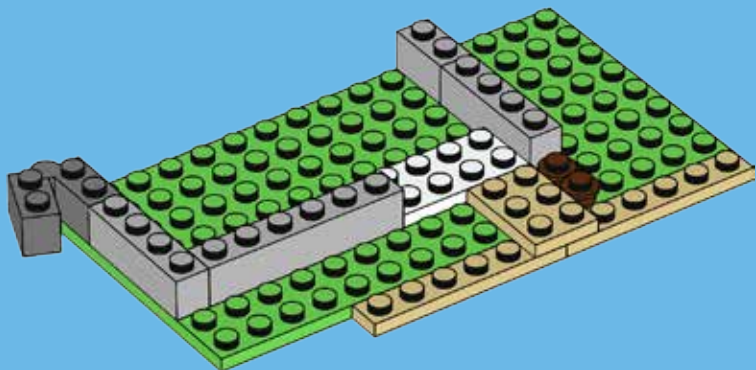



1x



1x



2x

5

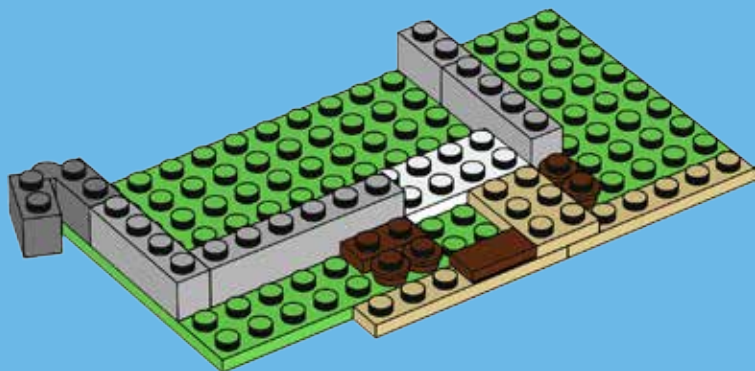



2x

6

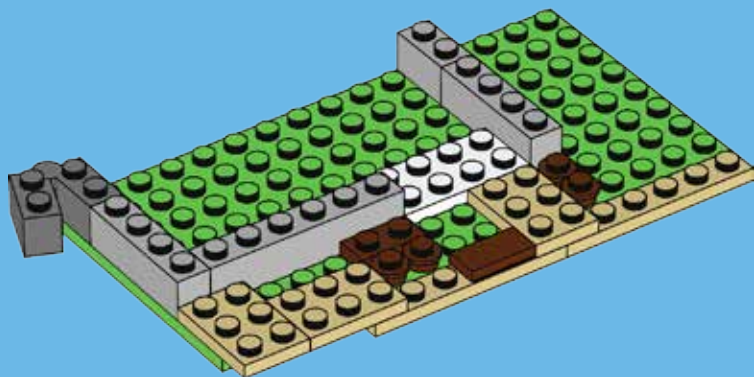



2x



1x



1x



1x

7

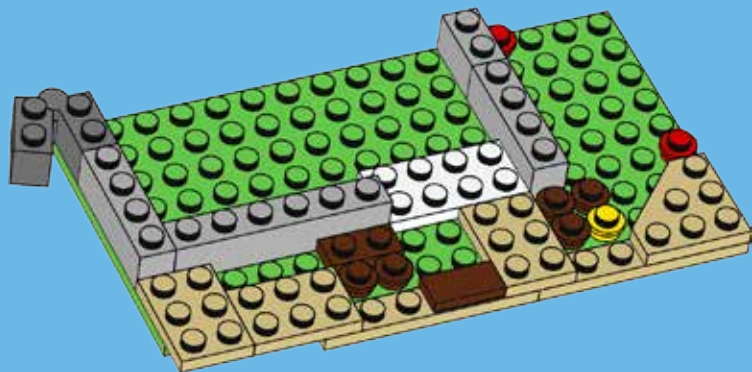



1x



1x



1x

8

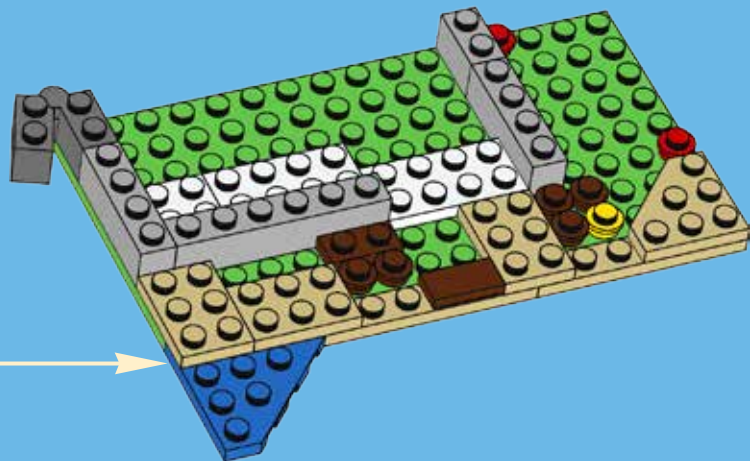



1x



1x



1x



4x

9

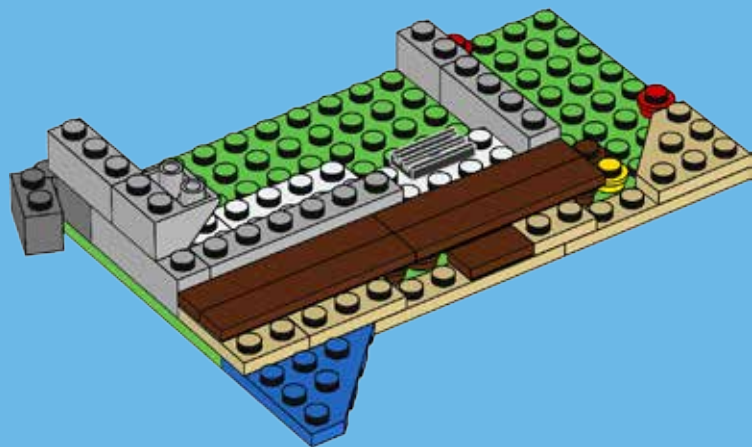



1x



1x

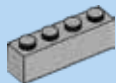

1x



1x

10

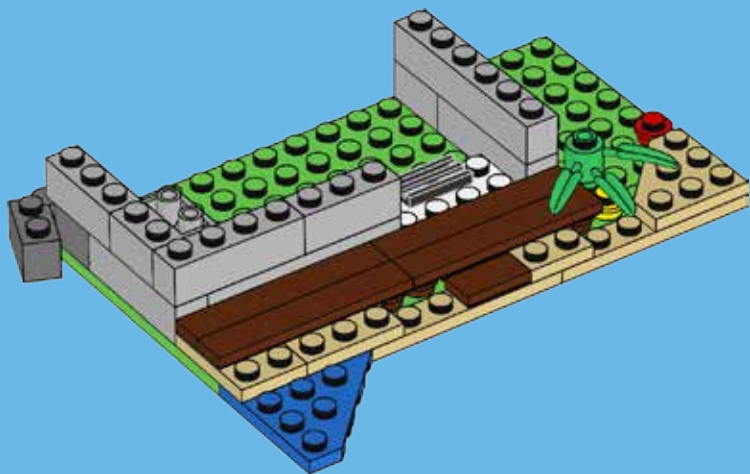



1x



1x



1x



2x

11

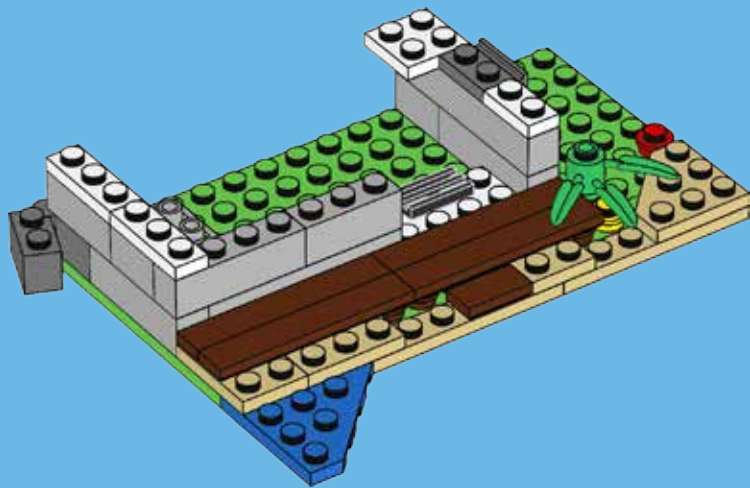



1x



1x



2x

12

1

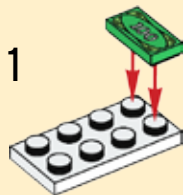

2

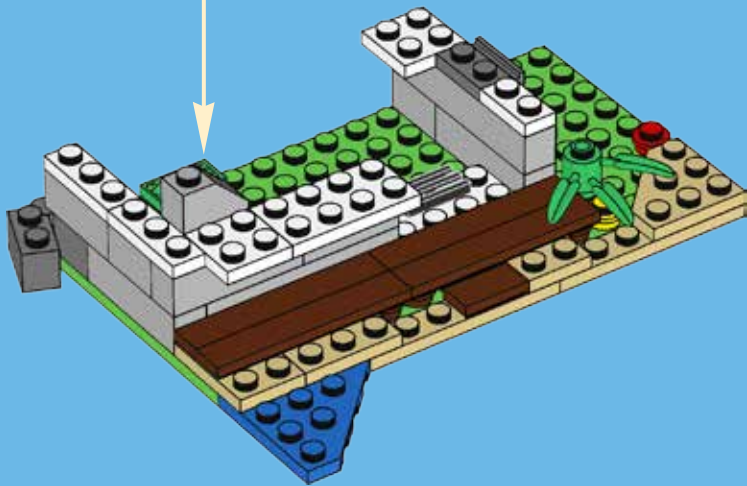

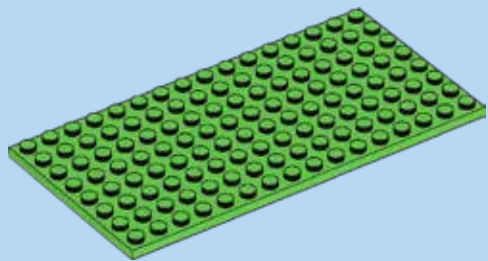

1x

13

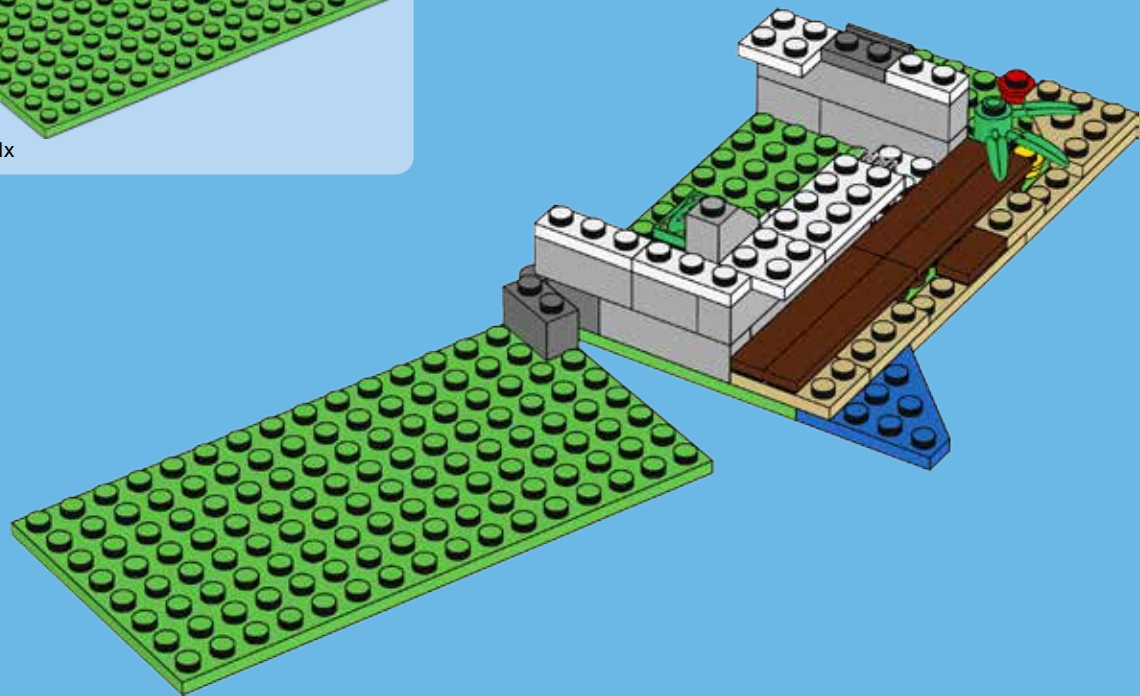



2x



1x



2x



1x

14

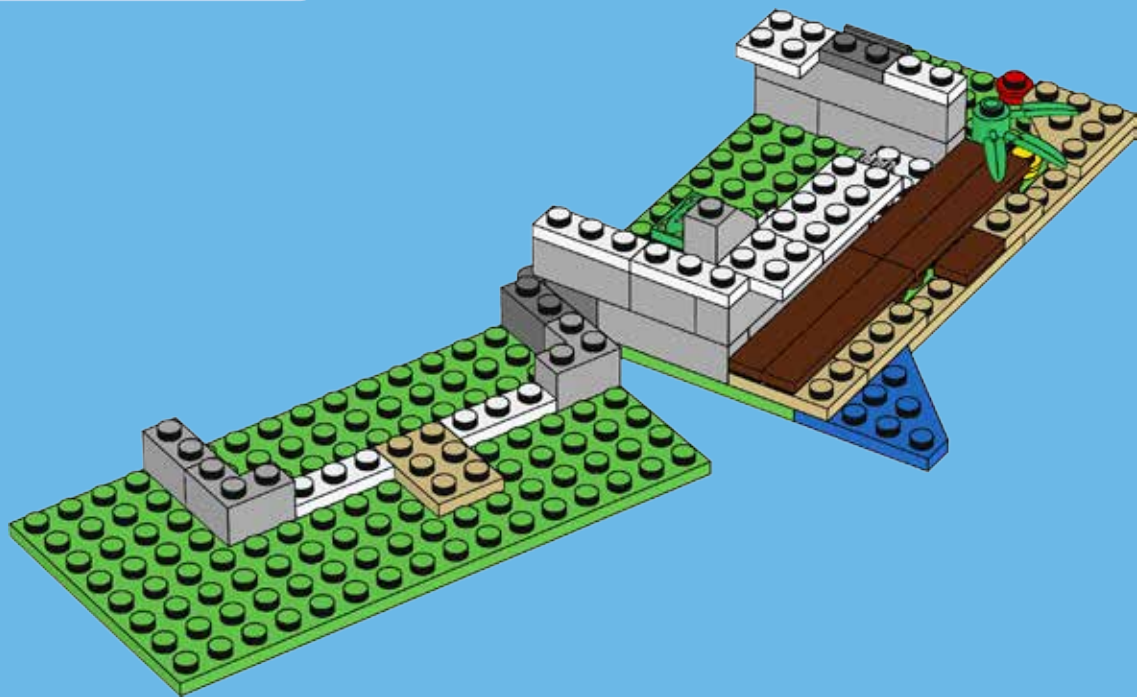

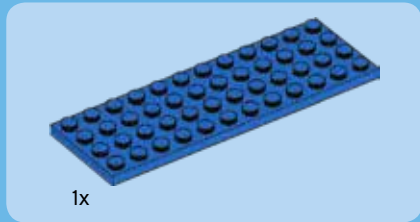

16

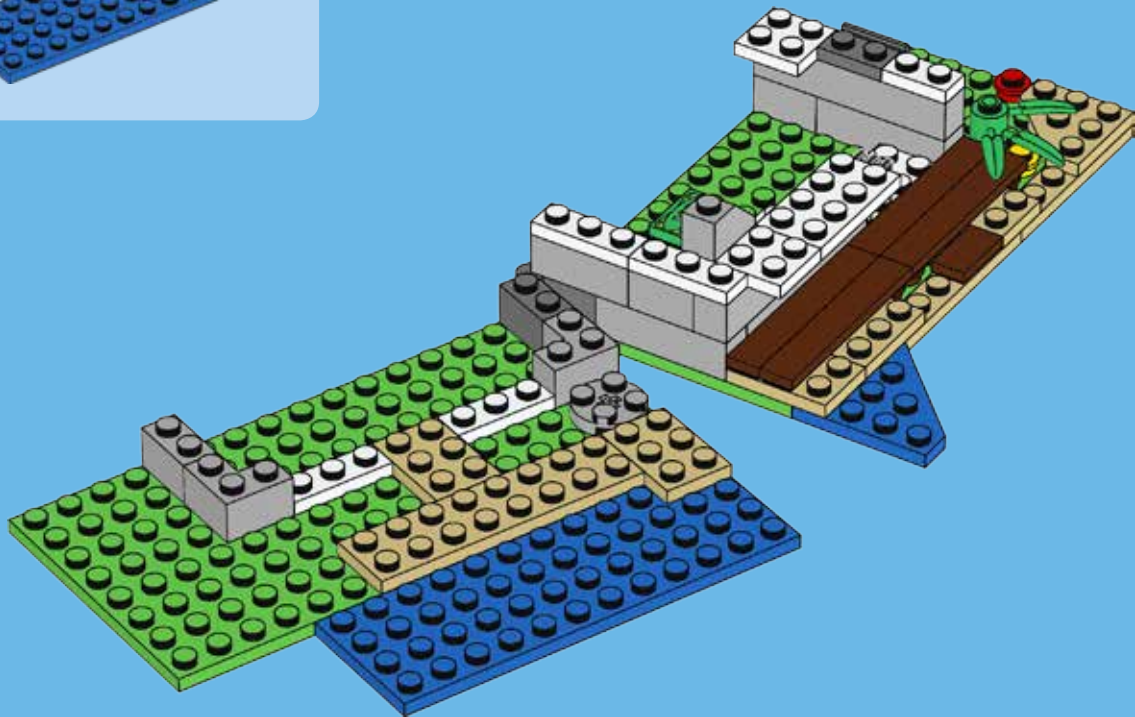



1x



1x

17

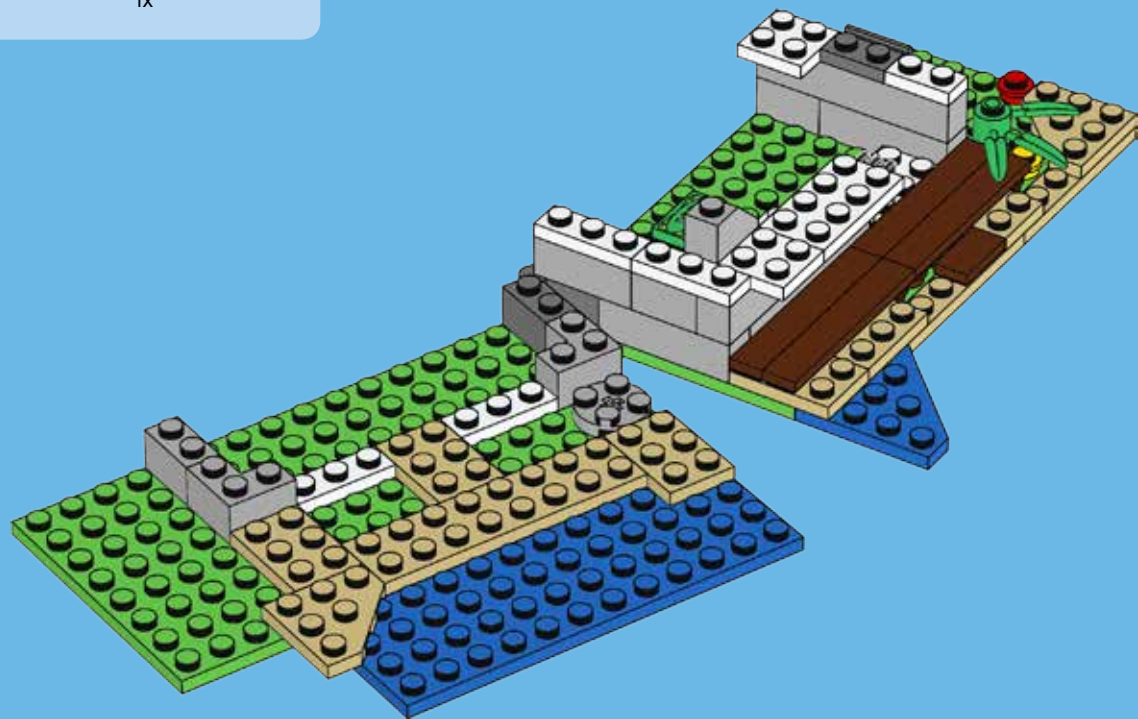



2x



3x



1x

18

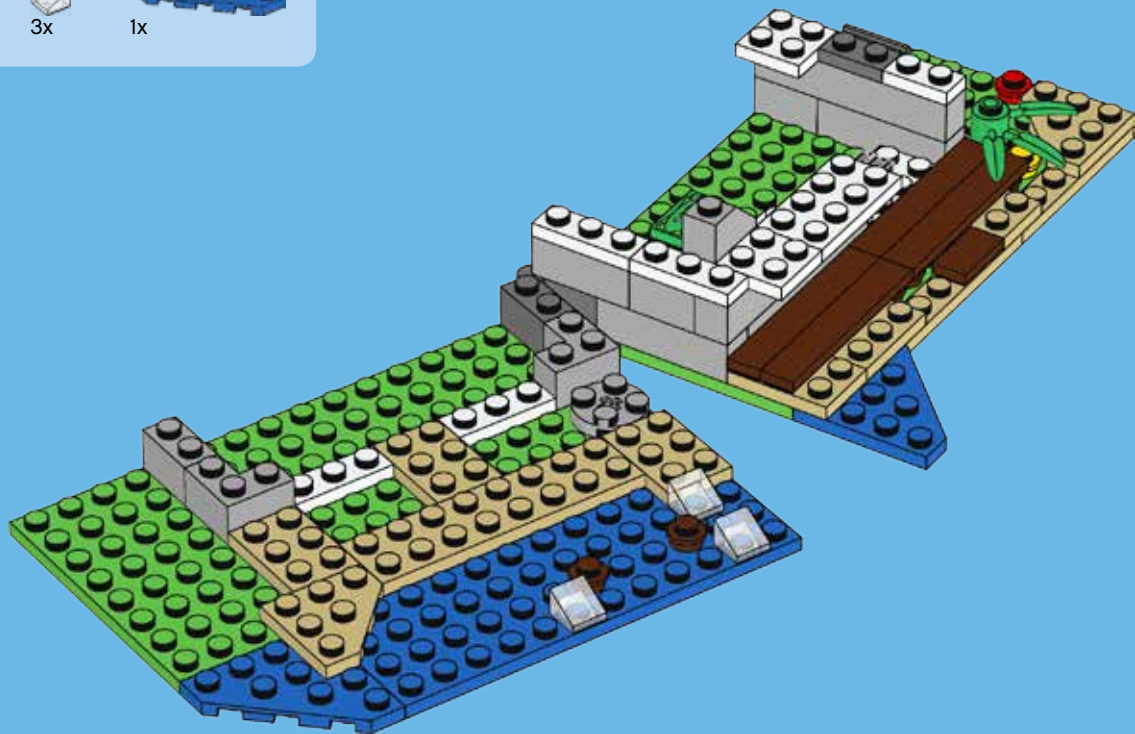



1x



1x



1x



1x



1x

19

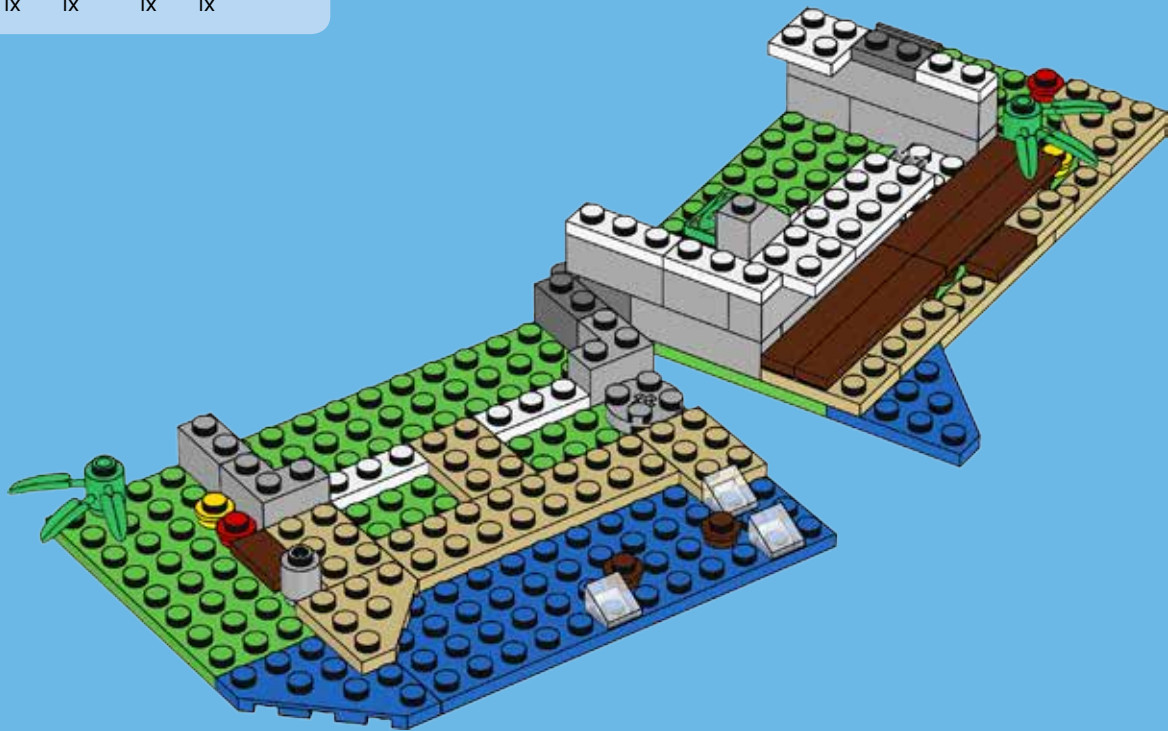



1x



2x

20

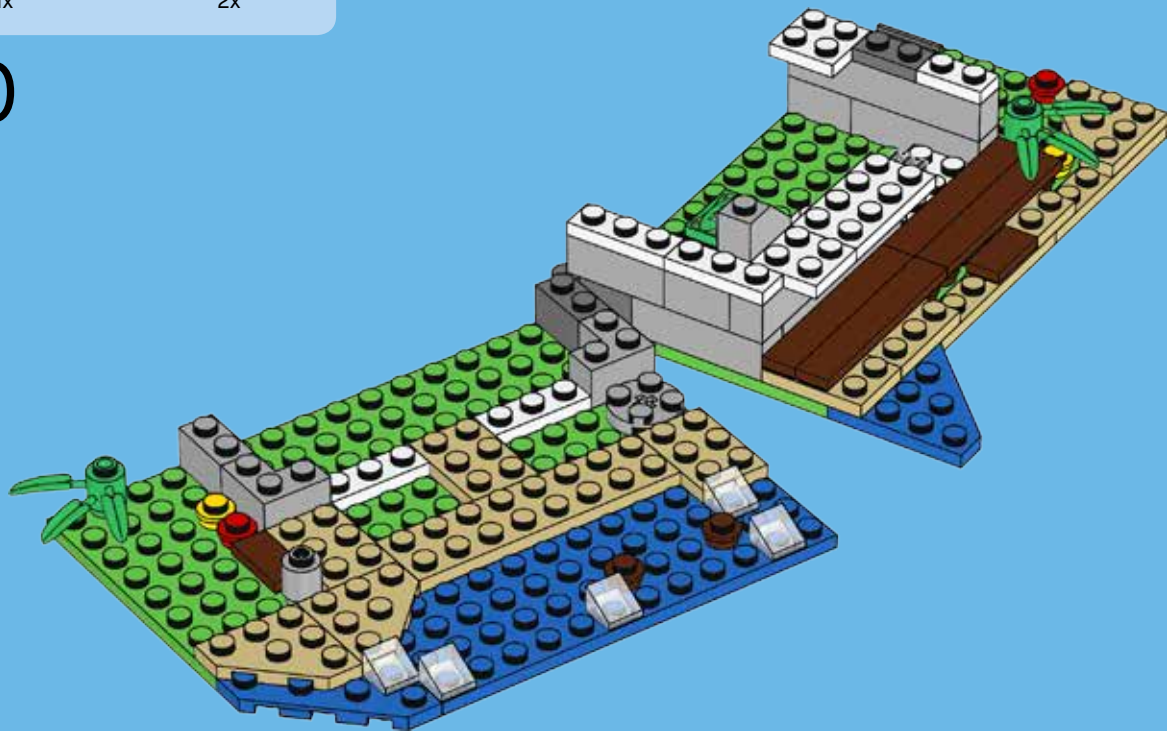



3x



3x

21

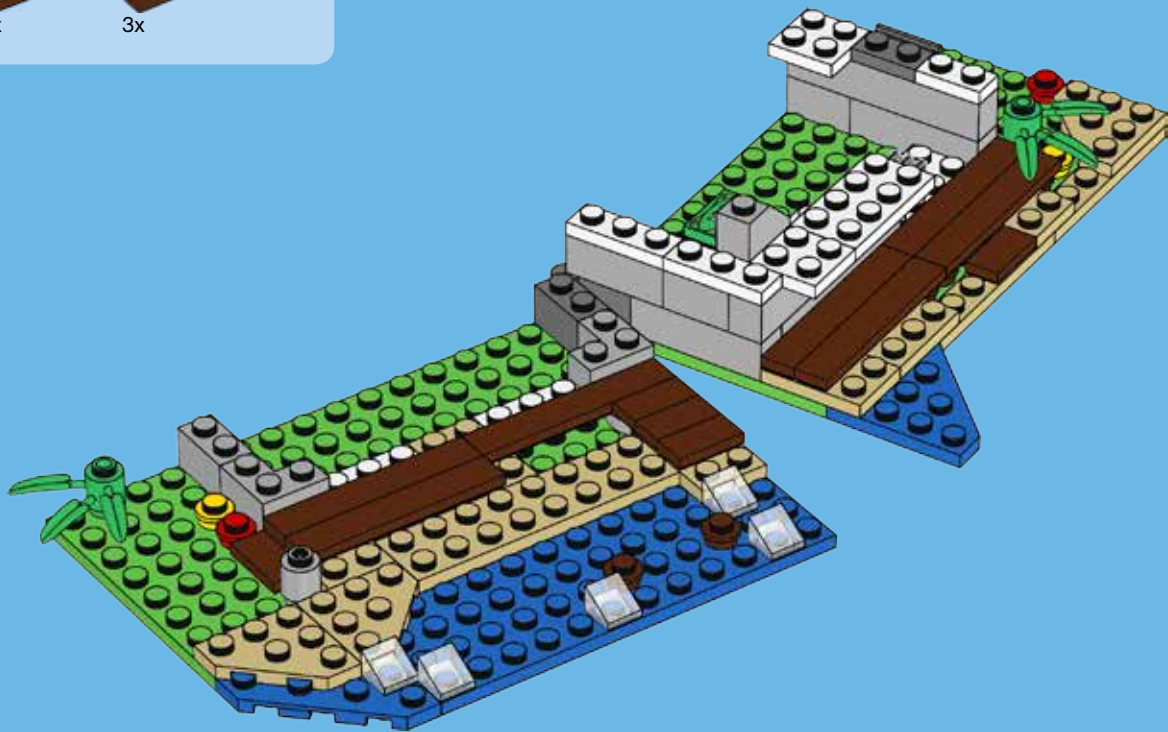



2x



1x

22





2x



2x

23

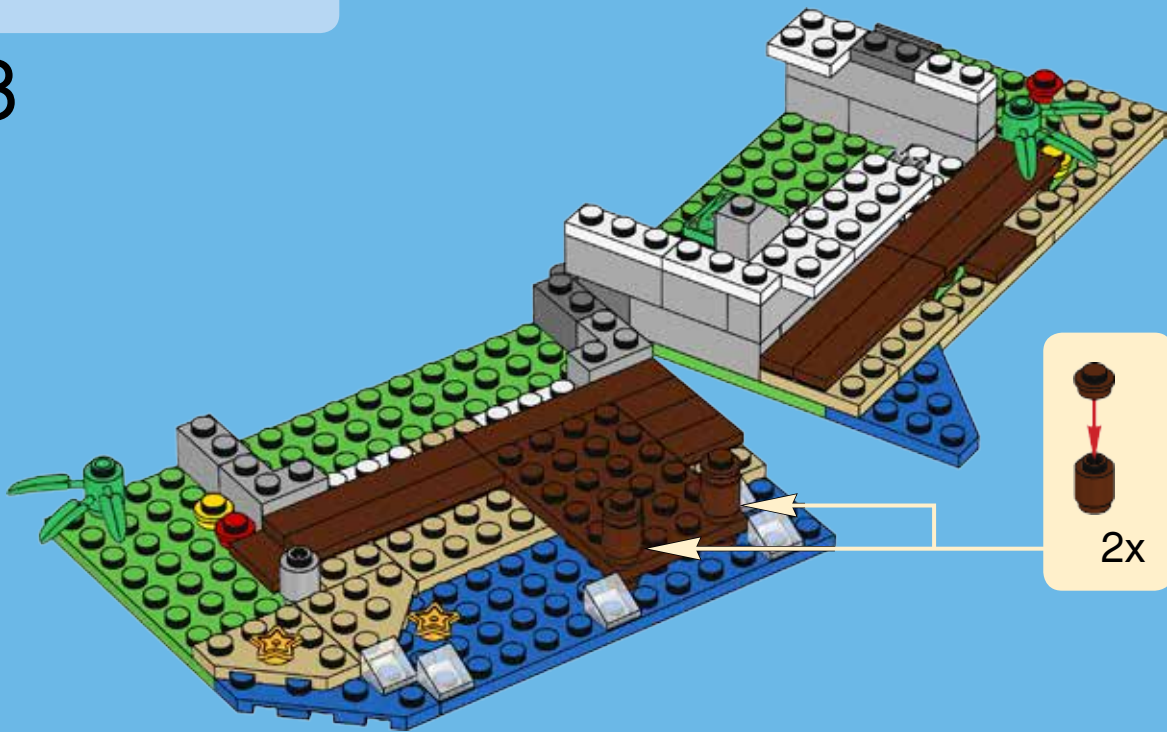

2x



3x



1x



1x

24





1x



1x



1x



1x

25

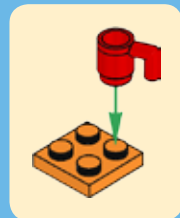
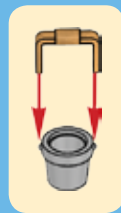



1x



1x



1x



1x

26





1x



1x



2x

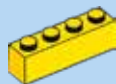

1x

27

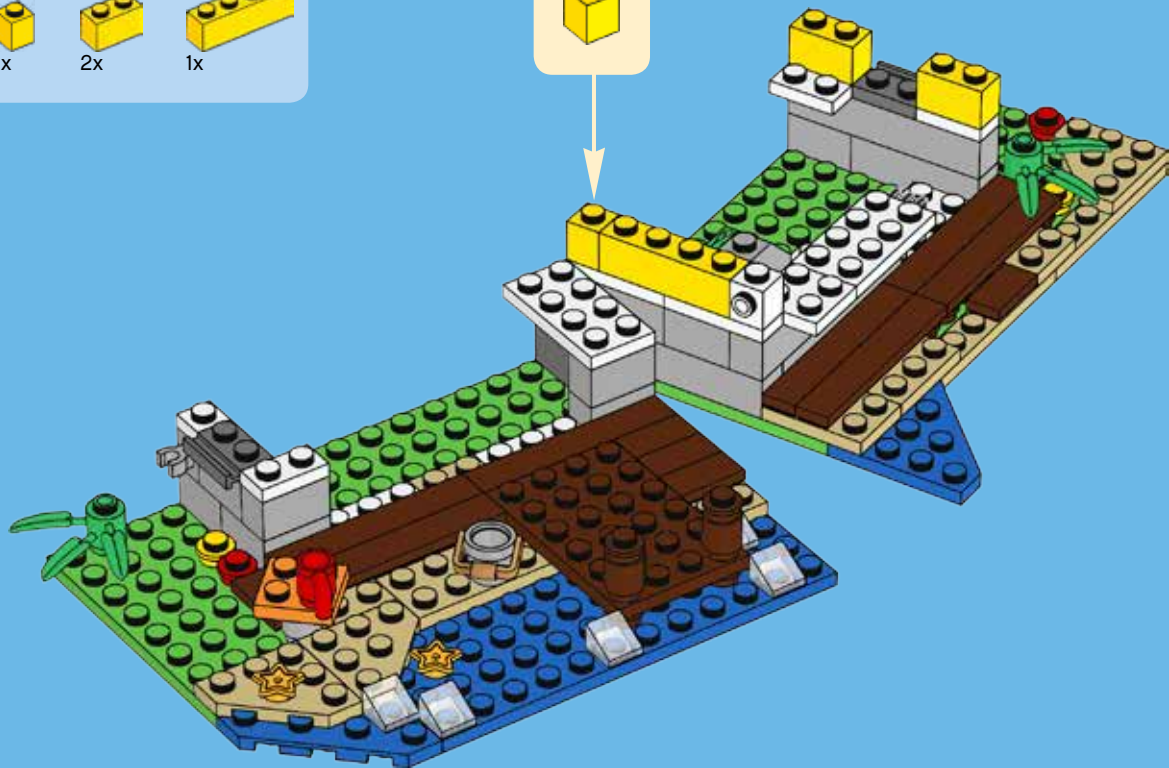



1x



2x



1x

28



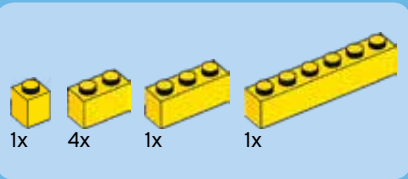

29



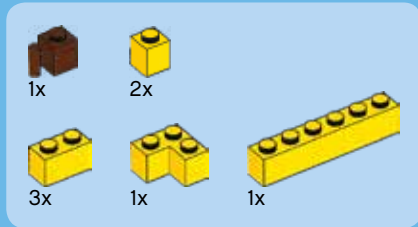

30

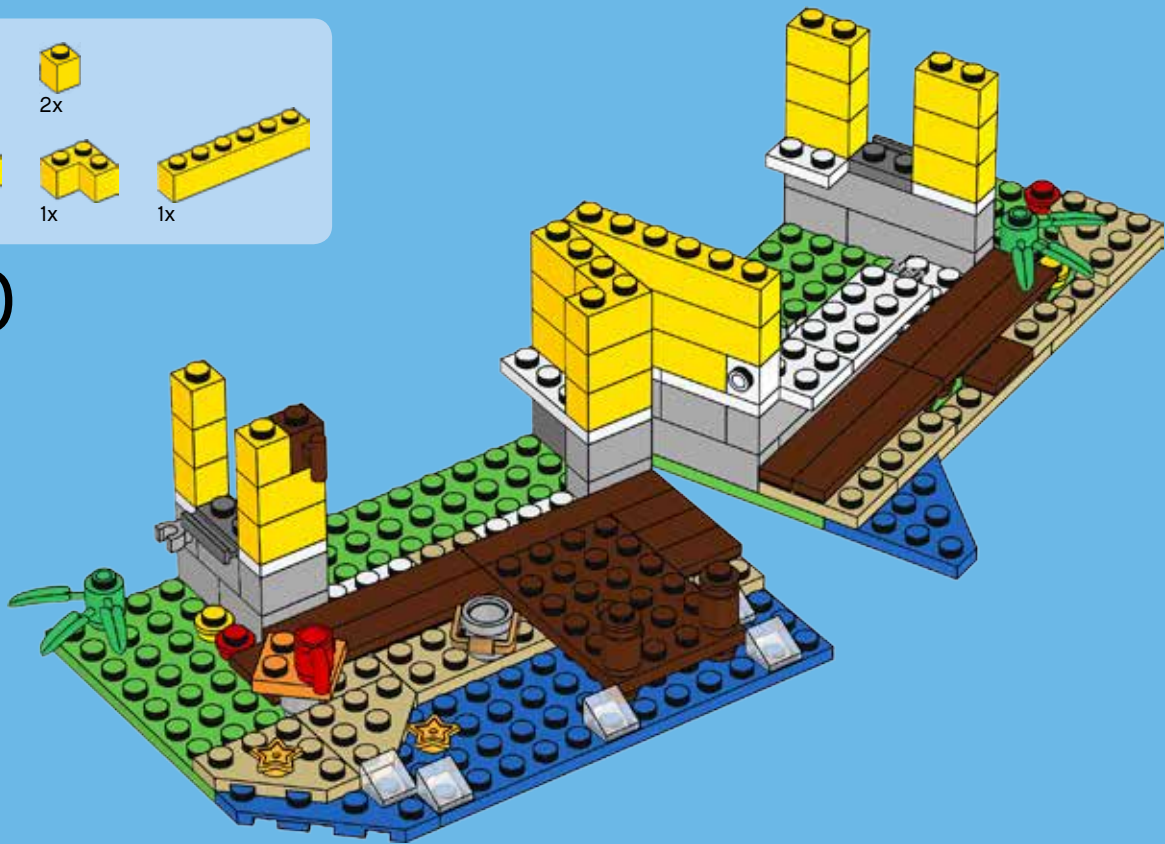



1x



1x



1x



1x

31

1

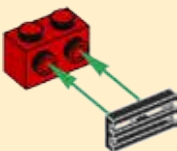

2

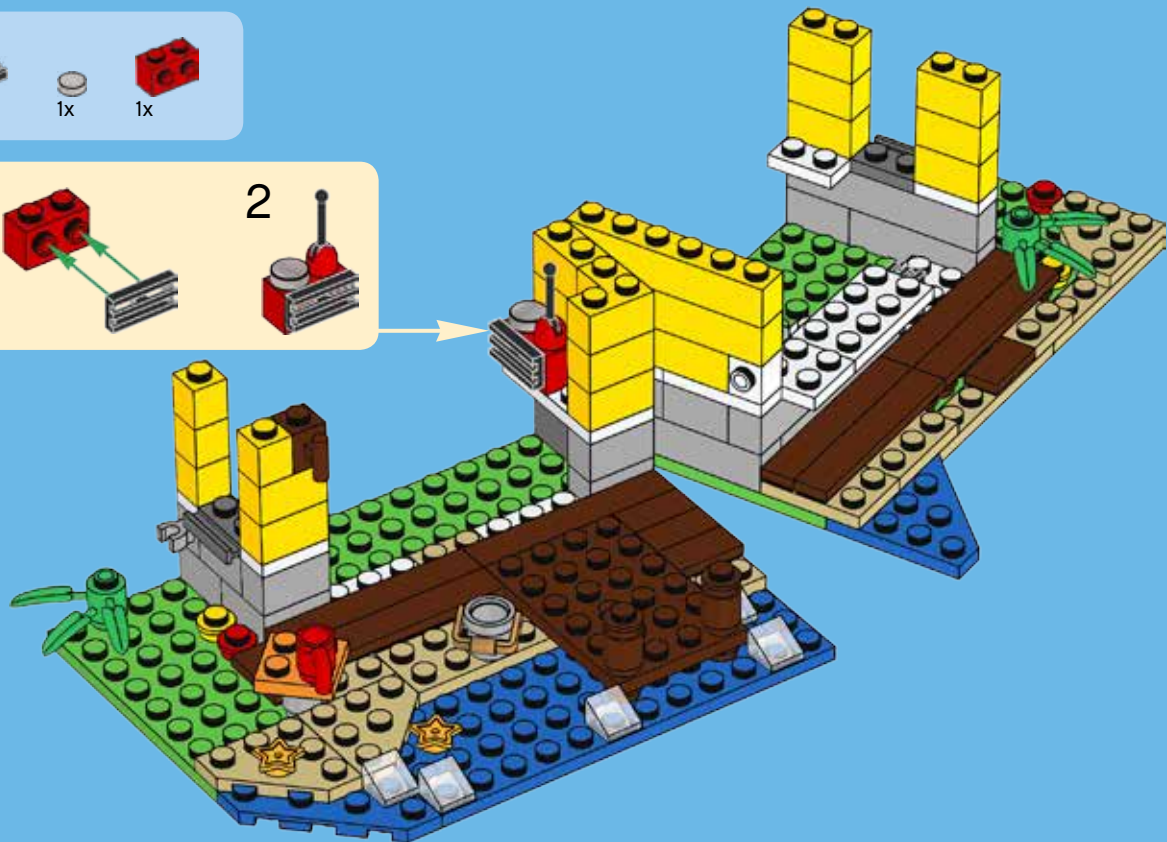



3x



3x

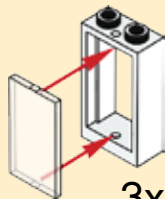

3x

32

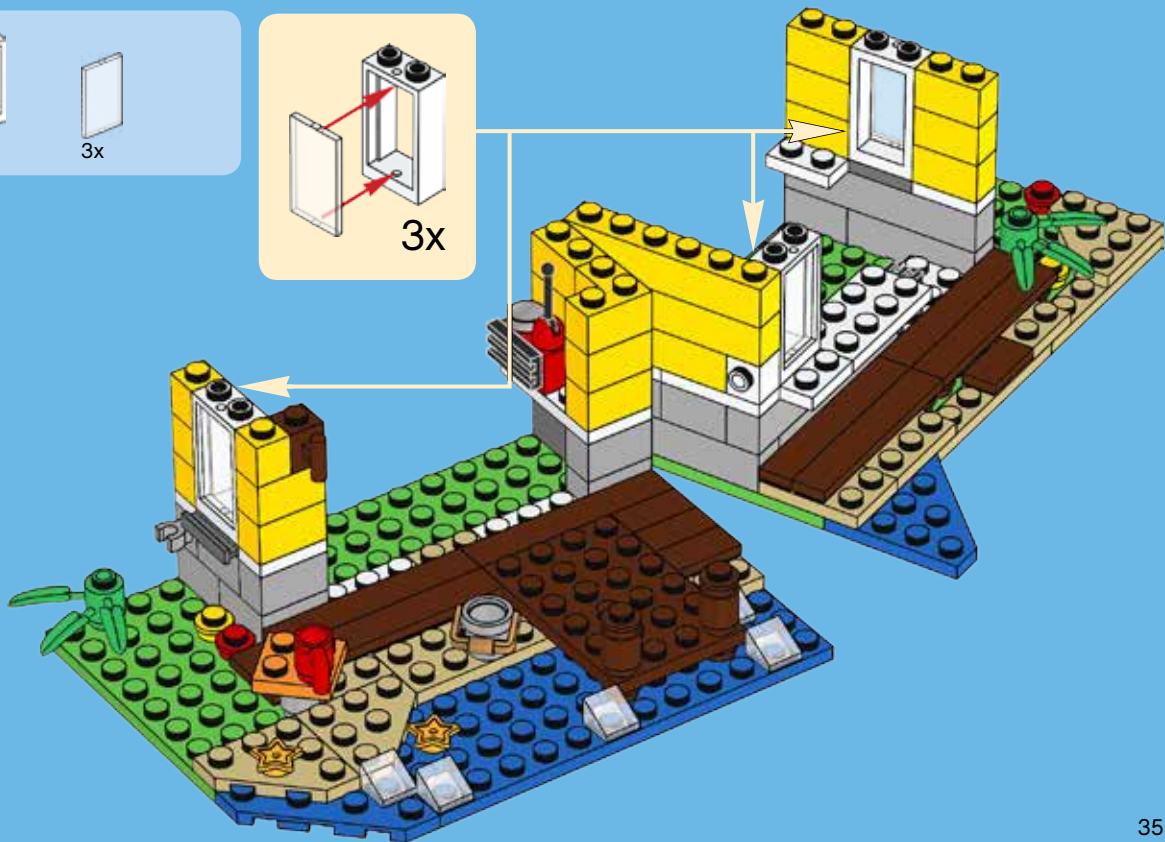

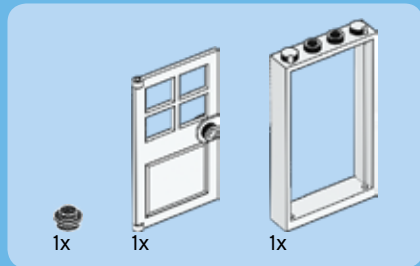

33

1

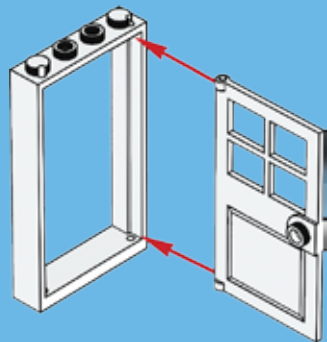

2

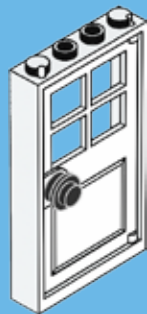

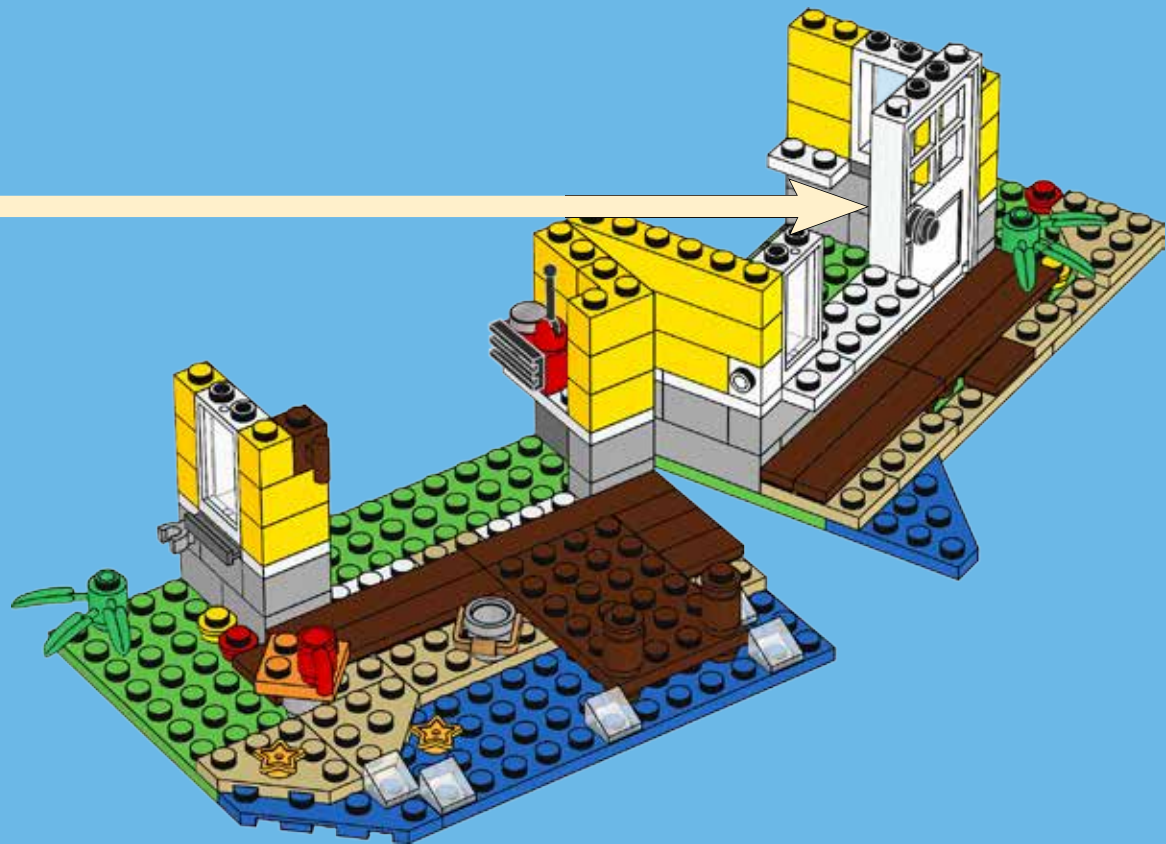



1x

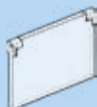

1x

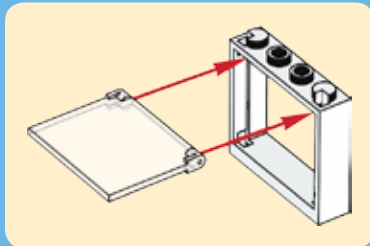

34



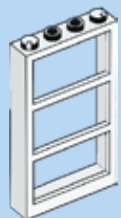

1x



1x

35

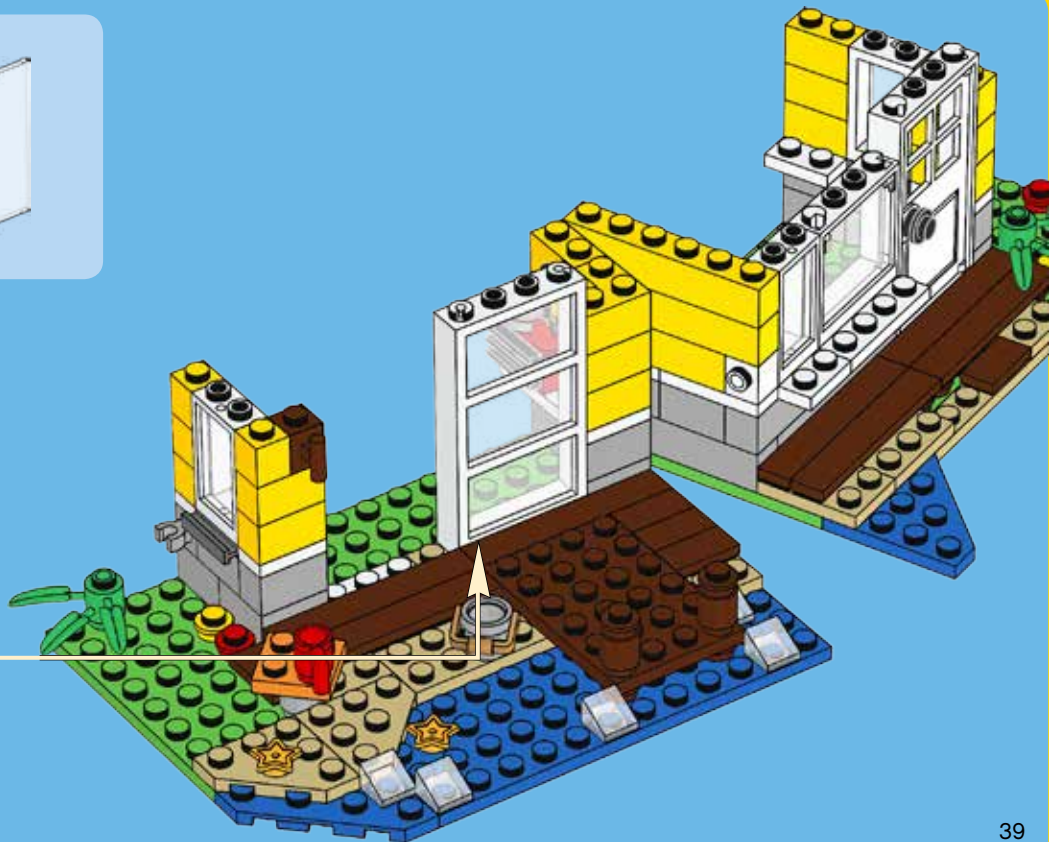
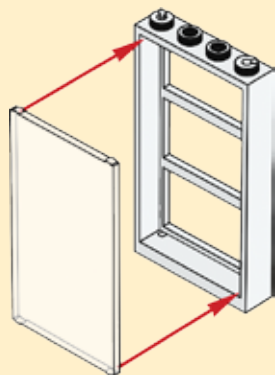

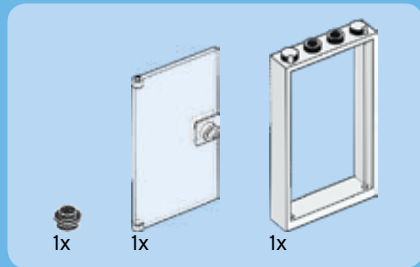

36

1

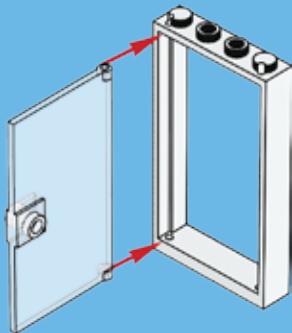

2

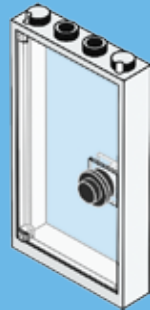





1x



1x



1x

37





3x



3x



1x

38





1x



2x



1x

39





2x



1x



1x



1x



1x

40





1x



2x



1x



1x



1x

41



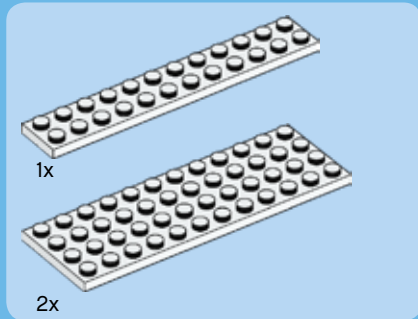

42



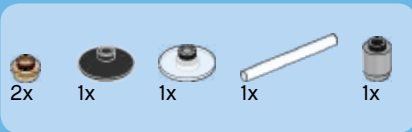

43

1



2



3



4

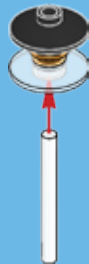

5



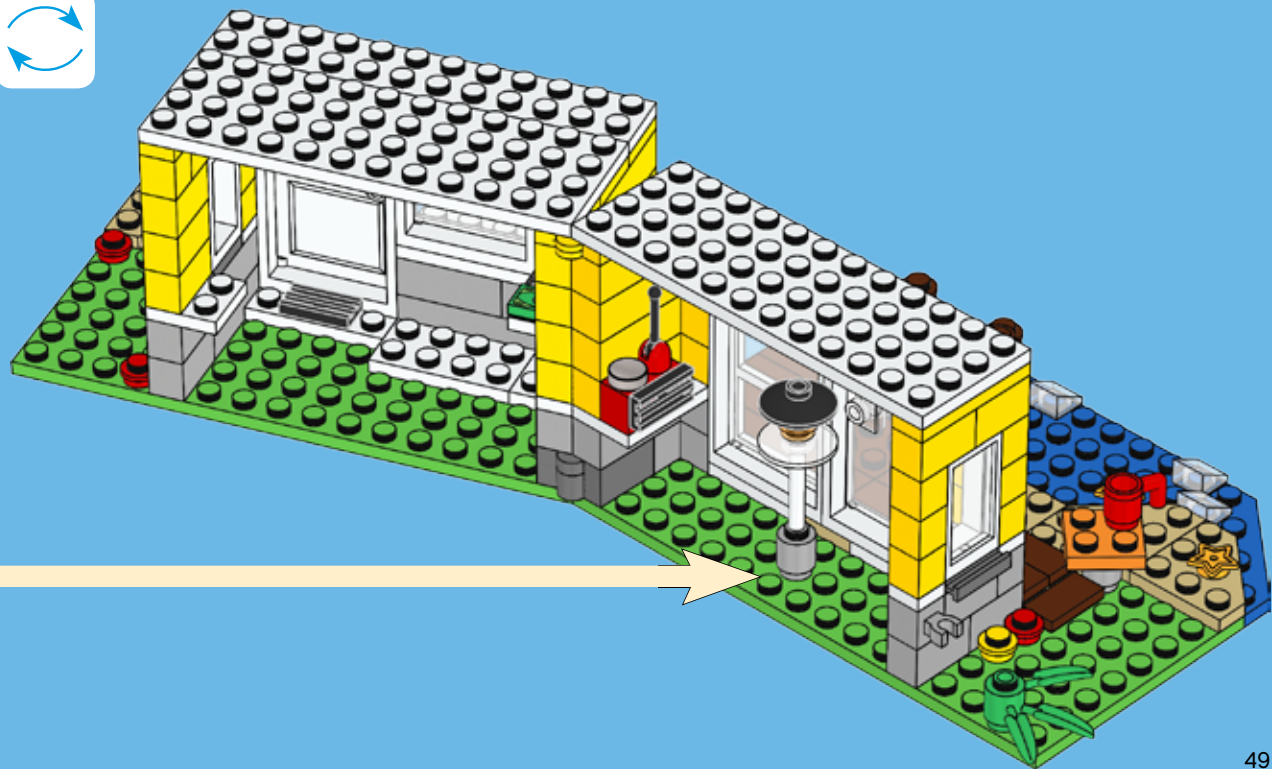



1x



1x



2x



44

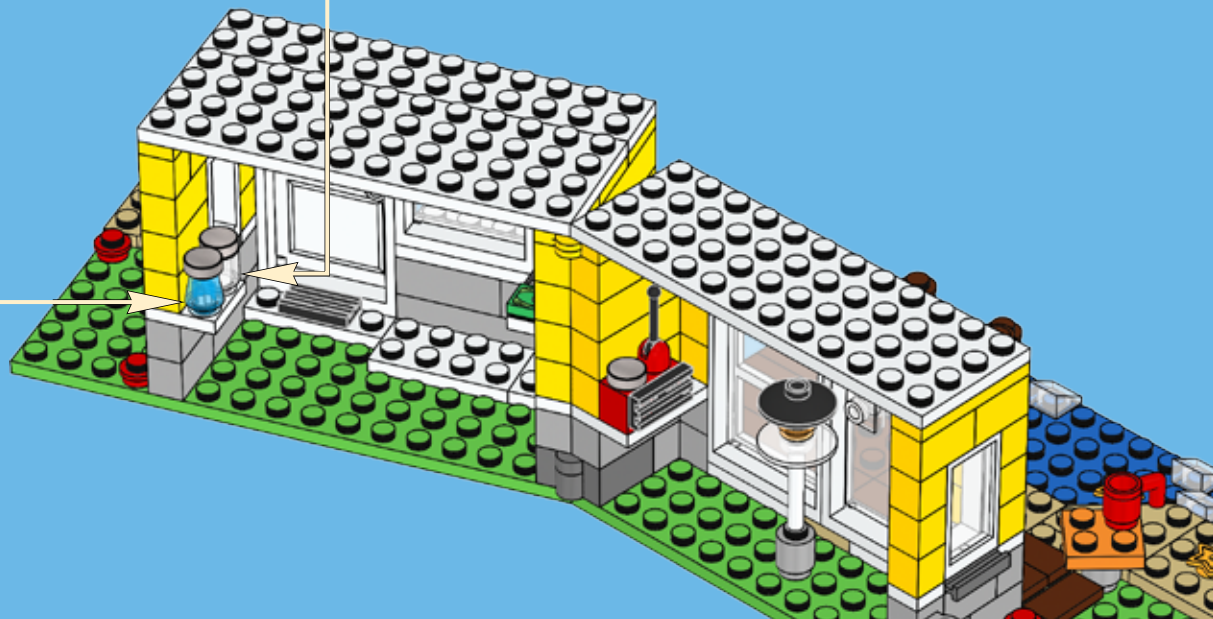

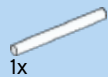

1x



1x



2x



1x

45

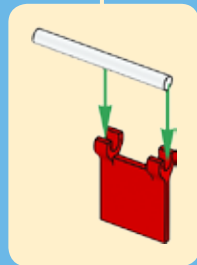



4x



4x

46





47





4x

48





1x



1x



2x



49





2x



4x



4x

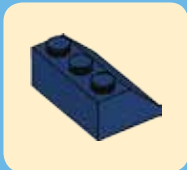

50





1x



4x

51





4x



2x



2x

52





53

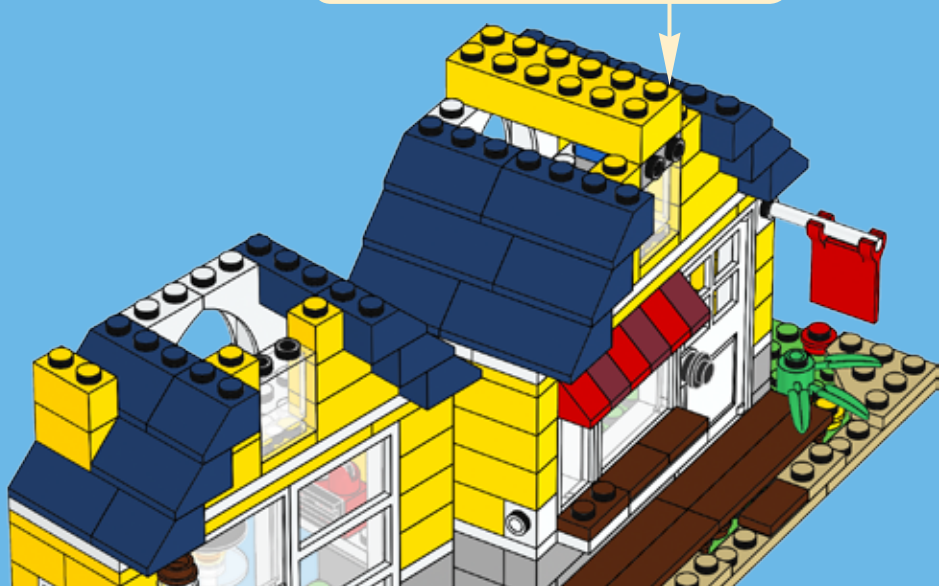
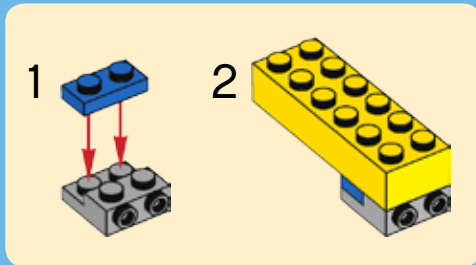



1x



1x



1x

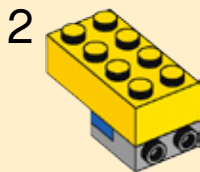
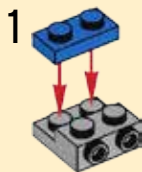

54





55





1x



4x

56





2x

57





4x

58





2x



2x

59





1x



1x



1x



1x



2x

60

1



2

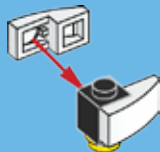

3

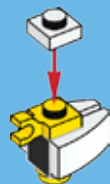





1x



1x



2x



1x



1x

61

1



2



3

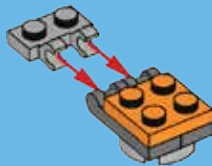

4



5

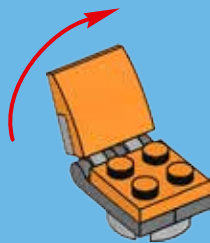





1x

62



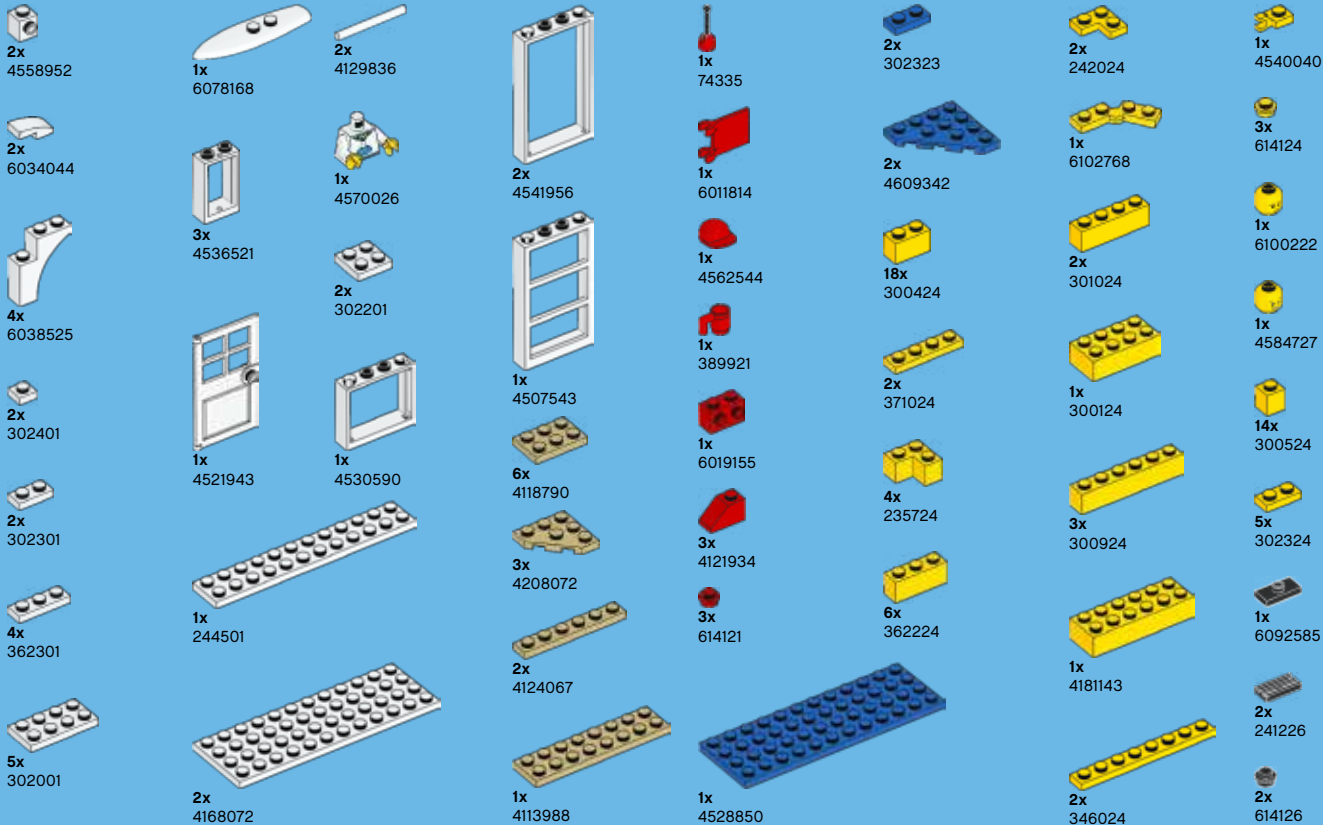



1x
4214559

2x
6000740

1x
4187750

1x
4654247

1x
4295260

7x
4211204

2x
4211183

2x
4543086

2x
4211349

1x
474026

3x
4536998

1x
4552033

2x
6017001

1x
4567331

7x
4211151

2x
4211150

1x
4210795

3x
4211428

1x
4596914

1x
4639698

1x
4521504

1x
6067913

1x
6102906

1x
4609635

9x
4153653

3x
4211412

3x
4211394

1x
9339

1x
4639698

1x
4521504

2x
4159007

2x
4114348

1x
4609635

20x
4568711

1x
4228198

3x
4211394

1x
6032681

5x
4244362

2x
3006840

1x
6093260

3x
4541526

1x
4271874

20x
4568711

2x
4654577

2x
4211393



Customer Service
Kundenservice
Service Consommateurs
Servicio Al Consumidor
LEGO.com/service or dial

00800 5346 5555 :

1-800-422-5346 :

2x
4610353

3x
4655241

1x
6011461

2x
4211475

1x
4211436



CREATOR



Available on the
App Store

ANDROID APP ON
Google play



CREATOR ISLANDS



Apple, the Apple logo, iPad, iPhone and iPod touch are trademarks of Apple Inc., registered in the U.S. and other countries. App Store is a service mark of Apple Inc./Apple, le logo Apple, iPad, iPhone et iPod touch sont des marques de commerce d'Apple Inc., déposées aux Etats-Unis et dans d'autres pays. App Store est une marque de service d'Apple Inc./Apple, el logotipo de Apple, iPad, iPhone e iPod touch son marcas comerciales de Apple Inc. registradas en EE. UU. y otros países. App Store es una marca de servicio de Apple Inc.

Google Play is a trademark of Google Inc./Google Play est une marque de commerce de Google Inc./Google Play es una marca comercial de Google Inc.

LEGO.com/creator





CREATOR



31026



31031



31036



3 IN 1

LEGO.com/creator



CREATOR

31034

3 IN 1



LEGO.com/creator



CREATOR

LEGO and the LEGO logo are trademarks of the/sont des marques de commerce du/son marcas registradas de LEGO Group.
©2015 The LEGO Group.
6170206 / 6170207



31034



31032



31031



31033



3 IN 1

LEGO.com/creator



CREATOR

31035



LEGO.com/creator





1x

1

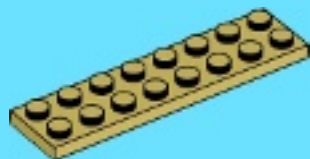

1x

1x

1x

2

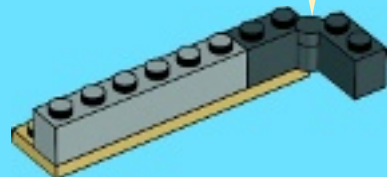
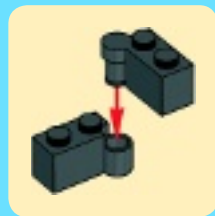

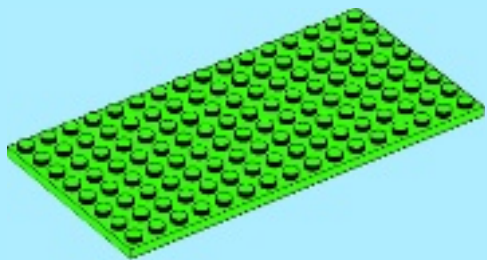

1x

3

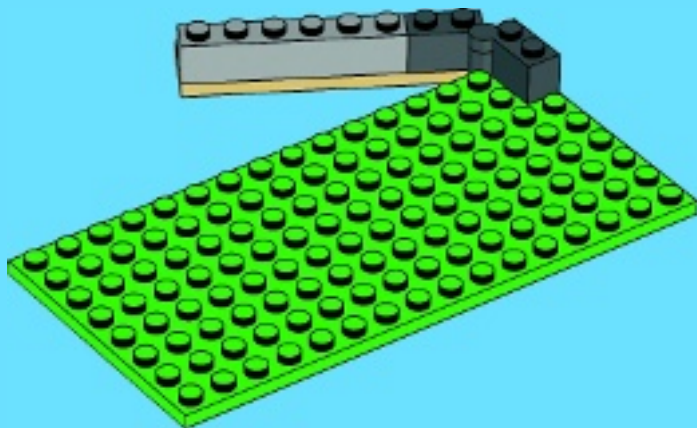



1x



1x



1x



1x

4

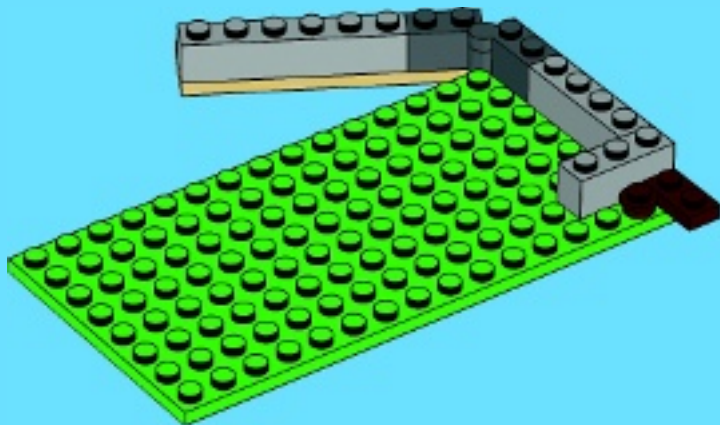



2x

5

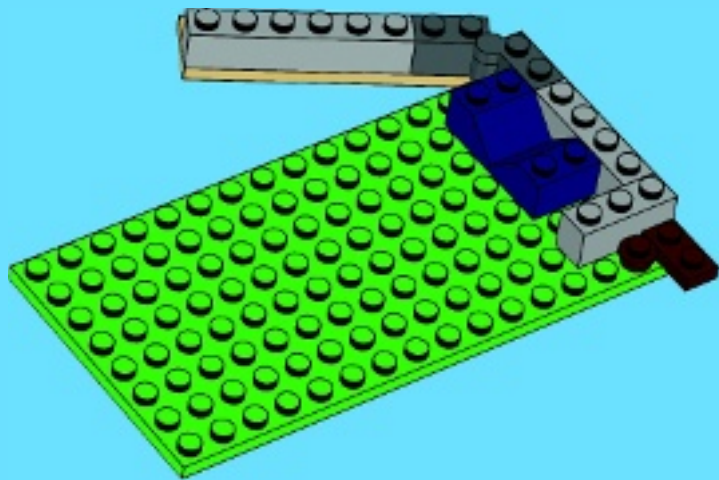

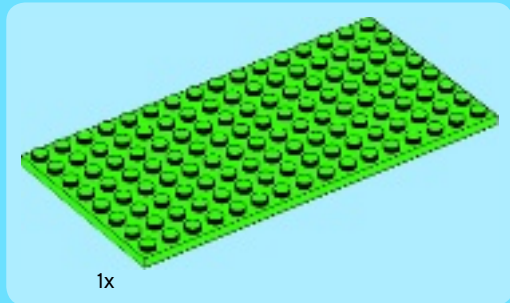

1x

6

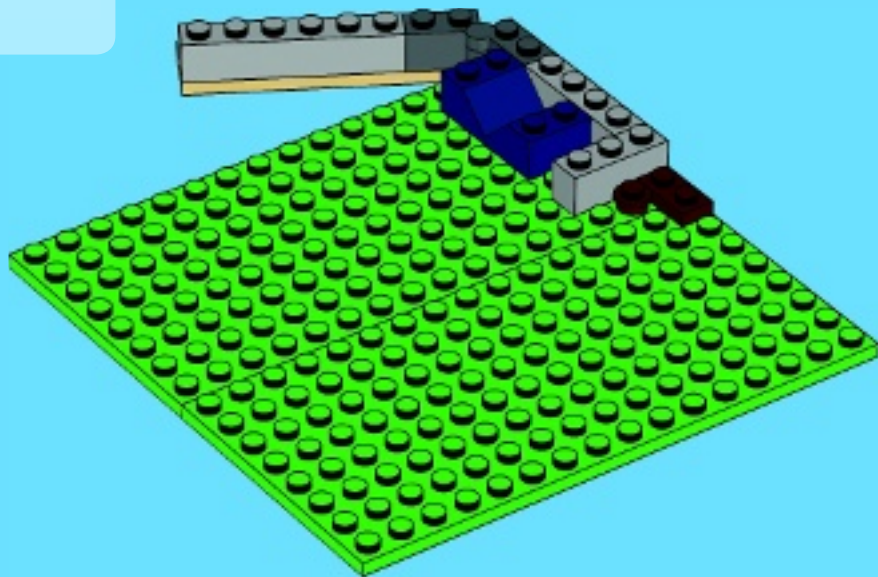



1x



1x



2x

7

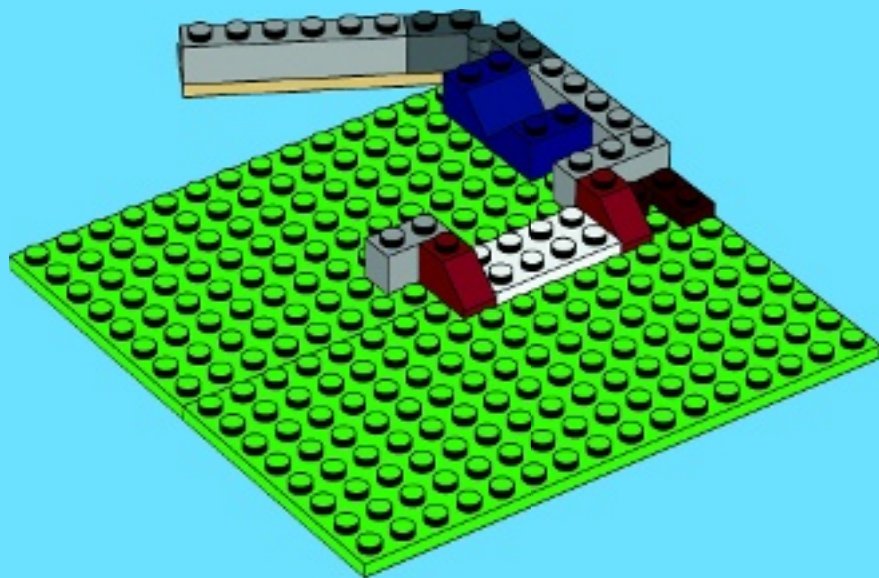



1x



2x



1x

8

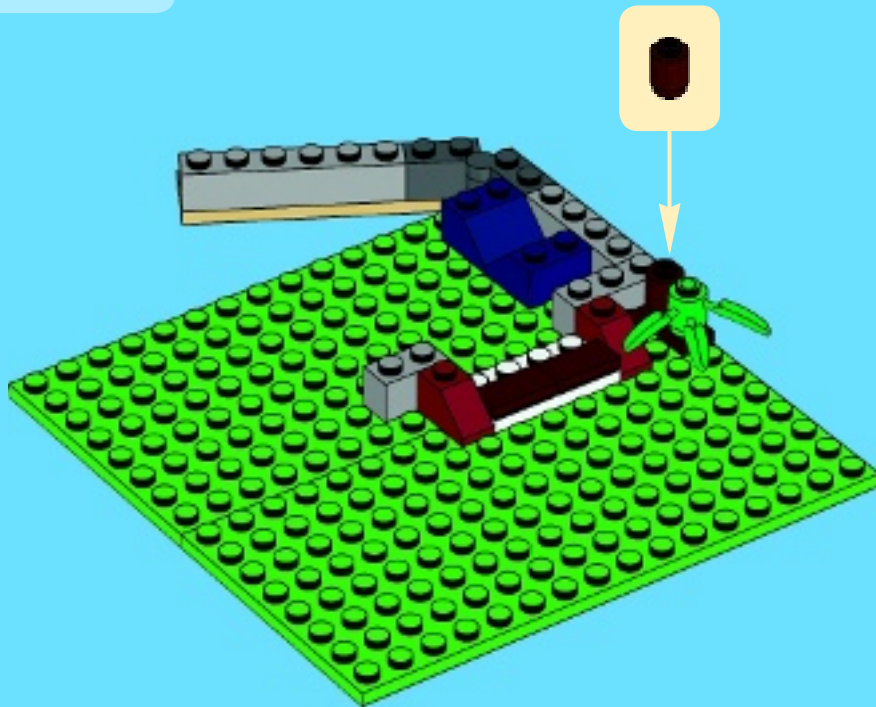



1x



1x



2x



1x

9

1



2



3

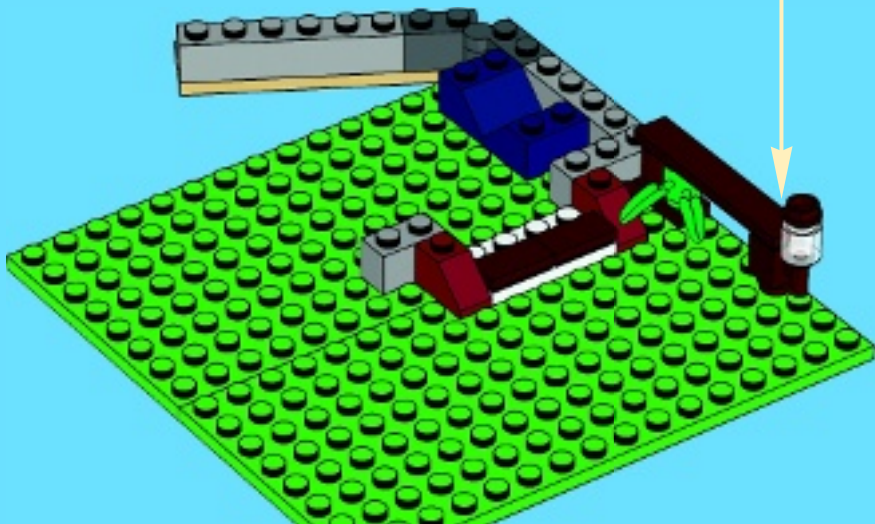



1x



1x



1x

10

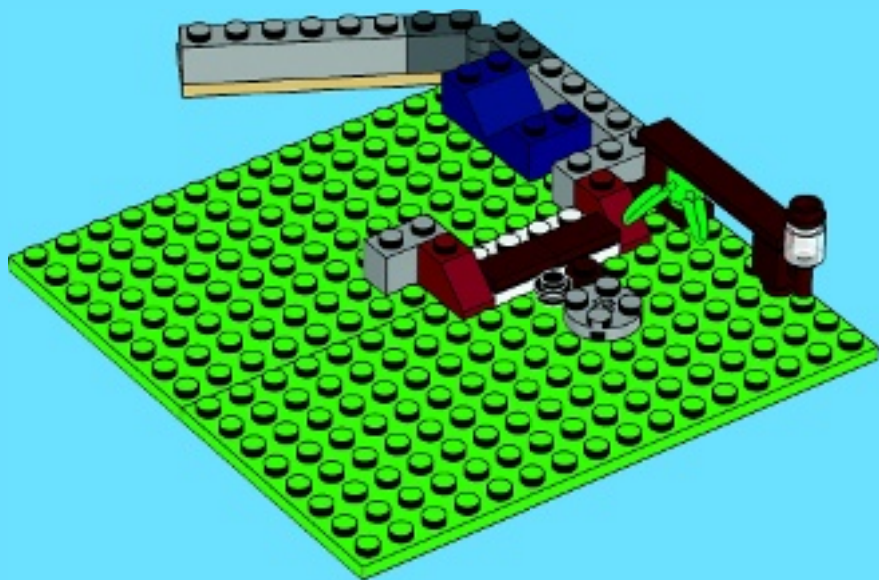



1x



1x



1x

13

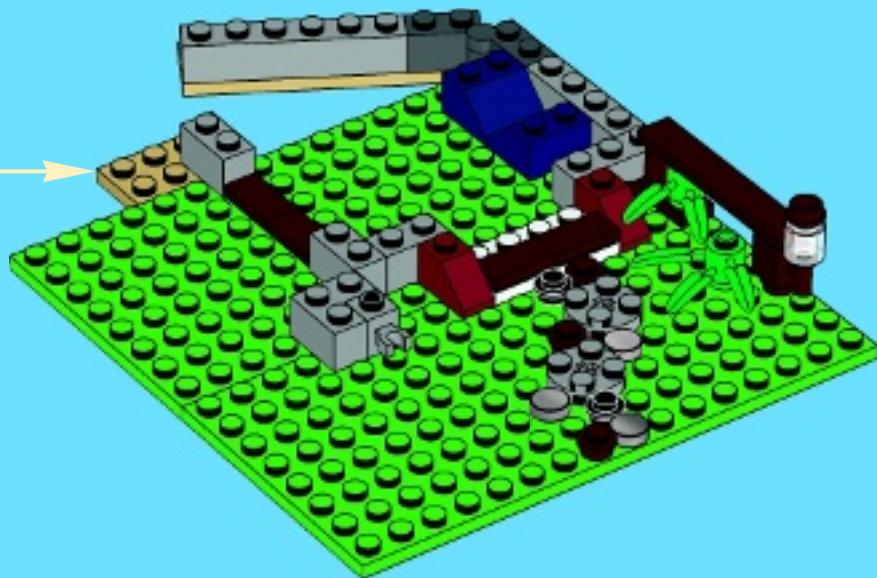



1x



1x



1x

14

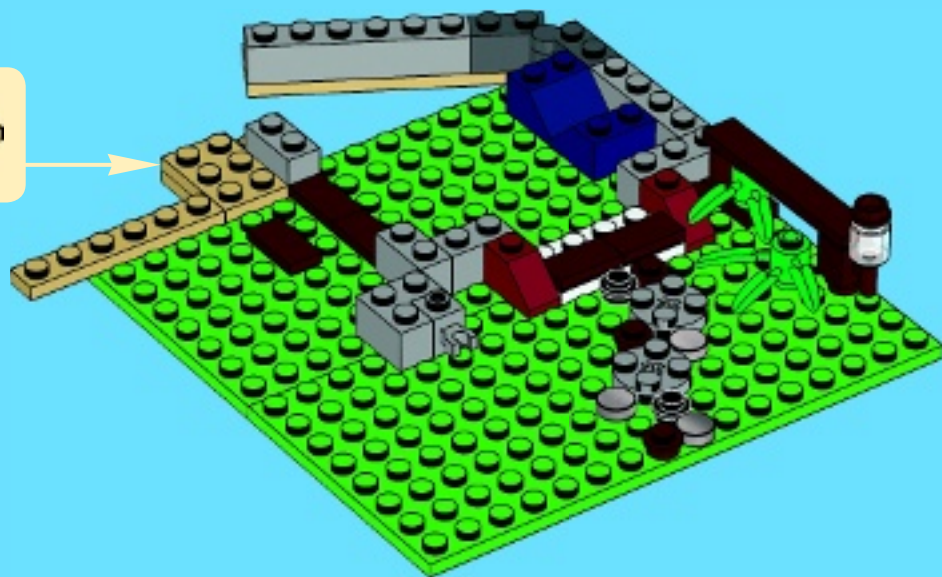



1x



1x

16

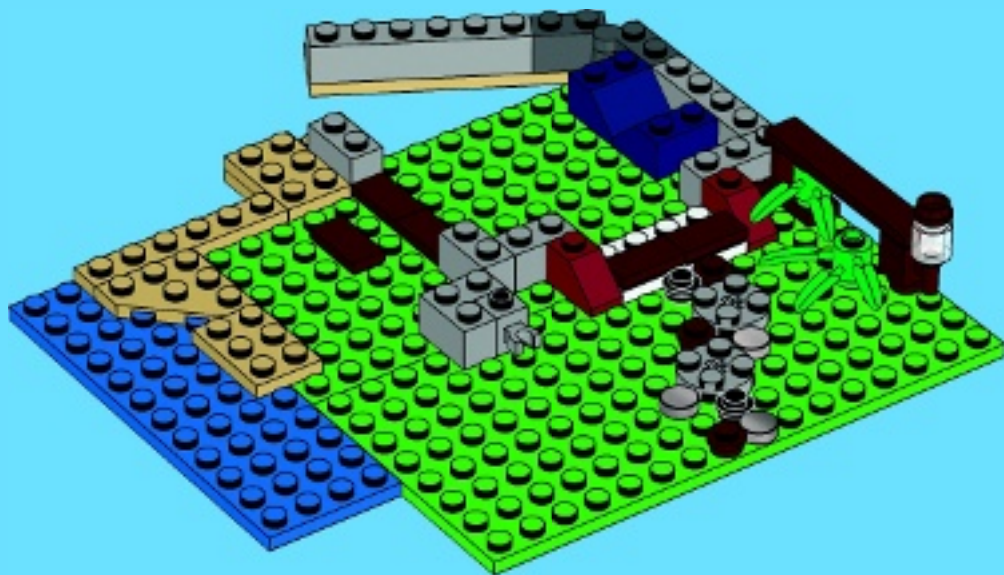



1x



2x



1x

17

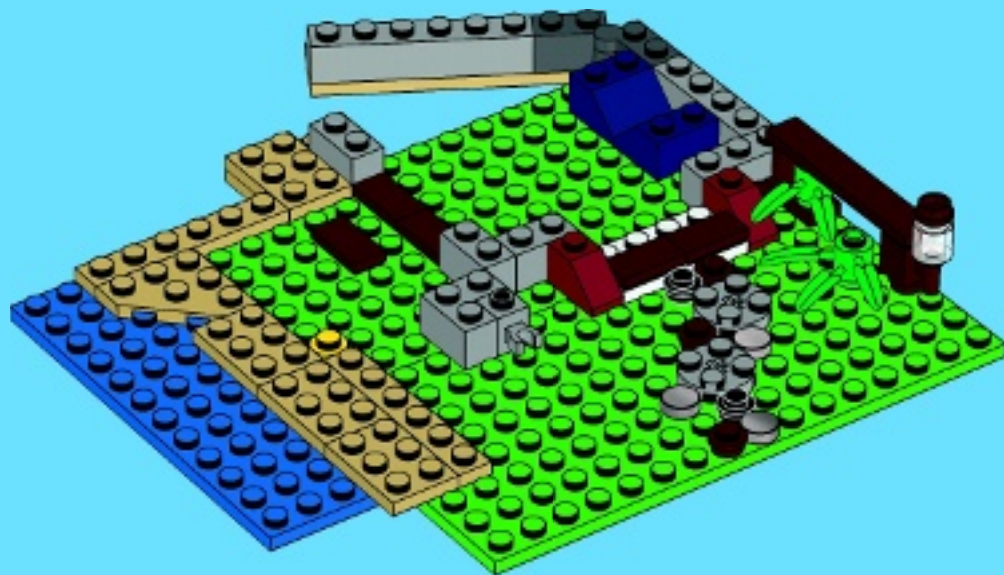



1x

18

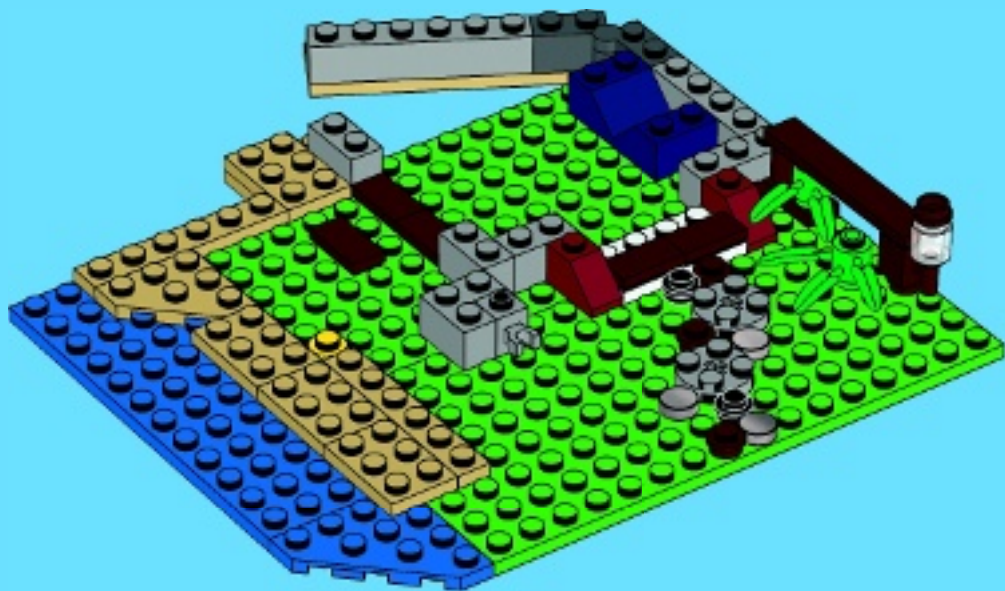



4x



2x



1x

19

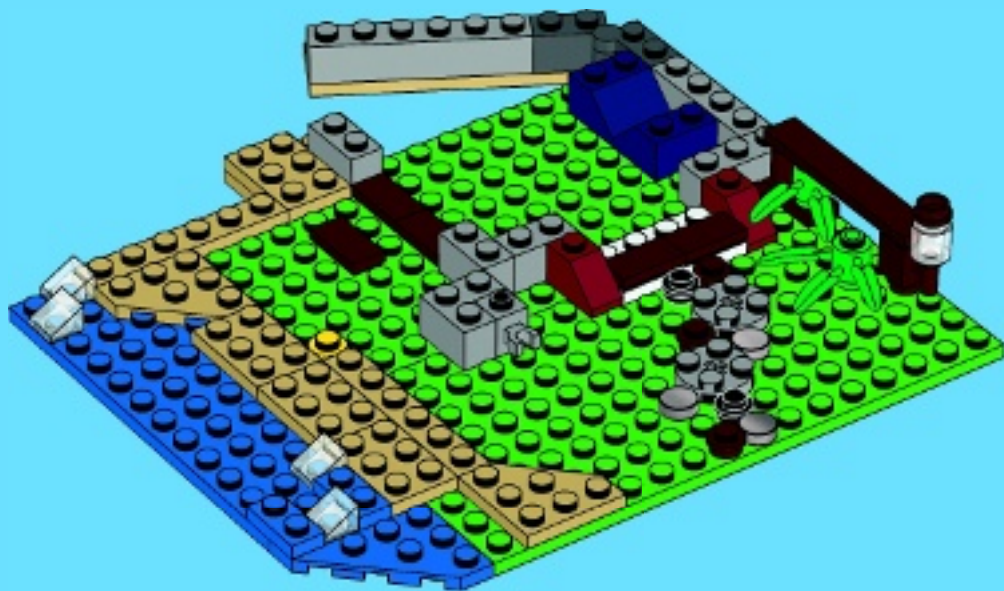

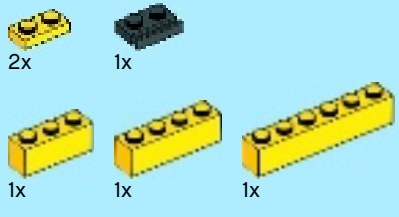

21

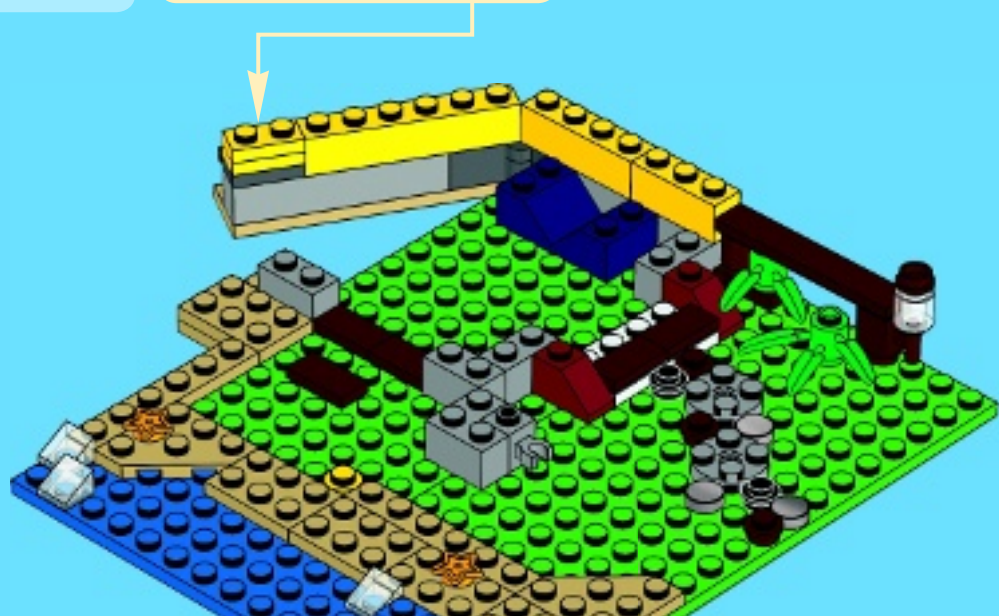



1x



2x



1x

22

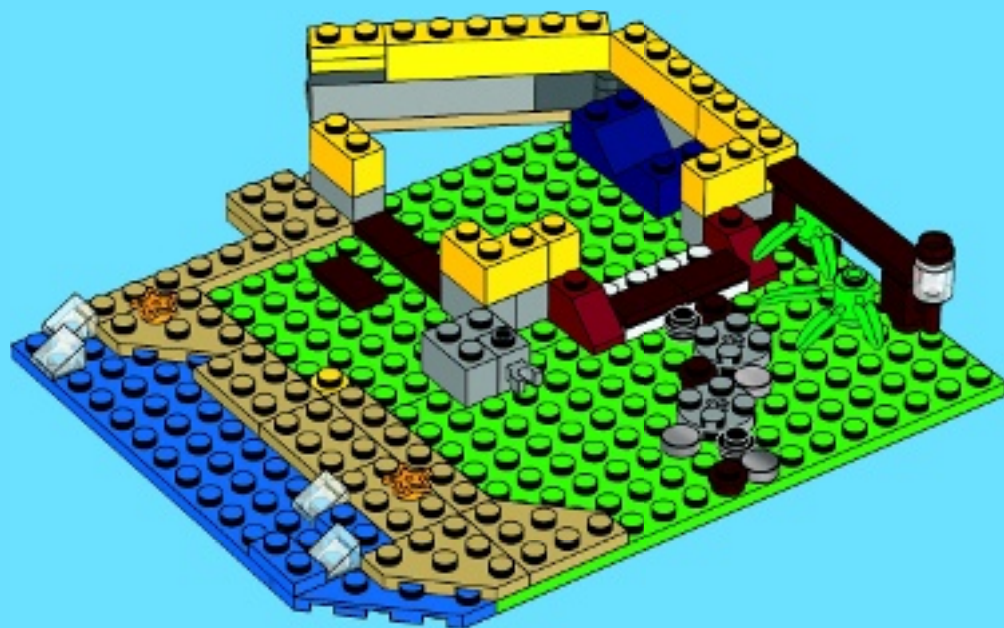



1x



1x



2x

23

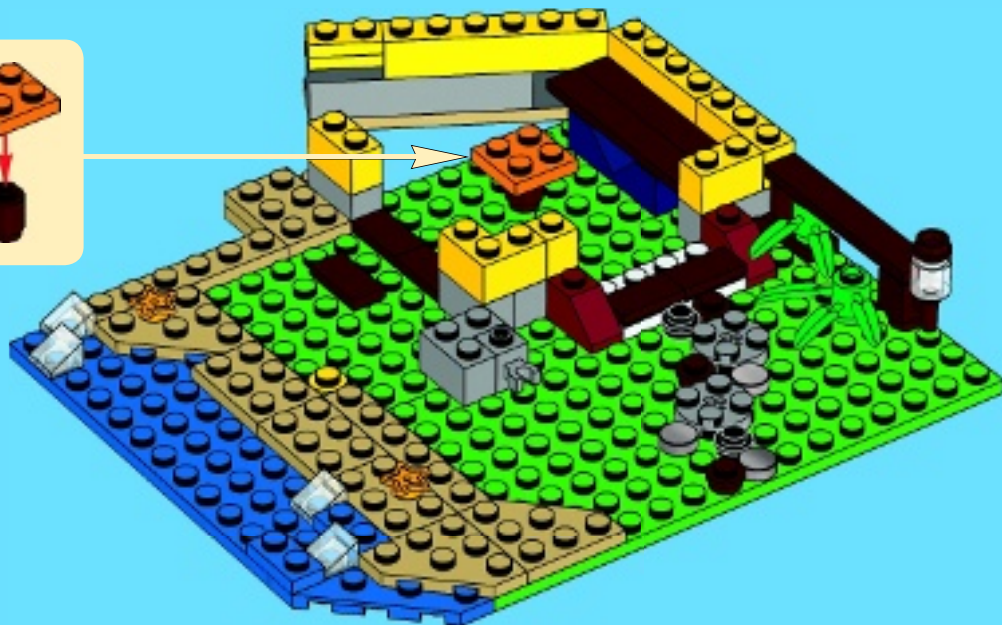



24

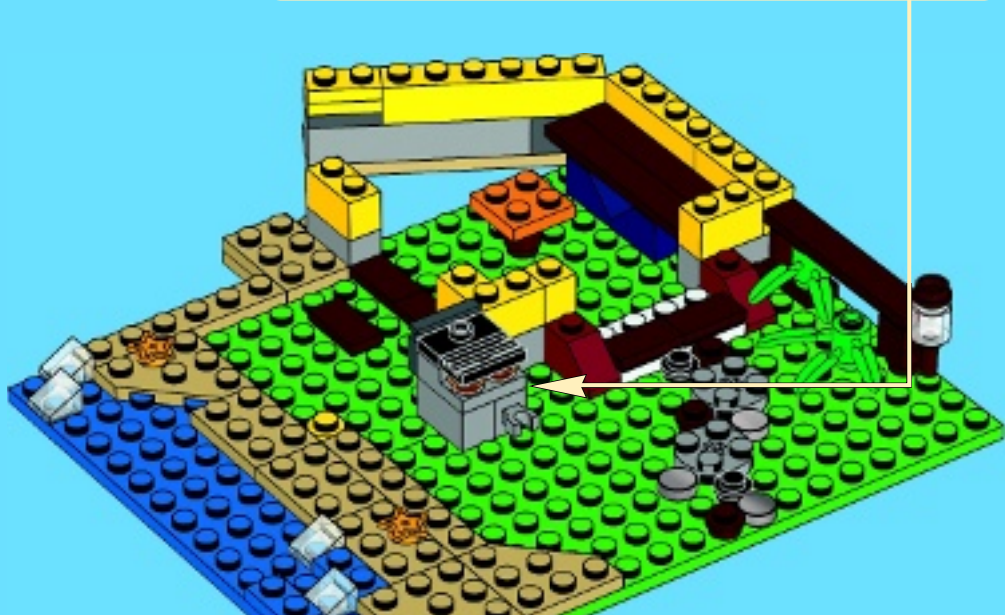
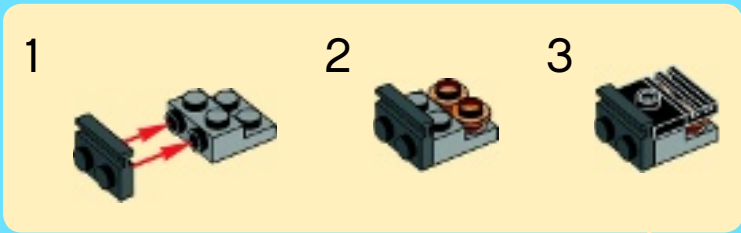



1x



2x



3x



1x

25

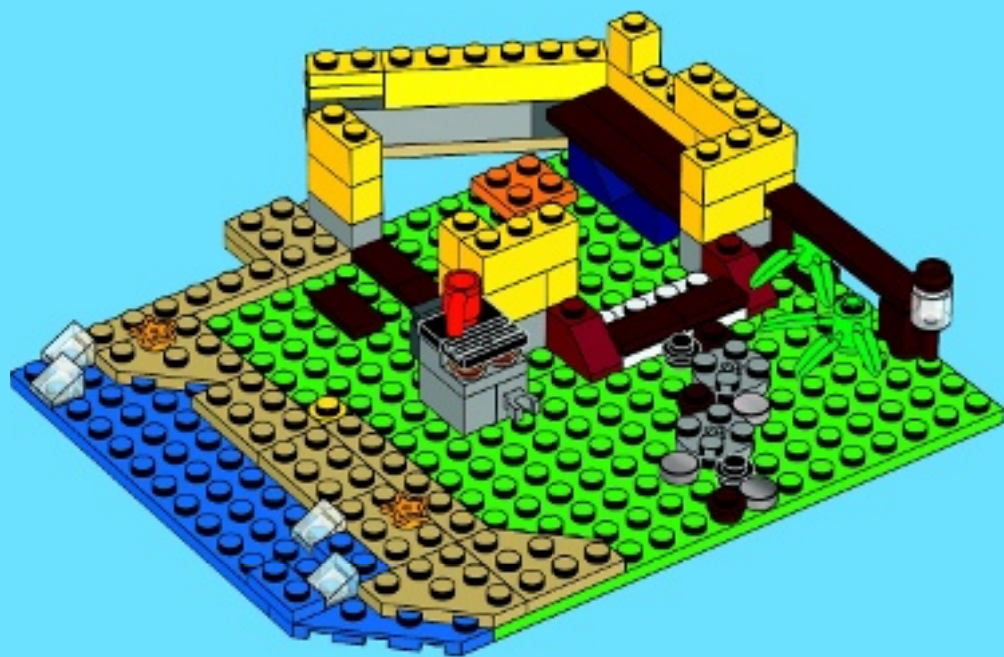



2x



1x



2x



1x

26

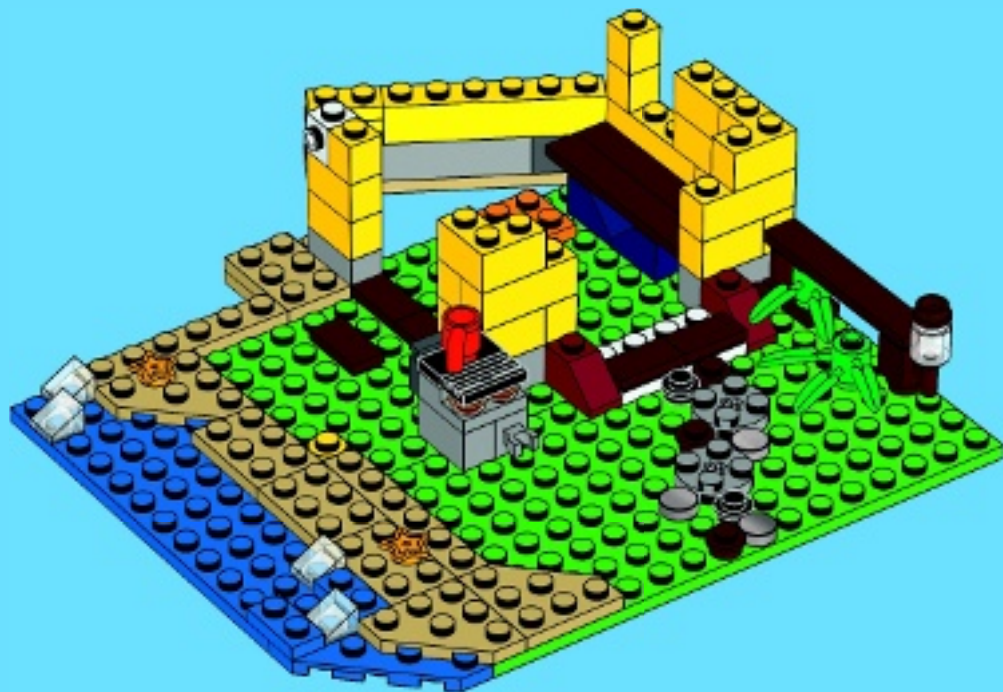



1x



2x



1x



1x

27

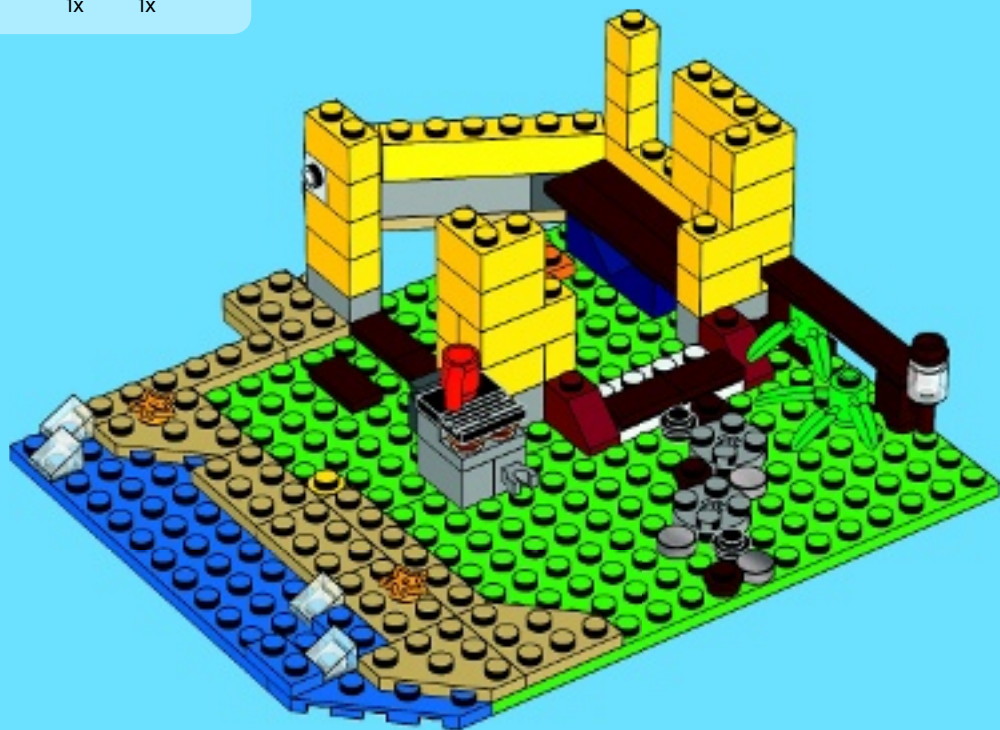



3x



3x

28

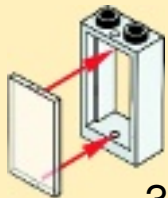

3x

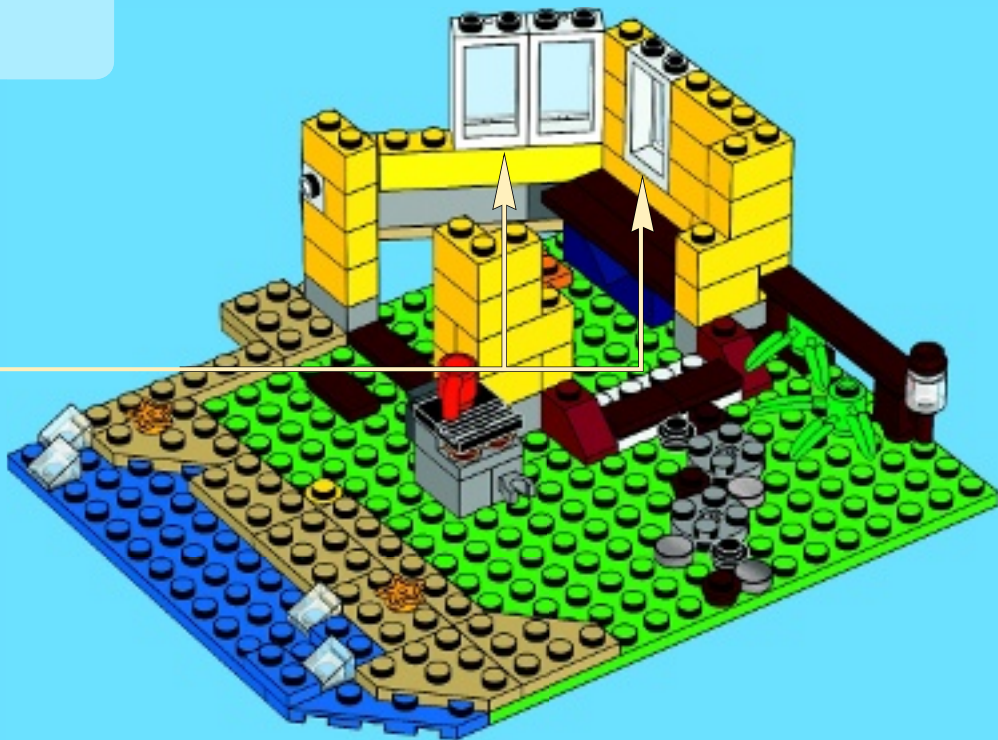

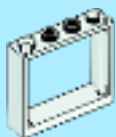

1x



1x

29

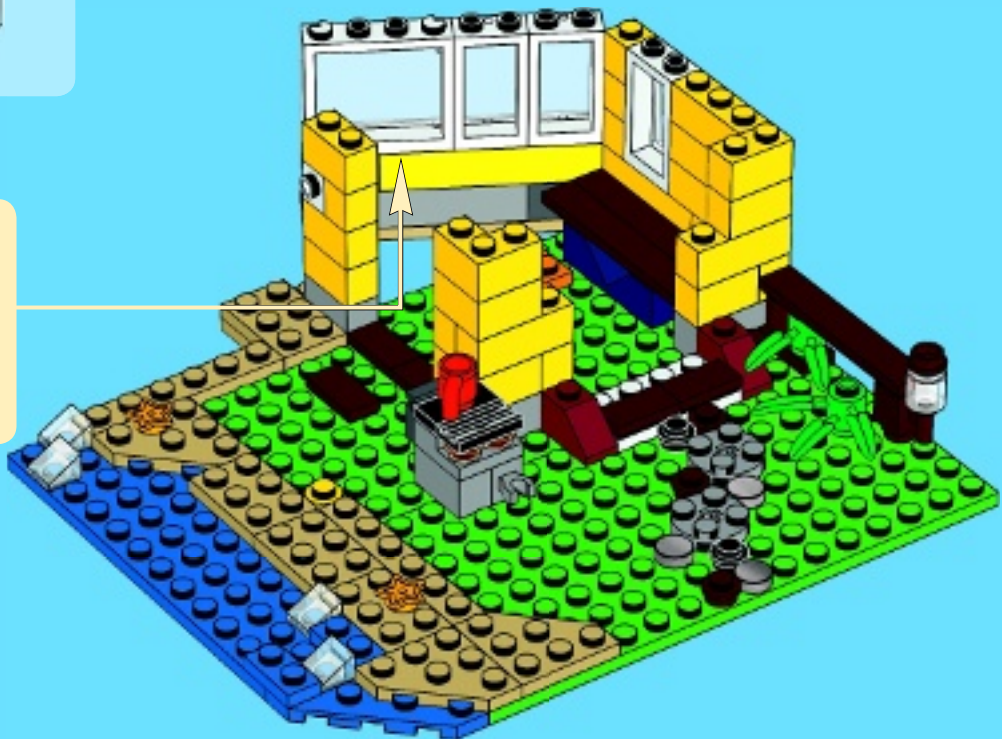
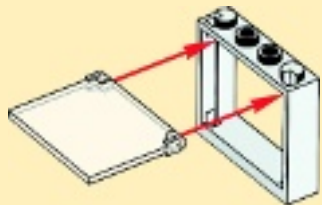



1x



1x



1x



1x



1x

30

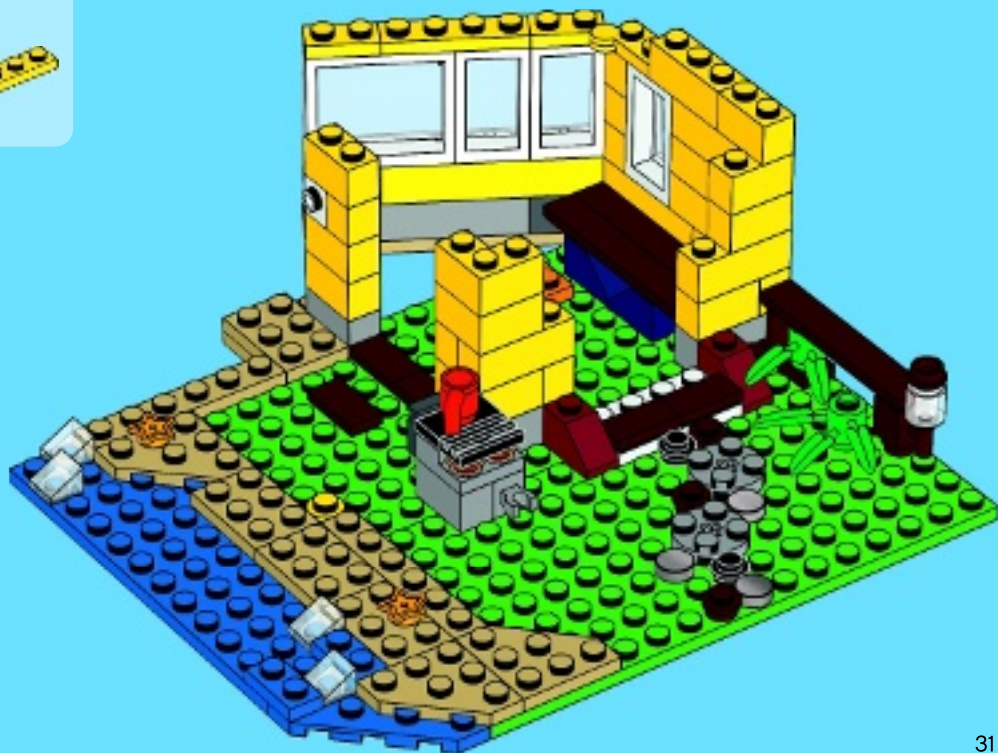

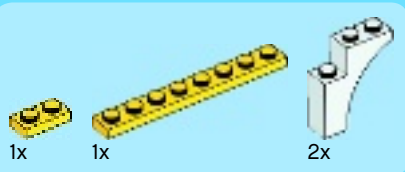

31

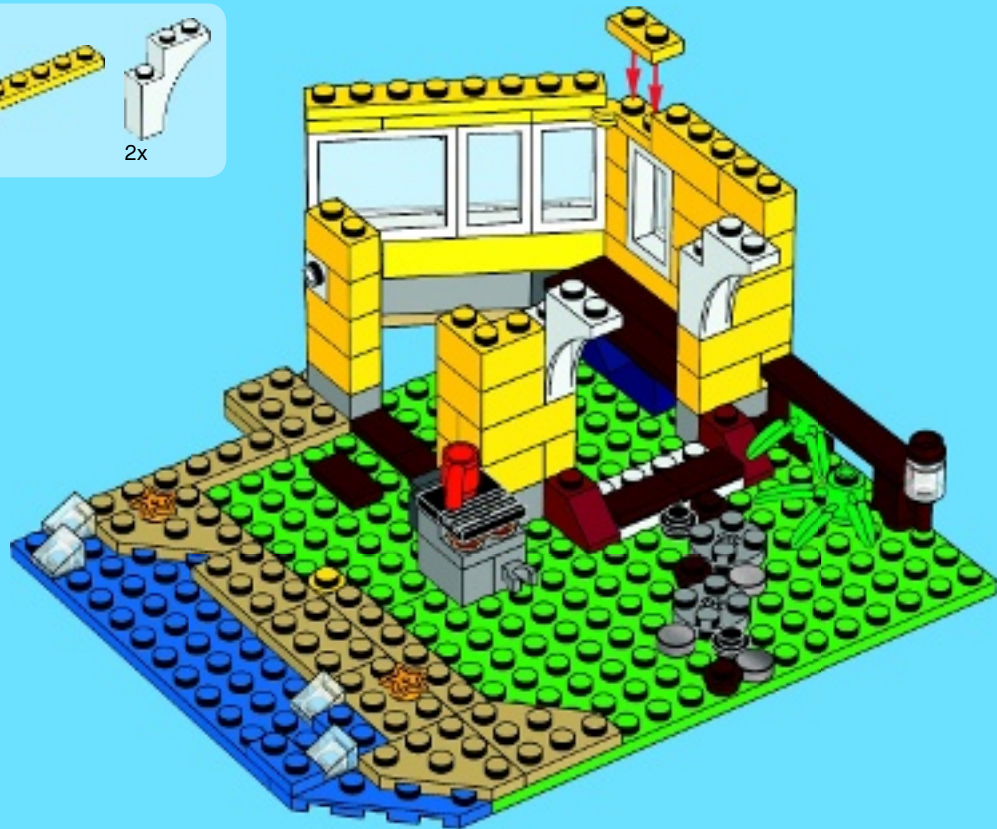

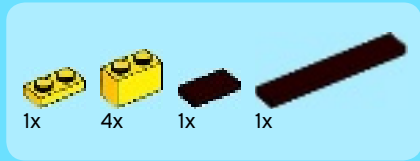

32

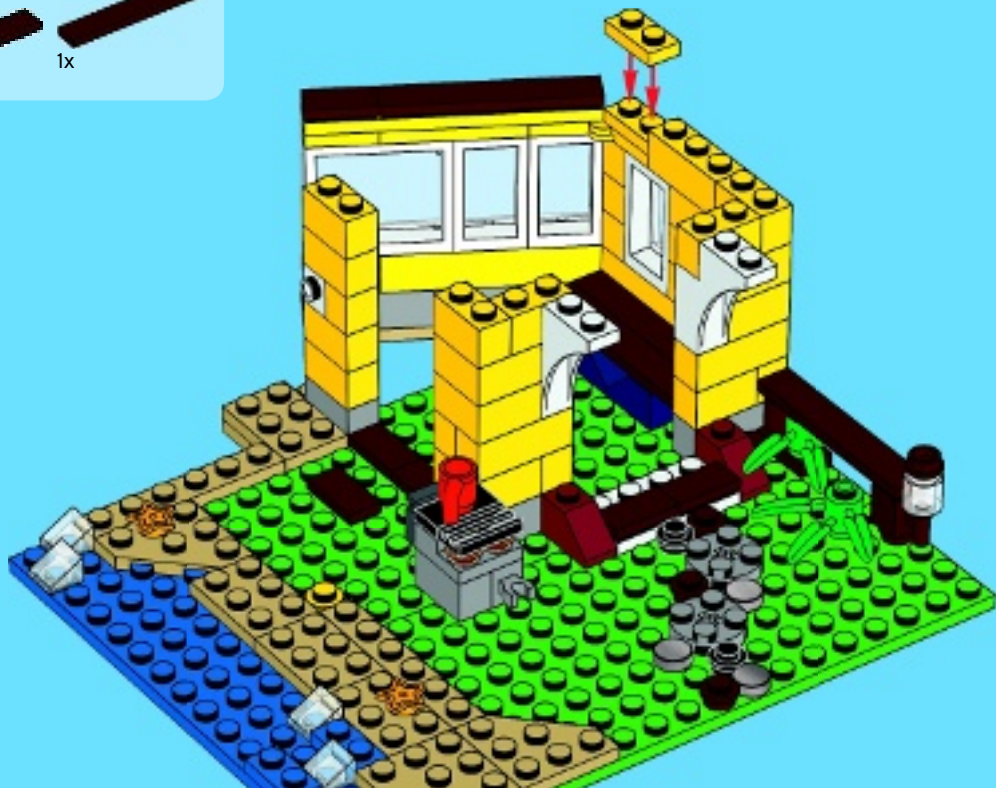

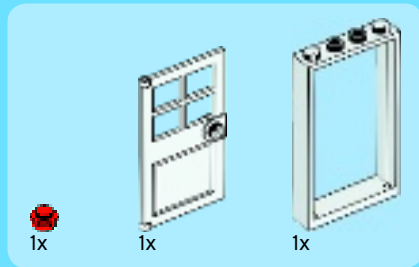

33

1

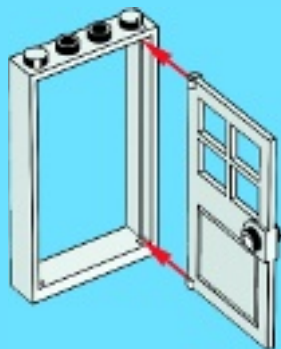

2



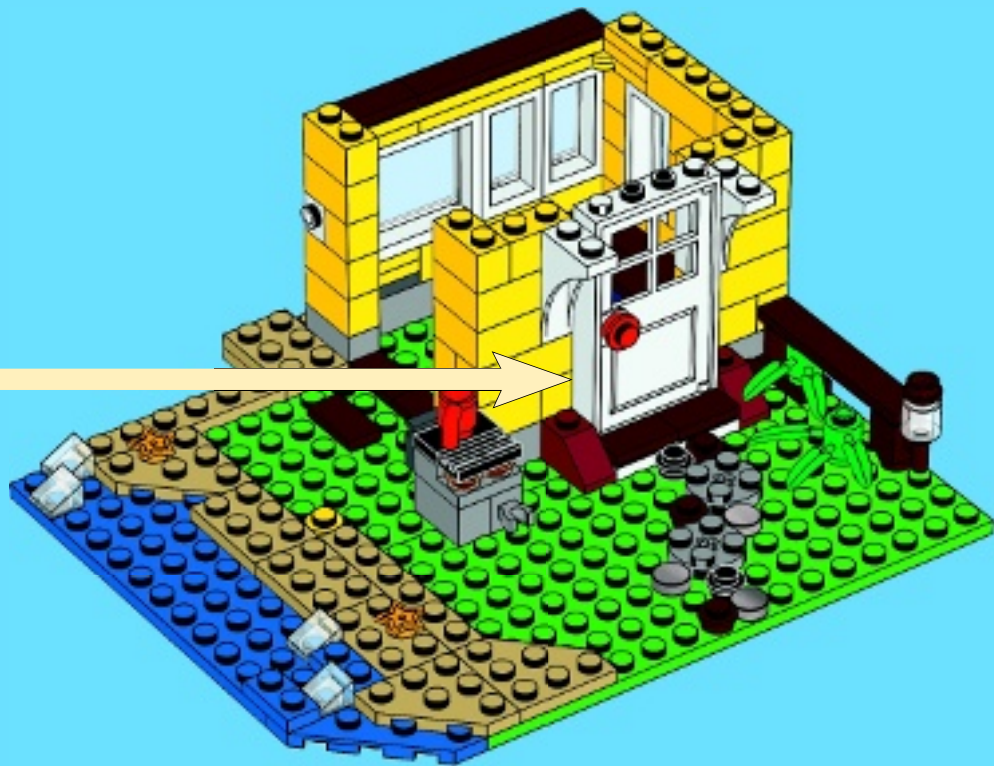

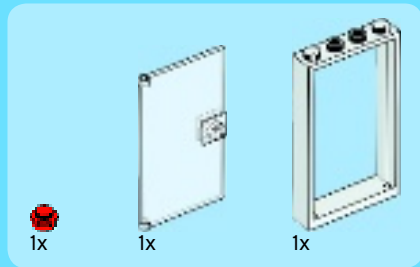

34

1

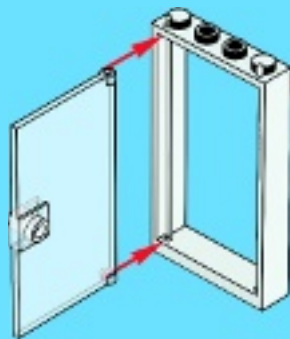

2

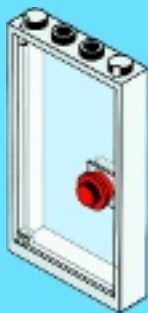

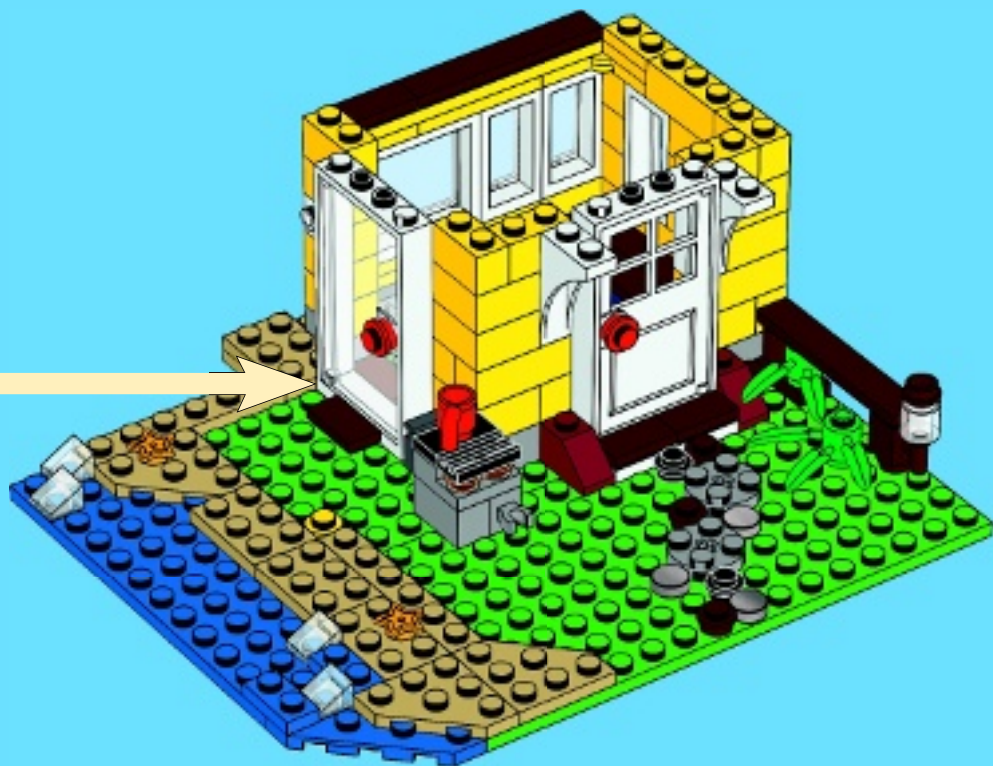

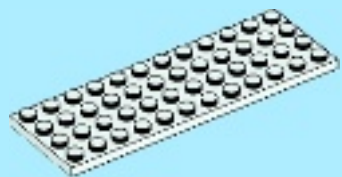

2x

35





1x



3x



2x



1x



1x

36

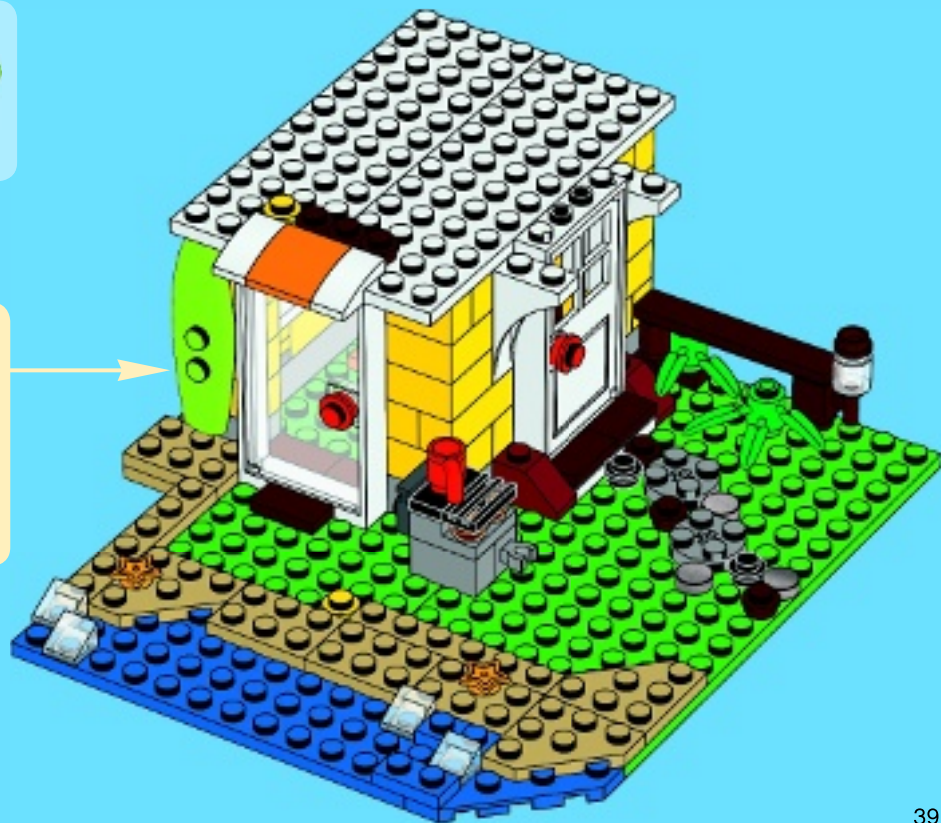
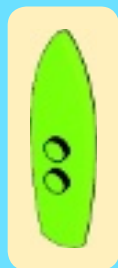



1x



1x



1x



2x



1x

37



1



2



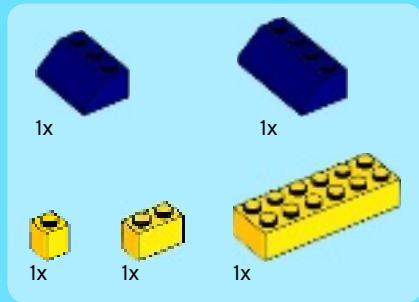

38





1x



2x



1x

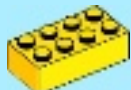

1x

39

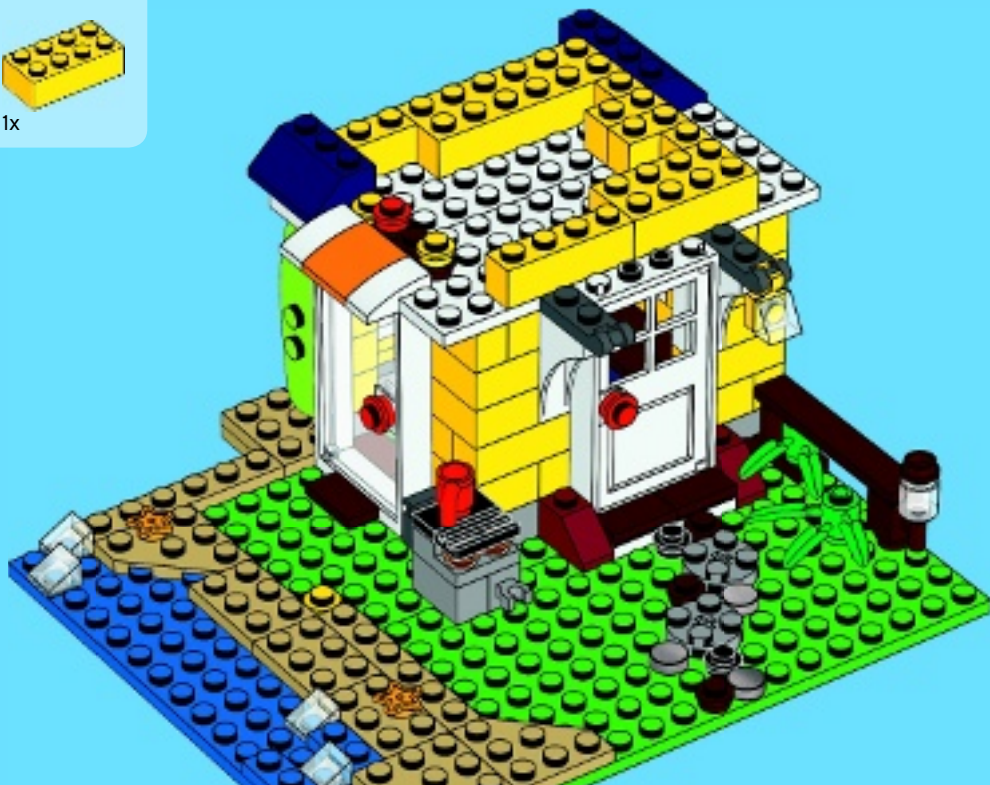



5x

40





2x



2x



2x

41





1x



1x



2x



1x

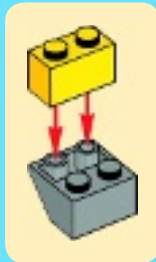

42





1x



2x



2x



1x



2x

43

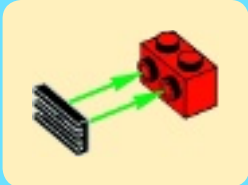



2x

44

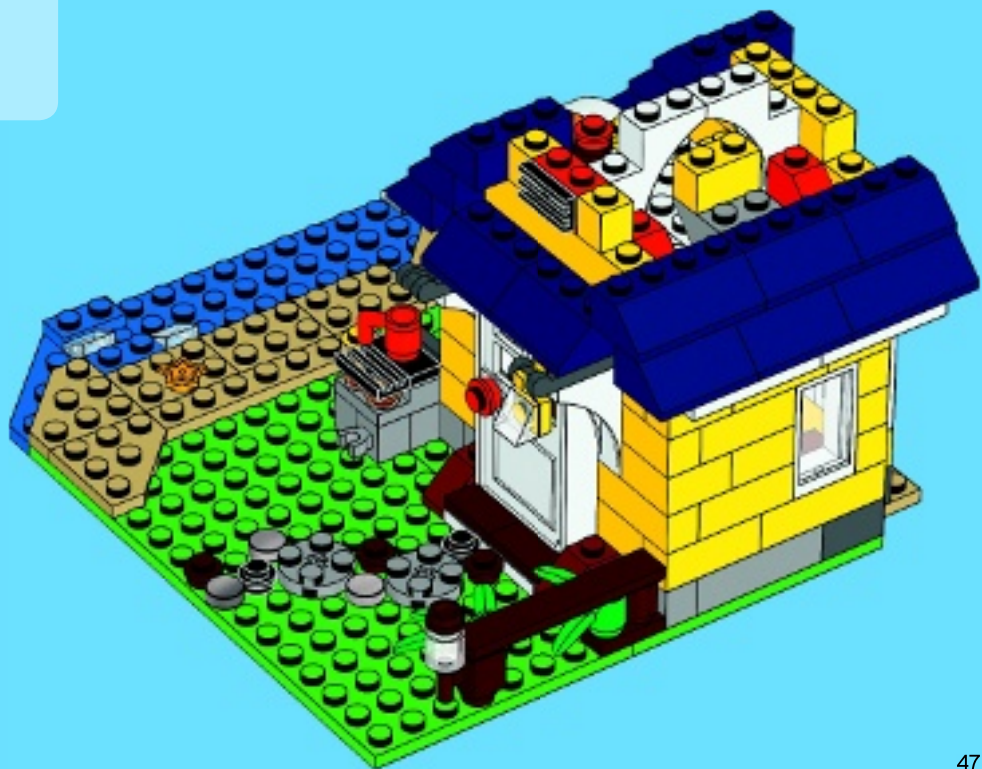



2x



1x

45





46





2x



1x

47

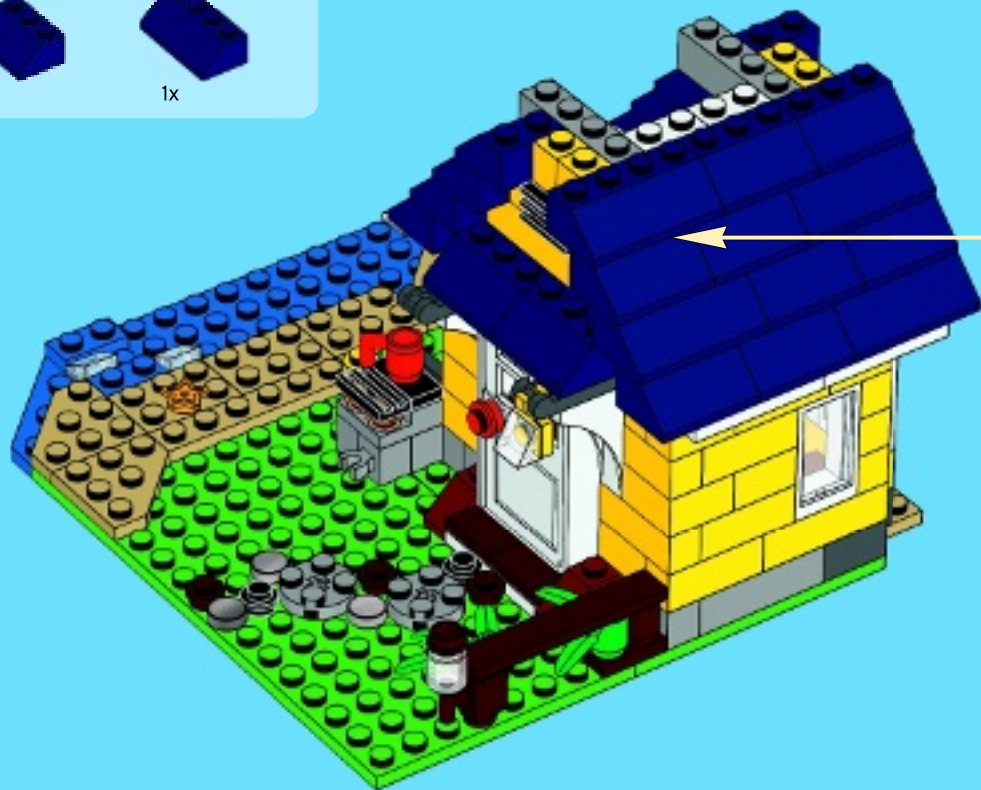



2x



1x

48

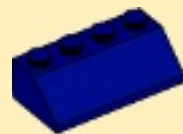



2x



2x

49



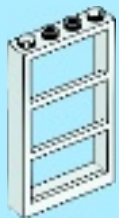

1x



1x

50

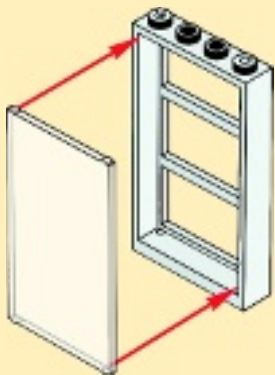



2x



2x



1x

51





1x



1x

52





1x



1x



1x

53



LEGO CREATOR



31034



31032



31031



31033



3 IN 1

LEGO.com/creator



CREATOR

31033

3 IN 1



LEGO.com/creator



CITY



60069



60068



60067



60066



60065

LEGO.COM/CITY

WIN

GO TO WWW.LEGO.COM/PRODUCTFEEDBACK AND
GIVE US YOUR SHORT **FEEDBACK** ABOUT THIS
LEGO® SET FOR A CHANCE TO WIN
A COOL LEGO PRIZE.



LEGO.com/productfeedback

GEWINNE



Erzähle uns auf
www.LEGO.com/productfeedback

etwas über die Erfahrungen, die du mit
diesem LEGO® Set gemacht hast, und
sichere dir die Chance auf einen coolen
LEGO Preis!

GAGNE



Rends-toi sur
www.LEGO.com/productfeedback

et donne-nous quelques commentaires
sur ce produit LEGO® pour avoir une
chance de gagner un prix LEGO !

GANAN



Visita
www.LEGO.com/productfeedback

y envíanos tu opinión acerca de este set
LEGO®. ¡Participarás en el sorteo de un
premio LEGO!

获取奖品



登录
www.LEGO.com/productfeedback

给出关于此乐高®套装的简短反馈，
就有机会获得炫酷乐高奖品

LEGO and the LEGO logo are trademarks of the/son des marques de commerce du/son marcas registradas de LEGO Group. ©2015 The LEGO Group.

6120321 / 6120322



CREATOR

31035



LEGO.com/creator



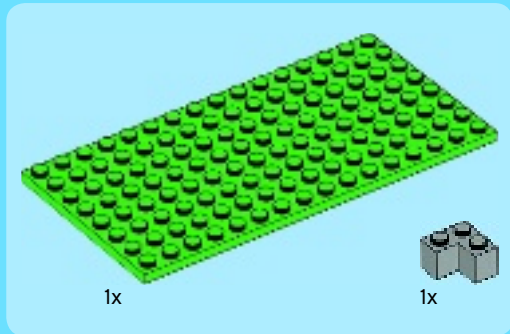

1

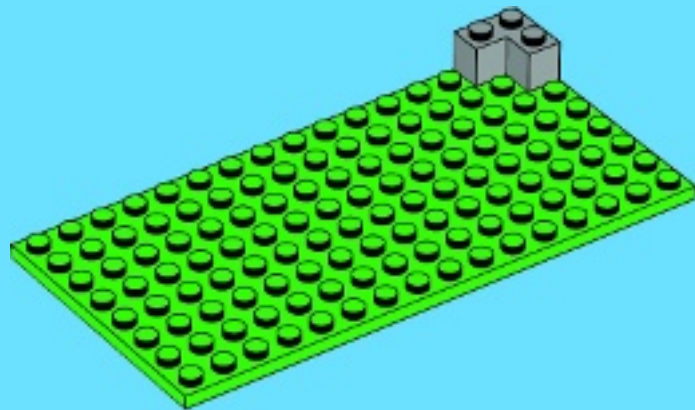



1x



2x

2

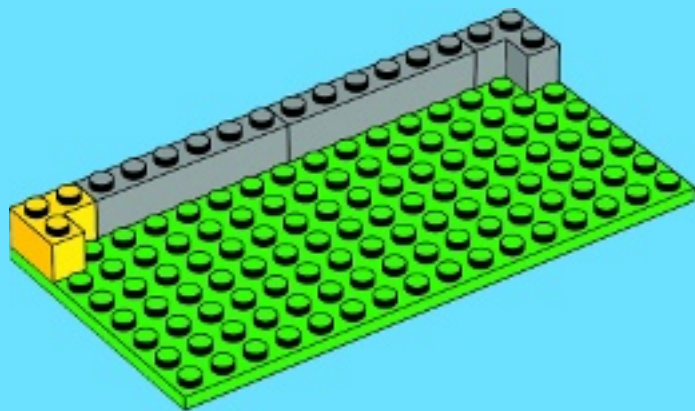

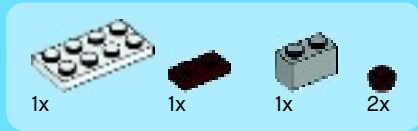

3

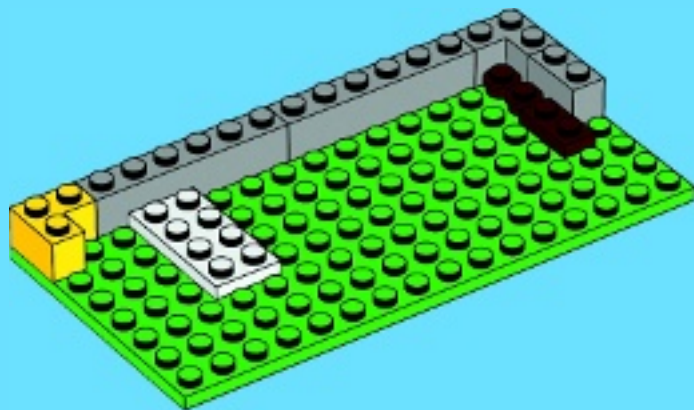



2x



2x



1x



2x

4

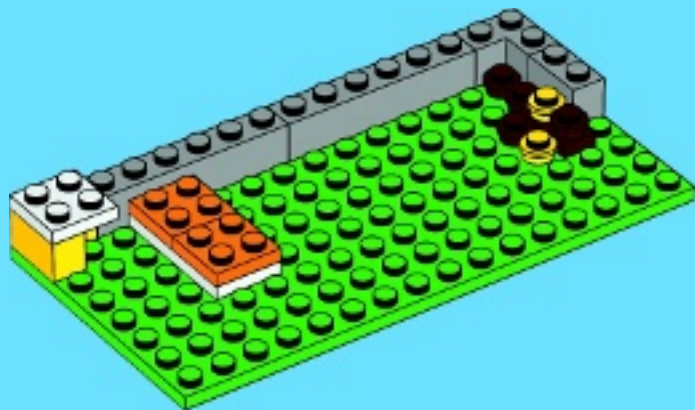



1x



1x



1x

5

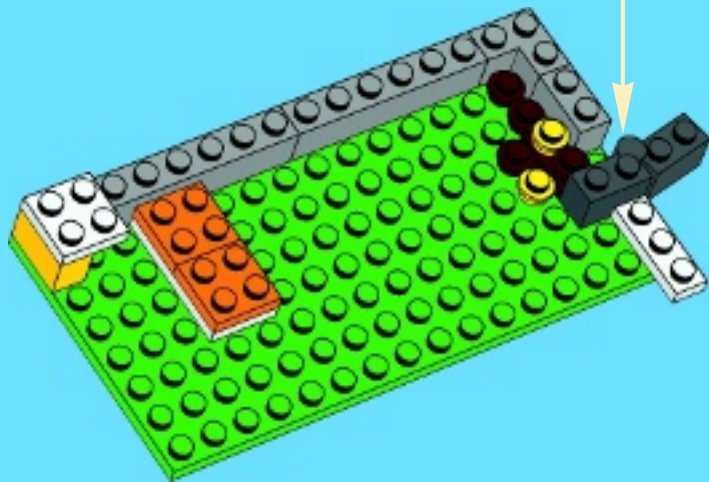
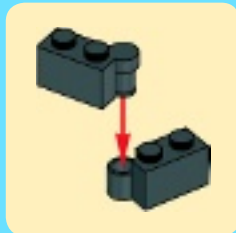

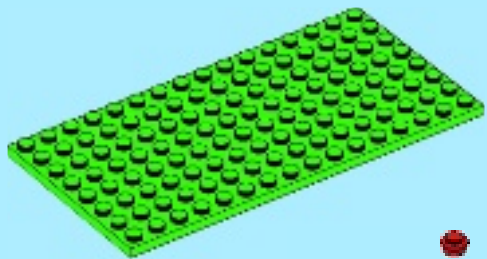

1x



1x

6

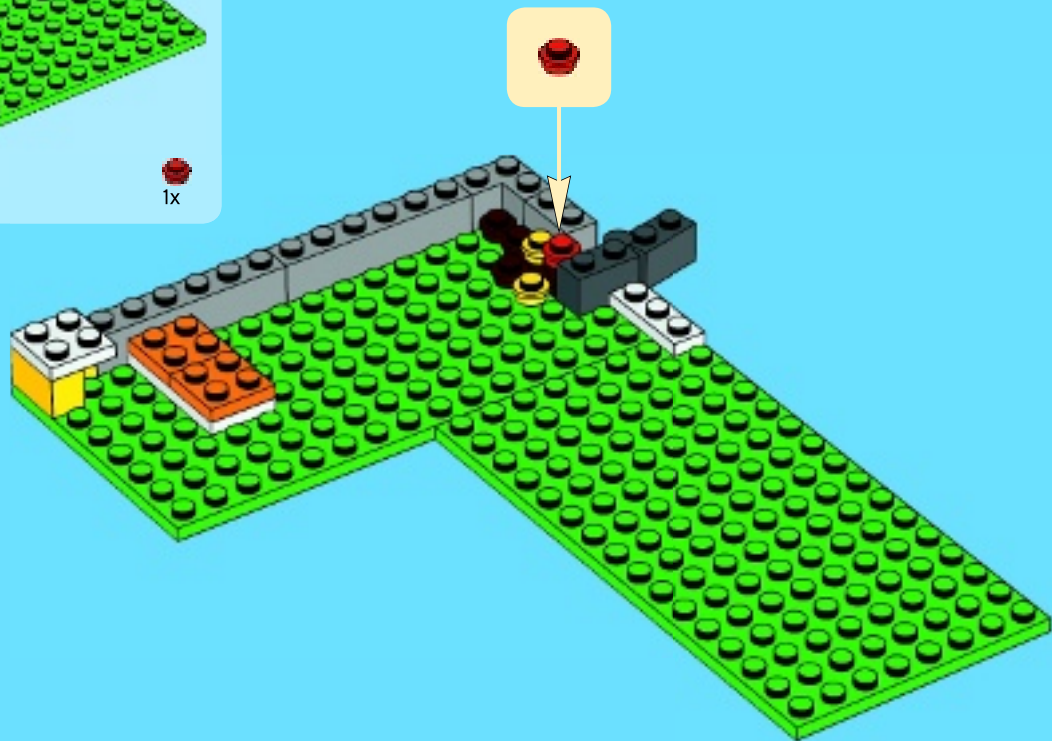

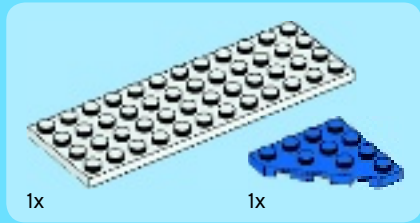

7

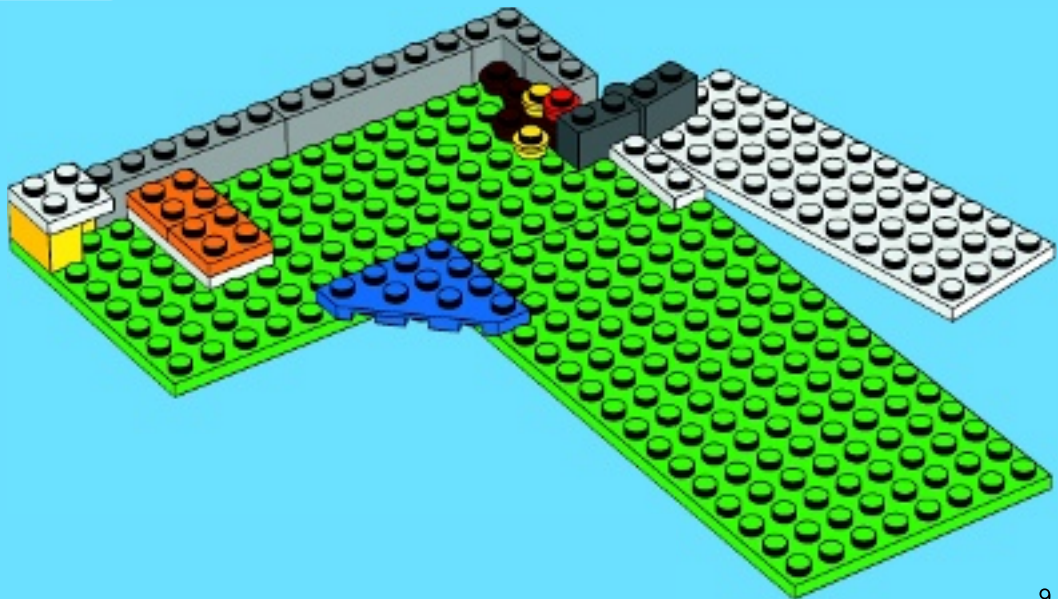

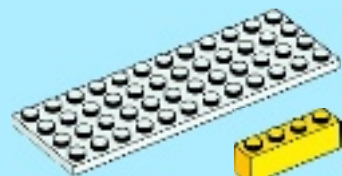

1x

1x

8

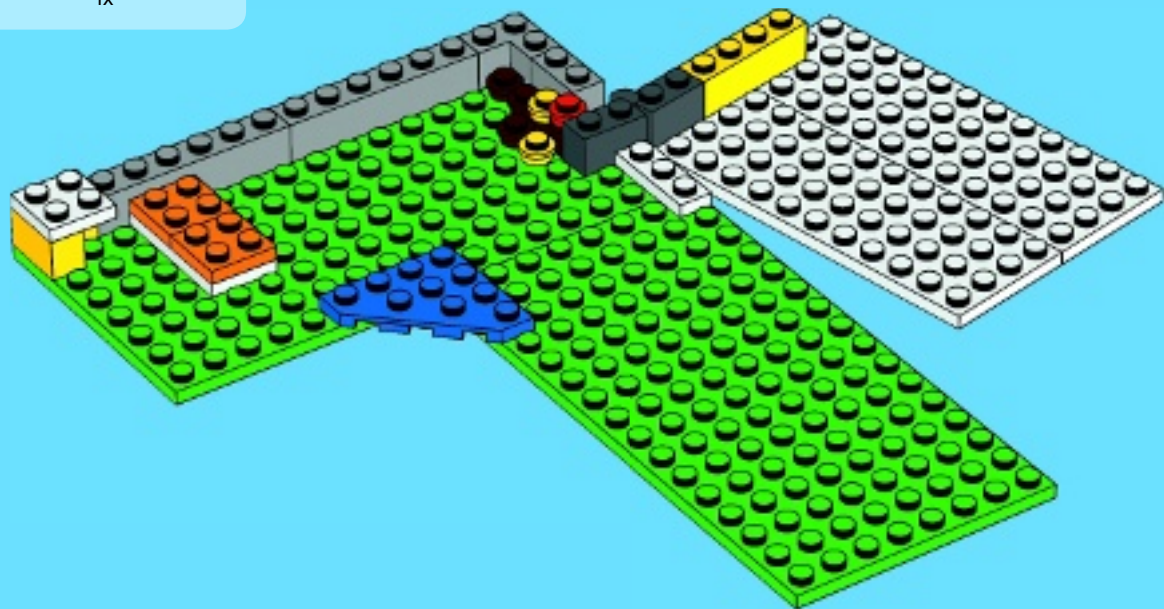

4x

1x

9



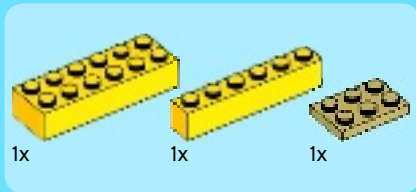

10

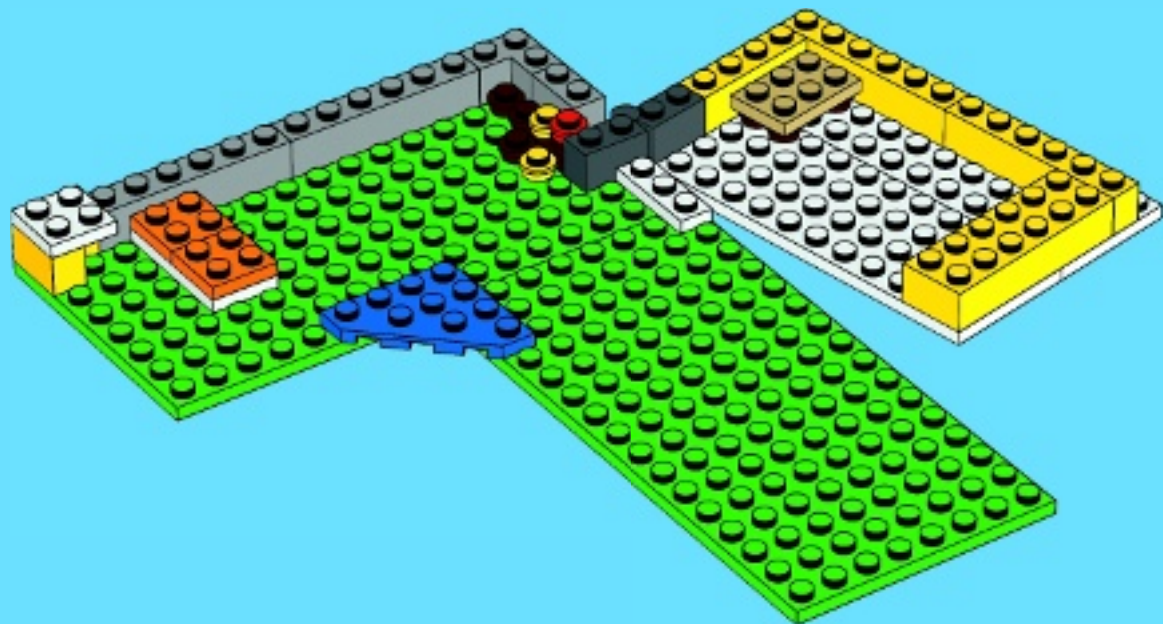



2x



1x



1x



1x

11

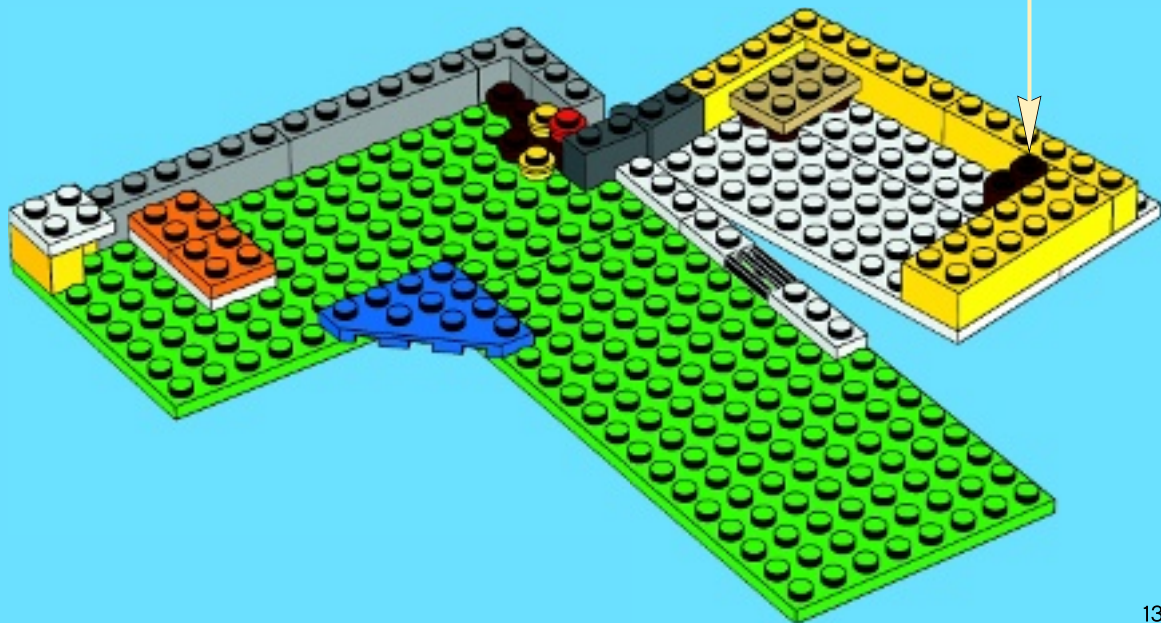



1x



1x



1x

13

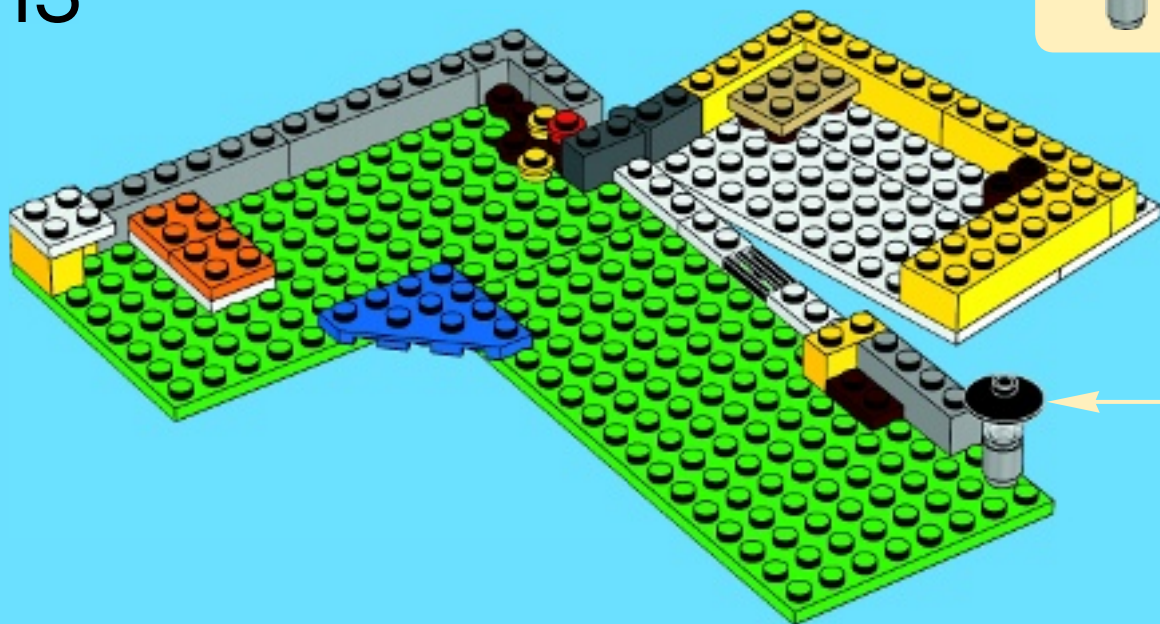

1



2



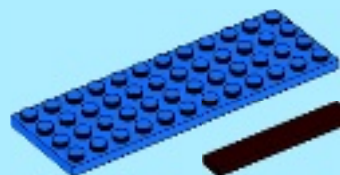

1x

1x



1x

14

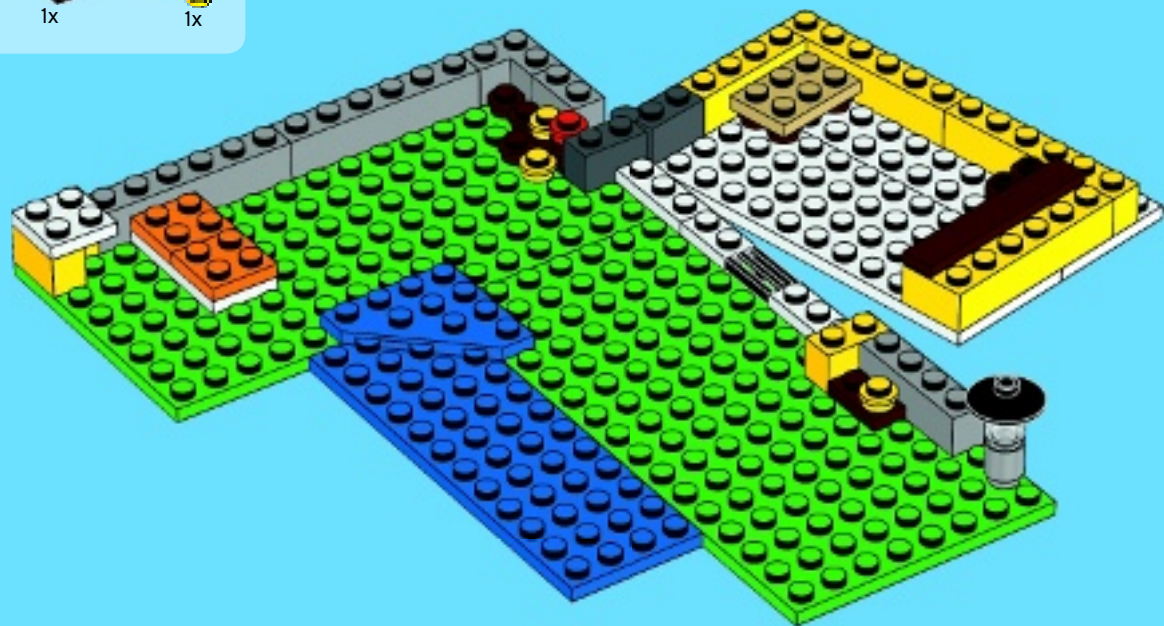



2x



1x



15

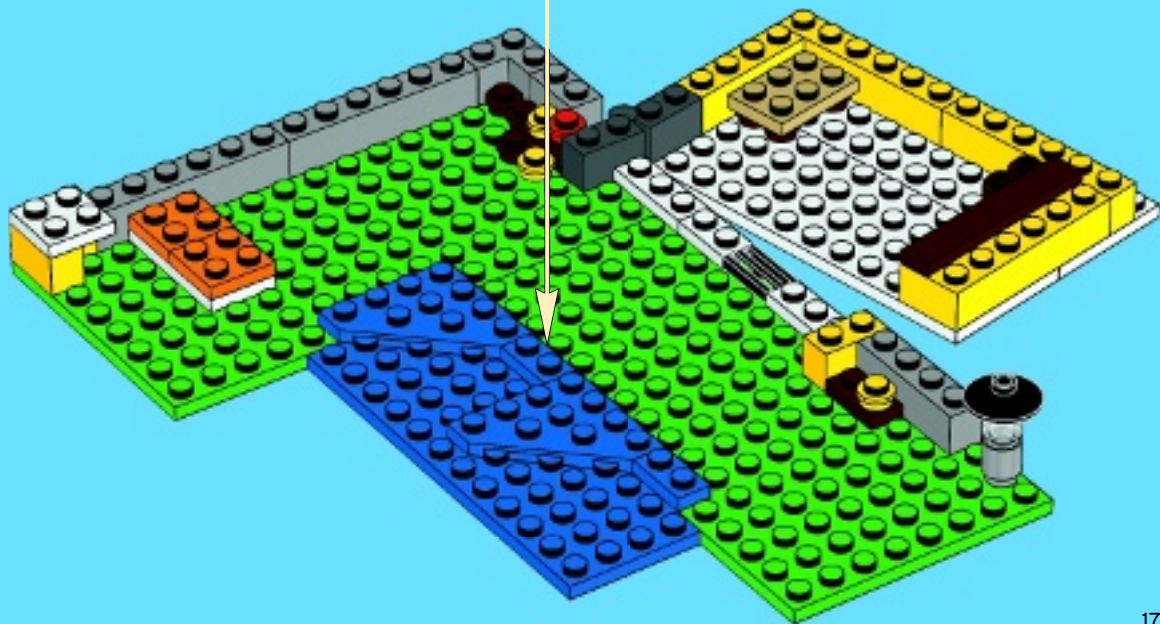



1x



1x



1x

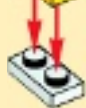

17





1x



1x



1x



1x

18

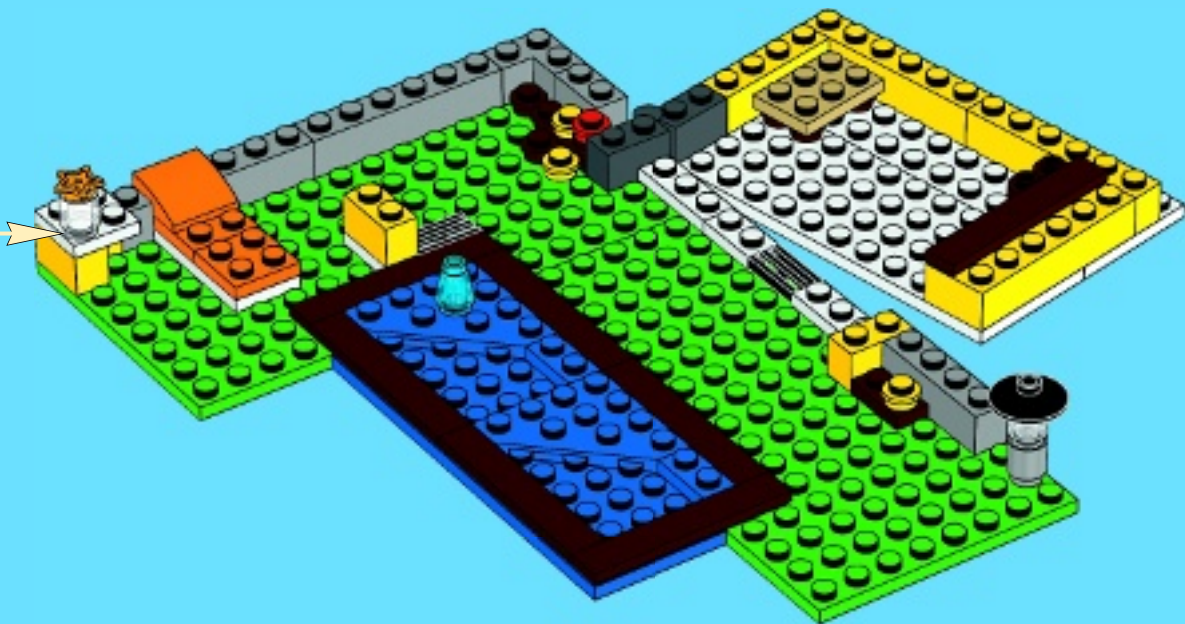



2x



1x



1x

1



2



19

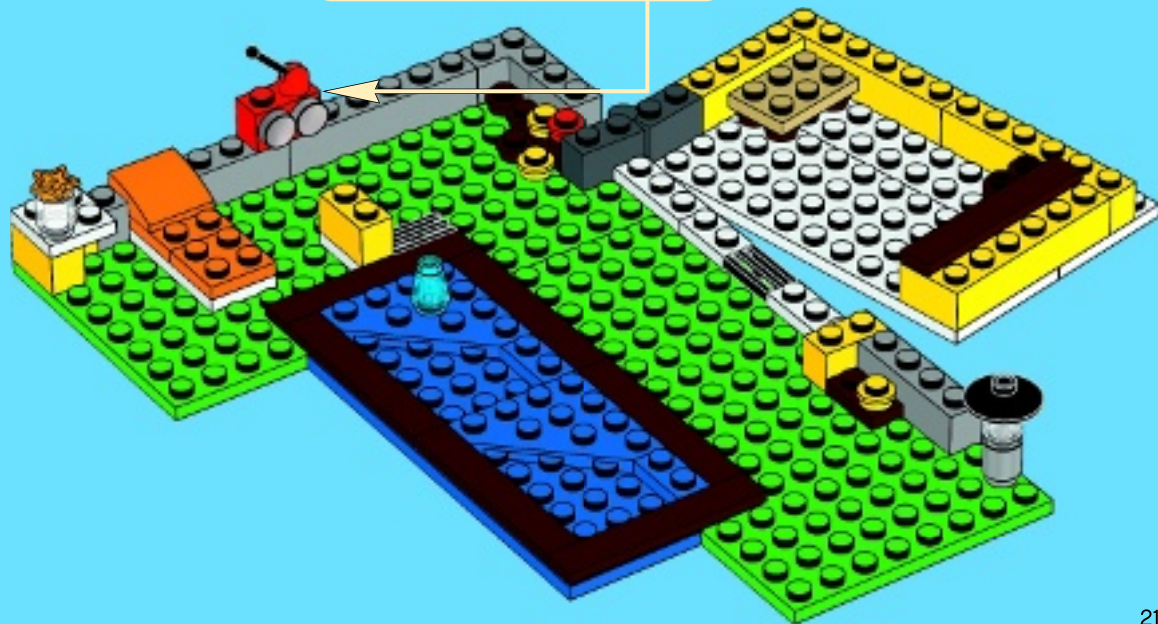



1x



1x



1x



1x

20

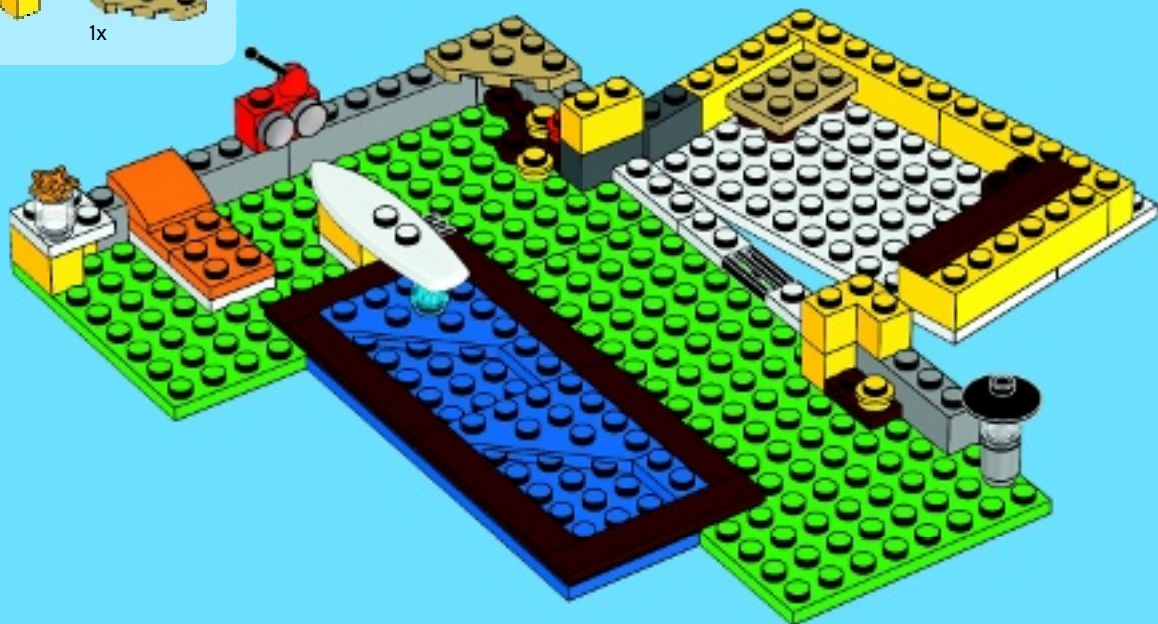



1x



1x



2x



1x



1x

21

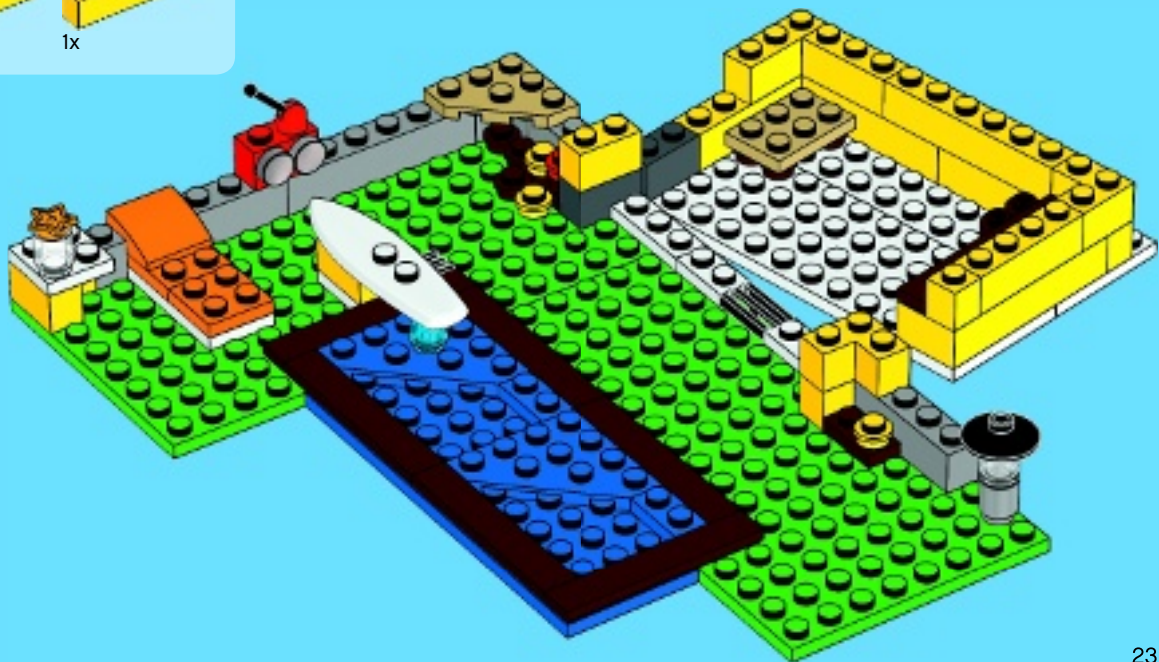



1x



2x



1x

22

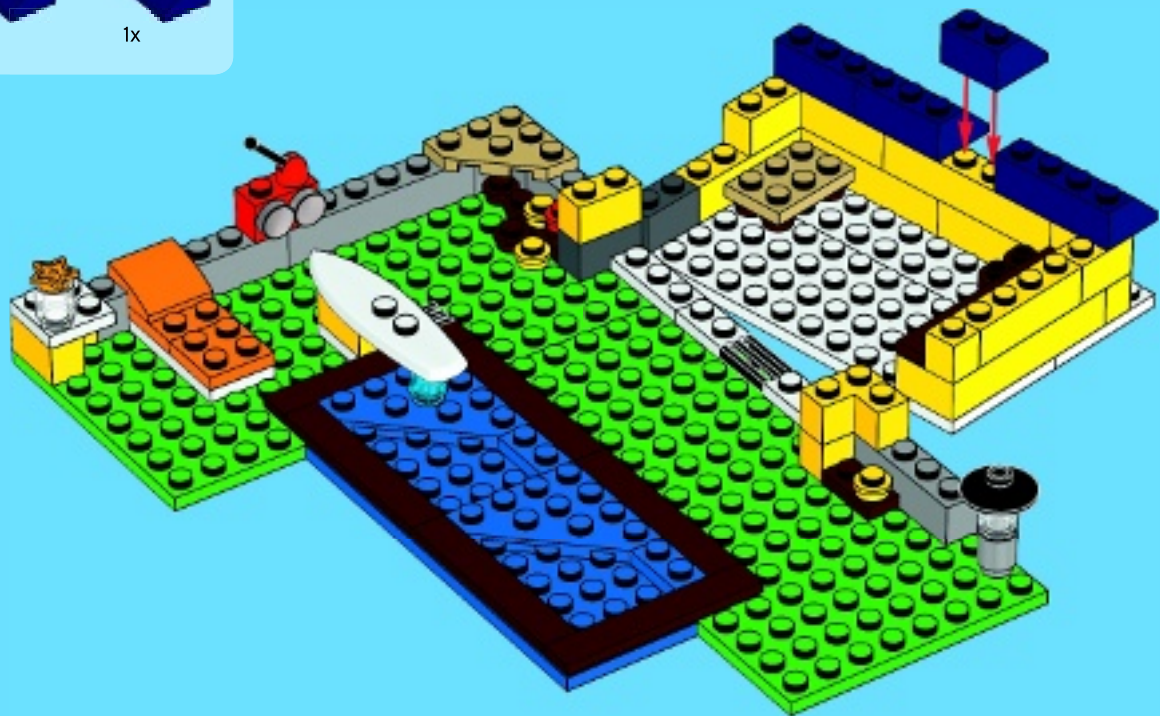



1x



5x

23





2x



2x

24



2x



1x

25





2x



1x



2x



1x

1



2



3



26





3x



2x



1x

28

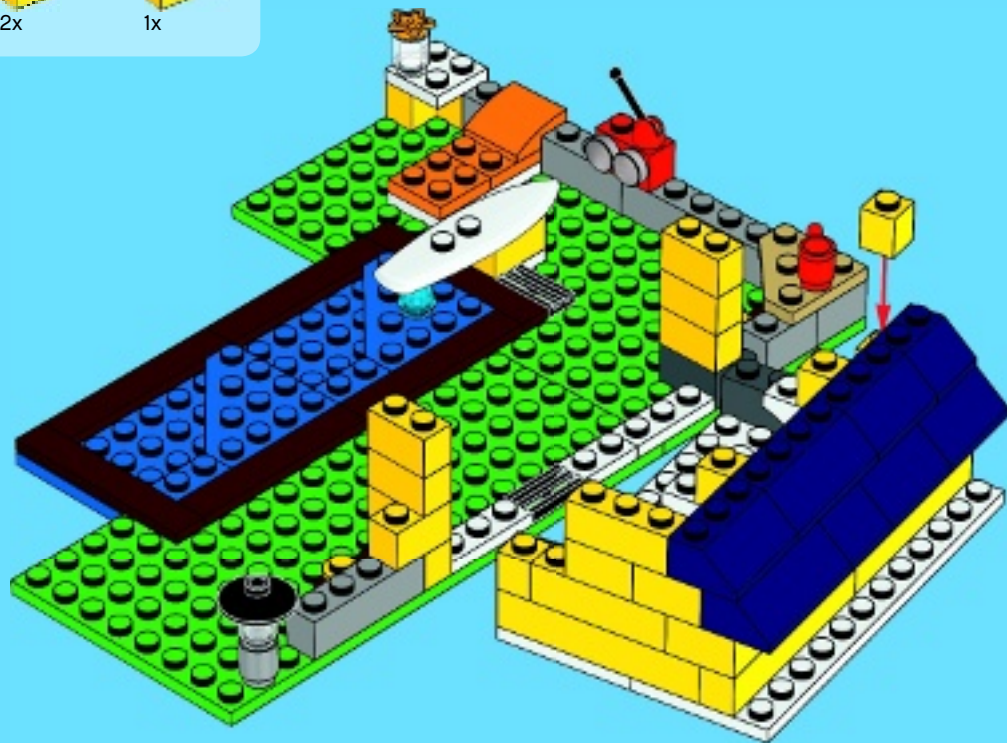

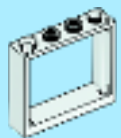

1x



1x

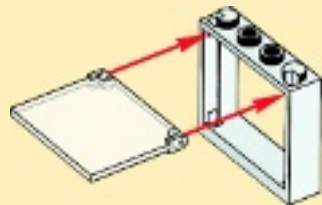

29





2x



2x

30

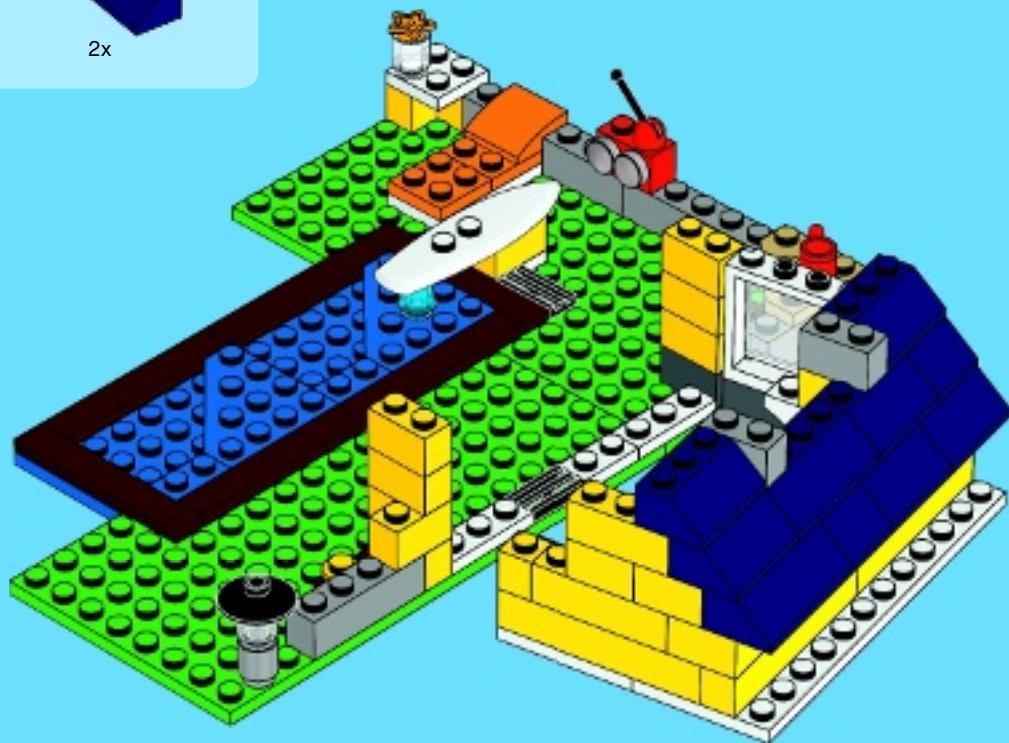



1x



3x



1x

31

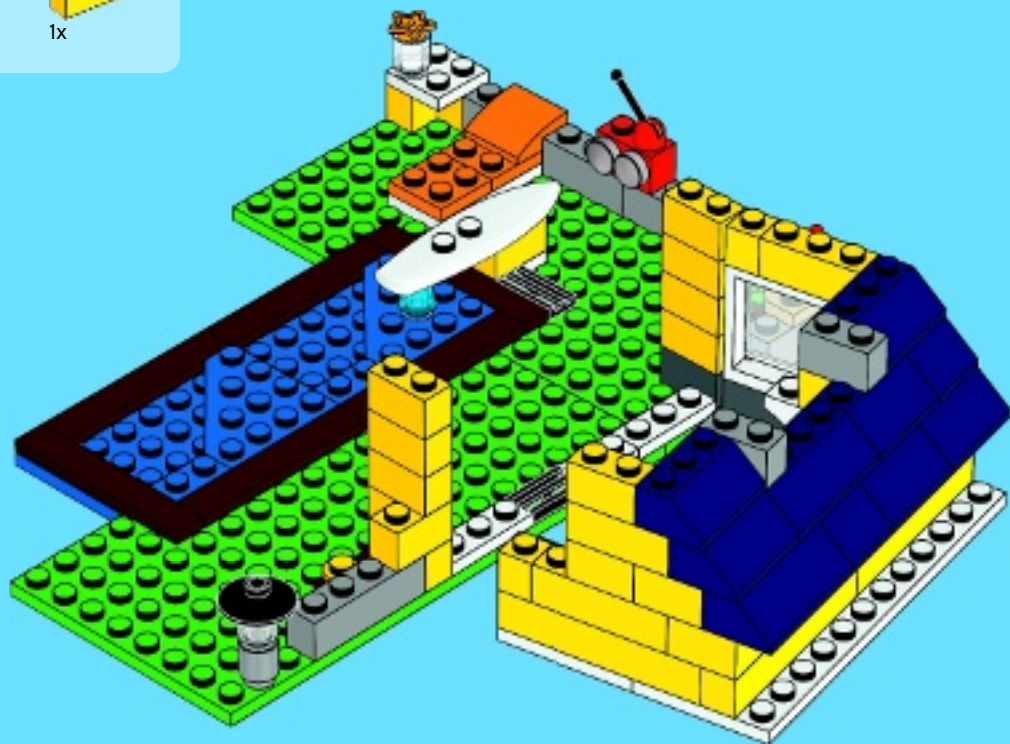



1x



1x



2x

32

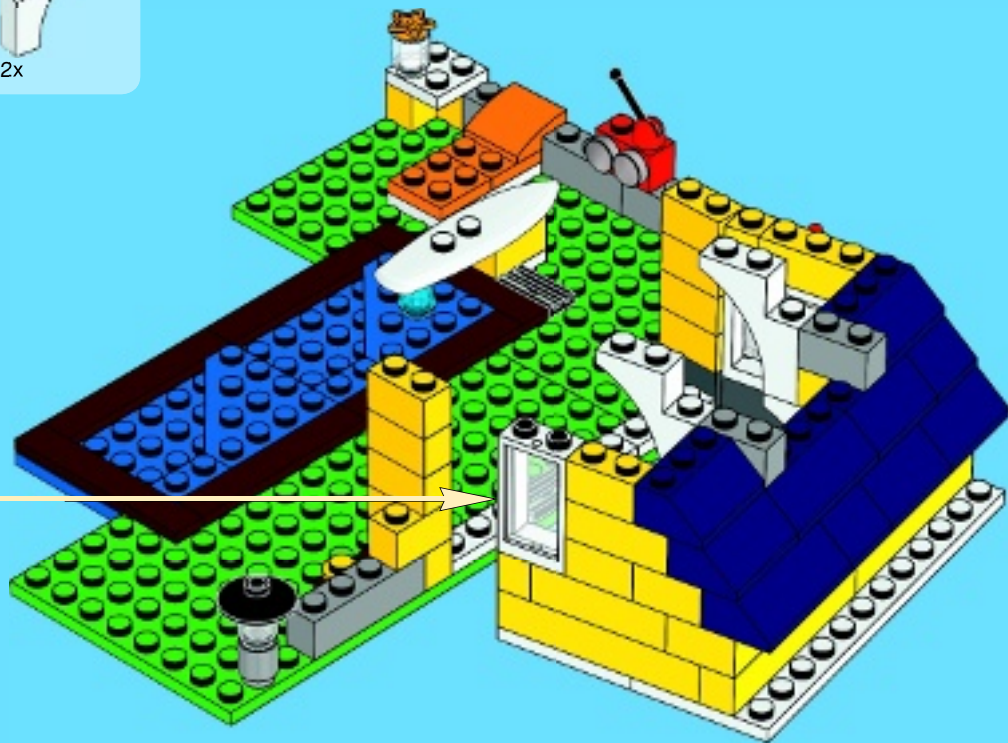
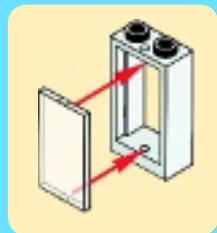



2x



2x



2x

33

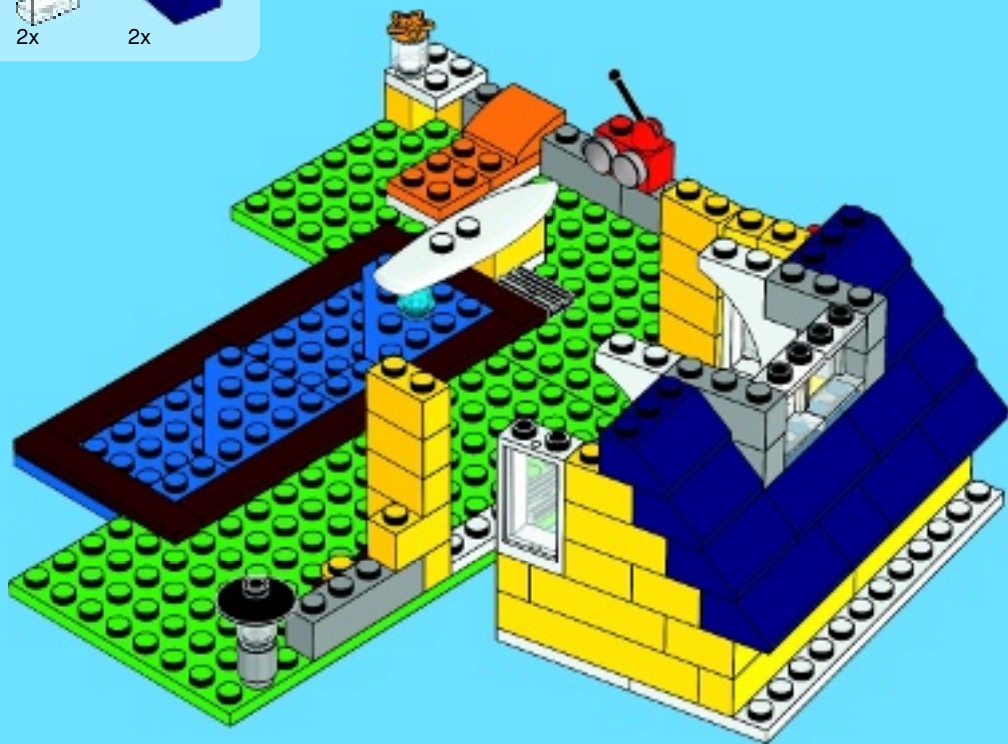



3x



1x



1x

34





2x



2x



2x

35

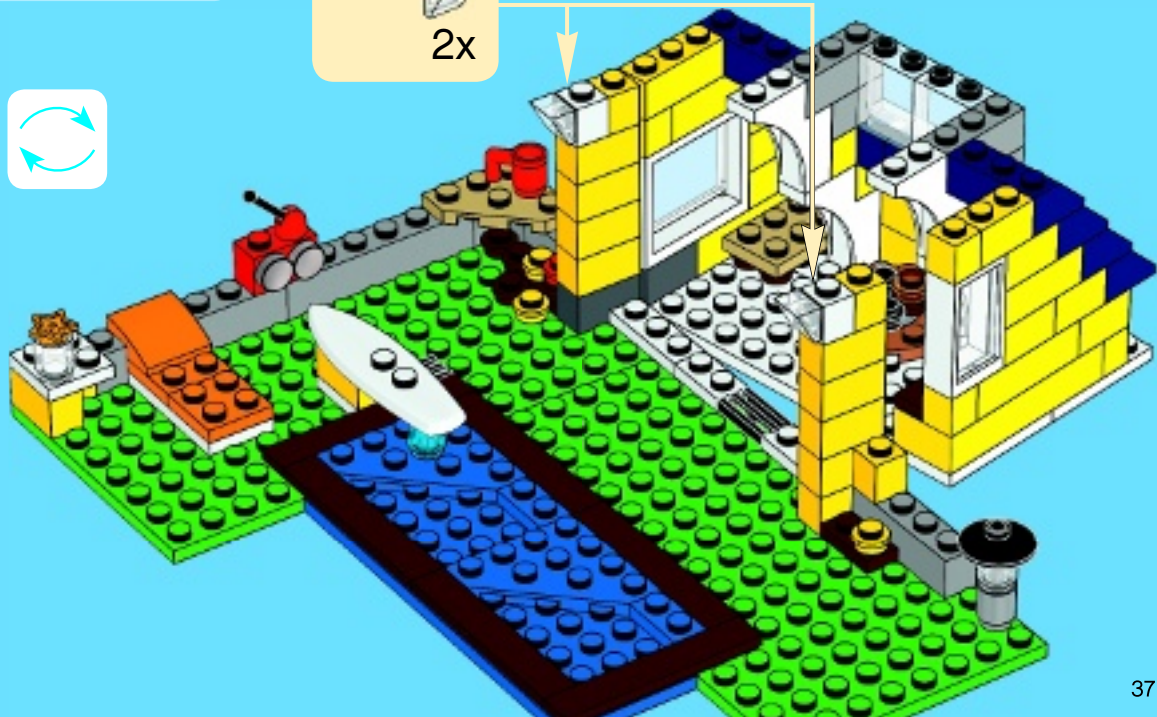

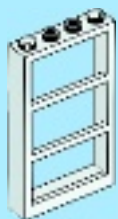

1x



1x

36

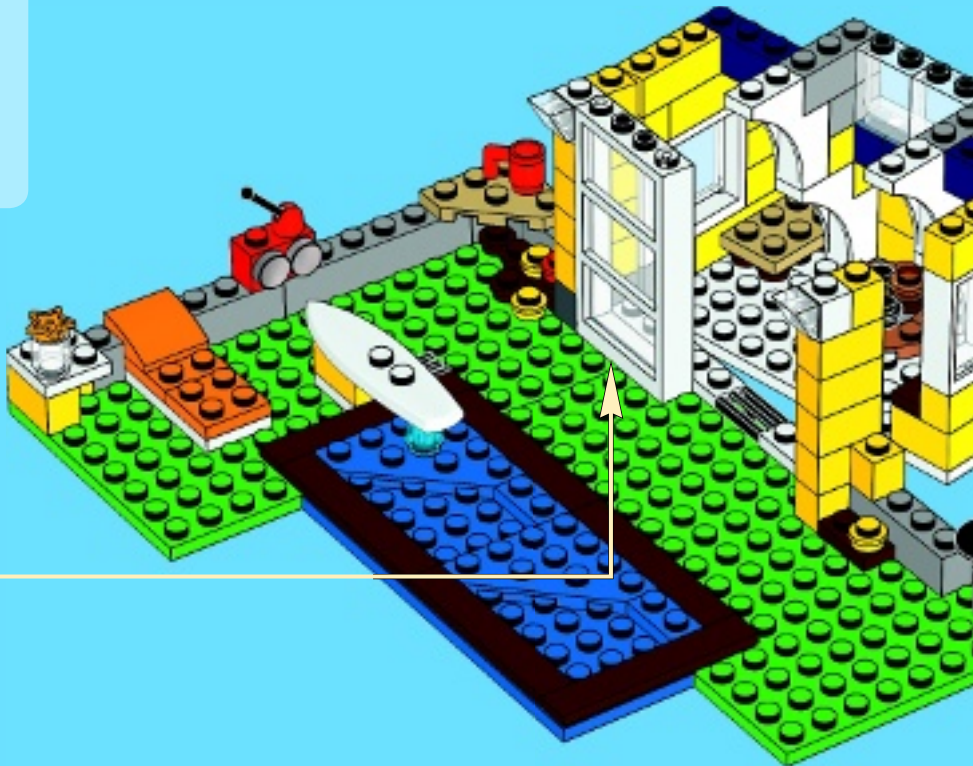
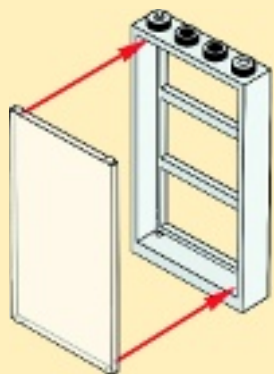

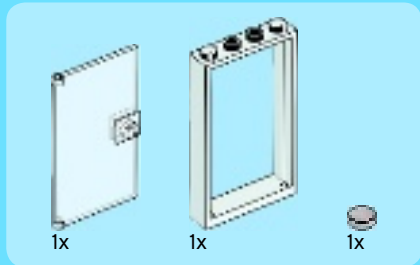

37

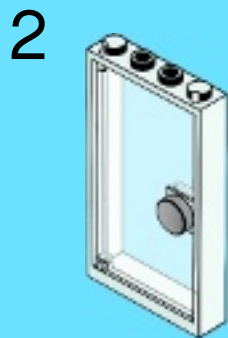
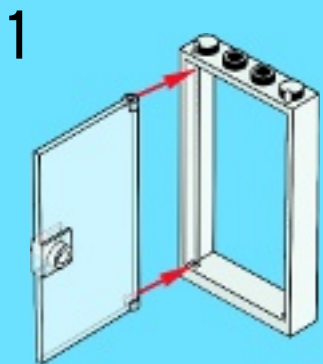

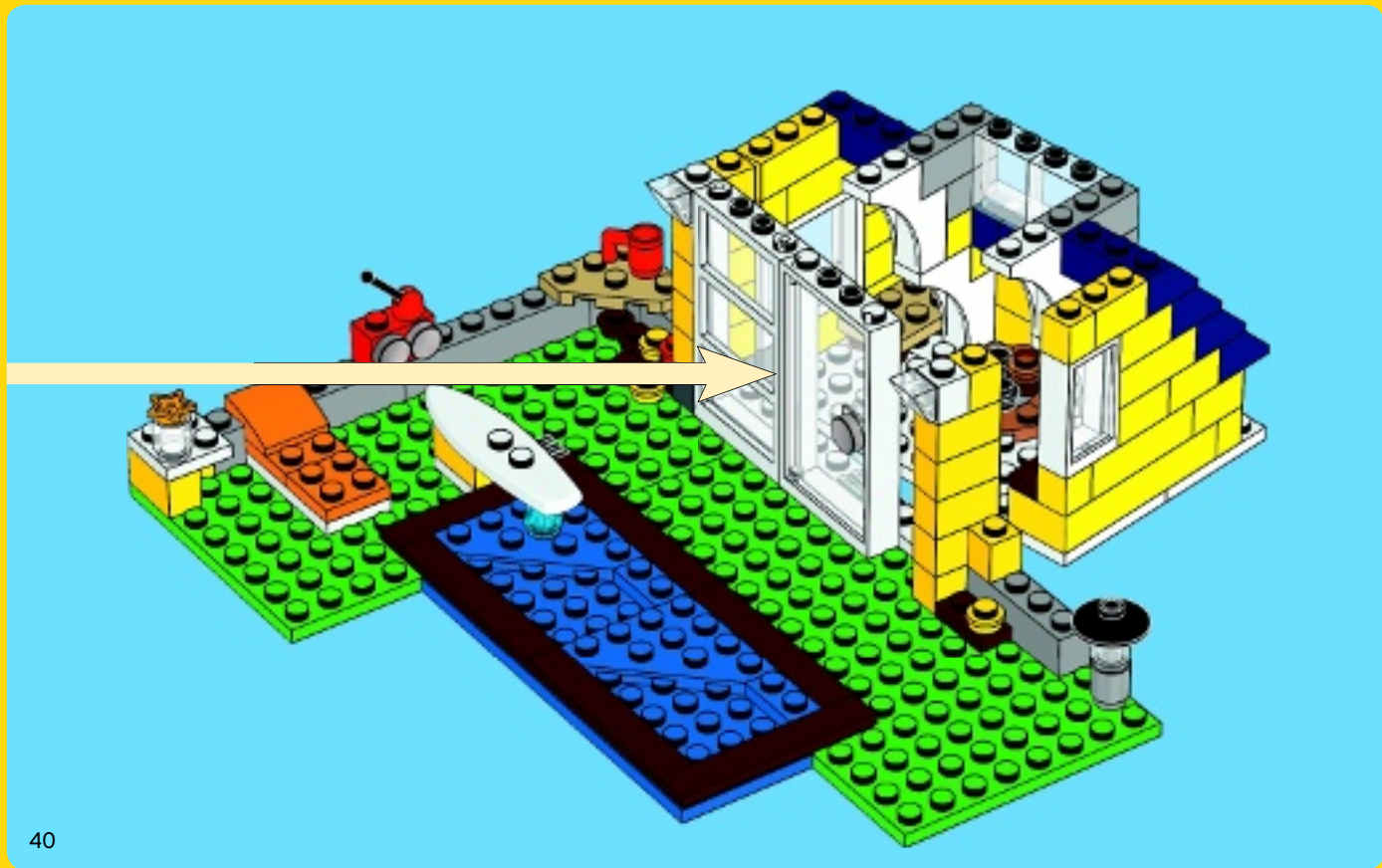



2x



2x

38

1

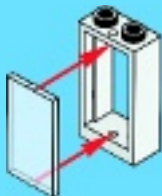

2

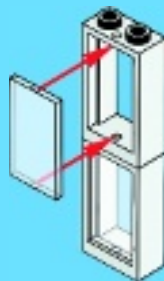

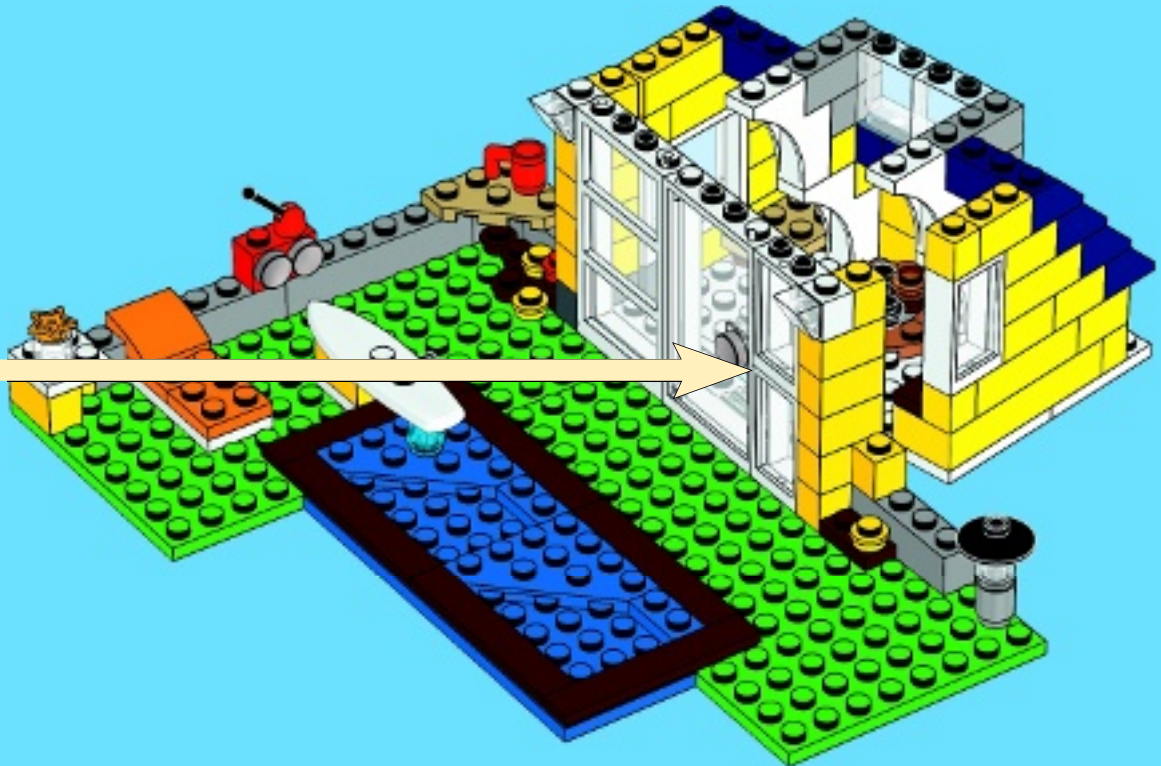



4x



1x



1x

39

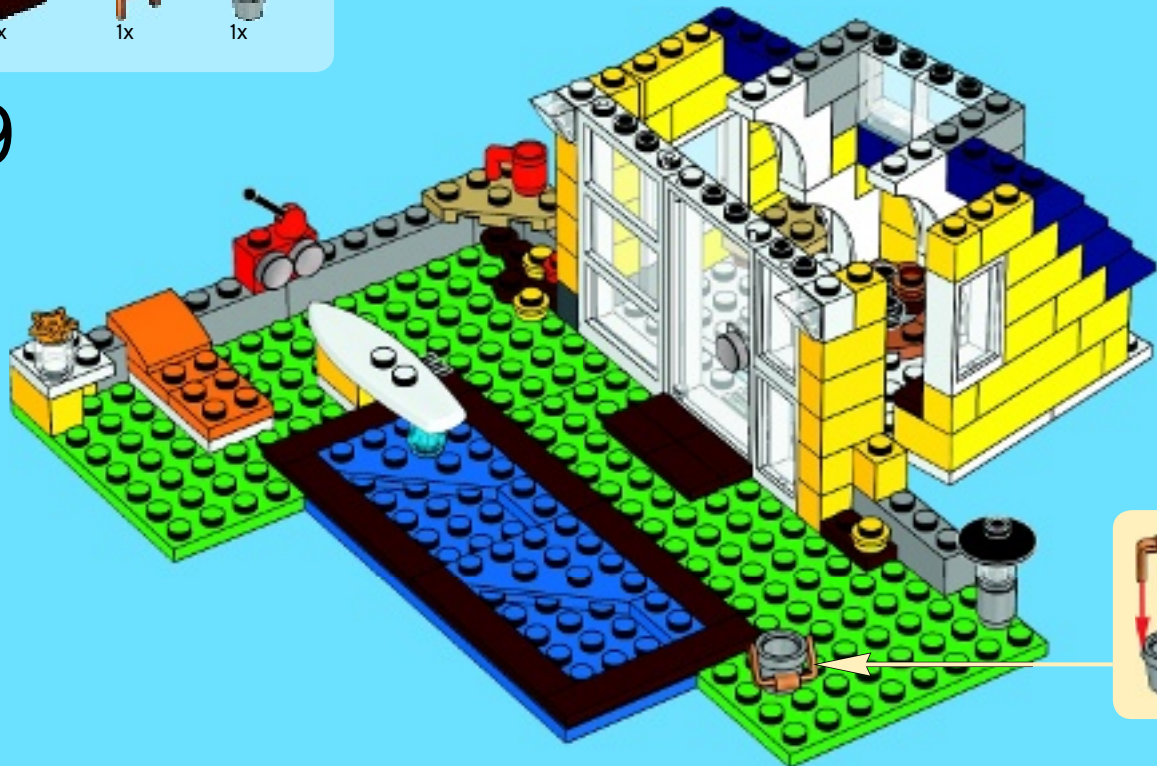

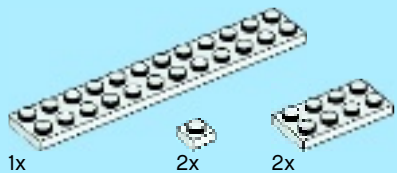

1x

2x

2x

40

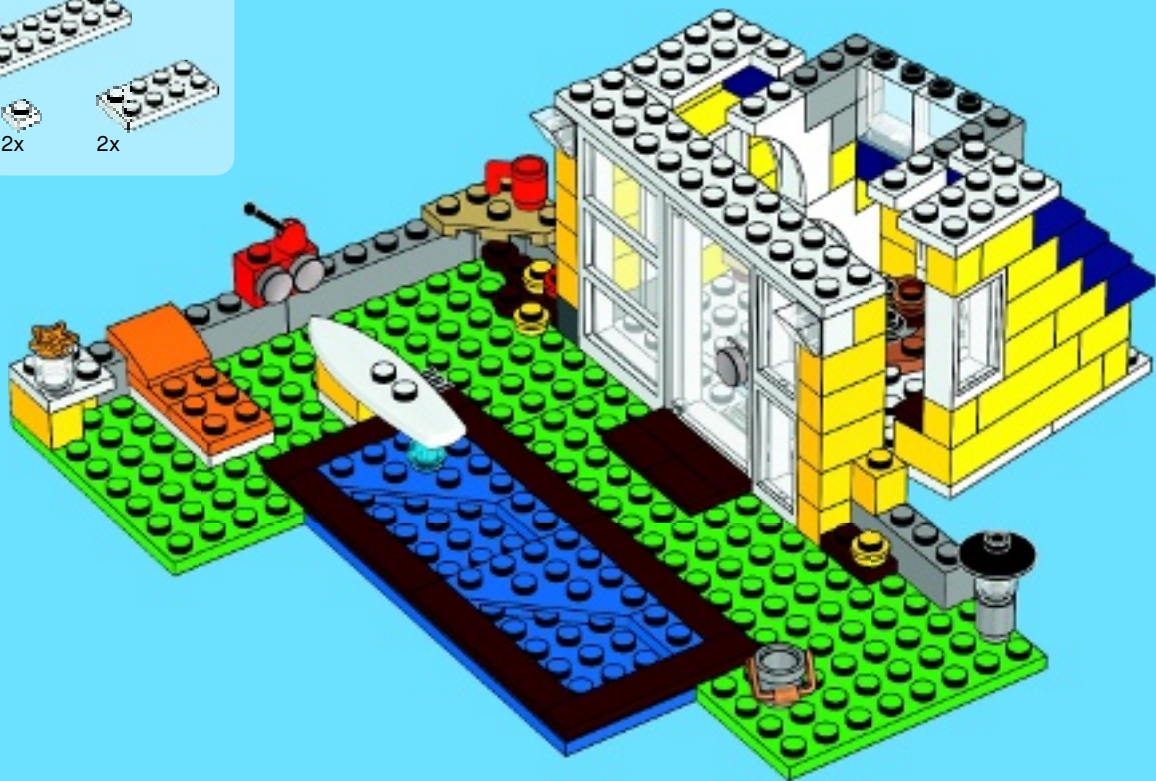



1x



1x



1x

41

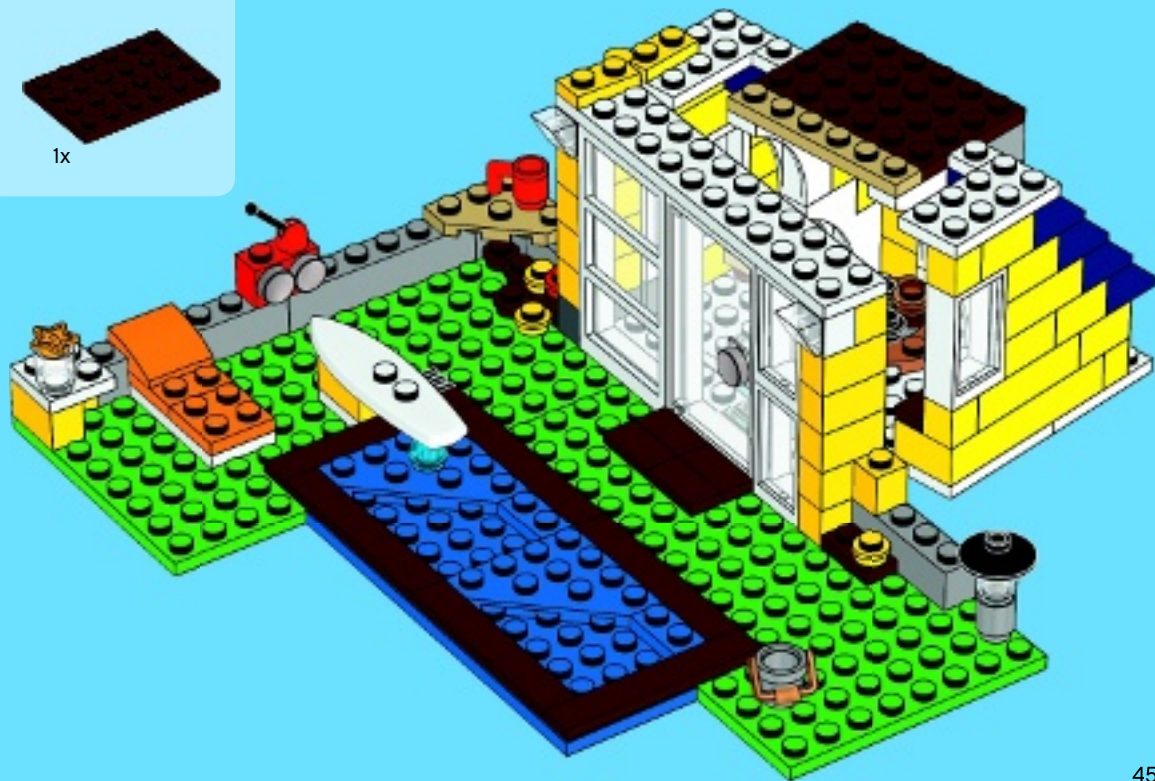



4x

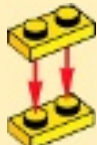

2x

42





1x



3x

43

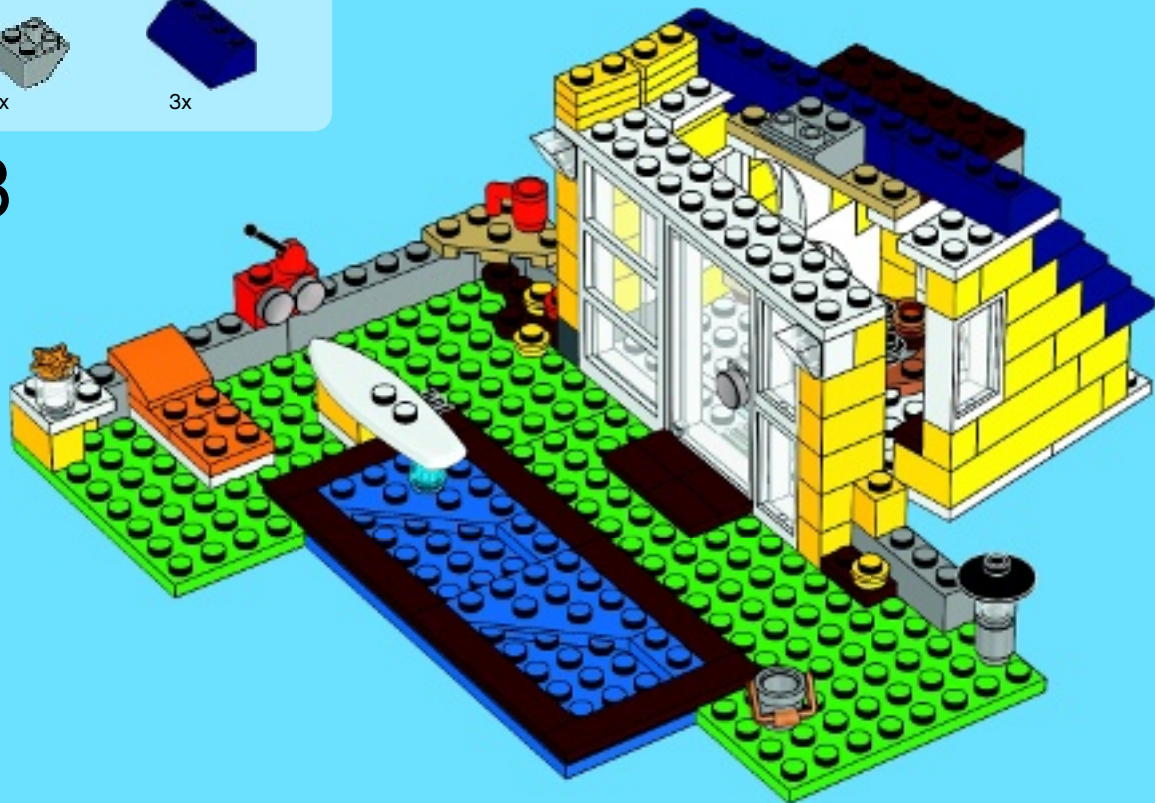

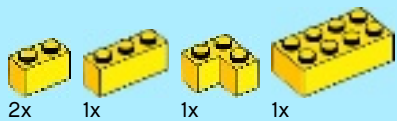

44

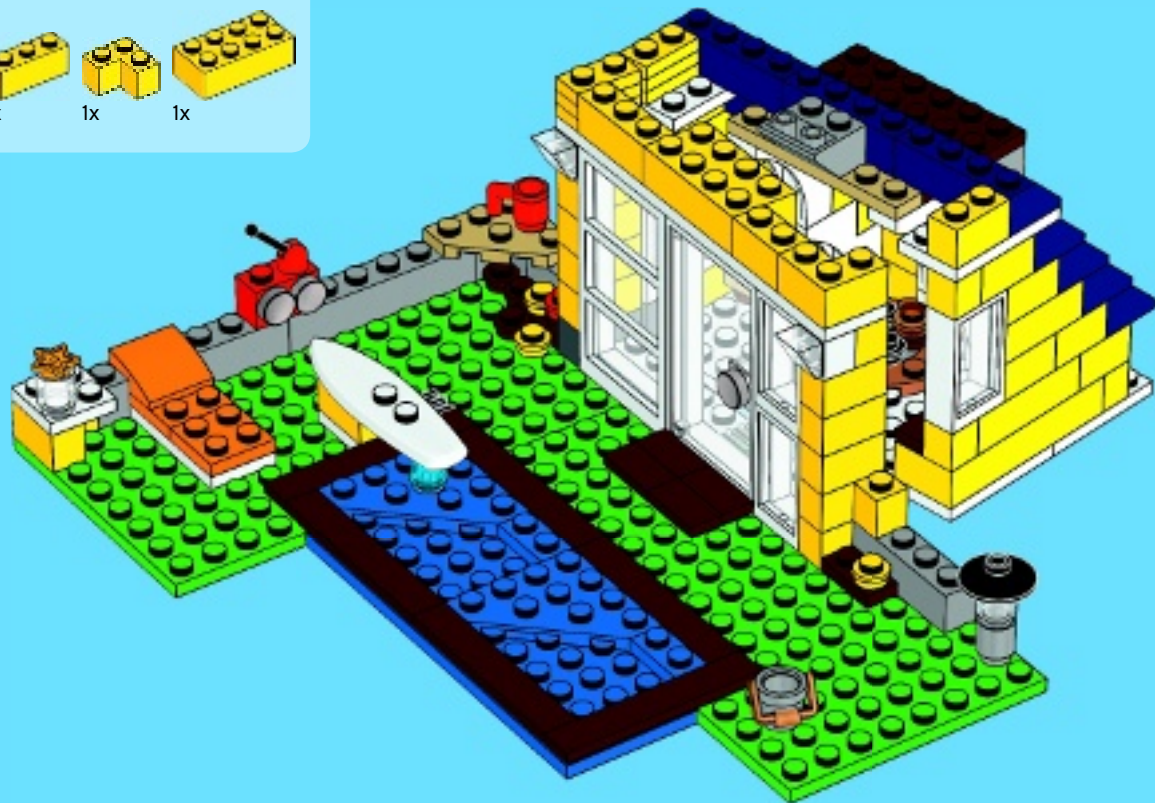



4x

45

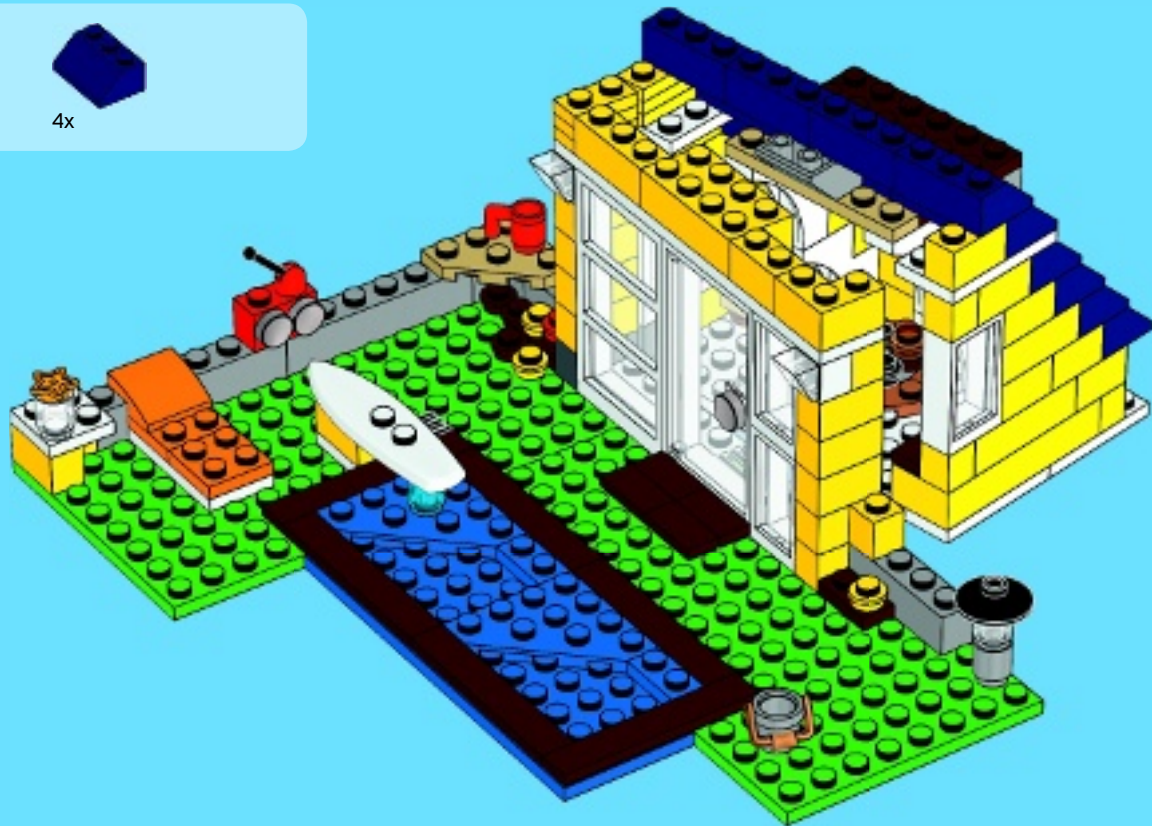



4x



1x



1x

46

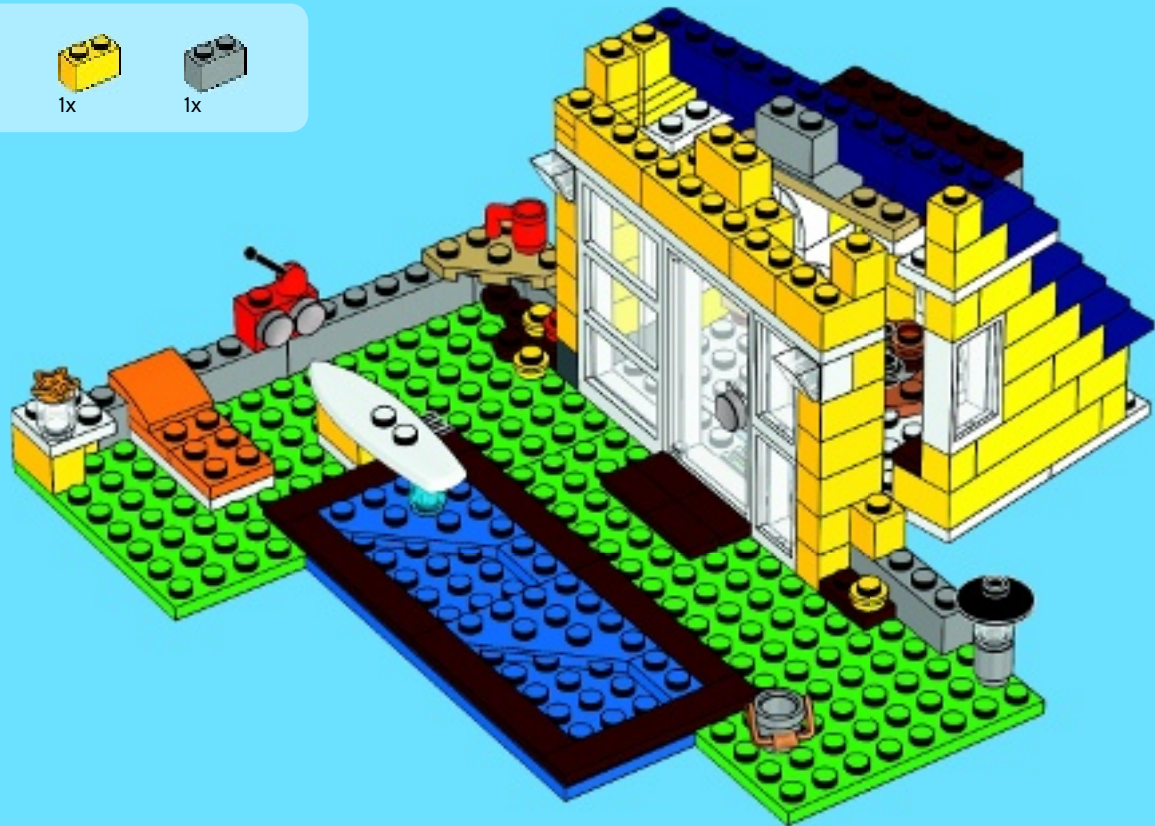



4x

47



48



1x



1x



1x



1x



1x



2x



2x

1



2



3



4

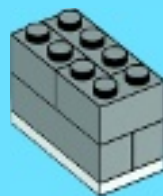

5



6



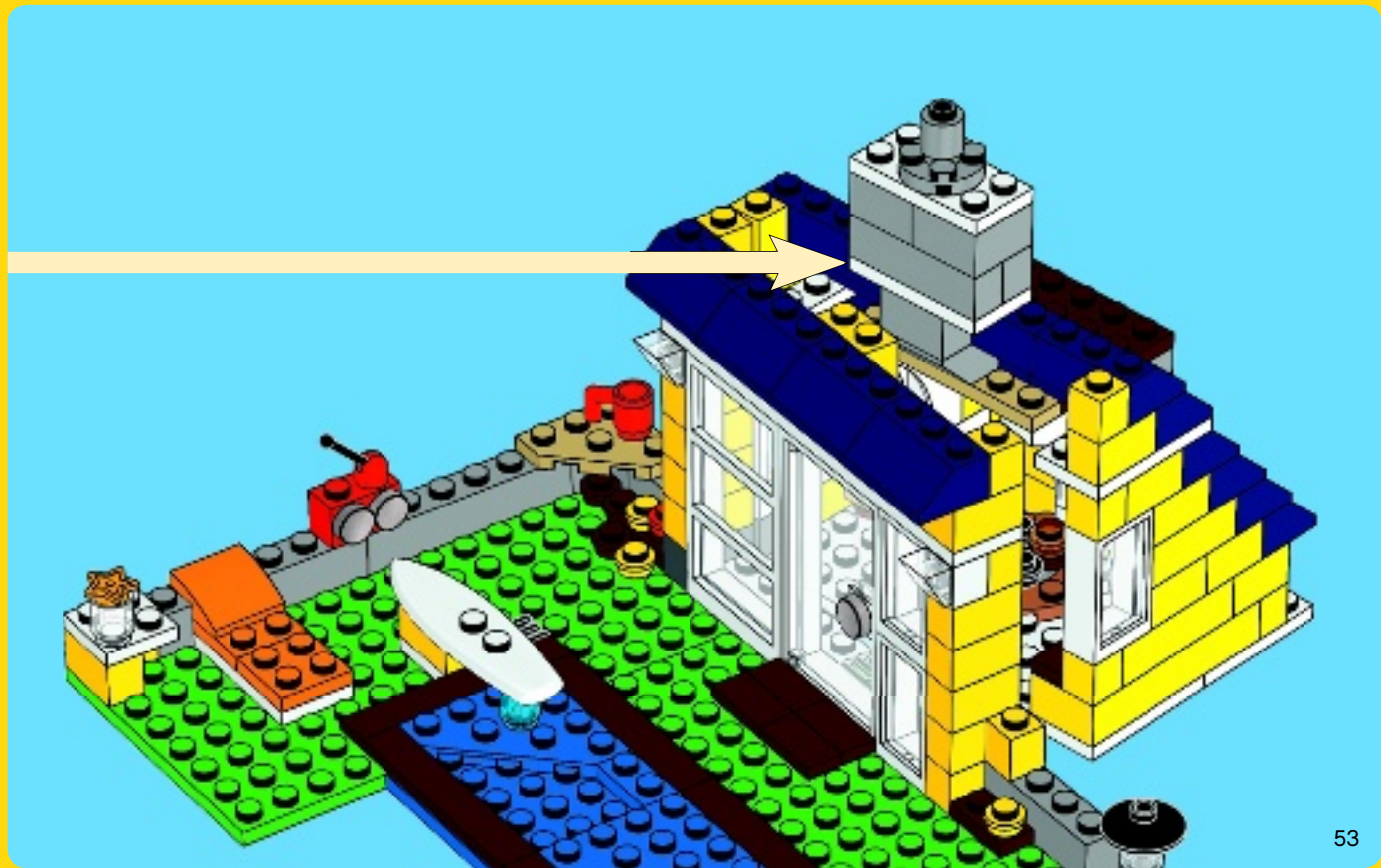



5x

49





2x



2x

50



2x

LEGO and the LEGO logo are trademarks of the/
sont des marques de commerce du/son marcas
registradas de LEGO Group.
©2015 The LEGO Group.
6120323 / 6120324

