



CLASSIC

7 [LEGO.com](https://www.lego.com)

10693









LEGO.com/brickseparator

 Easy building
Einfach zu bauen
Construction facile
Construcción fácil
Construção fácil
Kezdő építőknek
简单拼砌

 Medium building
Mittelschwer
Construction intermédiaire
Construcción intermedia
Construção intermédia
Gyakorló építőknek
中级拼砌



 Advanced building
Fortgeschritten
Construction avancée
Construcción avanzada
Construção avançada
Tapsztalt építőknek
高级拼砌



LEGO.com/classic

Page/页码

6



Page/页码

10

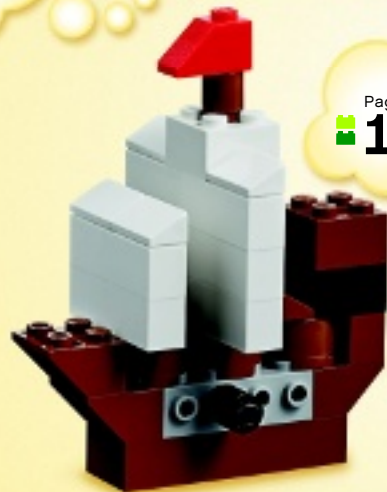

Page/页码

31



Page/页码

40



Page/页码

20



Page/页码

35



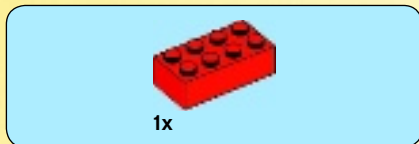

1

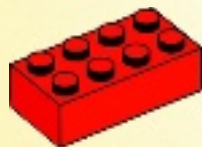



2x

2

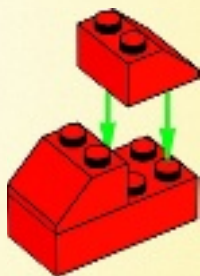

1x

3





1x



1x

4



1x

5





2x

6



1x



2x

7

1



2





1x

1





1x

2

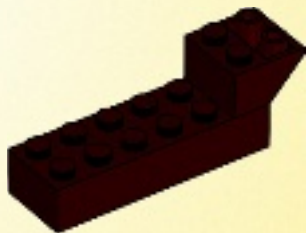

2x

3

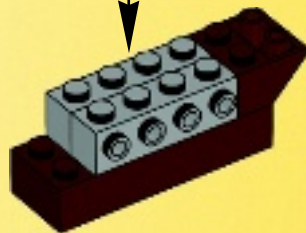
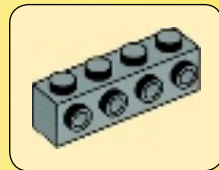



1x

4

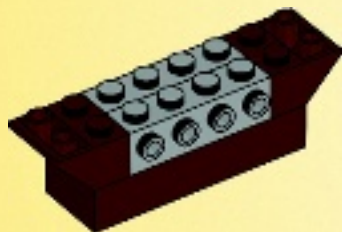



3x

5

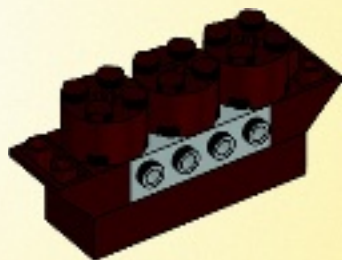

1x



1x

6

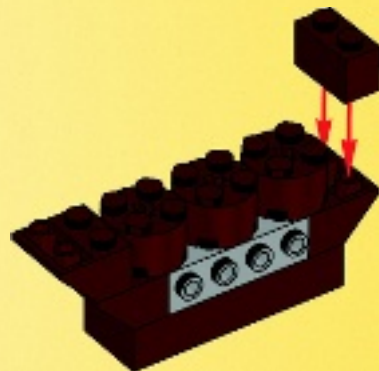



1x



1x

7

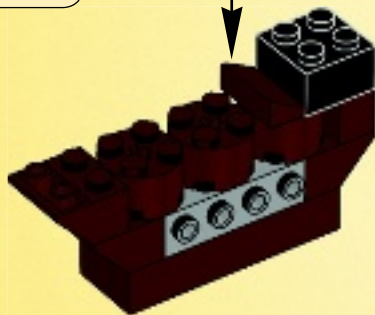
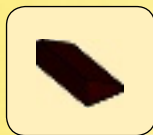



2x

8

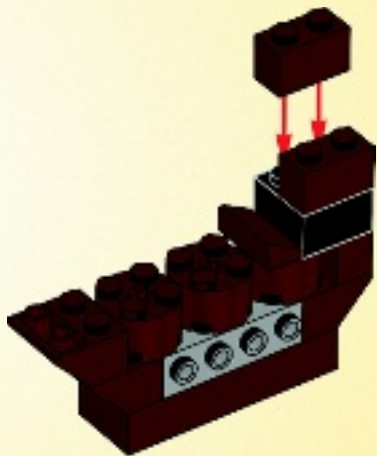

3x

9

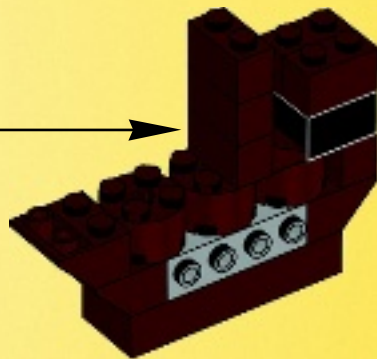
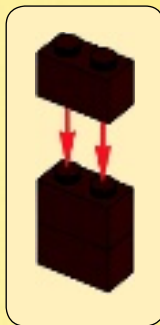

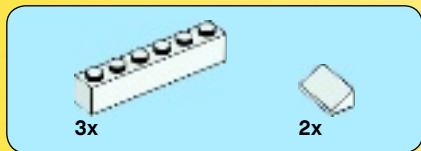

10

1

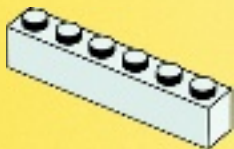

2

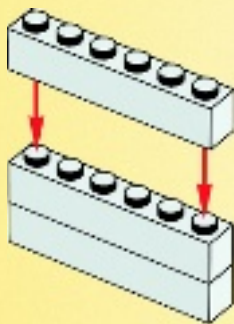

3

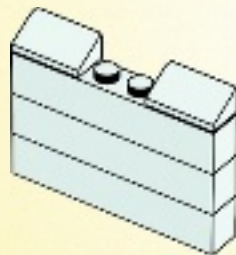

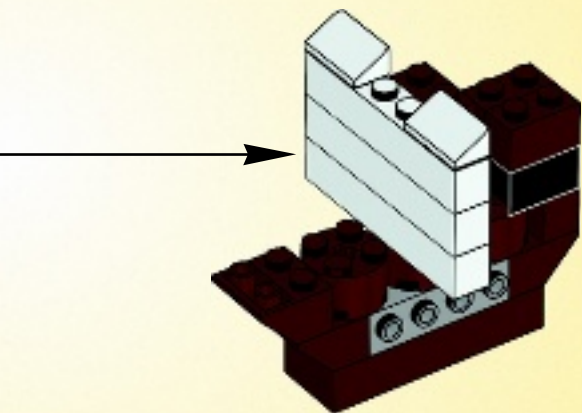

11

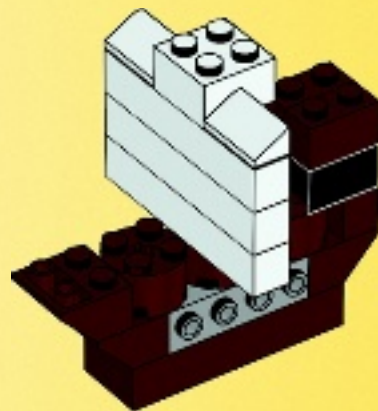



1x



1x

12

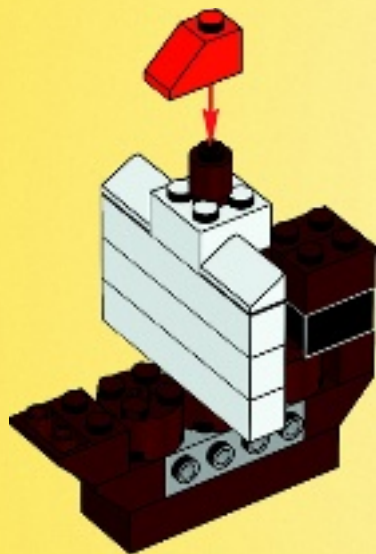

1x



1x

13

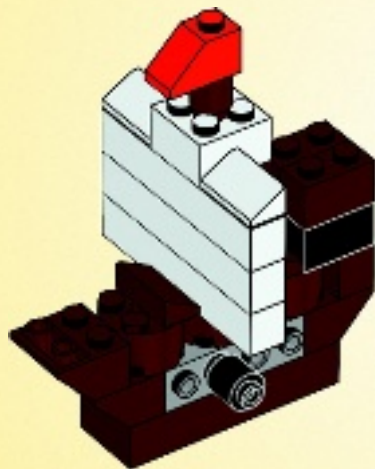



14

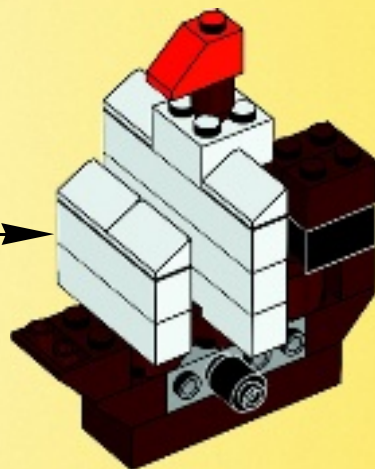
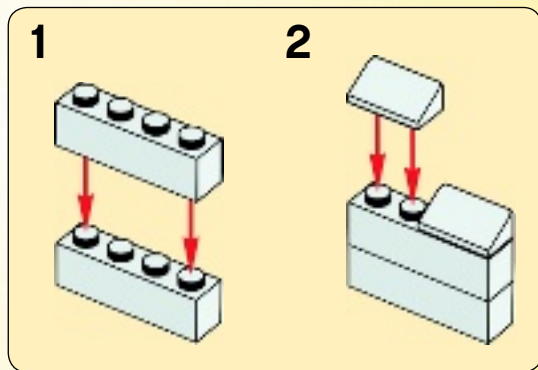

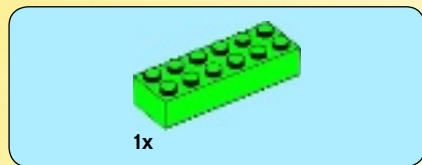

1

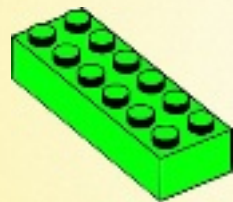



2x

2

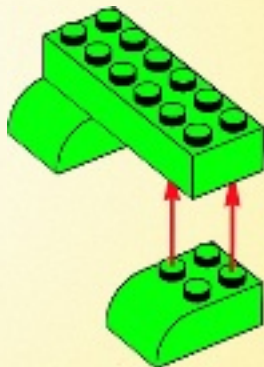

2x

3

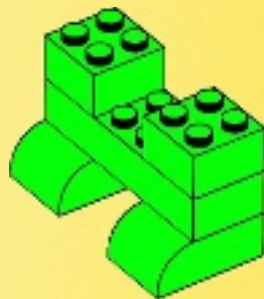

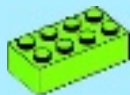

1x

4

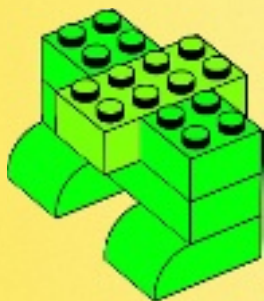

2x

5





1x



2x

6

1



2

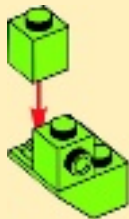



1x

7

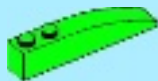
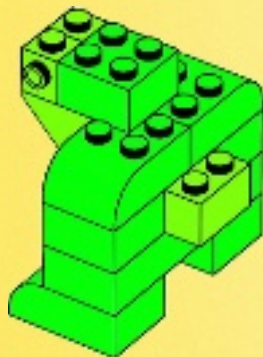

2x

8

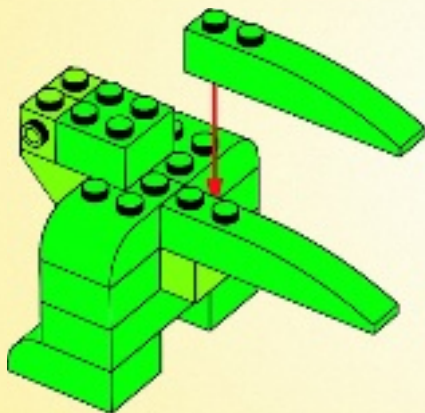



2x

9

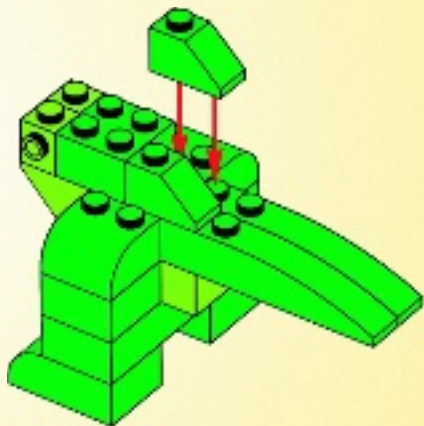

2x



1x

10

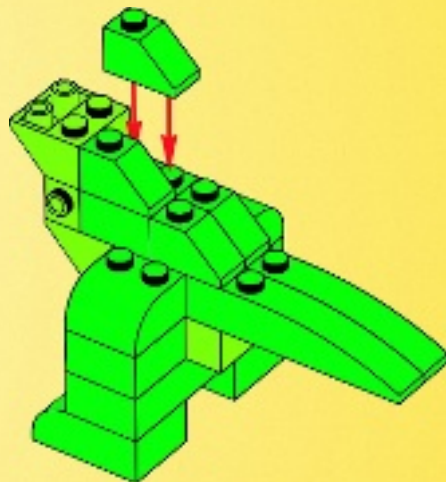



4x



1x

11

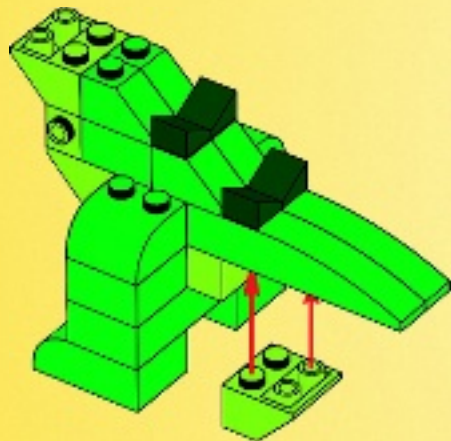

2x

12

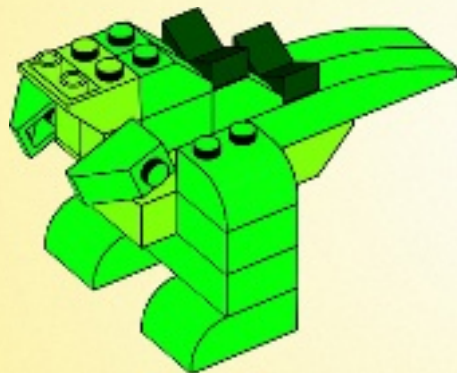

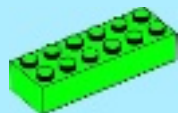

1x

1

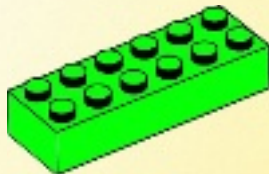

1x

2

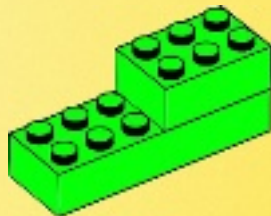



6x

3

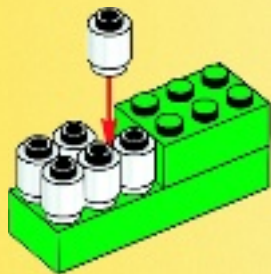

2x

4

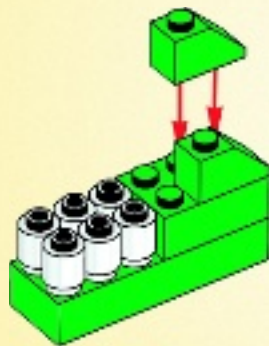



2x



2x

5

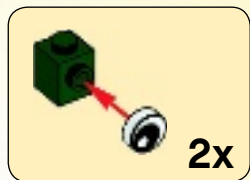

1x



2x

6



13

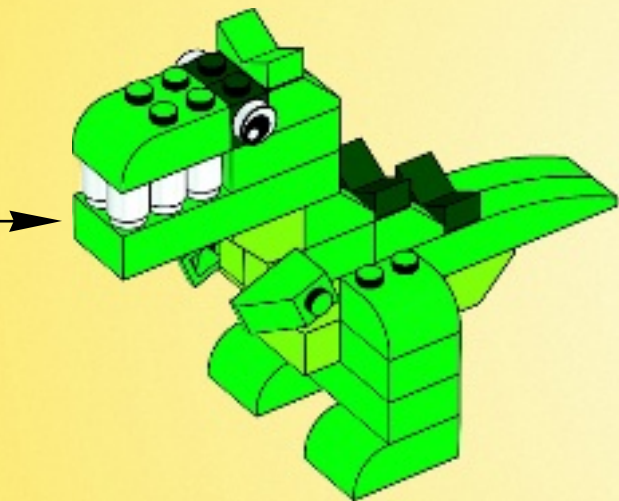

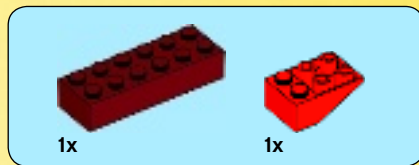

1

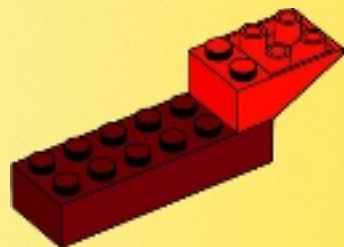

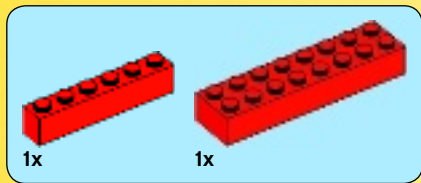

2

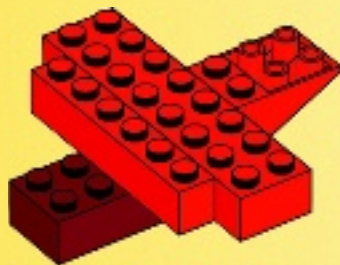

3

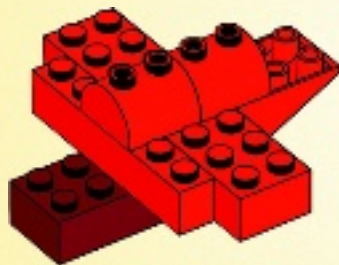



4

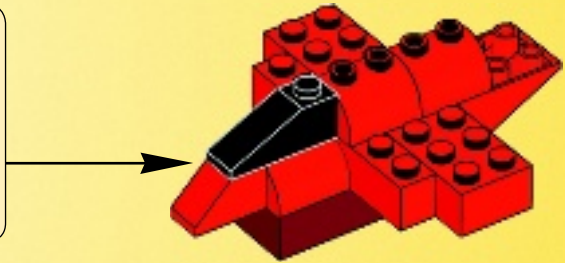



2x

5



1x



1x

6

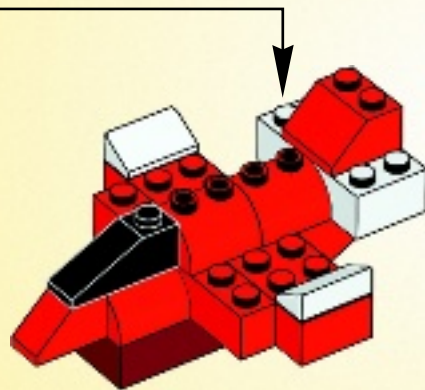
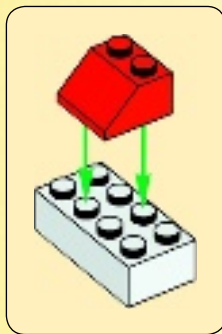



1x

1

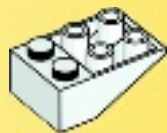



4x

2

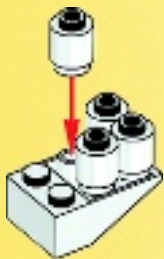

2x

3

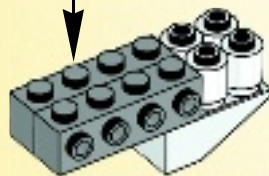
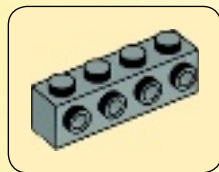



1x

4

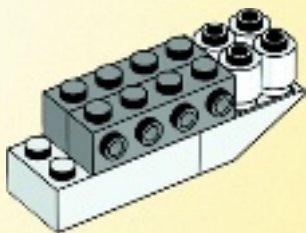

2x



2x

5

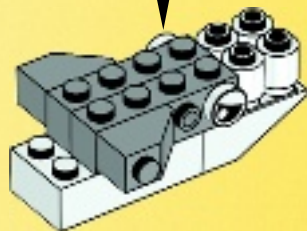



1x



1x

6

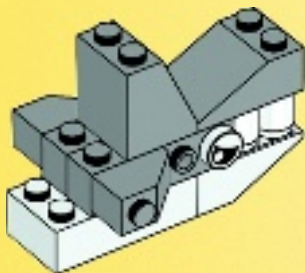

1x

7

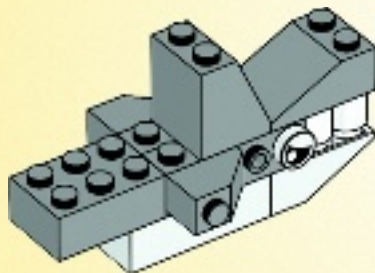



2x

8

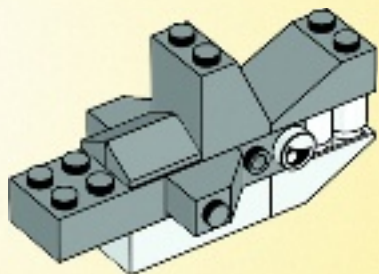

1x



1x

9

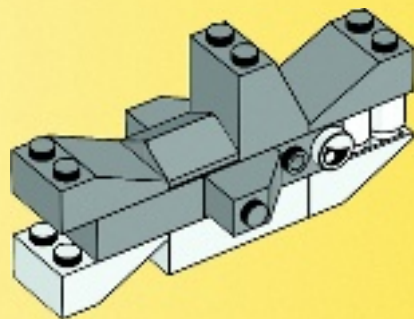

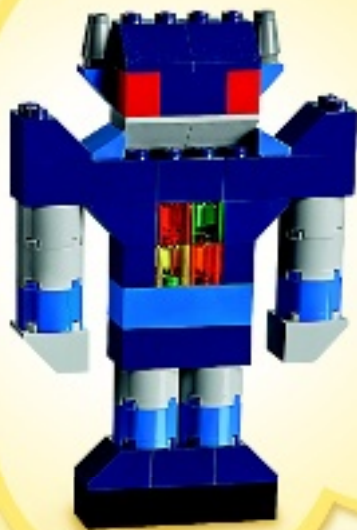

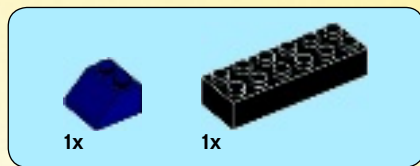

1

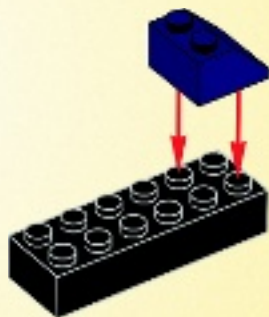

2

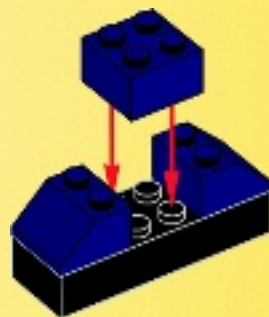



2x



2x

3

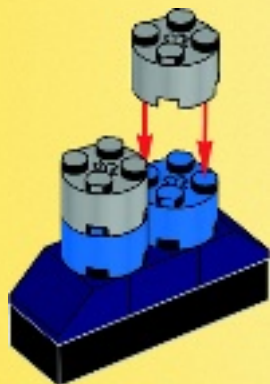

1x

4

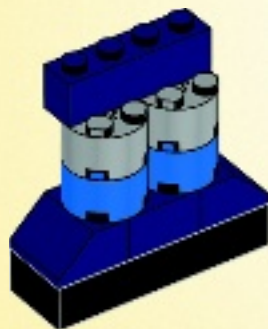



5

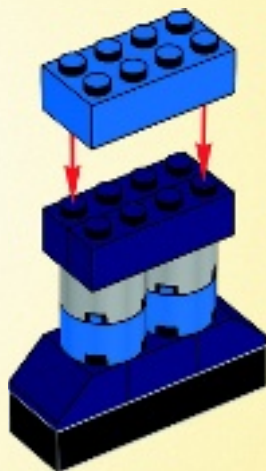

6

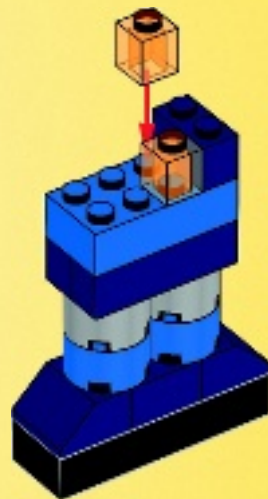



1x



1x

7

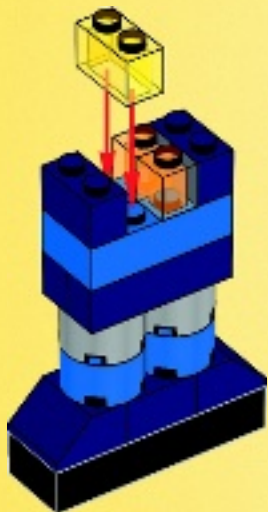

1x



1x

8





1x



1x

9



1x

10



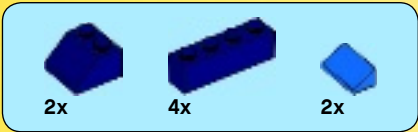

11

1

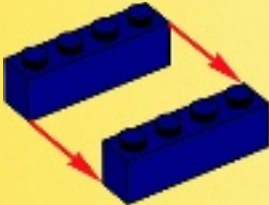

2

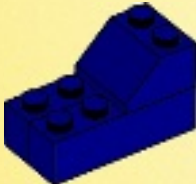

3

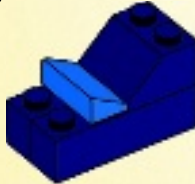

2x

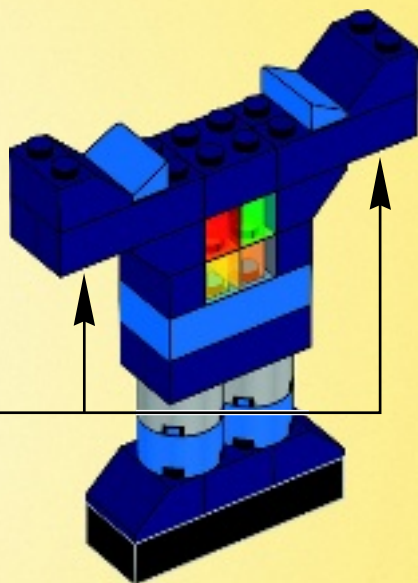



2x

12

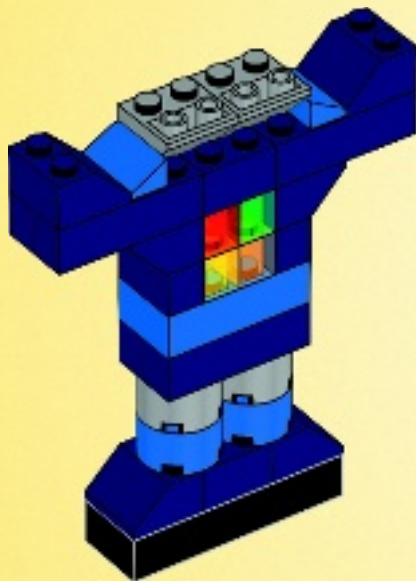



2x



1x

13

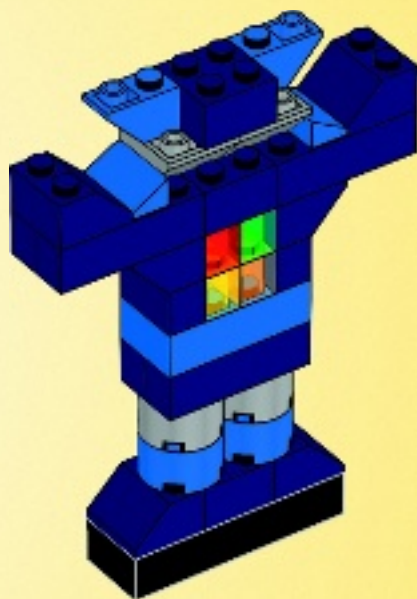



2x

15

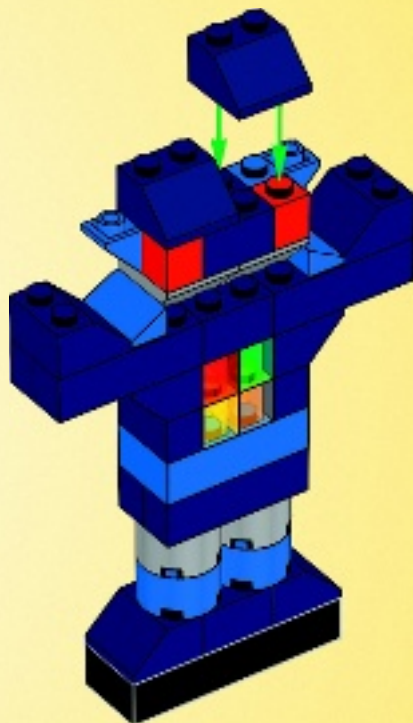



2x

16

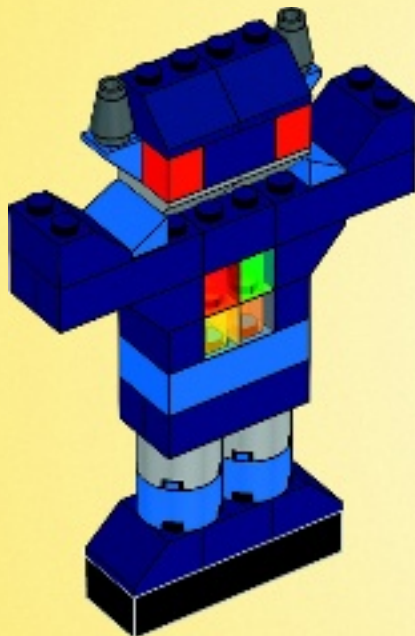

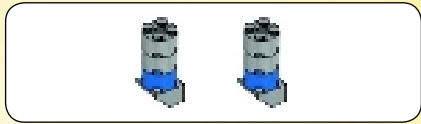

17

1



2



3

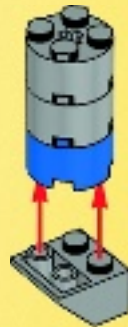

2x

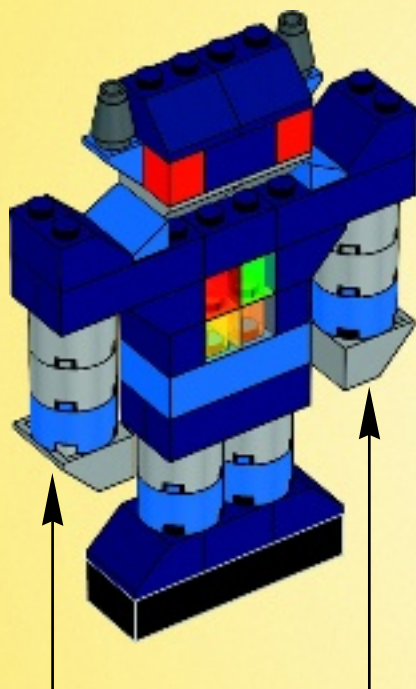



More ideas online:
LEGO.com/classic

More ideas online:
Weitere Ideen online:
Plus d'idées en ligne :
Más ideas en Internet:
Mais ideias online:
Online még több ötletet találsz:
更多在线构思:
LEGO.com/classic



LEGO CLASSIC



10692



10693



10694



10696

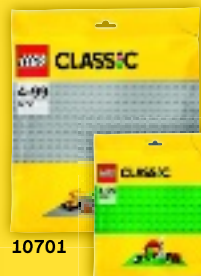

10701

10700

LEGO CREATOR



31030



31031



31032



31033

3 IN 1

LEGO.com/creator



4x
300301



4x
301001



4x
300101



4x
300901



10x
306201



4x
614301



6x
4547489



2x
4500469



2x
6029156



2x
6099548



4x
300521



4x
300421



4x
300121



2x
300921



2x
6036408



4x
306221



2x
6056297



4x
614321



2x
4121934



4x
303921



2x
4500462



4x
4521852



4x
300223



4x
300123



4x
614323



2x
4651236



2x
366523



2x
621523



4x
300424



4x
300124



2x
303924



4x
300326



2x
4181144



4x
306226



2x
428626



2x
306541



2x
306544



2x
306548



4x
300328



3x
4109674



2x
4181135



3x
4546705



8x
4121969



5x
621528



2x
4160395



4x
4529679



4x
4164022



4x
4165967



4x
6073026



4x
4121739



4x
4153826



4x
4118828



1x
4654448



4x
4249891



4x
4296785



8x
4264569



6x
4153653



2x
6025375



4x
6055222



6x
4504375



2x
6089268



4x
4541526



4x
4262655



4x
6061560



4x
6003003



2x
6023157



2x
4216615



4x
4211183



4x
4211166



2x
6035291



4x
4211221



6x
4211149



8x
4211526



2x
4568637



5x
4211614



2x
4234535



5x
4211436



2x
4211421



4x
4211386



4x
4211636



2x
6036851



7x
6004943



4x
4529240



Customer Service

Kundenservice

Service Consommateurs

Servicio Al Consumidor

LEGO.com/service or dial



: 00800 5346 5555

: 1-800-422-5346

WIN

GO TO WWW.LEGO.COM/PRODUCTFEEDBACK AND
GIVE US YOUR SHORT **FEEDBACK** ABOUT THIS
LEGO® SET FOR A CHANCE TO WIN
A COOL LEGO PRIZE.



LEGO.com/productfeedback

GEWINNE



Erzähle uns auf
www.LEGO.com/productfeedback

etwas über die Erfahrungen, die du mit
diesem LEGO® Set gemacht hast, und
sichere dir die Chance auf einen coolen
LEGO Preis!

GAGNE



Rends-toi sur
www.LEGO.com/productfeedback

et donne-nous quelques commentaires
sur ce produit LEGO® pour avoir une
chance de gagner un prix LEGO !

GANAN



Visita
www.LEGO.com/productfeedback

y envíanos tu opinión acerca de este set
LEGO®. ¡Participarás en el sorteo de un
premio LEGO!

获取奖品



登录
www.LEGO.com/productfeedback

给出关于此乐高®套装的简短反馈，
就有机会获得炫酷乐高奖品