



Mixels™

WUZZO



41547



6126511

1

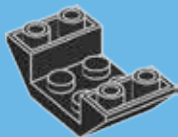

2



3

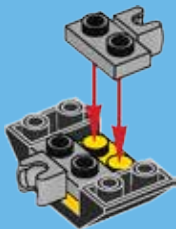

4

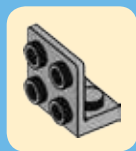

5

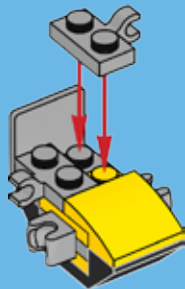

6

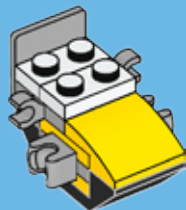



7



8



9

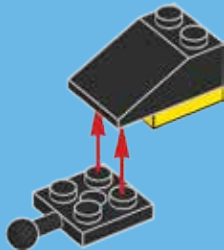

10

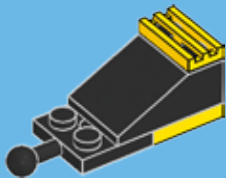

11

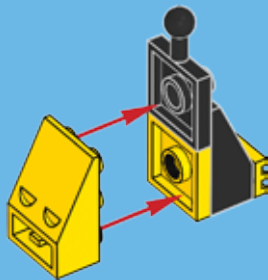

12



2x

13

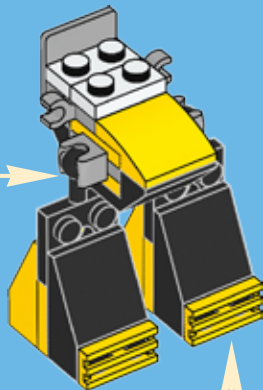

1



2



2x

14

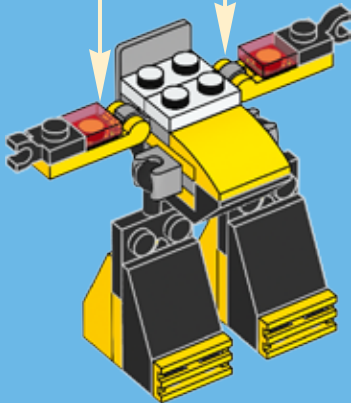

15

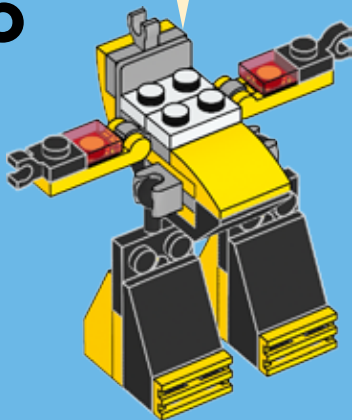



16

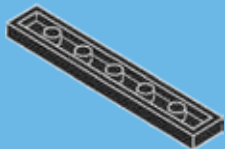

17

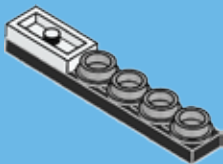

18

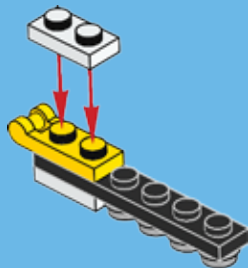

19

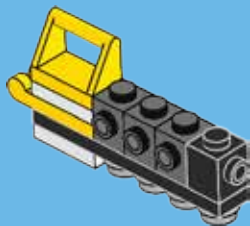

20

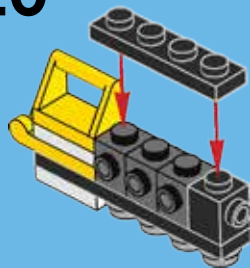

21

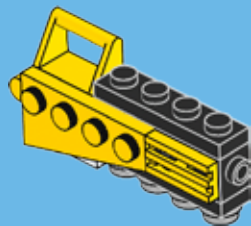

22

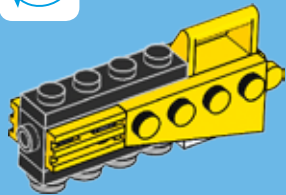

23

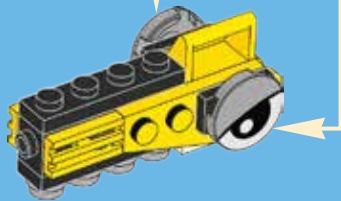

24

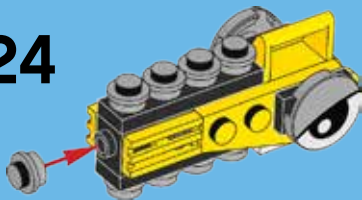

25

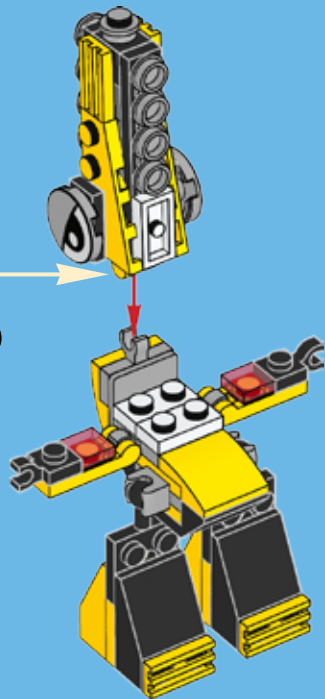



26



27

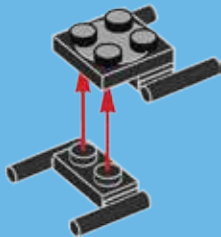

28

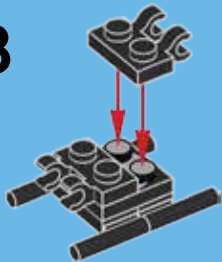

29



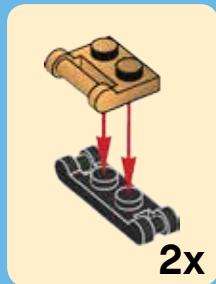

30

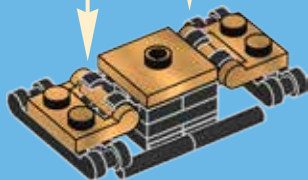



31

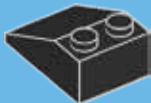

32

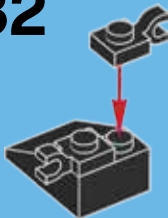

33

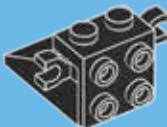

34

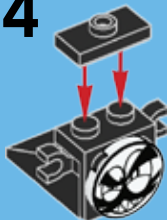

35

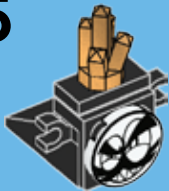

36

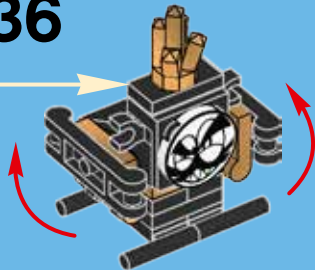



1x
4558954



1x
368026



1x
243224



4x
241224



3x
4213574



2x
3003941



4x
4517925



2x
6099483



3x
4515367



4x
302224



4x
302301



1x
6107193



3x
6092585



1x
371026



2x
6079007



2x
6043656



1x
6097124



2x
4585493



2x
4556158



1x
366626



2x
374724



3x
6028812



2x
6100970



1x
4516816



2x
6051038



1x
4188534



1x
4161331



9x
4211525



1x
6117973



3x
329826



1x
4160868



2x
383926



Customer Service

Kundenservice

Service Consommateurs

Servicio Al Consumidor

LEGO.com/service or dial



: 00800 5346 5555

: 1-800-422-5346



LEGO.com/mixels





**KRAMM
41545**



**FORX
41546**



**WUZZO
41547**



WELDOS MAX!



LEGO.com/mixels





Mixels™



**41545
KRAMM**



**41546
FORX**



**41547
WUZZO**



**41548
DRIBBAL**



**41549
GURGGLE**



**41550
SLUSHO**



**41551
SNAX**



**41552
BERP**



**41553
VAKA-WAKA**



LEGO.com/mixels



Mixels RUSH



**YOU CAN
BUY THE
GAME!**

CH A 1 N S A 8

IN GAME CODE!



Apple, the Apple logo, iPad, iPhone and iPod touch are trademarks of Apple Inc., registered in the U.S. and other countries. App Store is a service mark of Apple Inc. Google Play is a trademark of Google Inc.