



# CITY

60103





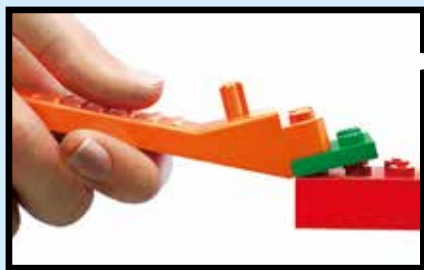

[LEGO.com/brickseparator](https://LEGO.com/brickseparator)

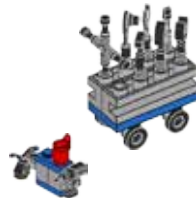



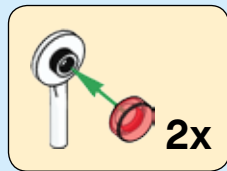
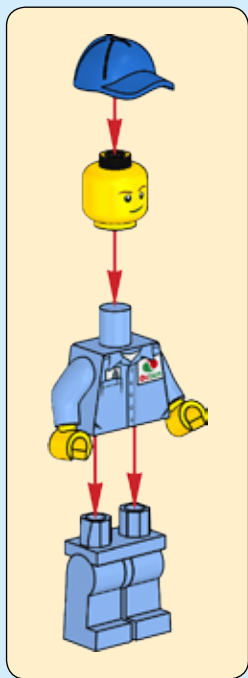



1x

1

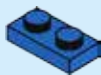

6



2x

2

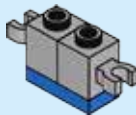



1x

3

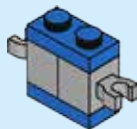

1x

1x



4

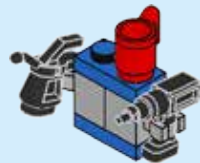



1x

5



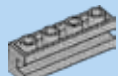

2x

6

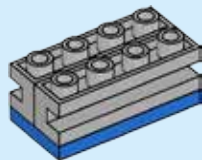

2x

7

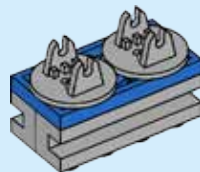
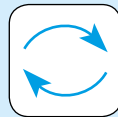



2x

8

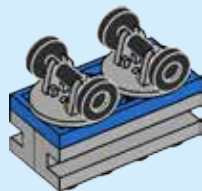



9

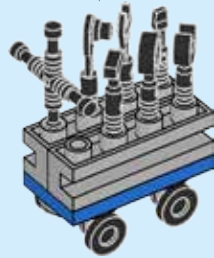
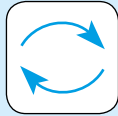
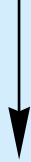

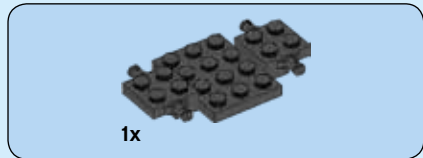

10

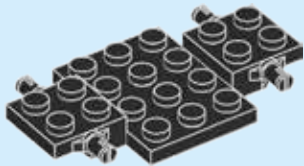



2x

# 11

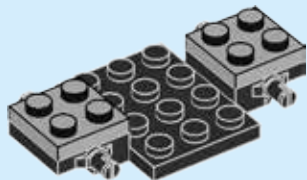

1x

# 12

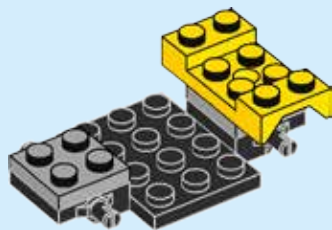



1x



2x

# 13

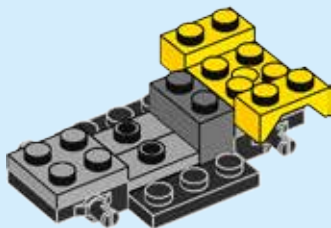



2x

# 14

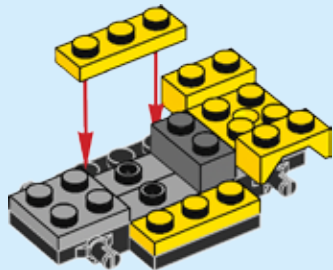

2x



2x

# 15

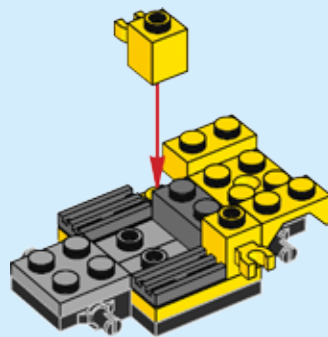



1x

# 16

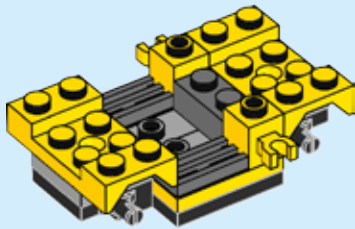



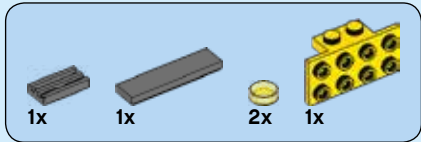

# 17

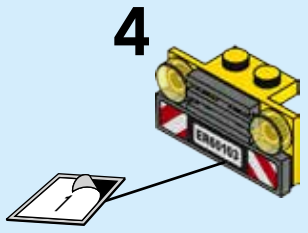
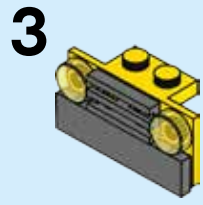
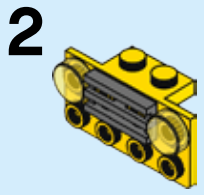
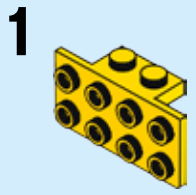

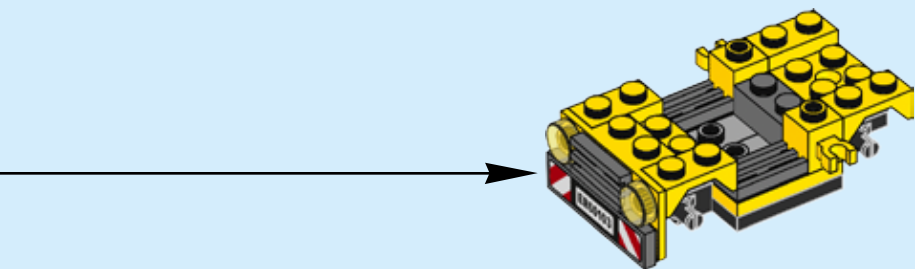



1x

# 18

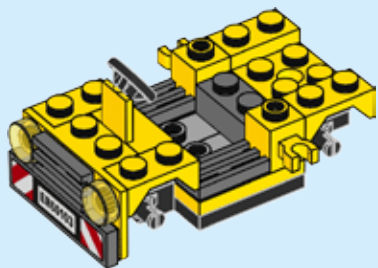

2x

# 19

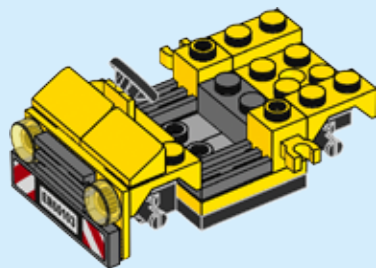



1x

# 20

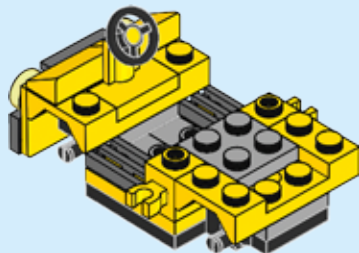

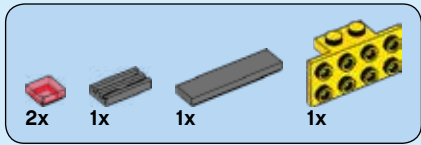

# 21

1



2



3

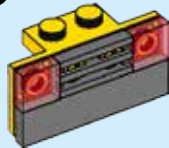

4

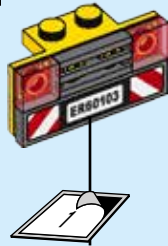

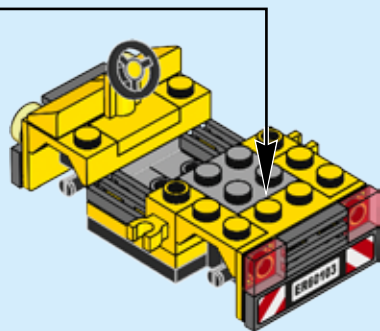





1x

# 22

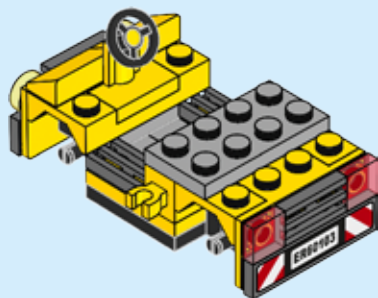

2x

# 23

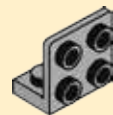

2x

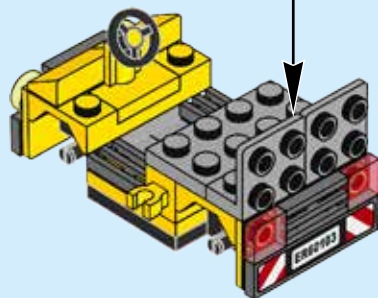



1x

# 24

1

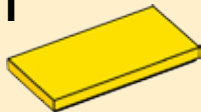

2

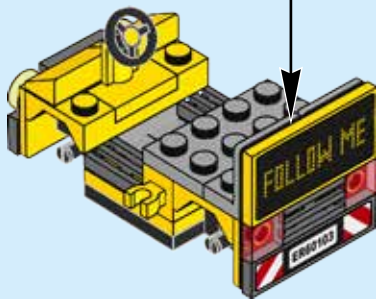
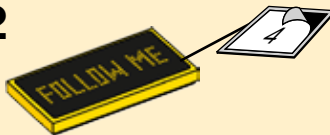

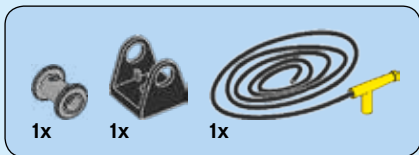

**25**

**1**



**2**

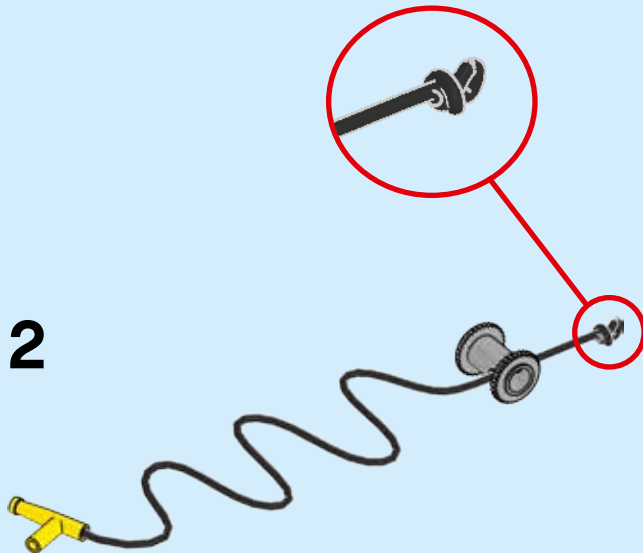

3



4

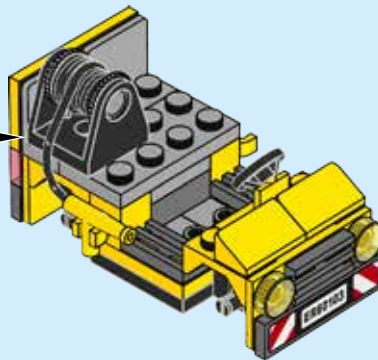
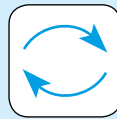

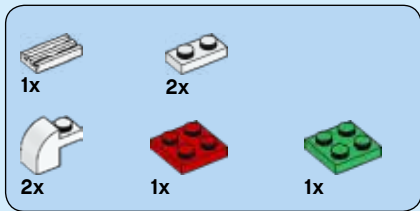

26

1

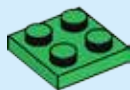

2



3

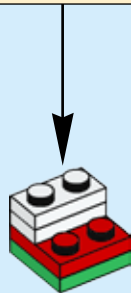
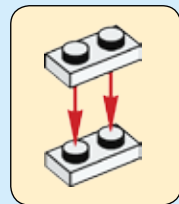

4



5

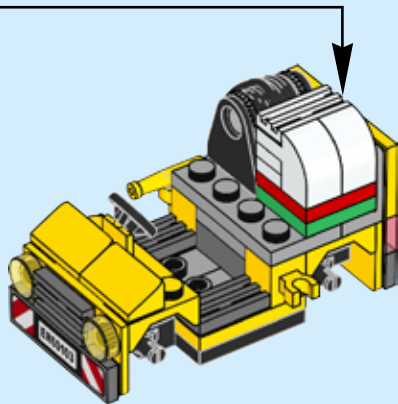
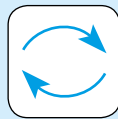
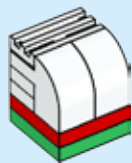





27

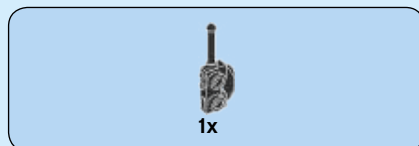
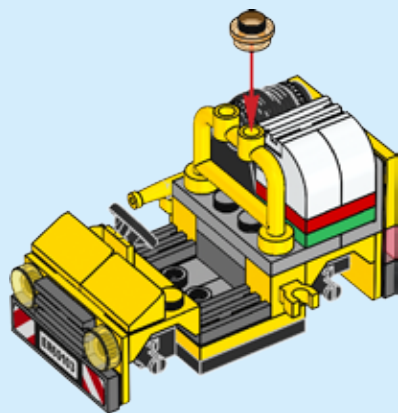

28

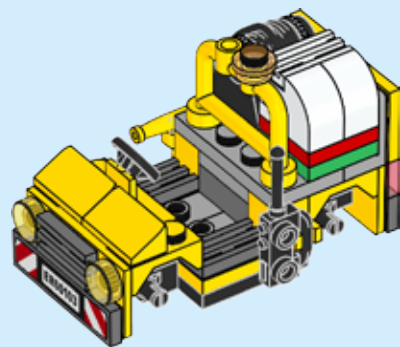



4x



4x

# 29

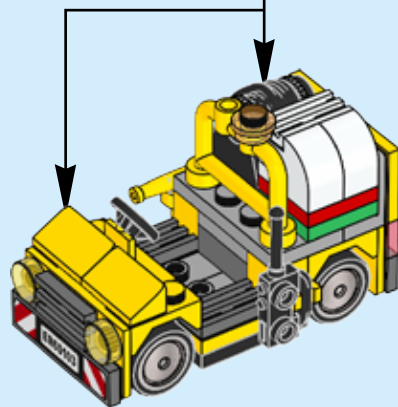
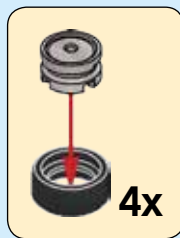

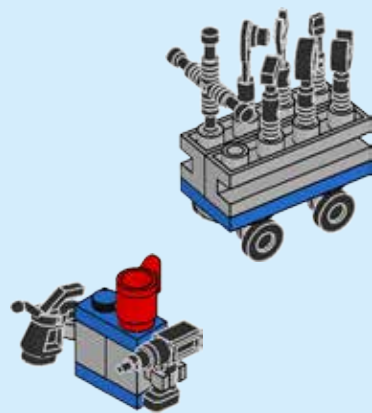
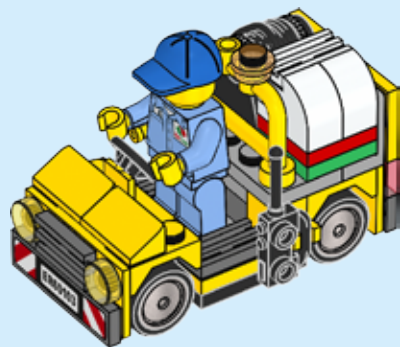



# CITY

60103



[LEGO.com/city](http://LEGO.com/city)

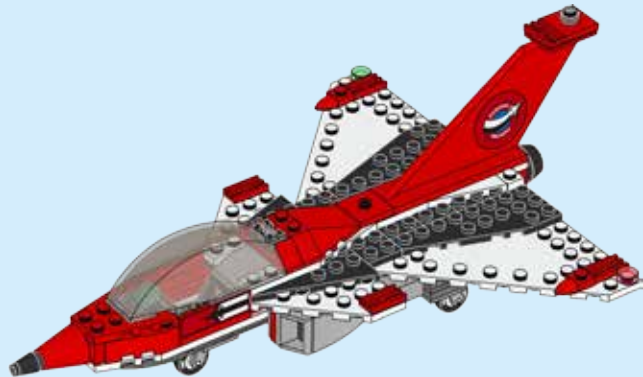
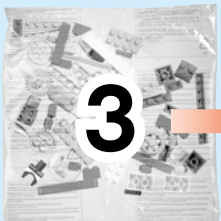
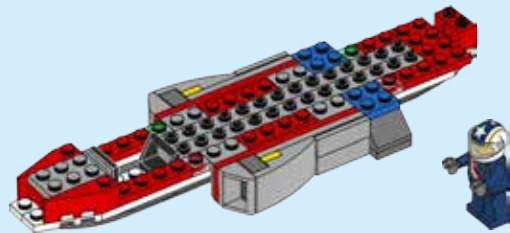
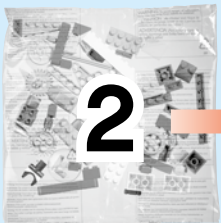

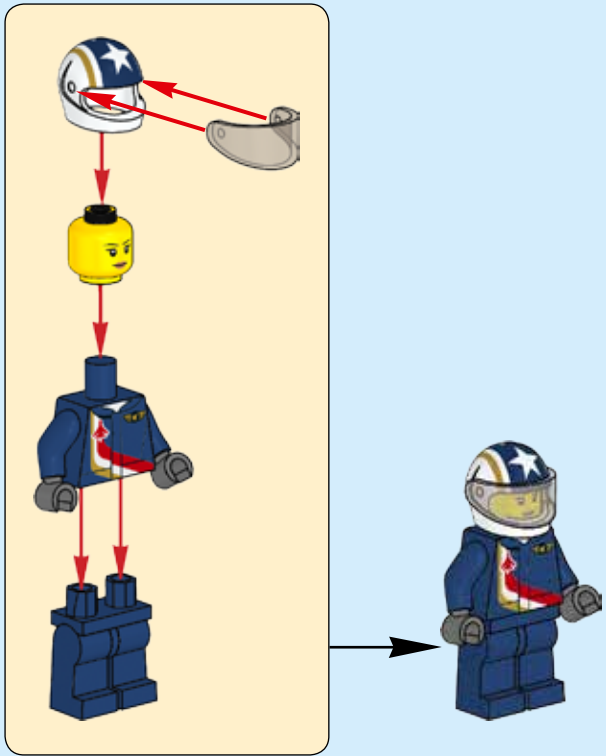
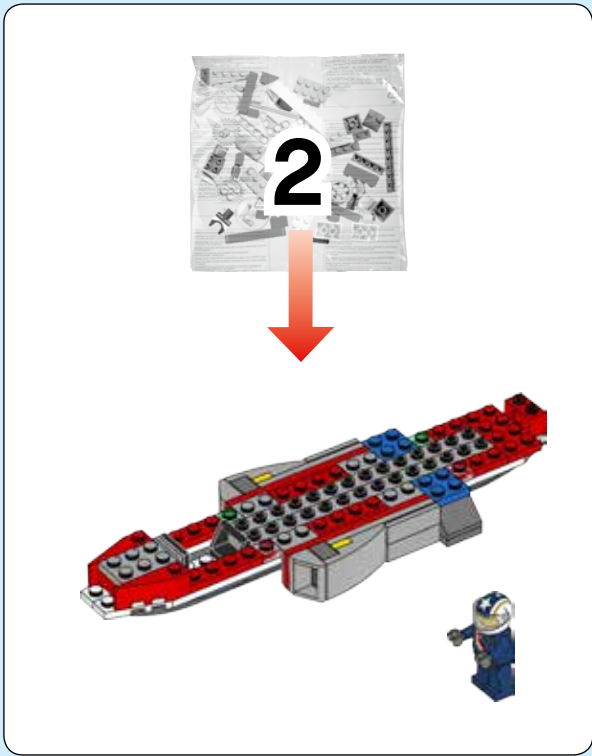

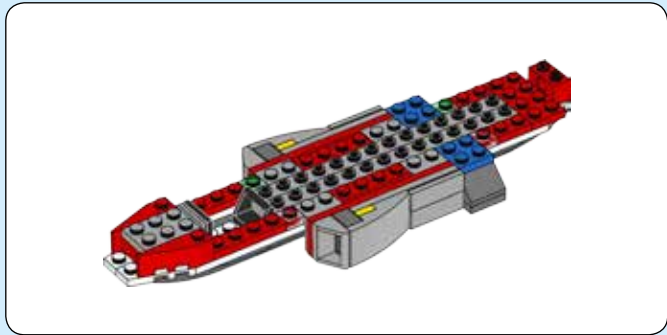

**1**

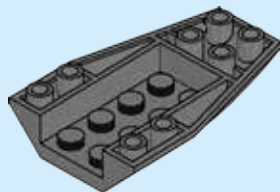



1x

2

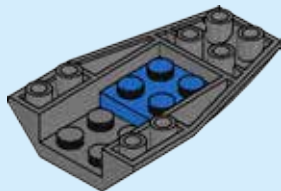

1x



1x

3

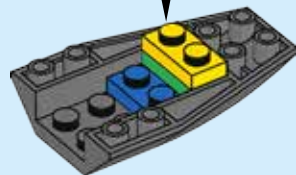
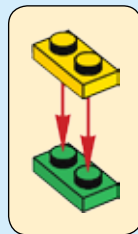



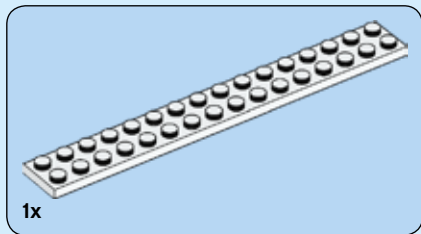

4

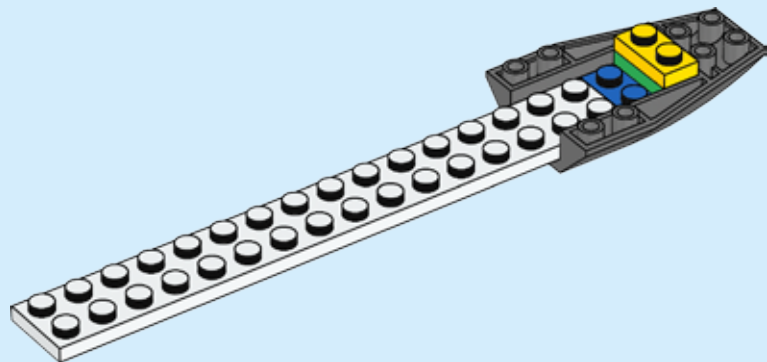

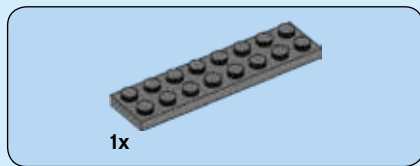

5

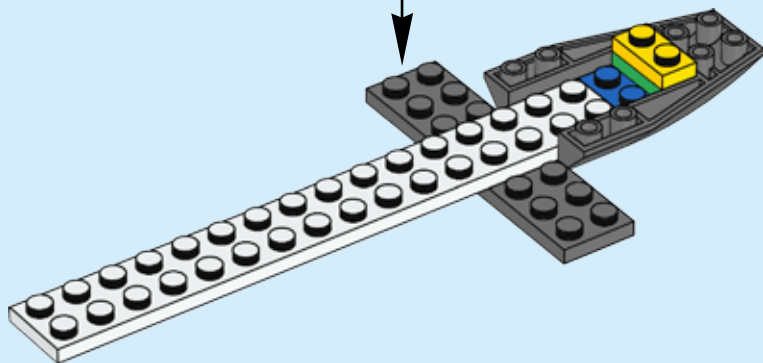
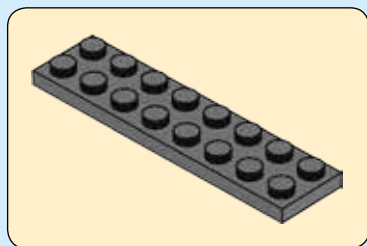



6

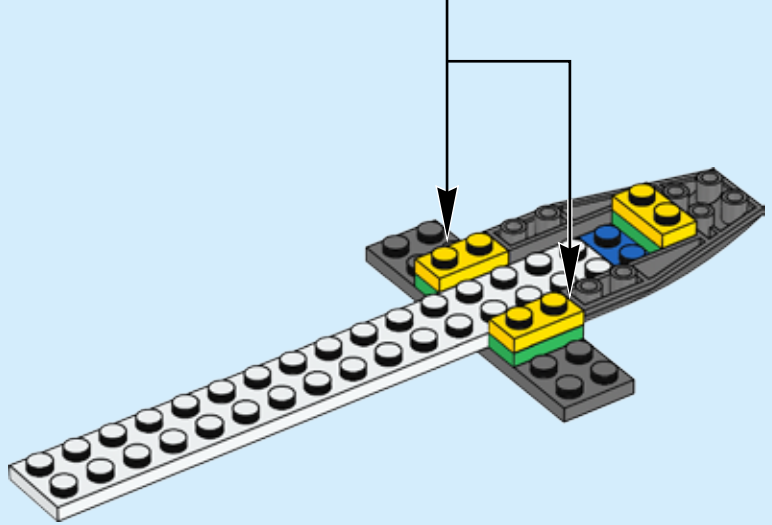
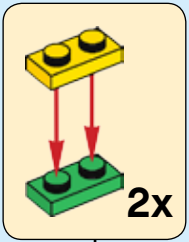

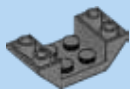

1x

7

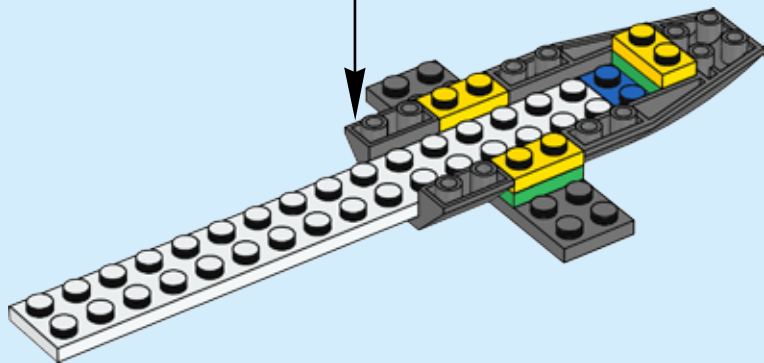
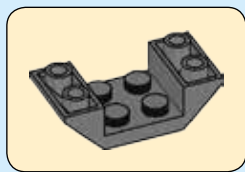

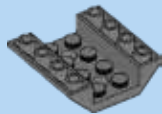

2x

8

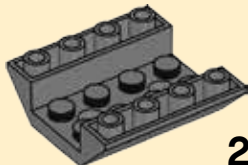

2x

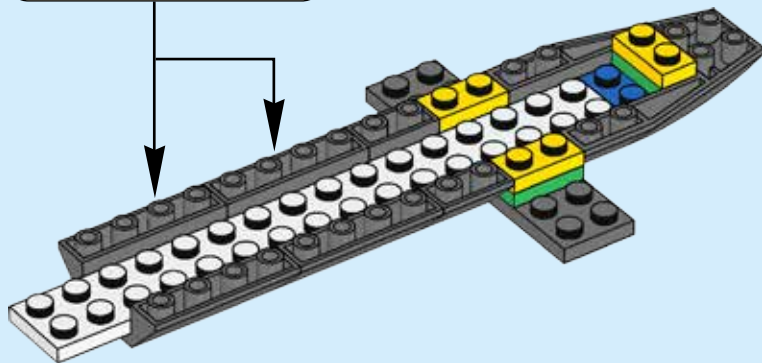



9

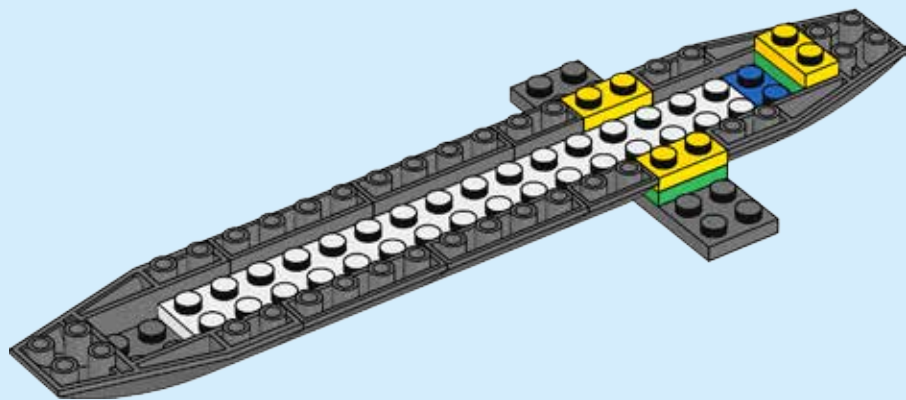



1x

# 10

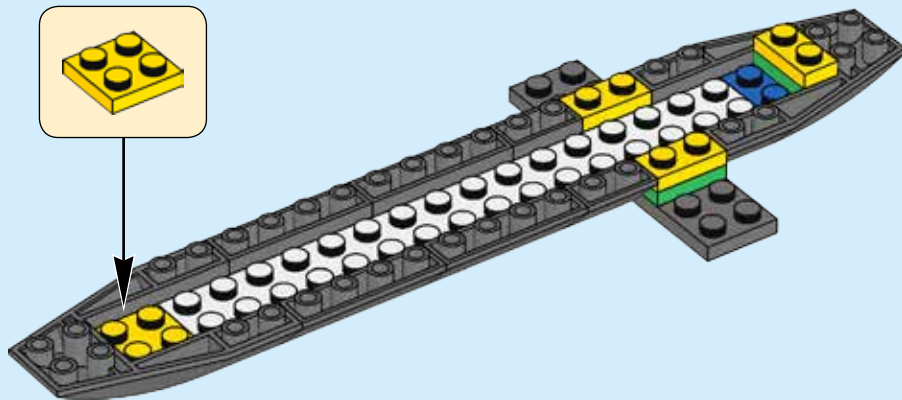



1x

# 11

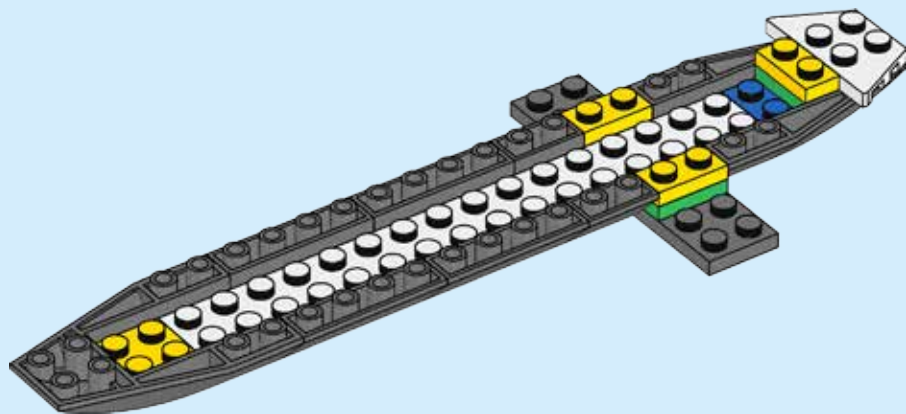



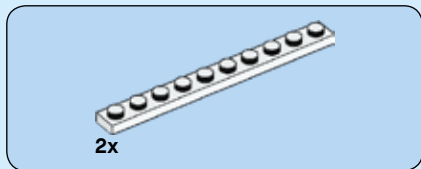

12

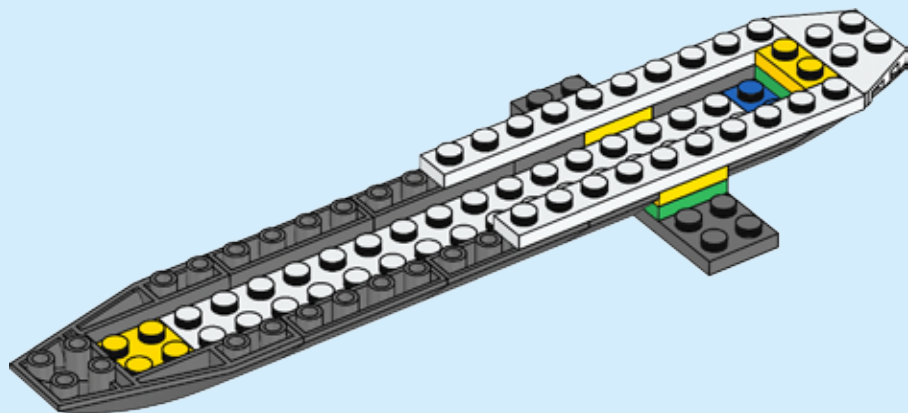



2x

# 13

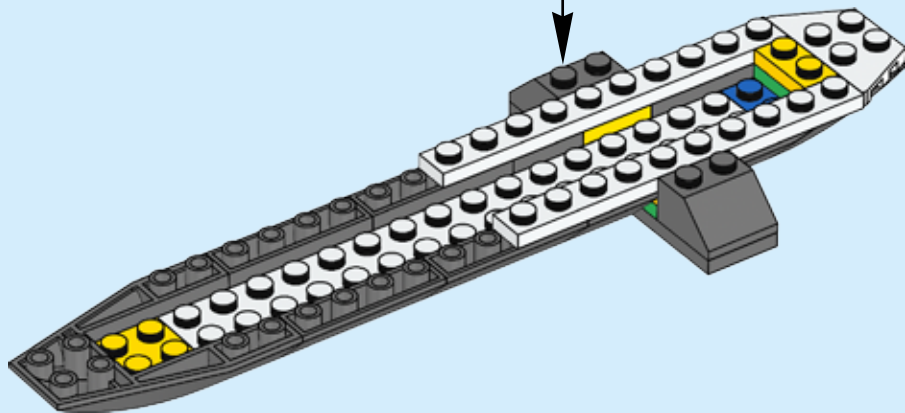
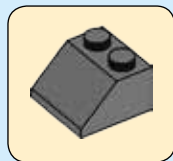

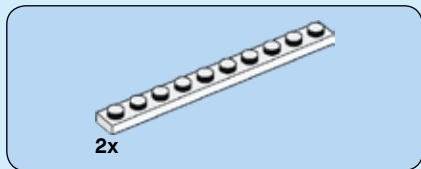

14

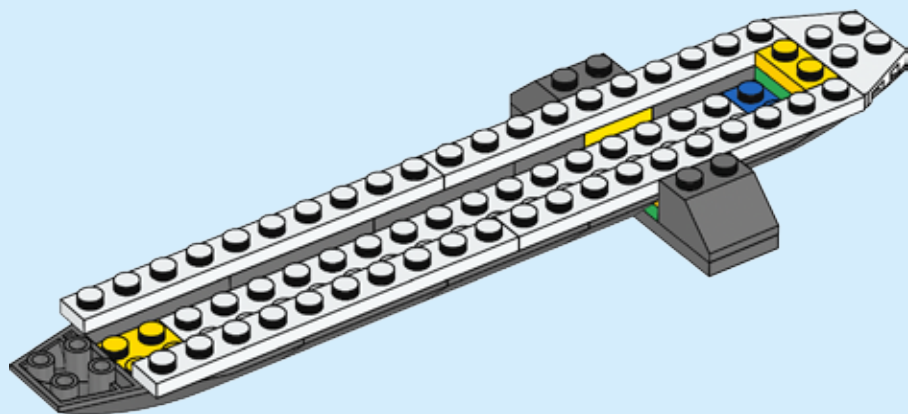



1x

# 15

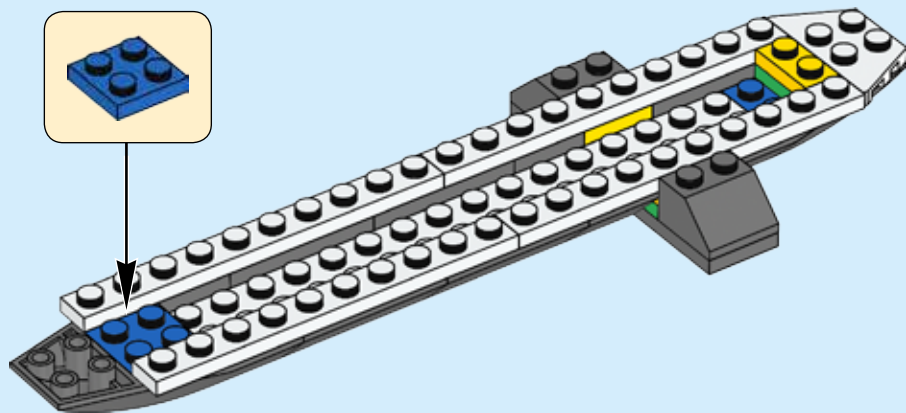



1x



1x

# 16

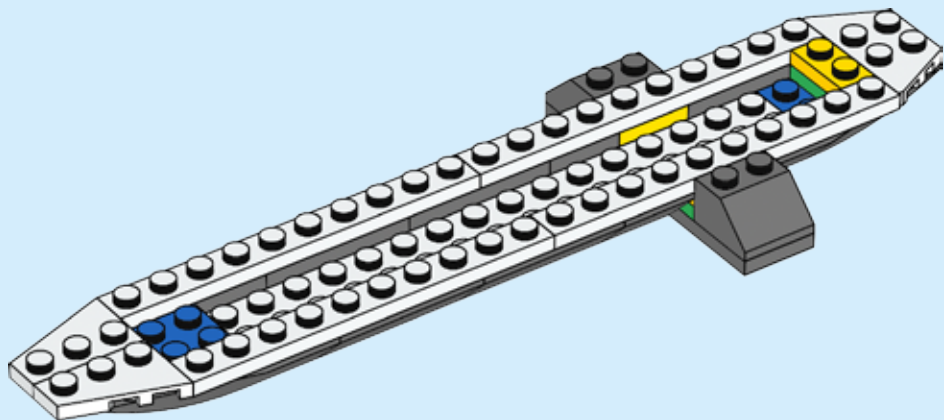

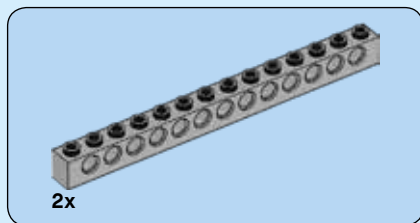

17

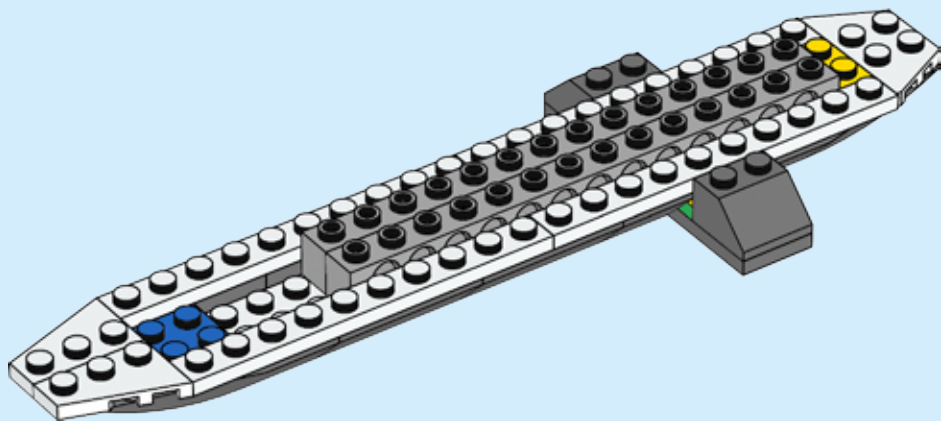



1x



1x

# 18

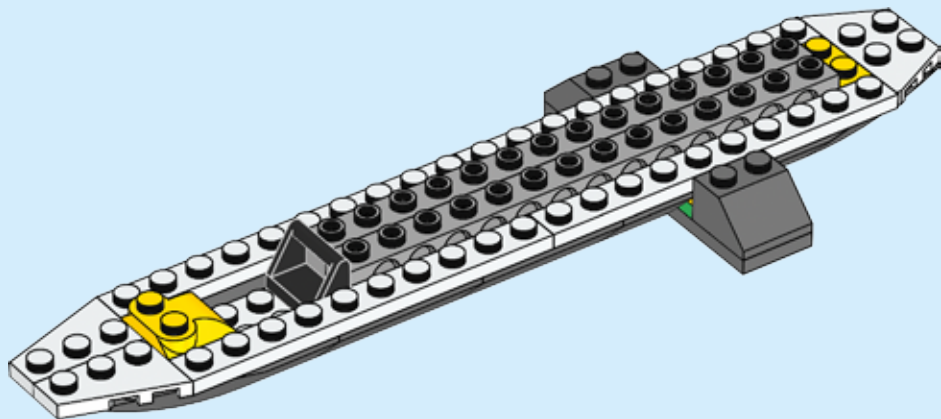



# 19

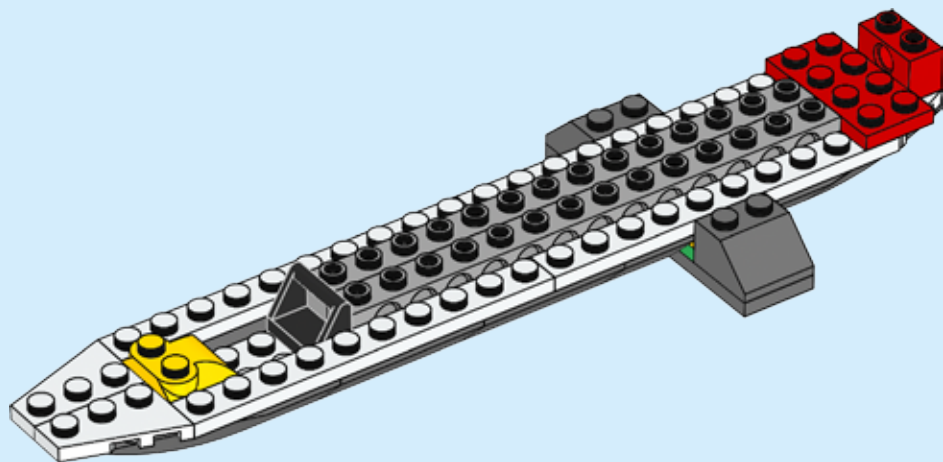





2x



1x



1x

# 20

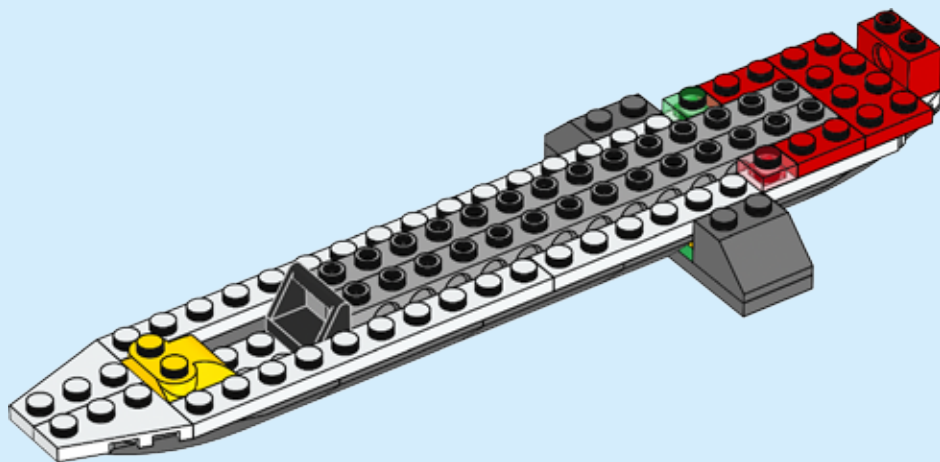



2x

# 21

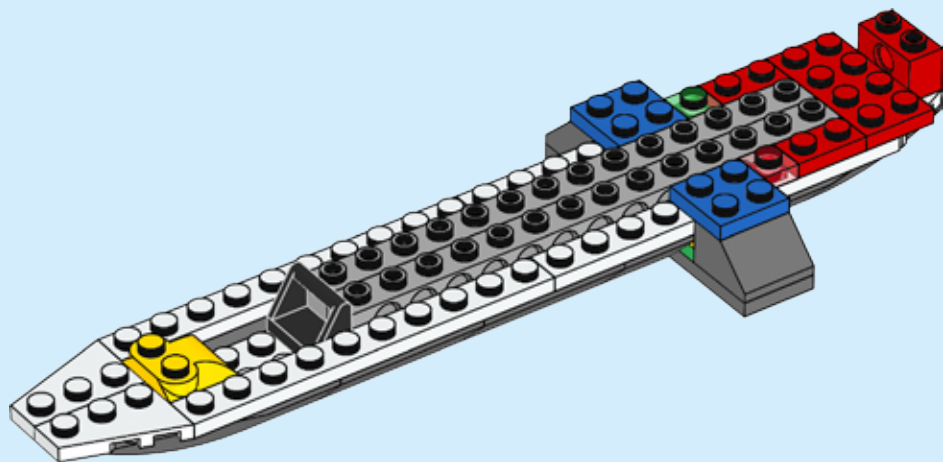



2x

# 22

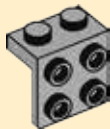

2x

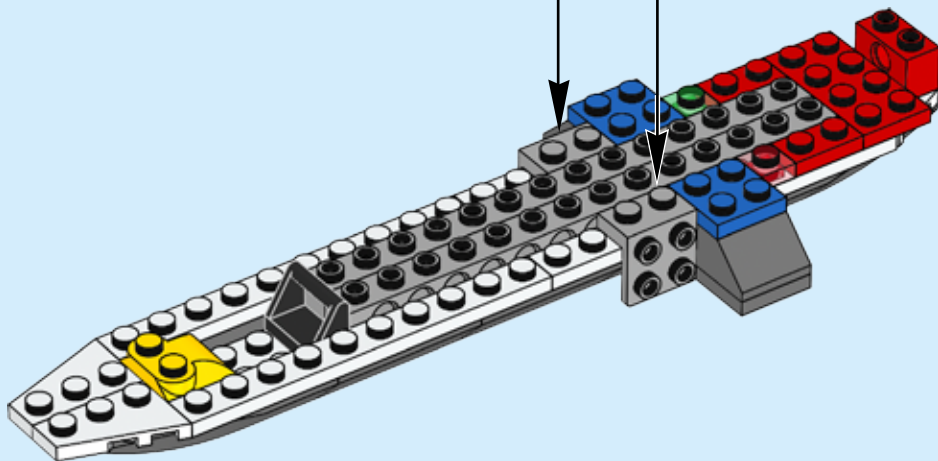



2x

# 23

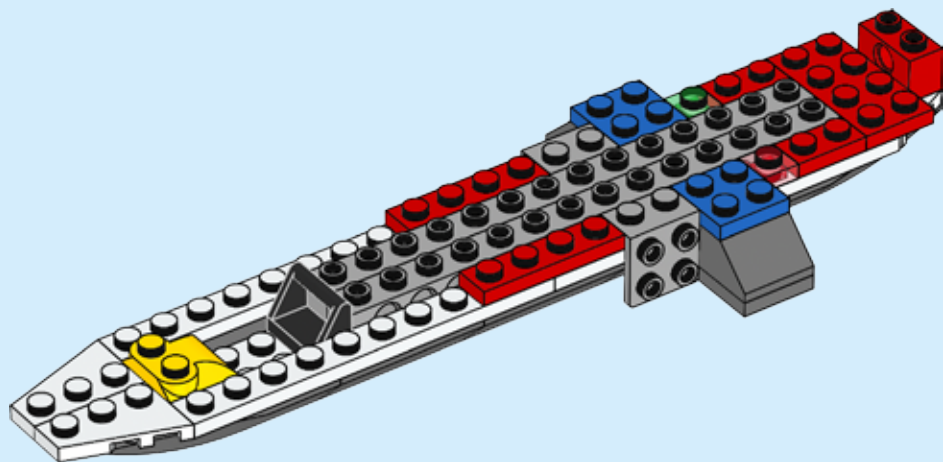



2x

# 24

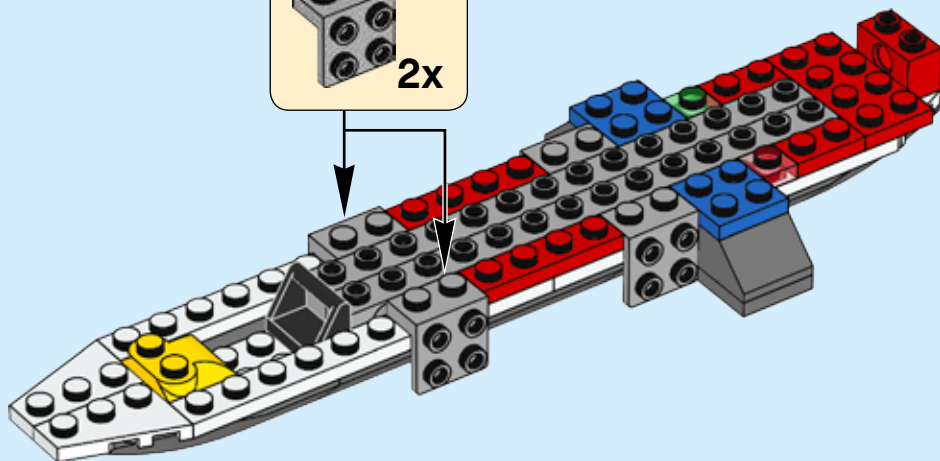
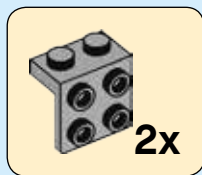



2x



1x



1x

# 25

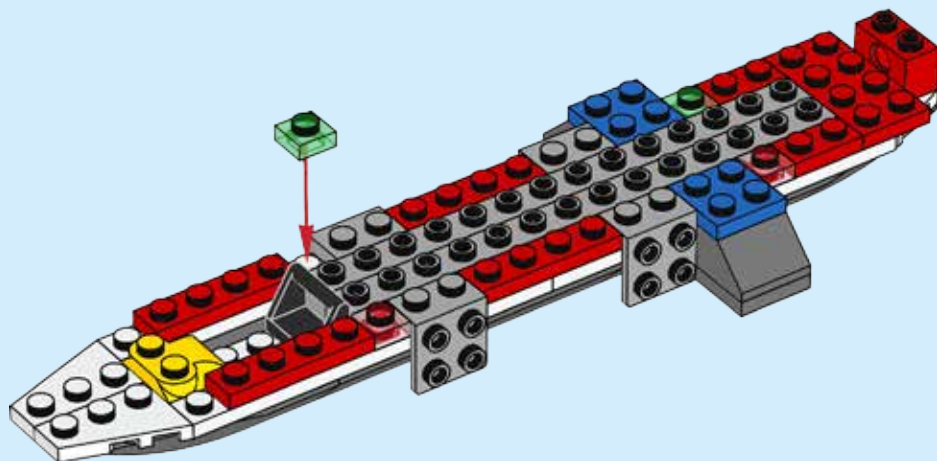



1x



1x

# 26

1

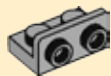

2

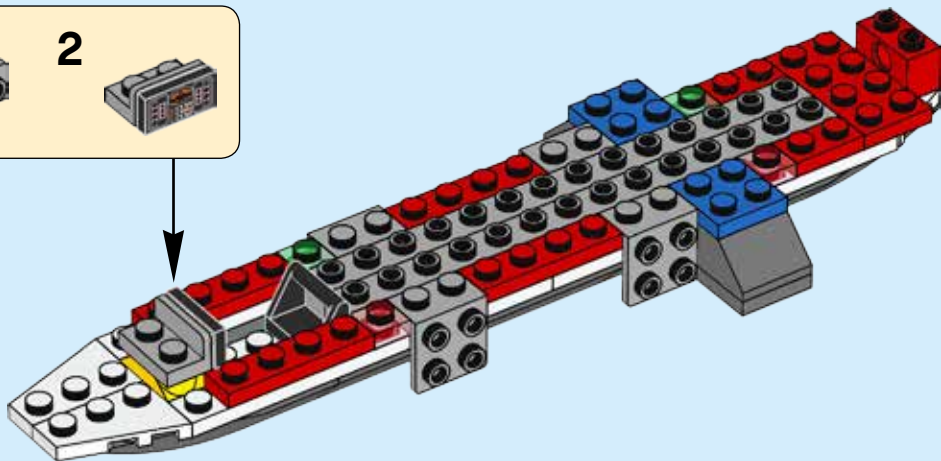



1x

27

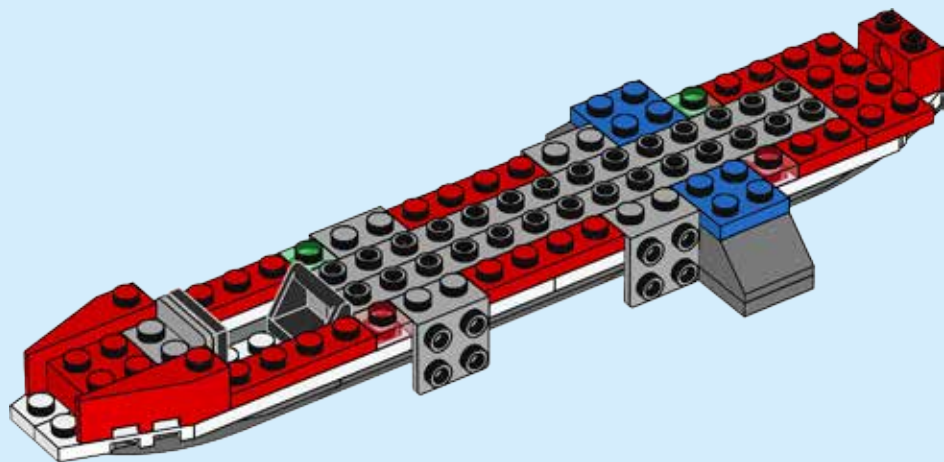





1x

# 28

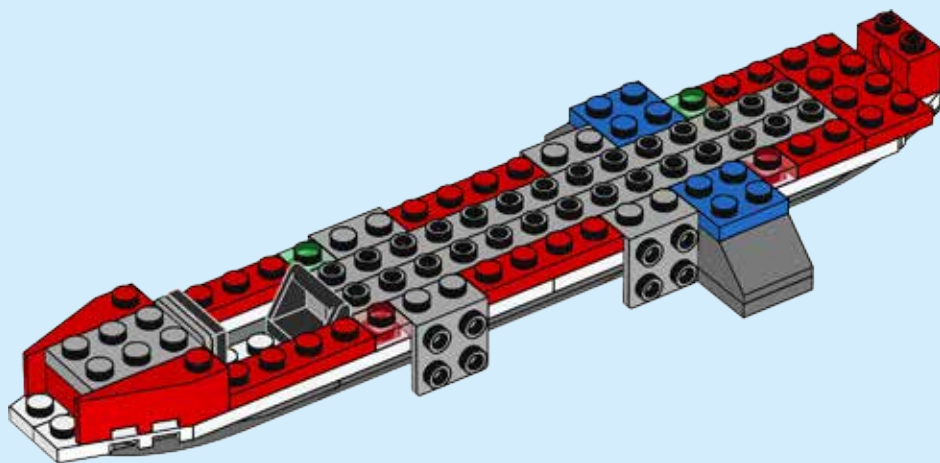

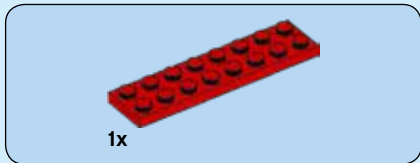

29

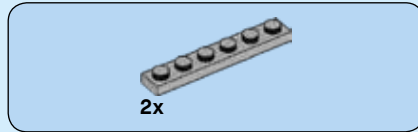
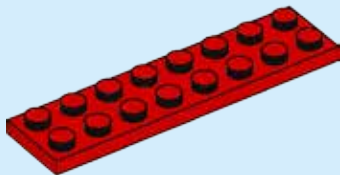

30

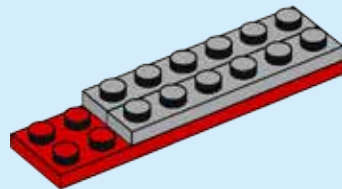



1x



2x

# 31

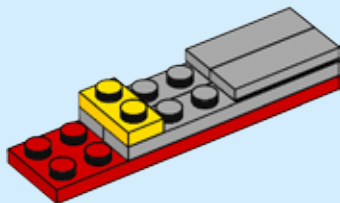

32



1x

32

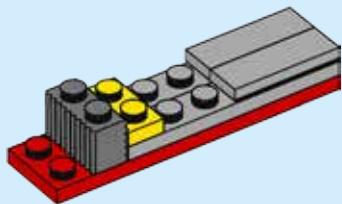

1x

33

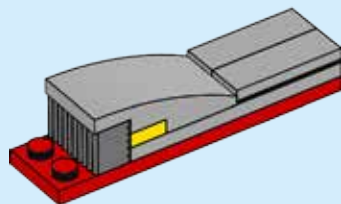



1x

34

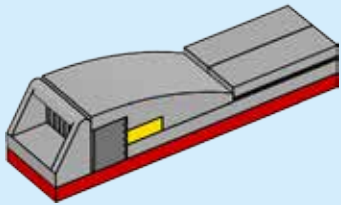

2x

35

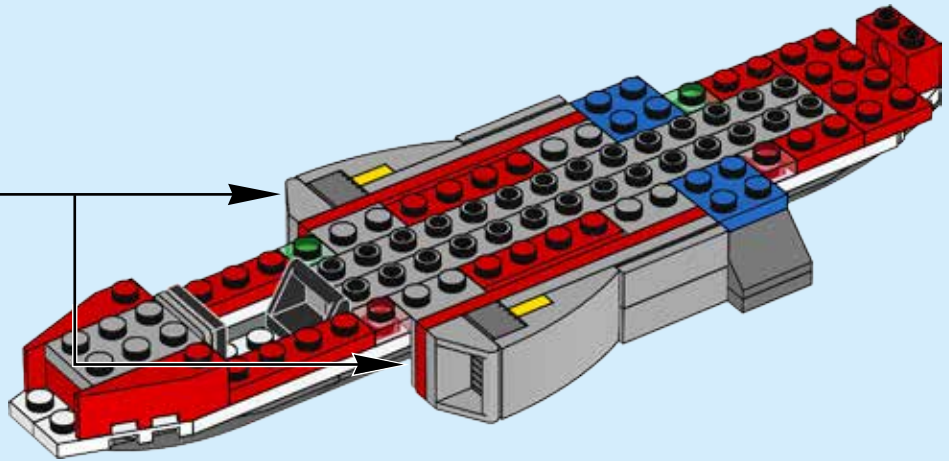

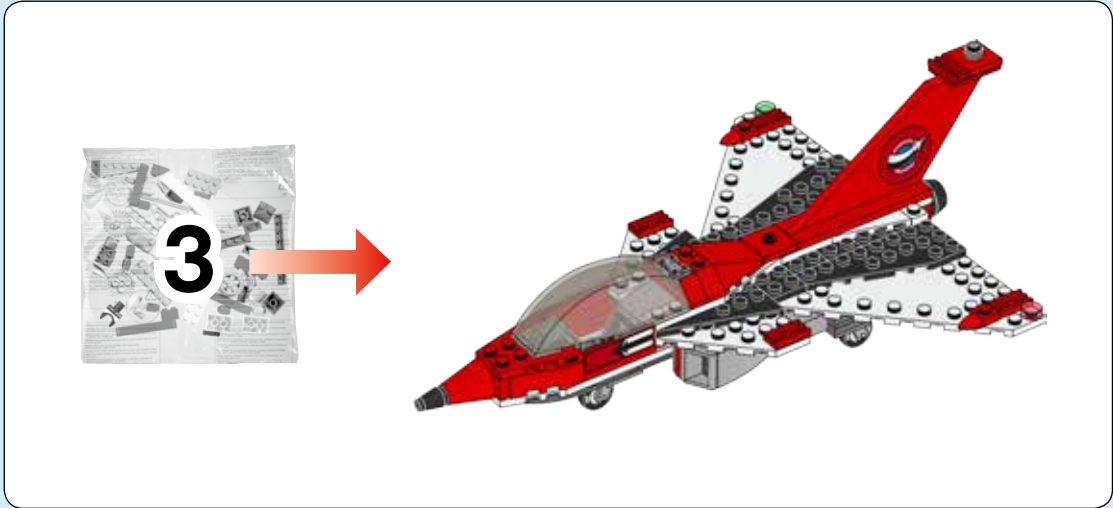

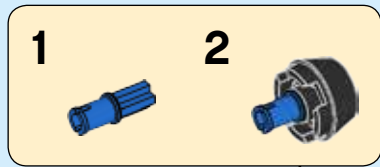

36

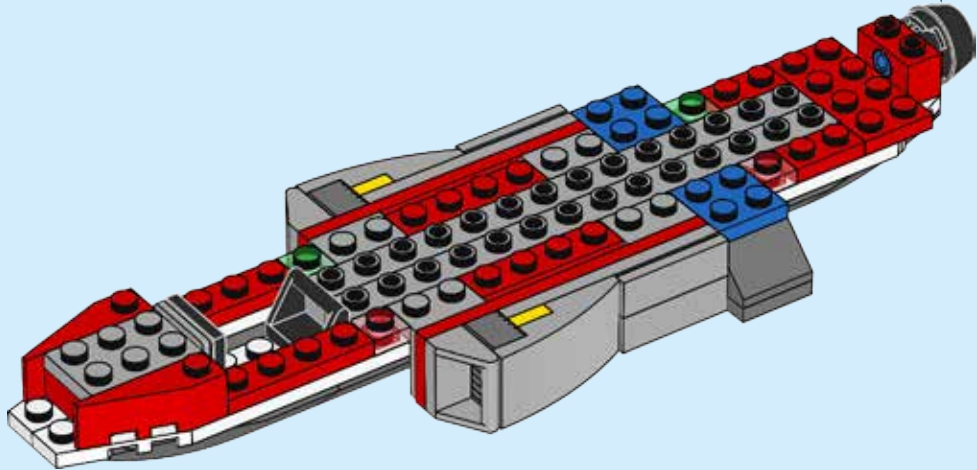

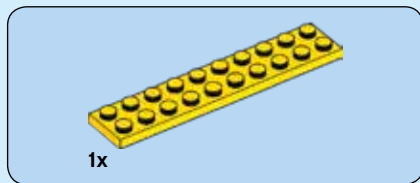

37

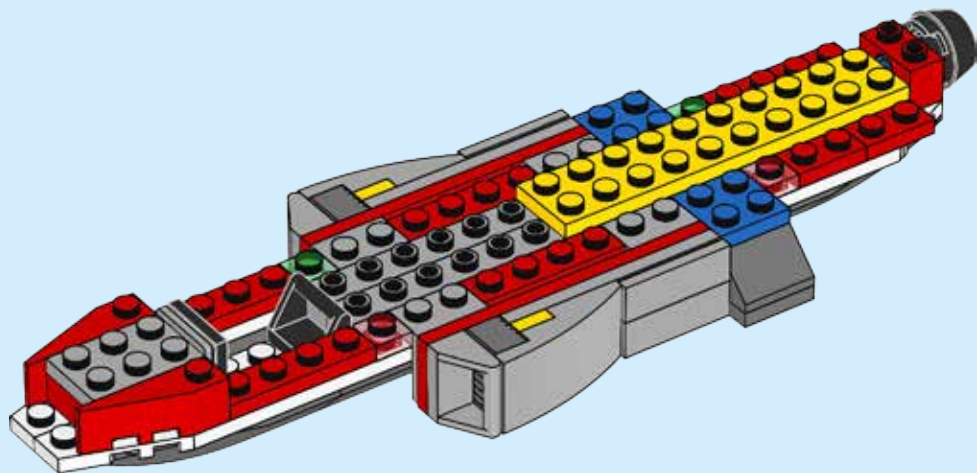



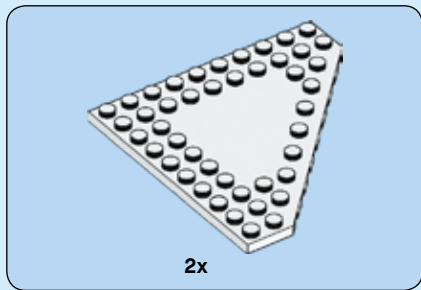

38

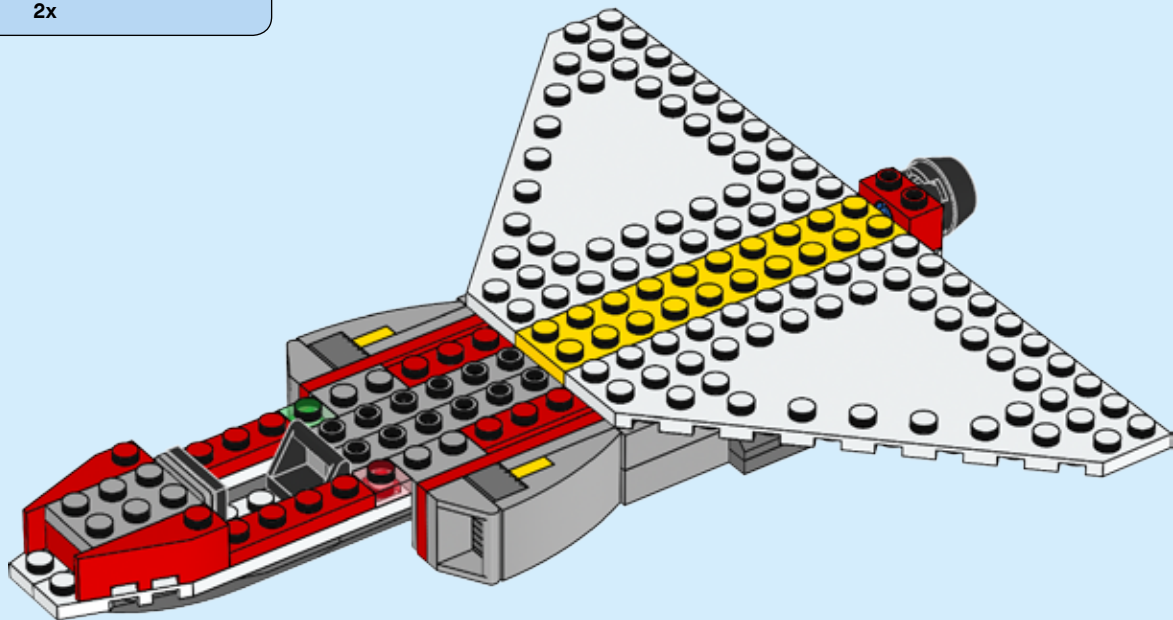

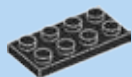

1x

# 39

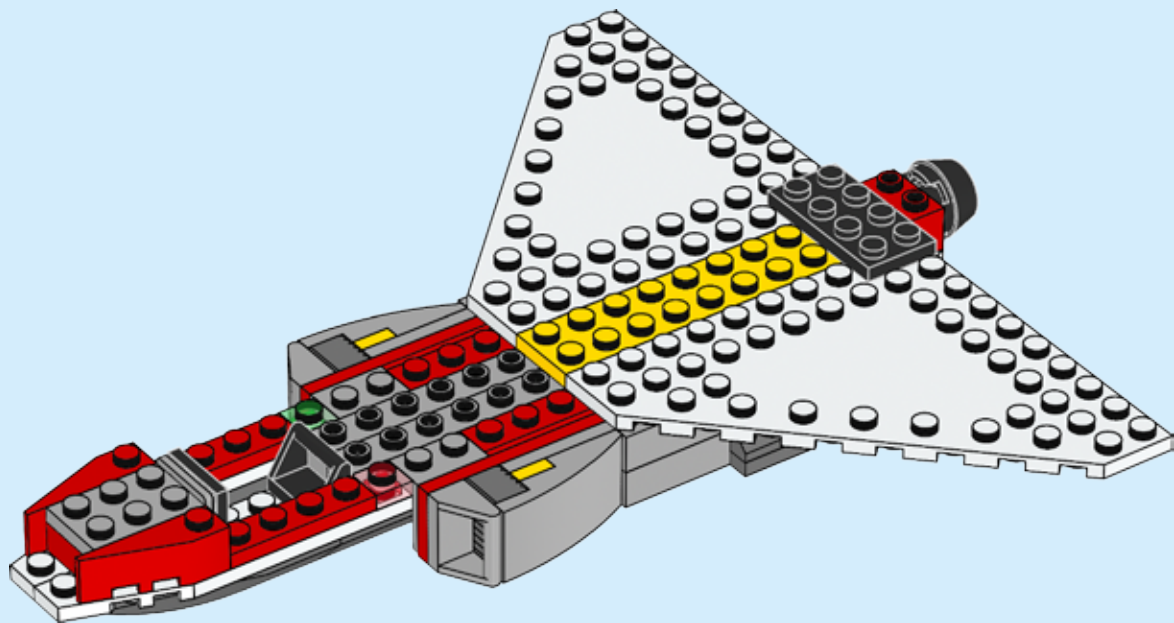

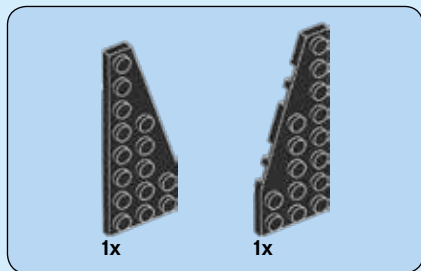

40

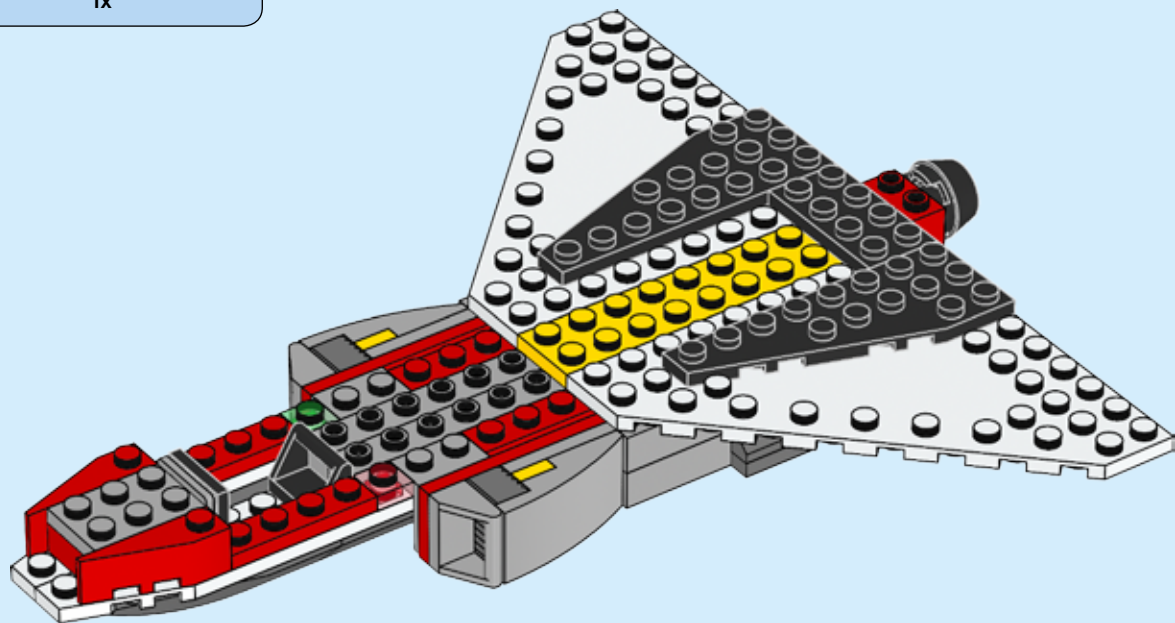

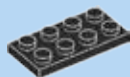

3x

# 41

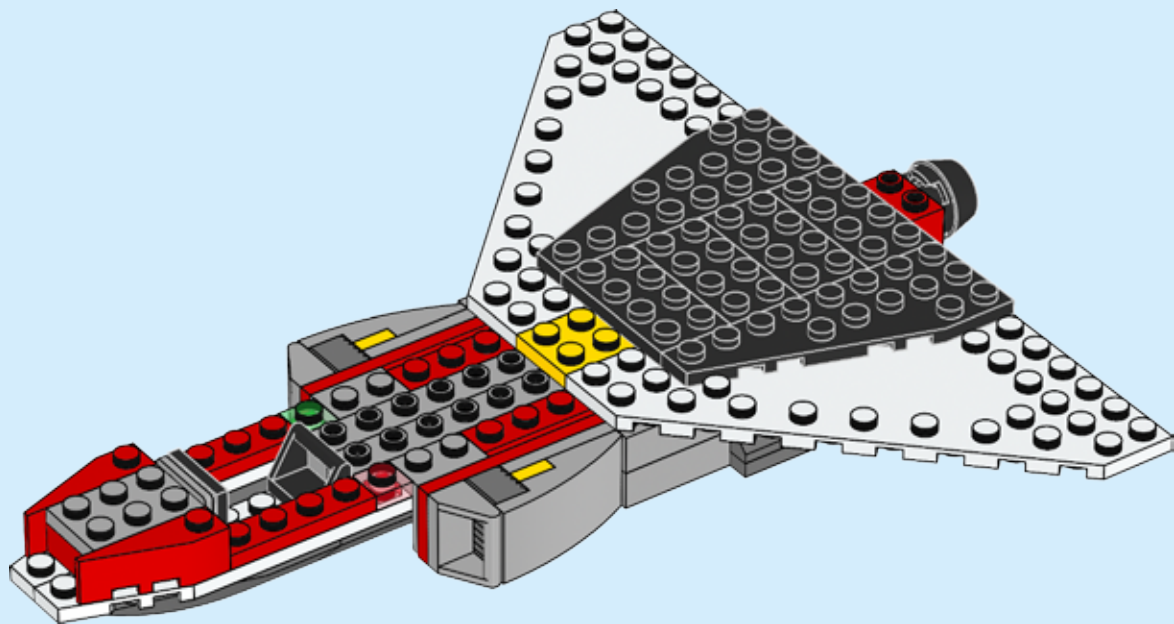



2x

42

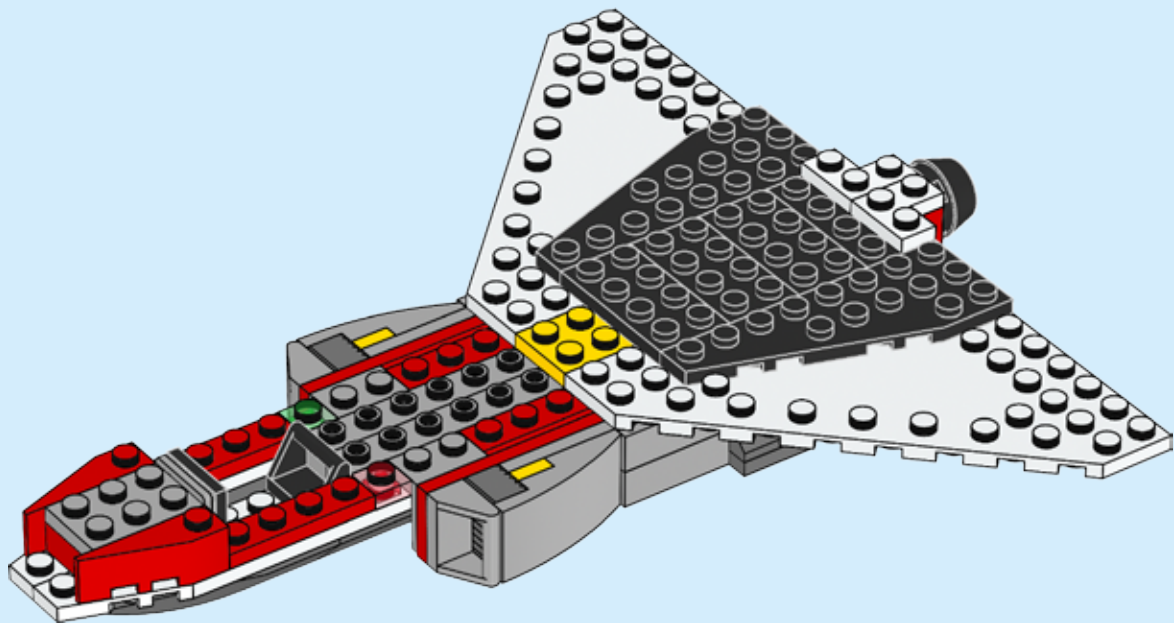

42

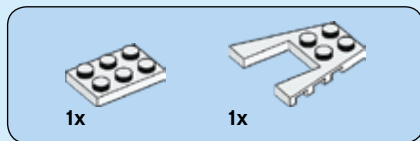

# 43

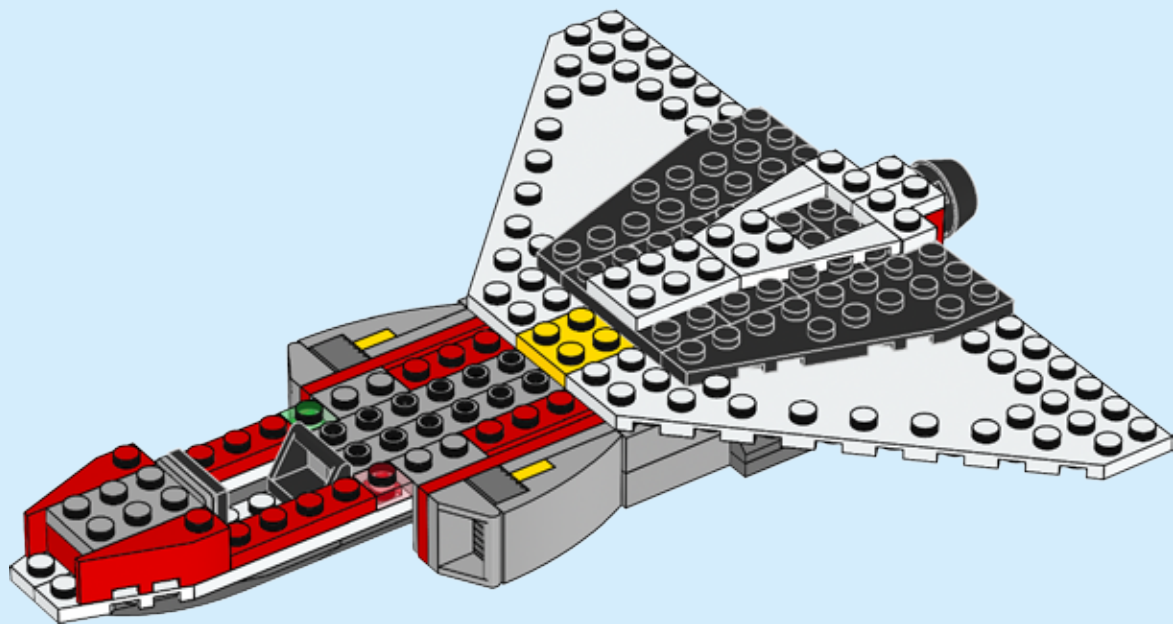



2x

44



2x

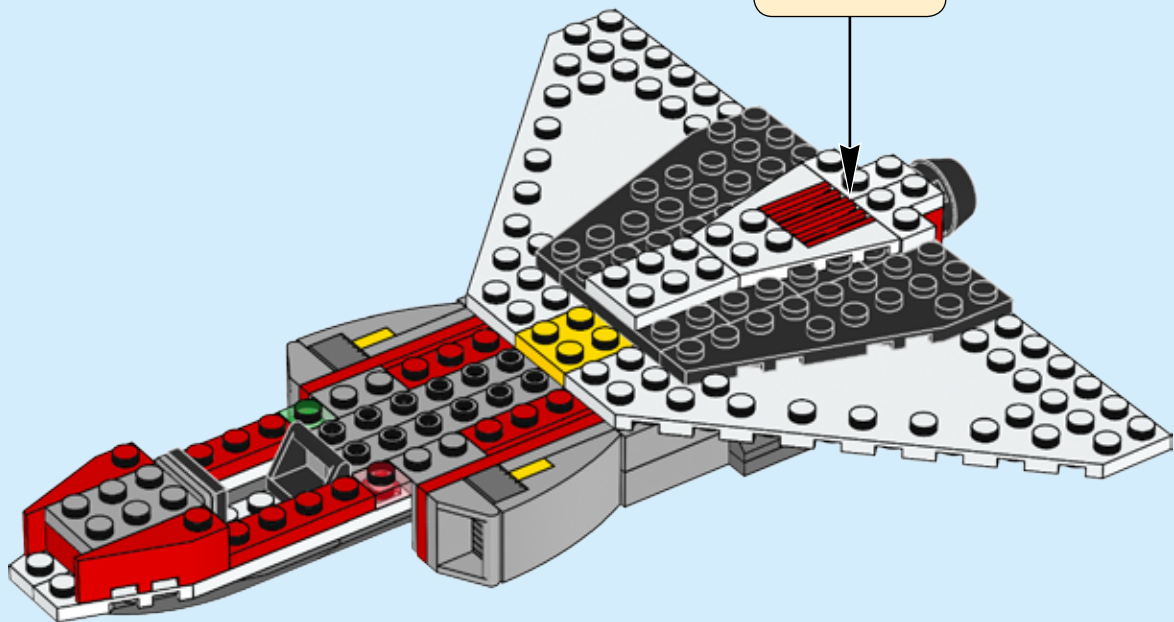

44

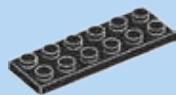

1x

# 45

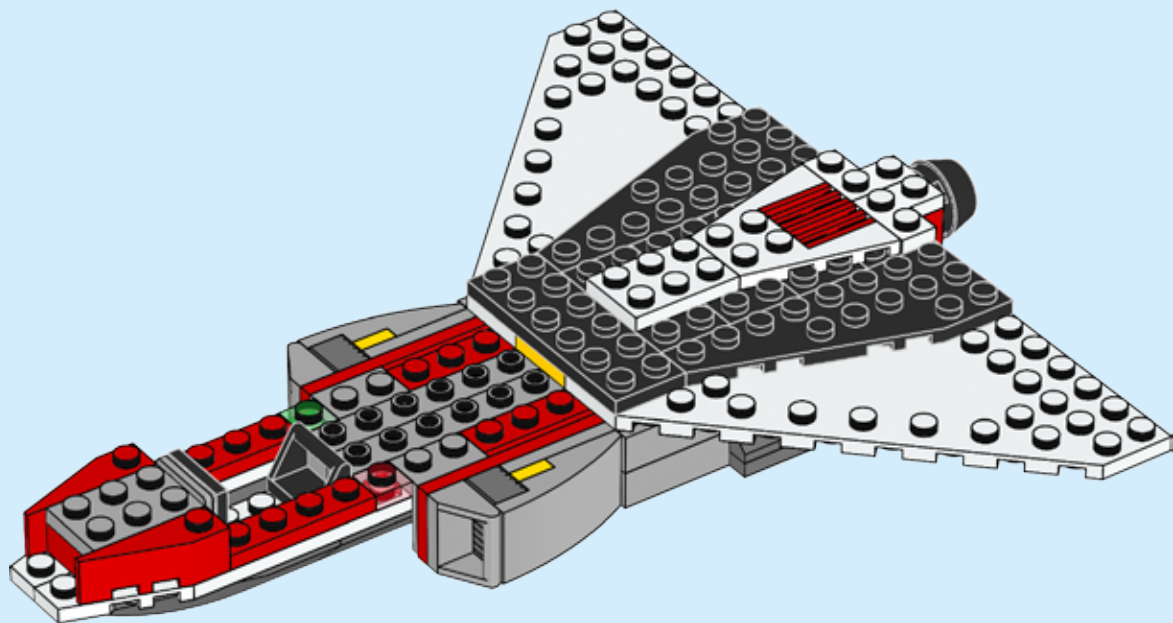





1x



1x



1x

# 46

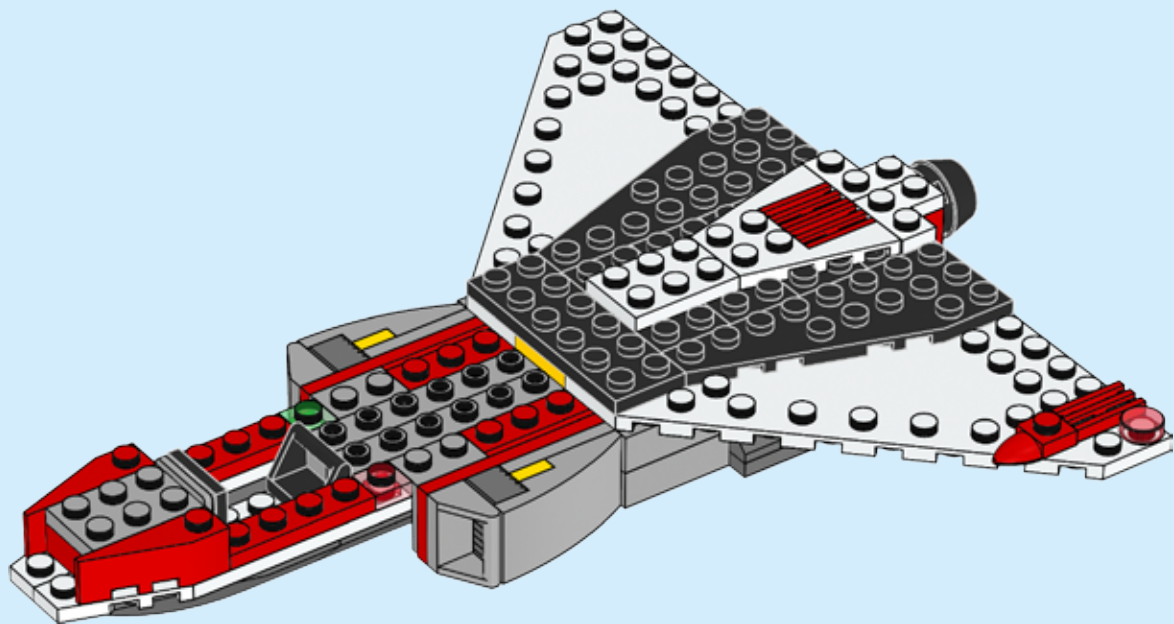



1x



1x



1x

# 47

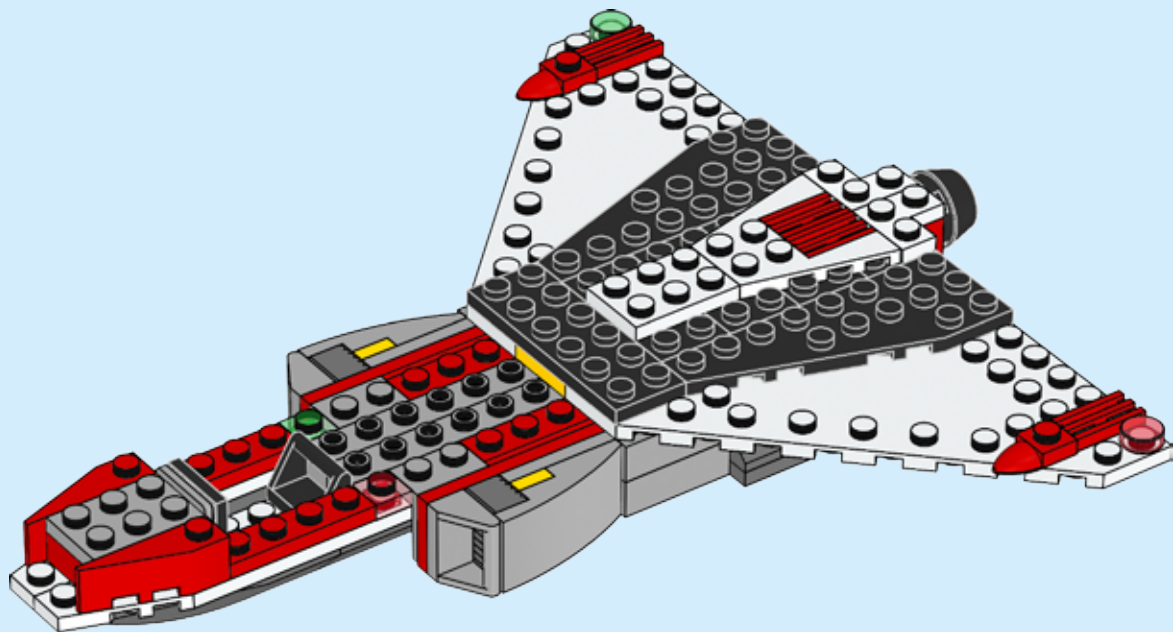



1x

48

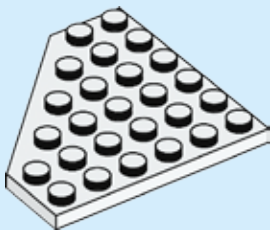



1x



1x

# 49

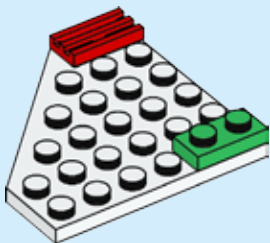

1x

# 50

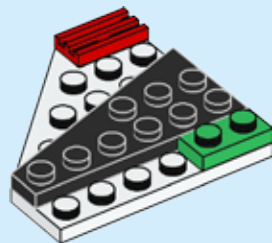

51

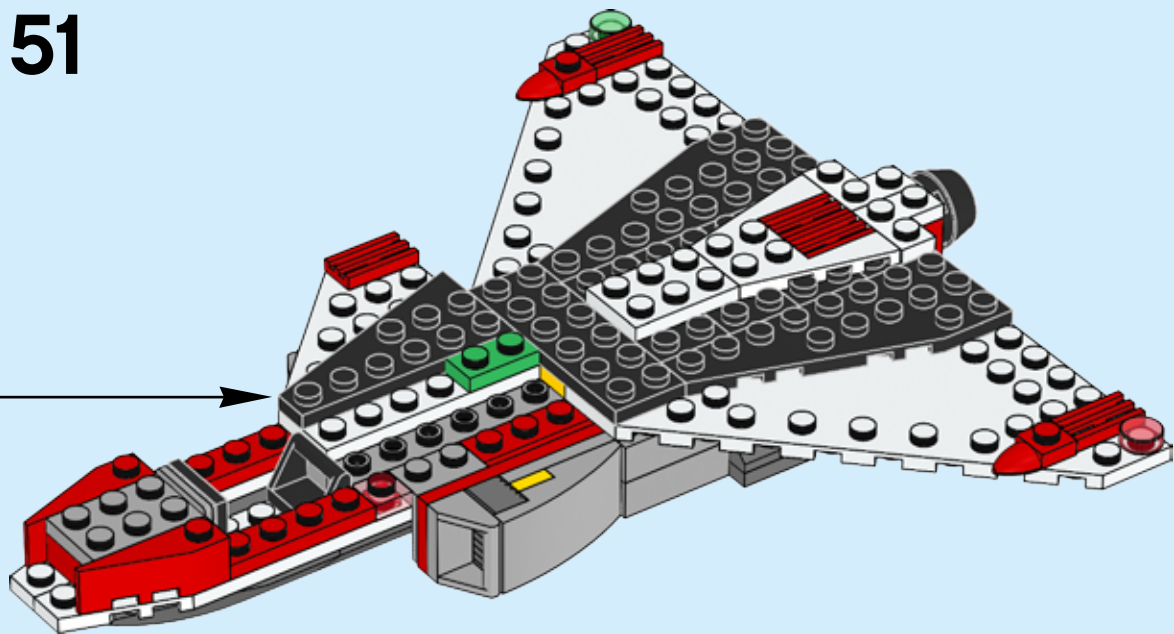



1x

52

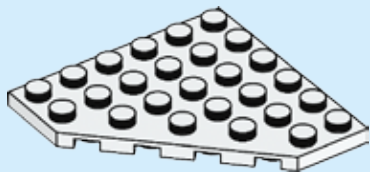

1x



1x

53

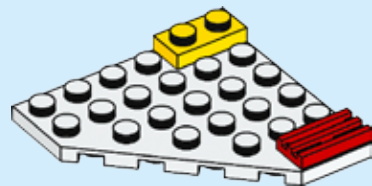

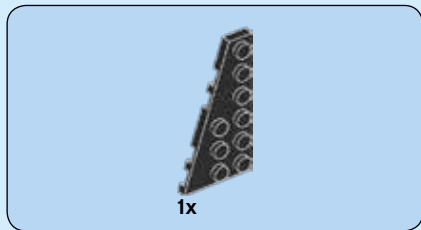

54

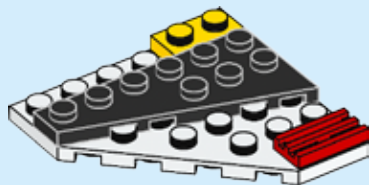

55

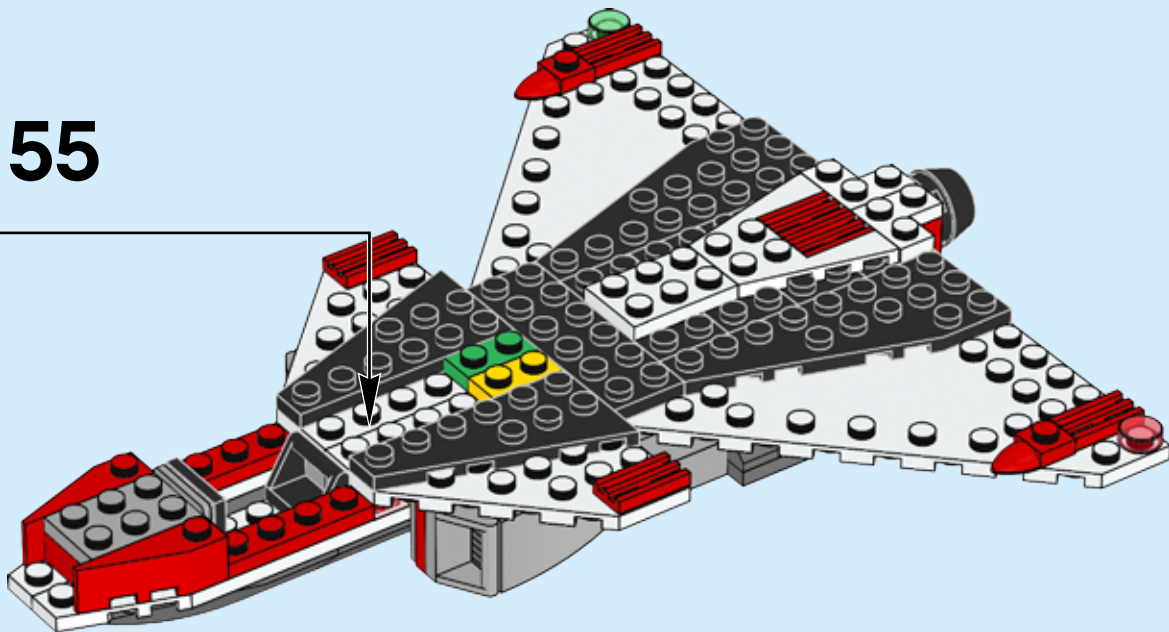





1x

# 56

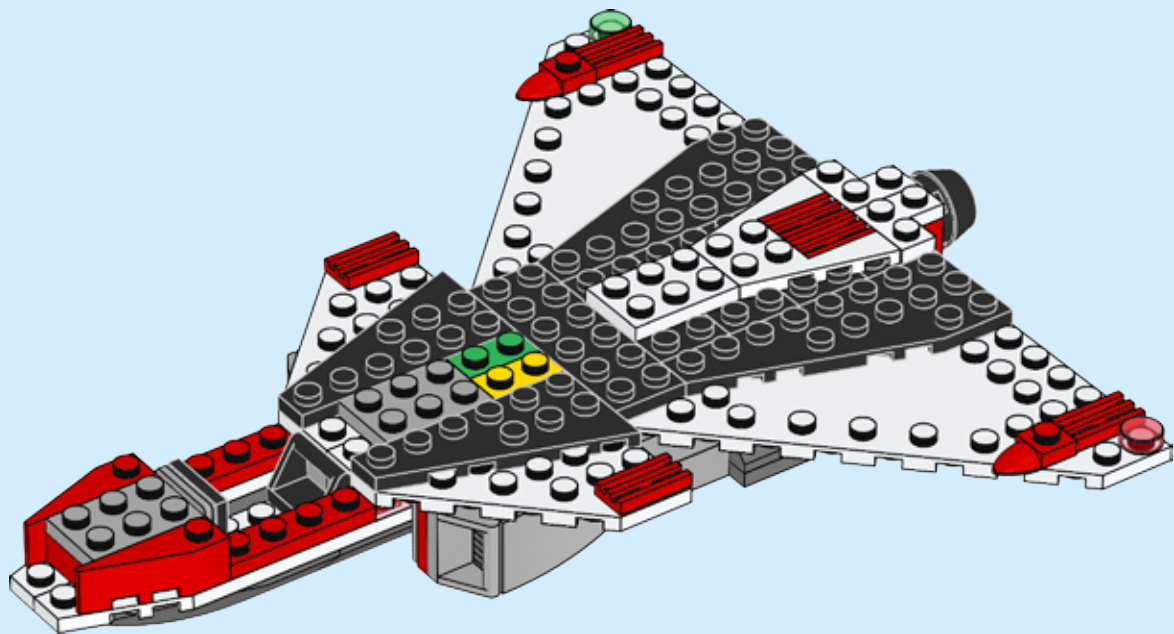

54

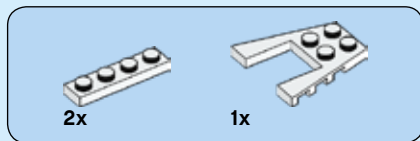

57

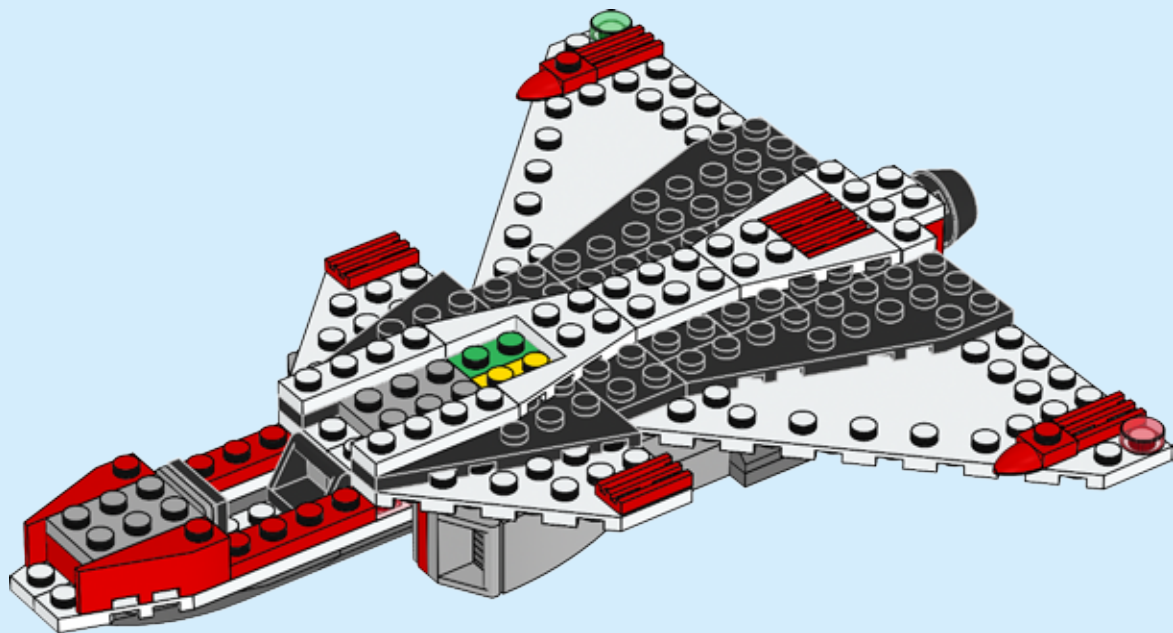



58

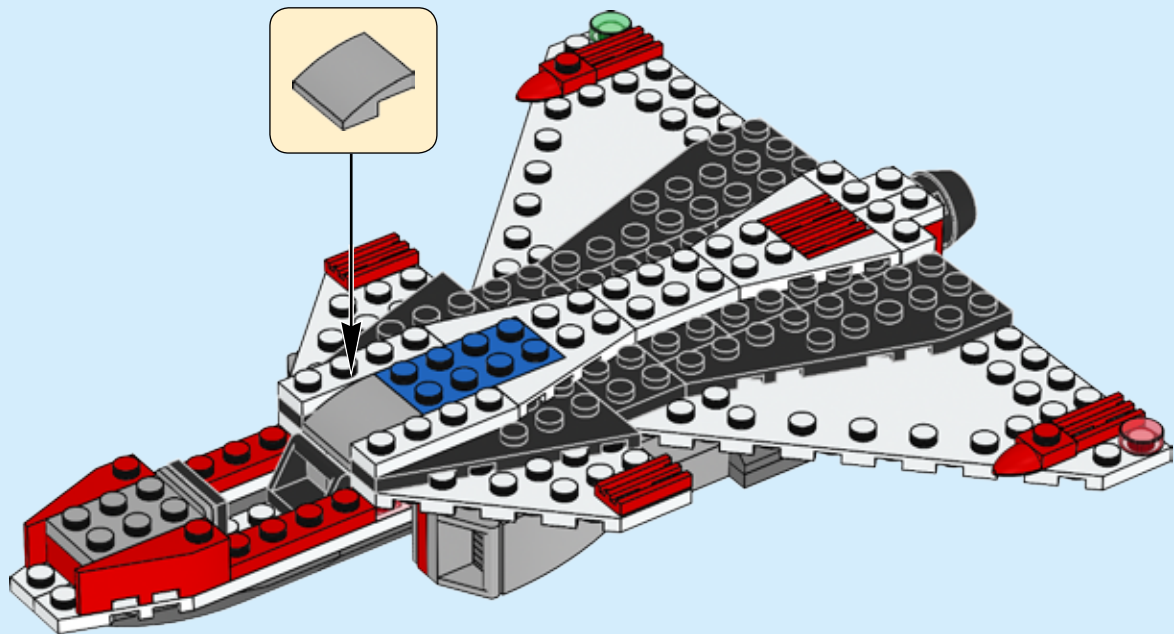



2x

# 59

1

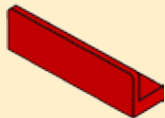

2

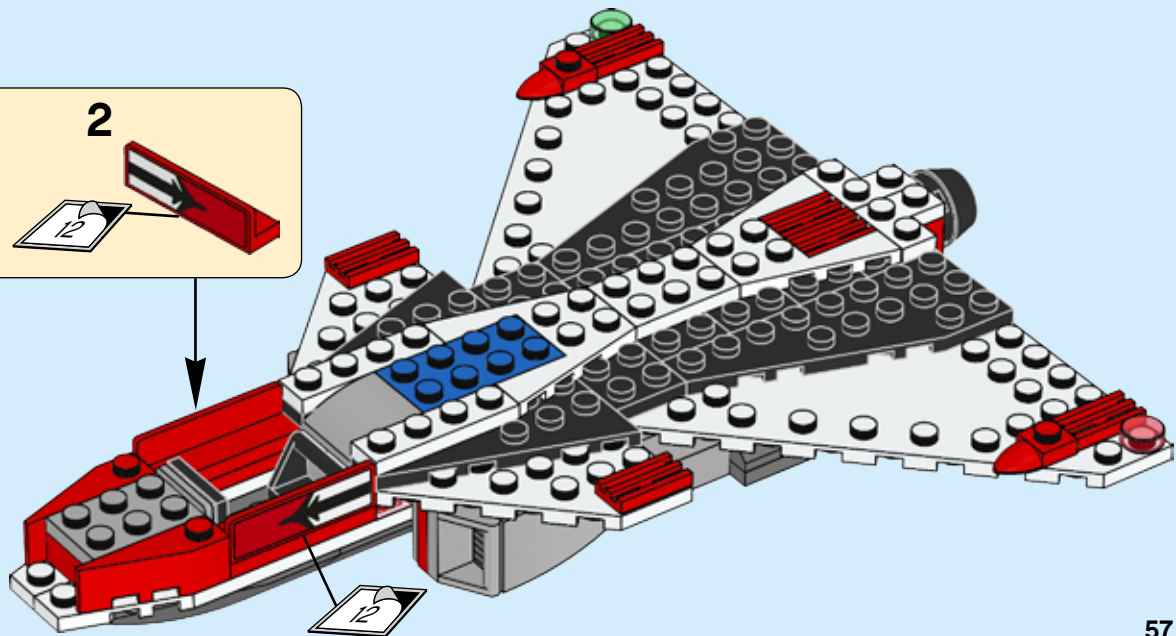
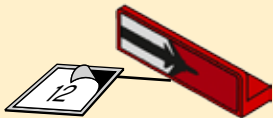



60

1

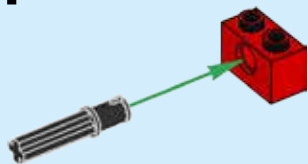

2



3



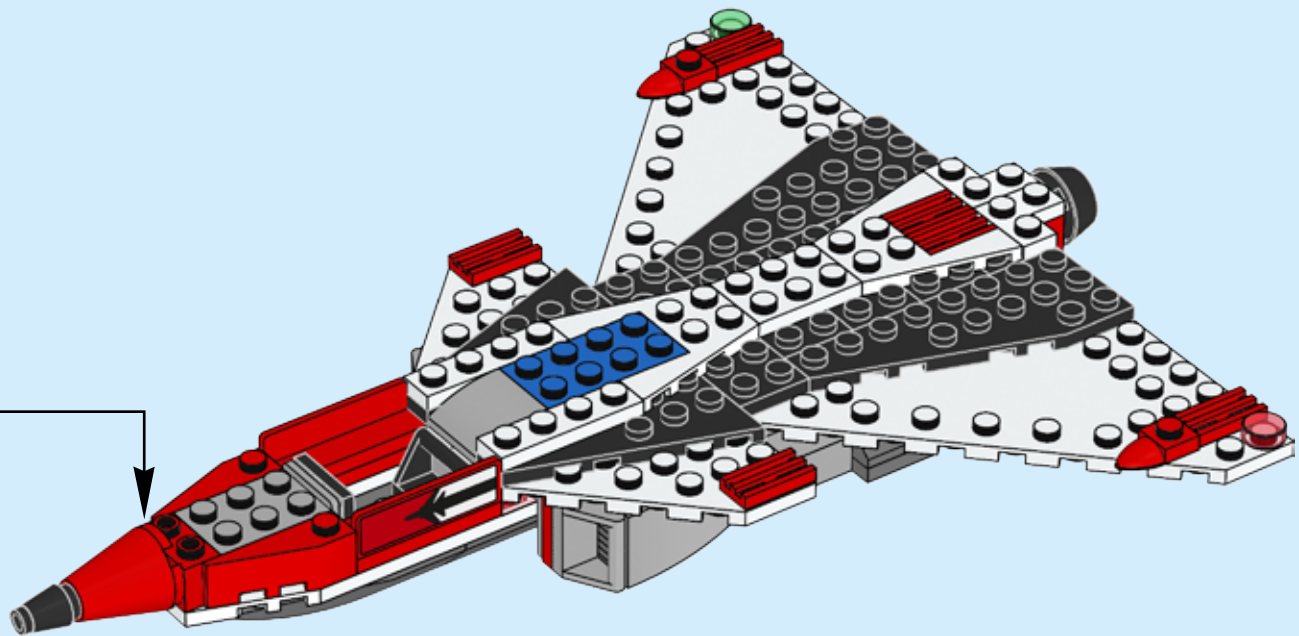



1x

61

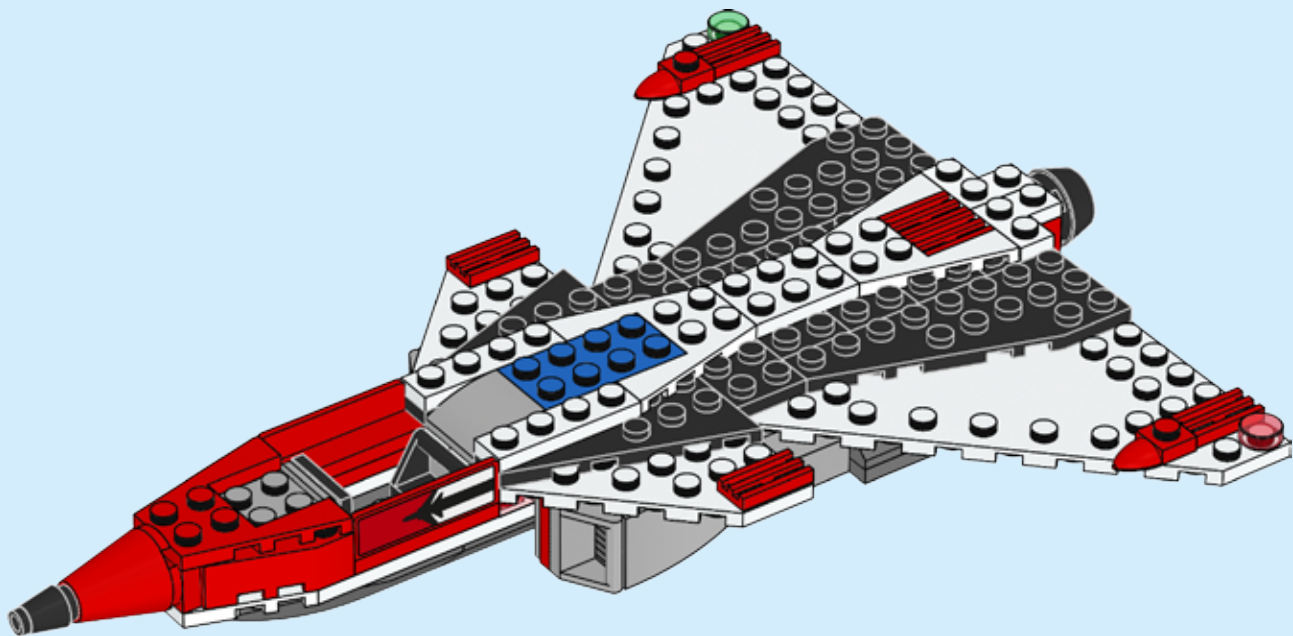

60



1x



1x

# 62

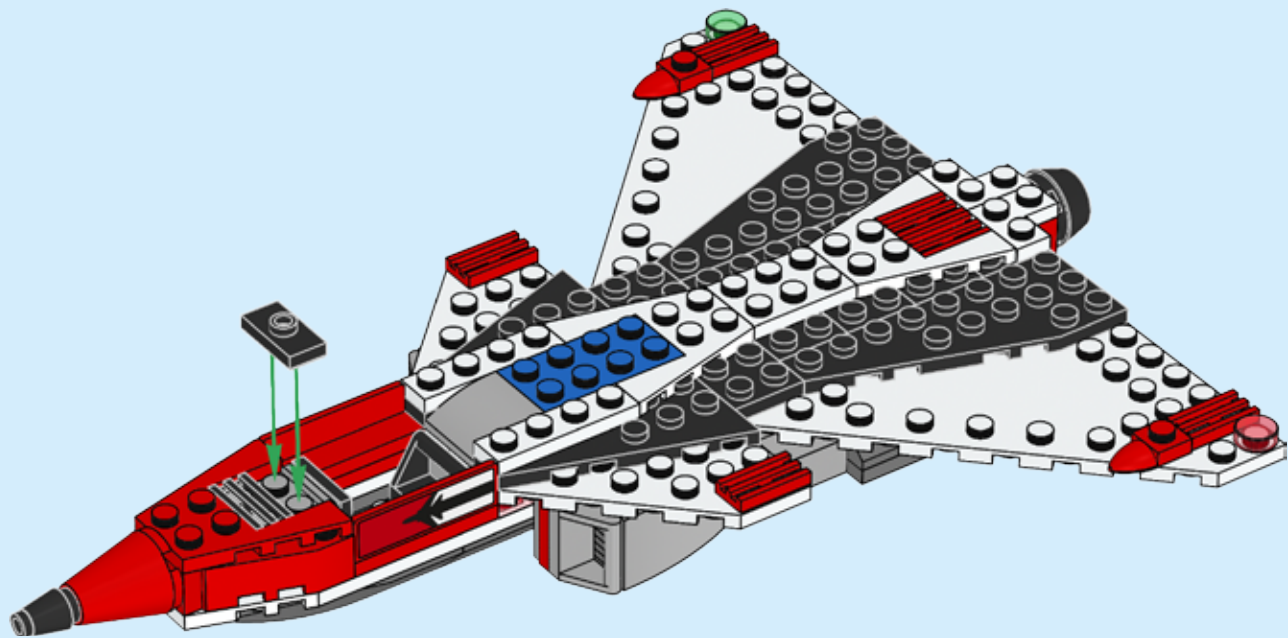



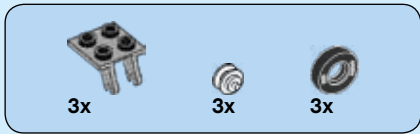

63

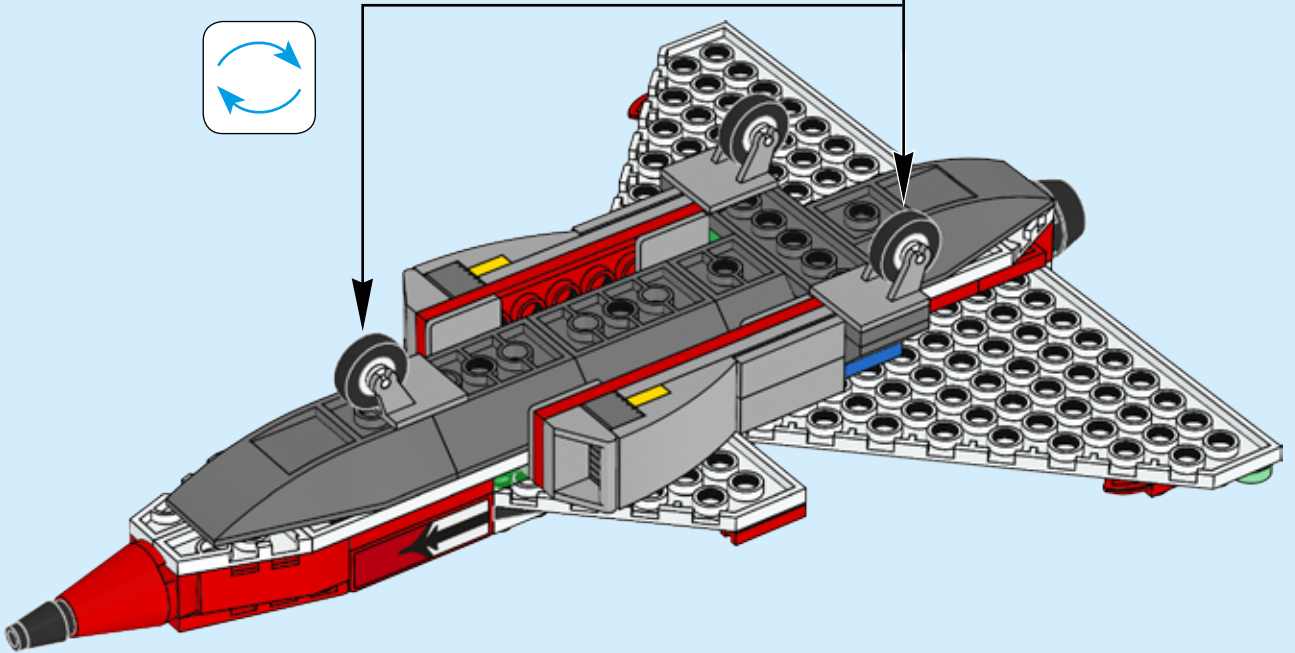
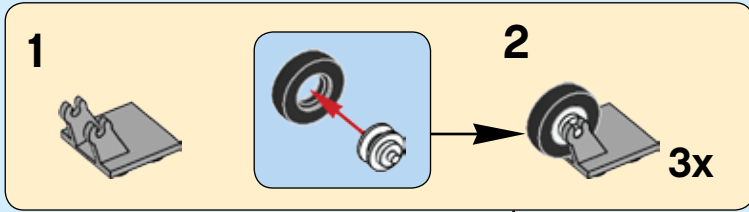
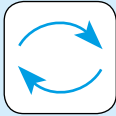



2x



1x

# 64

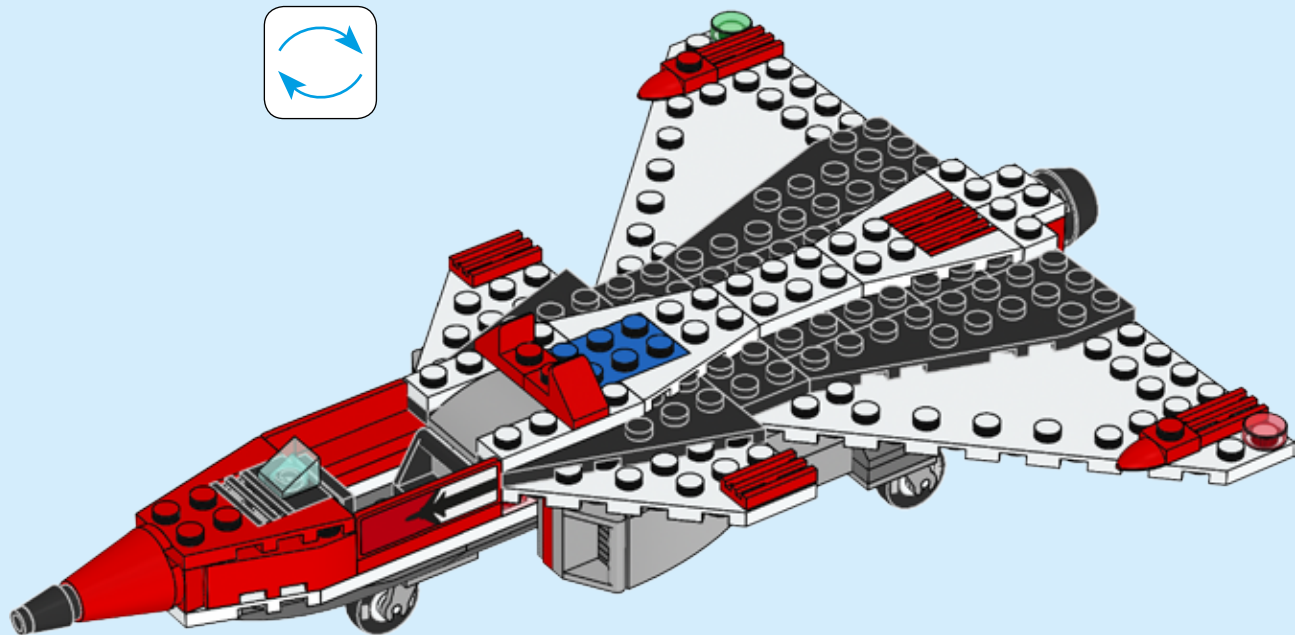
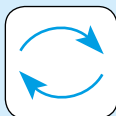



1x

65

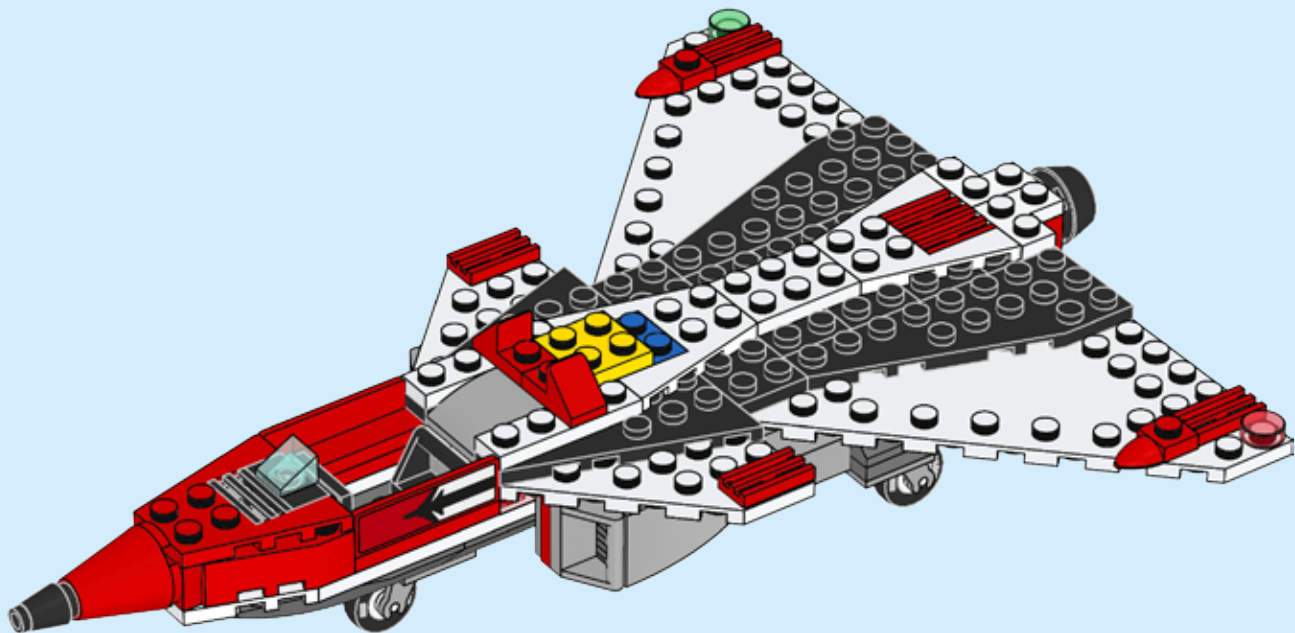

64



2x

66



2x

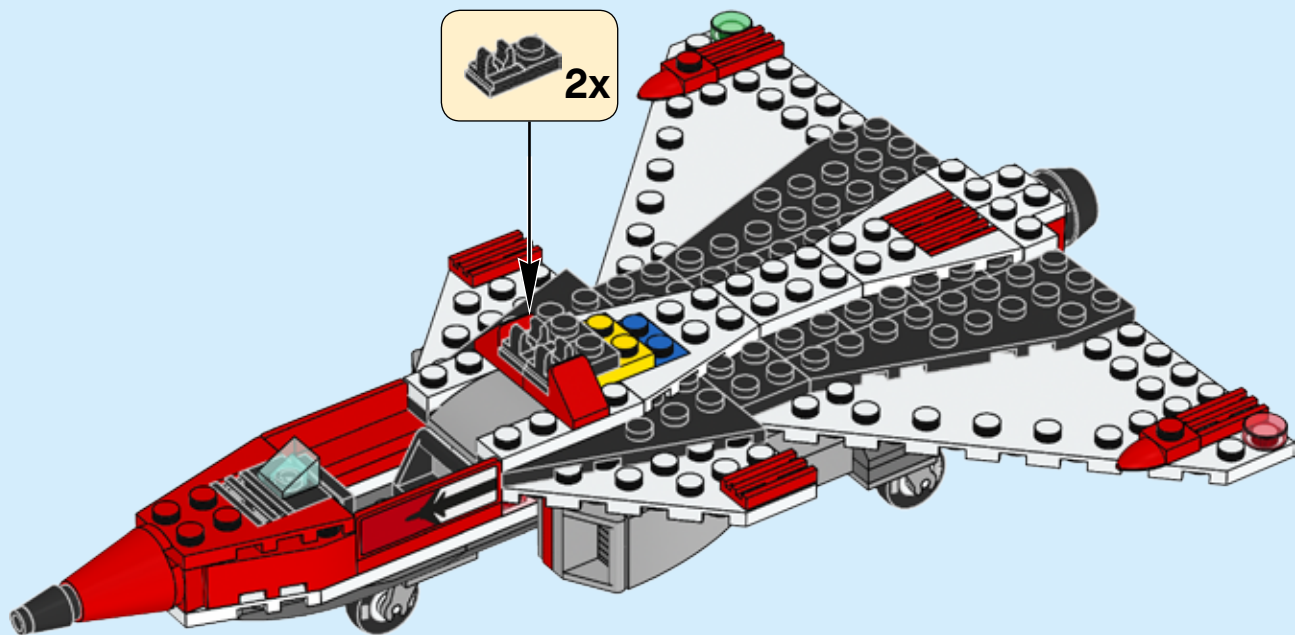

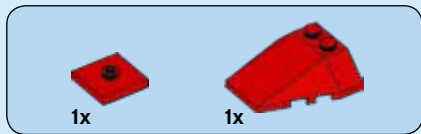

67

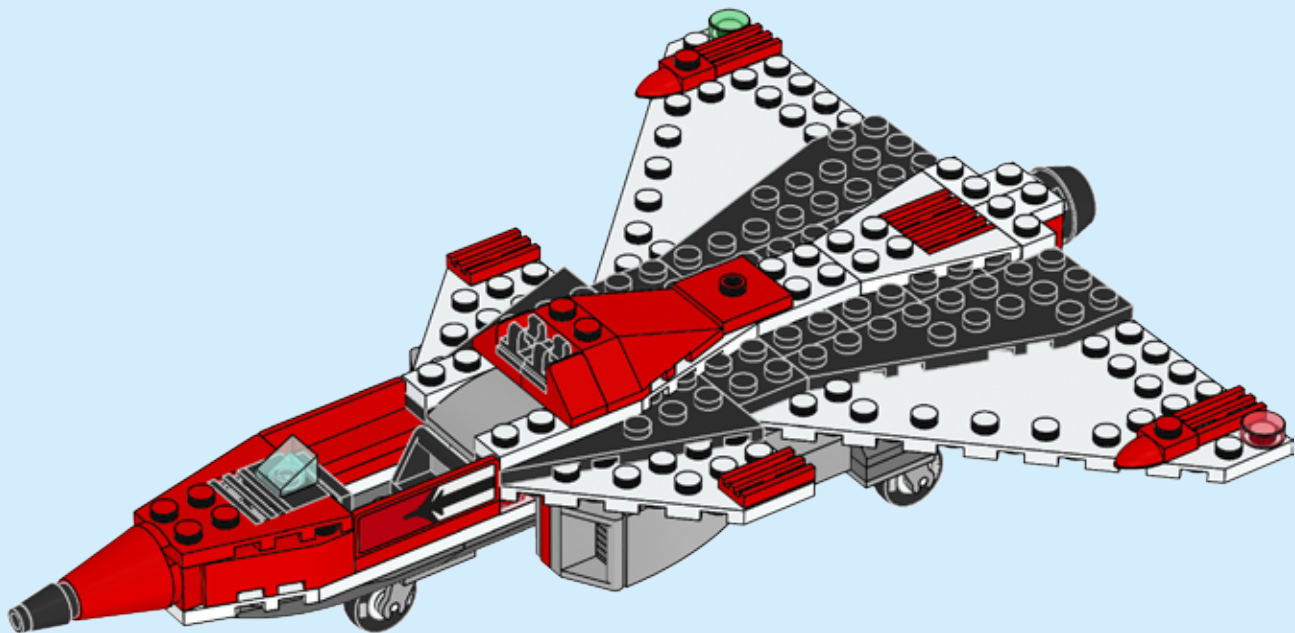

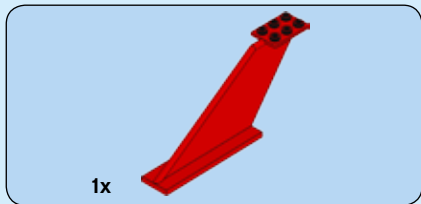

68

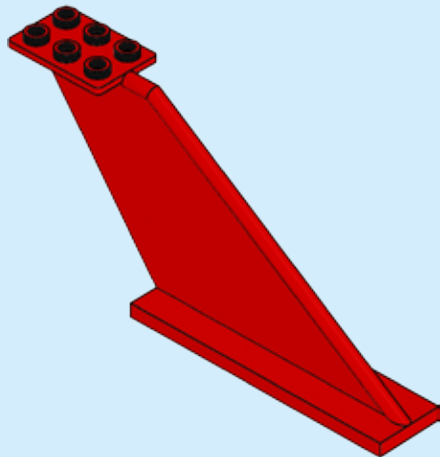

69

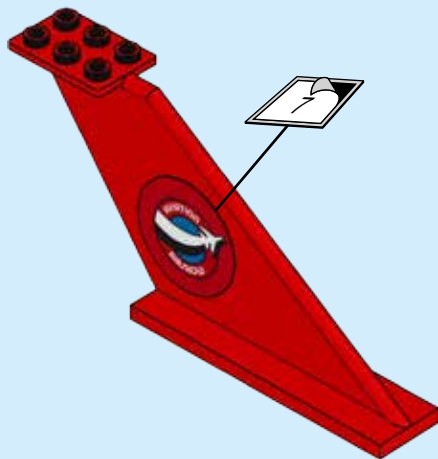

# 70

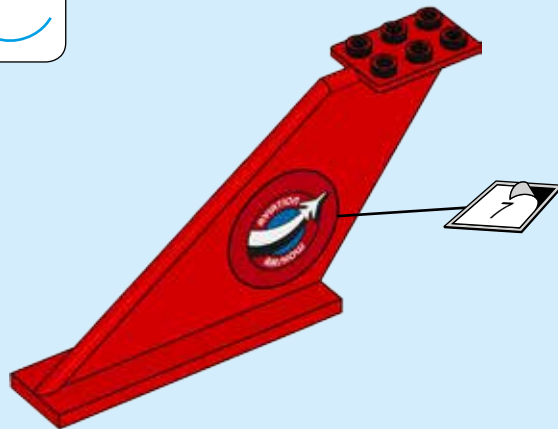
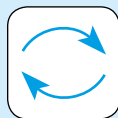



1x



1x

# 71

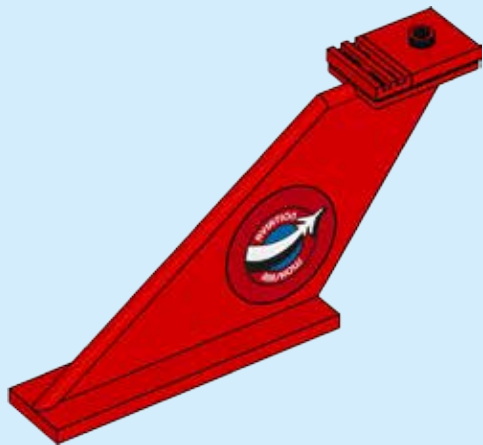

1x

# 72

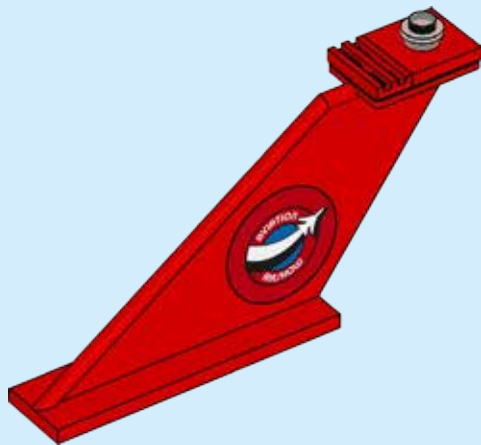



73

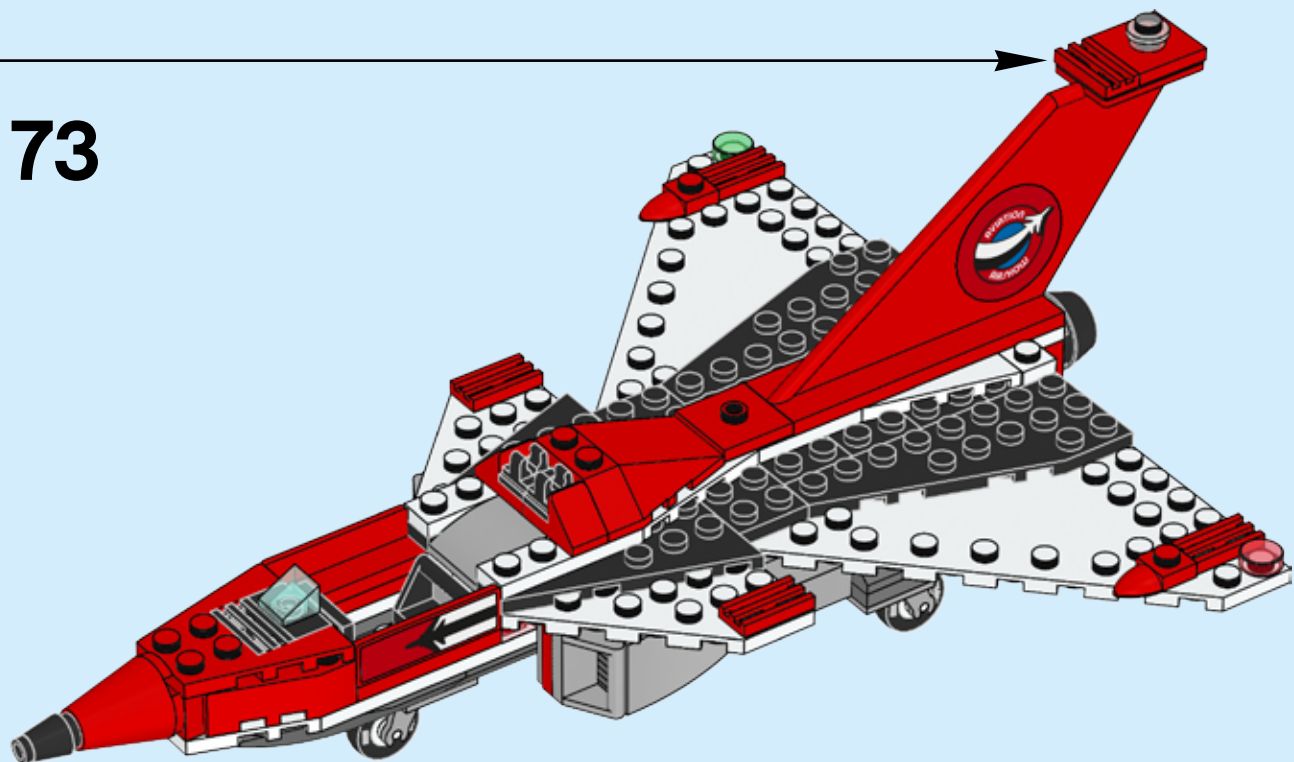

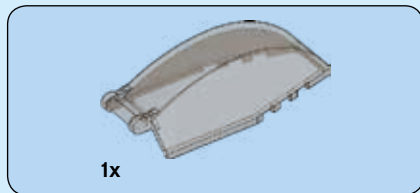

74

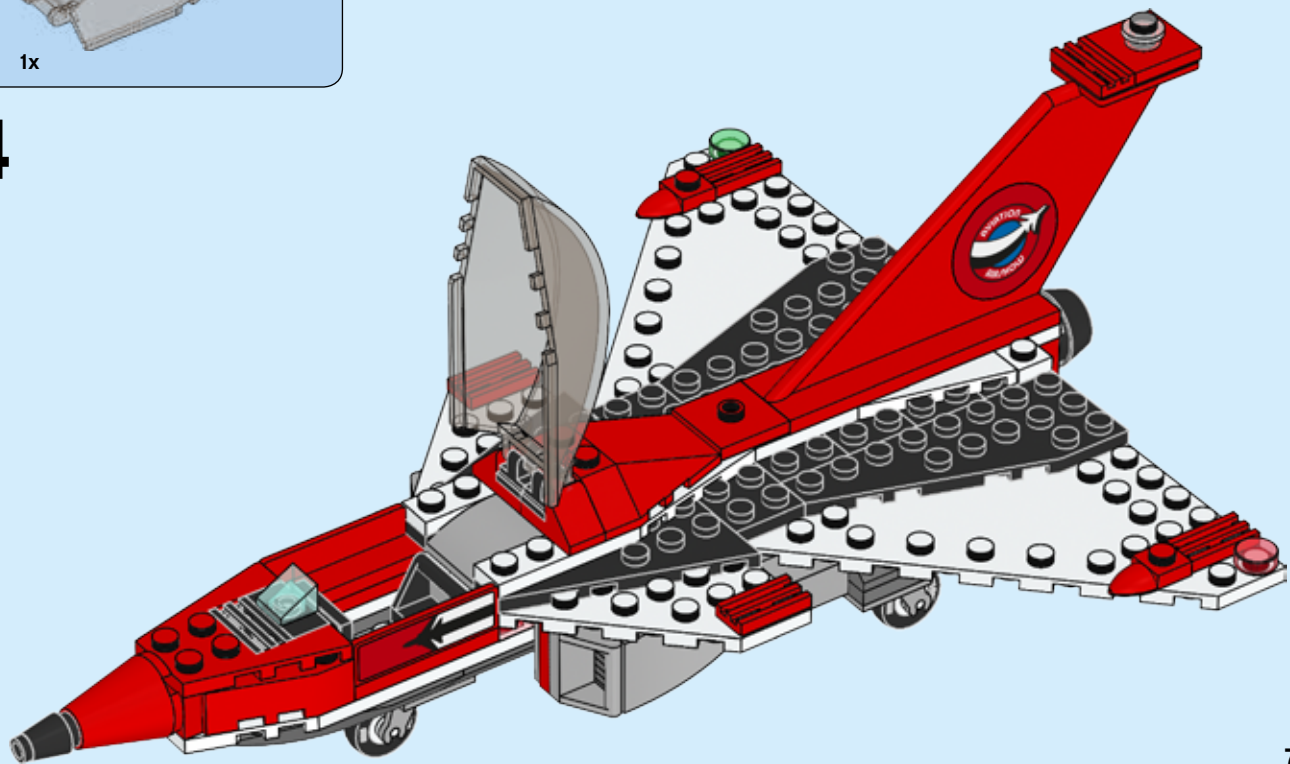

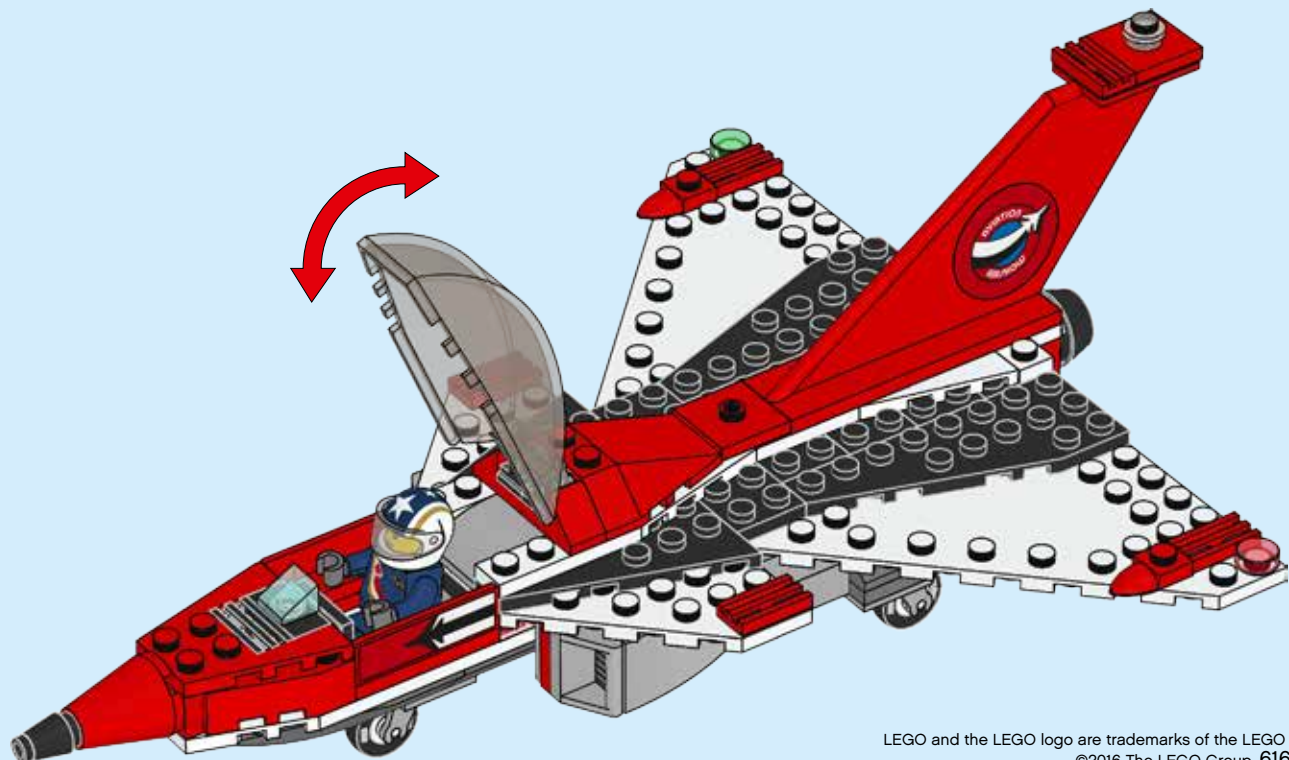



# CITY

60103



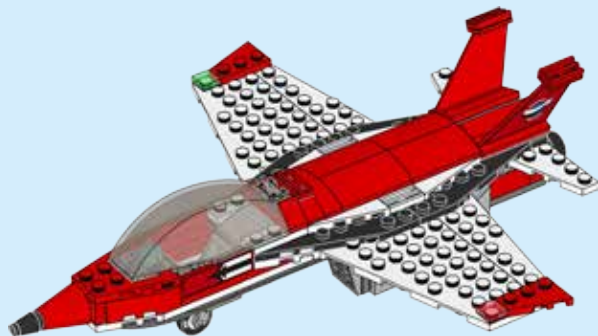
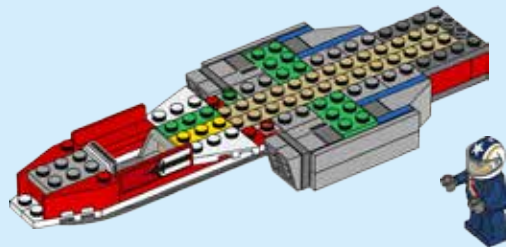
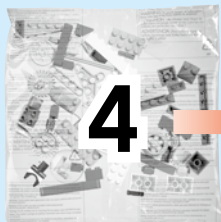

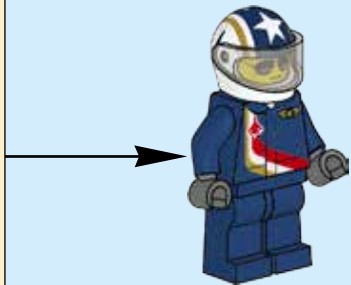
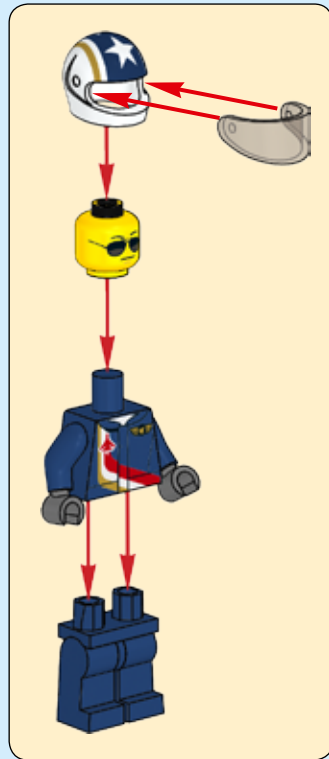
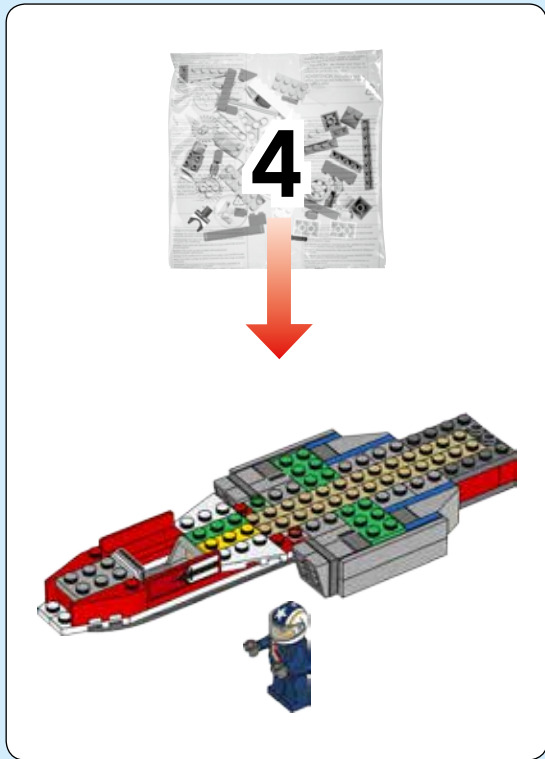

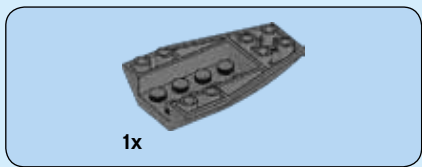
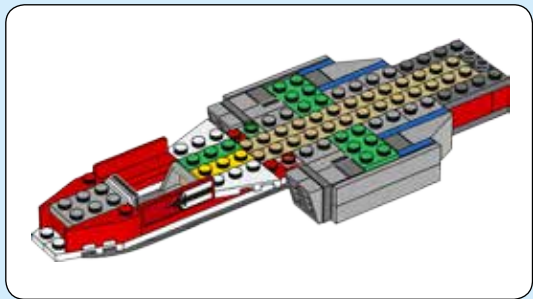

1

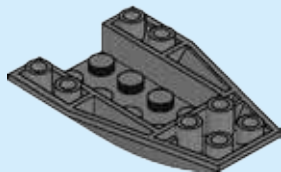



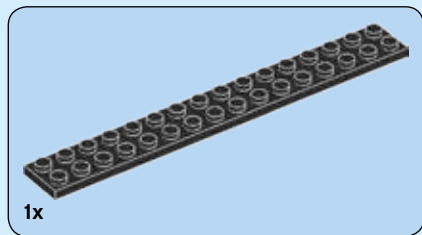

**2**

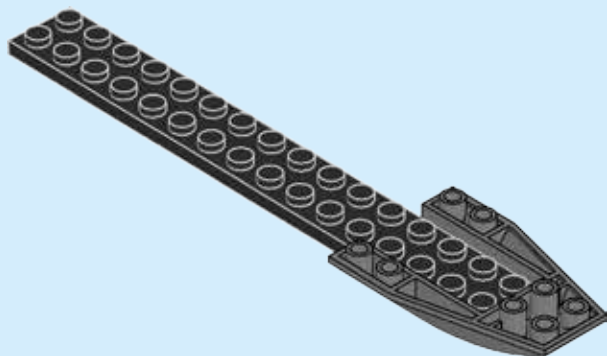



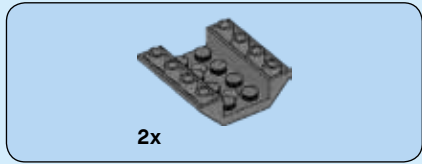

**3**

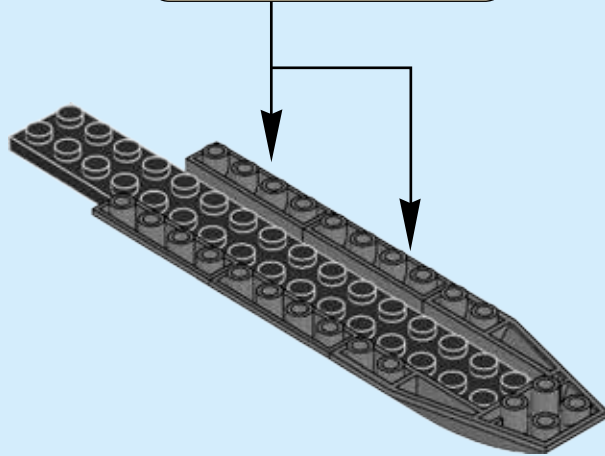
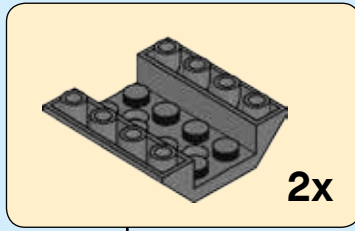

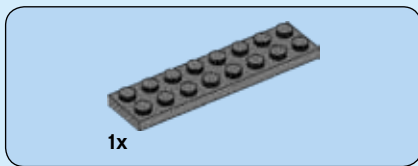

4

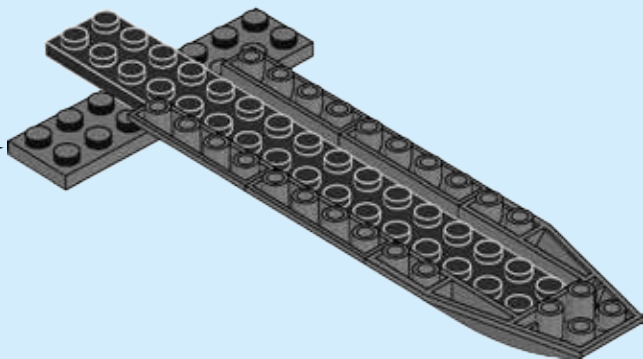
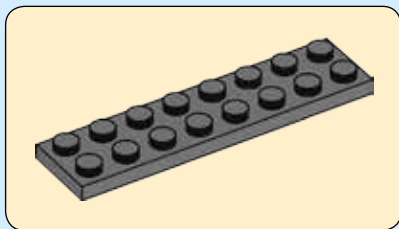



5

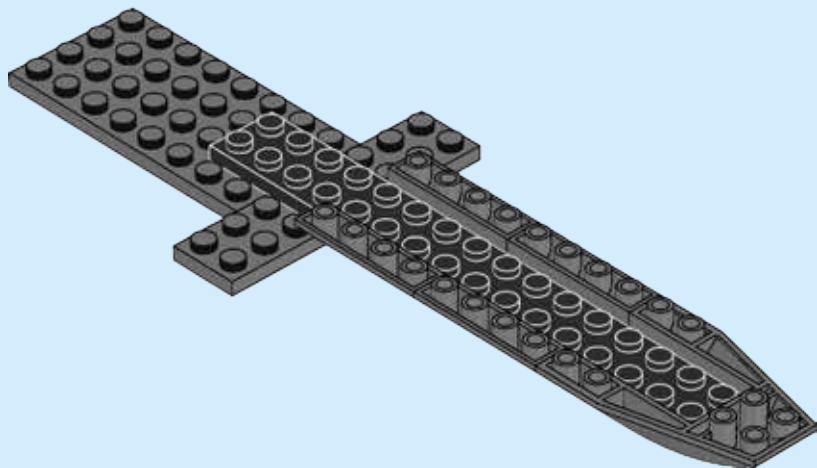



6

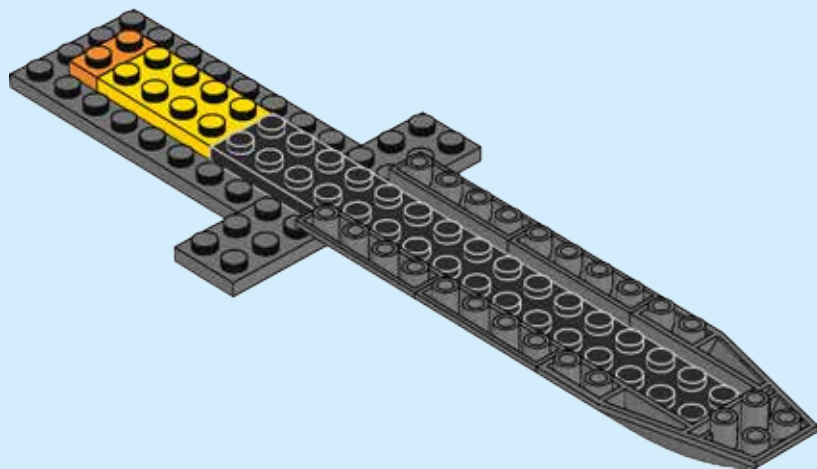

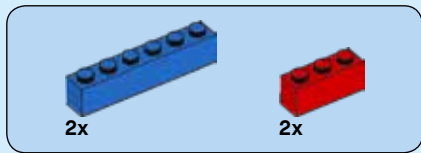

7

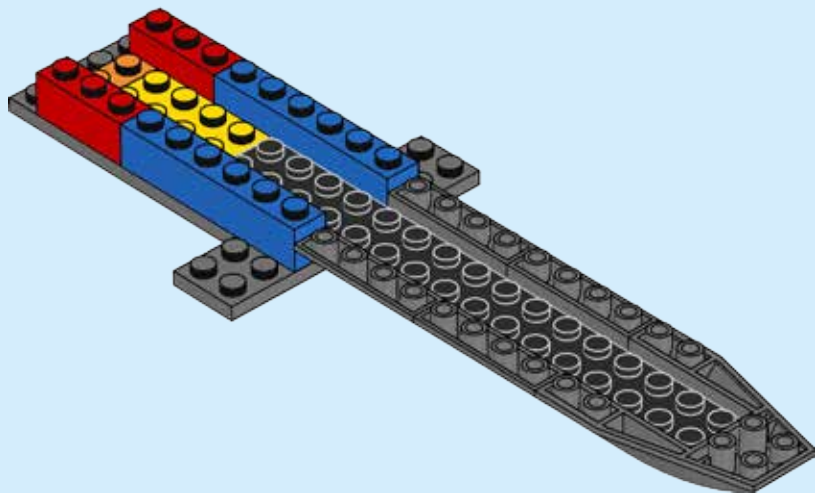

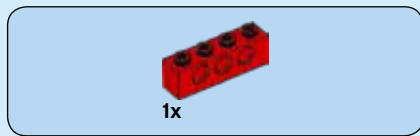

8

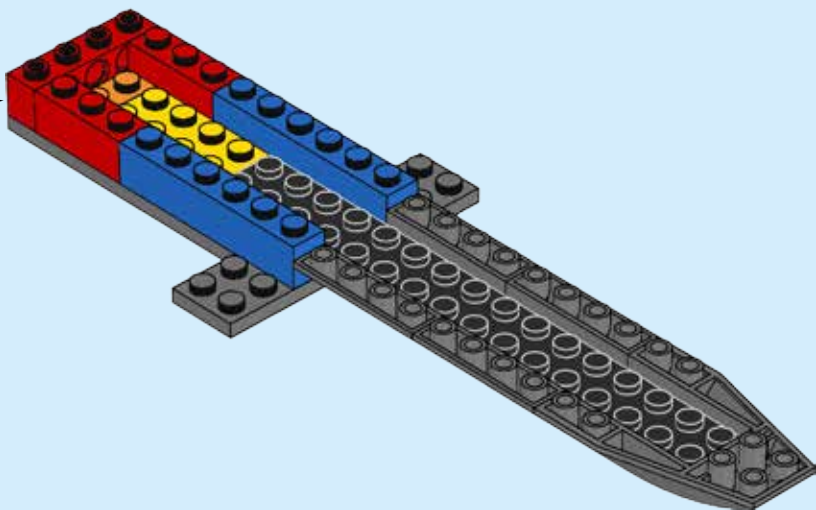
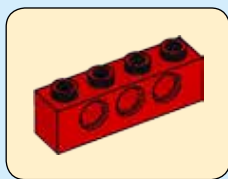

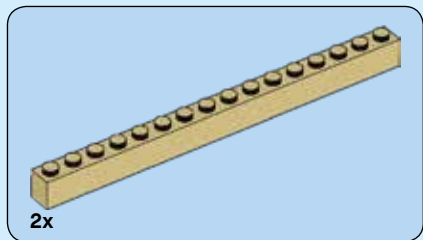

9

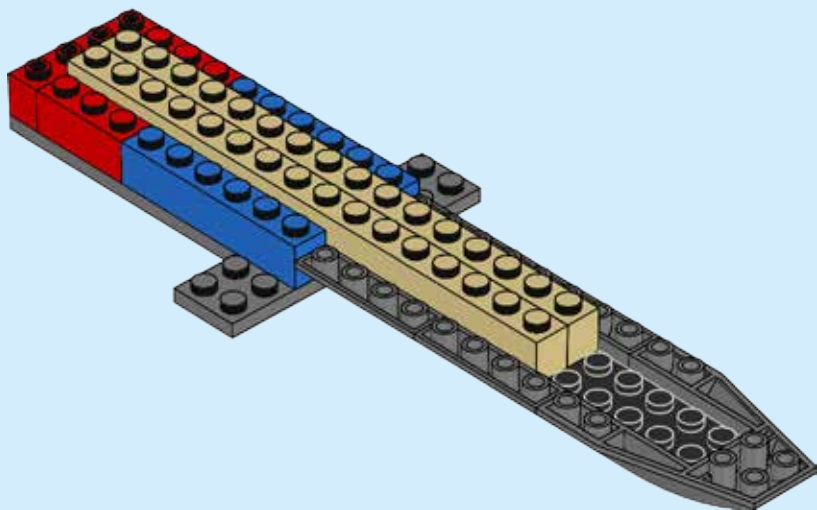

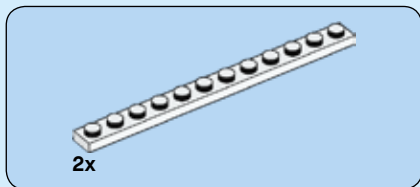

10

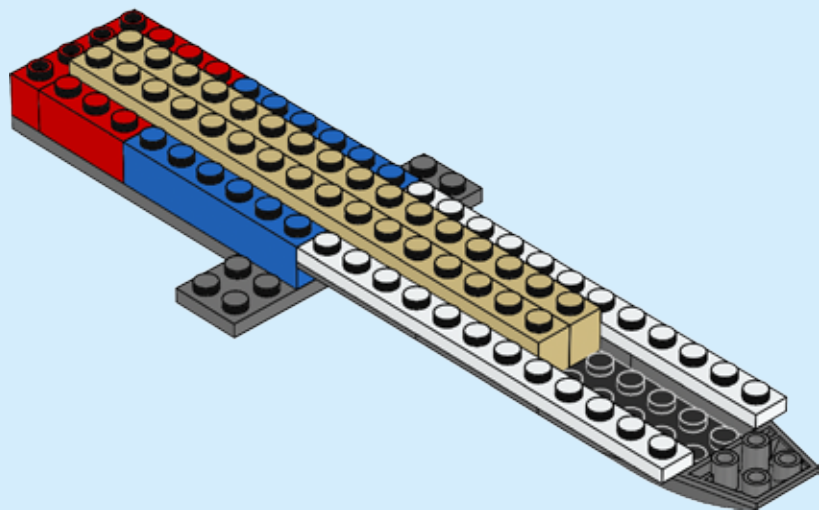





2x

11

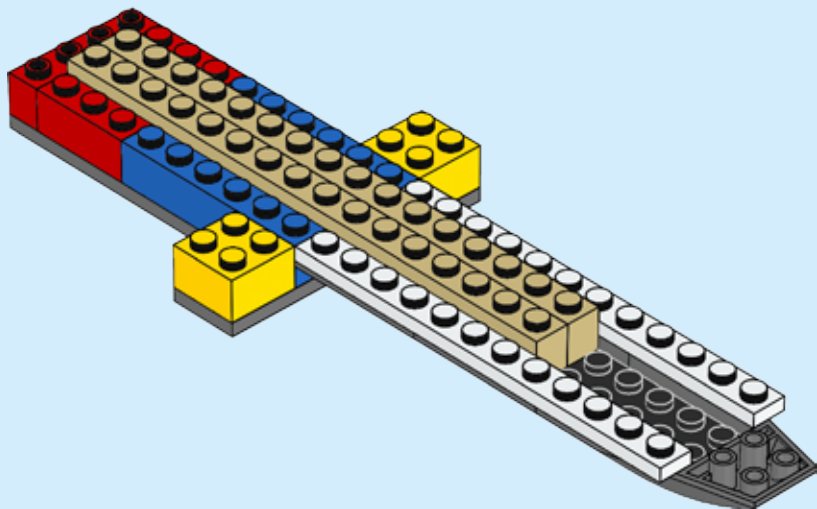

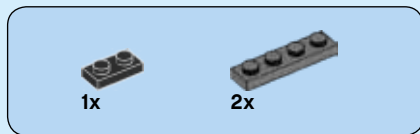

# 12

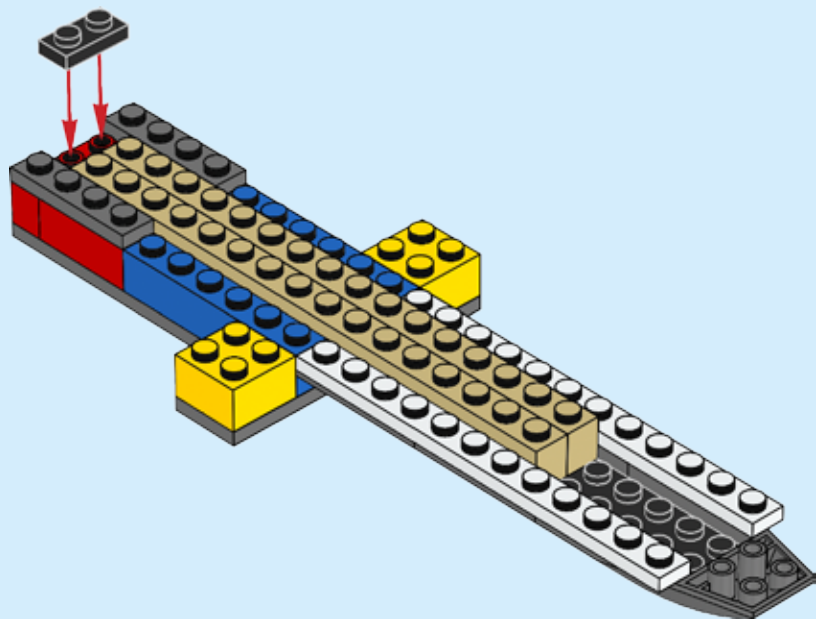



2x

# 13

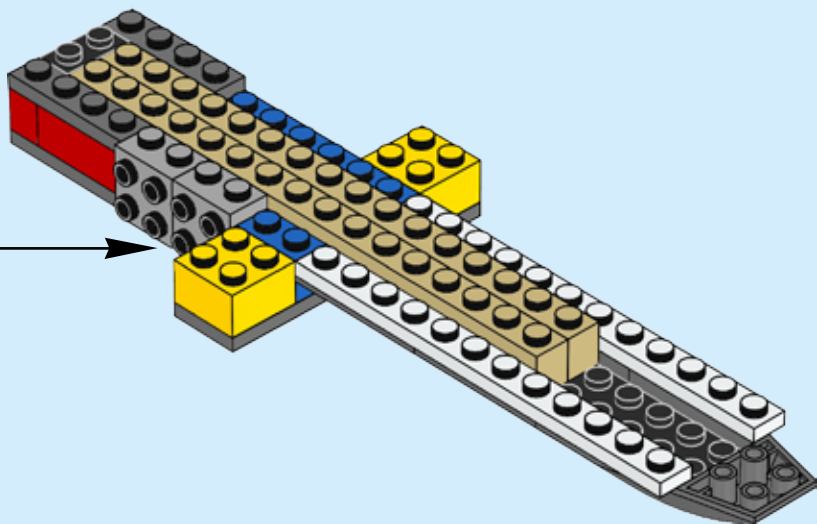

2x

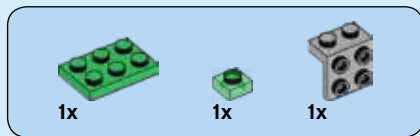

14

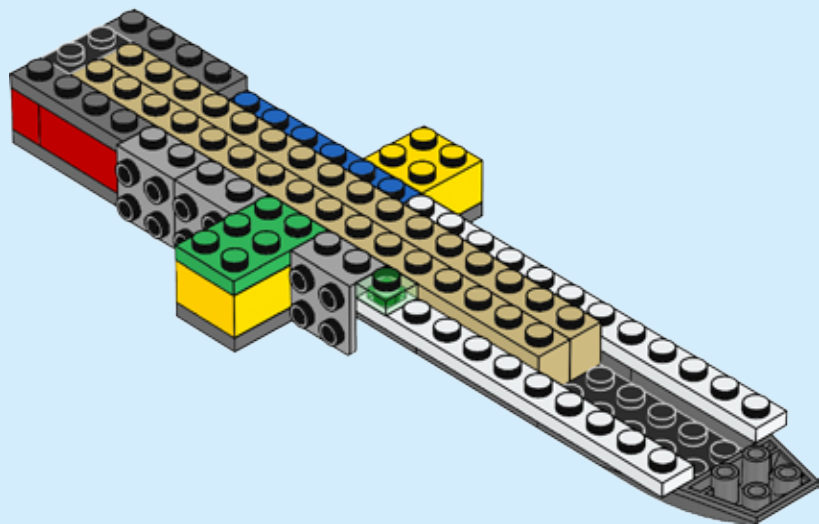

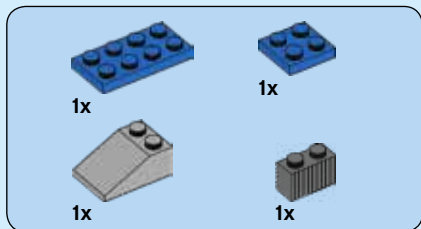

# 15

1



2

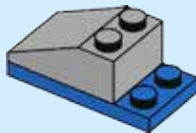

3

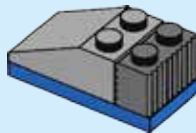

4

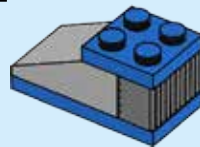

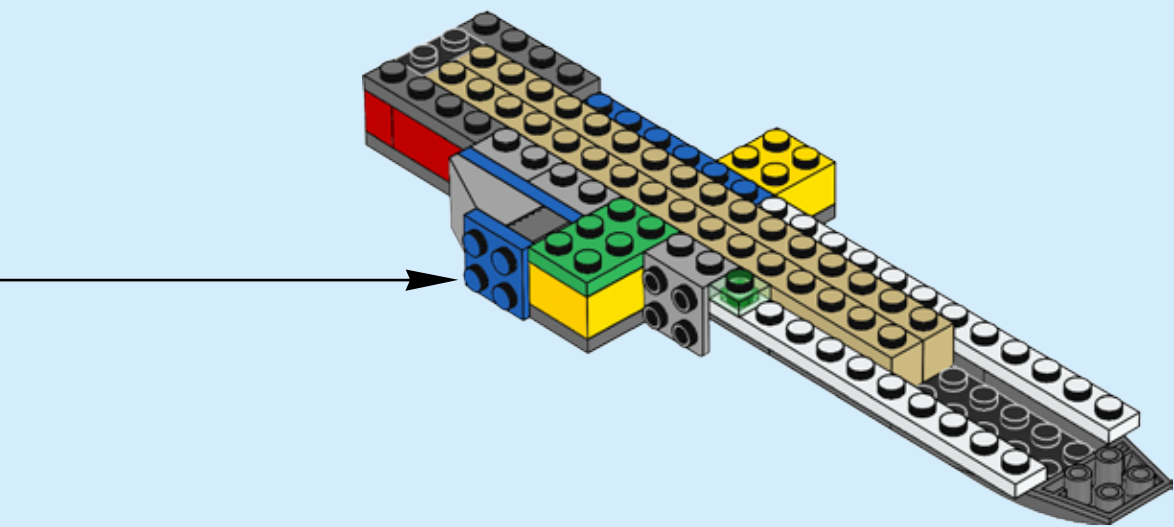

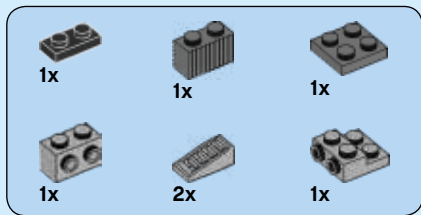

# 16

1

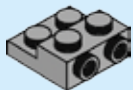

2

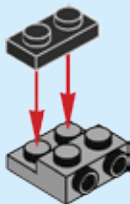

3

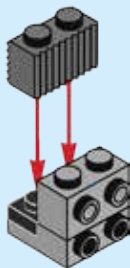

4

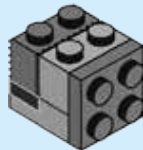

5

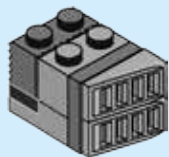

6

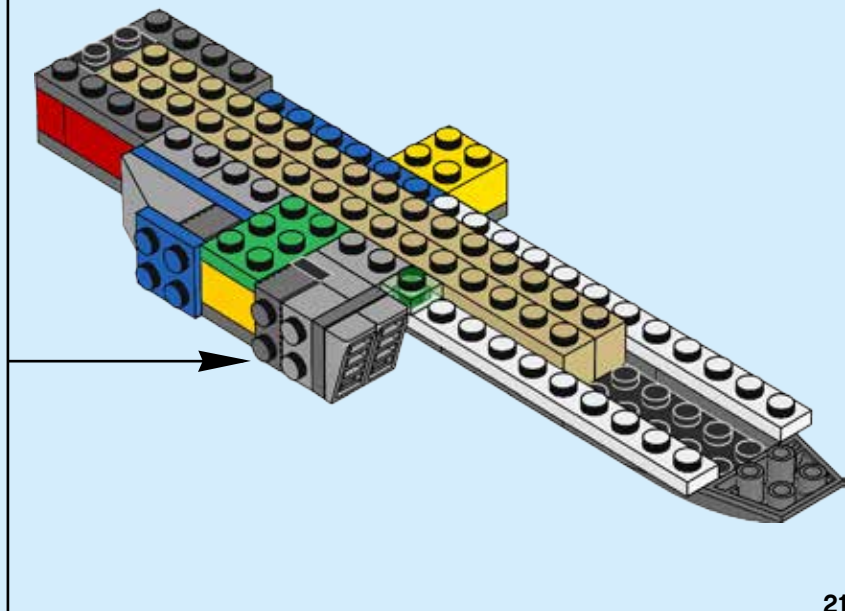
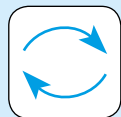
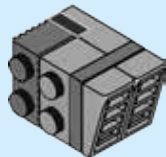



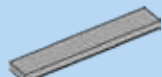

2x

17

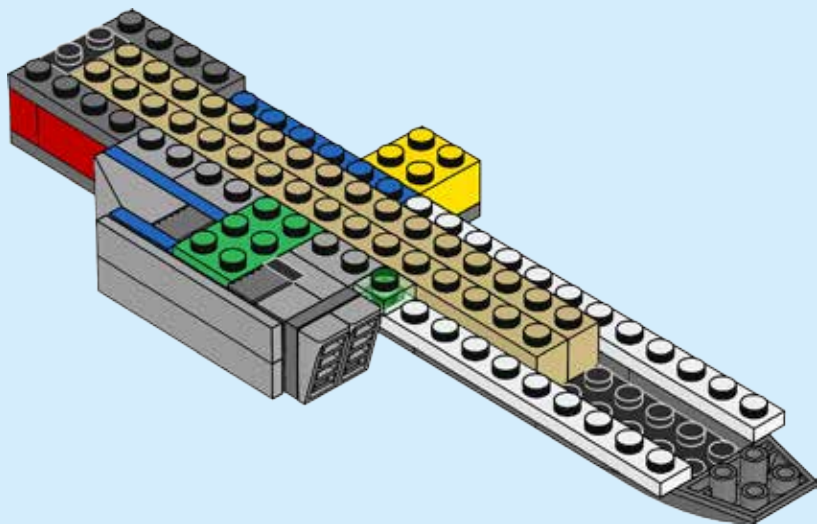



2x

# 18

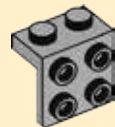
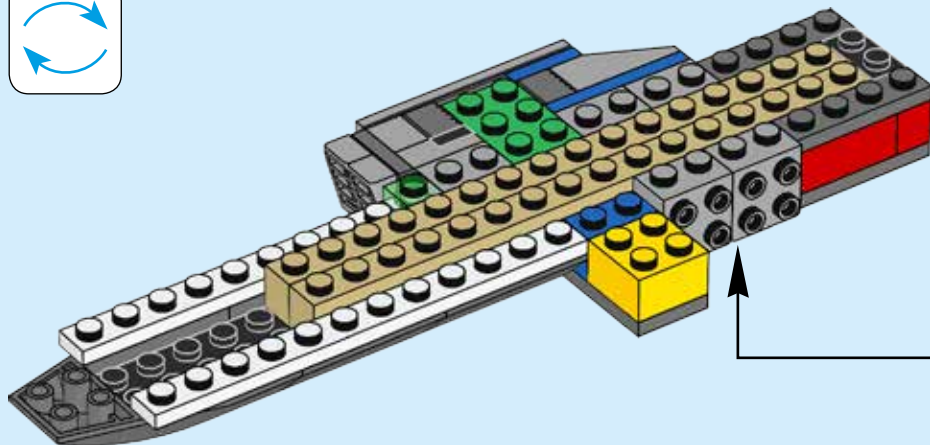
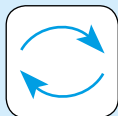

2x



1x



1x



1x

# 19

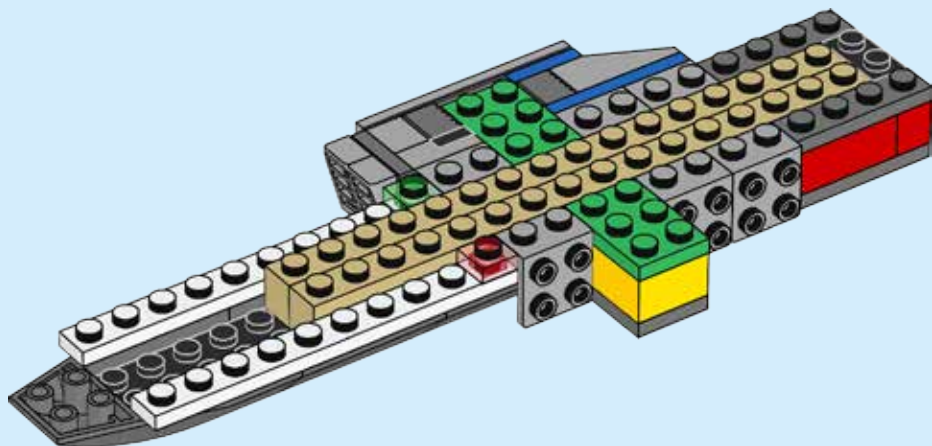

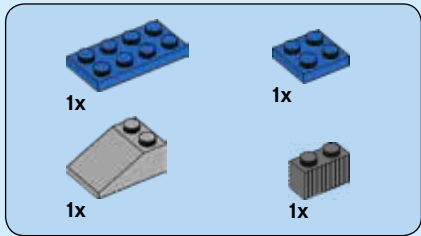

**20**

**1**



**2**

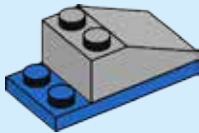

**3**

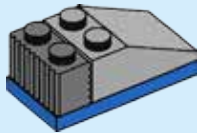

**4**

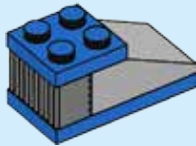

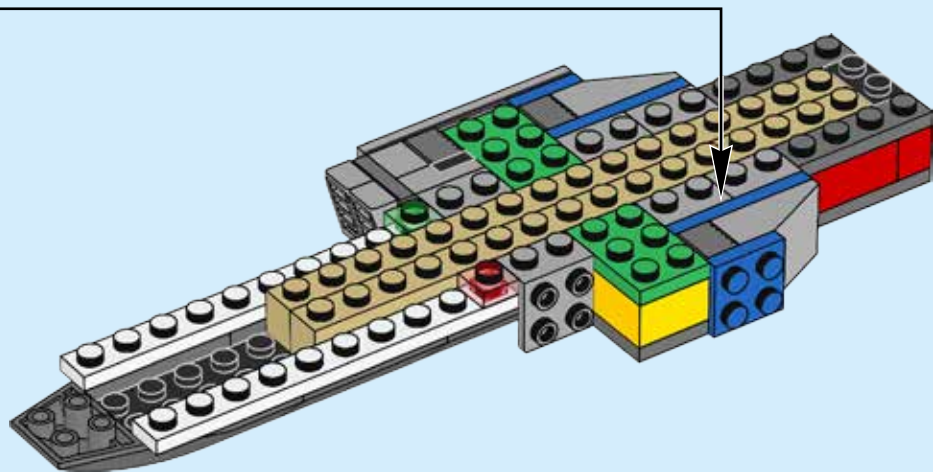



1x



1x



1x



1x



2x



1x

# 21

## 1

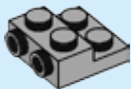

## 2

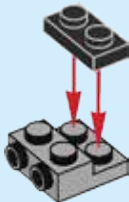

## 3

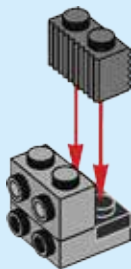

## 4

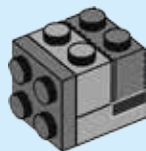

## 5

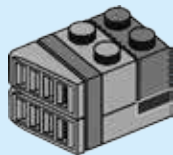

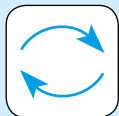

6

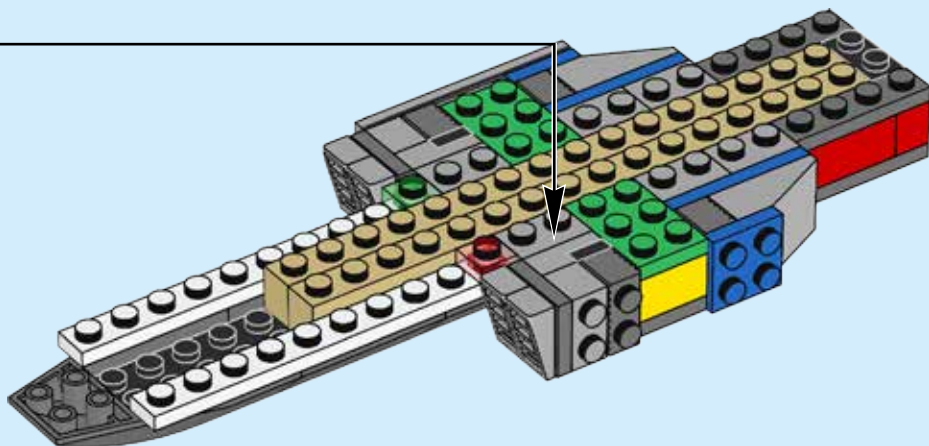
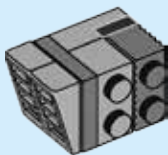

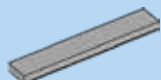

2x

# 22

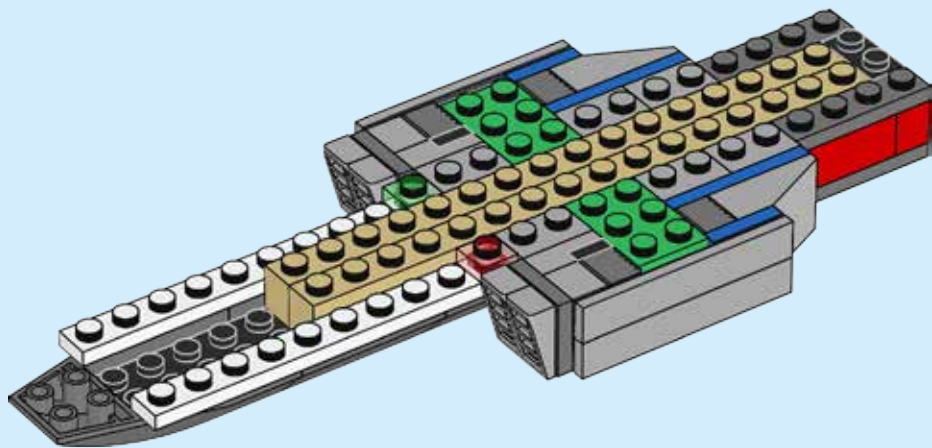





1x



1x

# 23

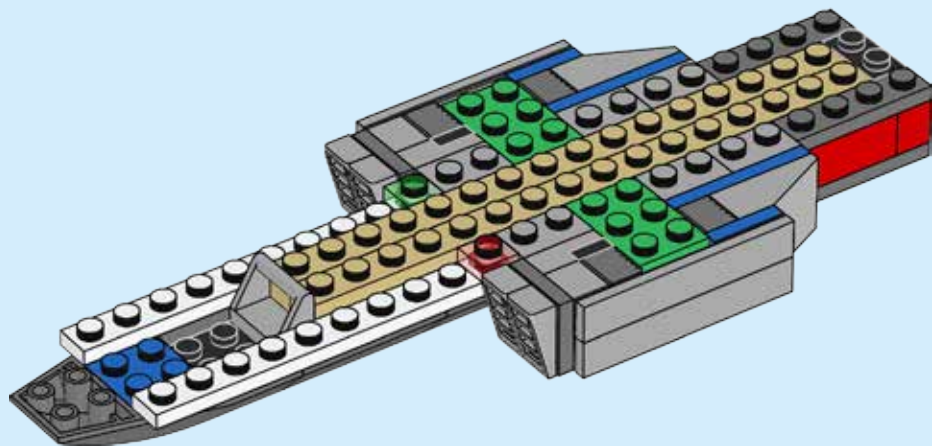

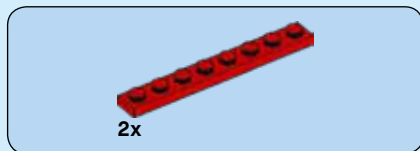

24

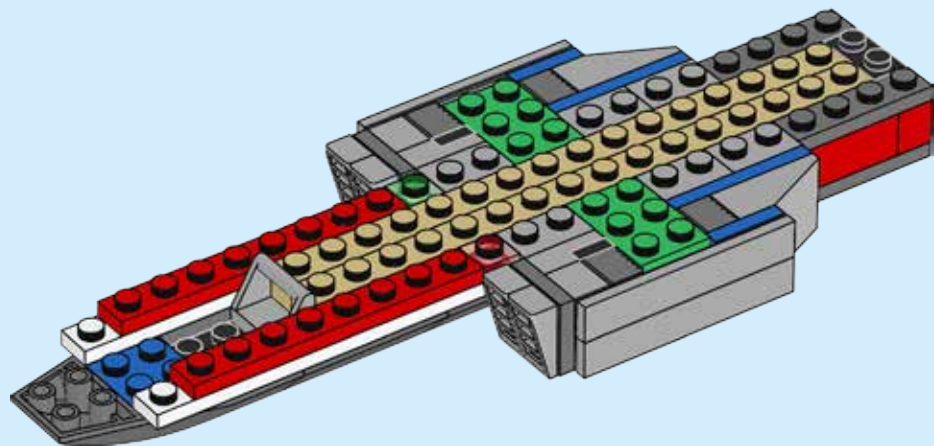



1x



1x



1x

# 25

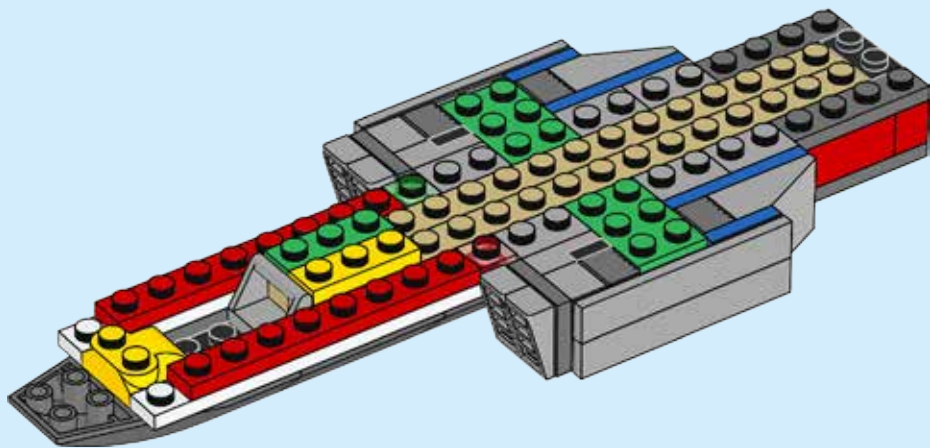



1x



1x

# 26

1



2

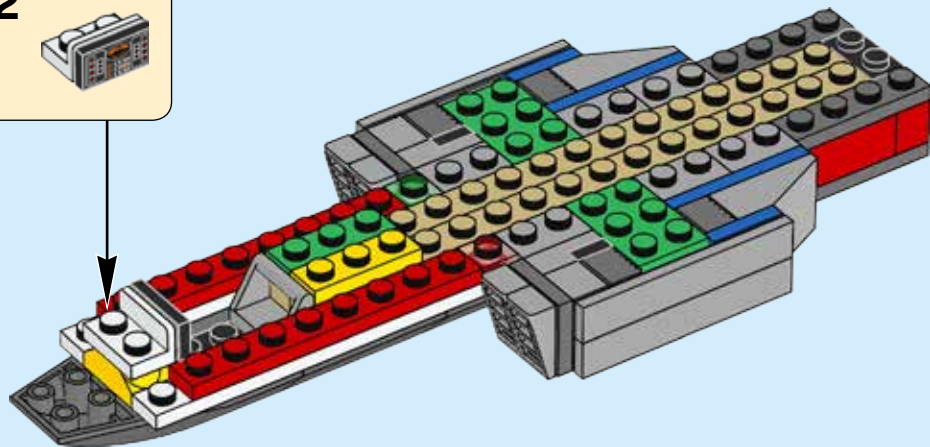

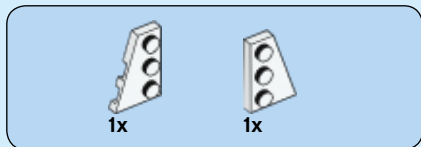

27

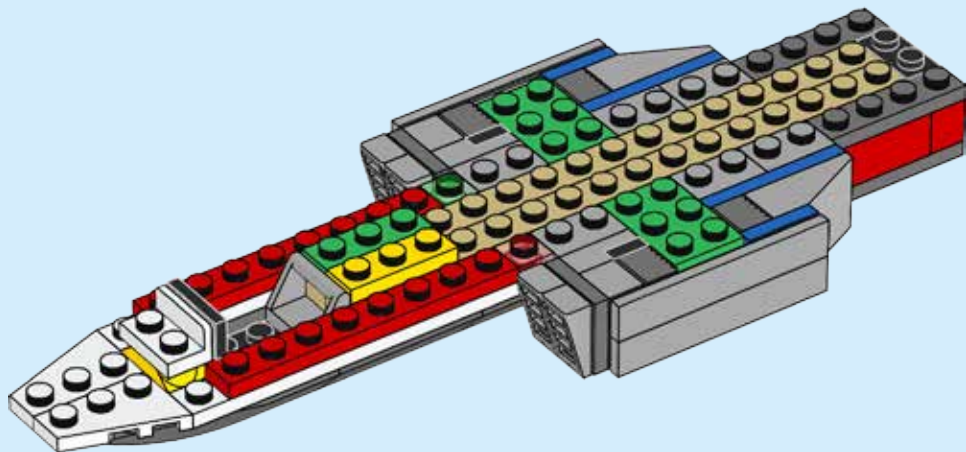



1x

28

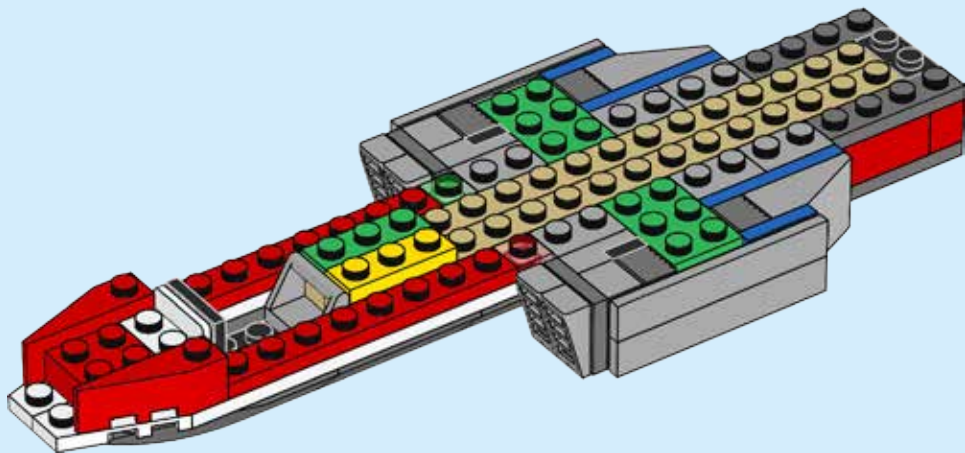



1x

# 29

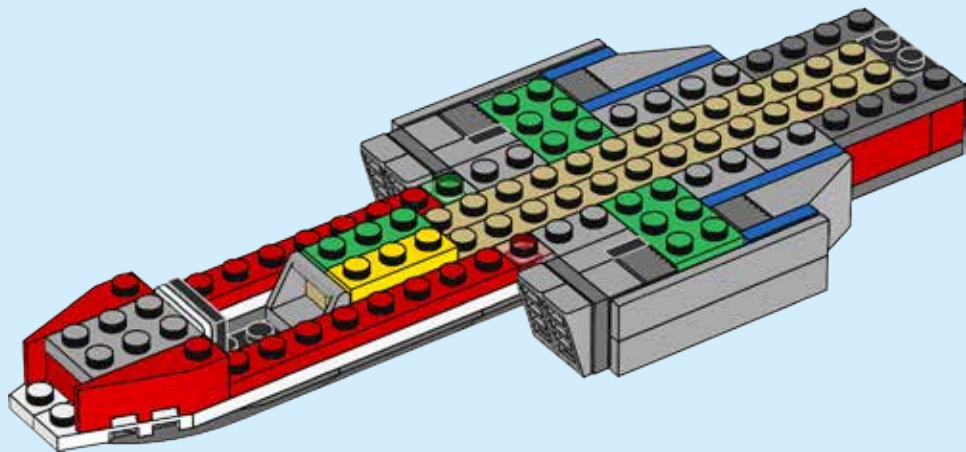

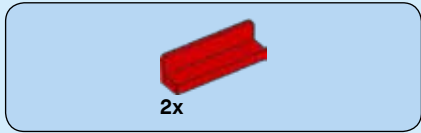

30

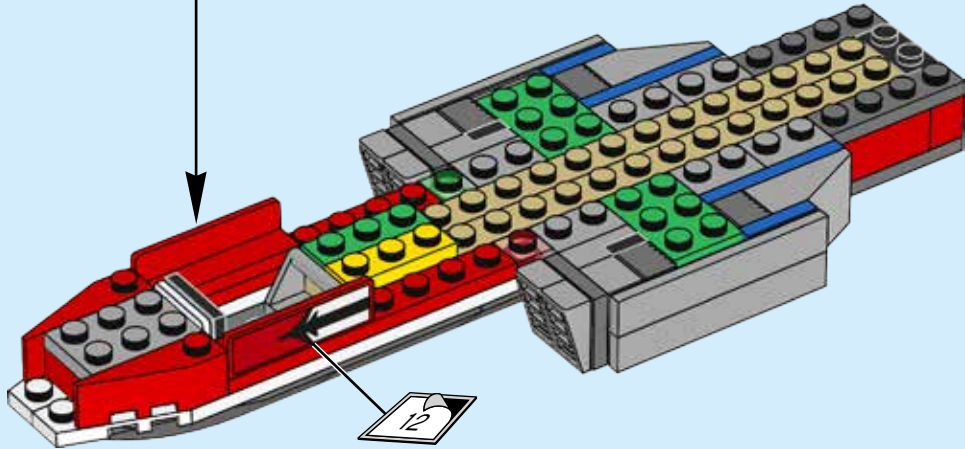
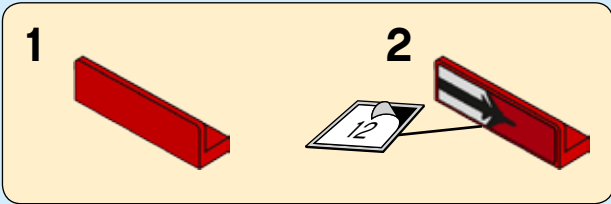





31

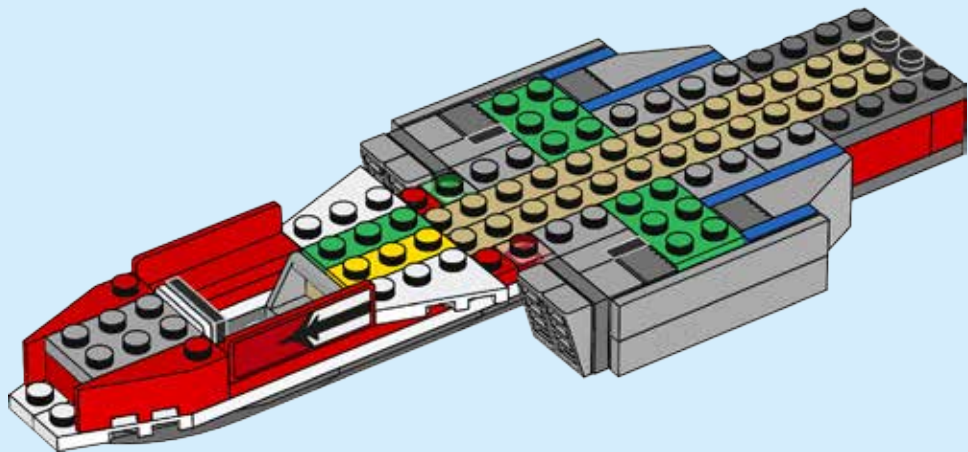

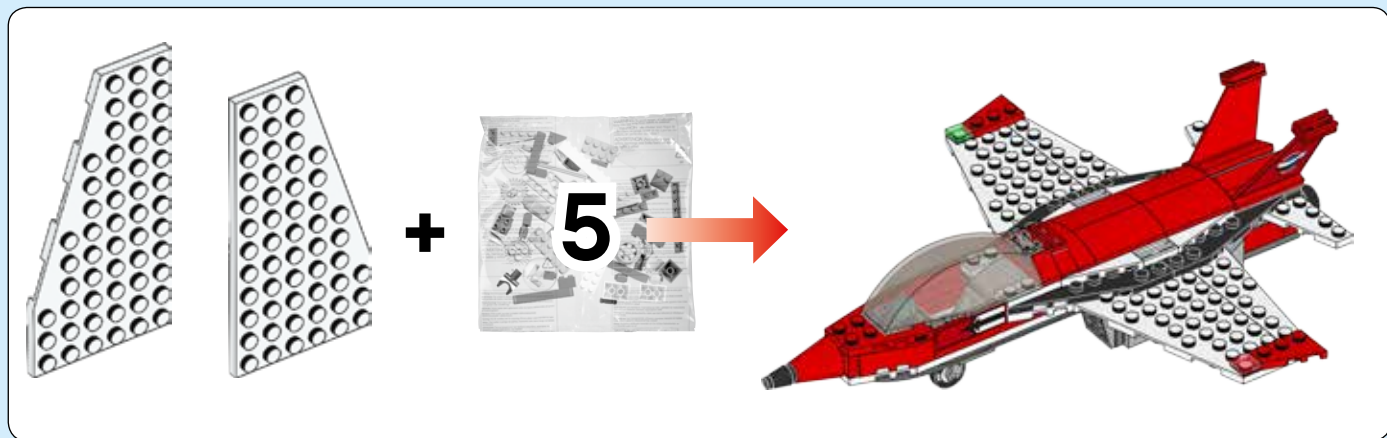



# 32

1

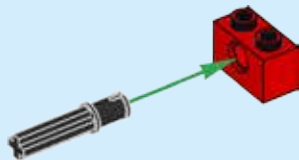

2



3



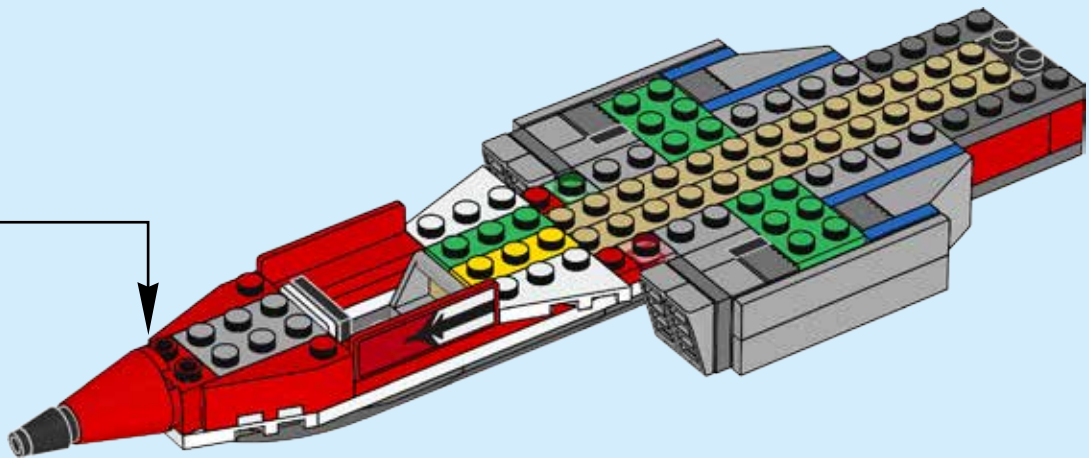



33

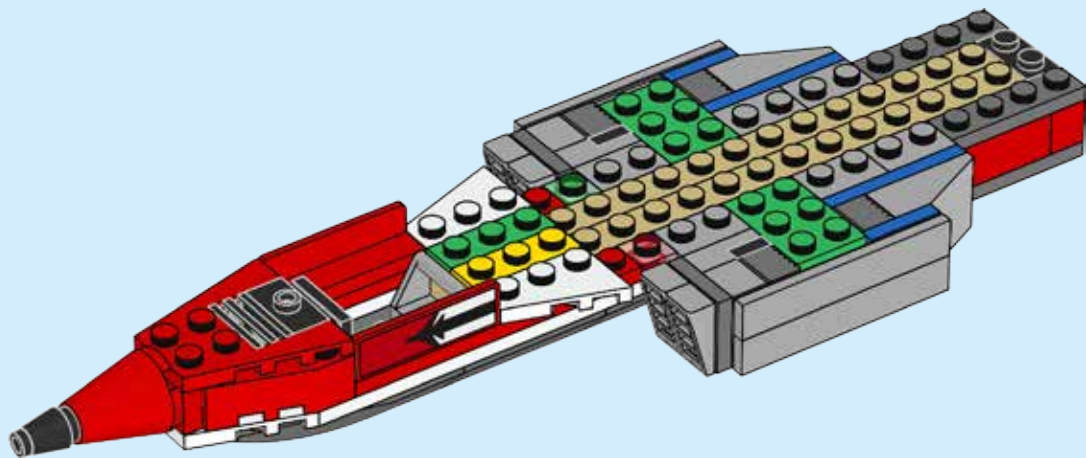



2x



2x

# 34

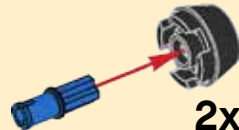

2x

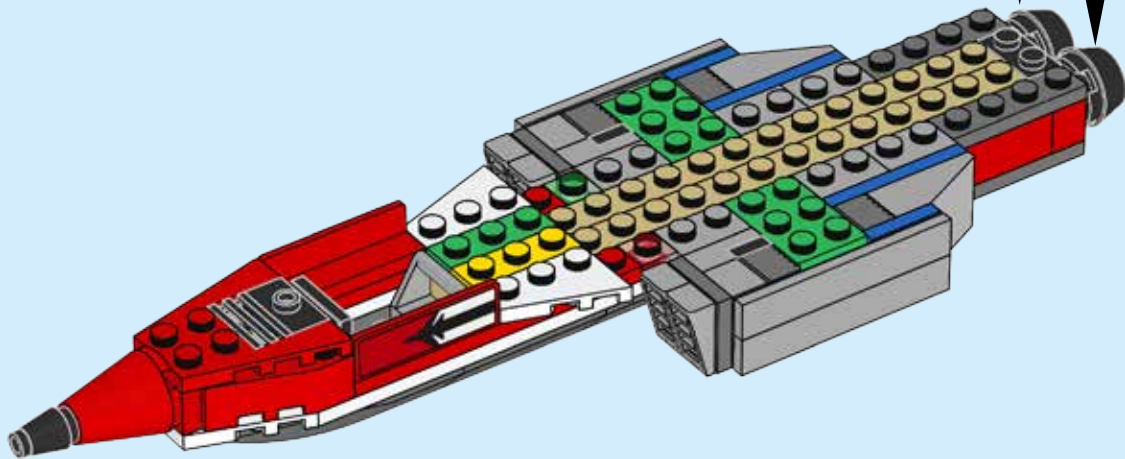

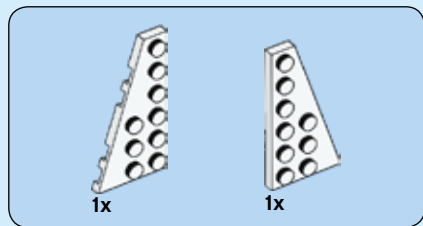

# 35

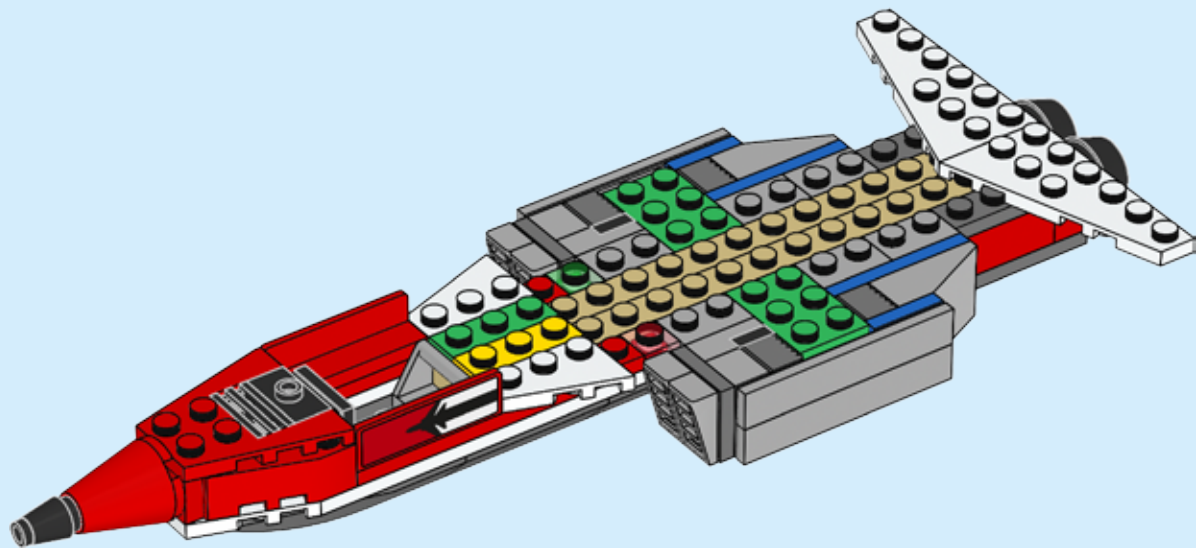



1x

# 36

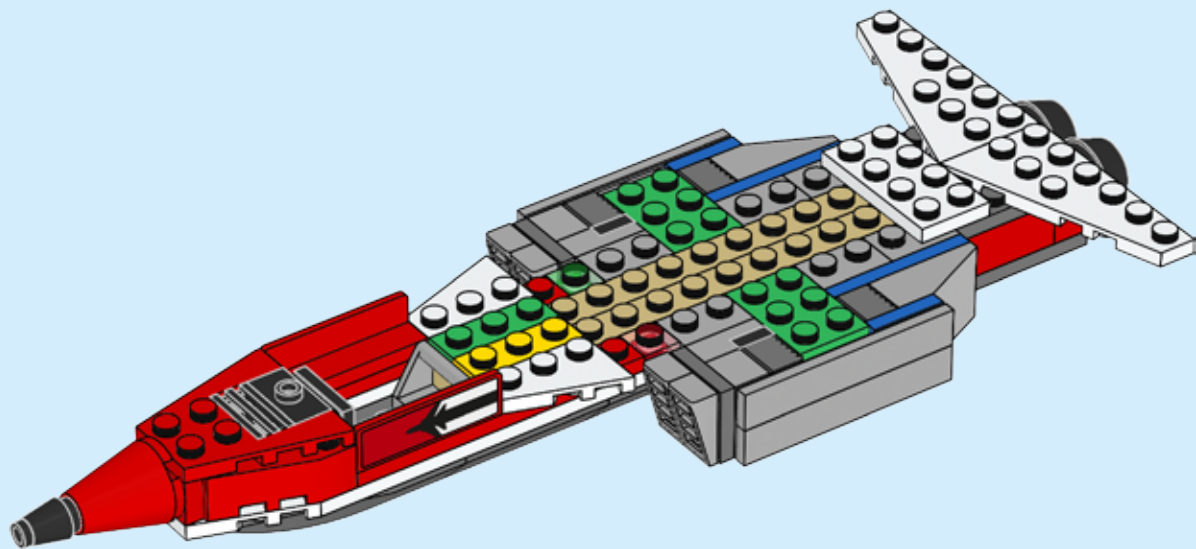



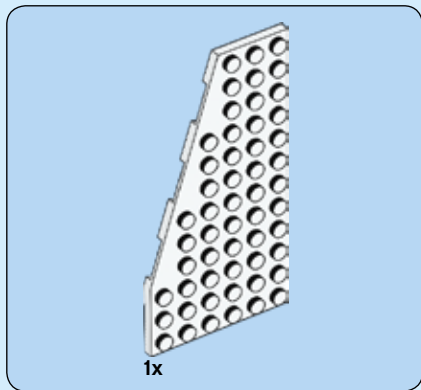

37

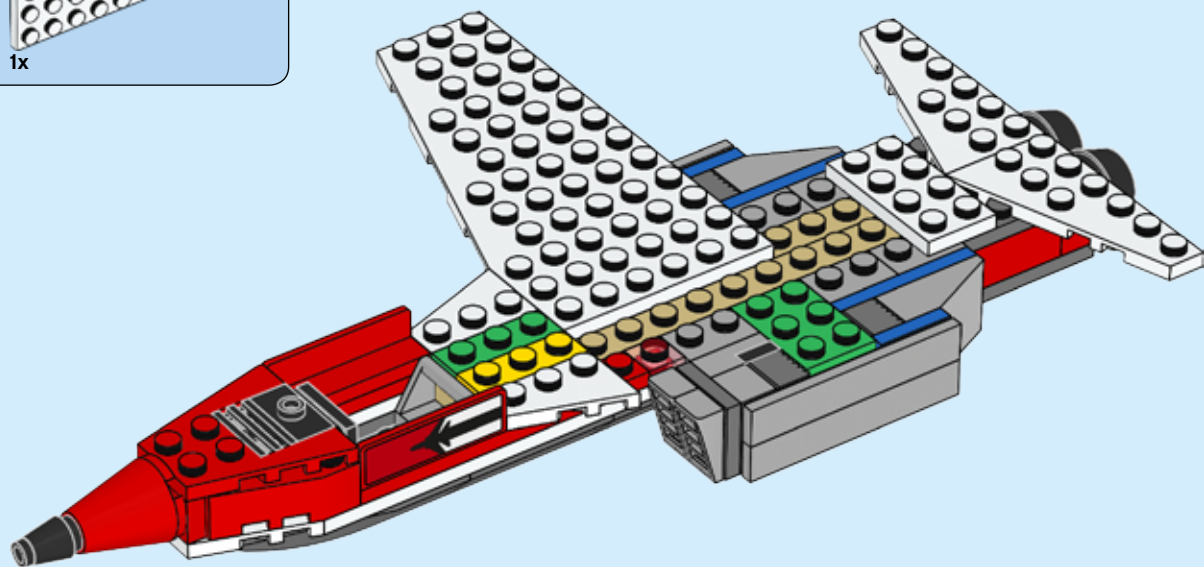

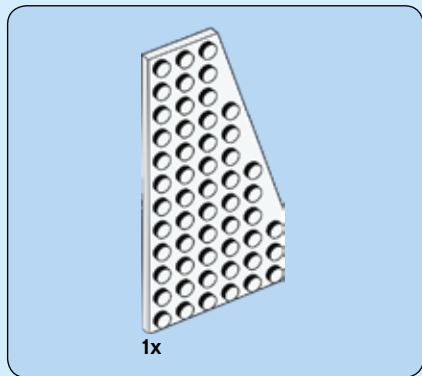

38

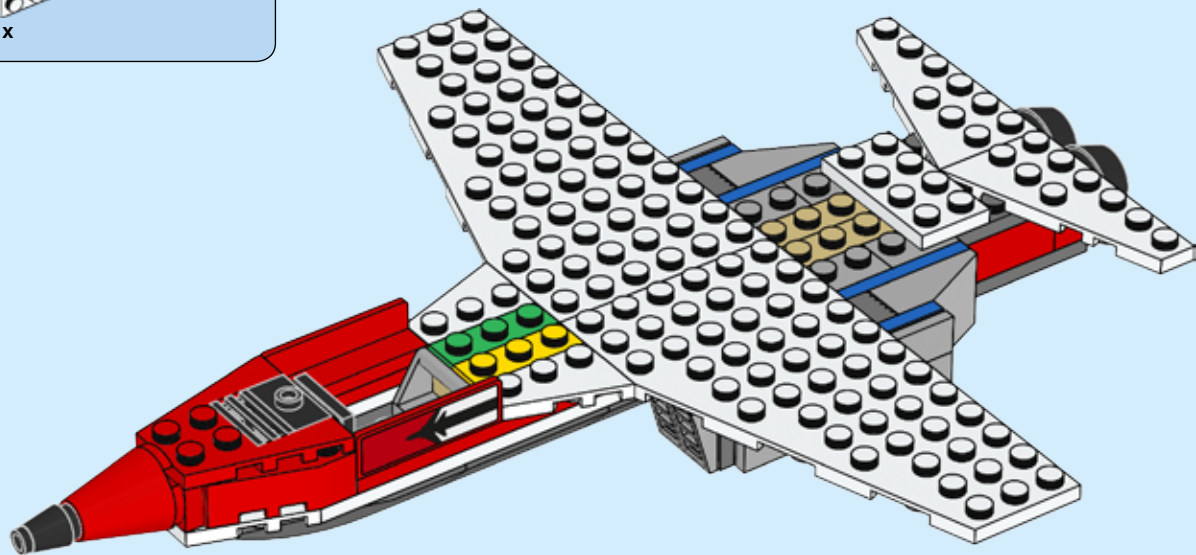

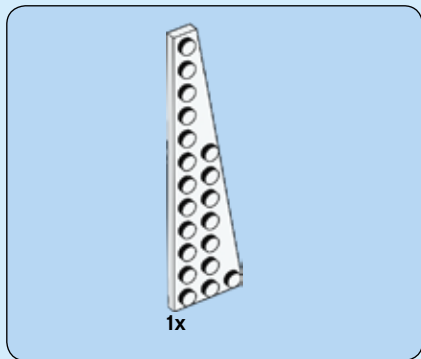

39

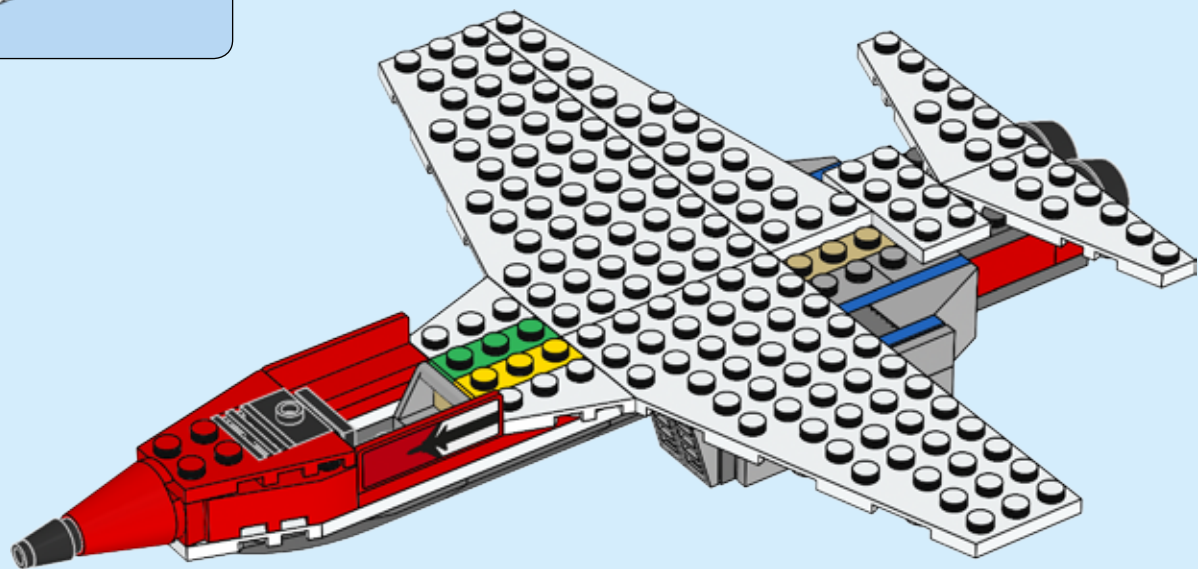

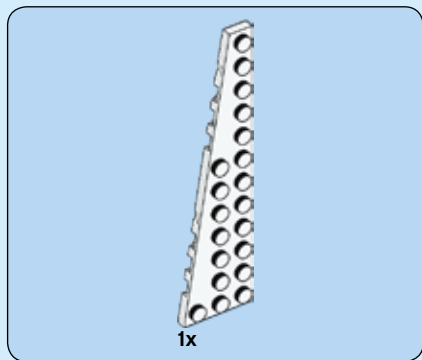

40

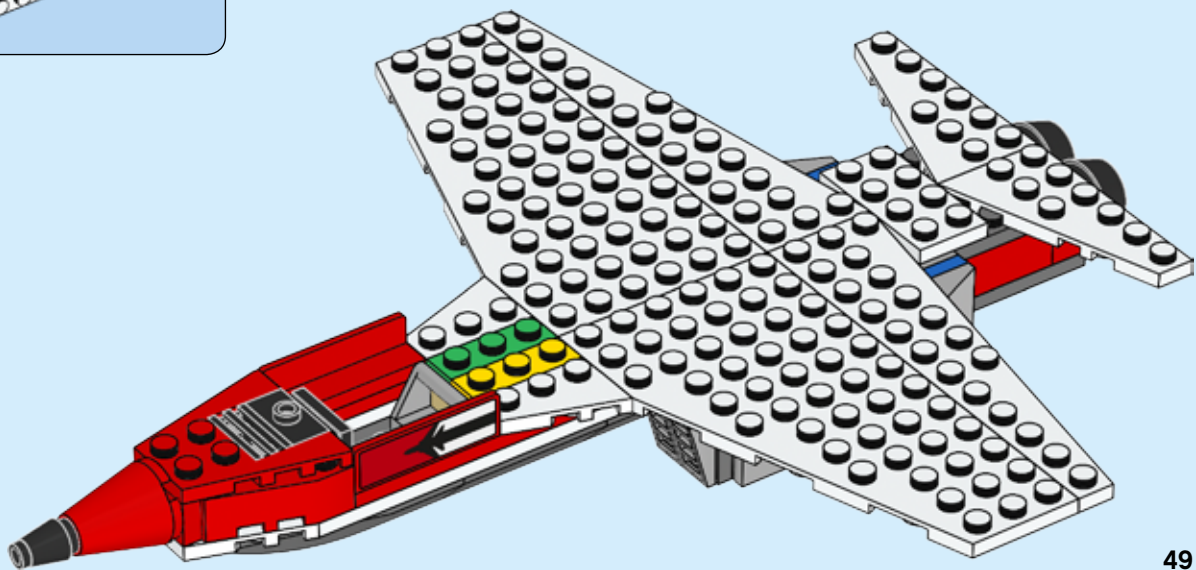

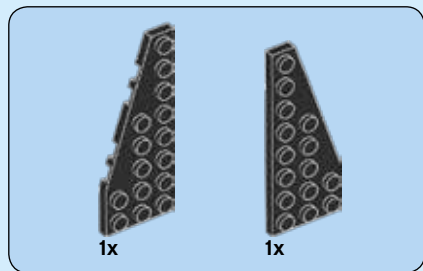

41

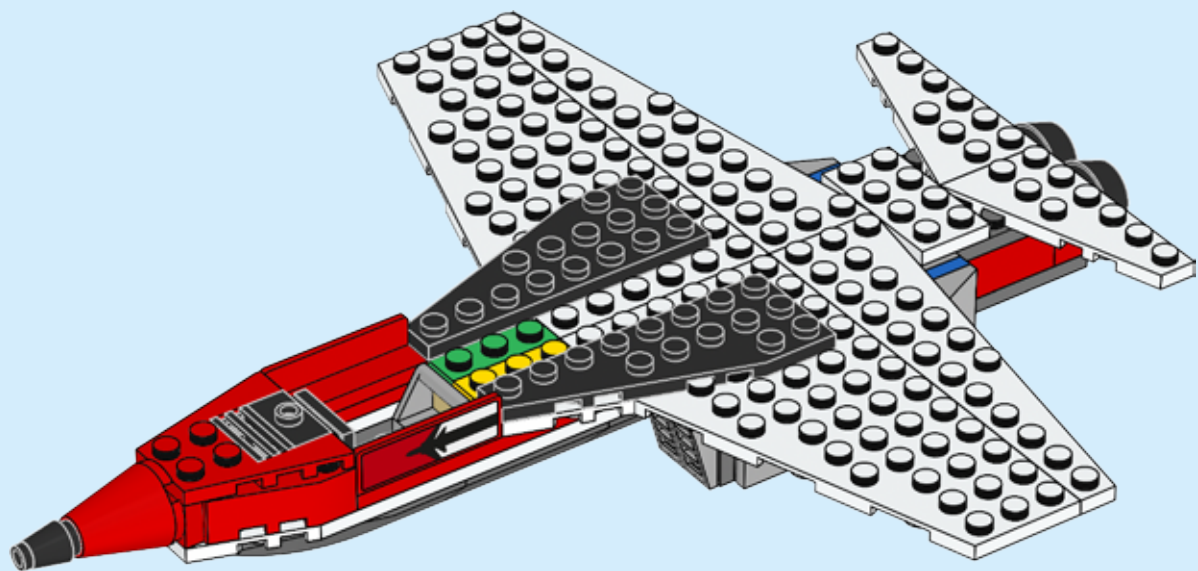

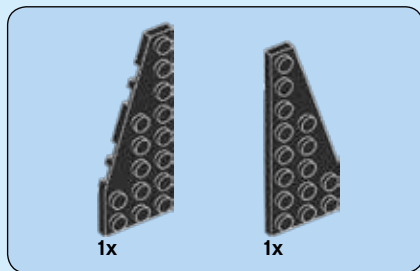

42

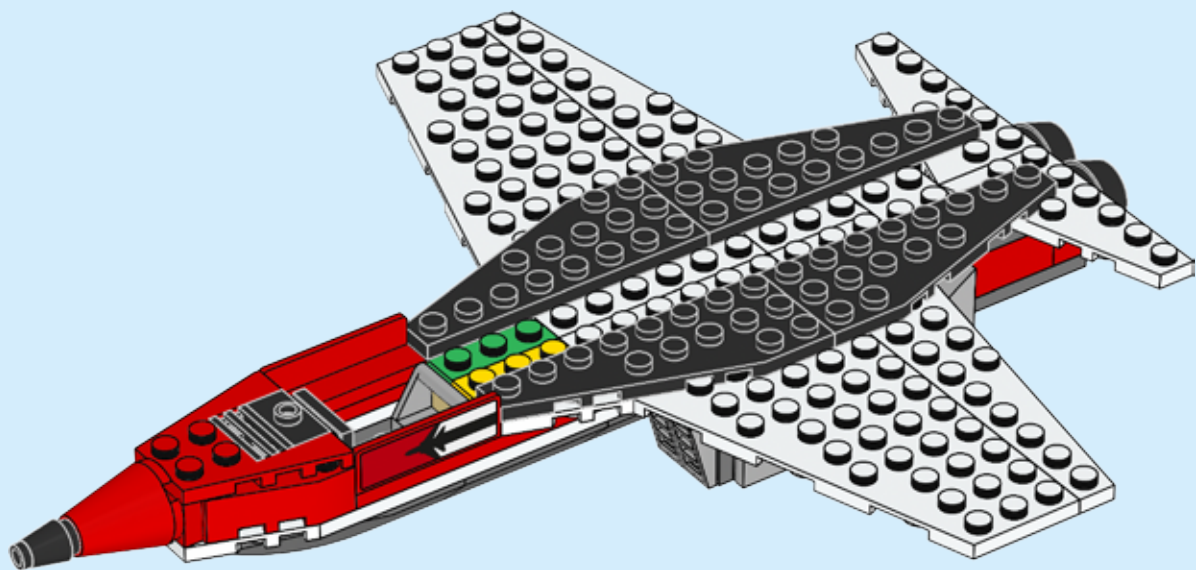



2x

# 43

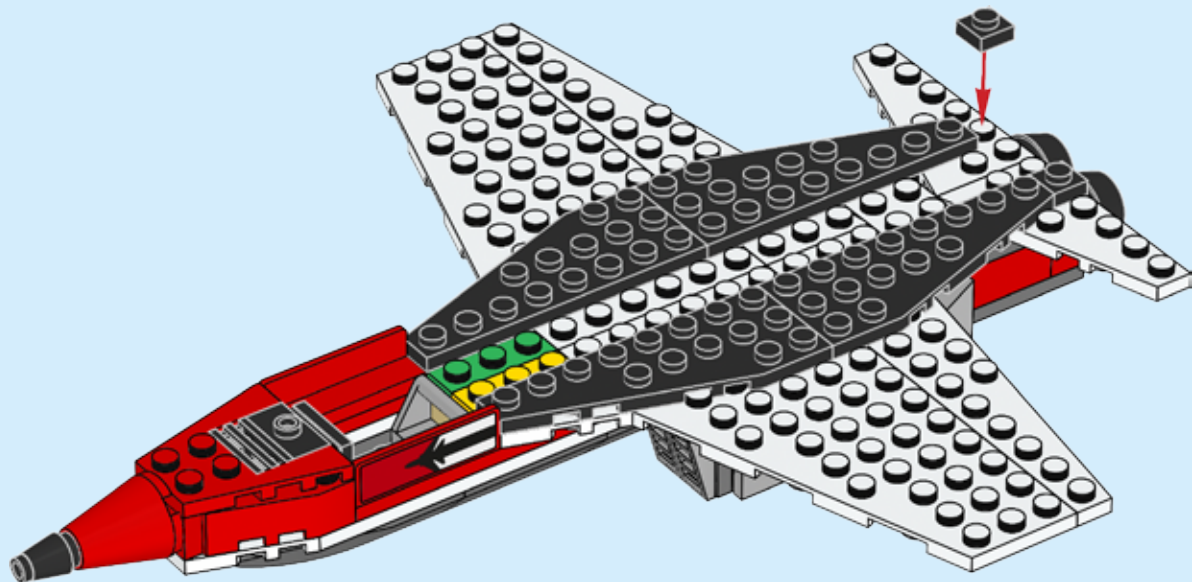





4x

# 44

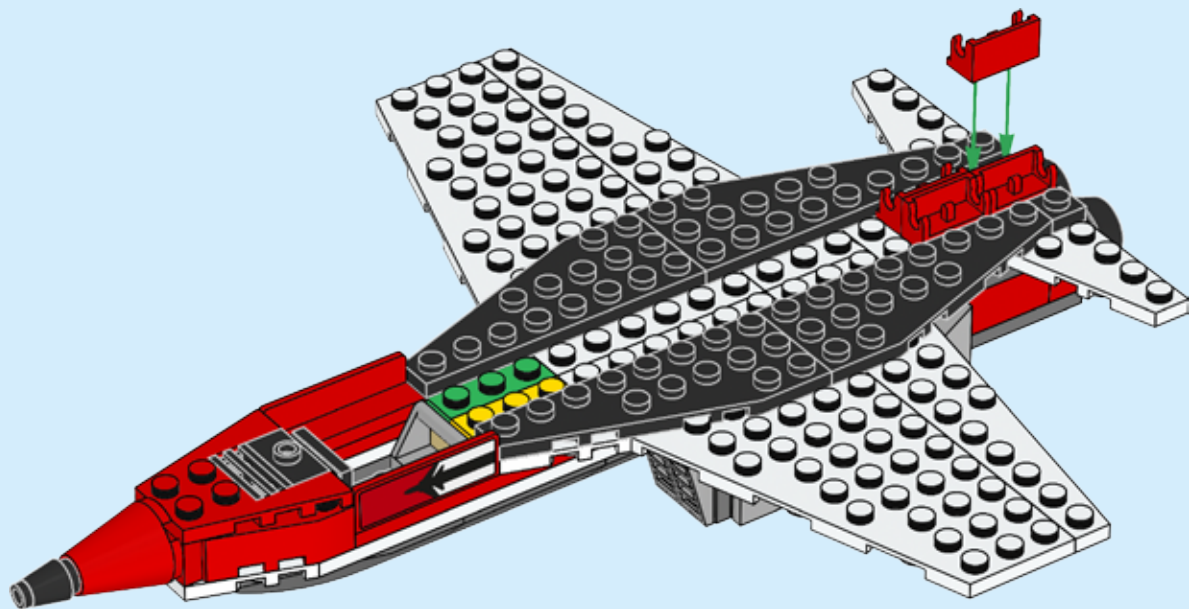



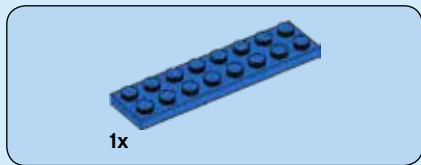

45

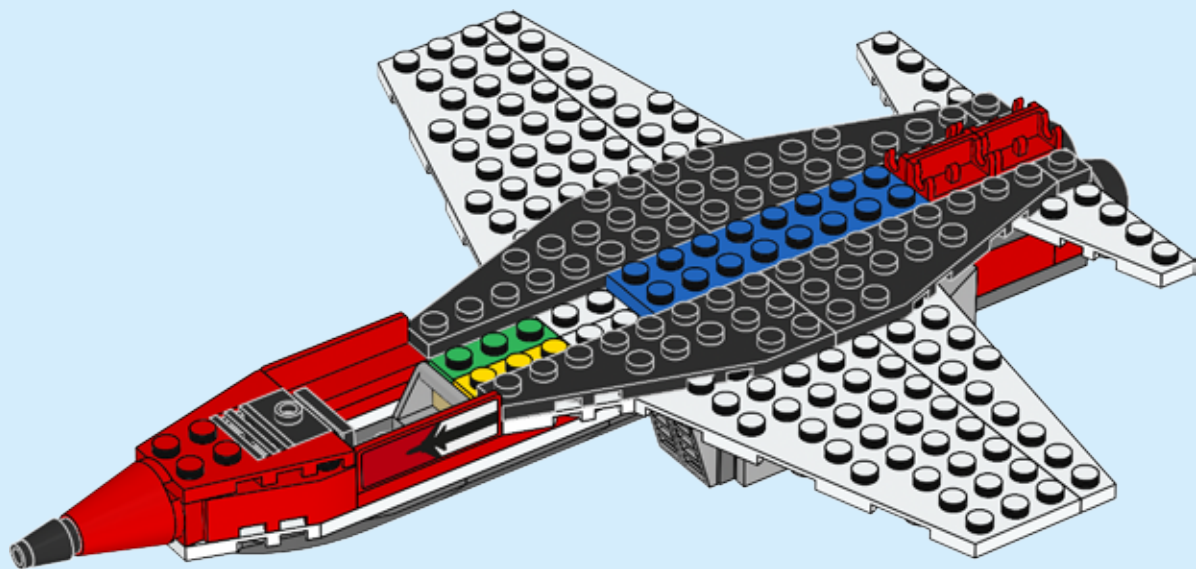



1x

# 46

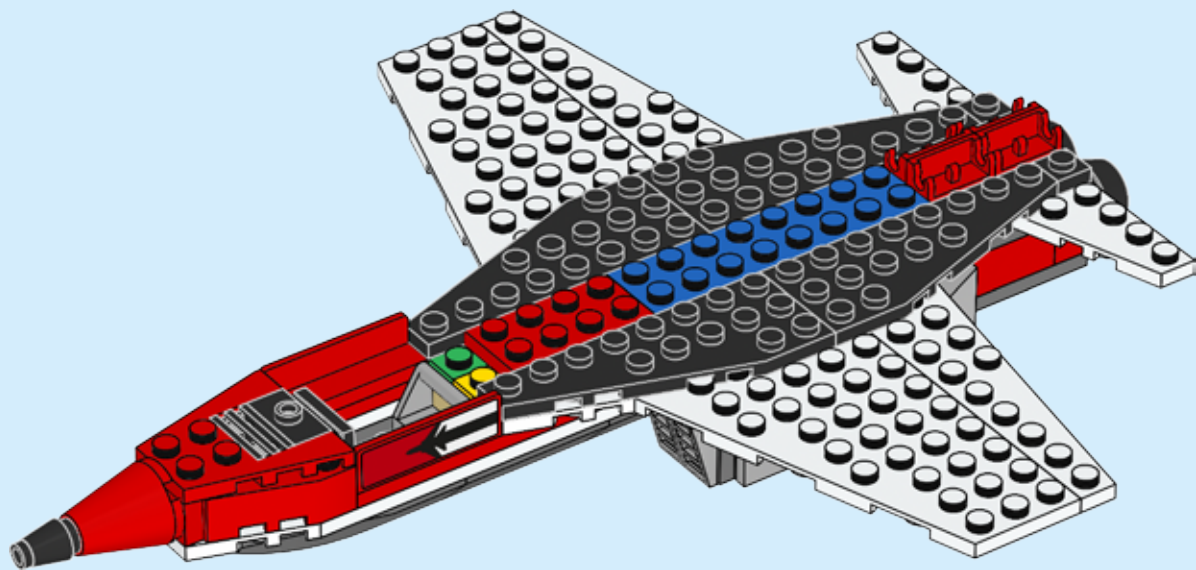



1x

47

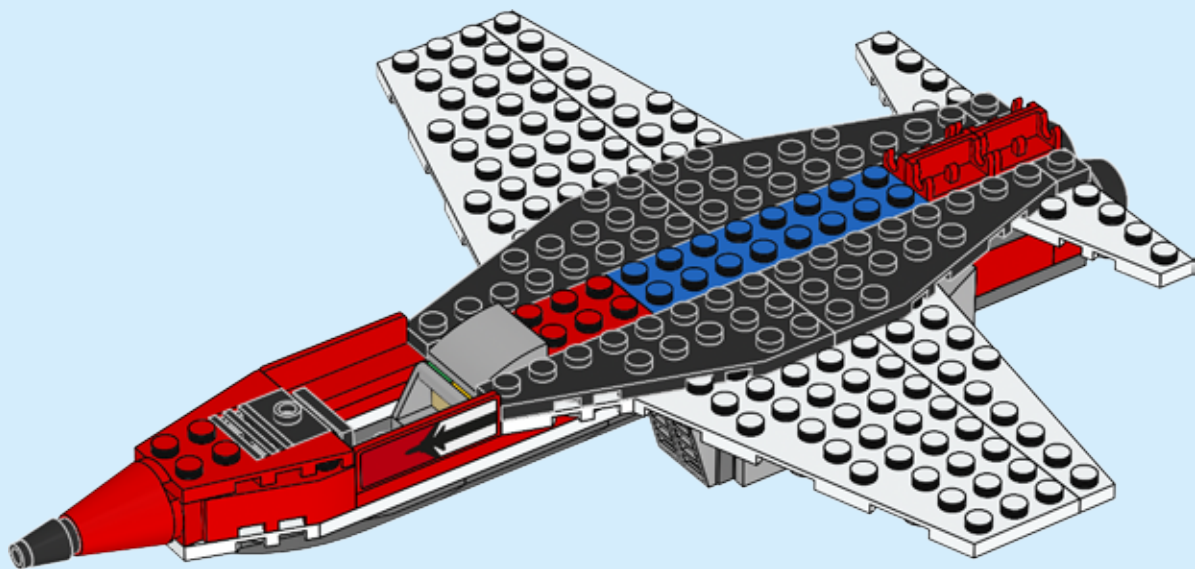

56



2x

48

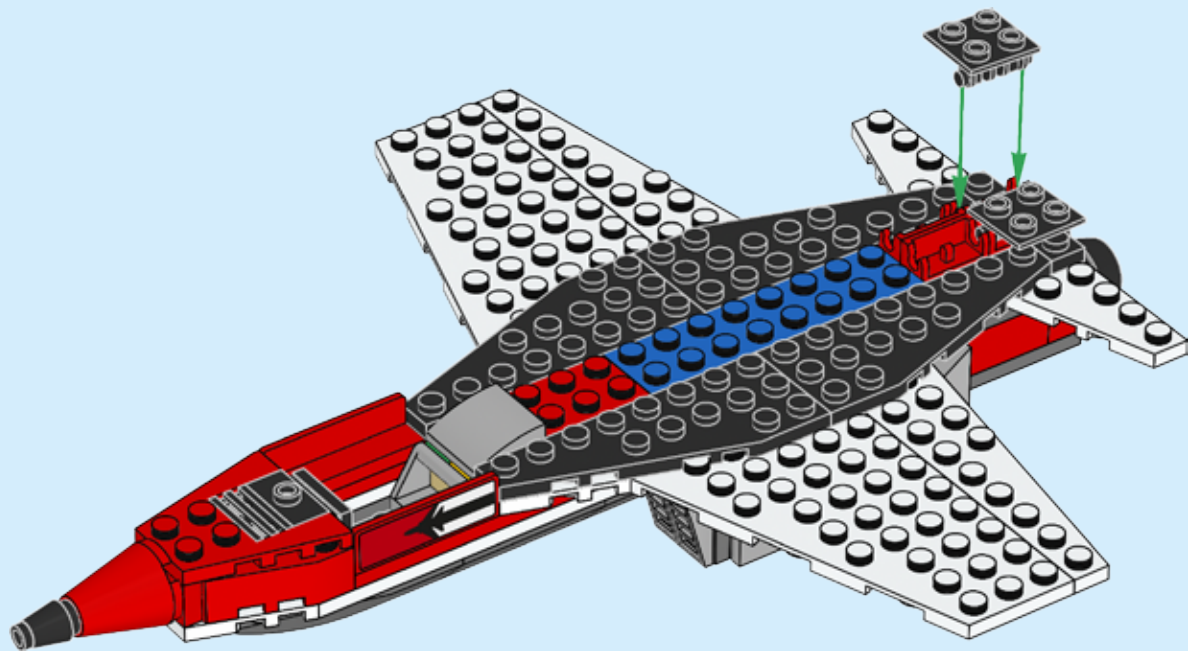



2x

# 49

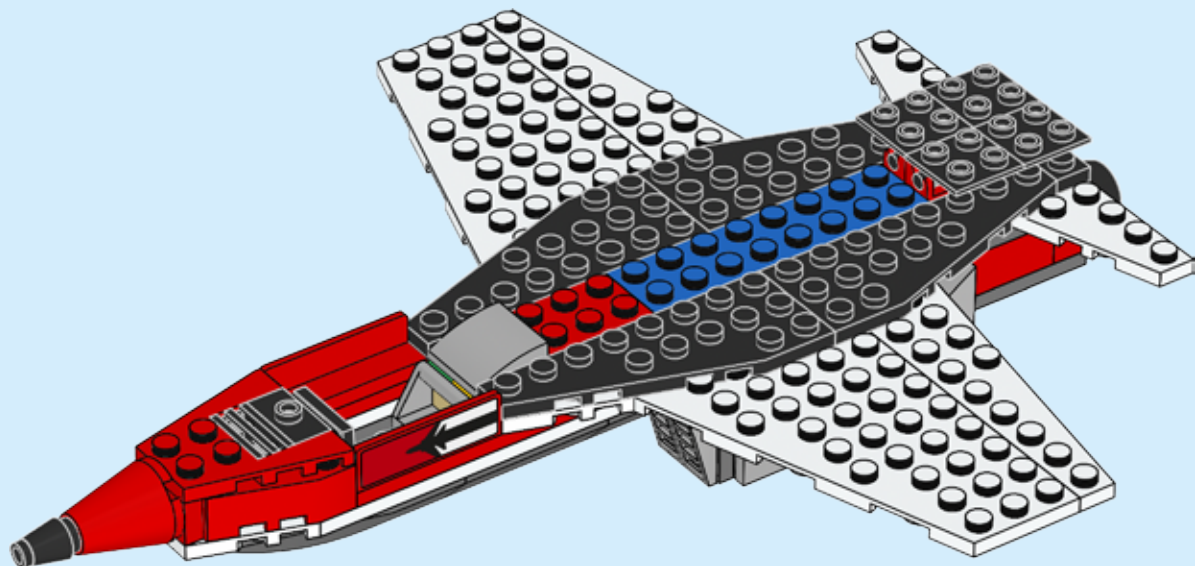

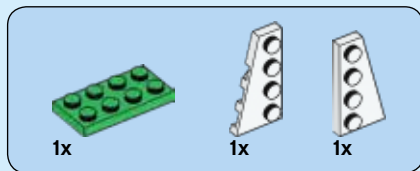

50

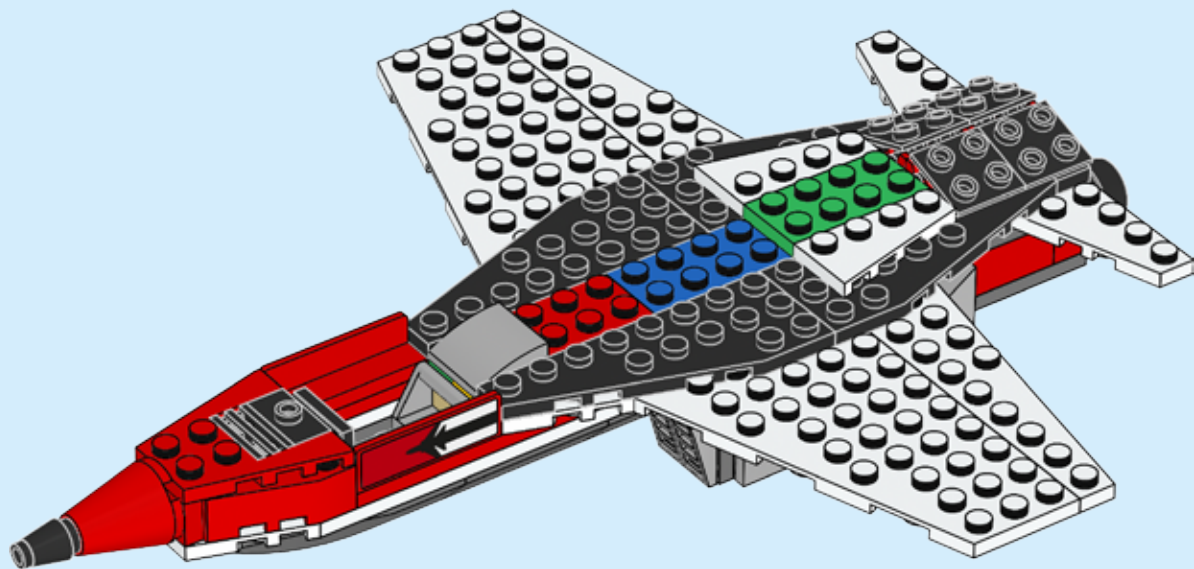



2x



1x

# 51

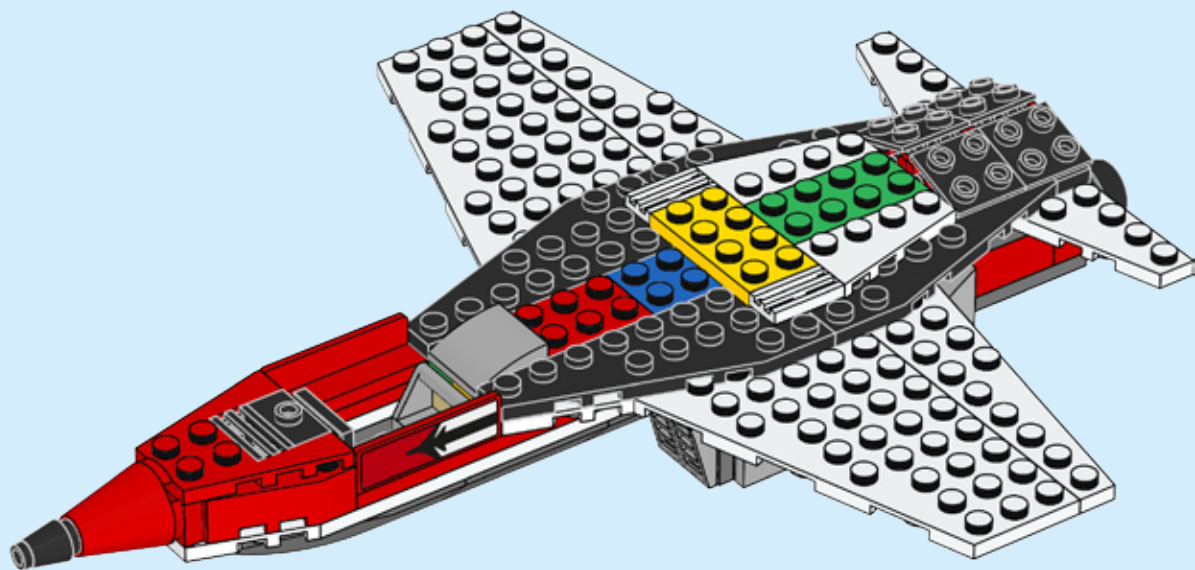





1x



1x

# 52

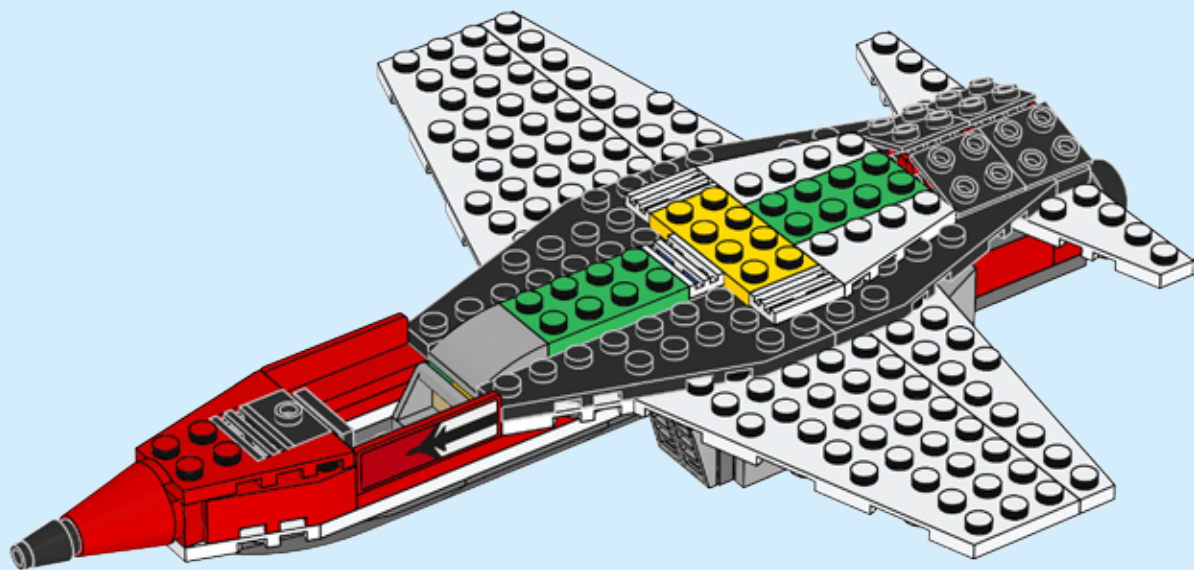





1x



1x

# 53

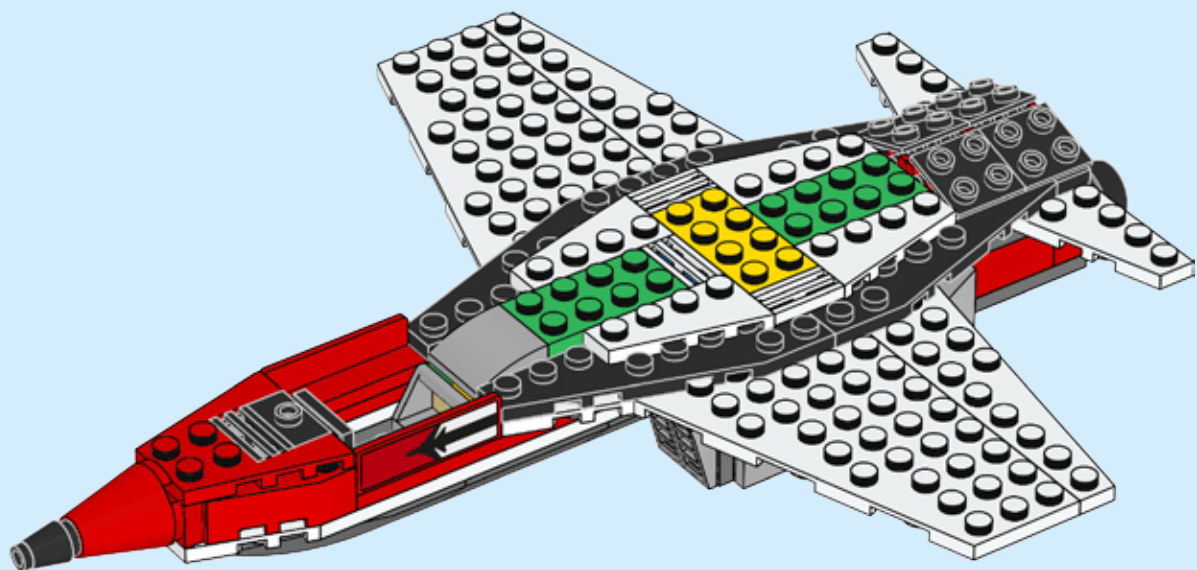



2x

# 54

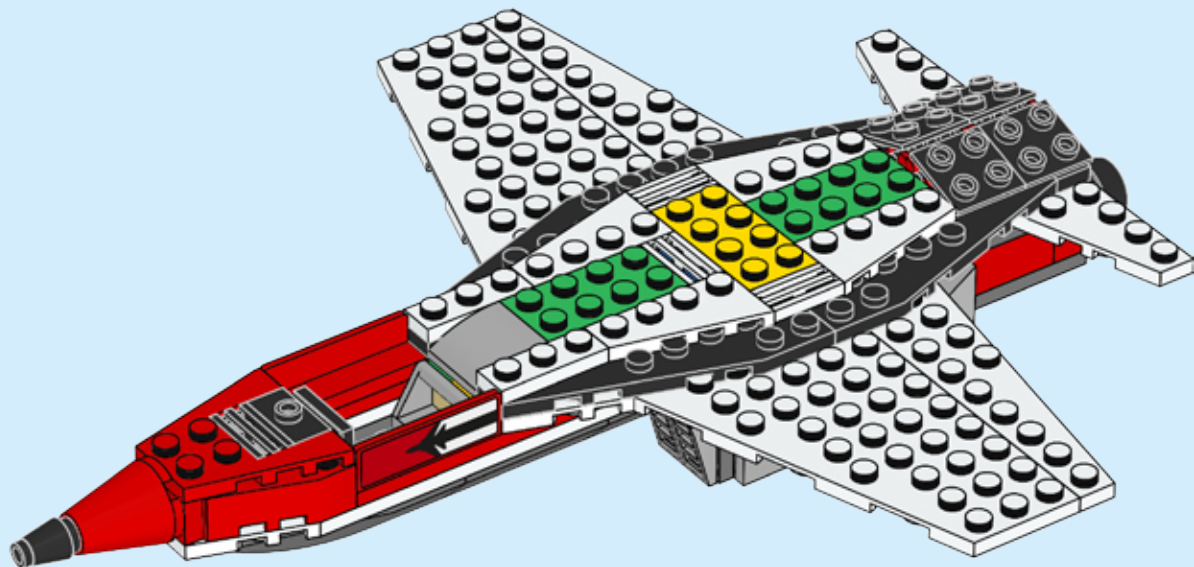



2x

# 55

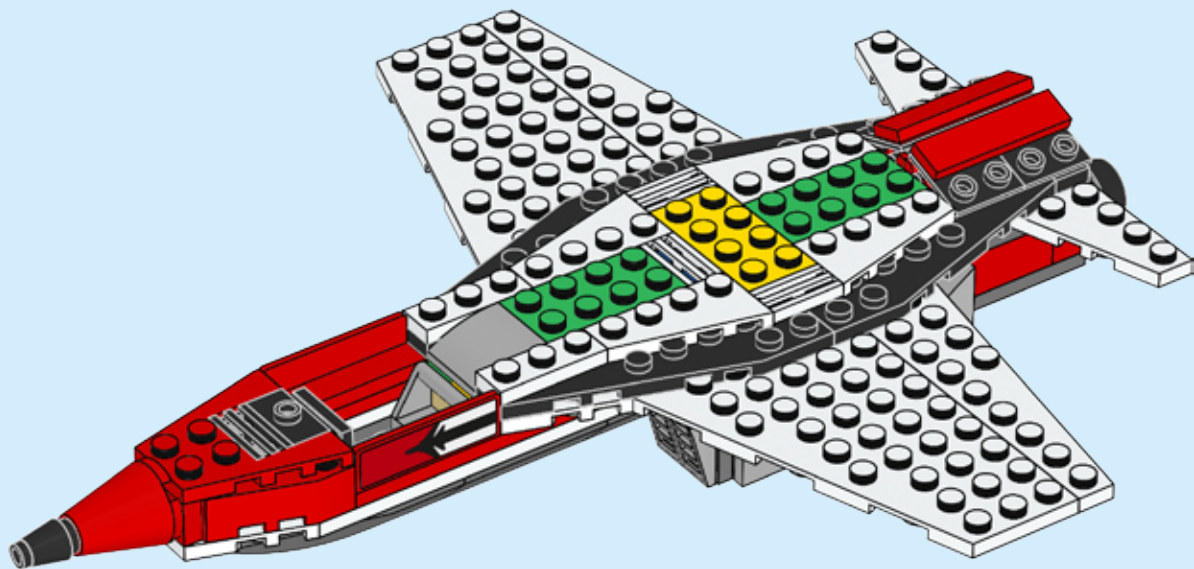



2x

# 56

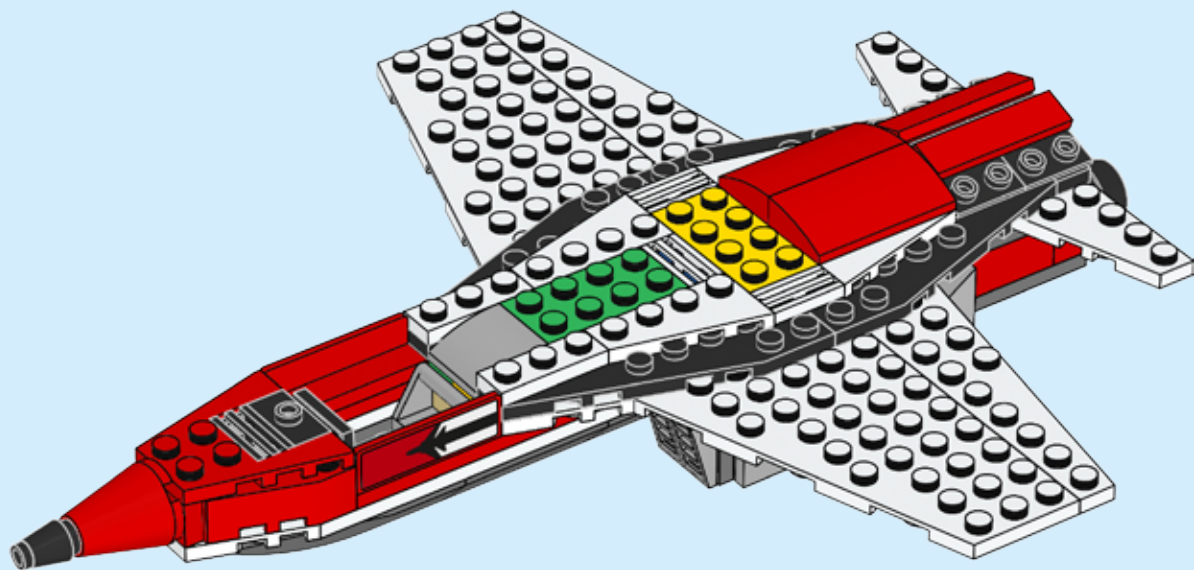



1x



2x

# 57

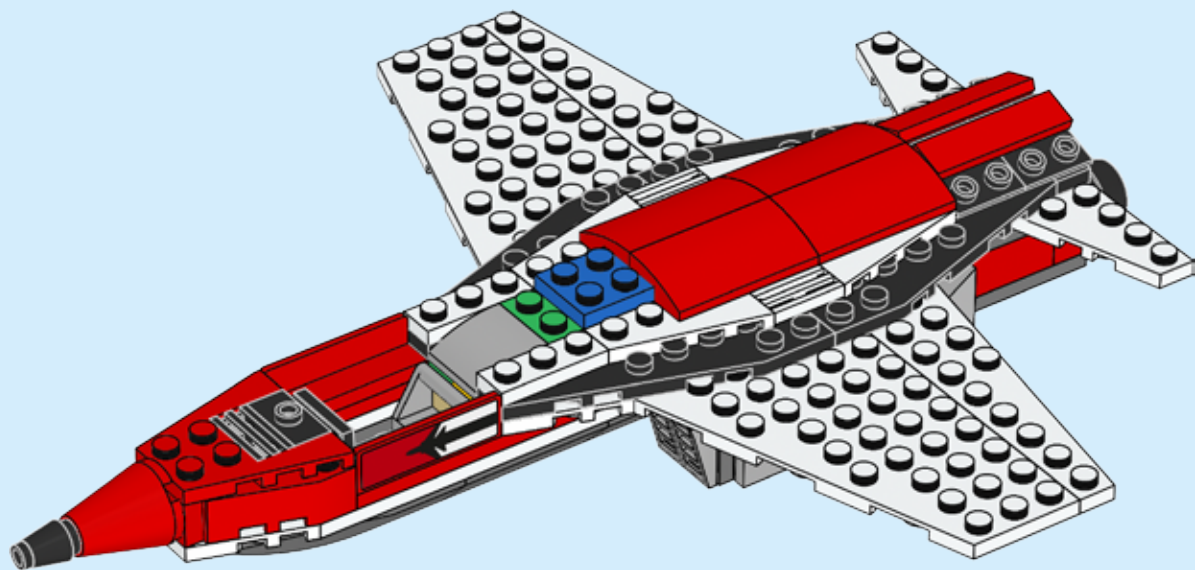



2x



1x

# 58

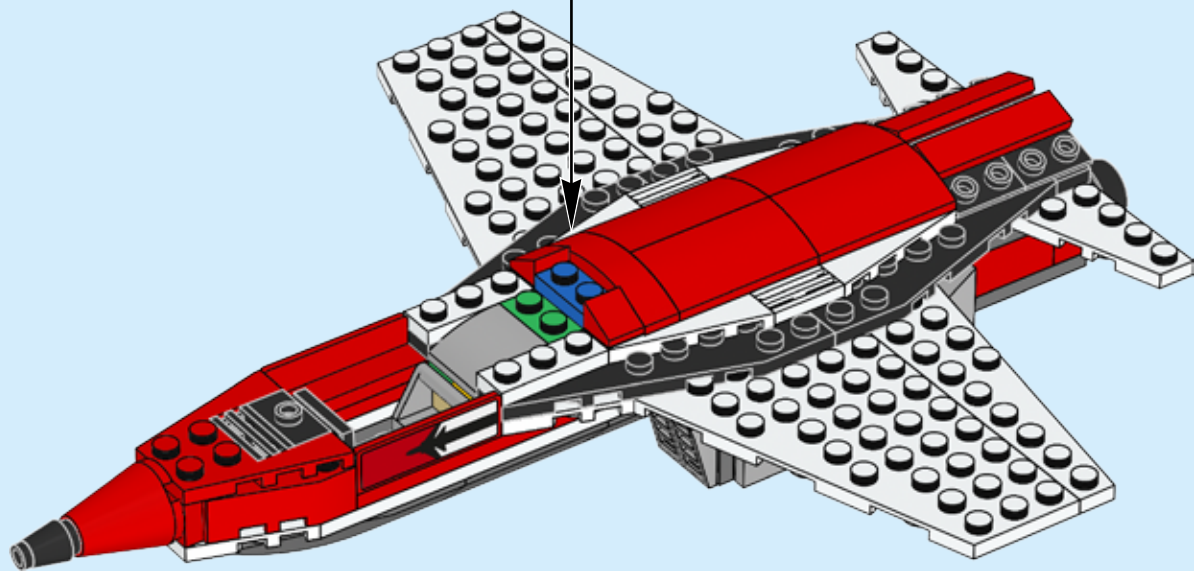
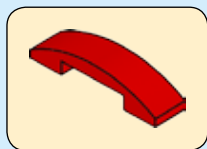



2x

# 59

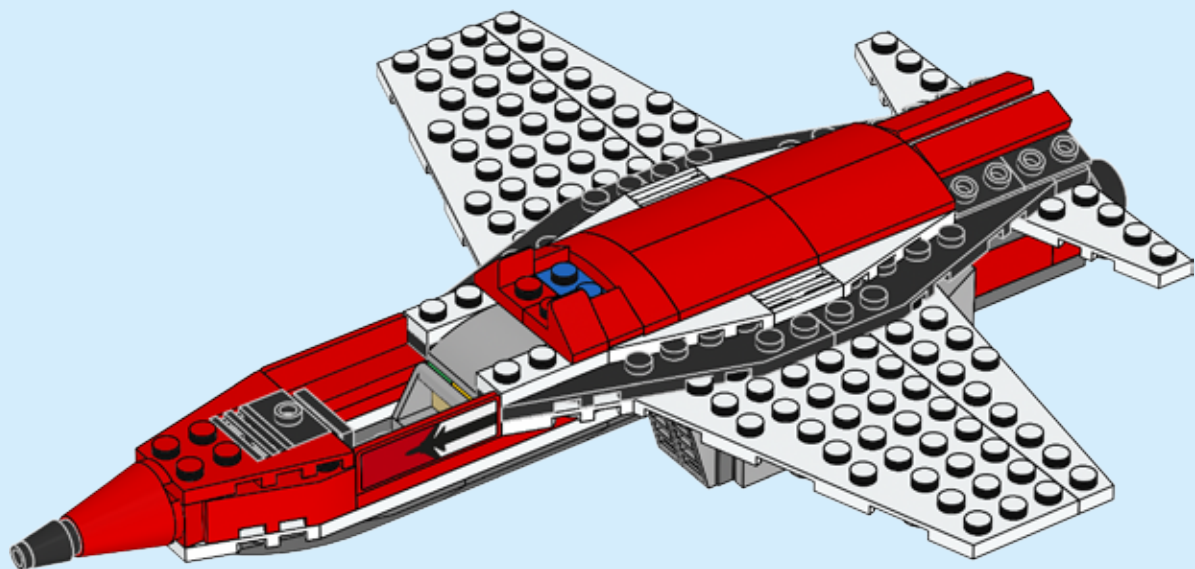





2x

60



2x

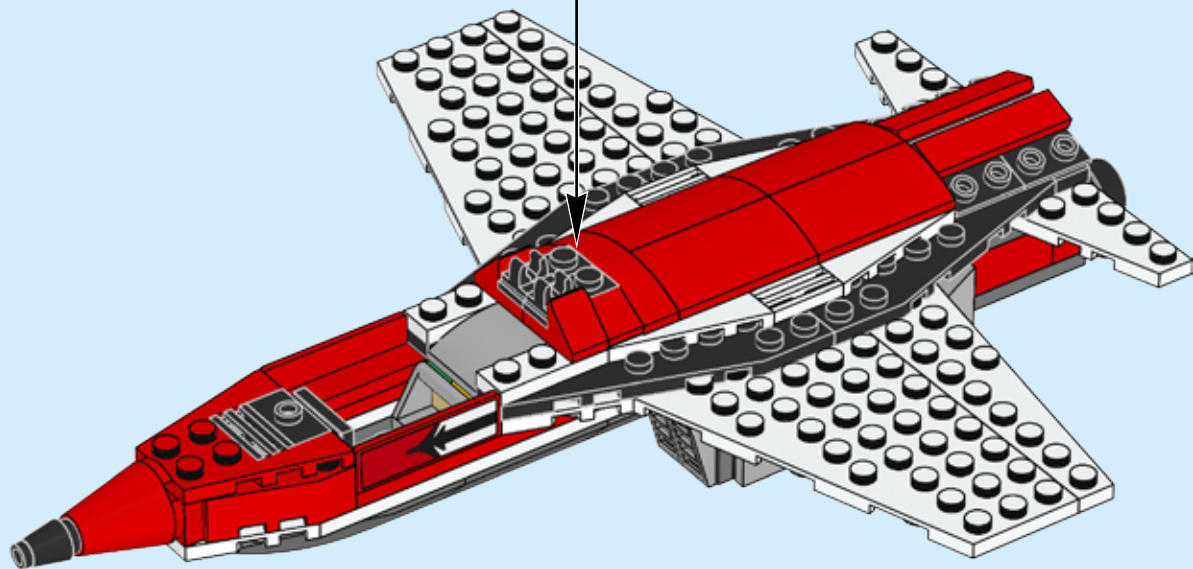





1x

# 61

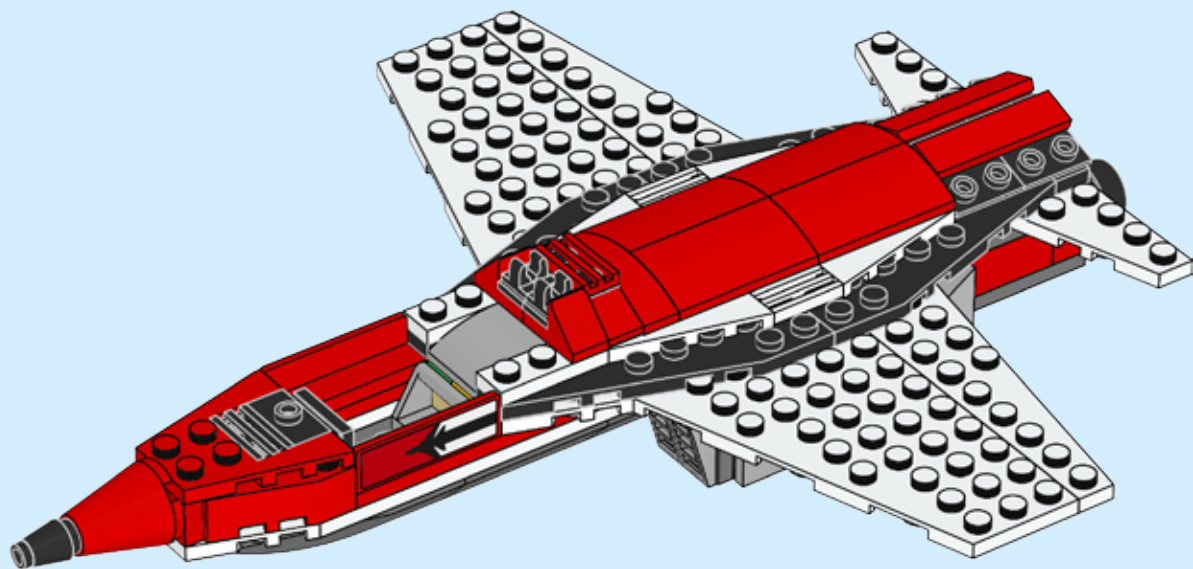

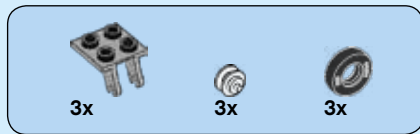

62

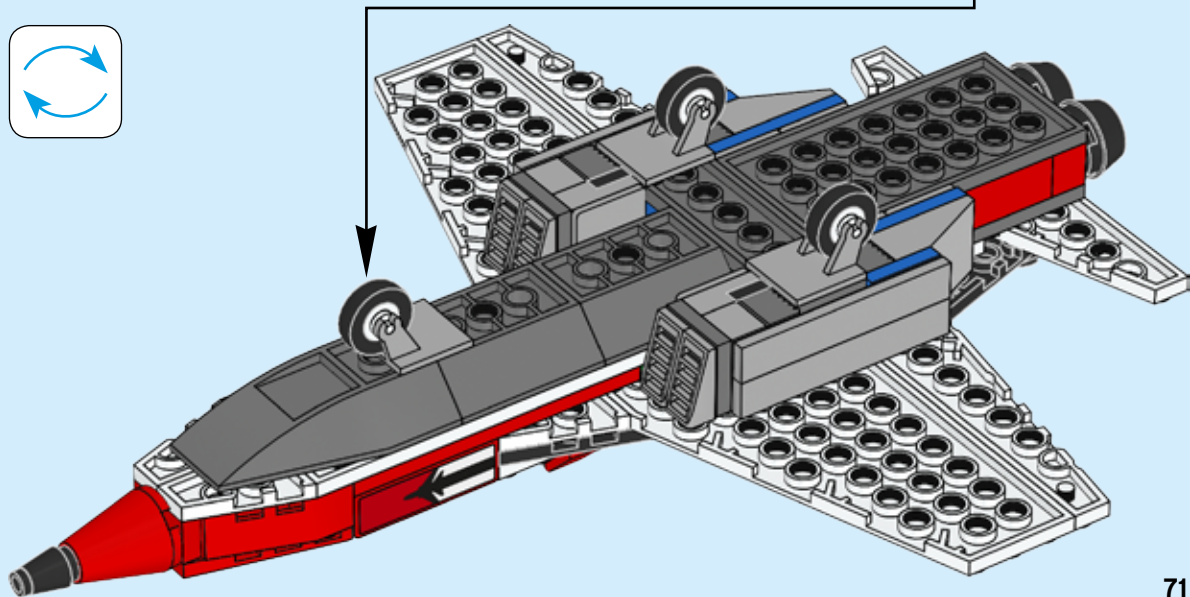
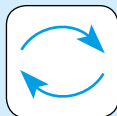
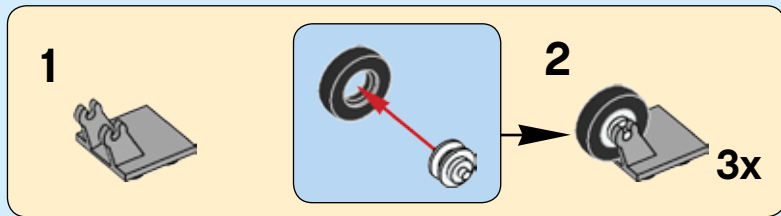



63

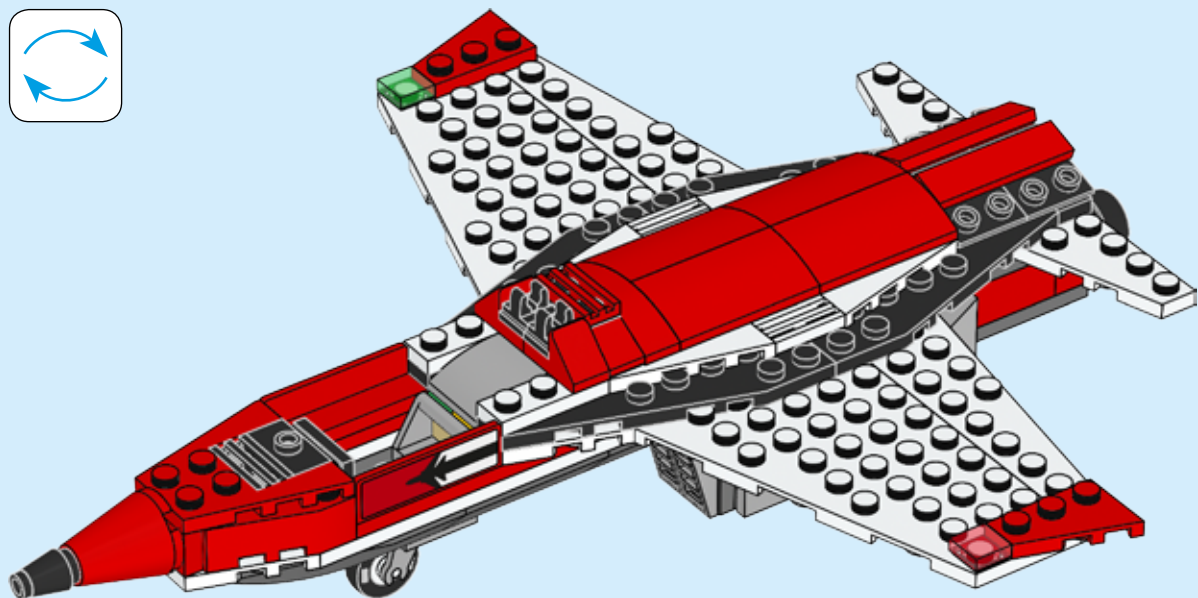
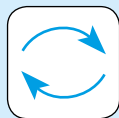

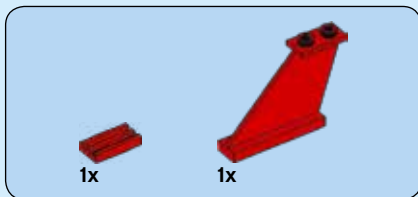

# 64

1

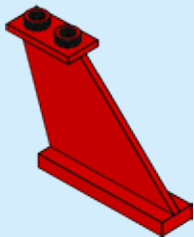

2

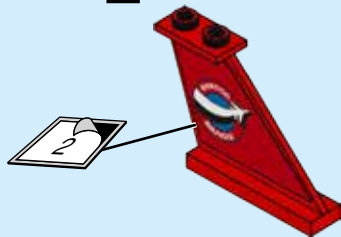

3

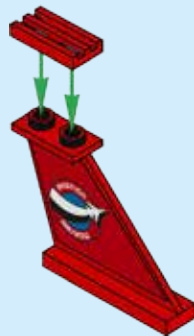

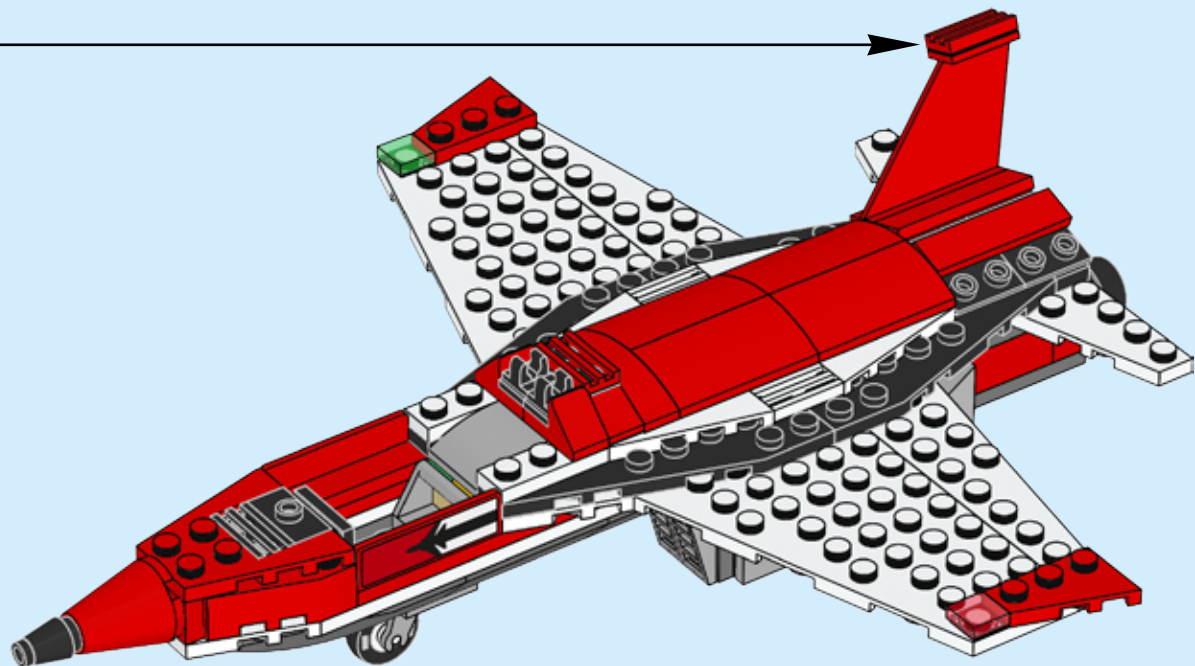

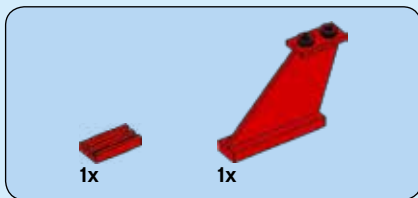

# 65

1

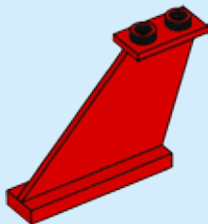

2

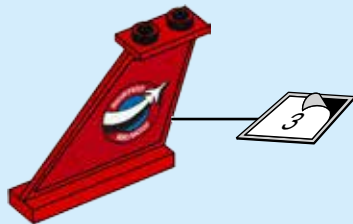

3



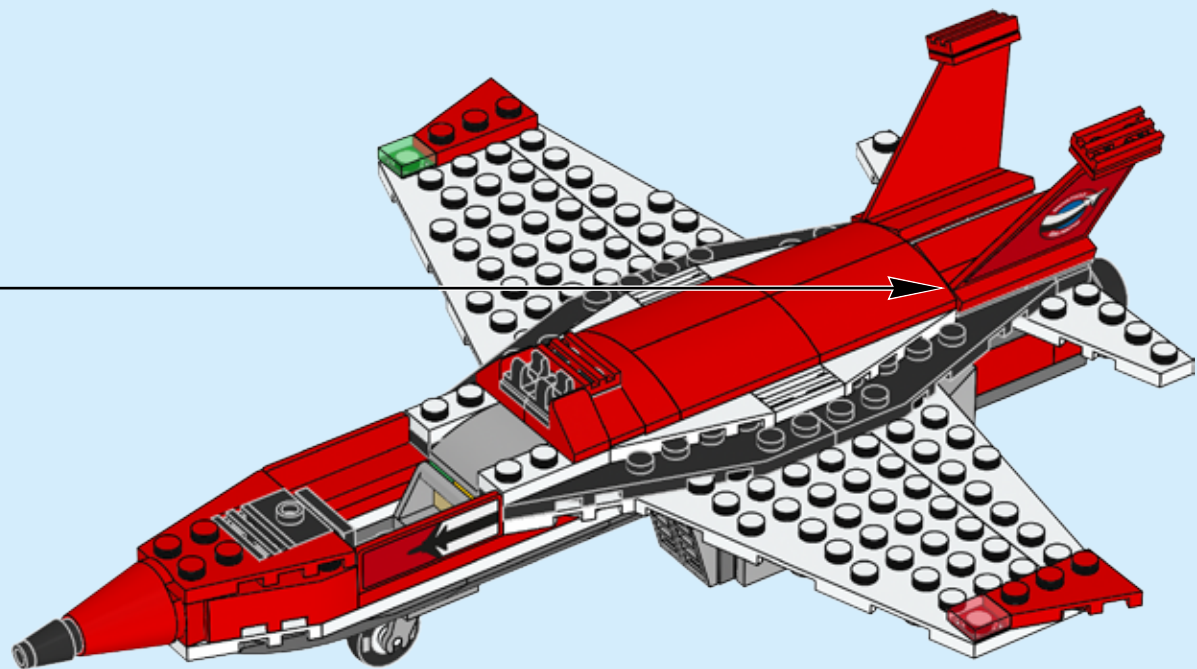



1x

66

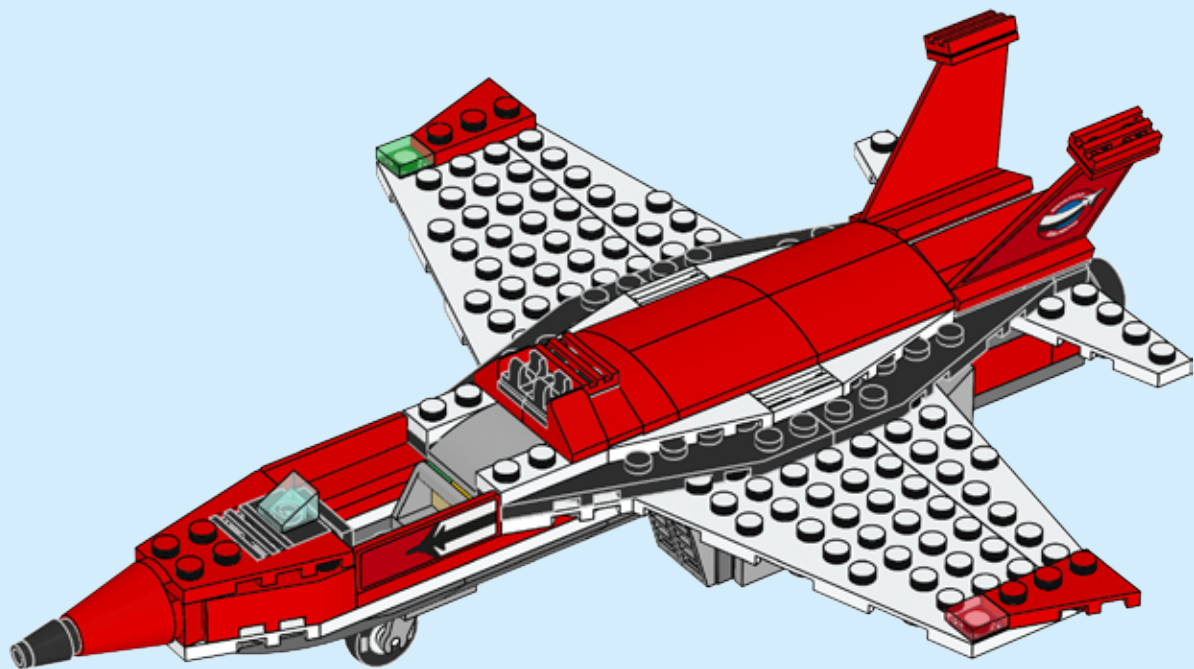



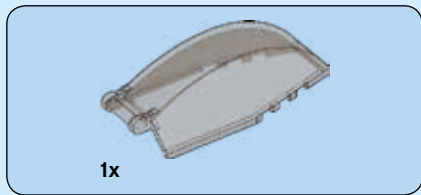

67

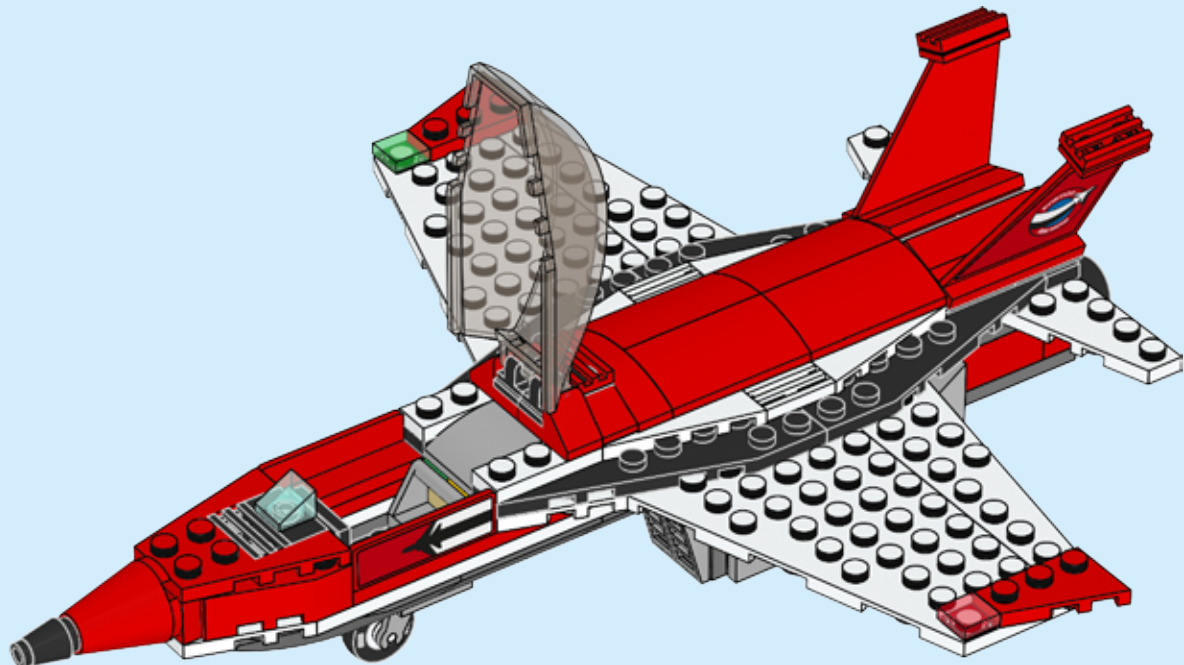

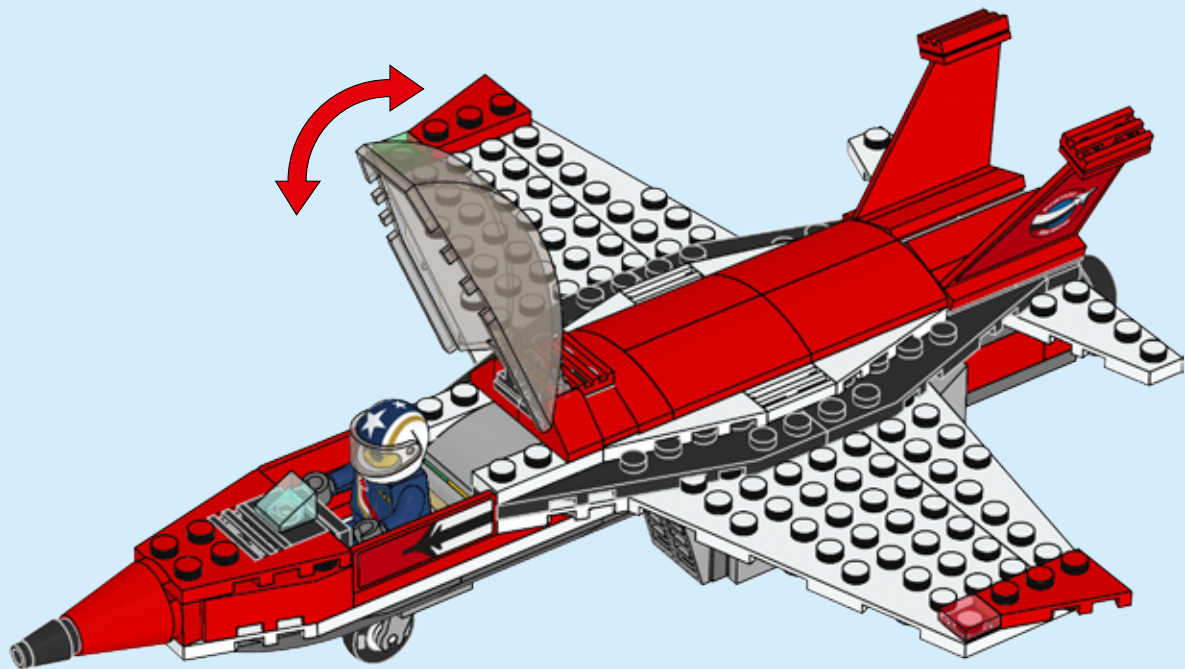



LEGO and the LEGO logo are trademarks of the LEGO Group.  
©2016 The LEGO Group. 6162938



60124



60123



60122



60121



60120



# CITY

60103





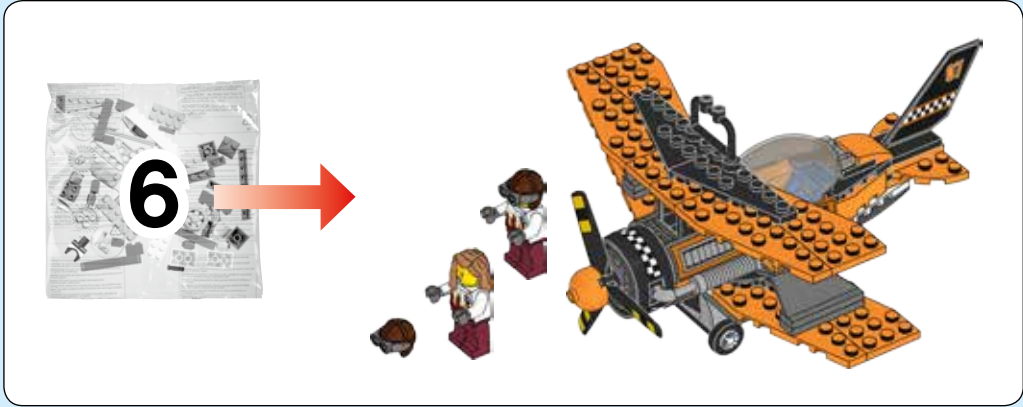

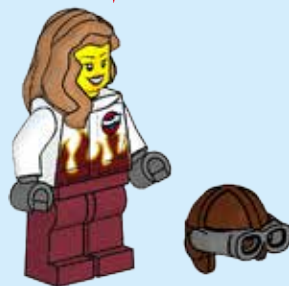
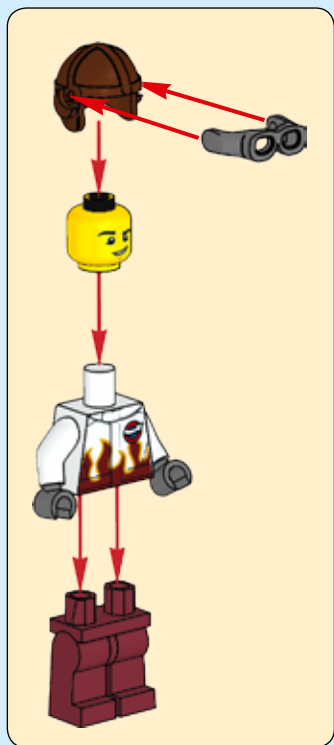

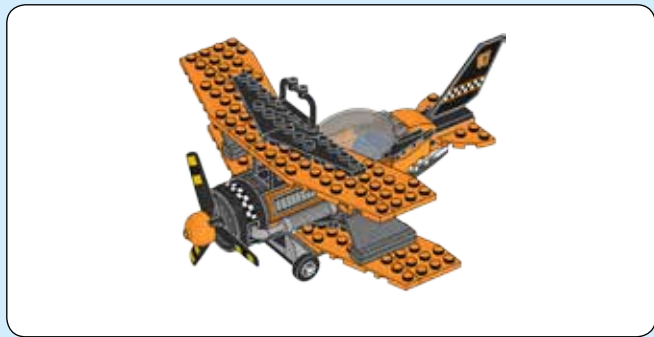

1x

1

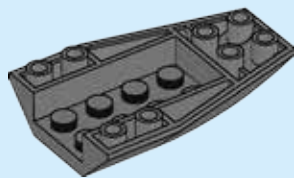

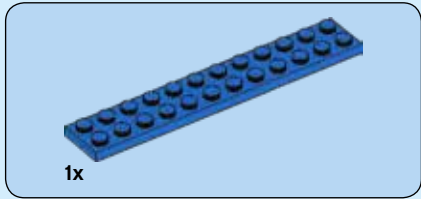

2

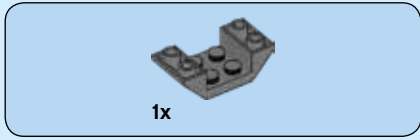
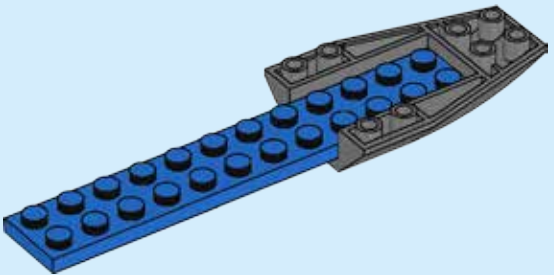

3

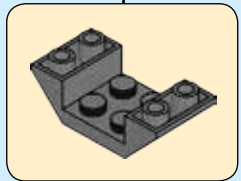
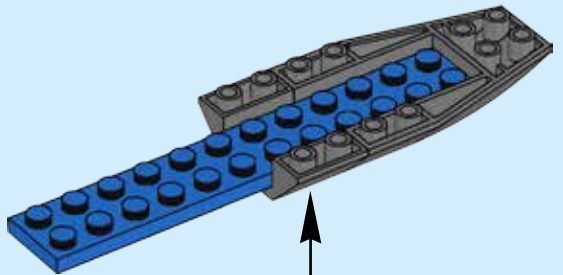



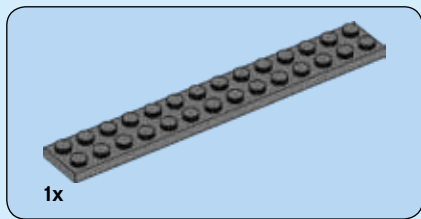

4

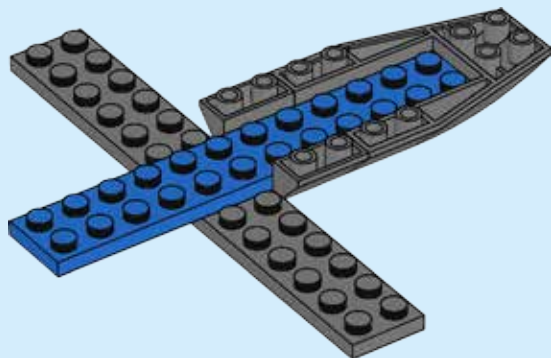

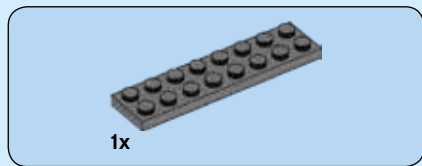

5

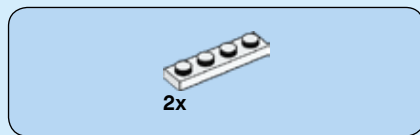
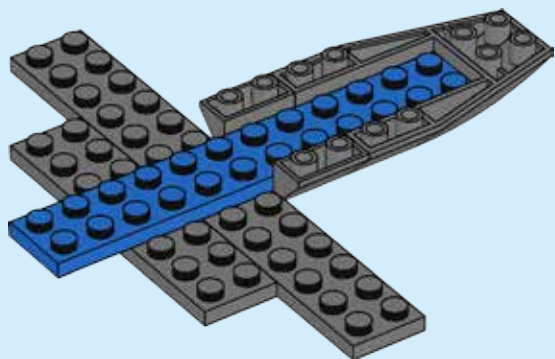

6

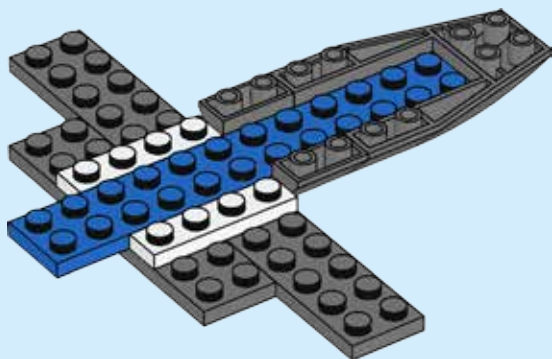

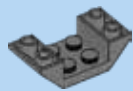

1x

7

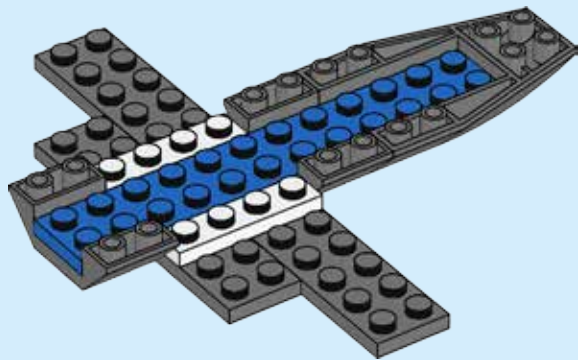

8



1x

8

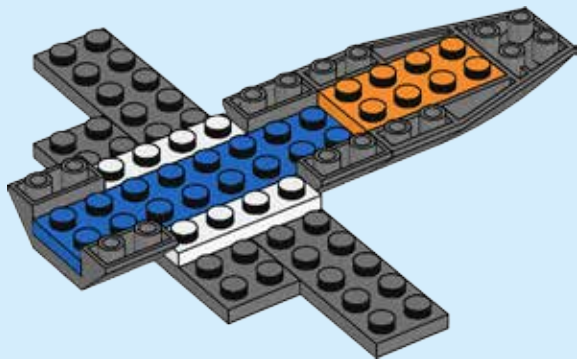

1x



1x

9

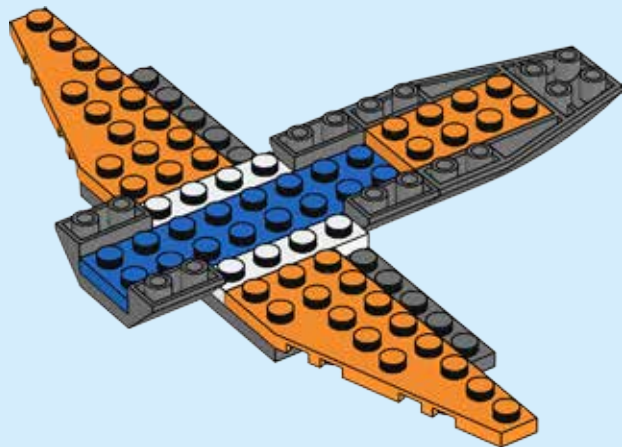

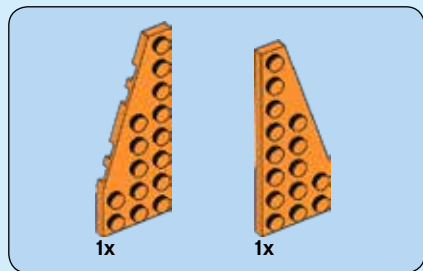

10

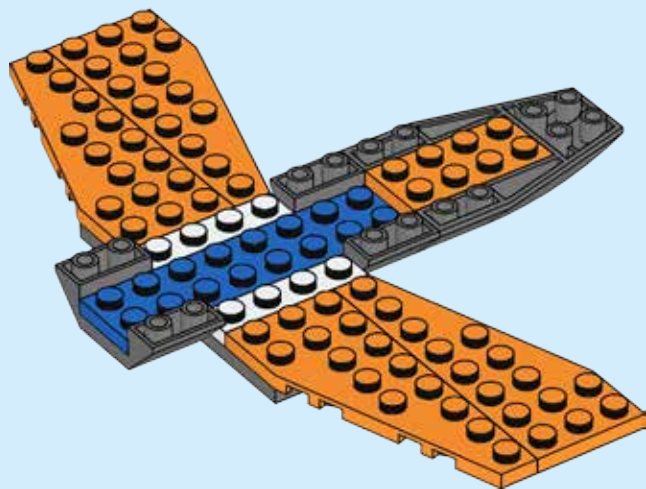

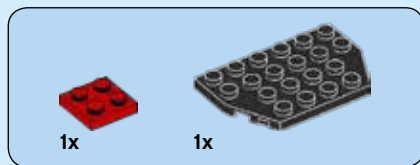

# 11

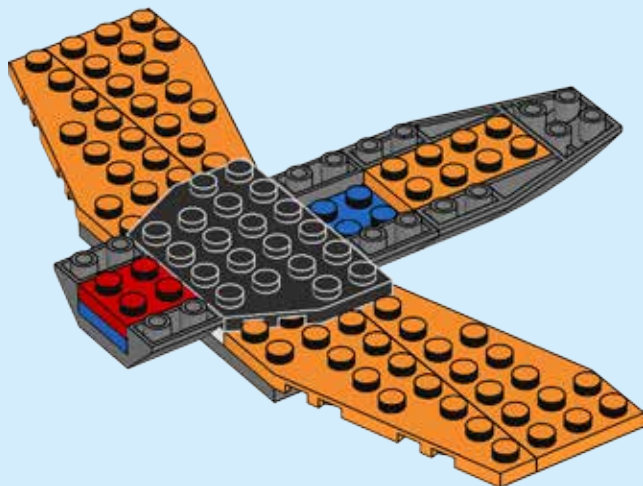



1x



1x

# 12

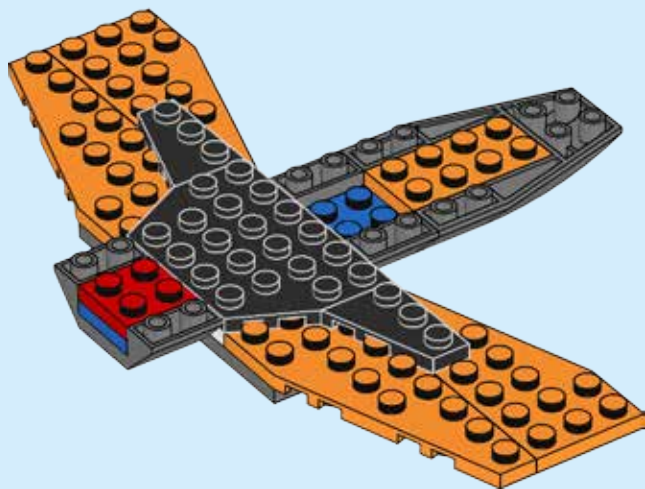



13

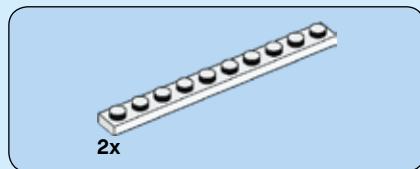
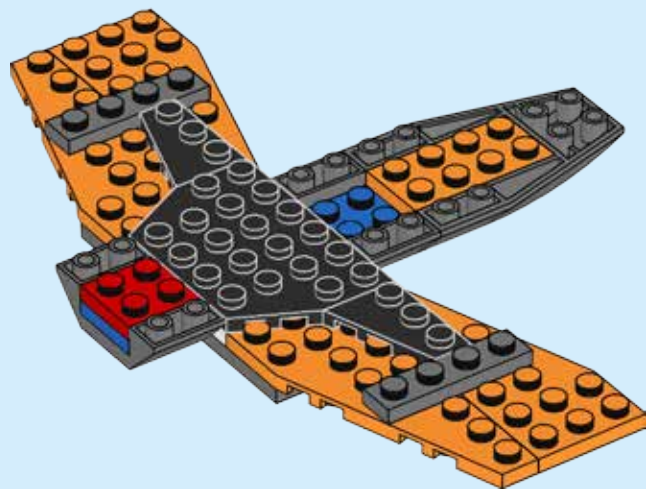

14

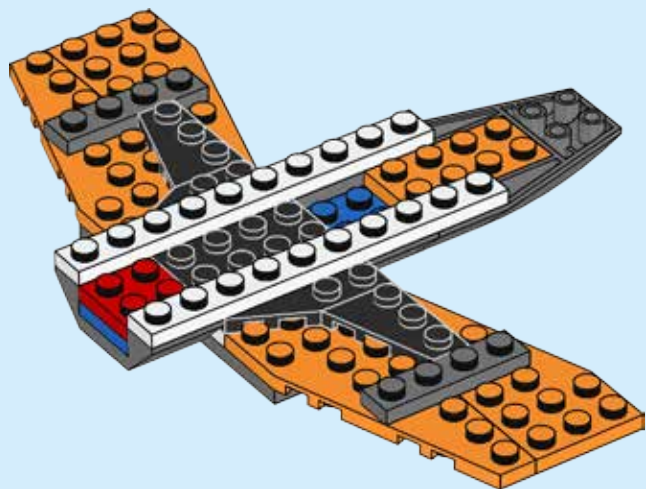





1x



1x

# 15

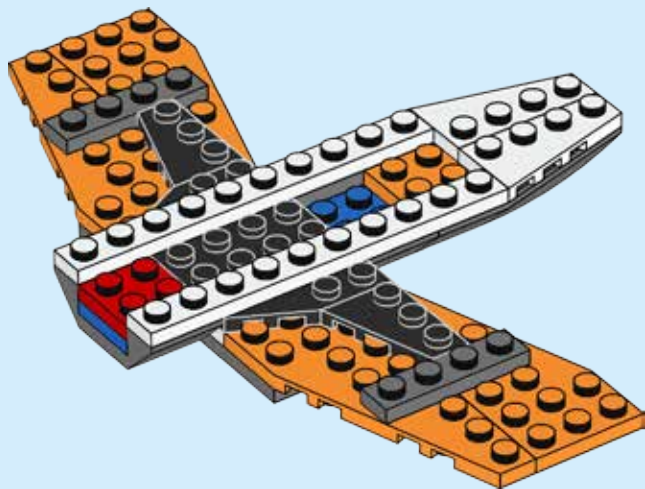

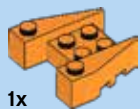

1x

# 16

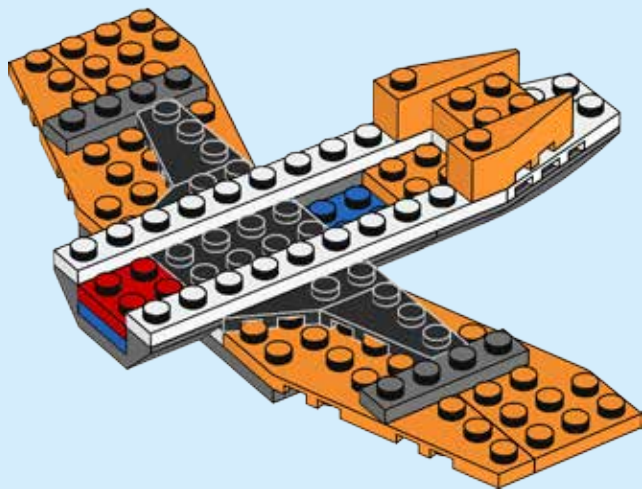

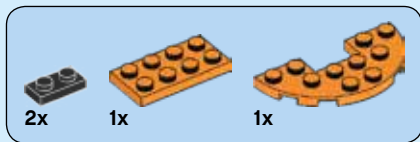

# 17

## 1



## 2

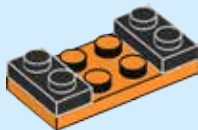

## 3



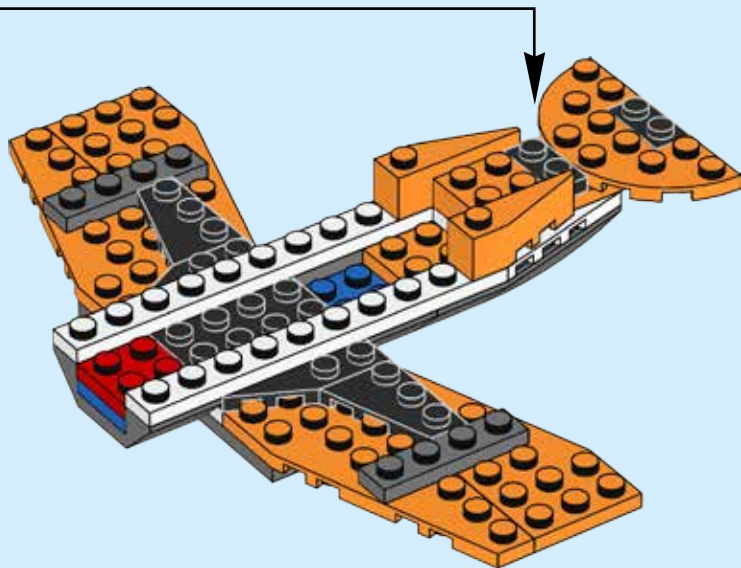



1x

18

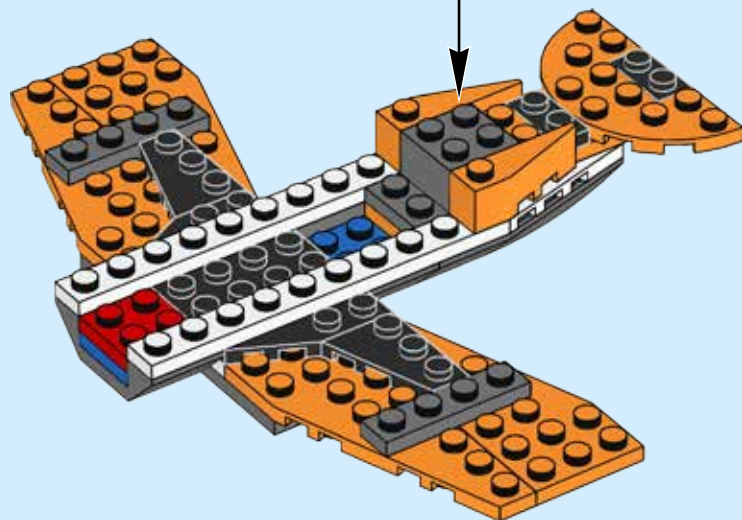
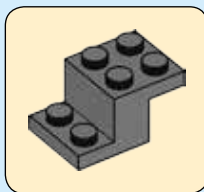



# 19

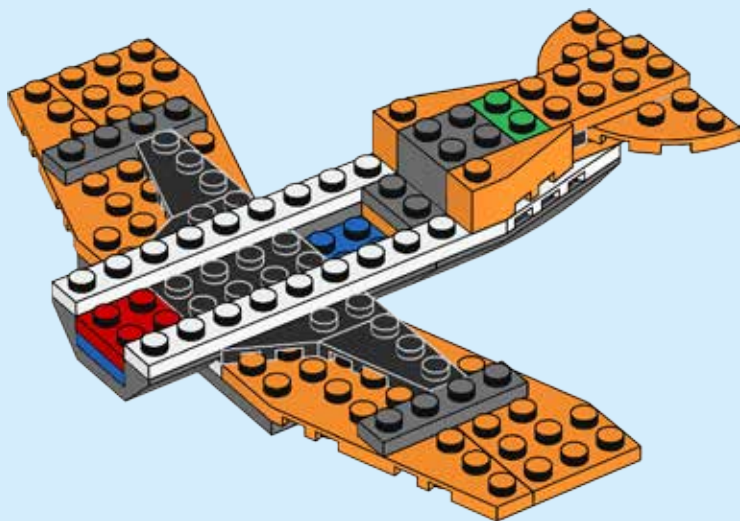



1x



1x

# 20

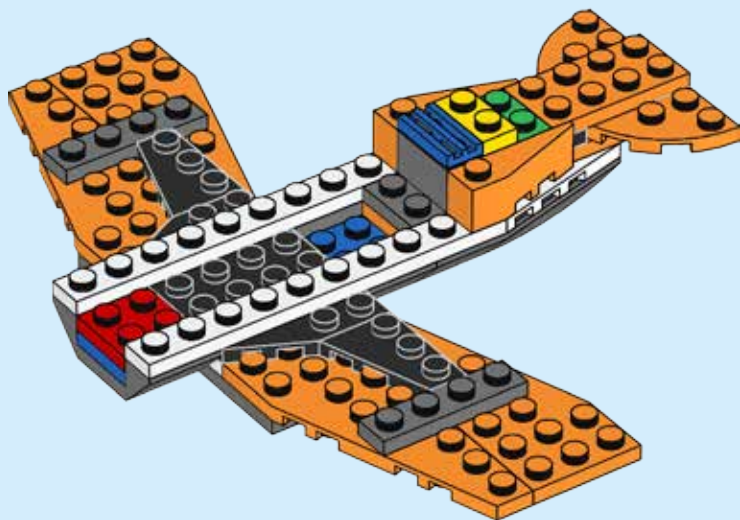

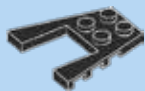

1x

# 21

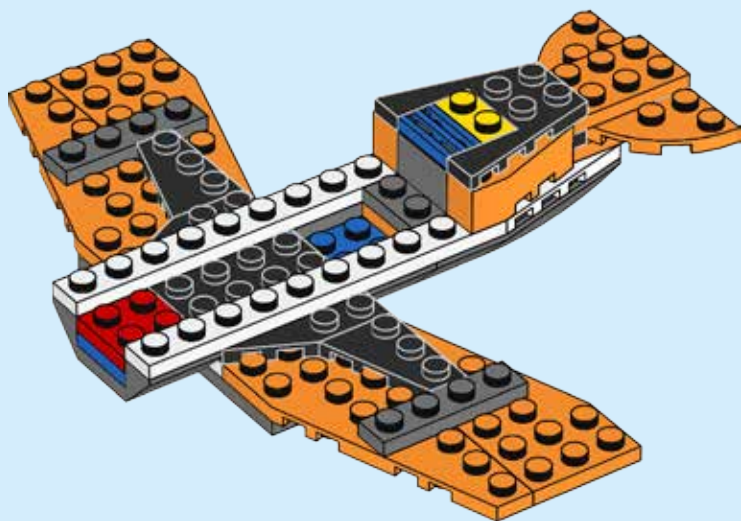



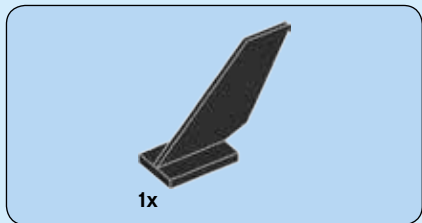

22

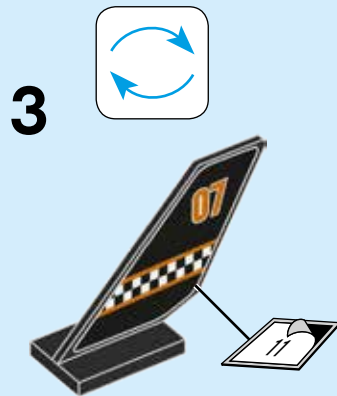
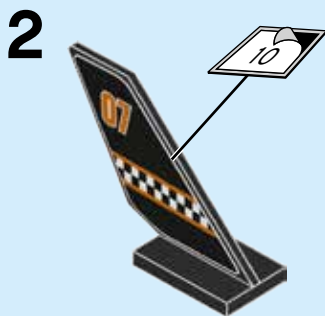

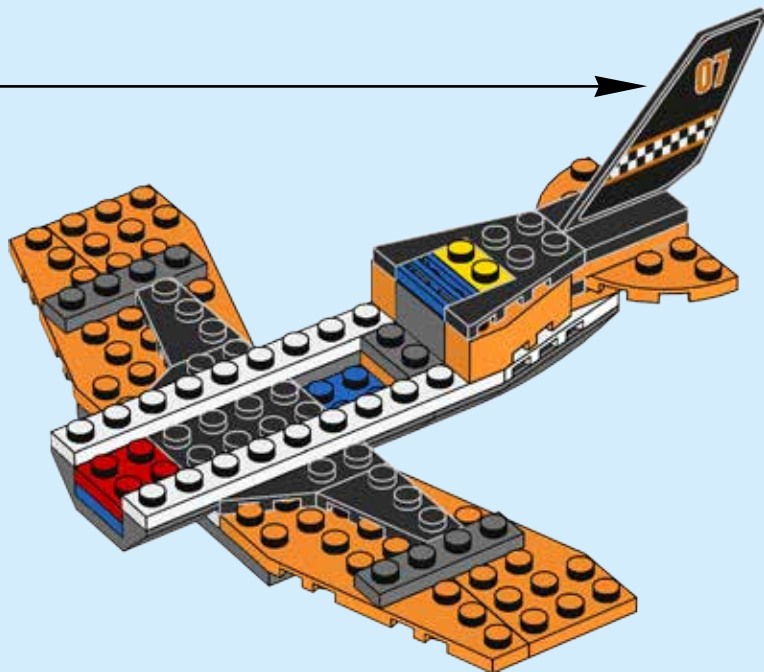



2x

23



2x

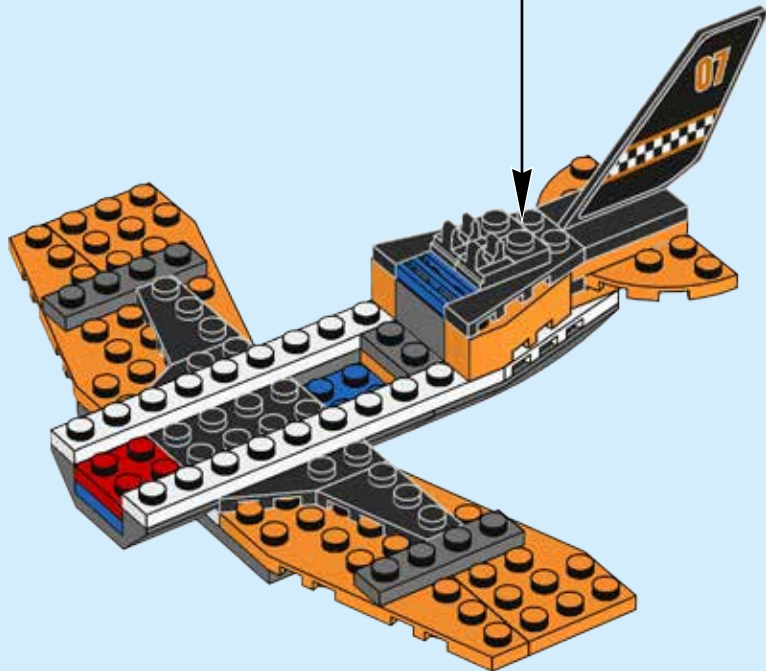

24



1x



1x

# 24

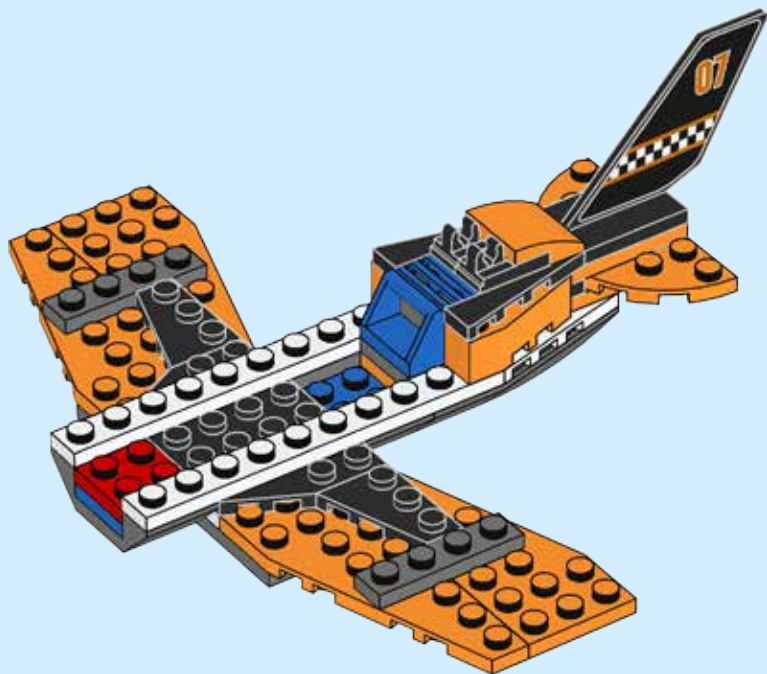



2x



2x

# 25

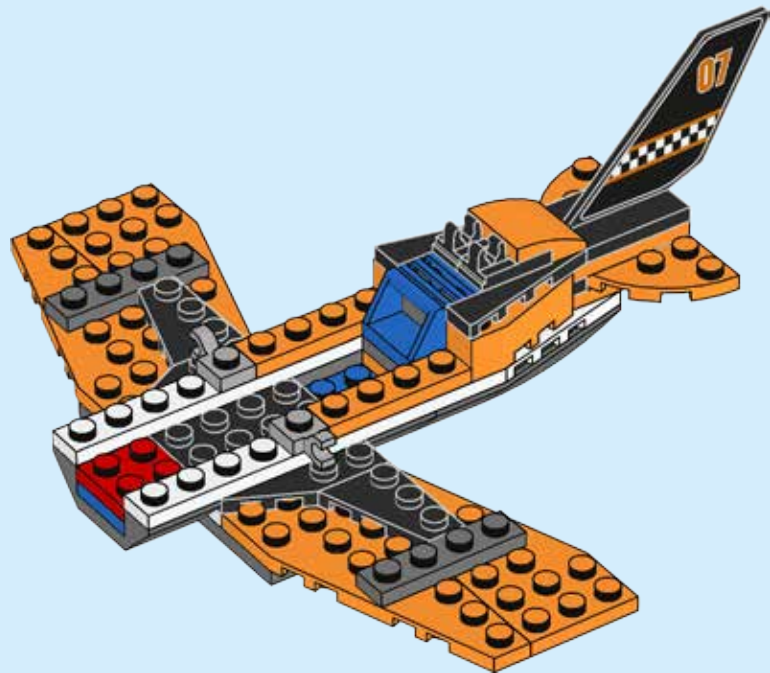

26



1x

# 26

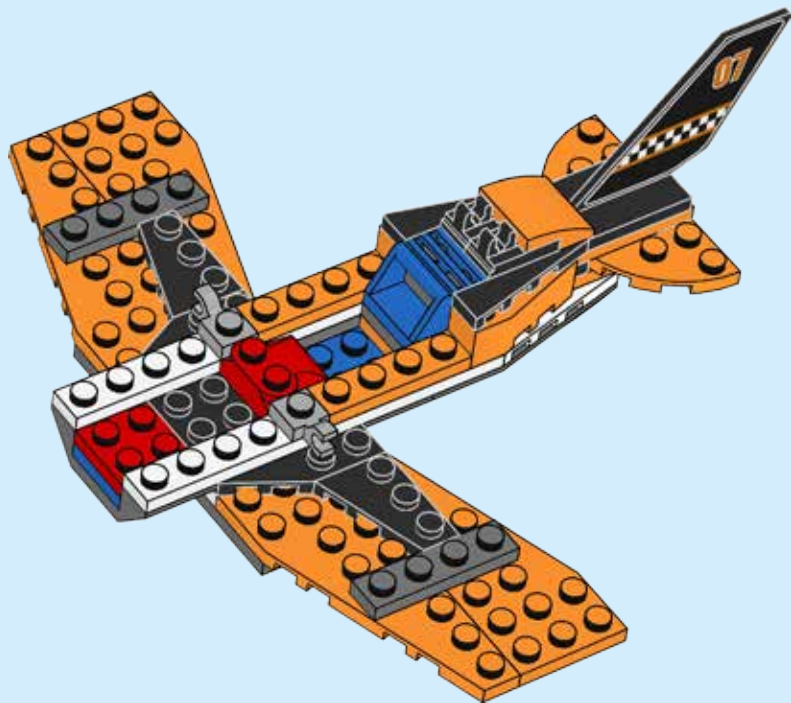



2x

27

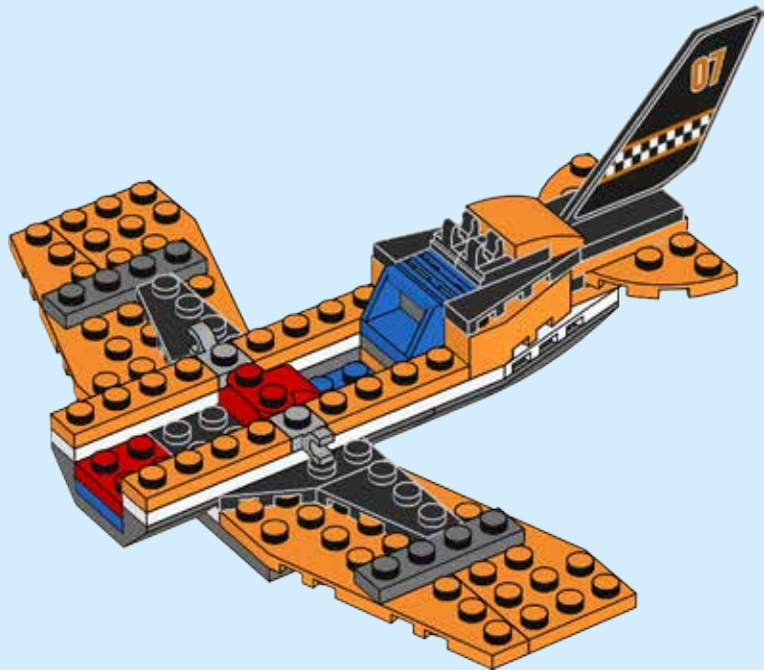

28

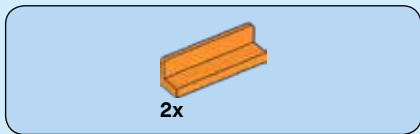

28

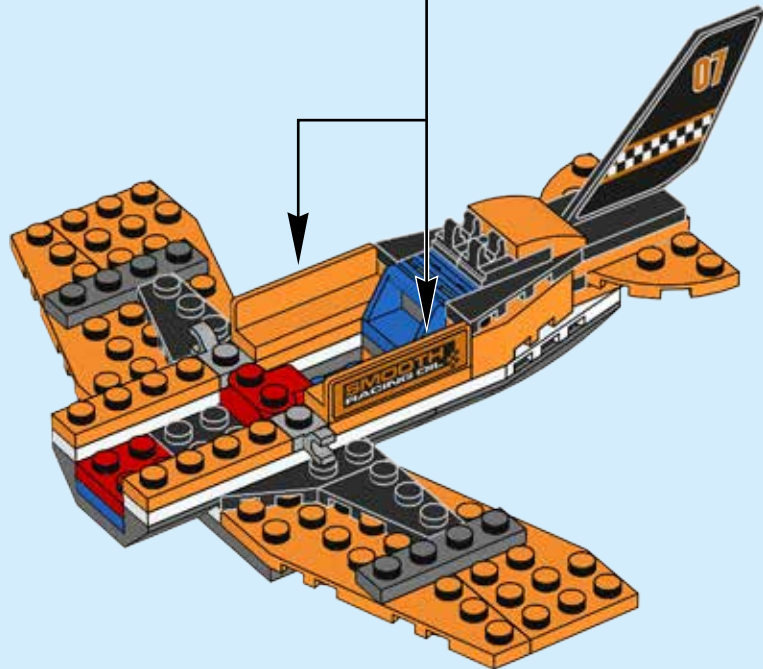
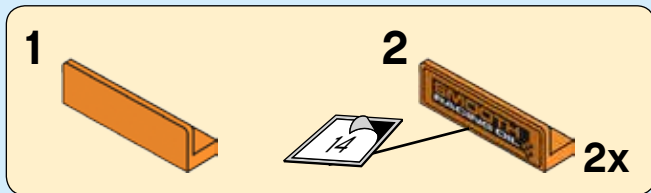





1x



1x

1

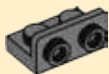

2

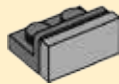

3



# 29

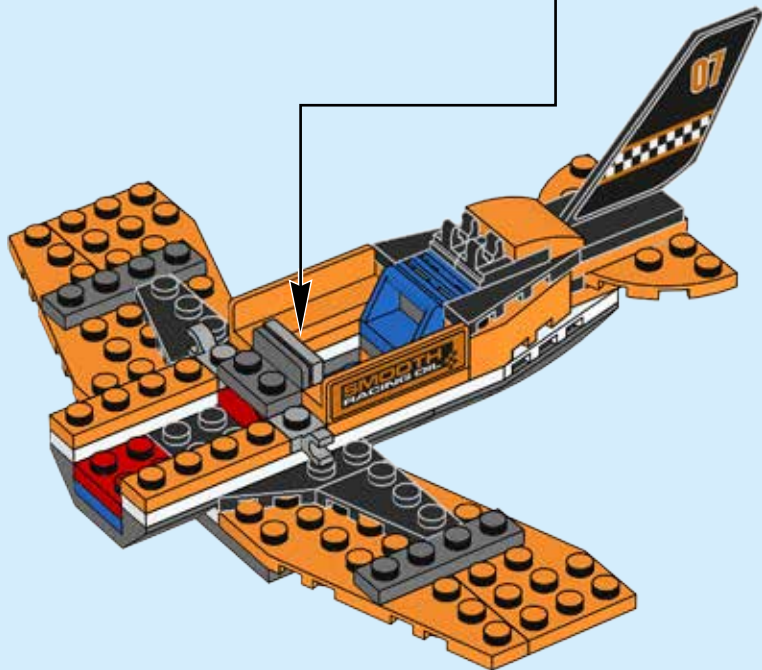



1x



1x



2x

# 30

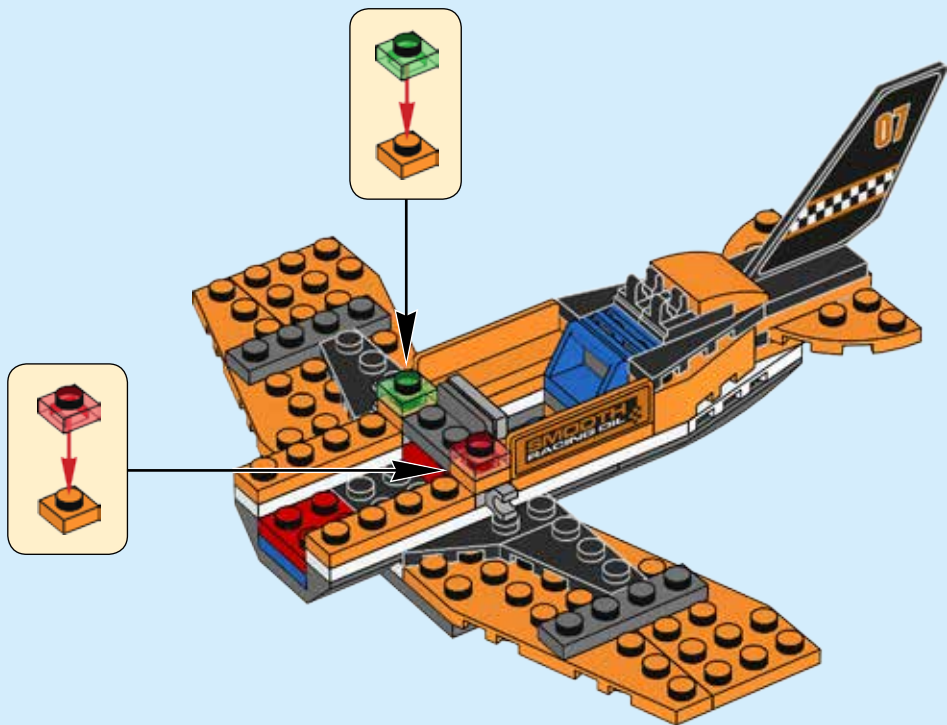



1x



2x

# 31

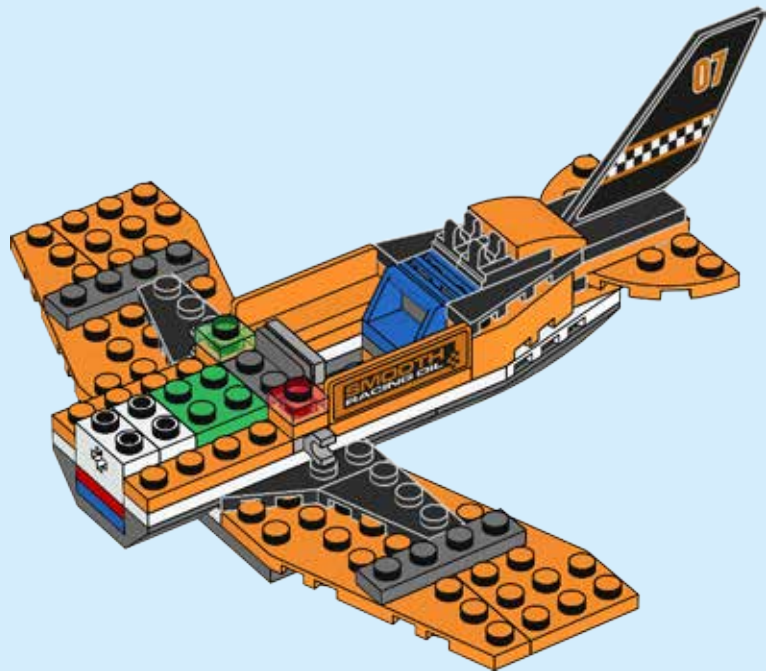

32

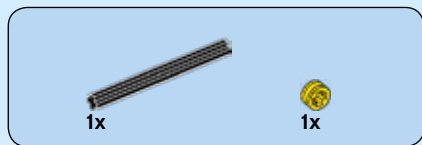

# 32

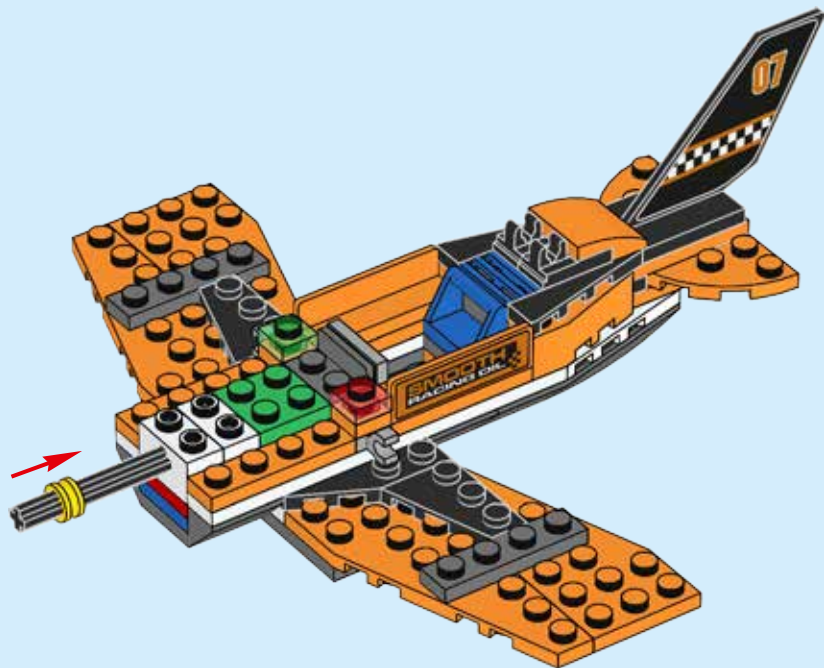



1x



1x

# 33

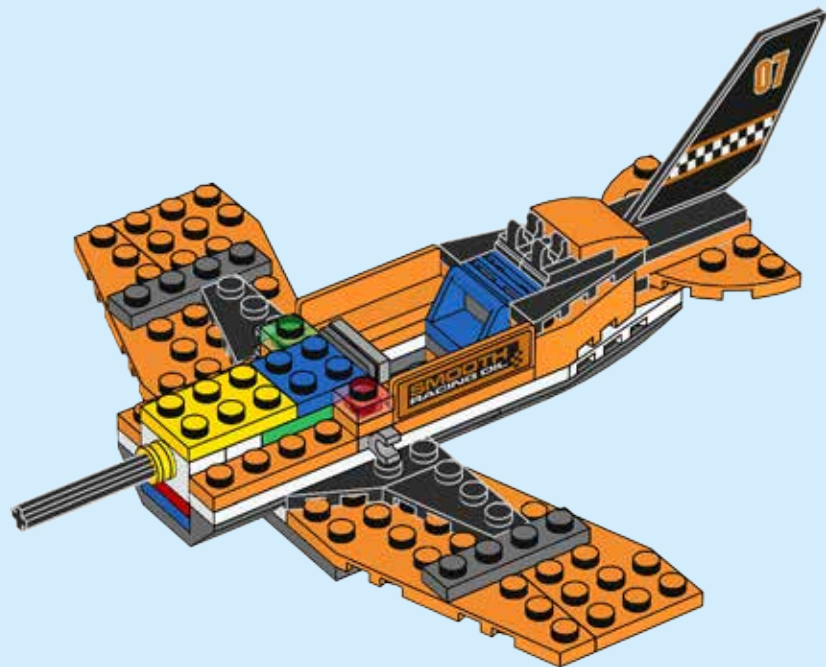

34



1x

# 34

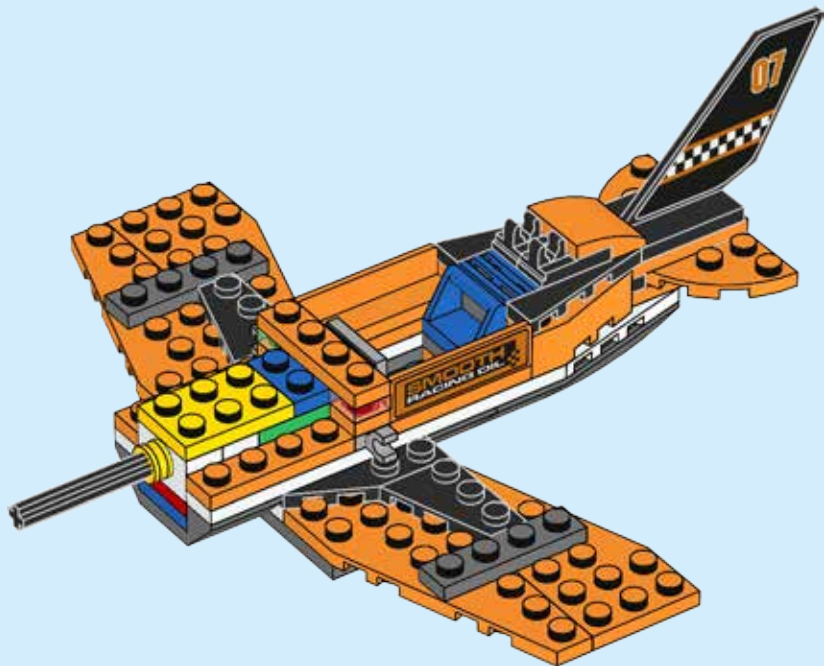

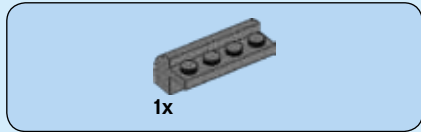

35

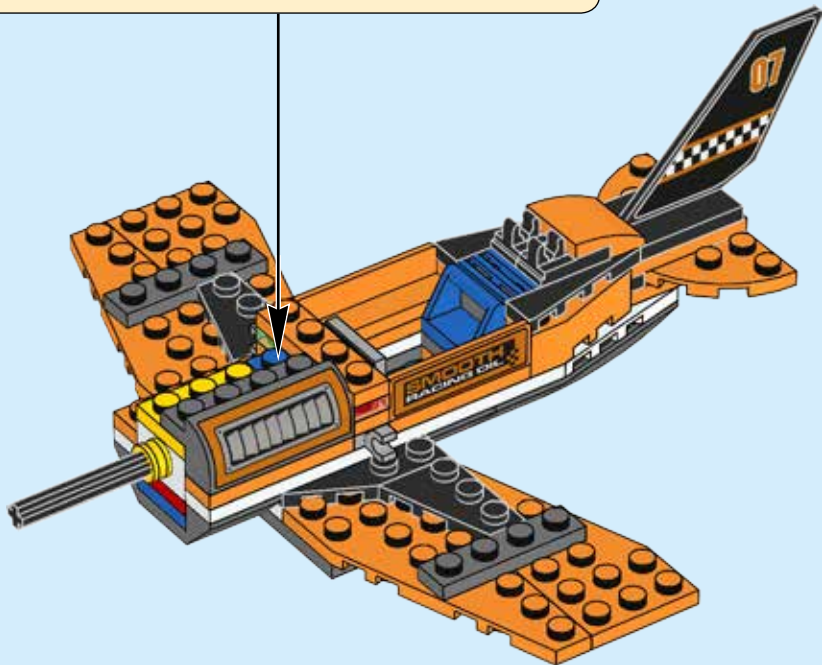
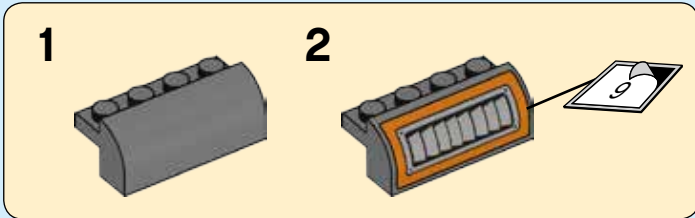

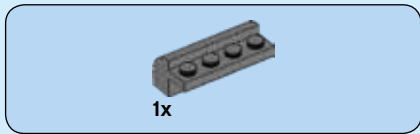

36

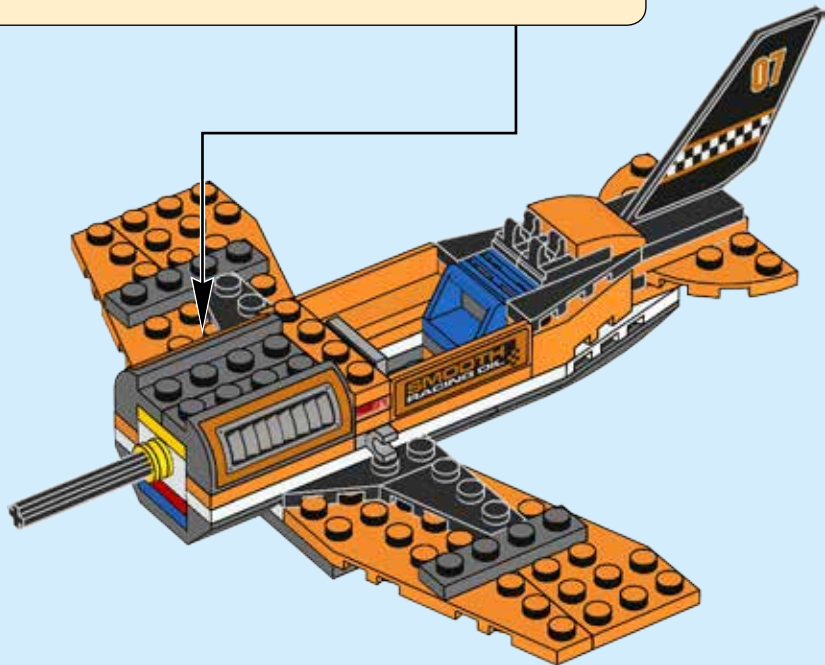
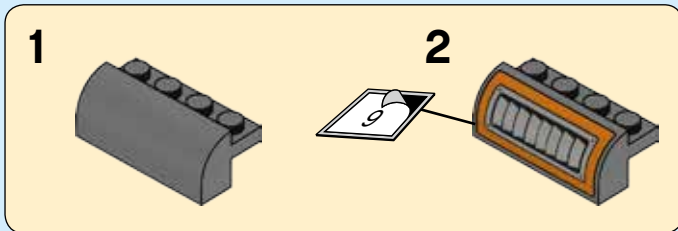





1x

37

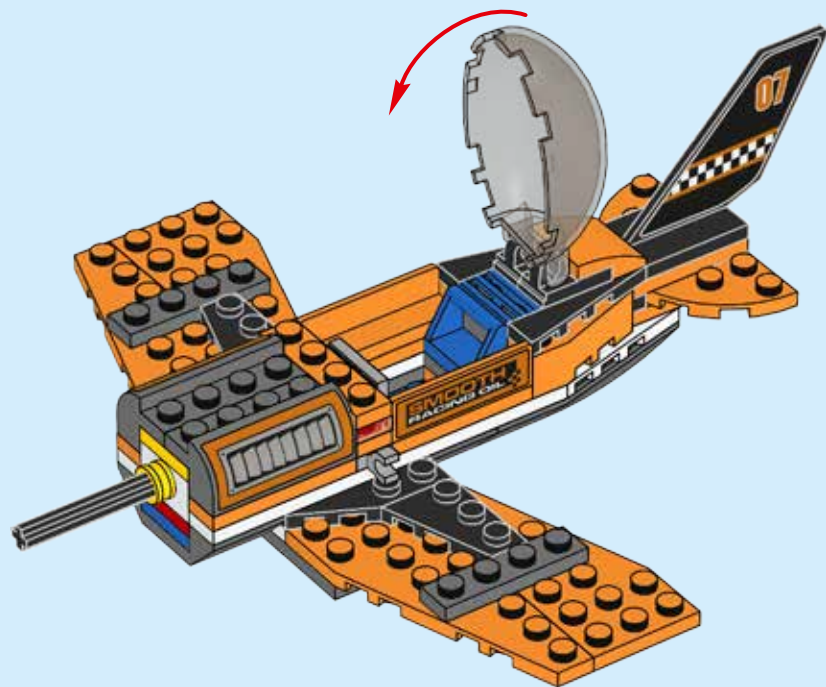

38



2x

# 38

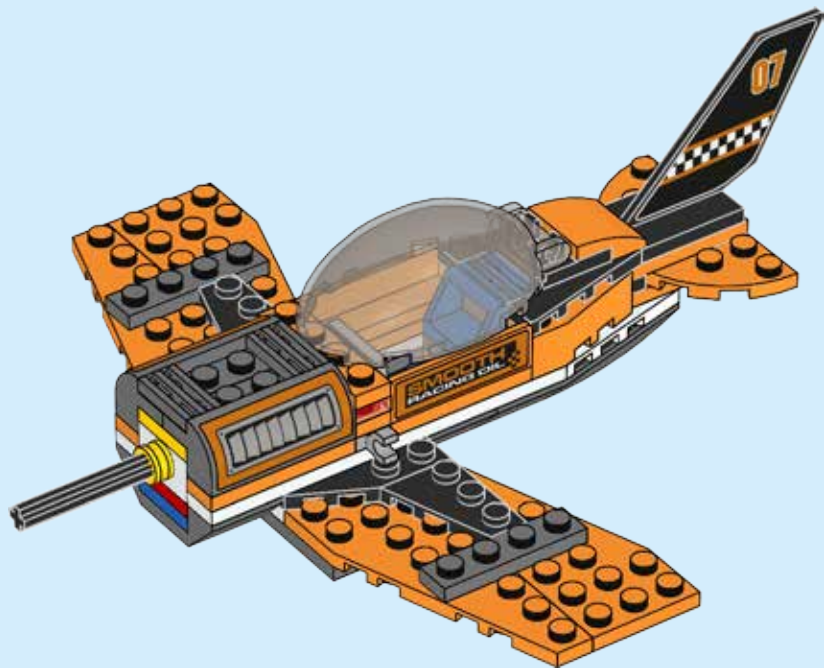



39

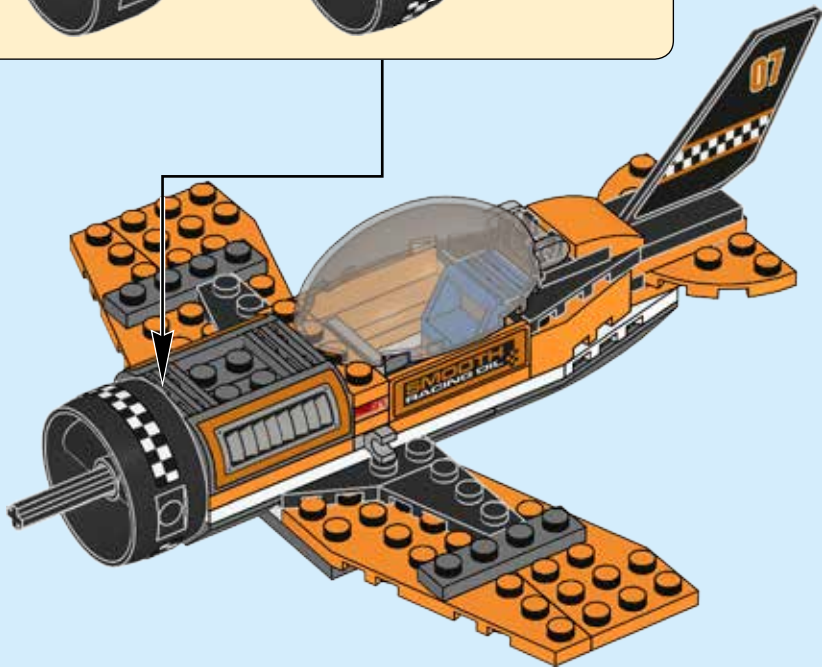
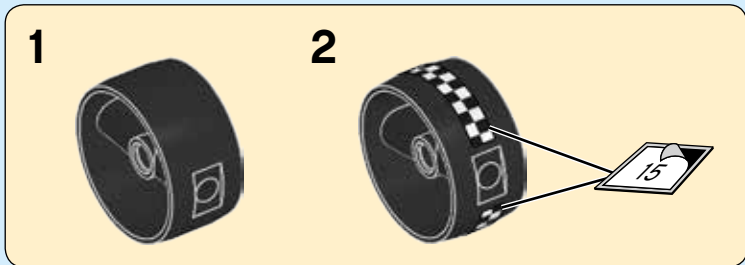



1x

40

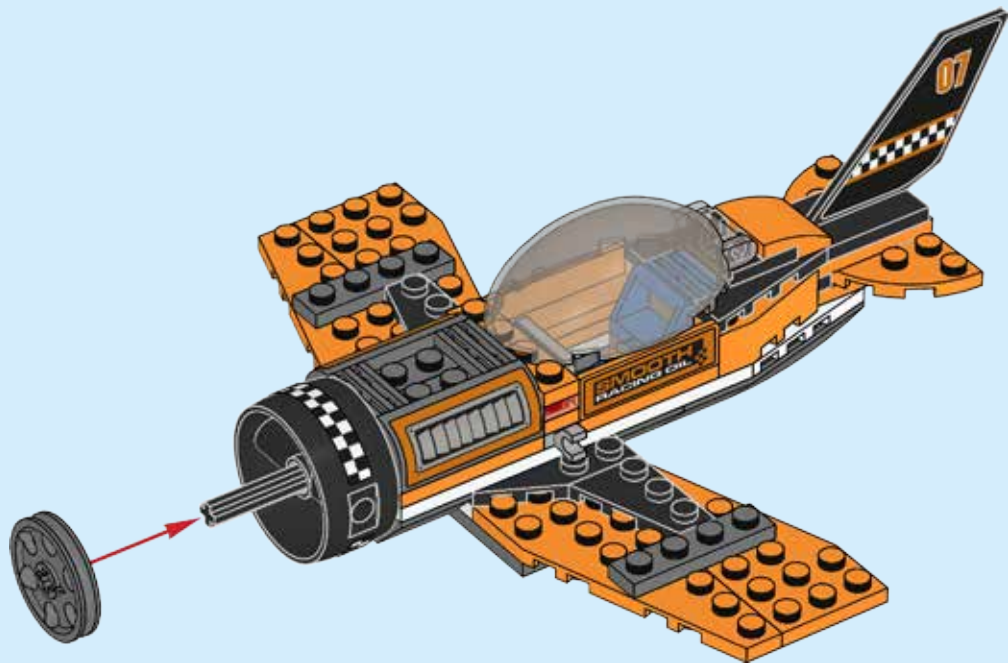



2x

41

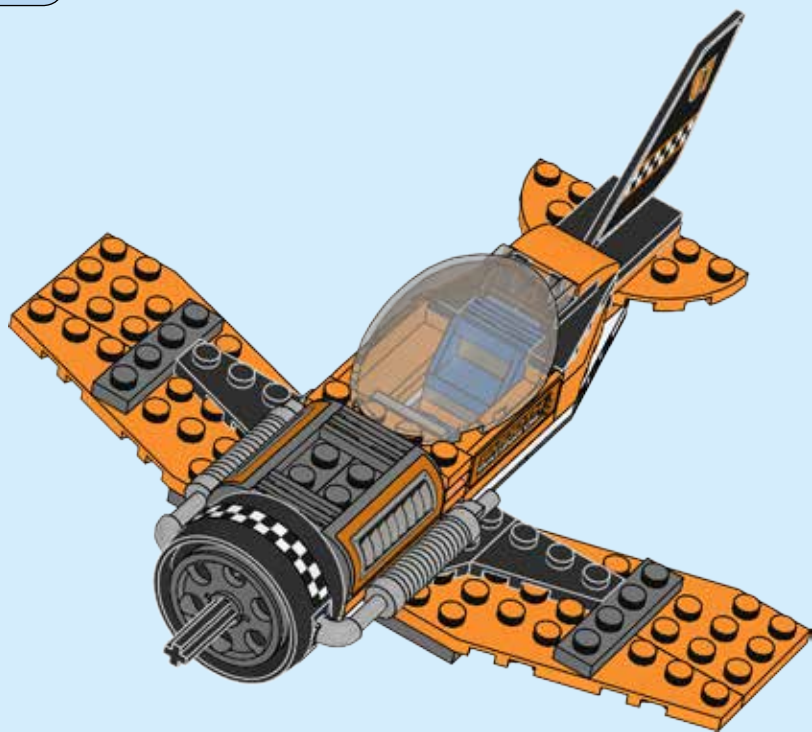

42

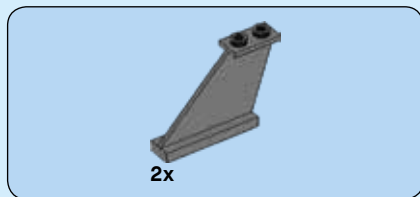

42

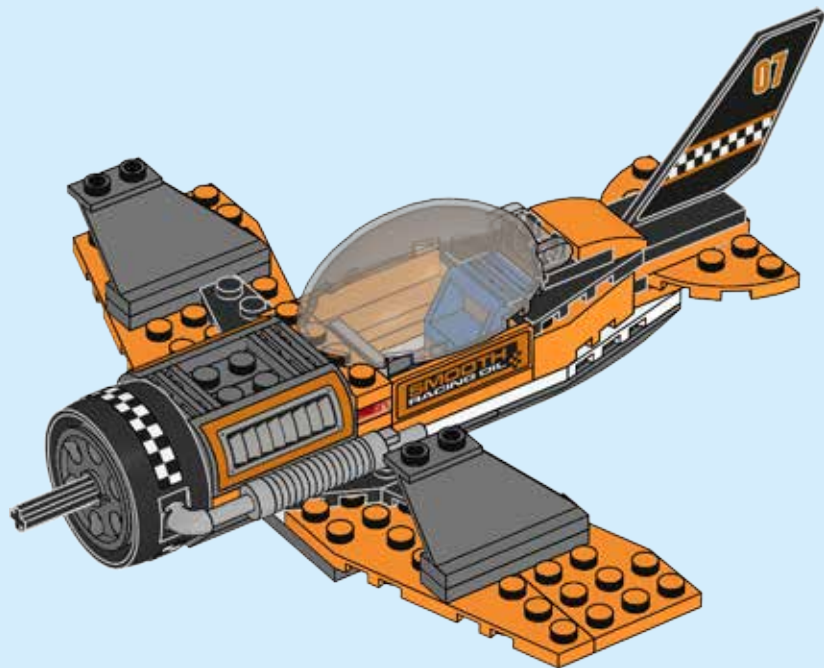



2x



2x

# 43



2x

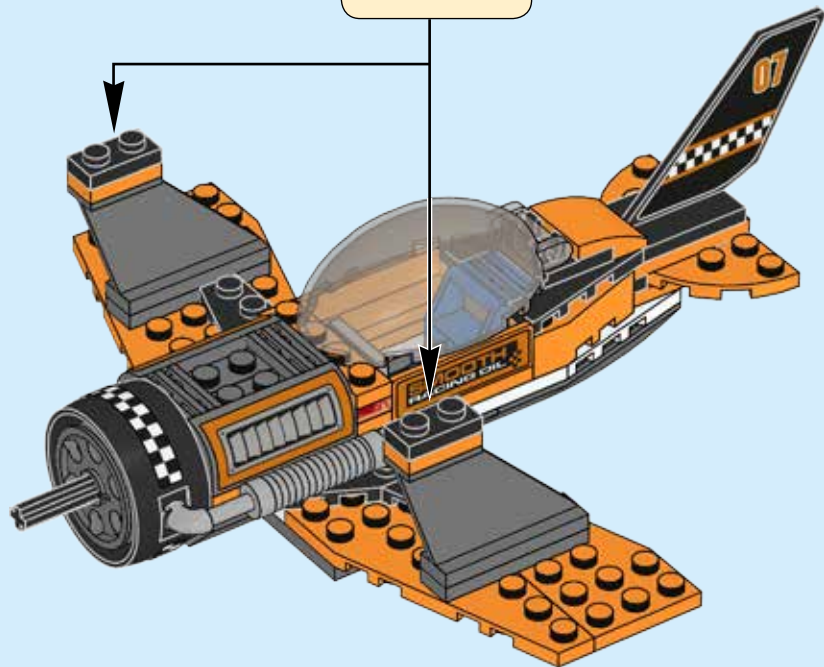

44



2x

# 44



2x

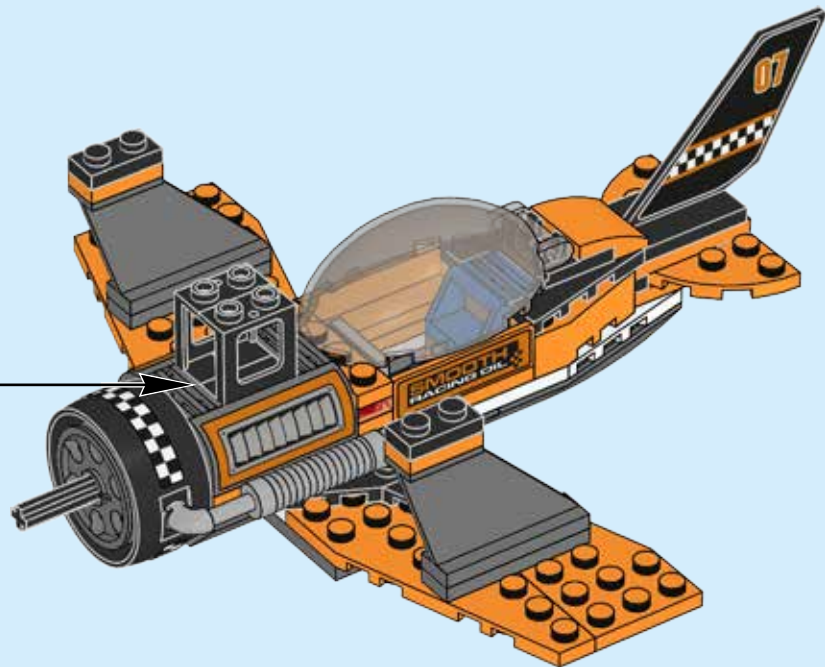





1x



1x

# 45

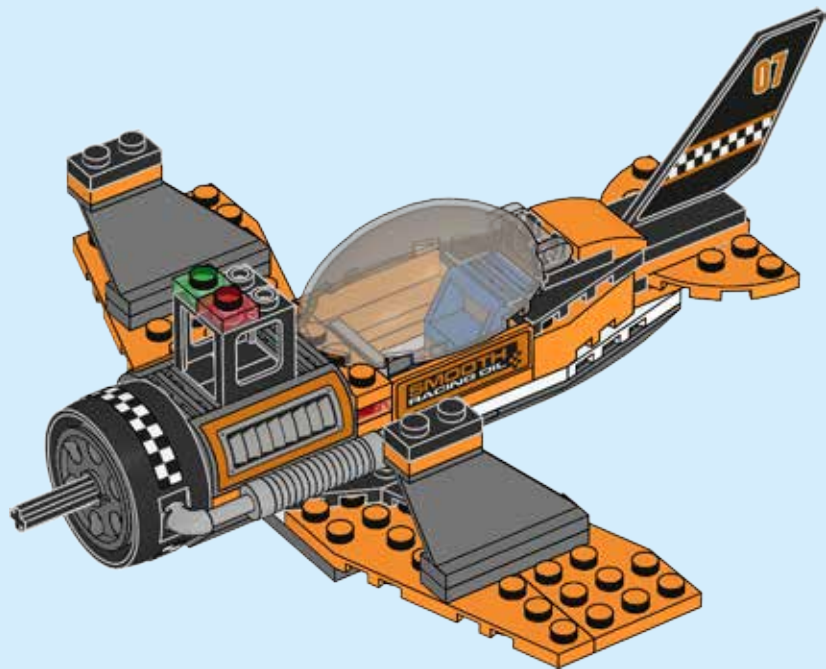

46

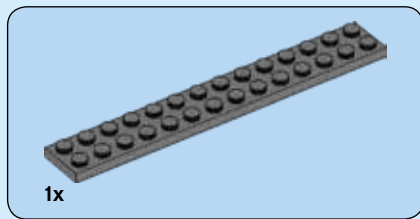

46

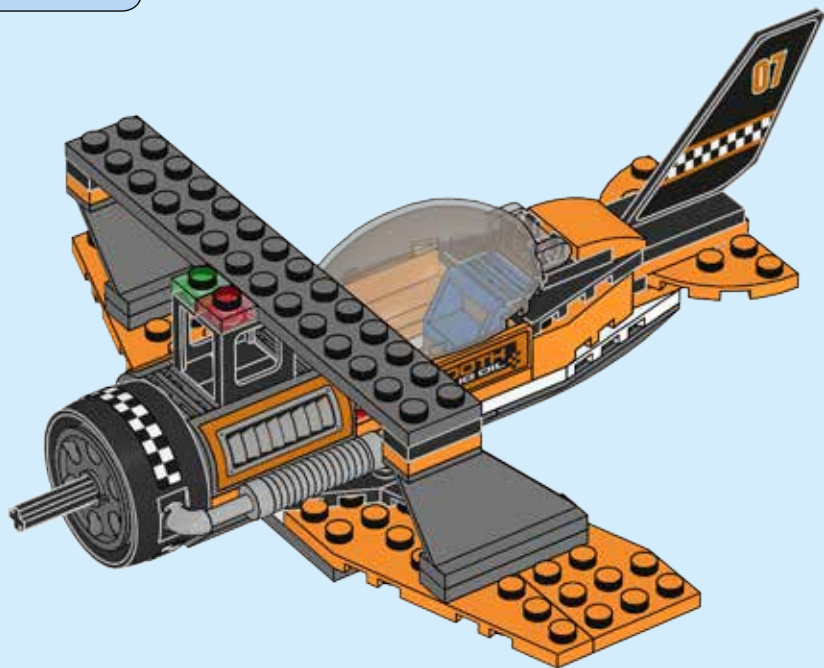



1x

47

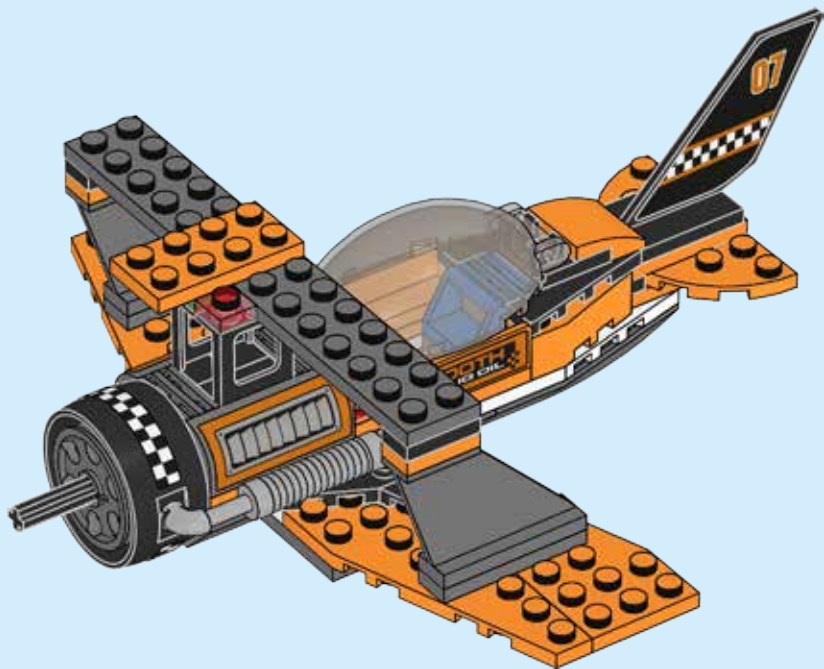

48

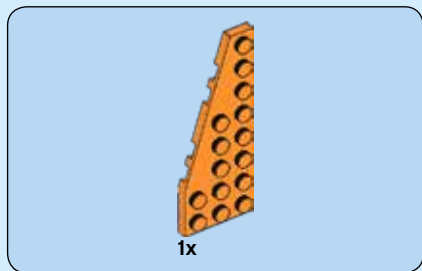

48

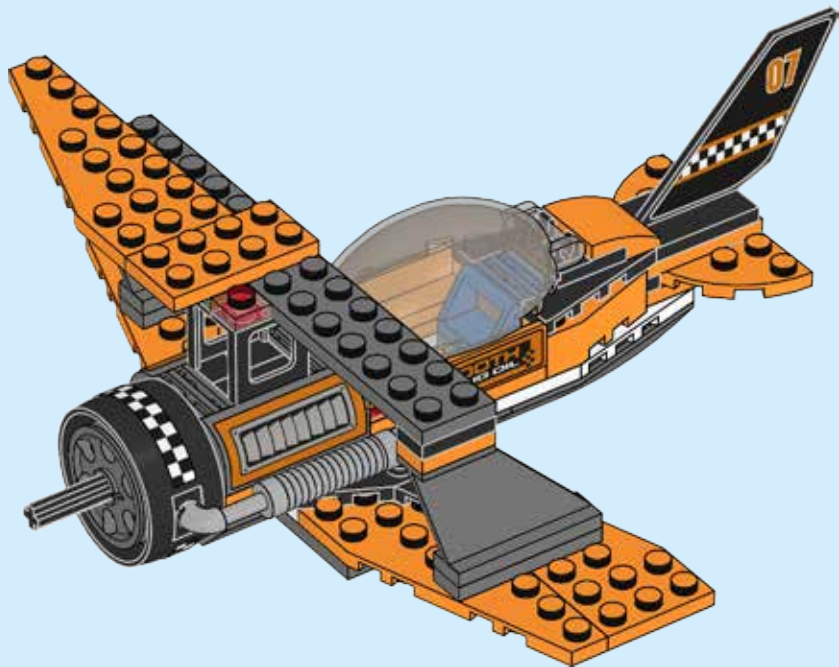



1x

49

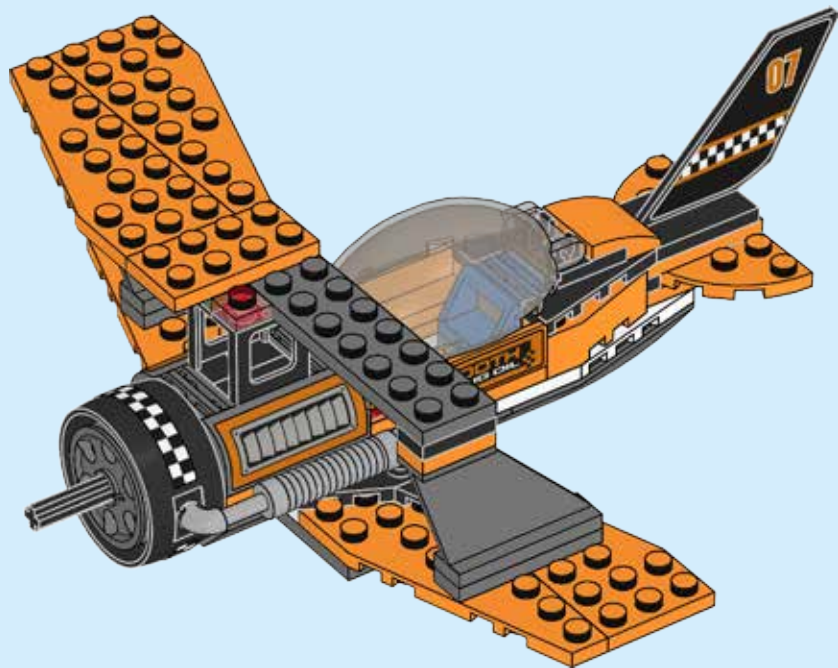

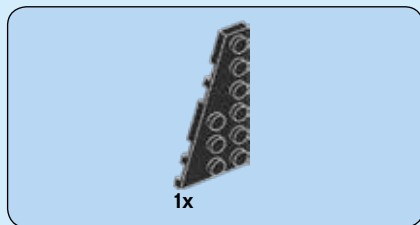

50

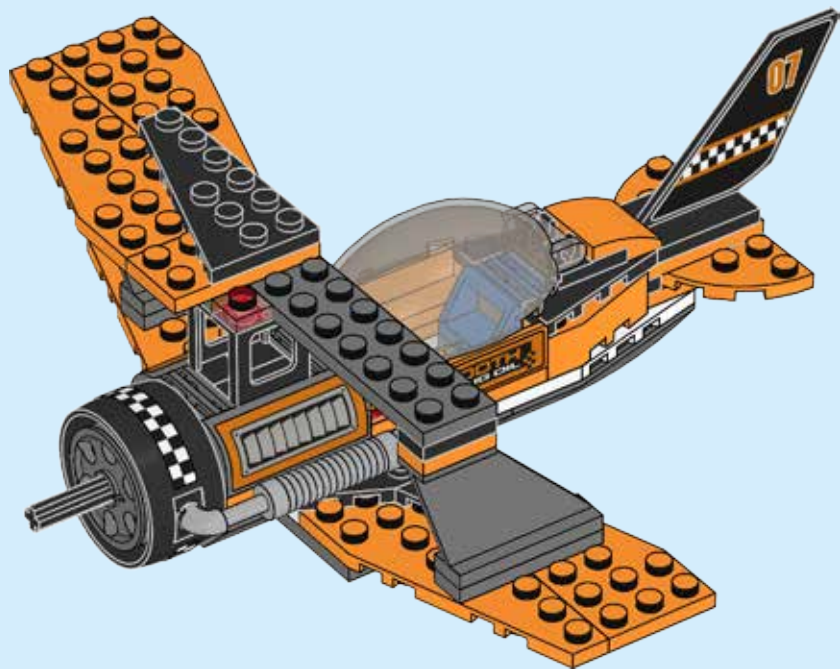



1x

# 51

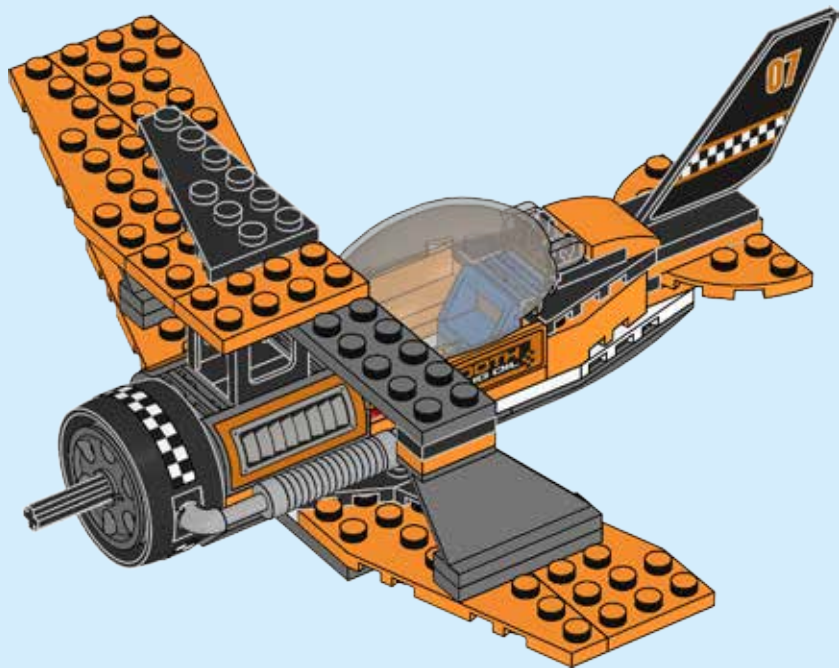

52



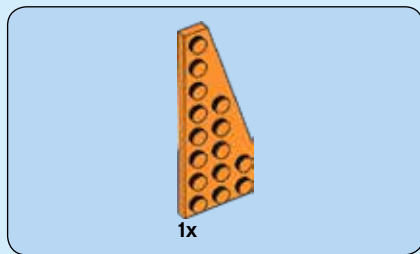

52

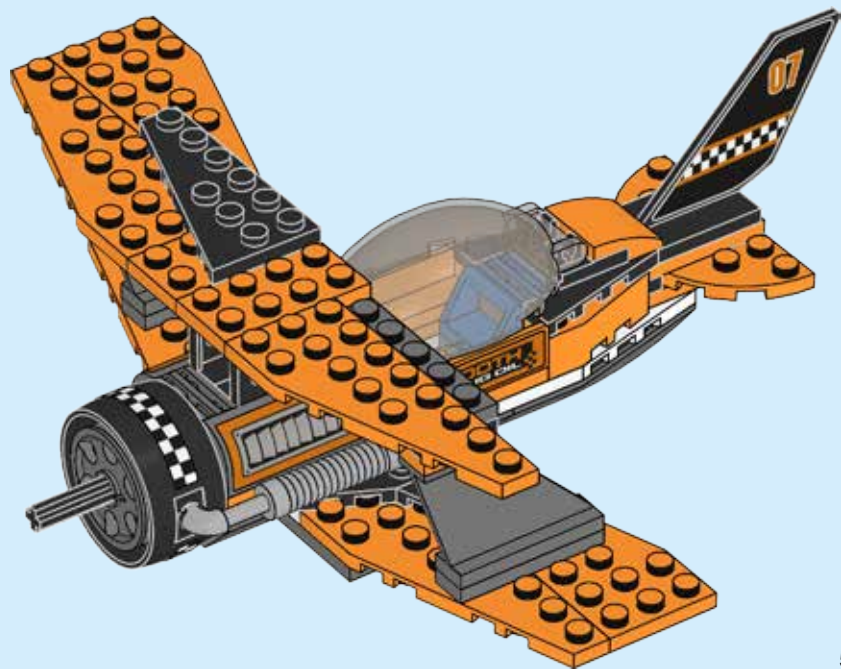



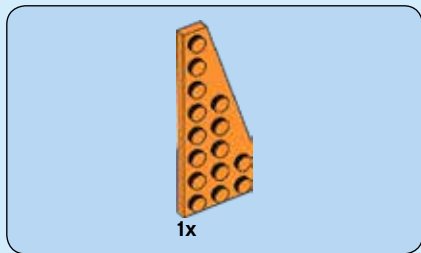

53

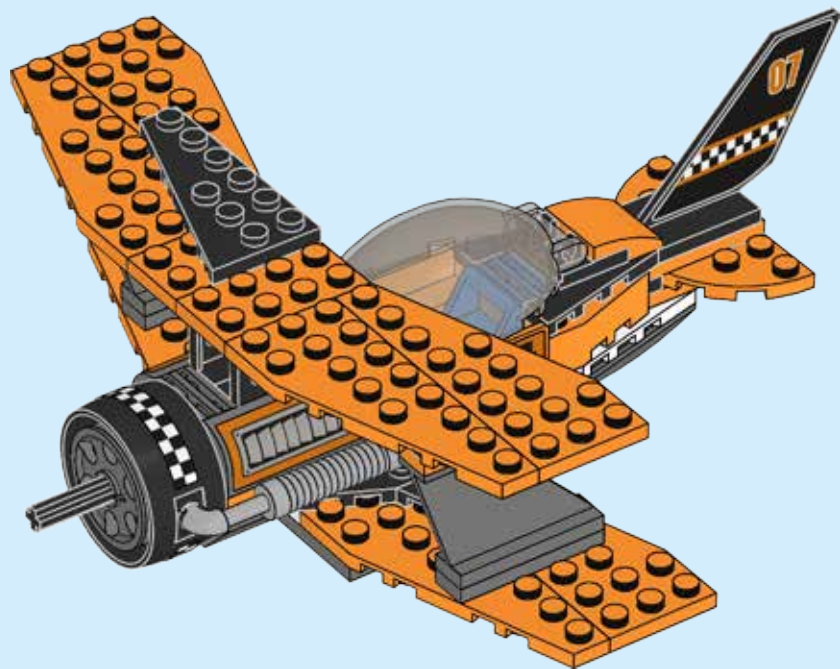

54

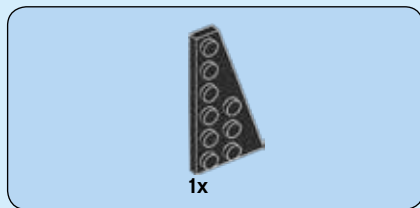

54

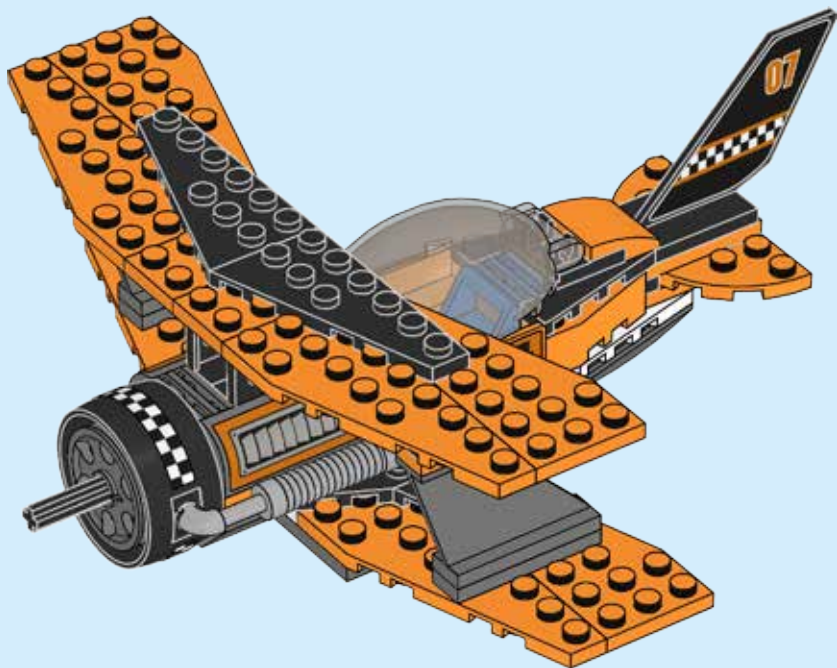



1x



1x

# 55

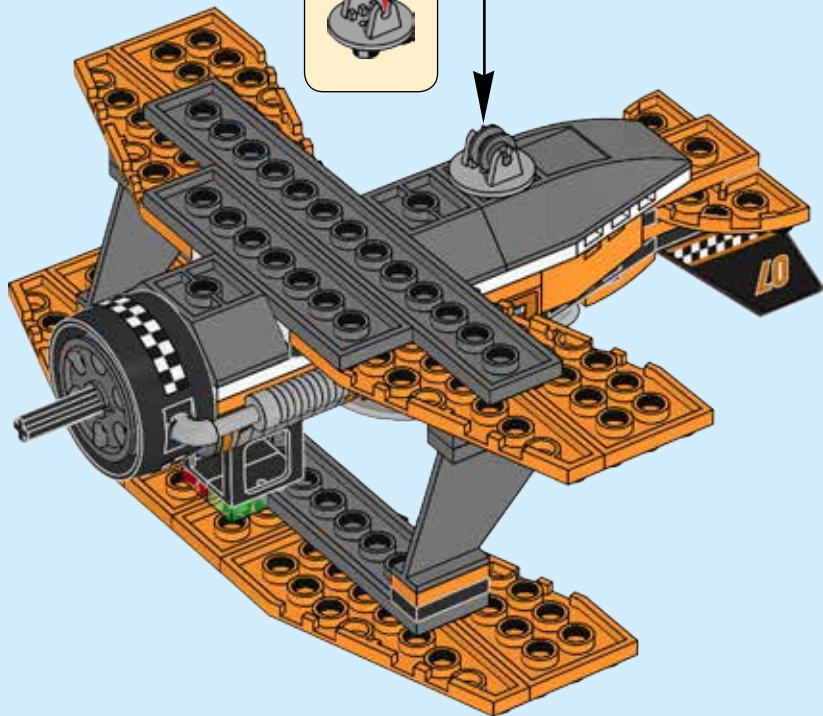
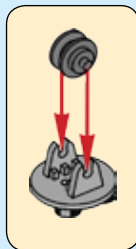
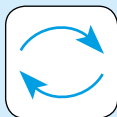

56



1x

56



1x

57

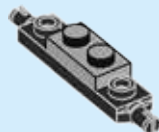



1x

58

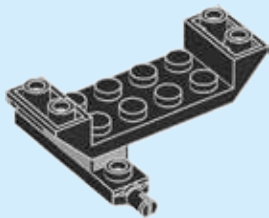



2x

# 59

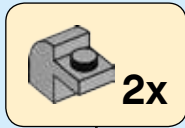

2x

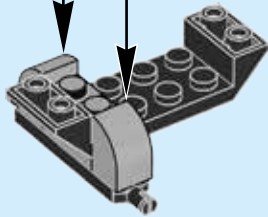

1x

# 60

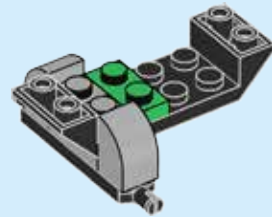



1x

# 61

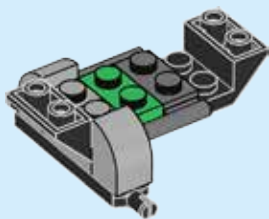



1x

62

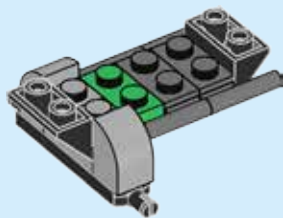

1x

63

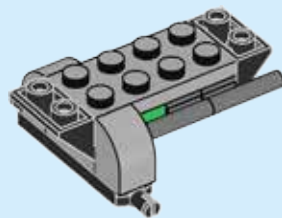





2x



2x

# 64

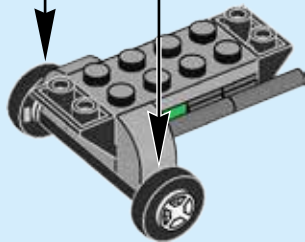
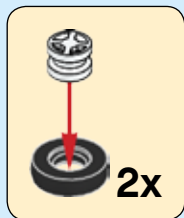

65

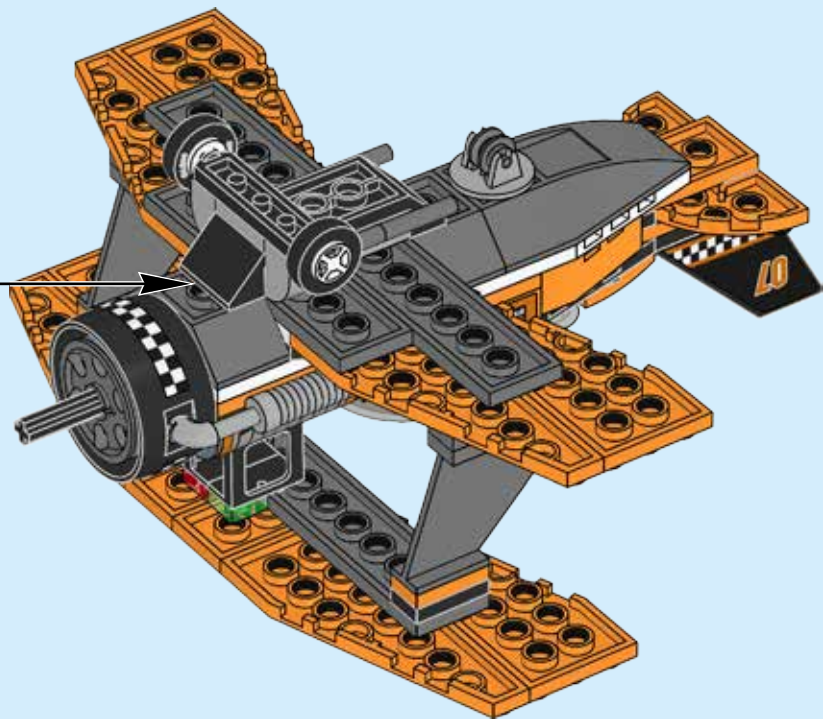

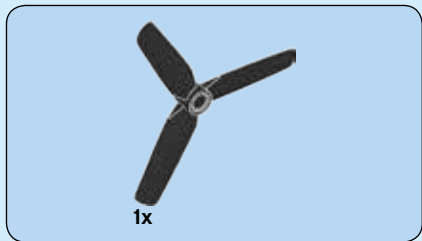

66

1



2

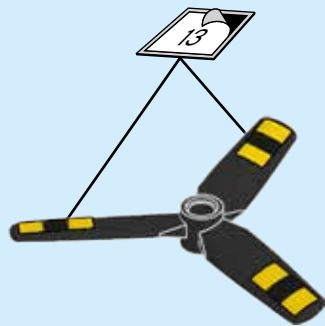

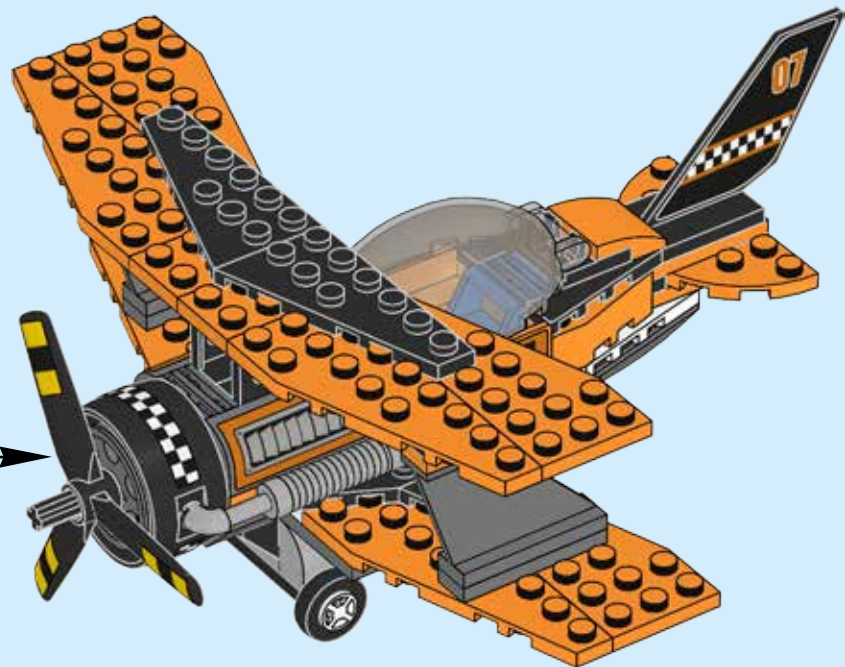
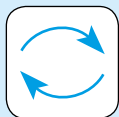



1x



1x

# 67

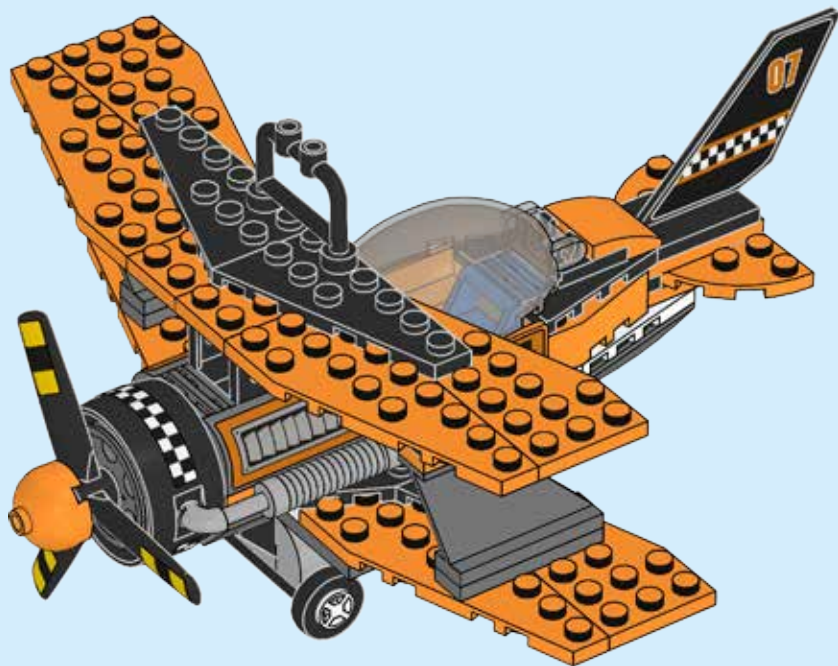

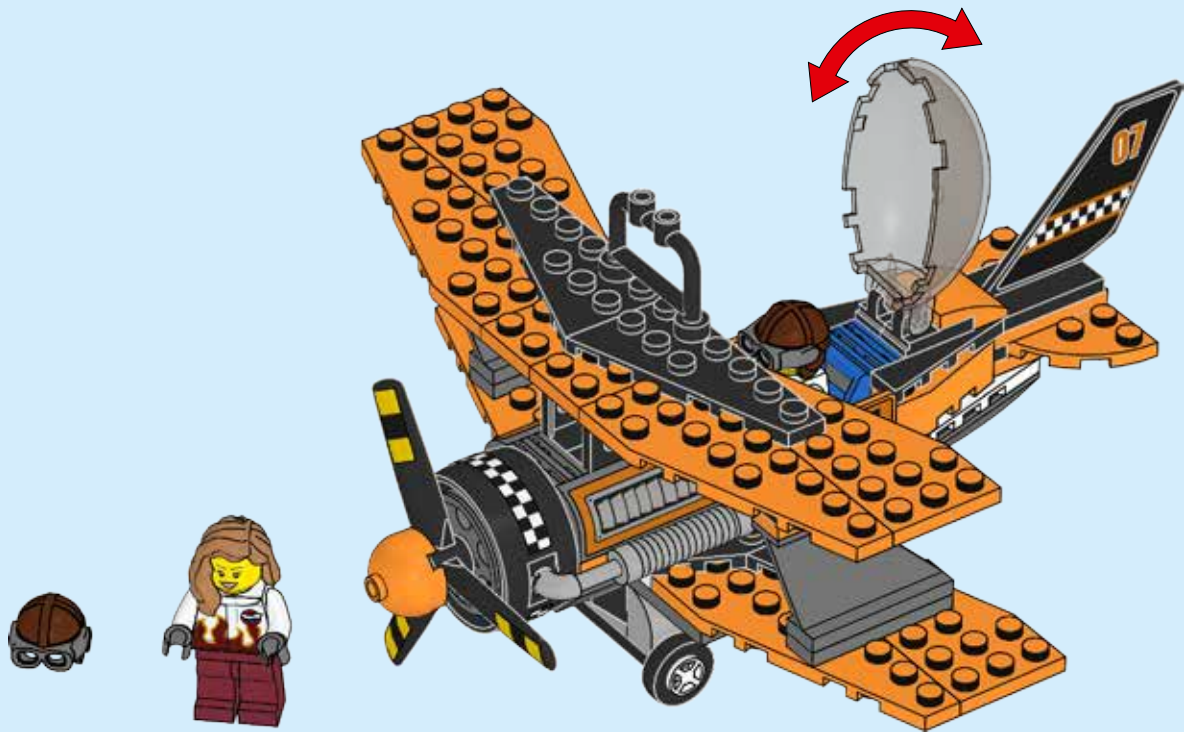



**LEGO** CITY



60110



60109



60108



60107



60106



60105

LEGO and the LEGO logo are trademarks of the LEGO Group. ©2016 The LEGO Group. 6162940

 [LEGO.com/city](http://LEGO.com/city)





# CITY

60103



 [LEGO.com/city](https://www.LEGO.com/city)



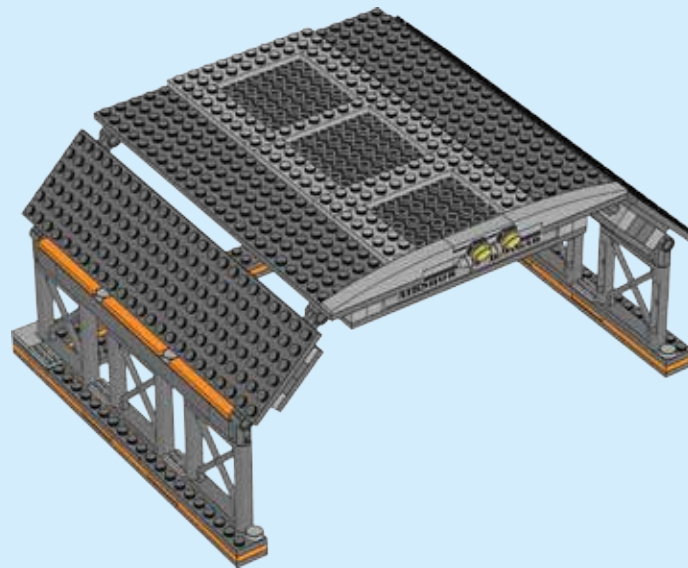
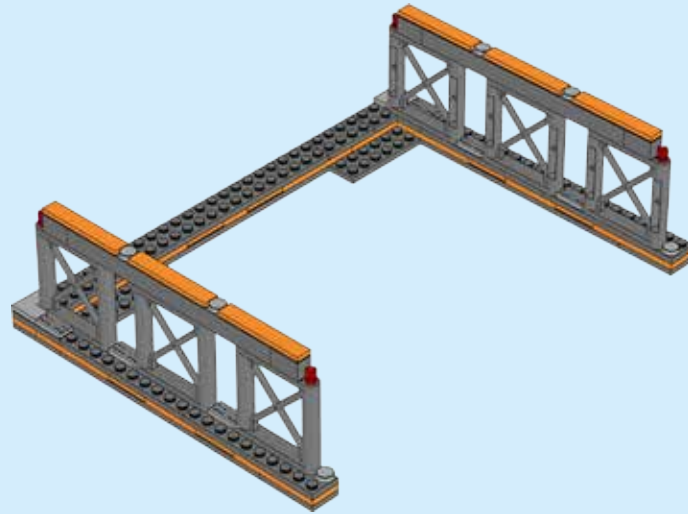

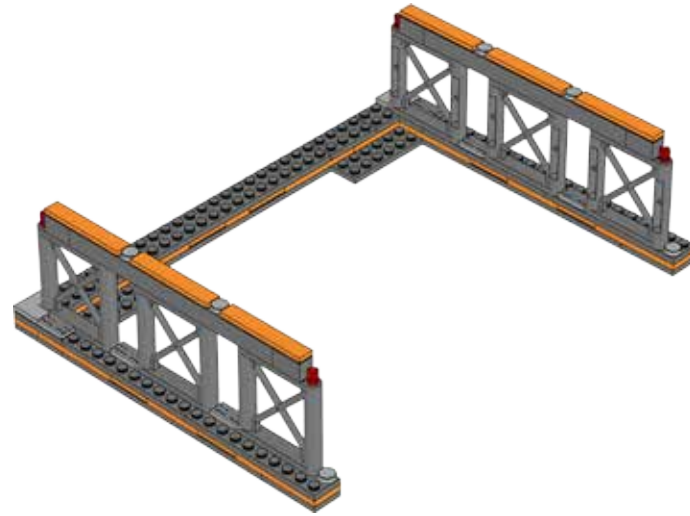

1x

1

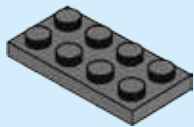

1x

2

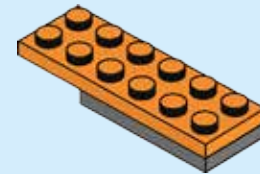

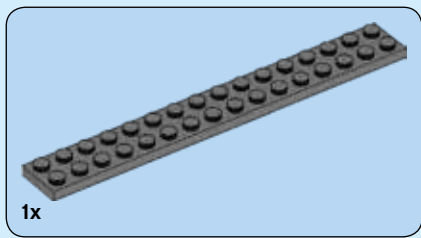

3

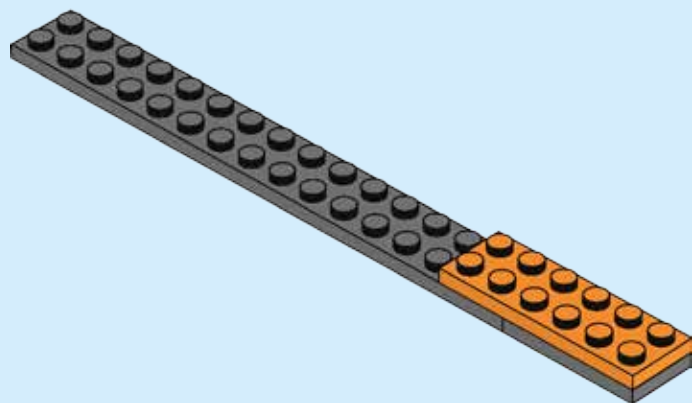

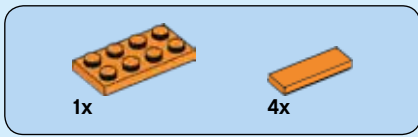

4

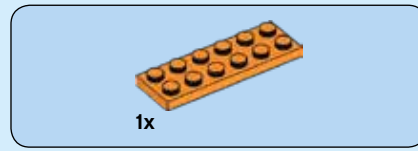
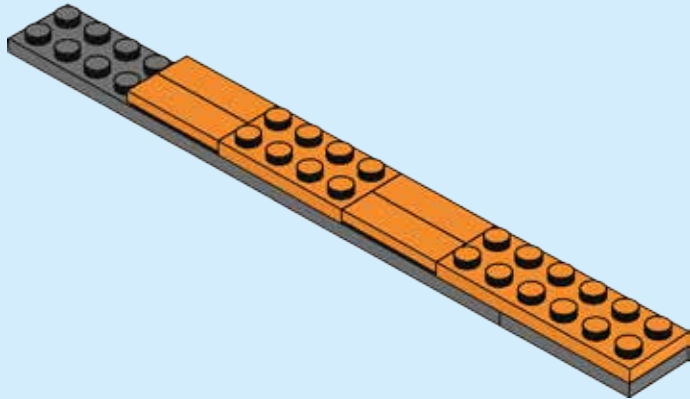

5

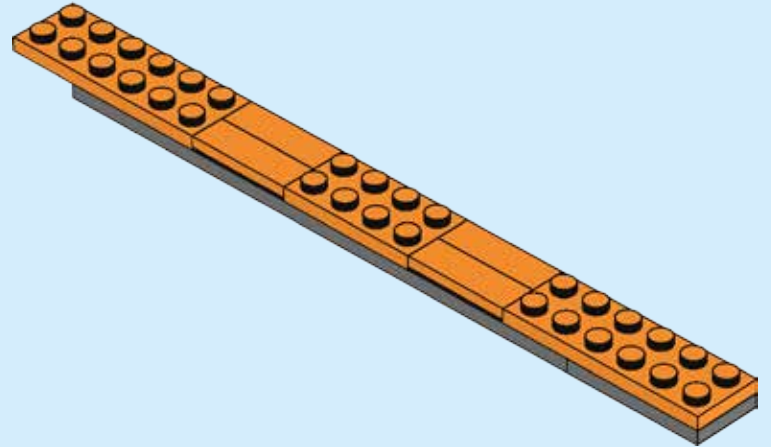

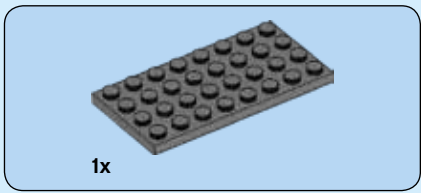

6

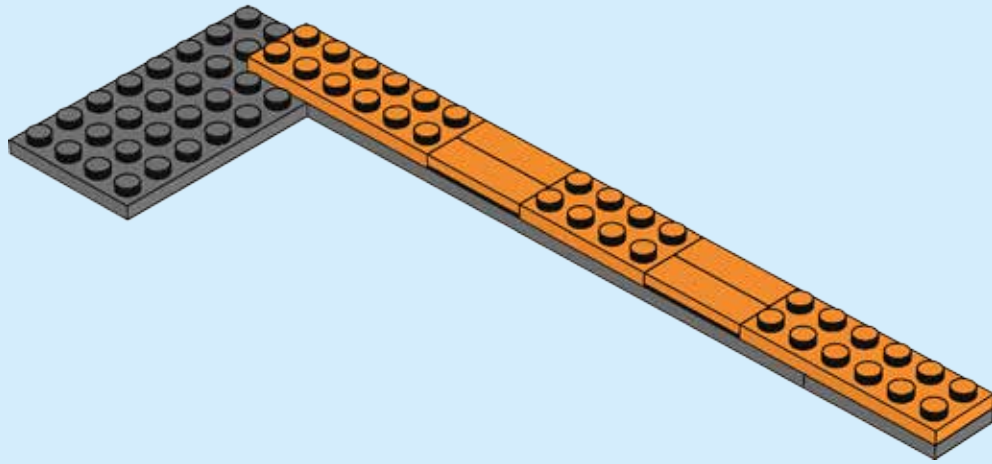

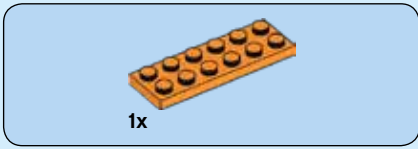

7

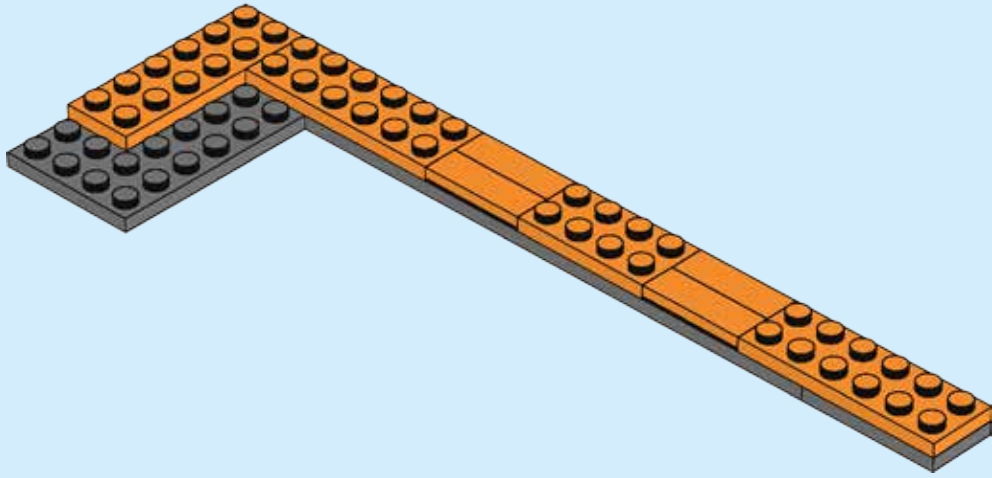

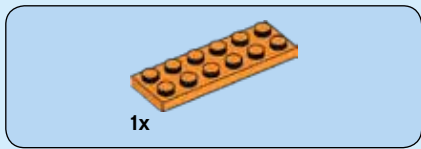

8

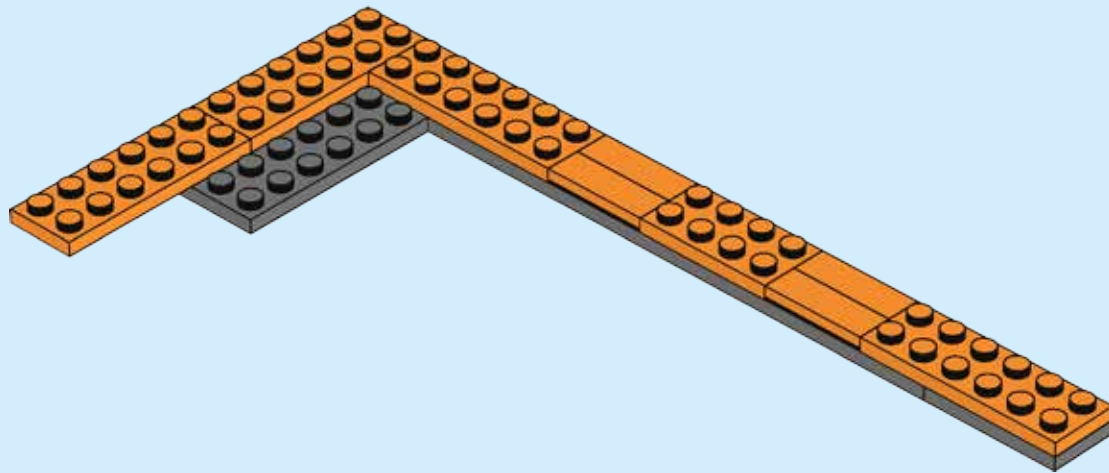

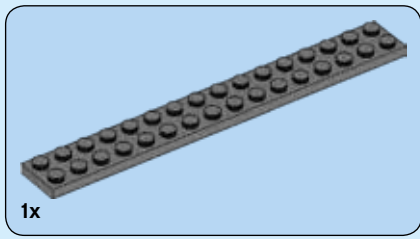

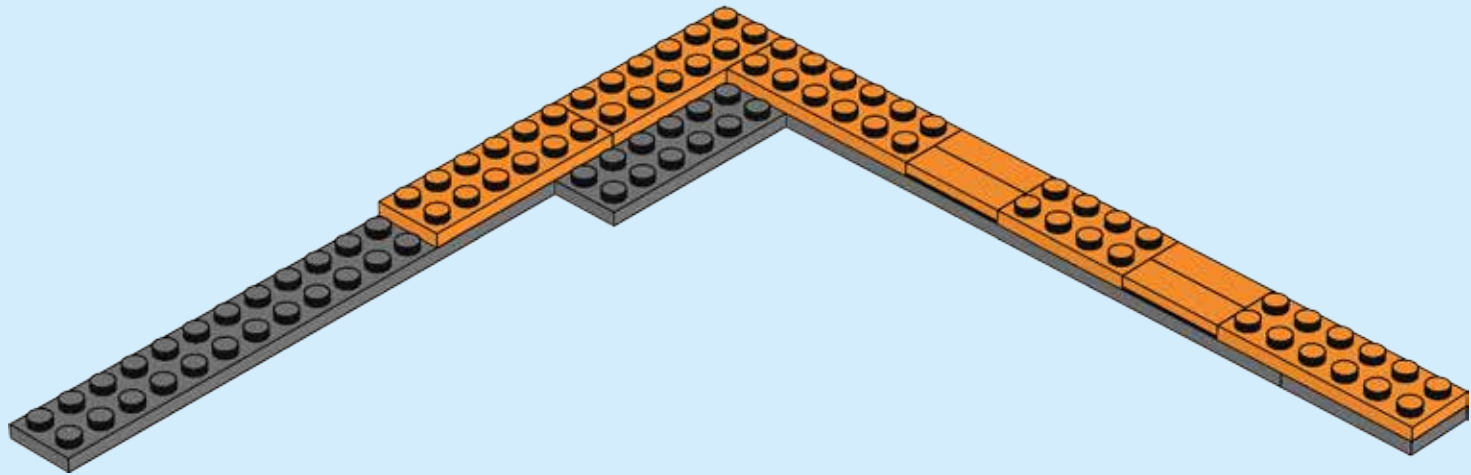

9





1x  4x 

10

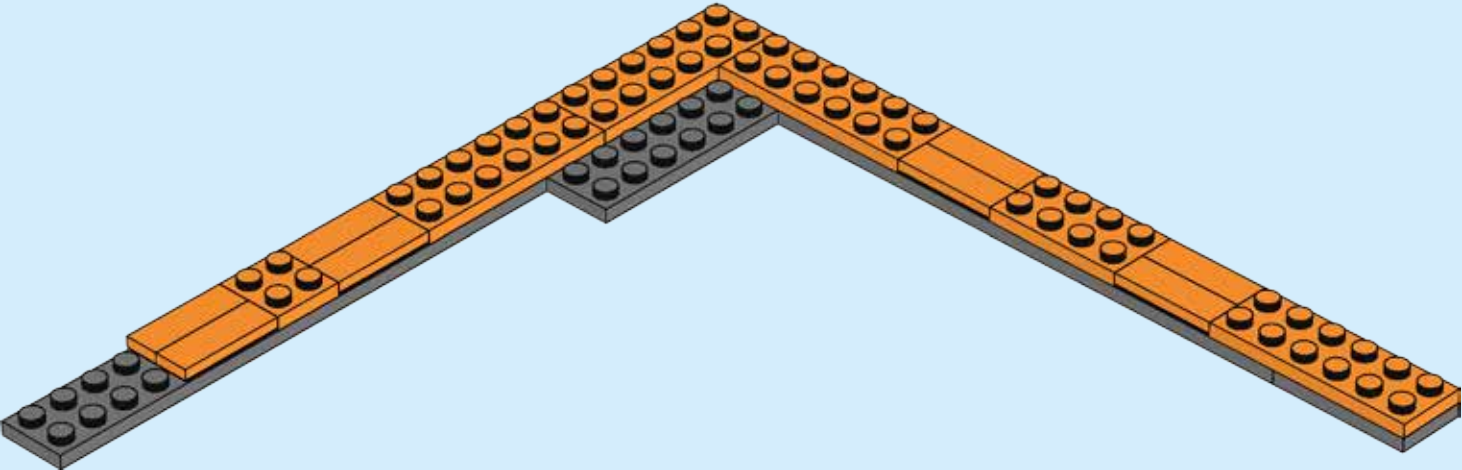

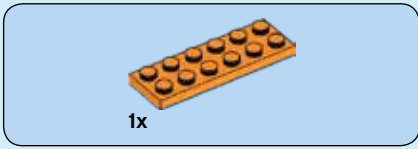

11

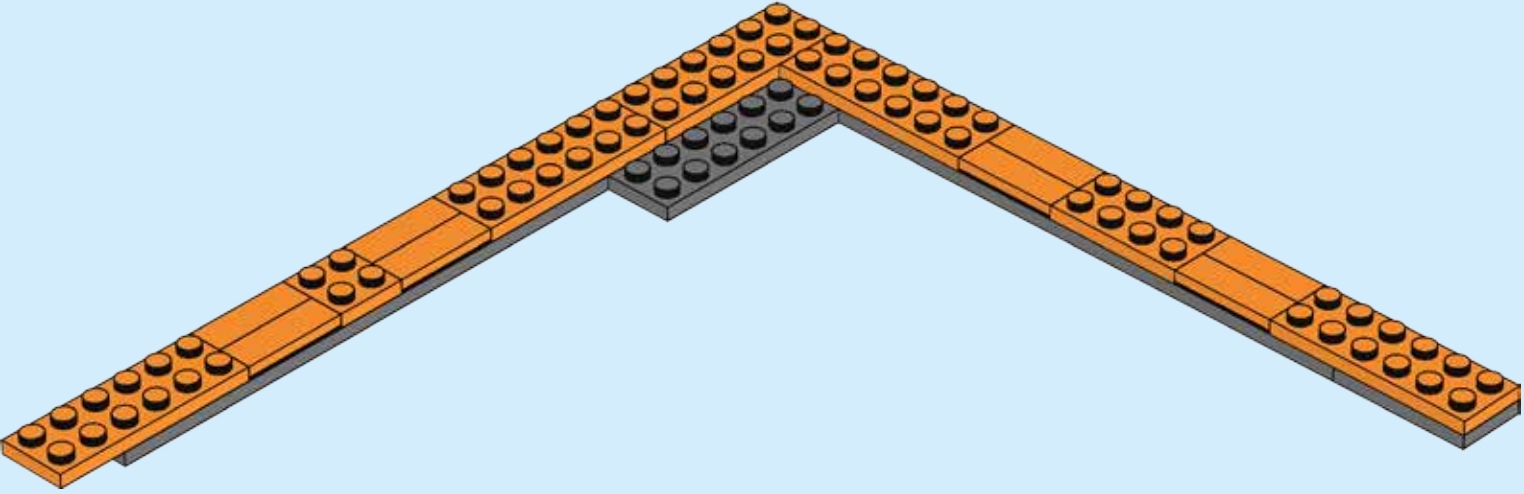

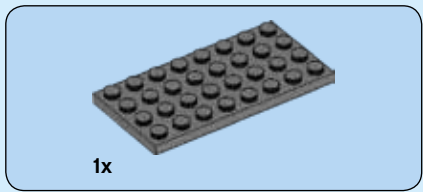

12

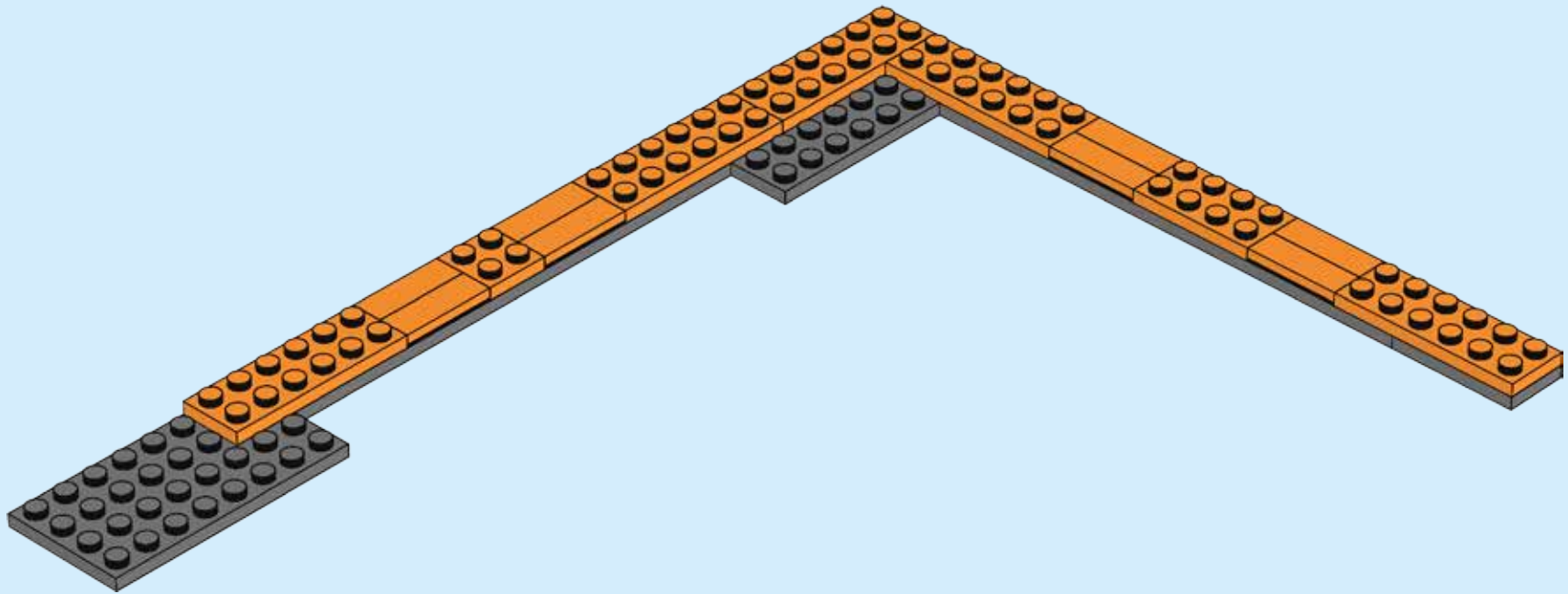

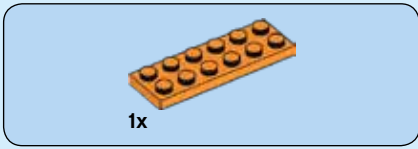

13

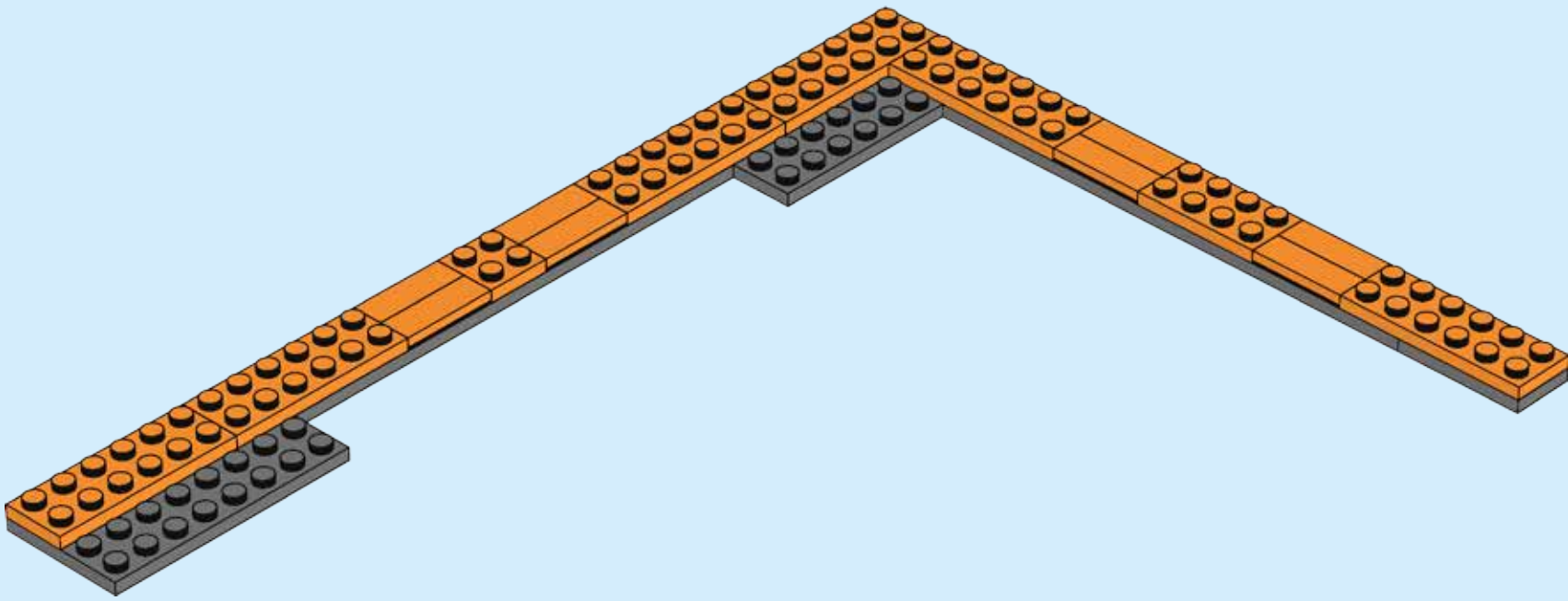

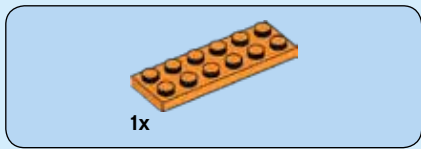

14

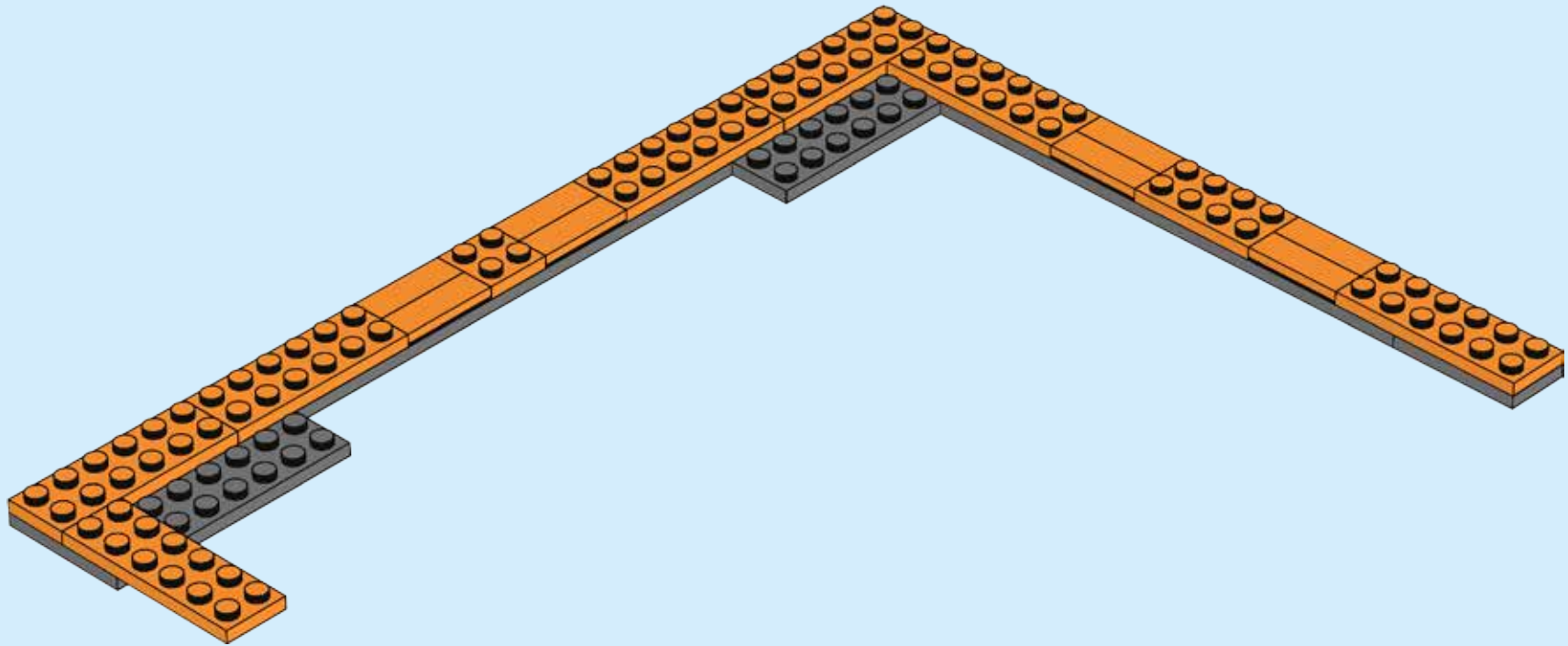

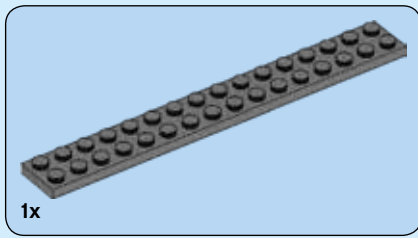

15

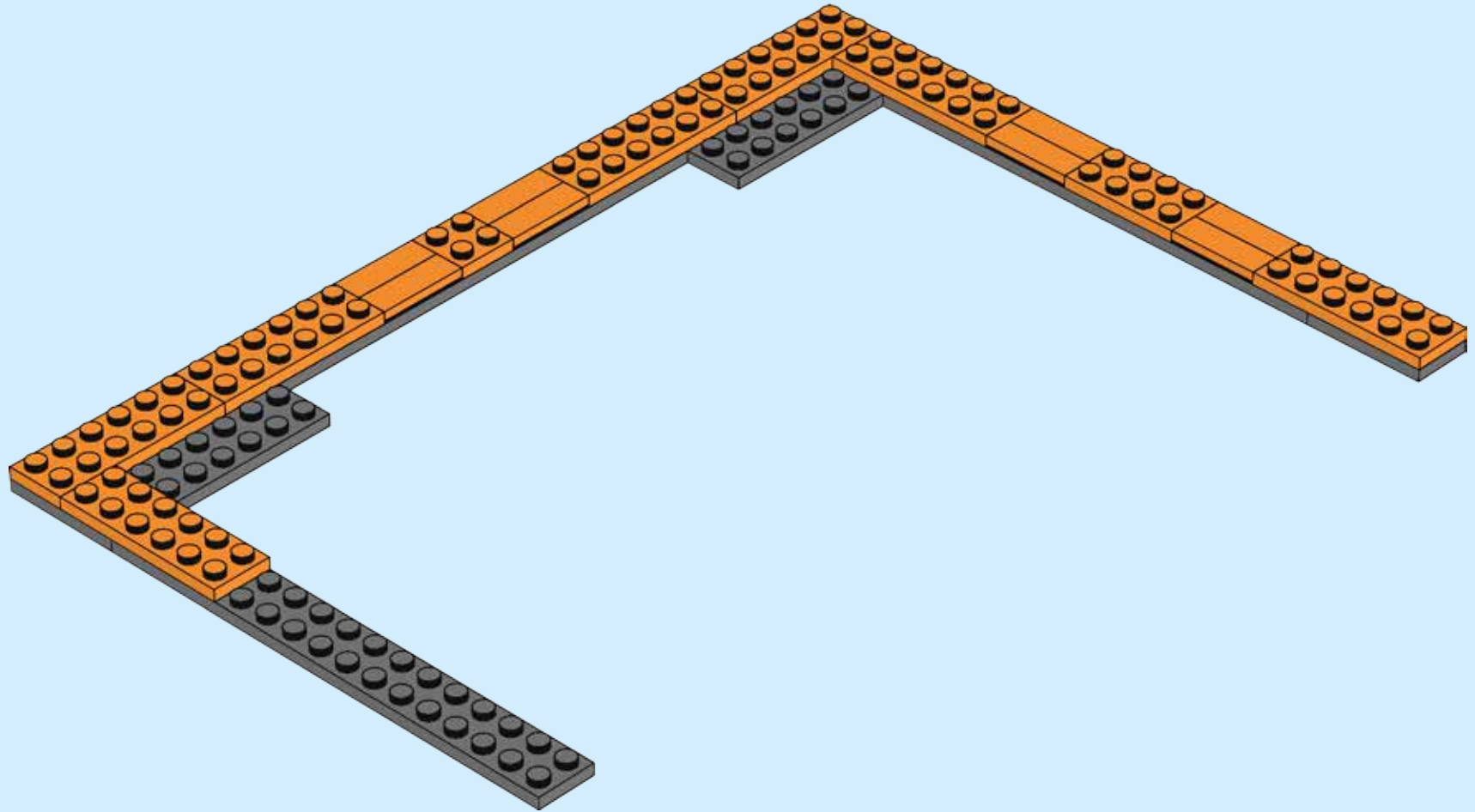

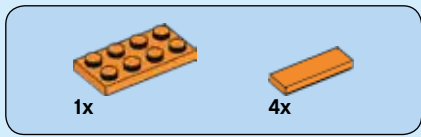

16

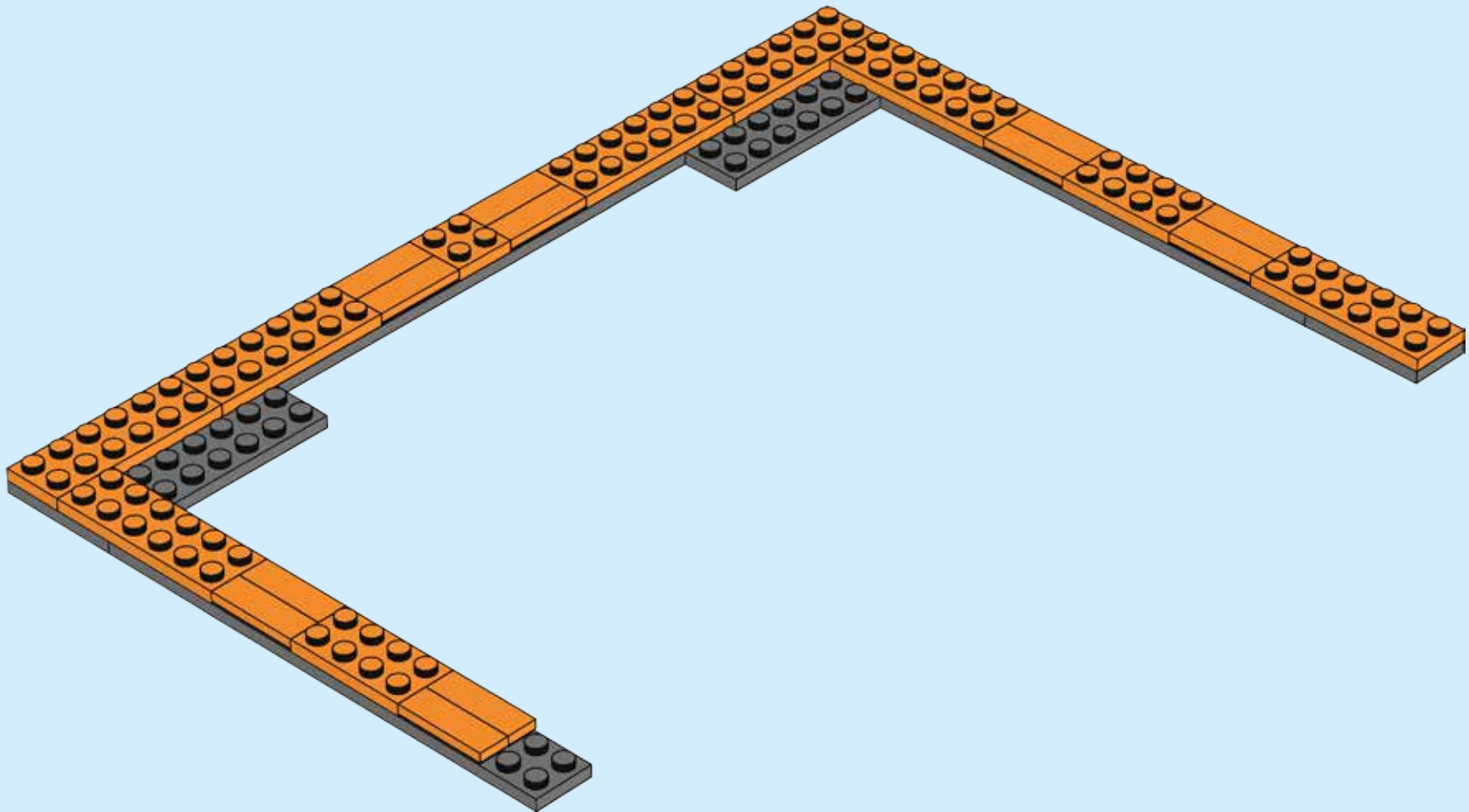

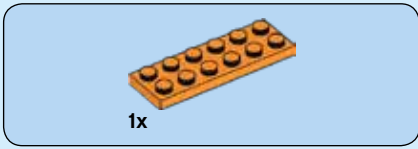

17

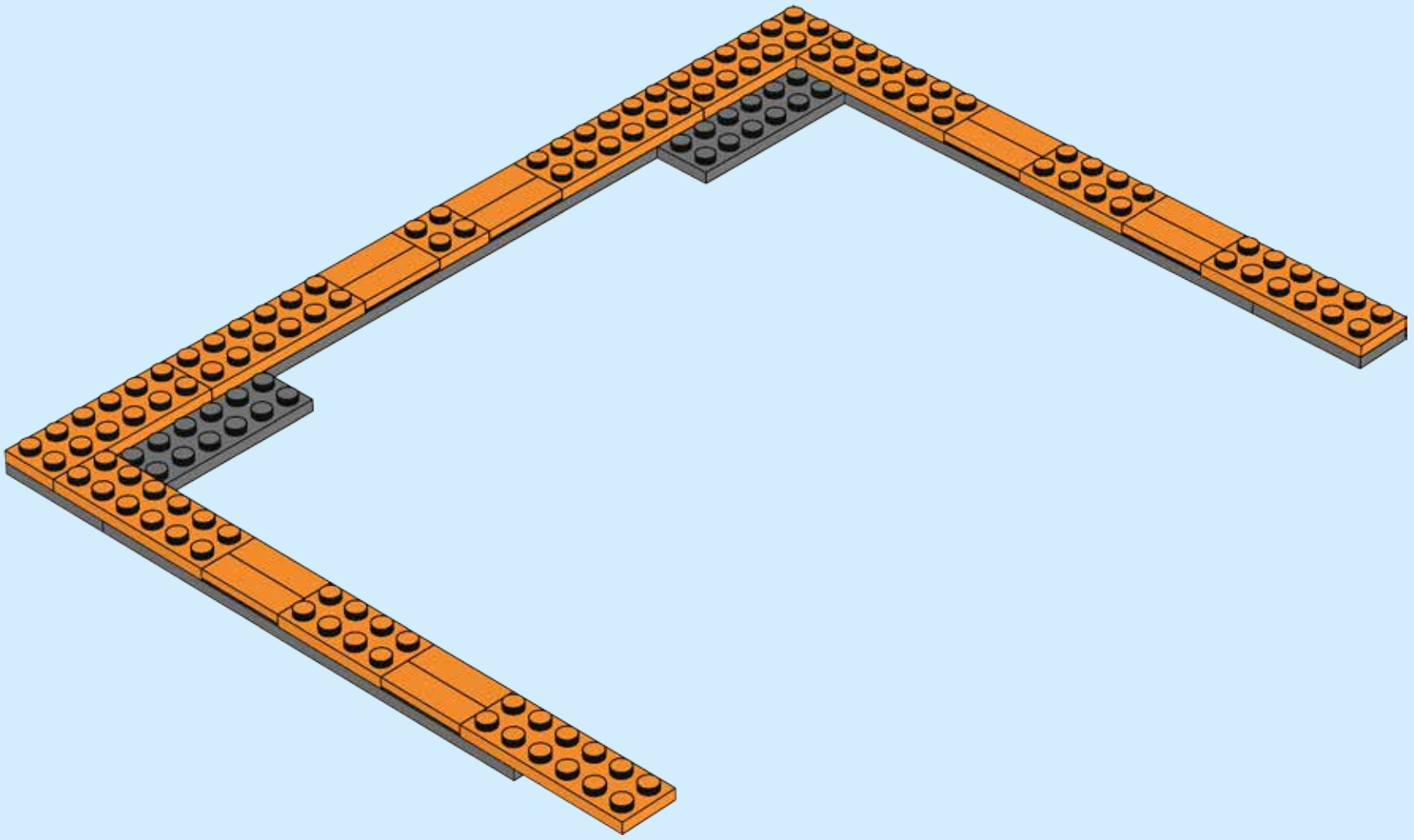



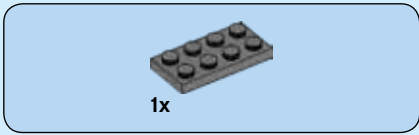

18

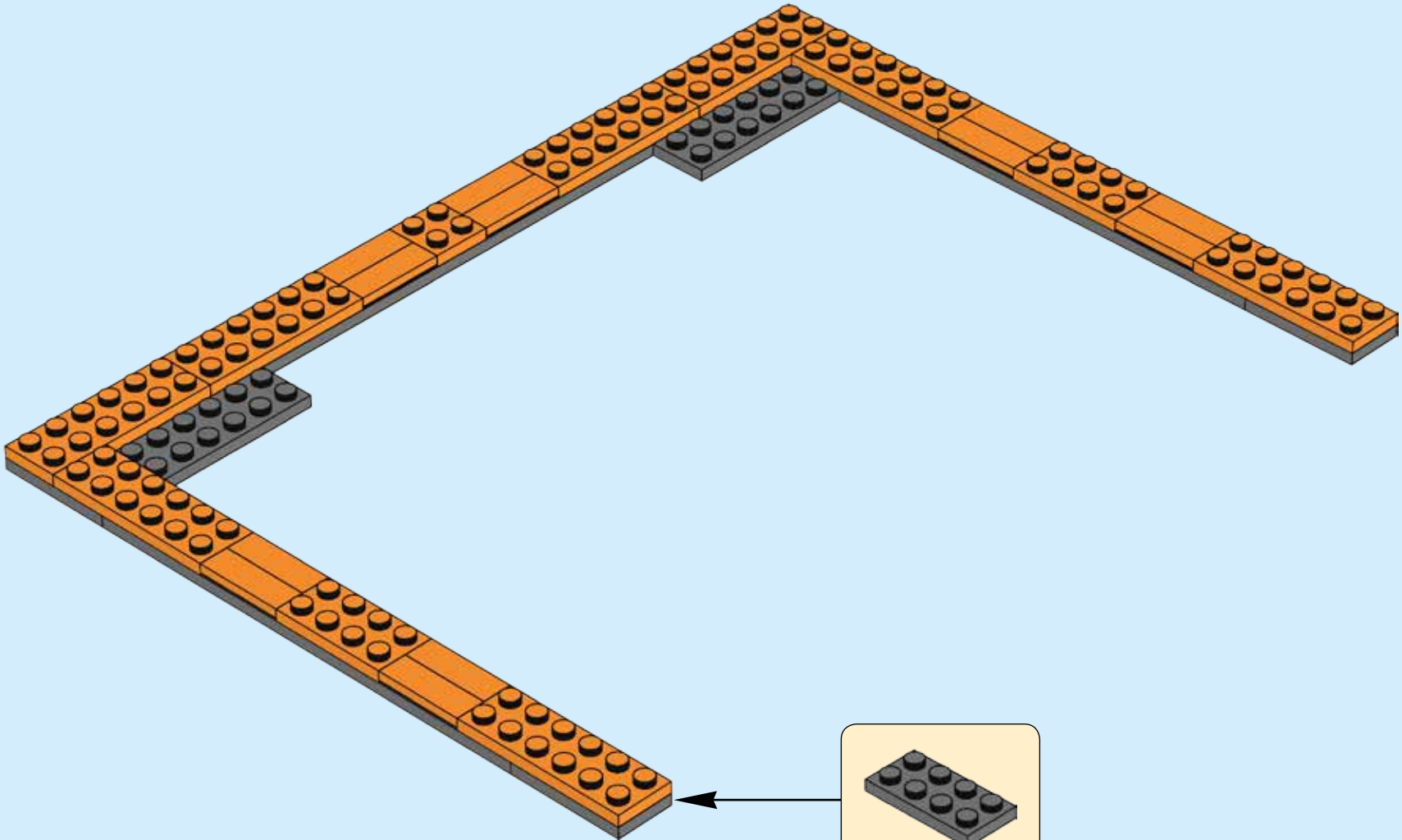

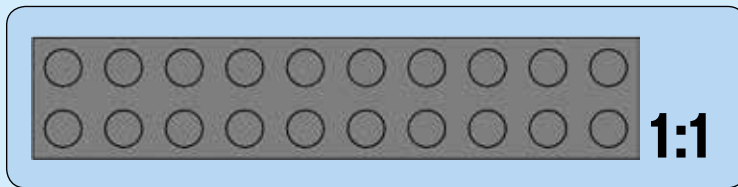
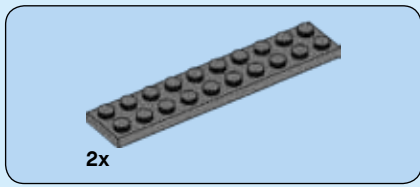

19

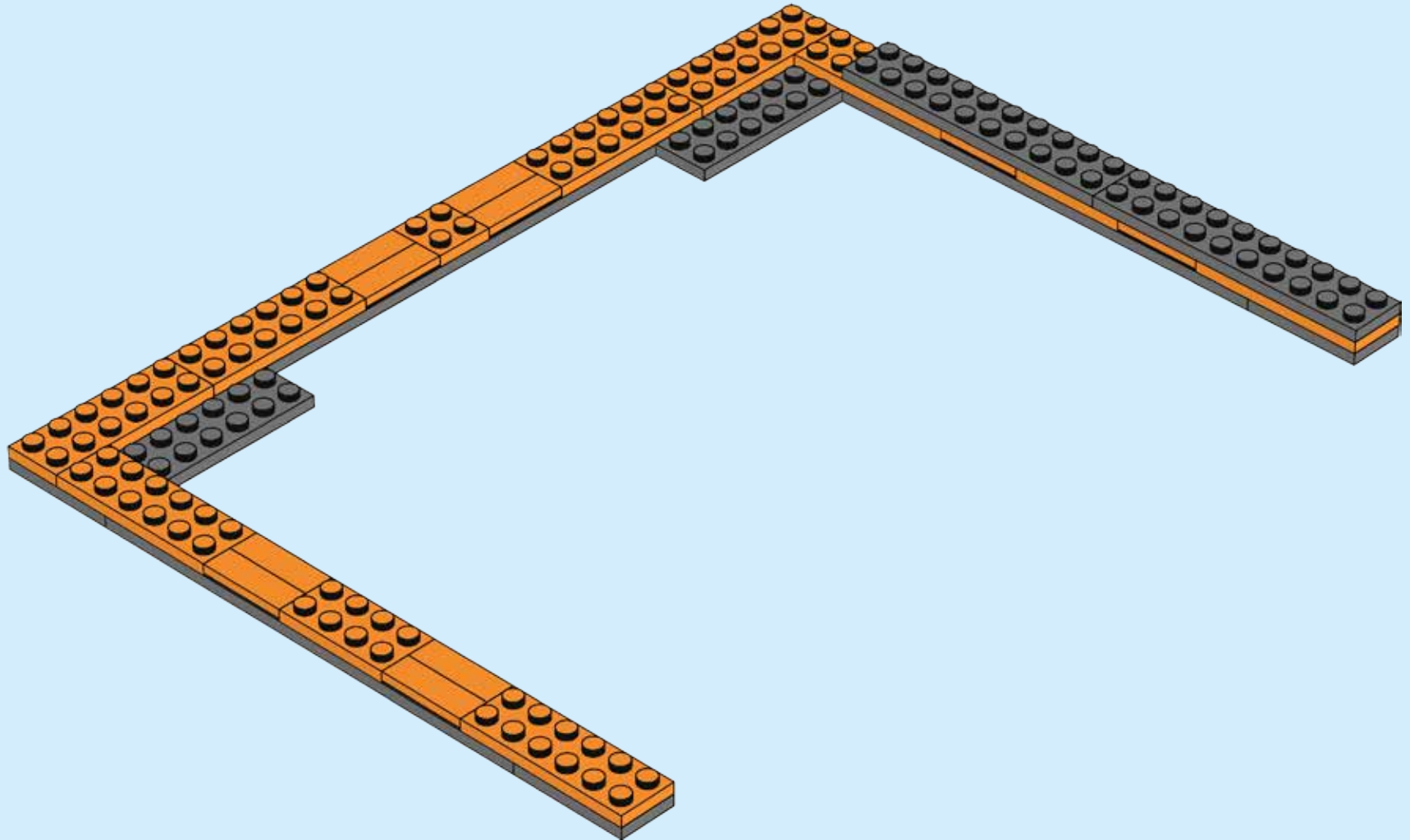

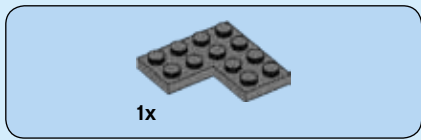

20

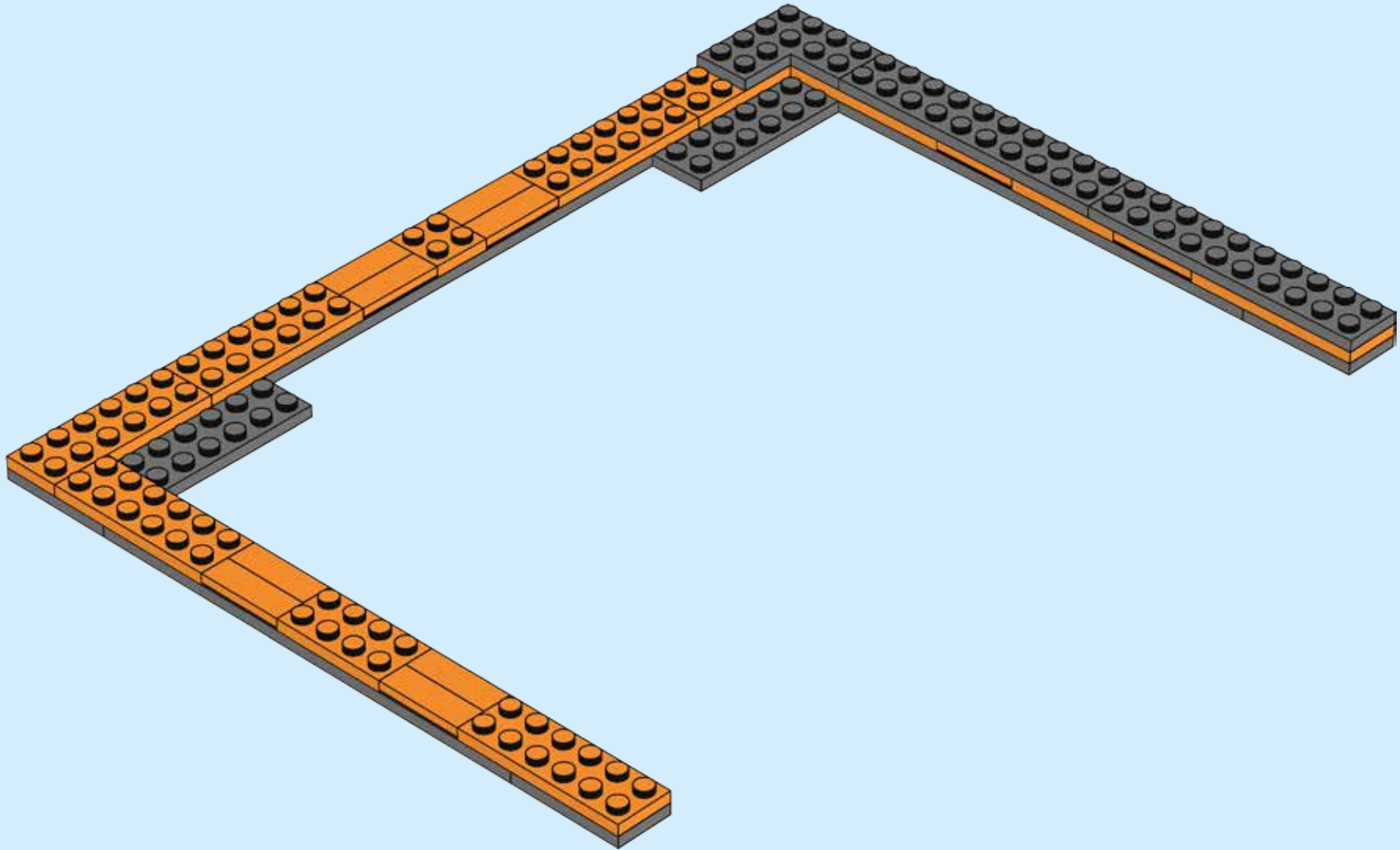

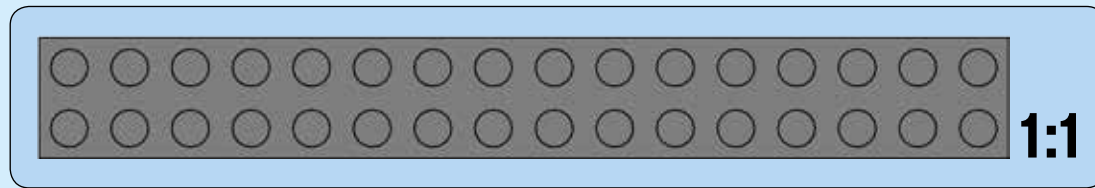
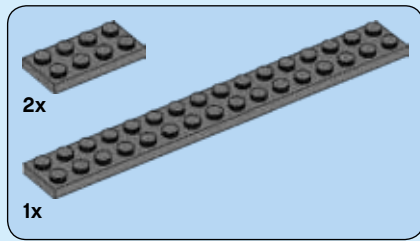

21

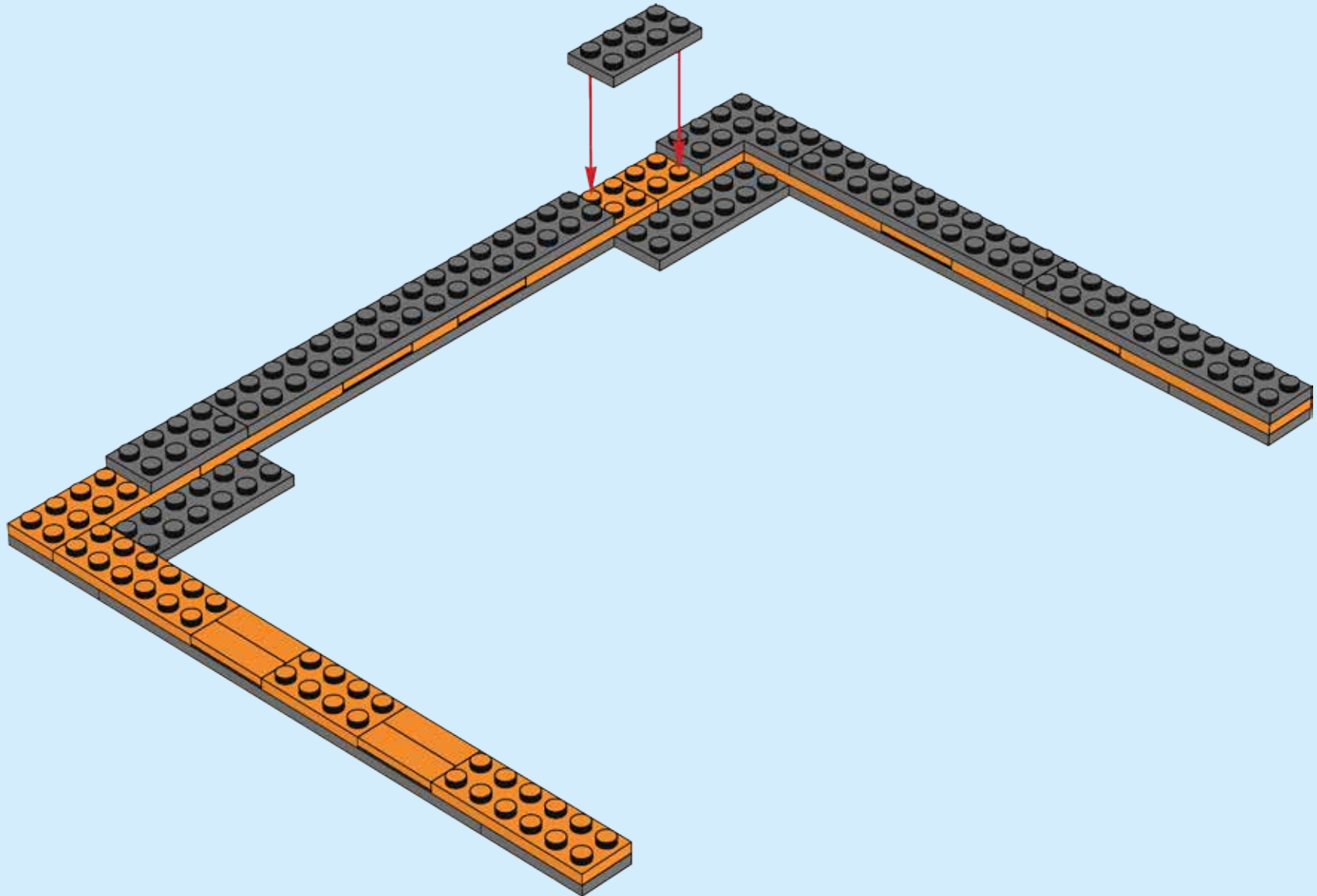

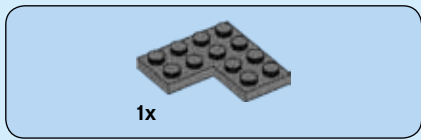

22

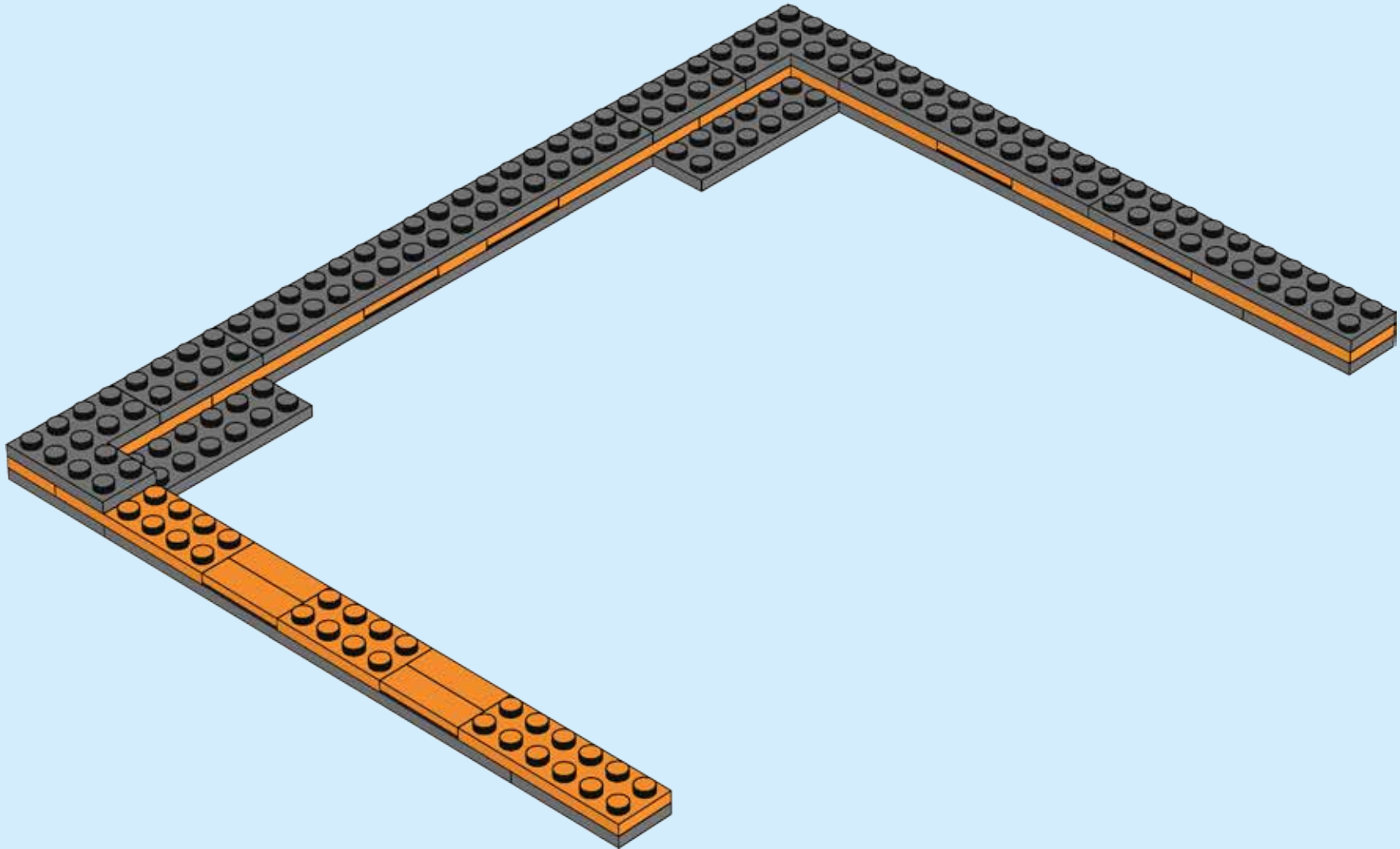

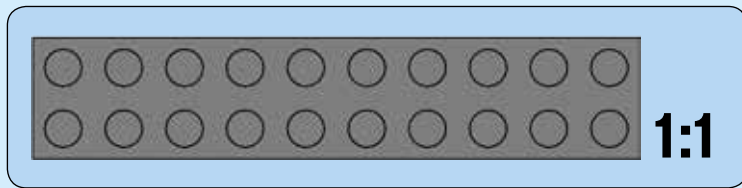
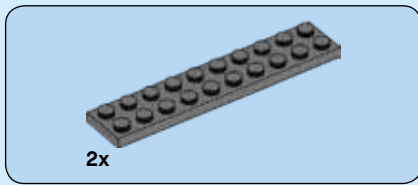

23

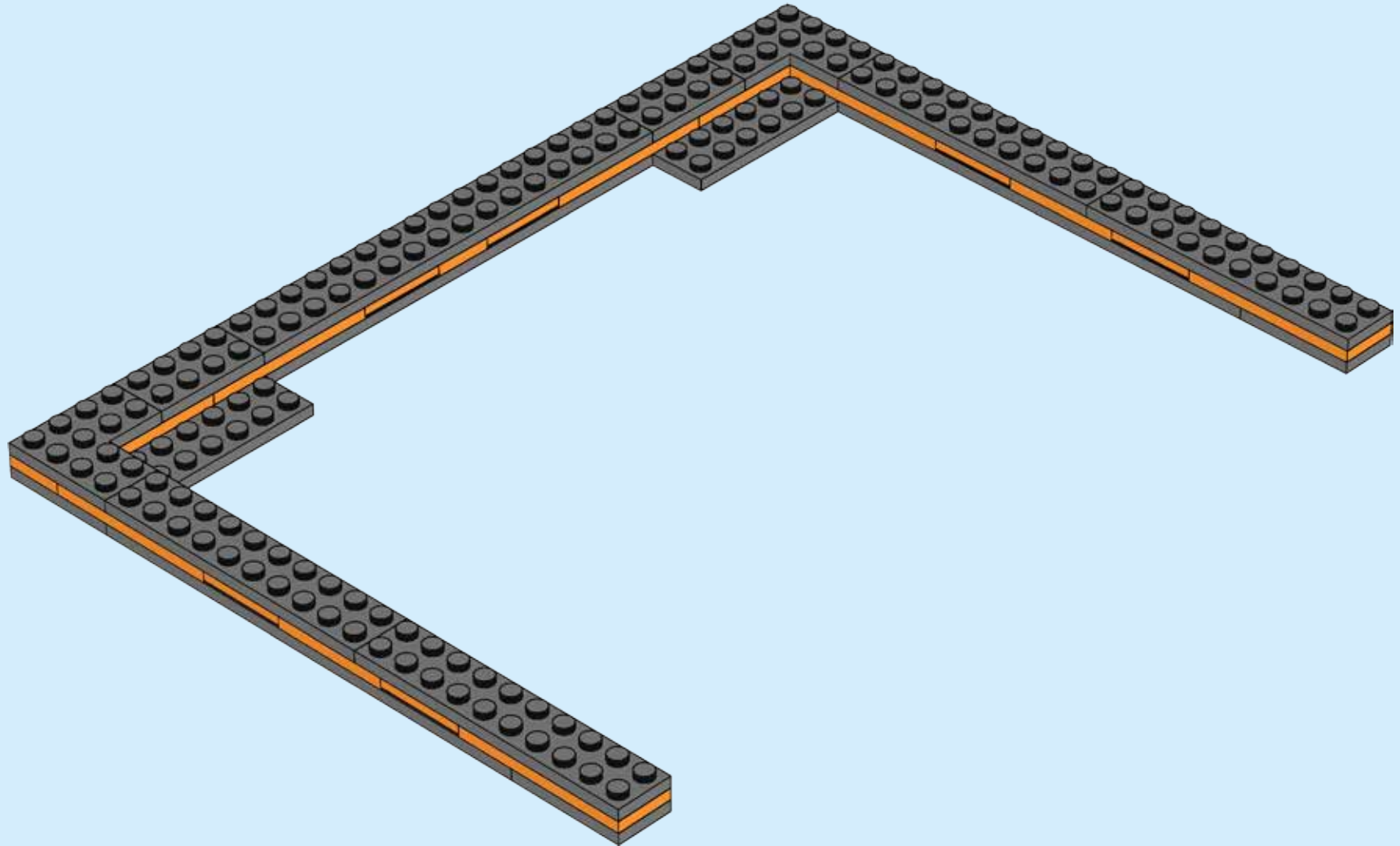



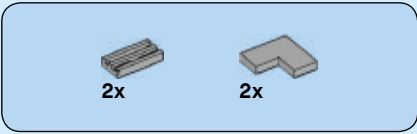

24

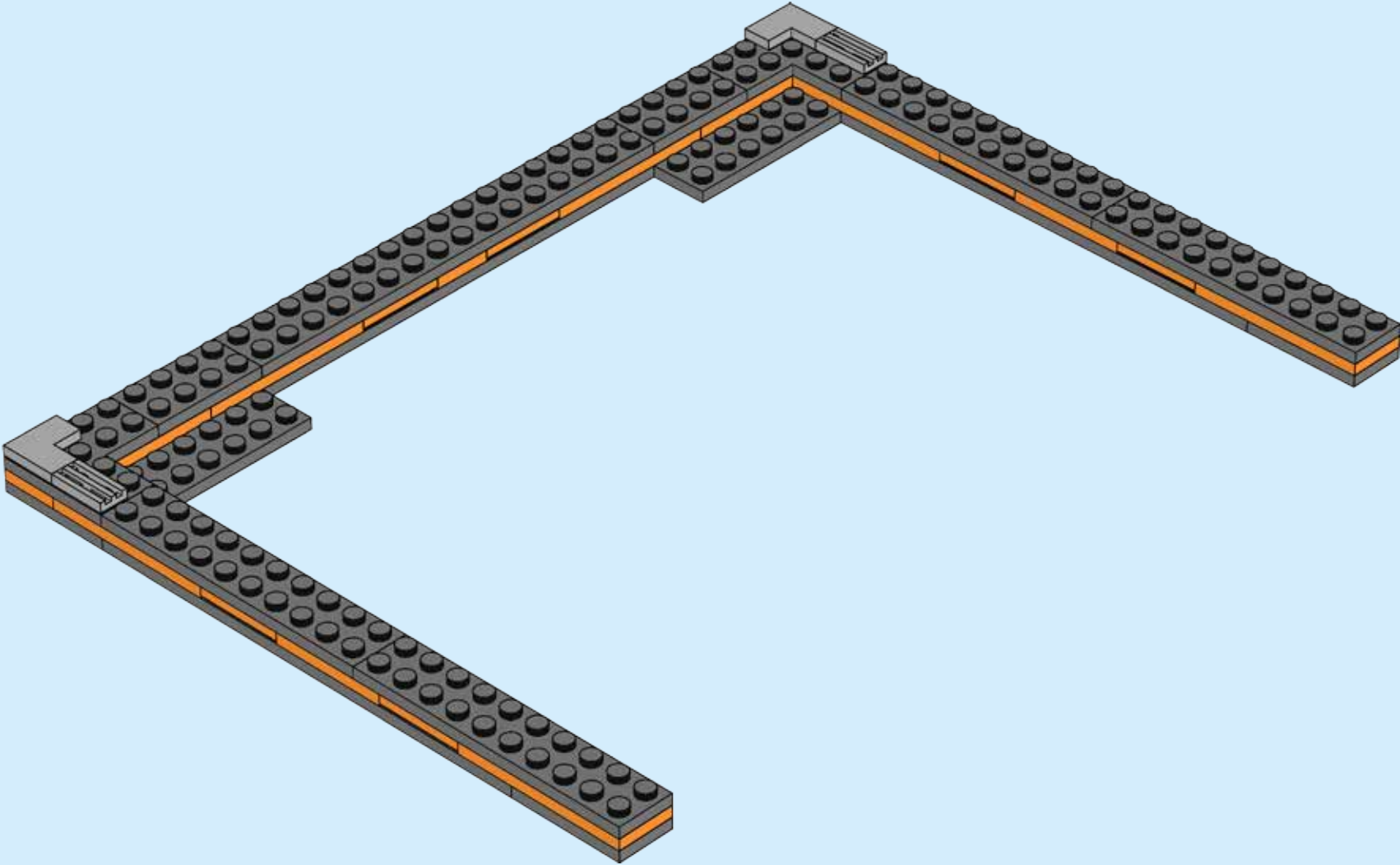

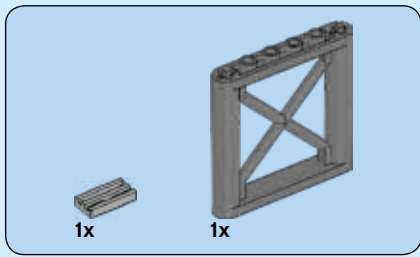

25

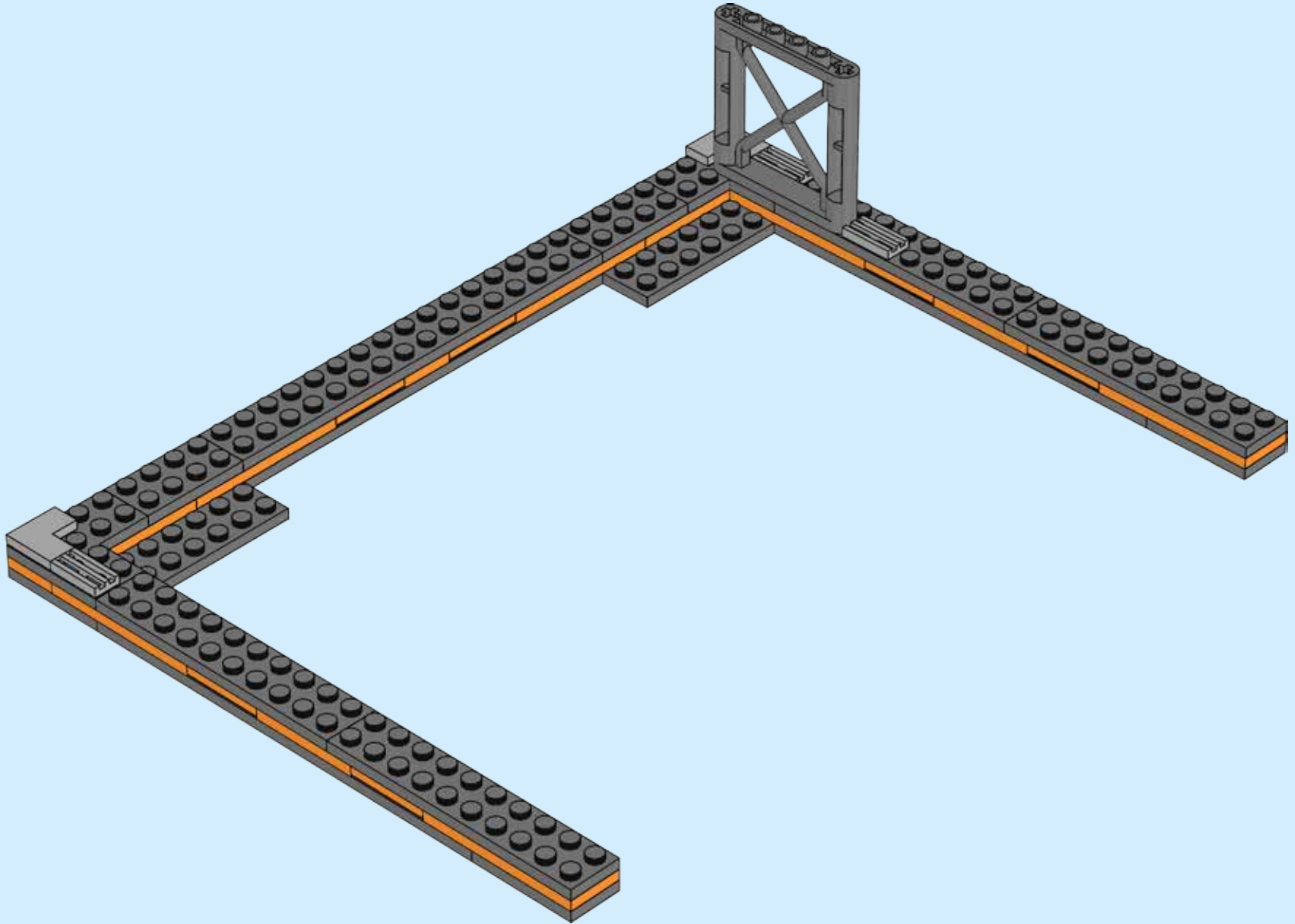



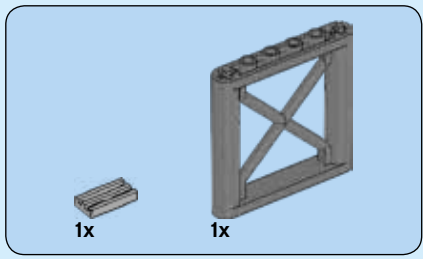

26

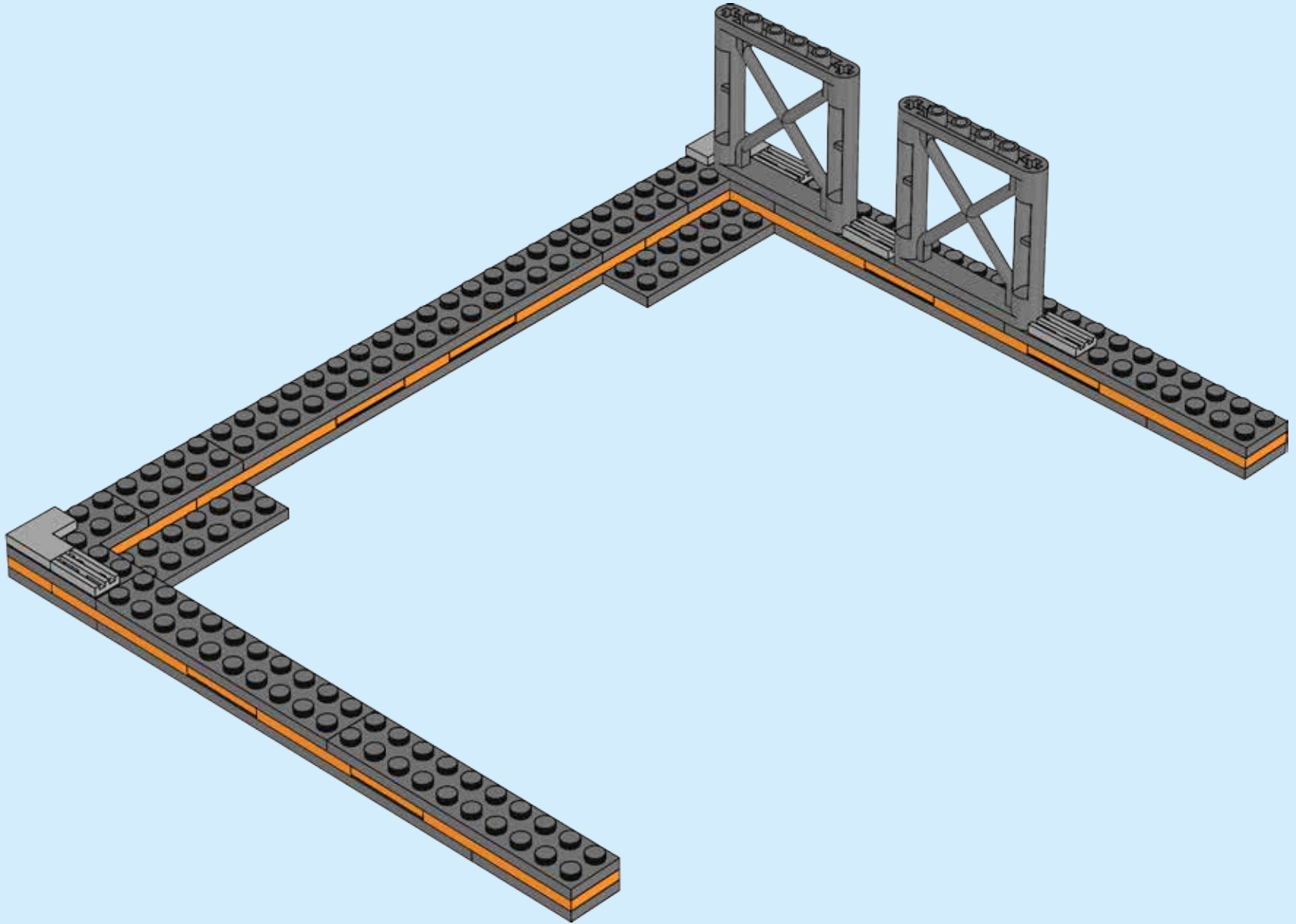

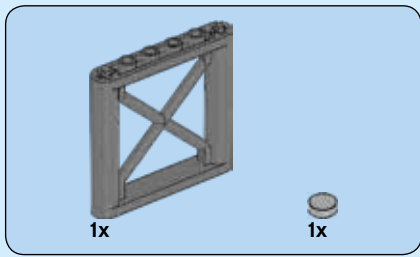

27

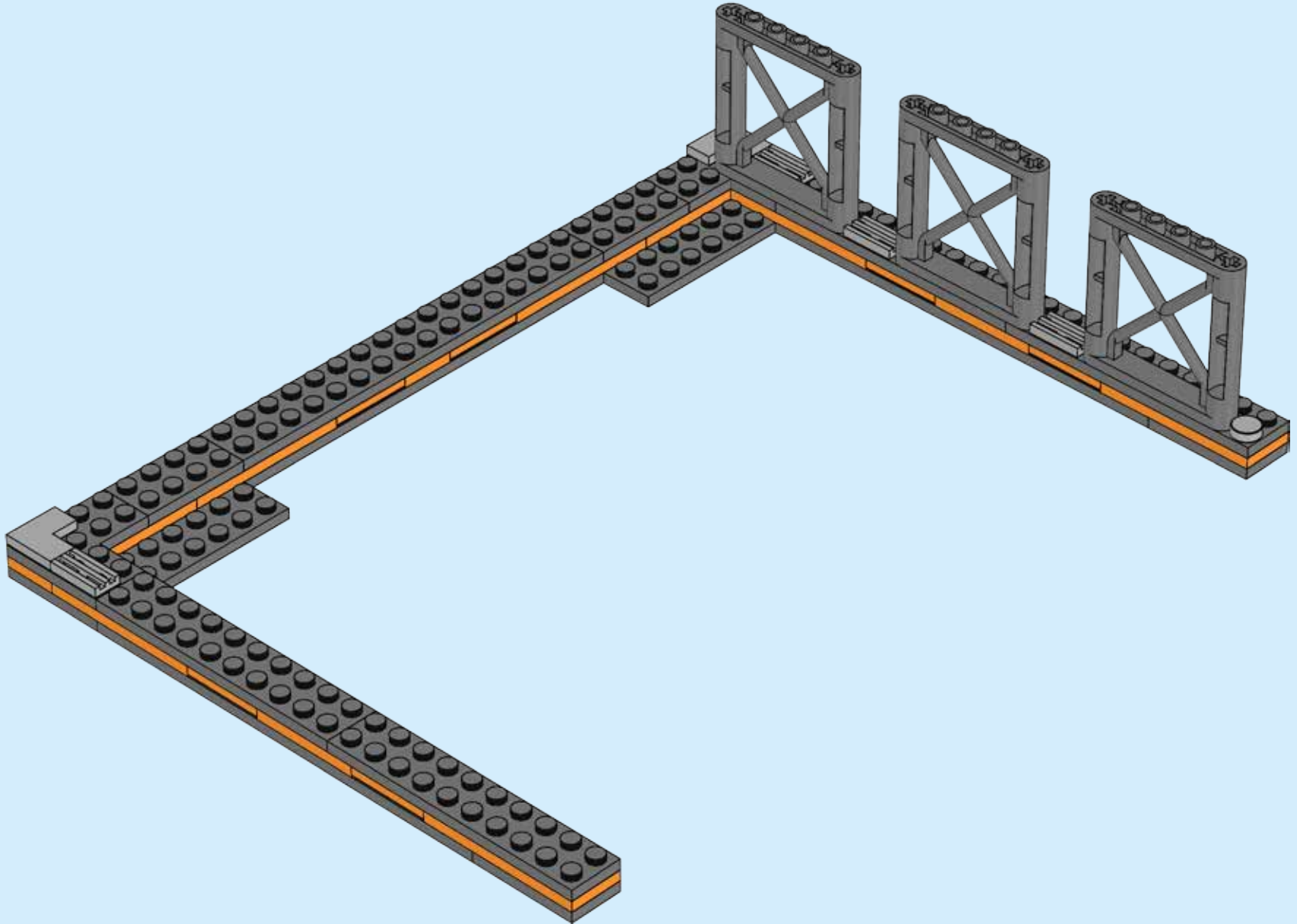

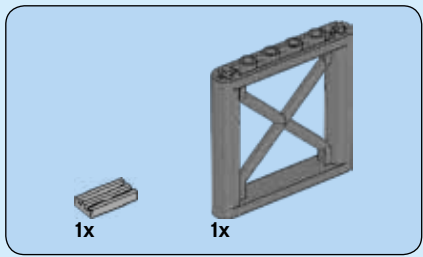

28

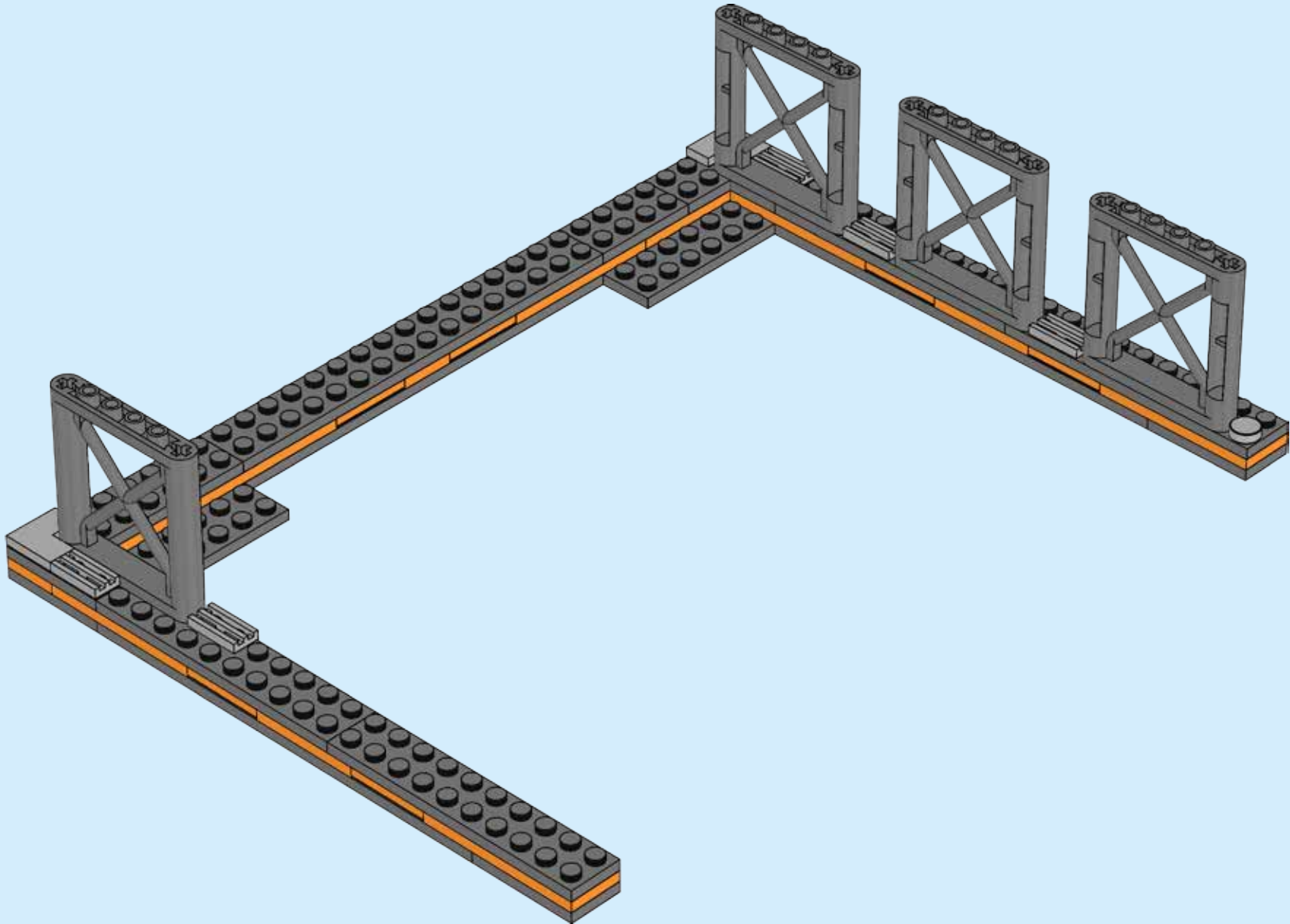

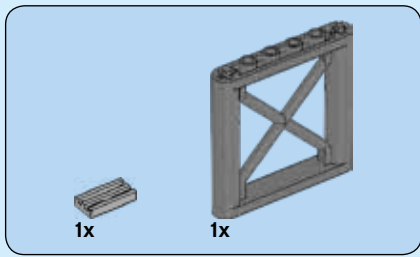

29

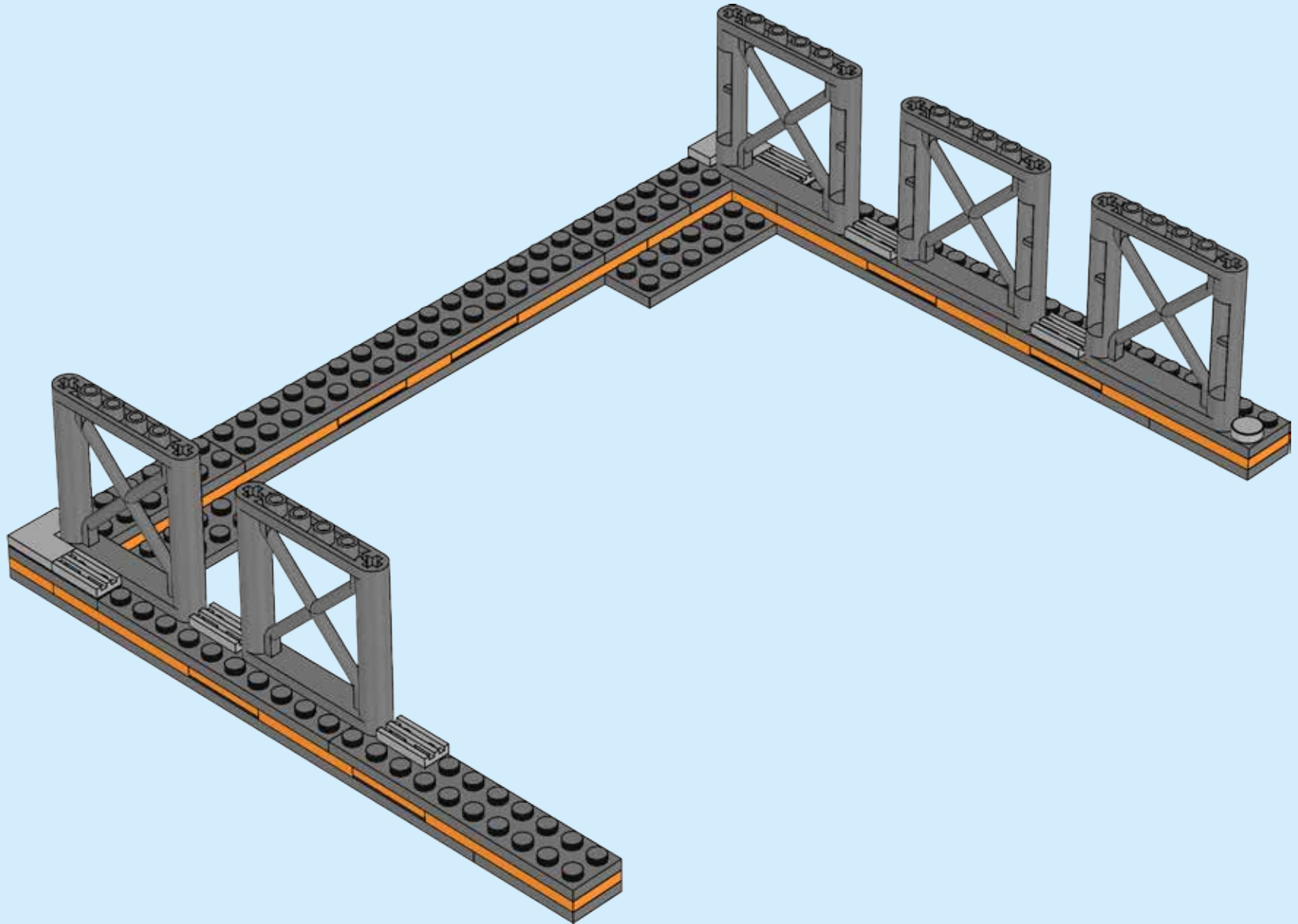

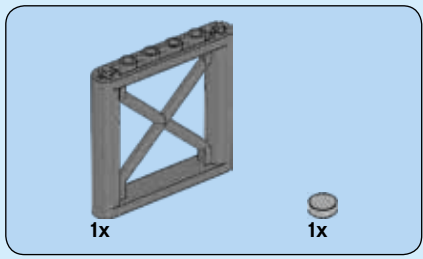

30

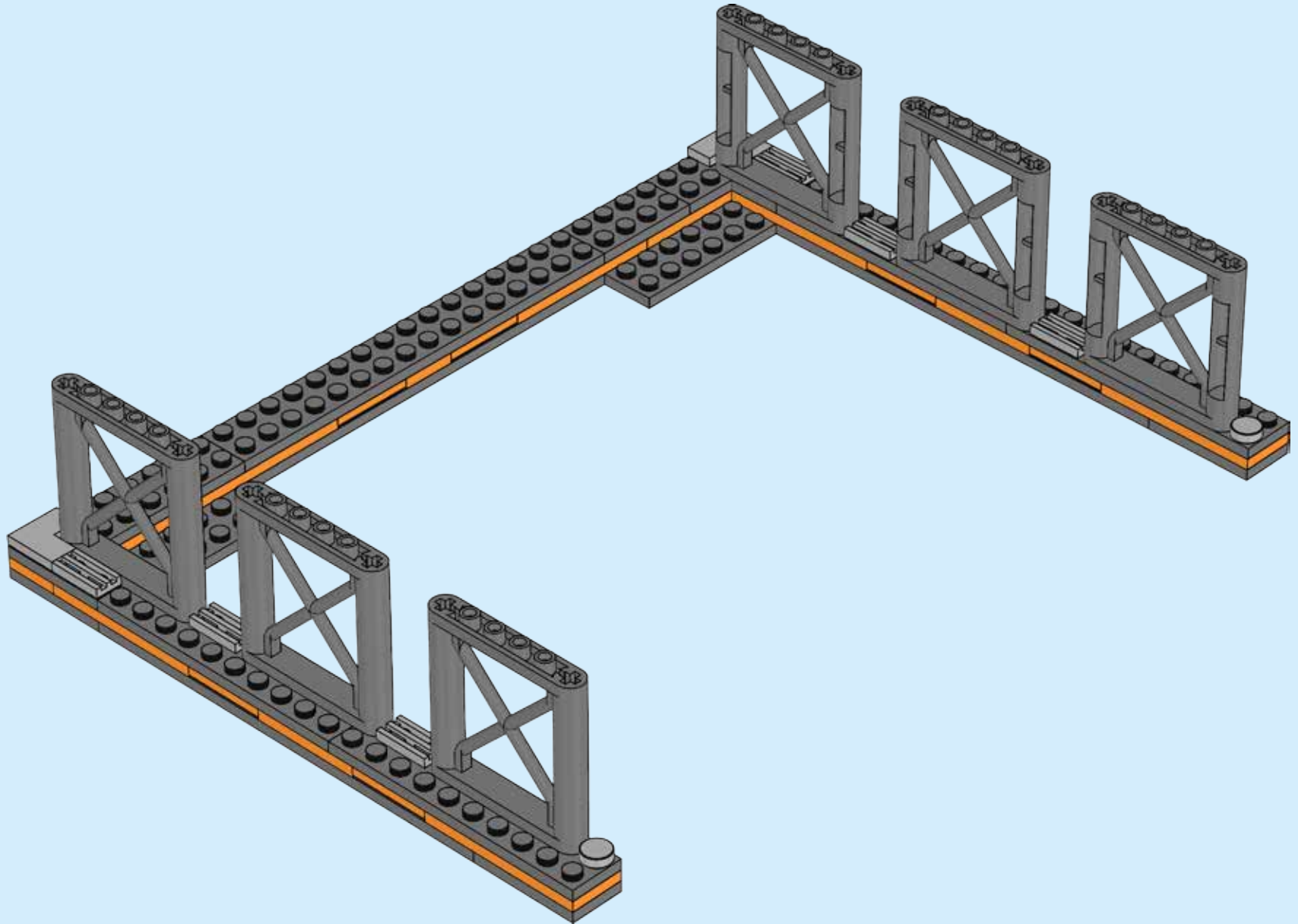



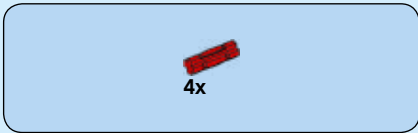

31

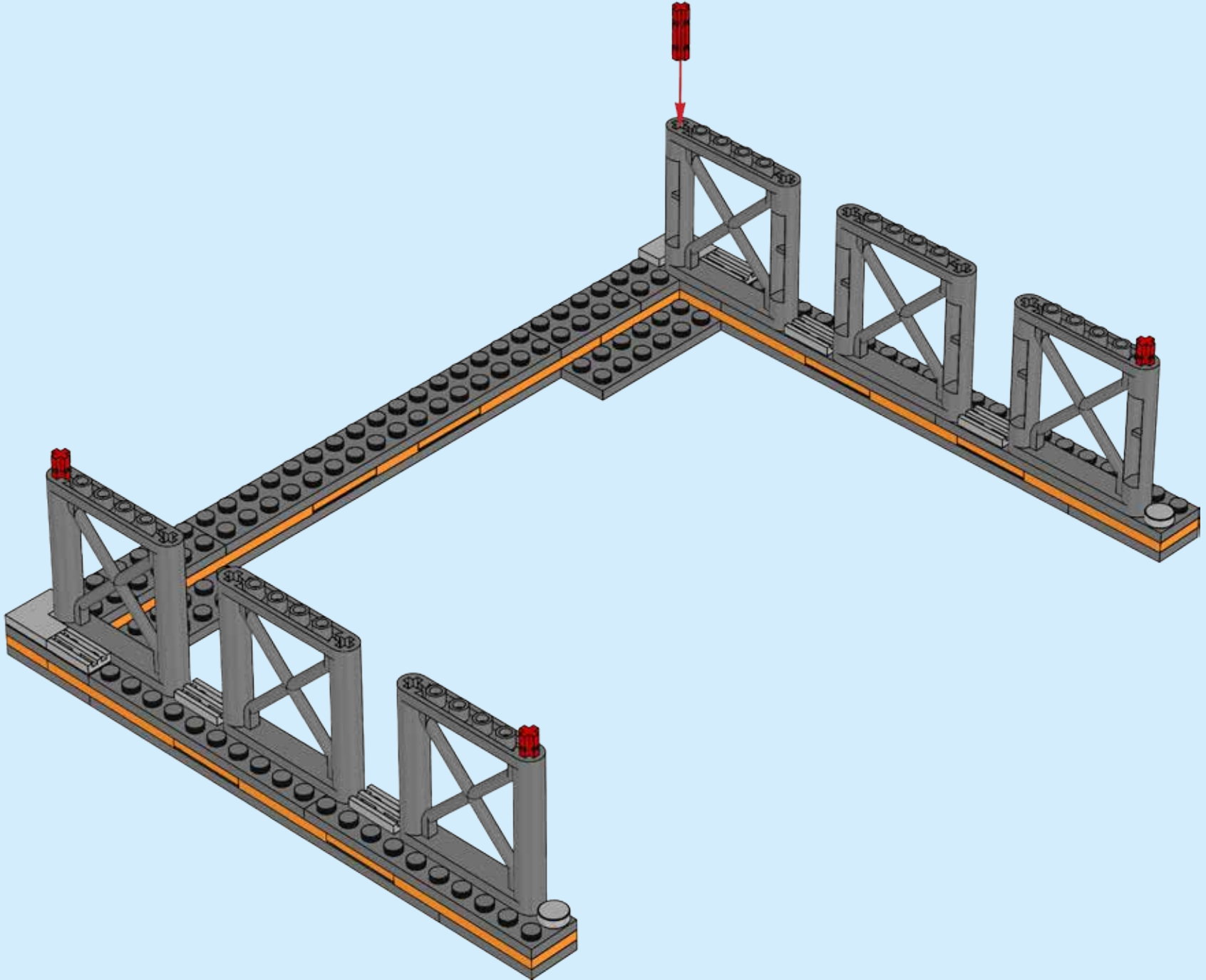

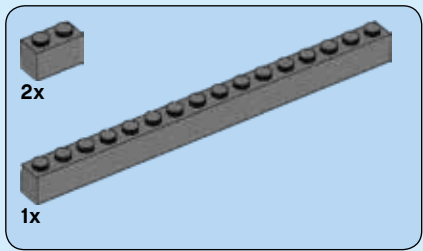

32

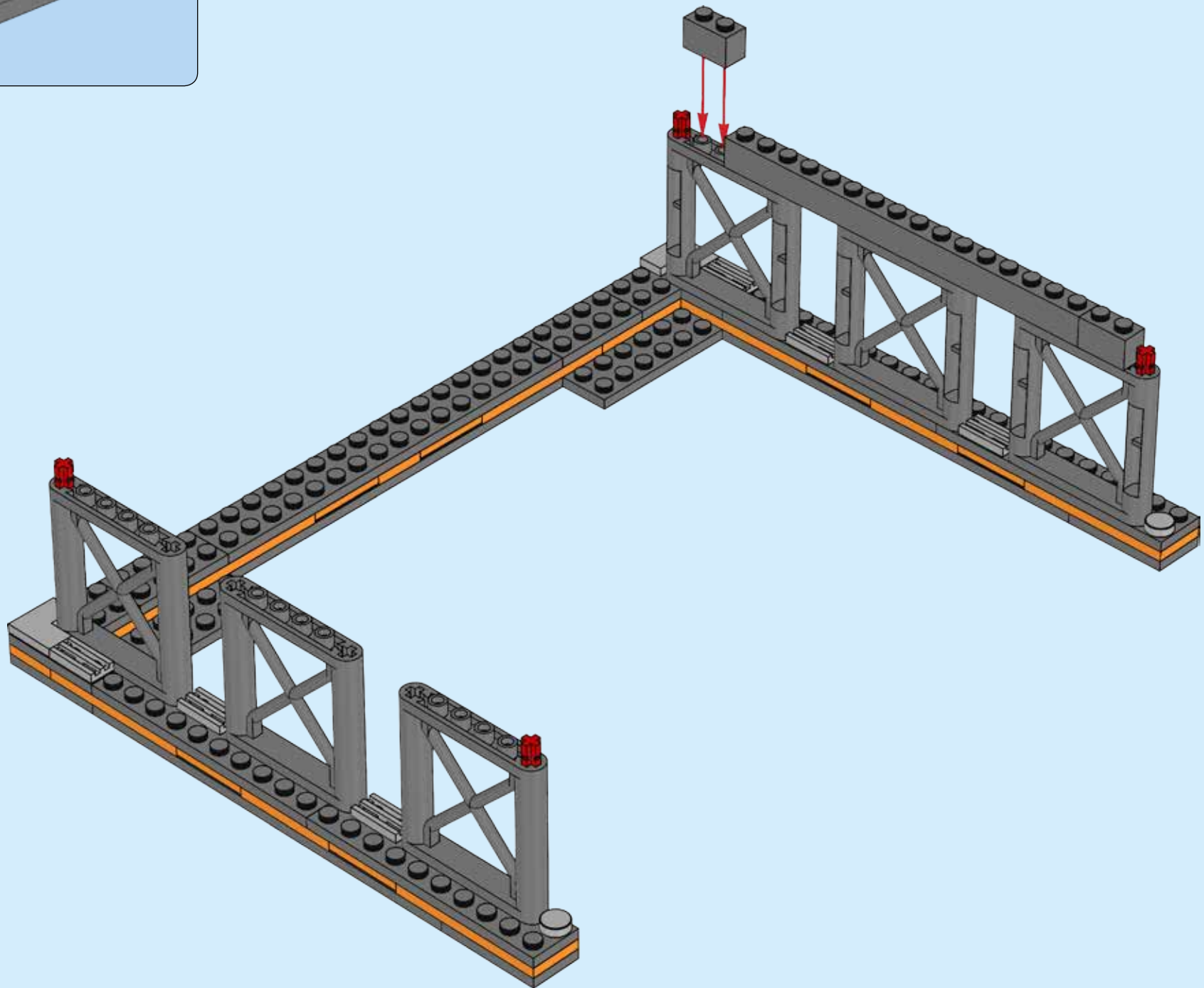

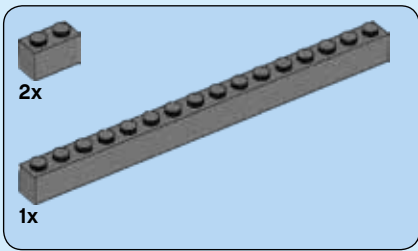

33

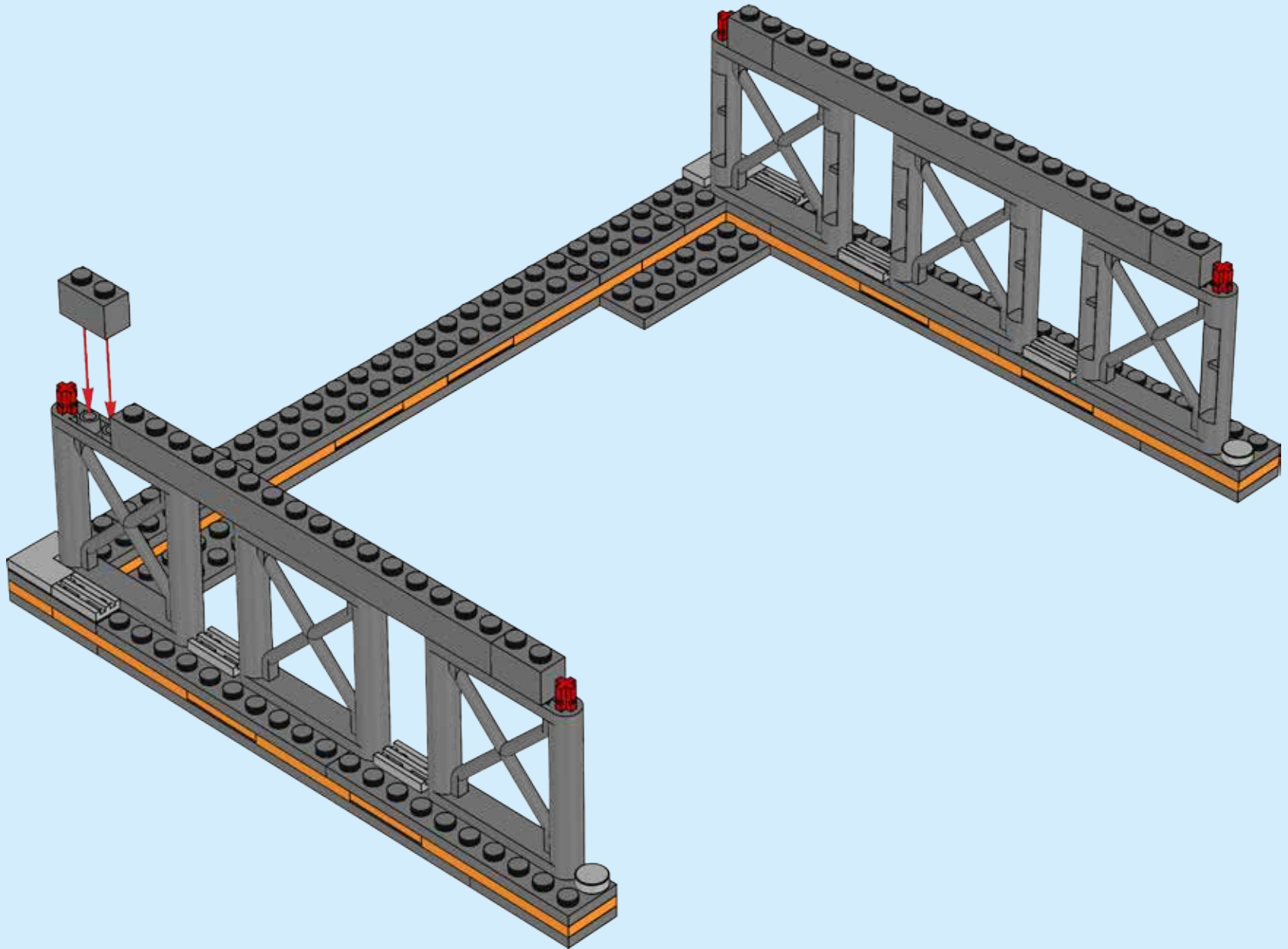



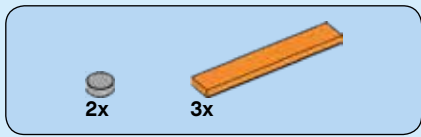

34

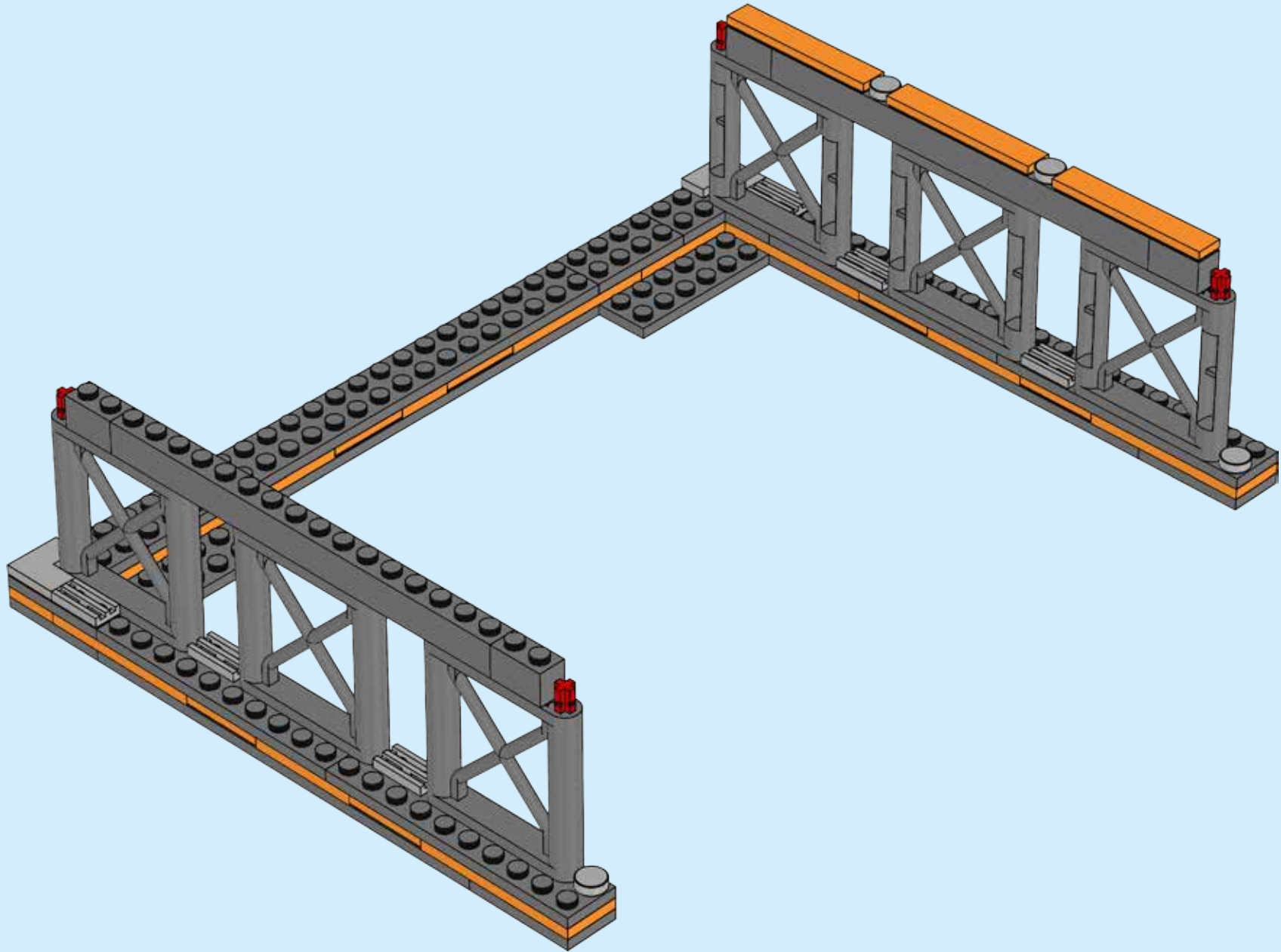

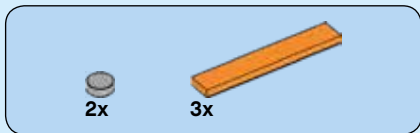

35

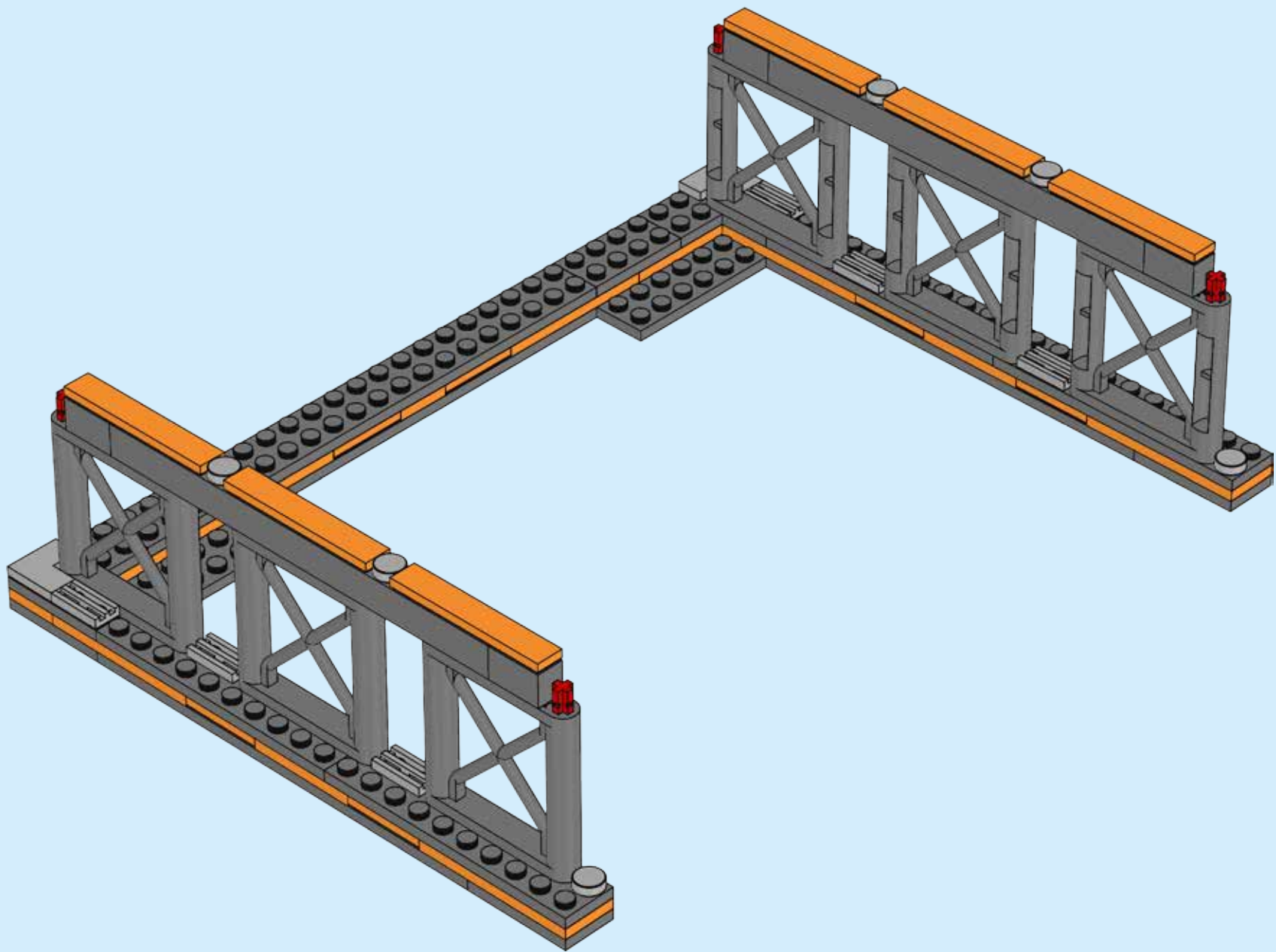

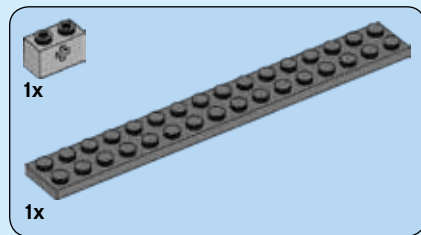
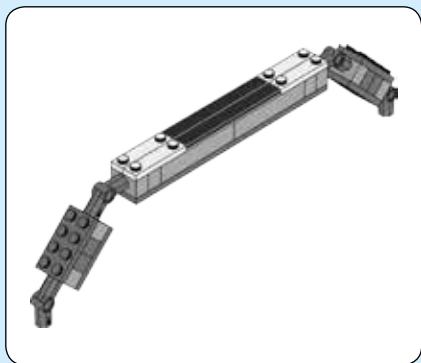
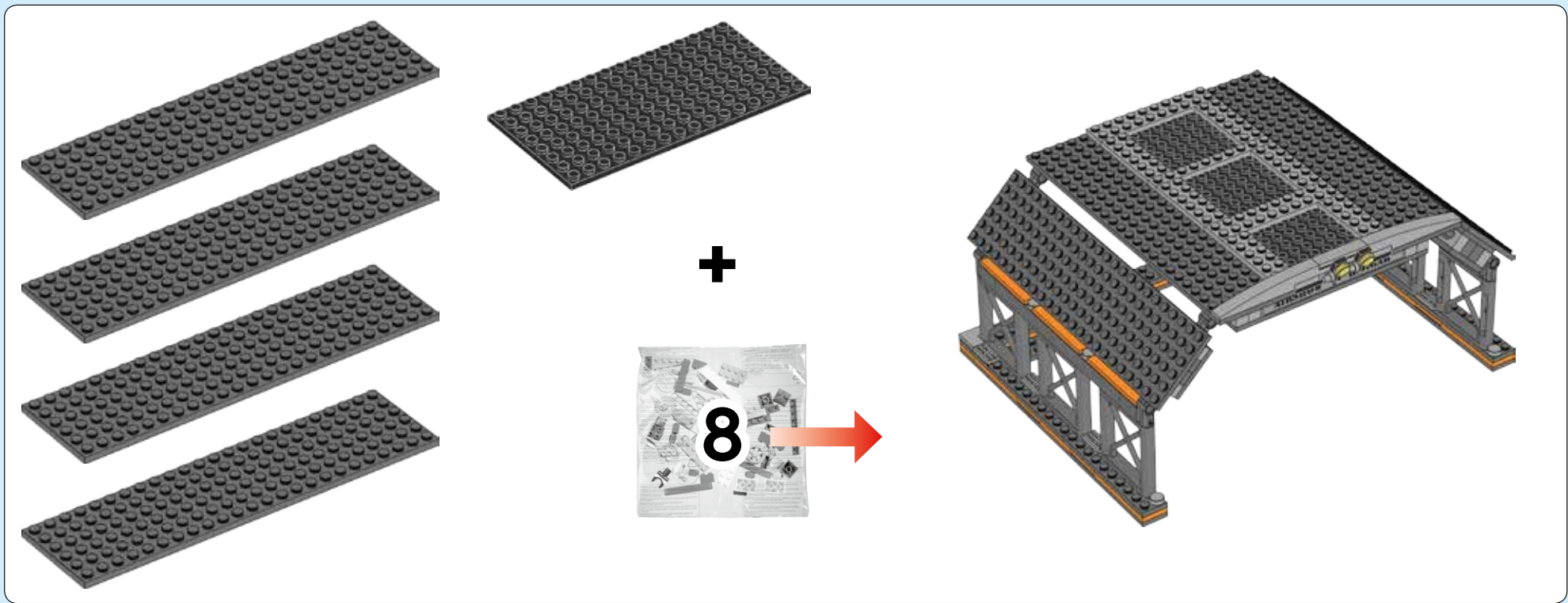

**36**

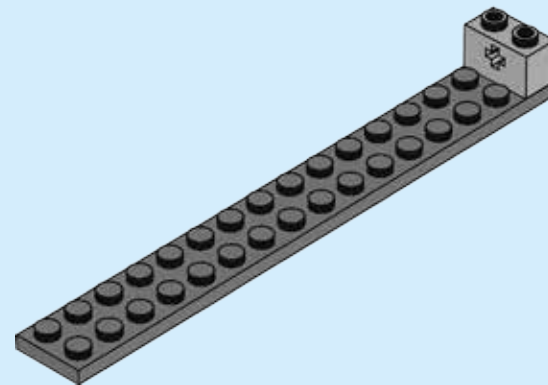

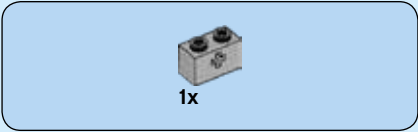

37

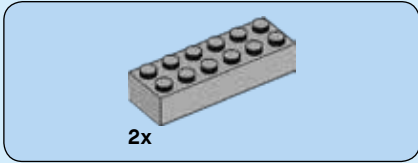
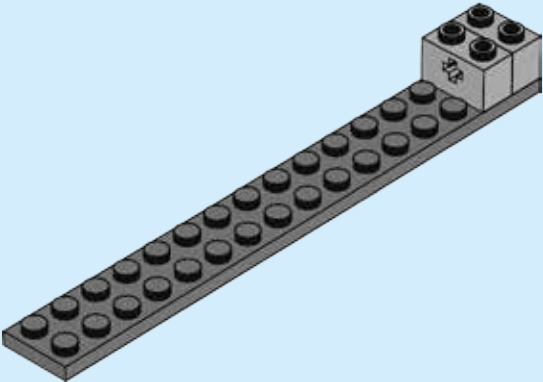

38

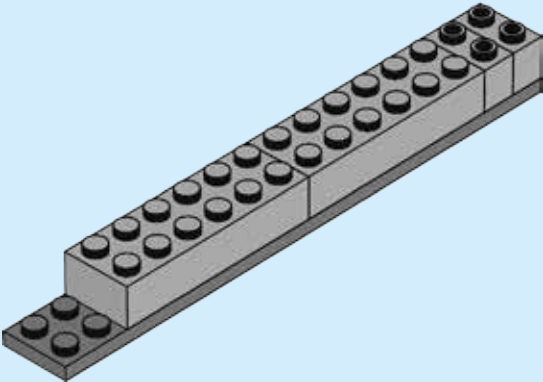



2x

39

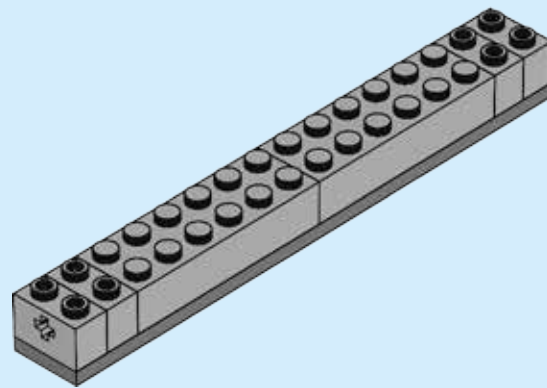

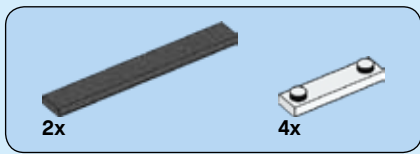

40

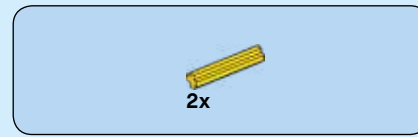
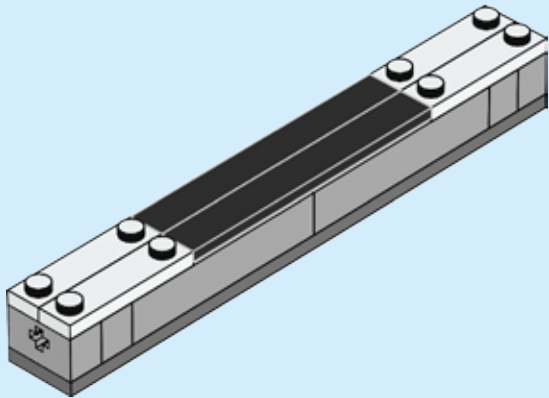

41

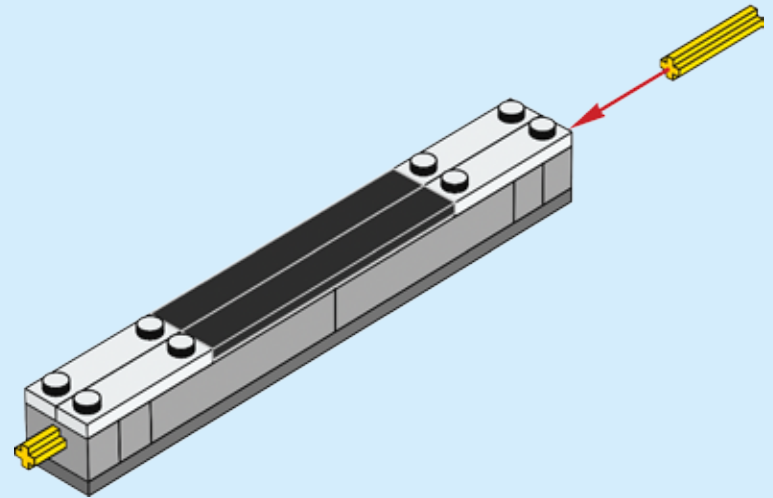

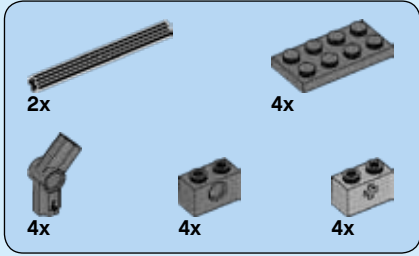
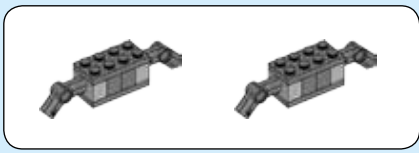

# 42

1



2

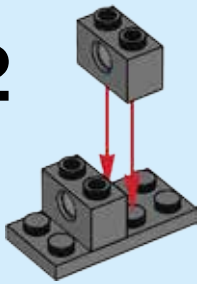

3

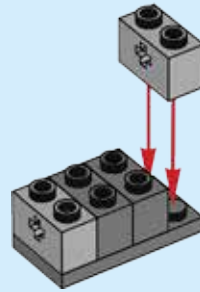

4

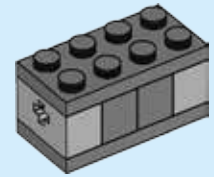

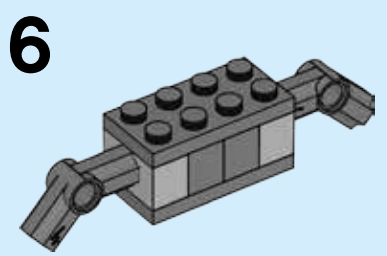
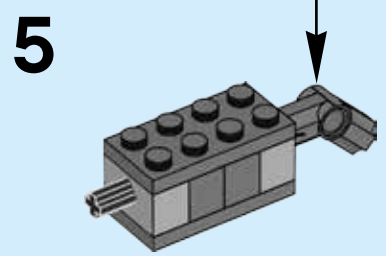
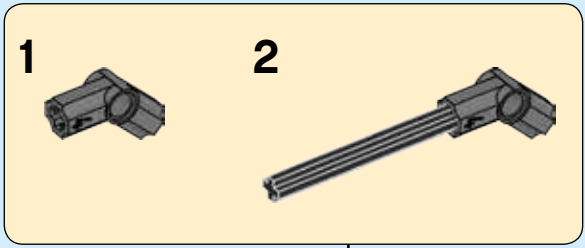

2x

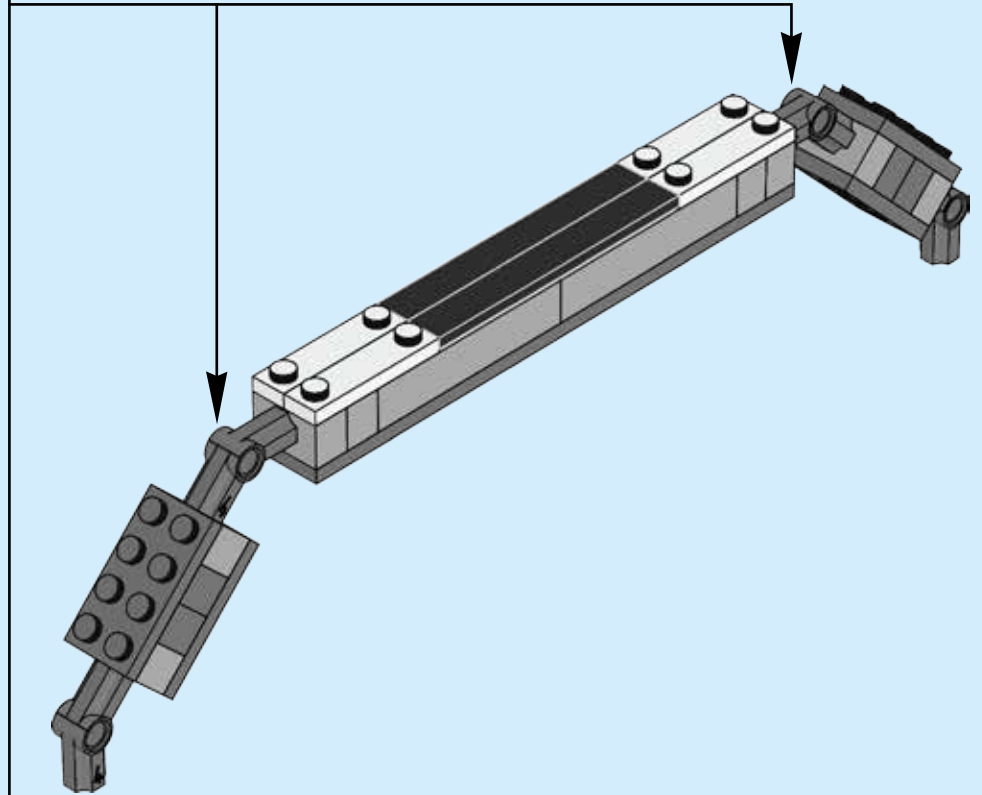



43

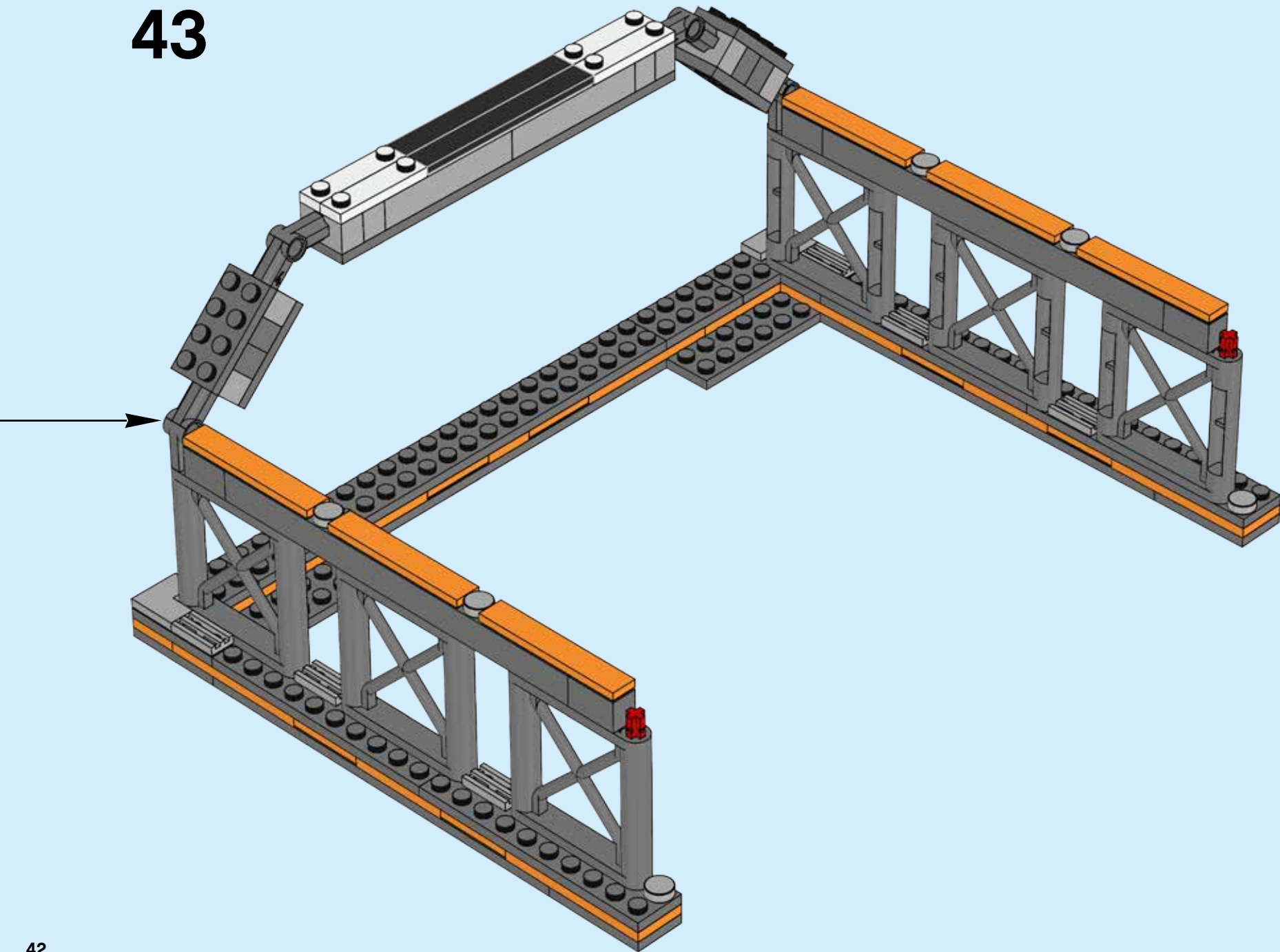

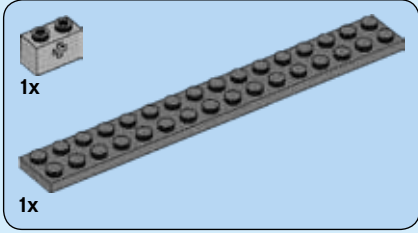
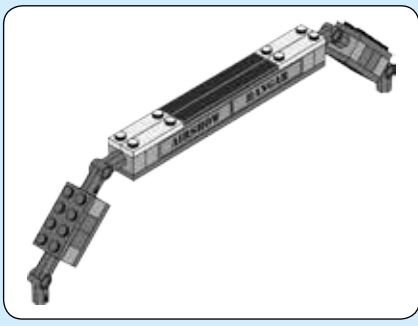

1x

1x

44

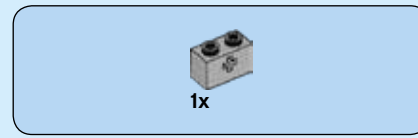
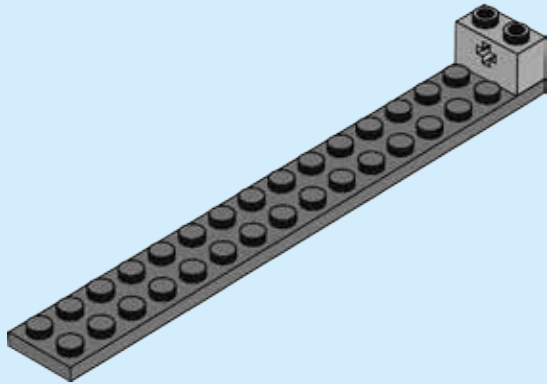

1x

45

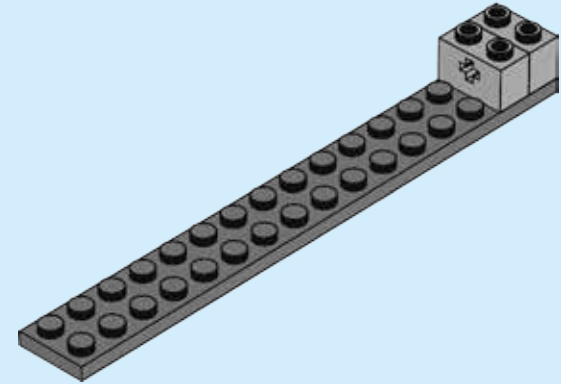

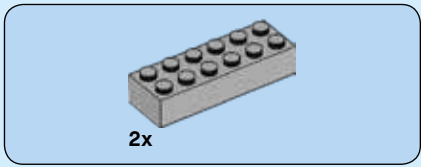

46

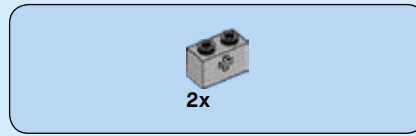
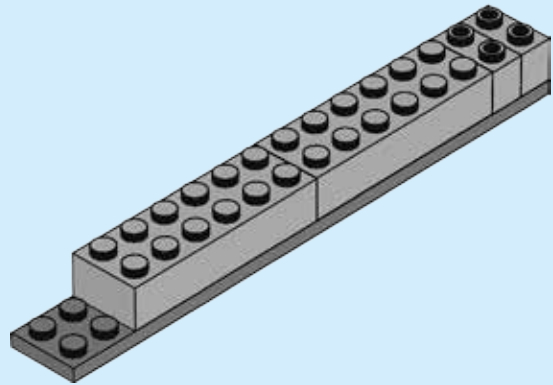

47

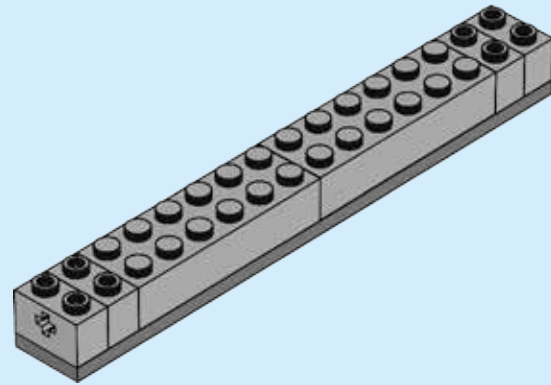

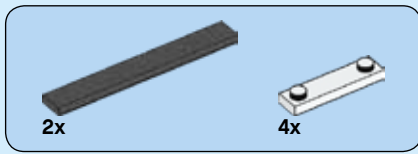

48

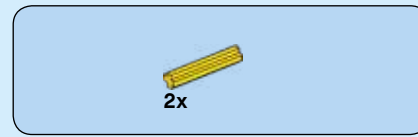
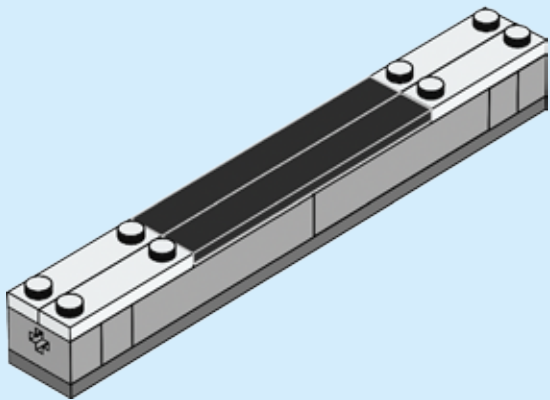

49

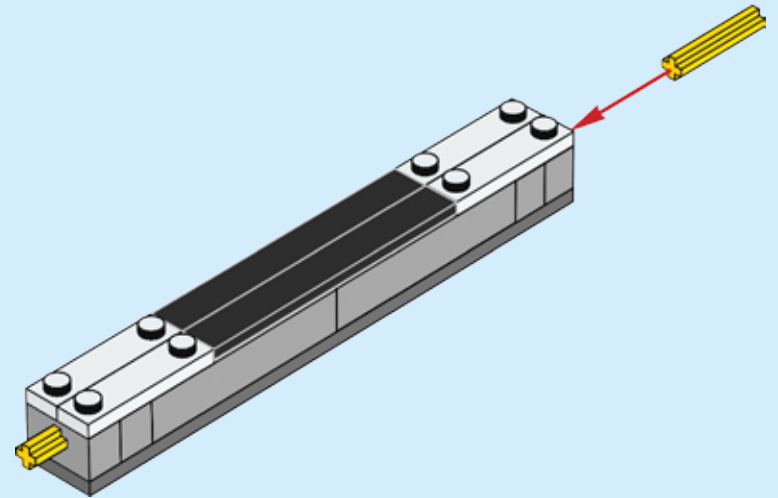

50

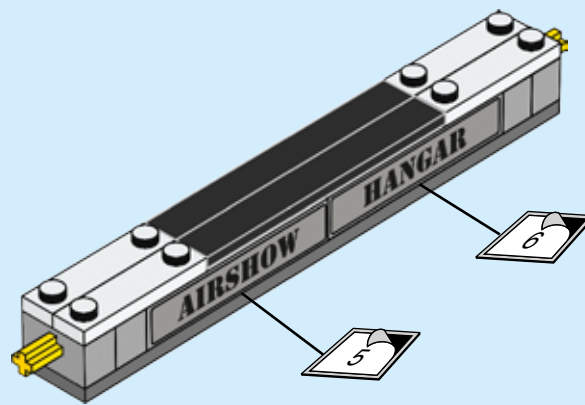

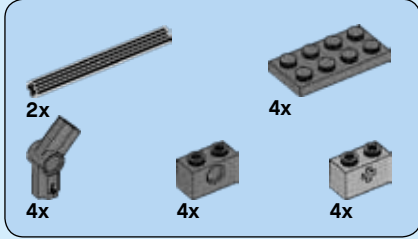
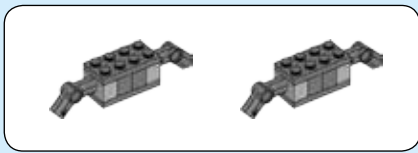

# 51

1



2

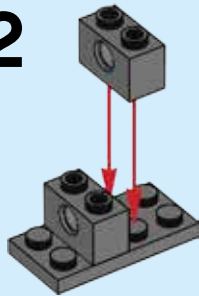

3

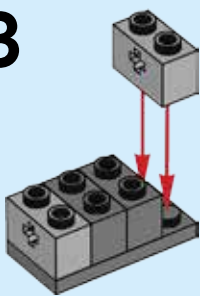

4

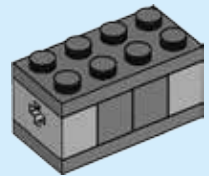

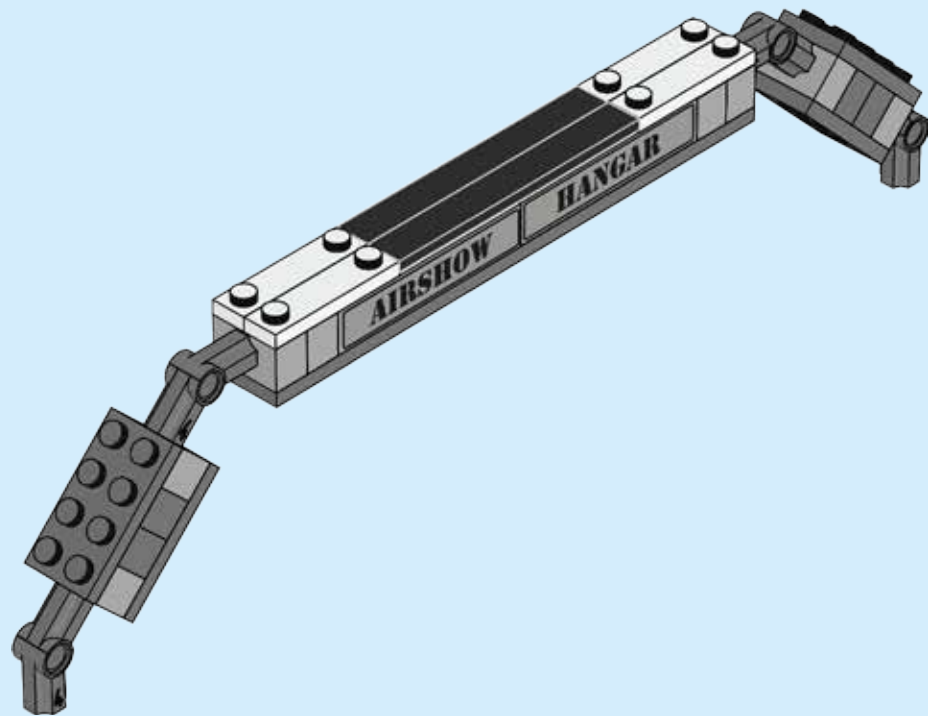
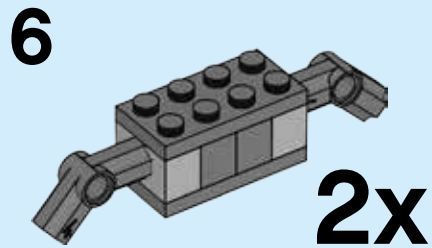
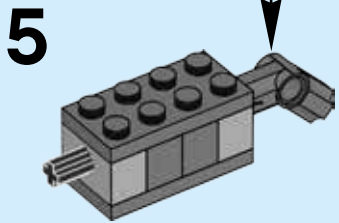
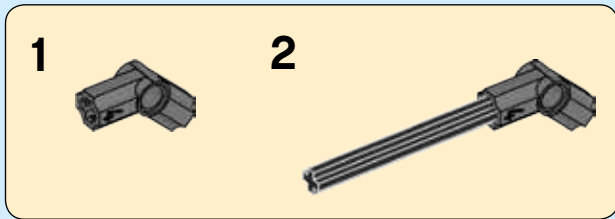

52

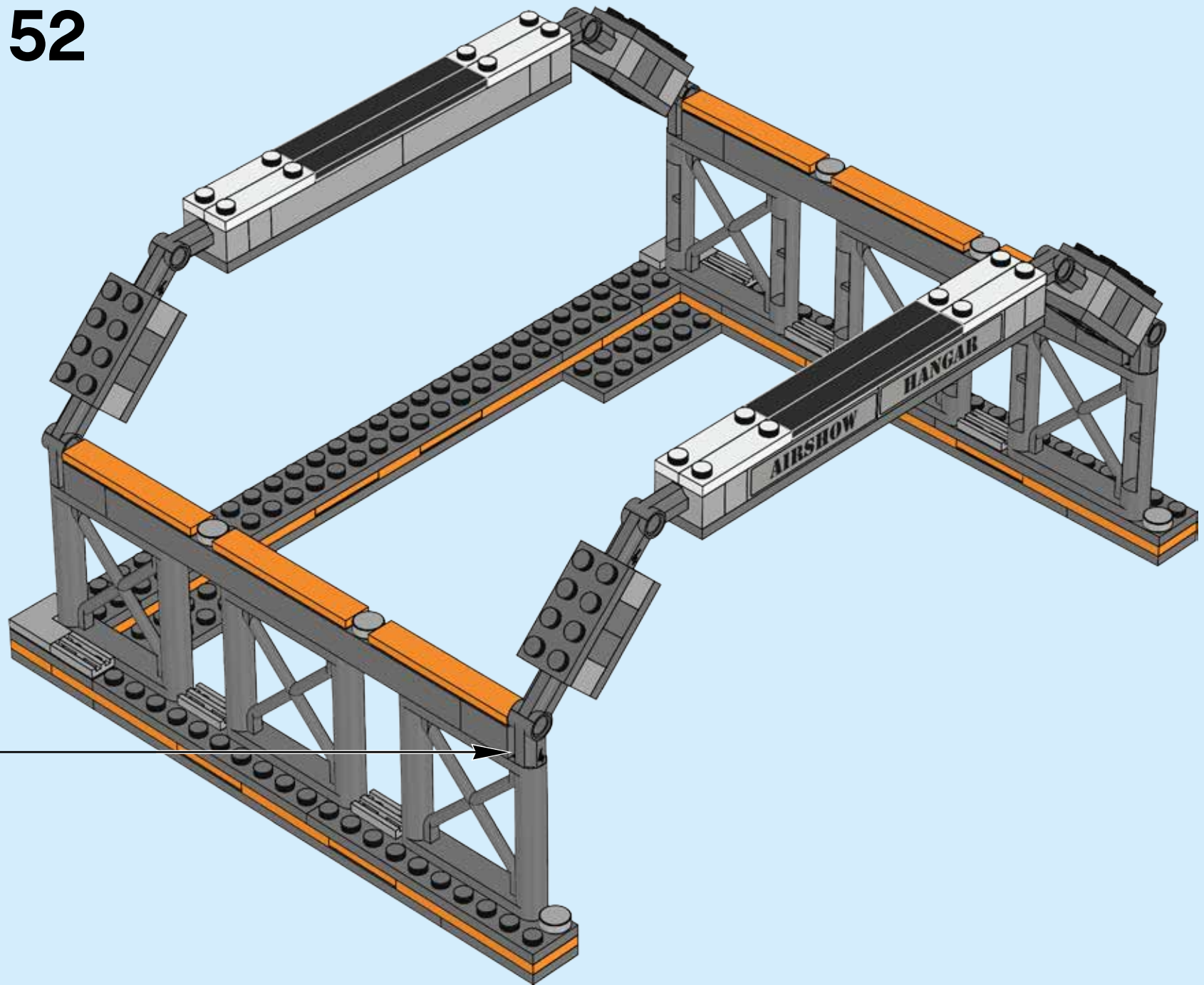



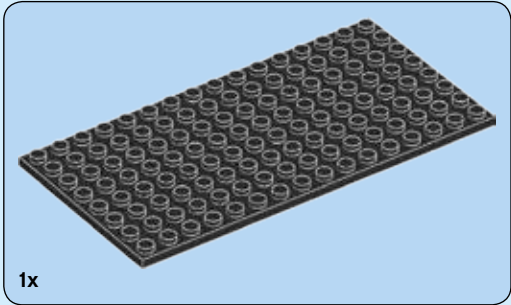
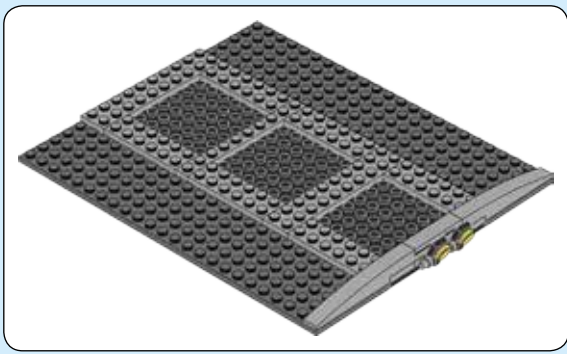

**53**

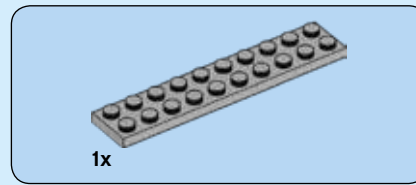
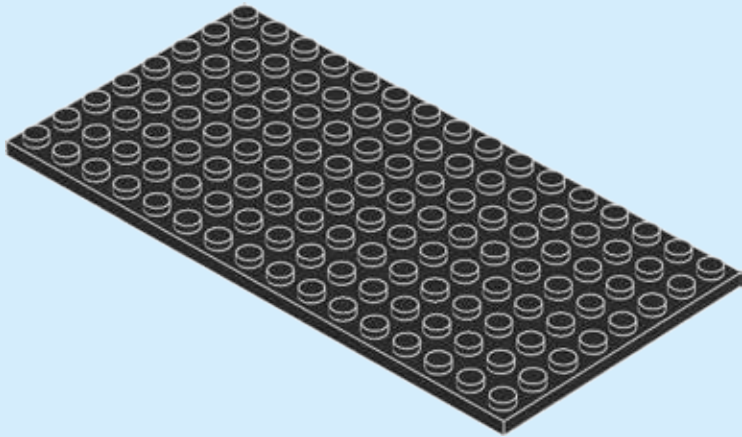

**54**

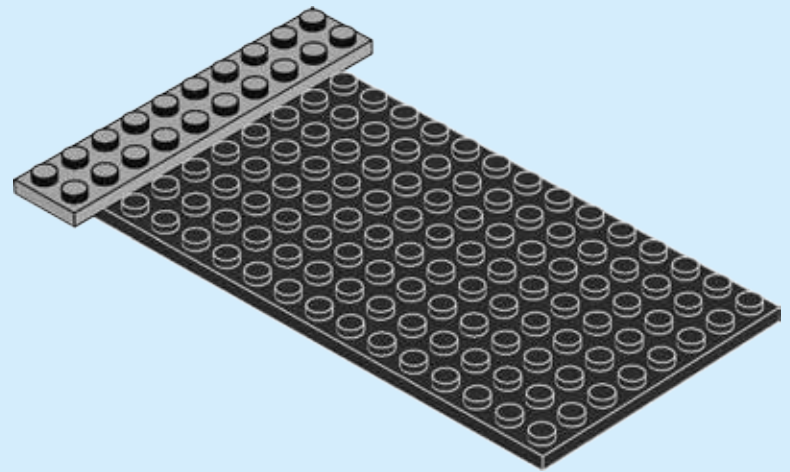

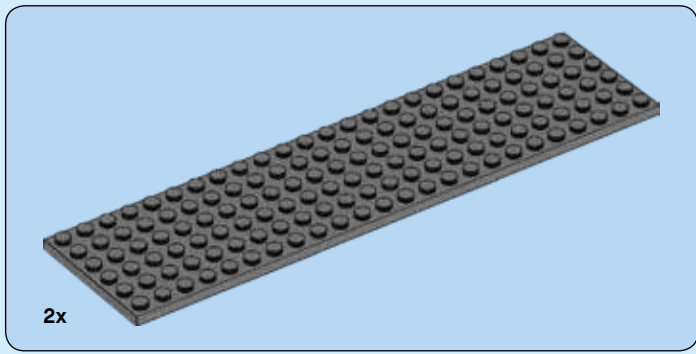

55

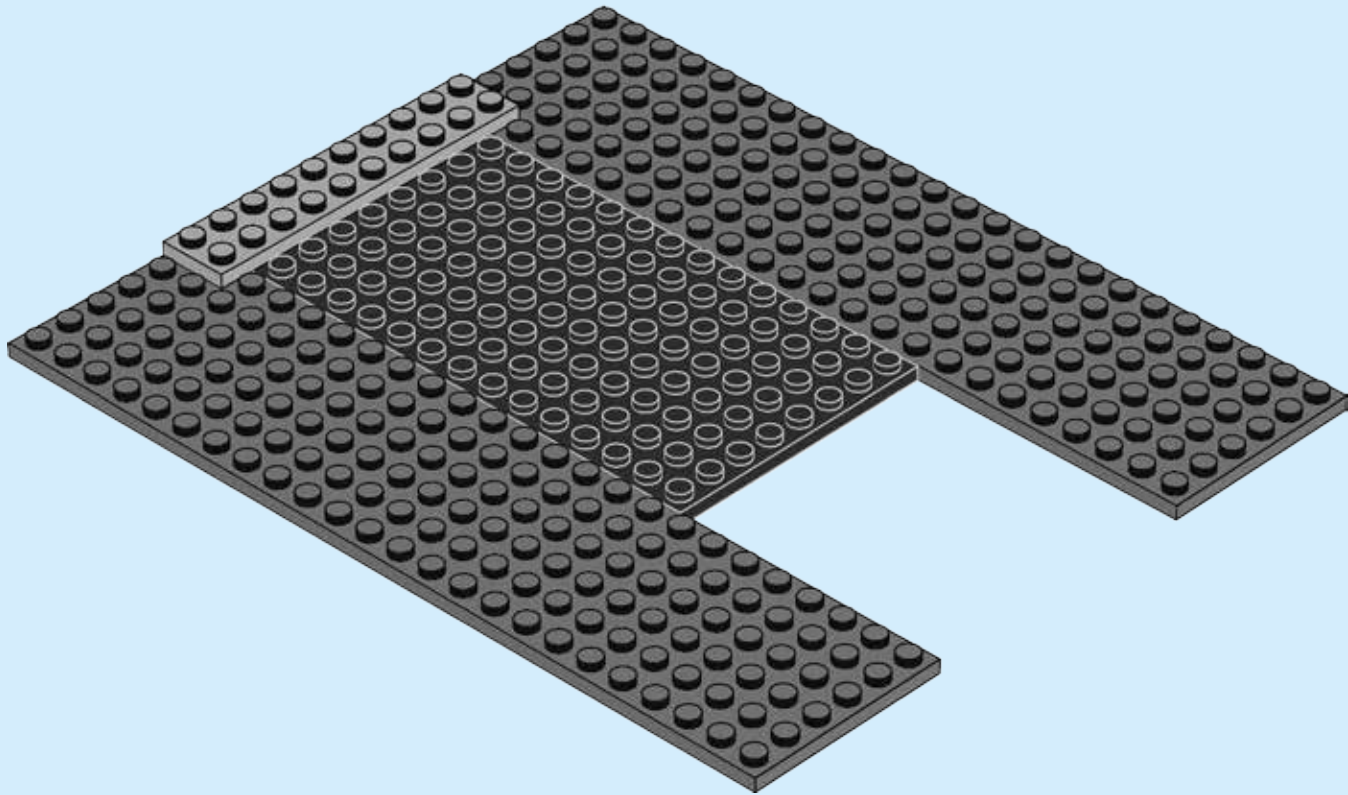

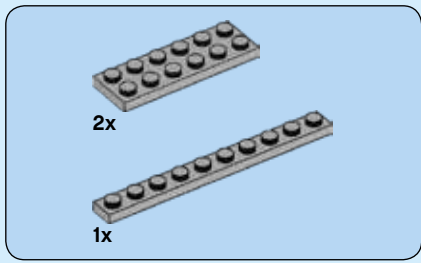

**56**

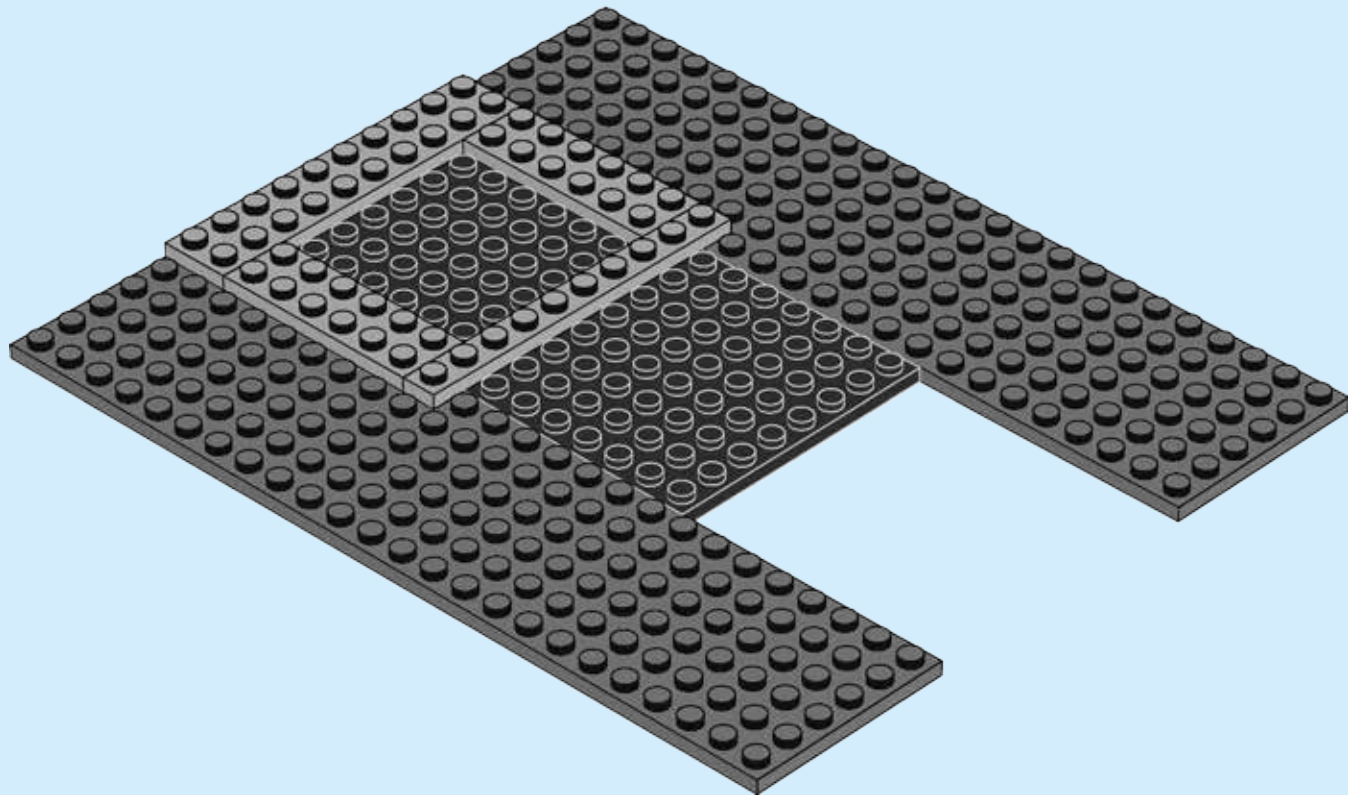

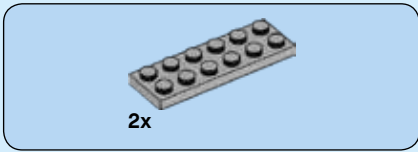

57

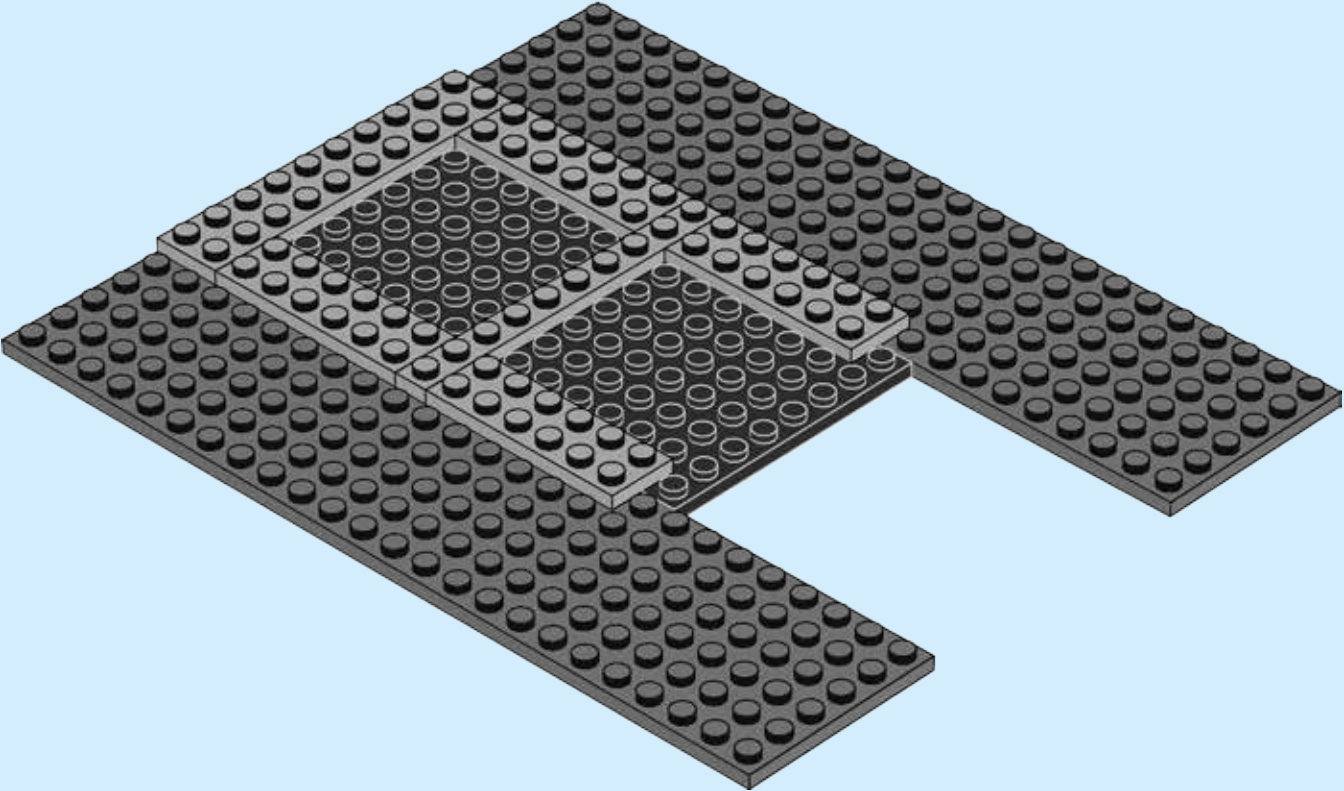

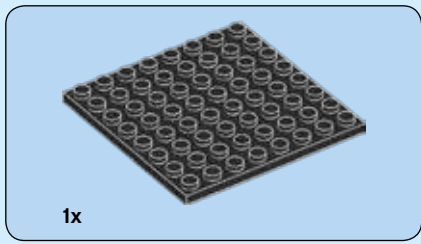

58

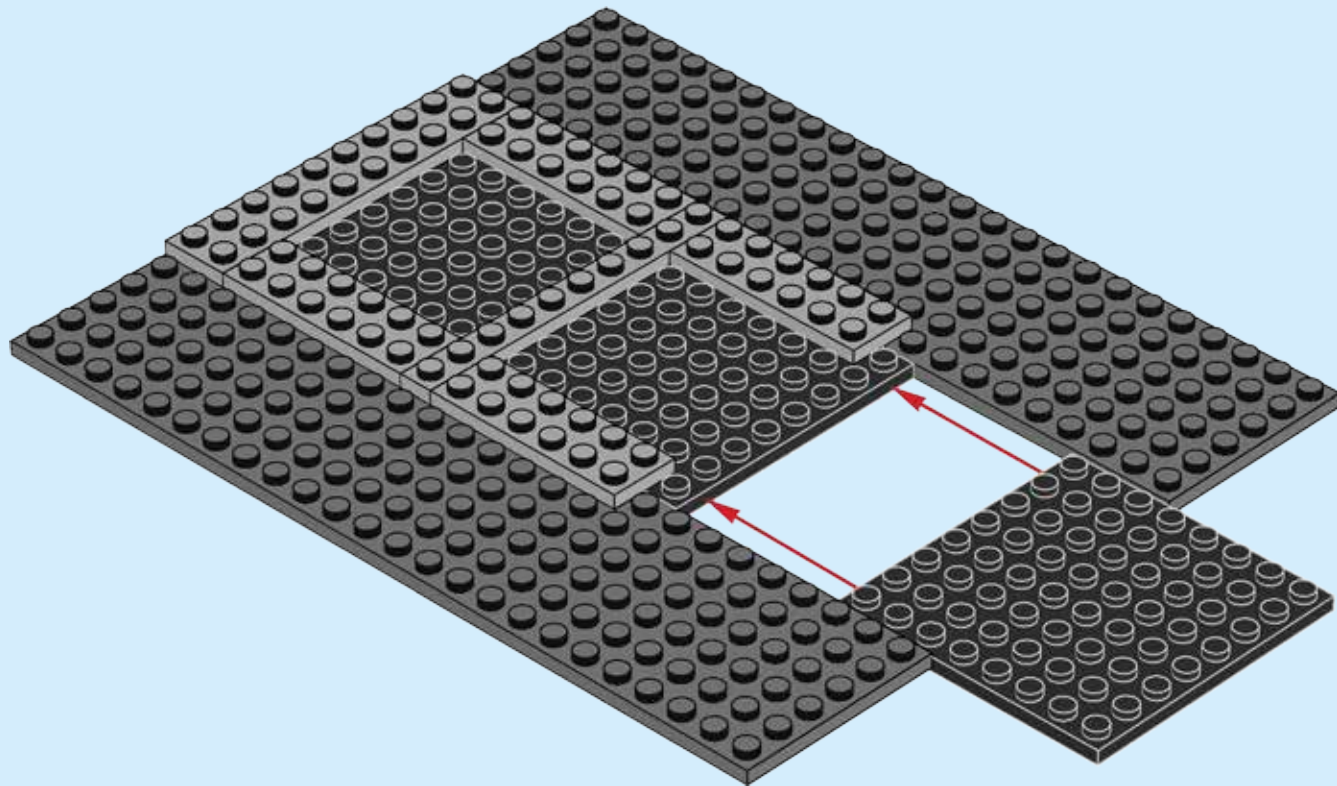



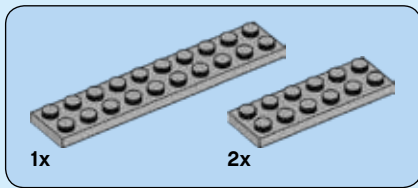

59

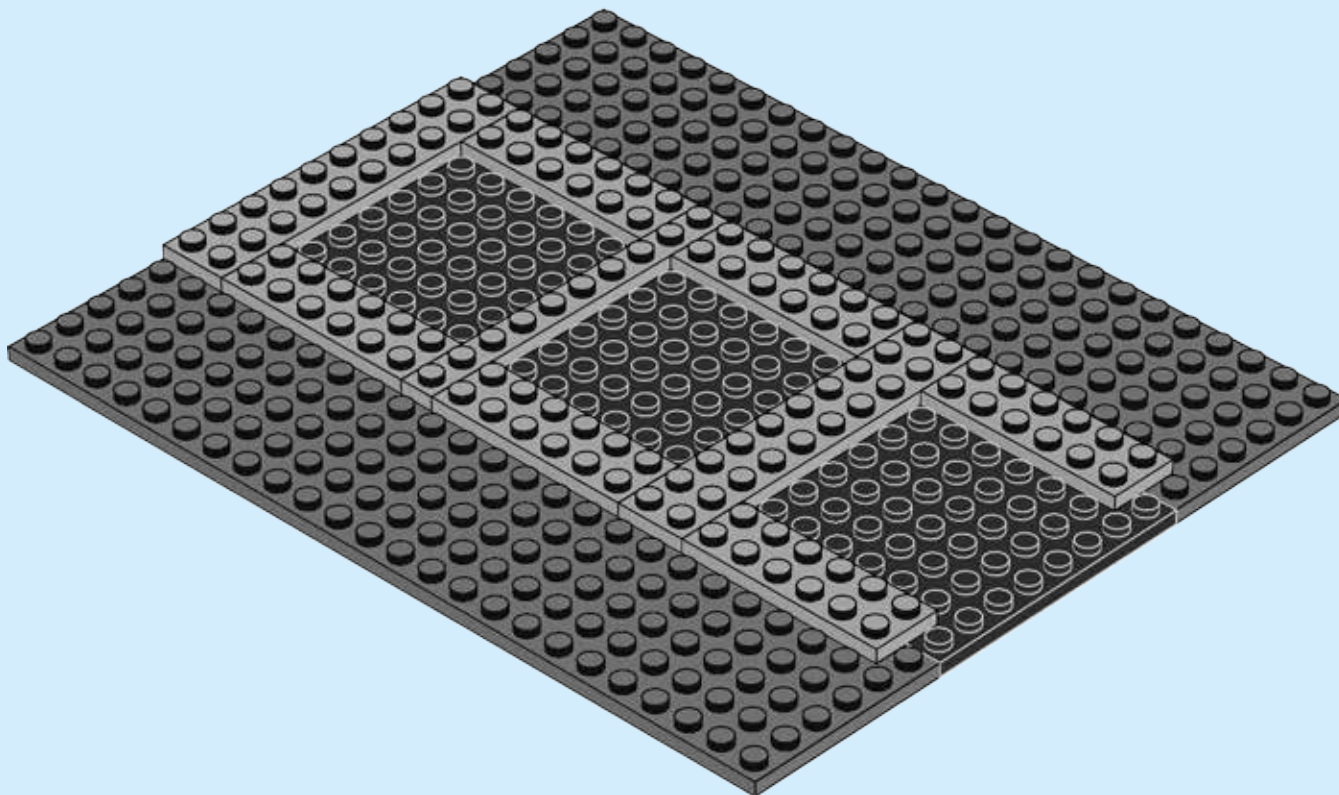

2x

2x

# 60

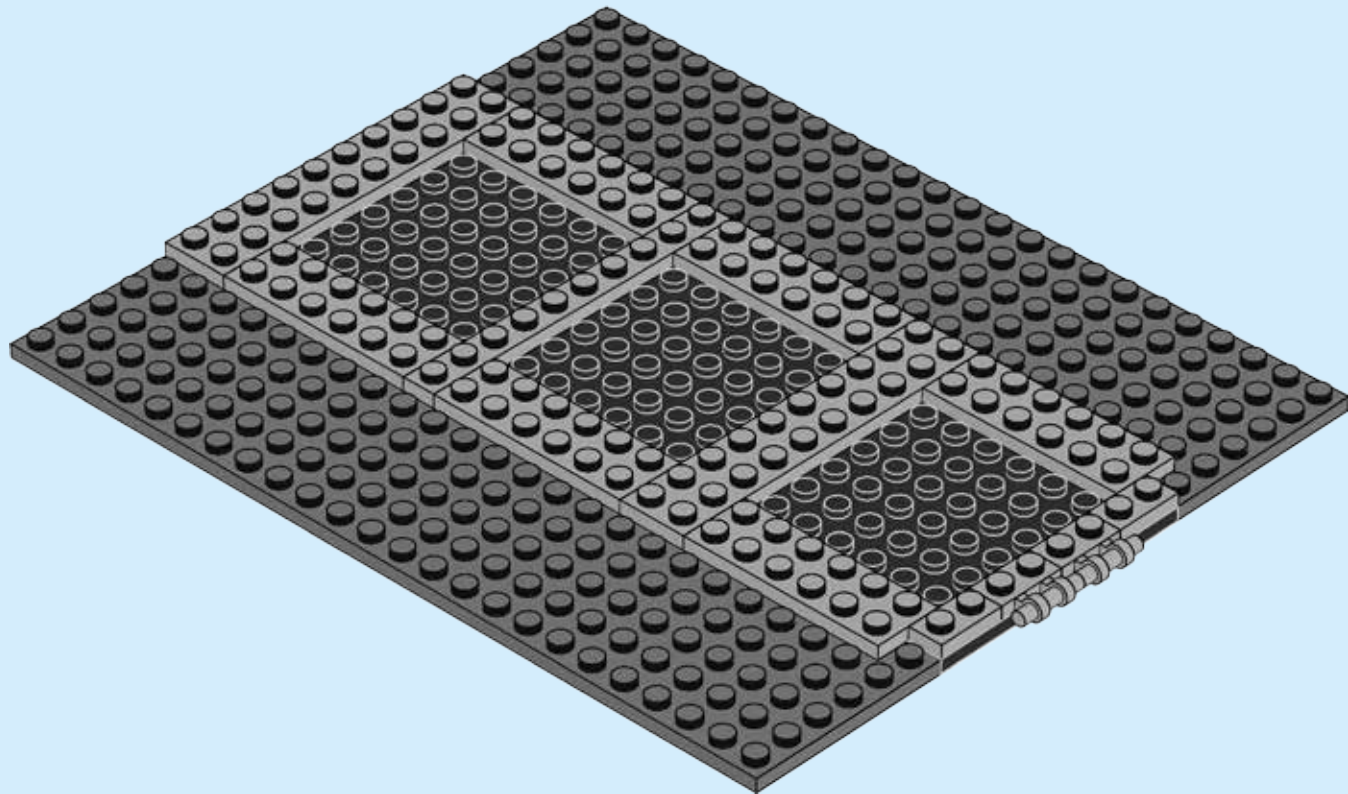

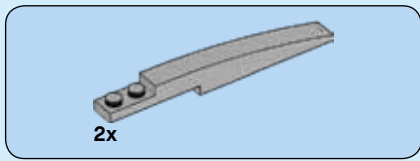

61

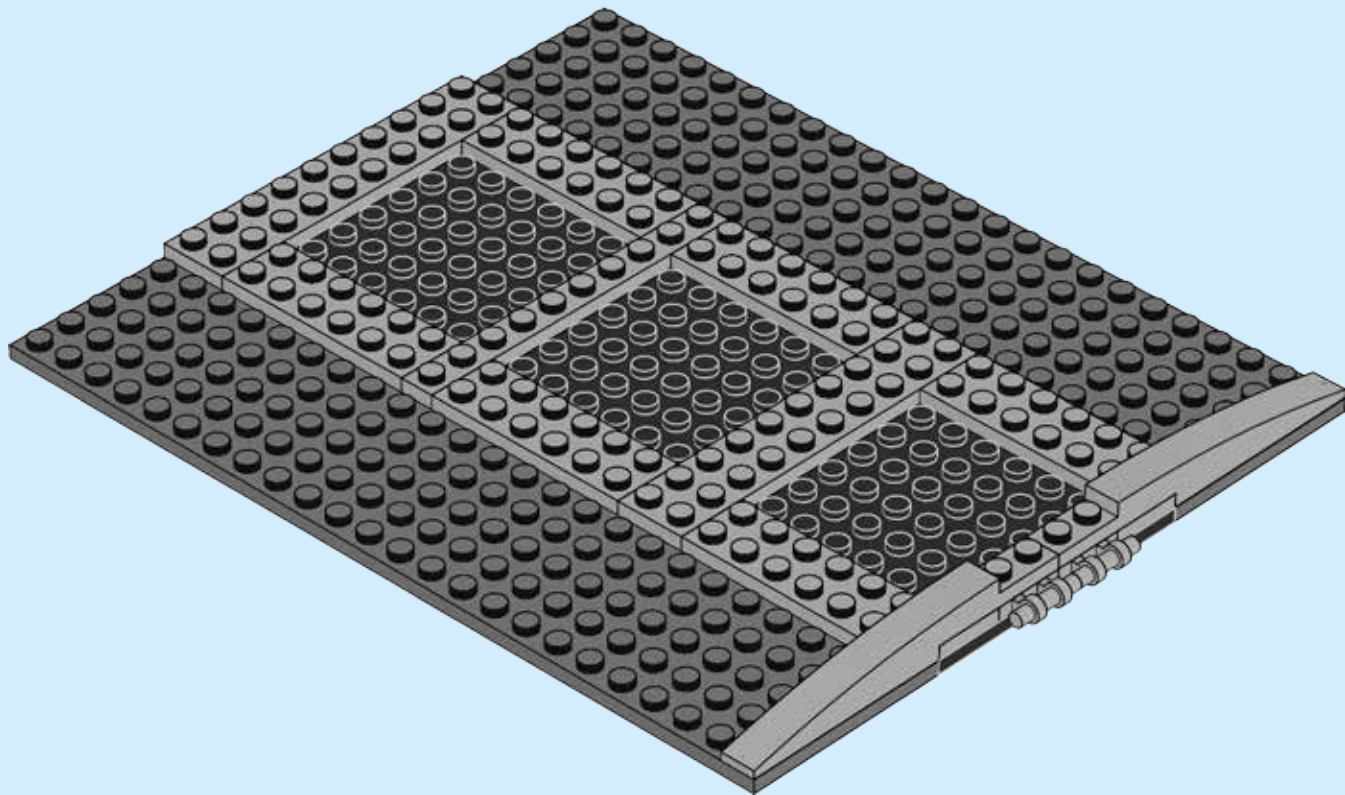



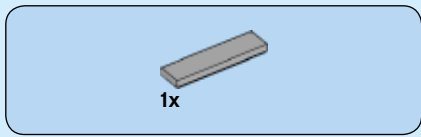

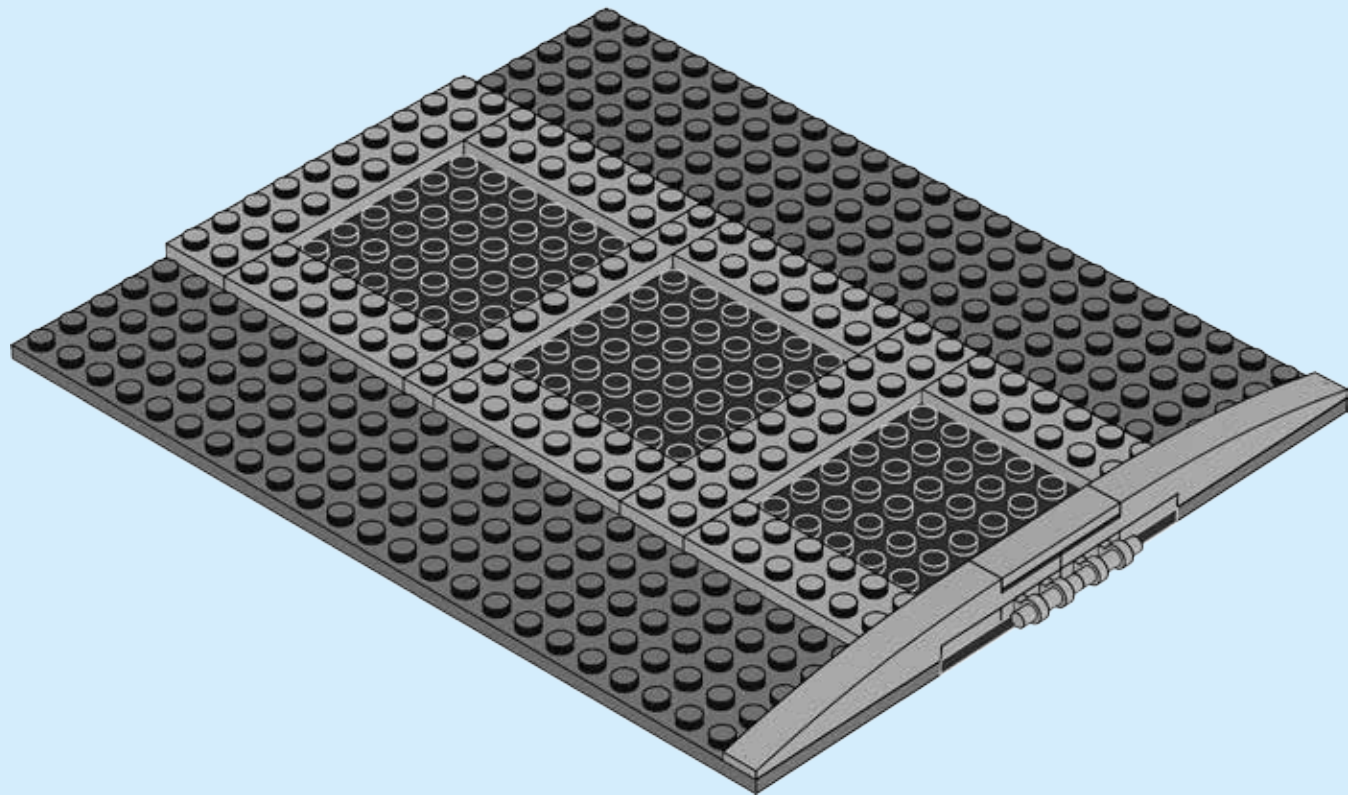

62

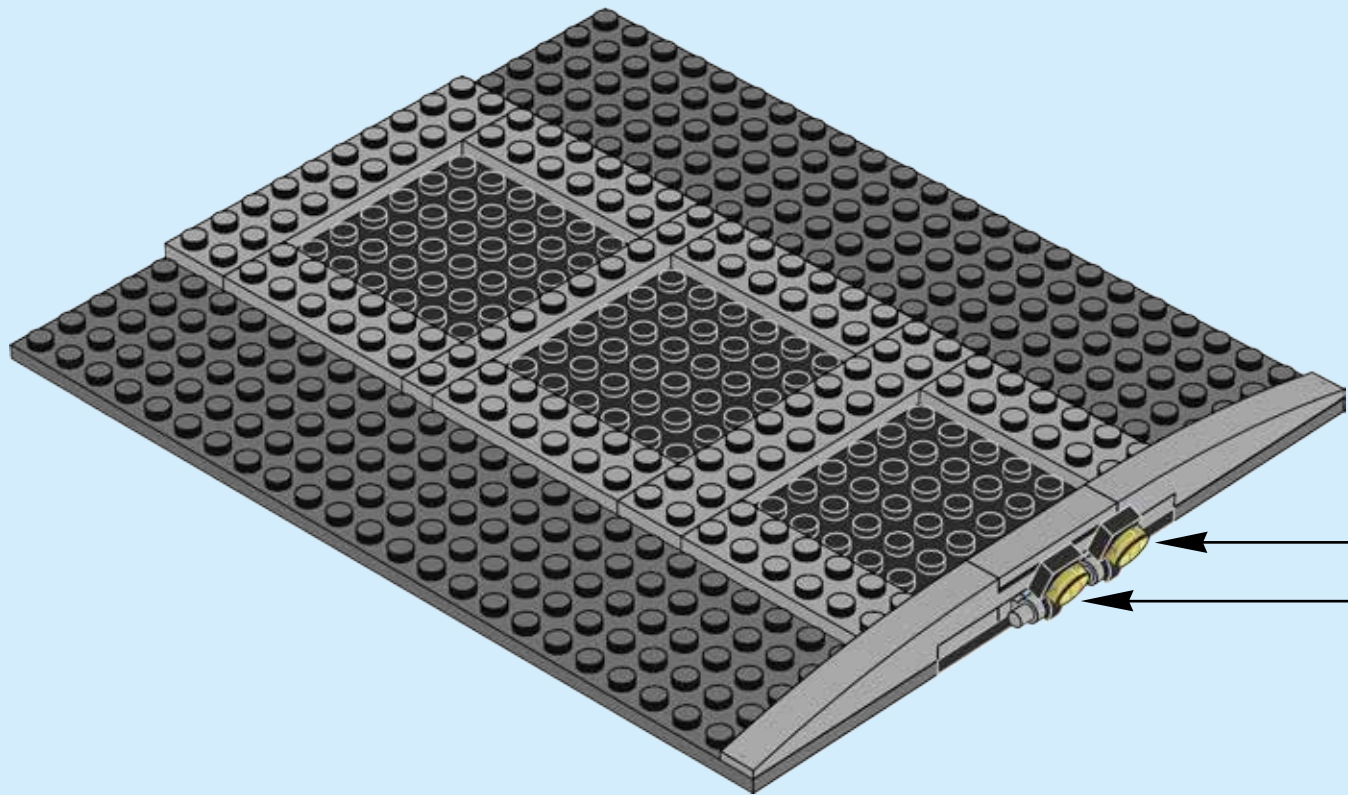

2x  2x 

# 63



  
 2x

64

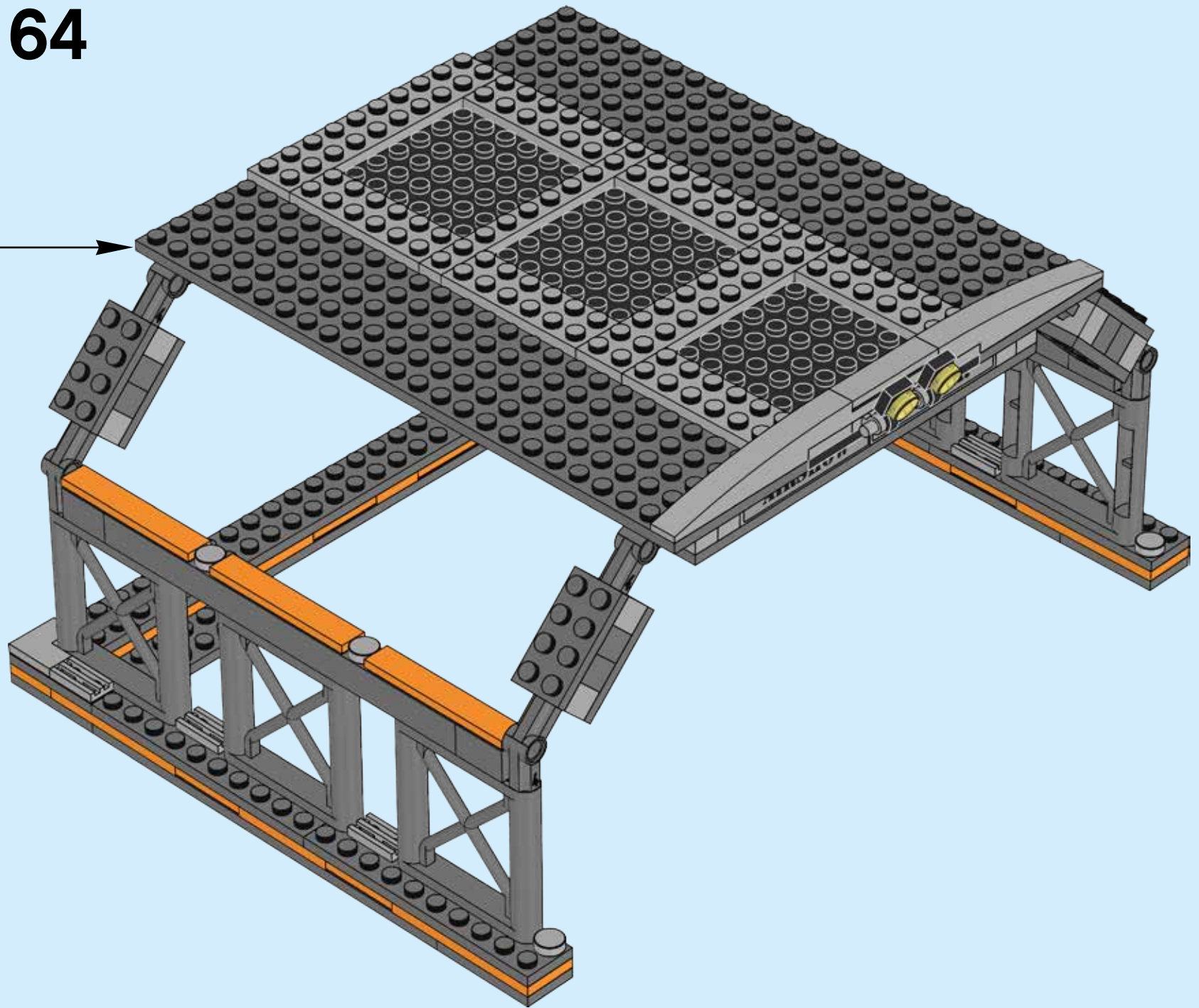



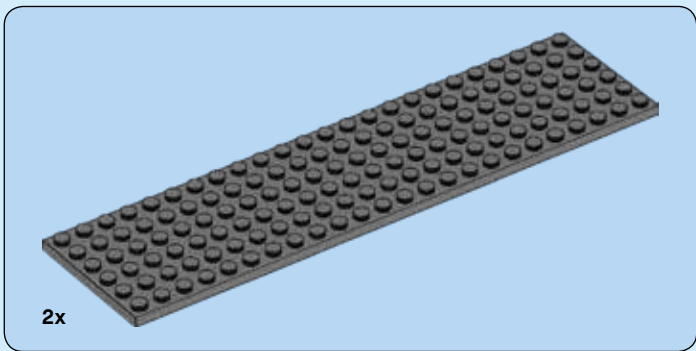

65

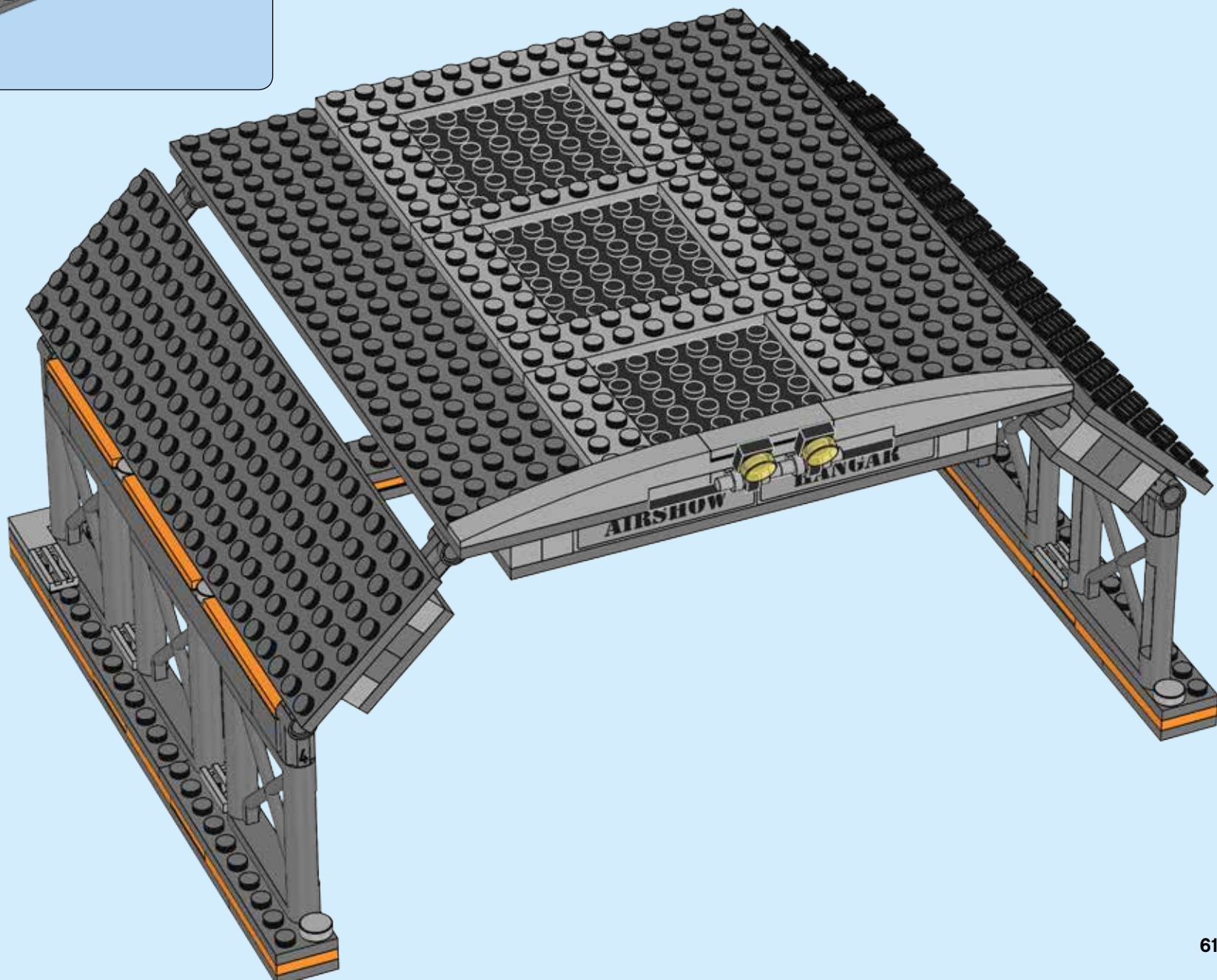

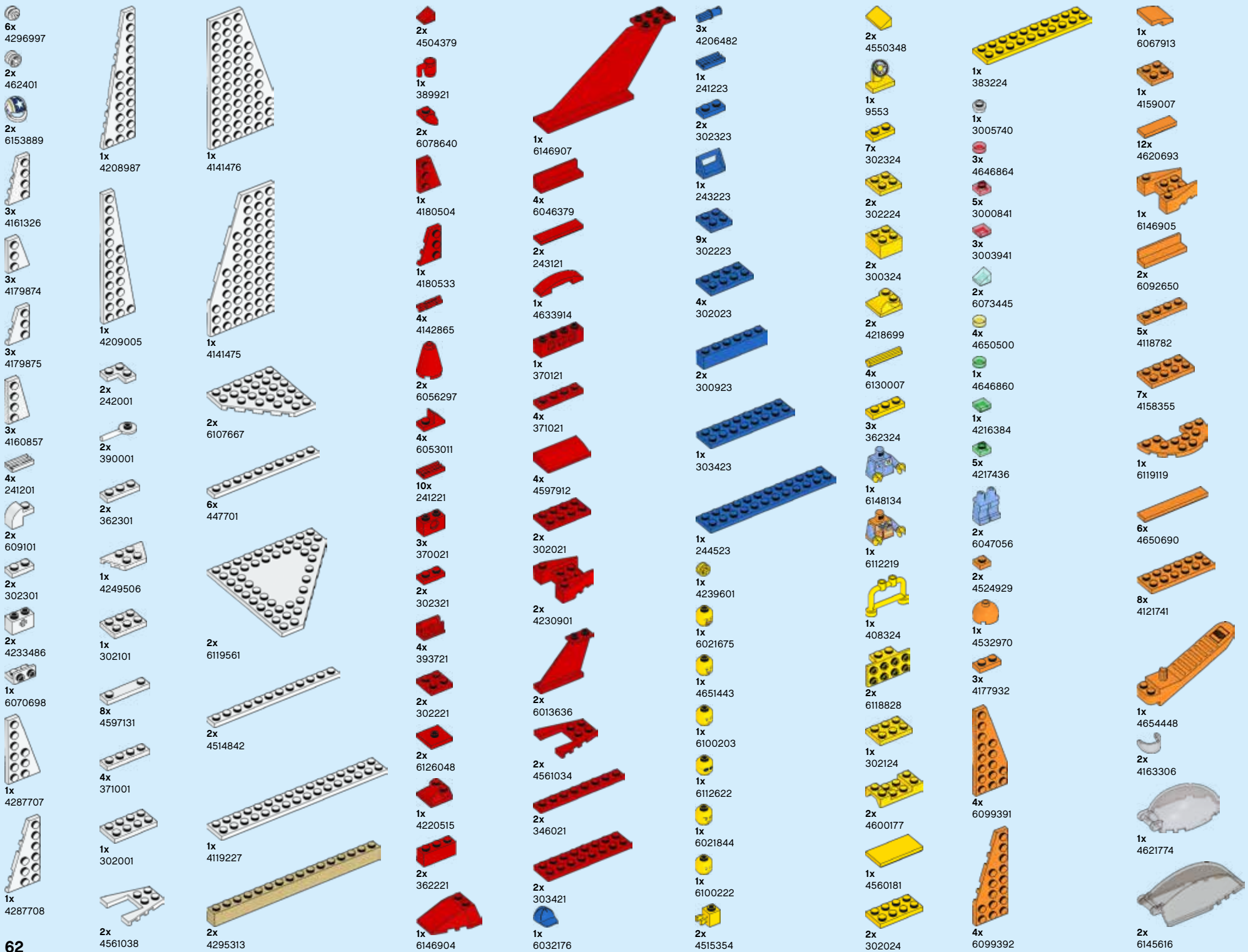



**Customer Service**  
 Kundenservice  
 Service Consommateurs  
 Servicio Al Consumidor  
[LEGO.com/service](http://LEGO.com/service) or dial  

**: 00800 5346 5555**  
**: 1-800-422-5346**





# CITY



60141



60140



60139



60138



60137



60136



60135

 [LEGO.com/city](https://www.LEGO.com/city)