



ADVENTURE TIME

21308



- 🇬🇧 Booklet available in English on
- 🇩🇪 Heft in deutscher Sprache erhältlich auf
- 🇫🇷 Livret disponible en français sur
- 🇪🇸 Folleto disponible en español en
- 🇵🇹 Folheto disponível em português em
- 🇮🇪 A füzet magyarul ezen a honlapon olvasható
- 🇮🇹 Libretto disponibile in italiano su
- 🇨🇳 如需中文版手册，请访问 www.LEGO.com/ideas

 LEGO.com/ideas

It's Adventure Time™!

Finn and his best friend and adopted brother, Jake, roam the Land of Ooo, righting wrongs and battling evil. Along the way, they make friends with a whole range of wacky characters such as Princess Bubblegum, Lady Rainicorn and Marceline the Vampire Queen. They also have to deal with the grumpy Ice King, the mean ruler of the Ice Kingdom, who really needs to chill out.

The animated television series created by Pendleton Ward has achieved both cult status and widespread popularity, and is now also the 16th set in the LEGO® Ideas series.

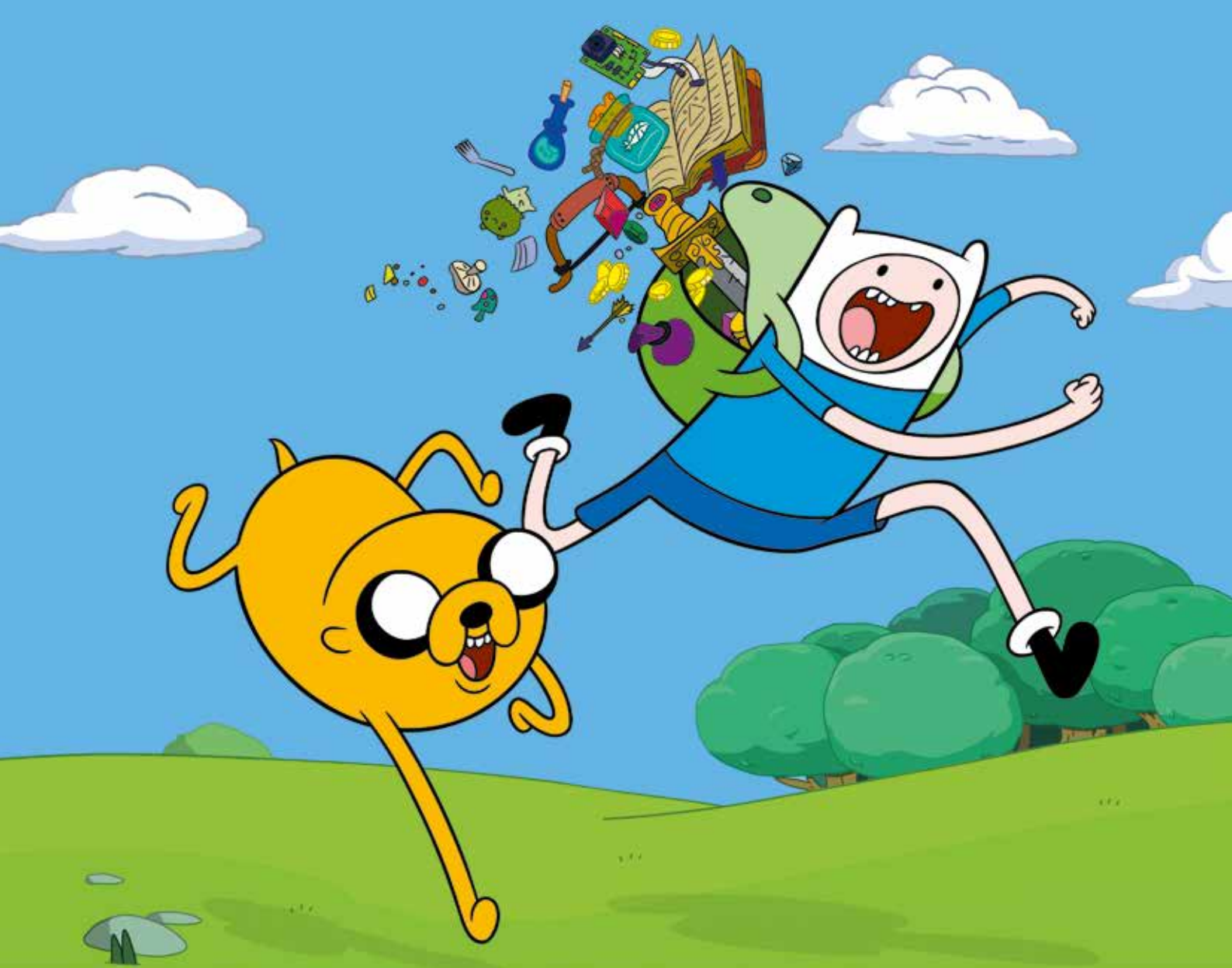



Finn

Finn is a silly kid who wants to become a great hero one day. He might not look too tough, but if there's evil around, he'll slay it. That's his deal.



Jake

Finn's best friend is a wise old dog with a big heart. Jake has the magical ability to stretch and grow. When evil's not running amok, he plays viola with his girlfriend, Lady Rainicorn.

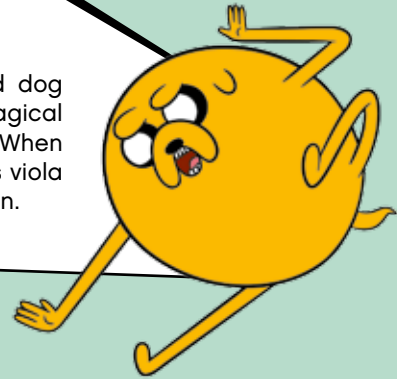



BMO

BMO is much more than just Finn and Jake's roommate. Beemo is also their friend, camera, alarm clock and video game system.

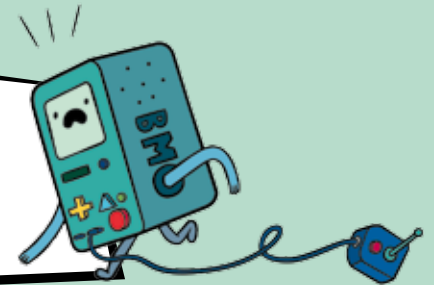

Marceline

Marceline is a wild rocker girl. Centuries of wandering the Land of Ooo have made her a Fearless daredevil.





Lady Rainicorn

Lady Rainicorn is Princess Bubblegum's loyal and majestic pet. Her love of the viola makes her a perfect match for Jake.



Princess Bubblegum

As a millionaire geek enthusiast, Princess Bubblegum immerses herself in every branch of geekdom from rocket science to turtle farming.





Ice King

Armed with a magic crown and an icy heart, the Ice King has only one goal: to secure a wife by any means necessary.



Gunter

Gunter is the name the Ice King gives to all of his penguin servants, yet he pronounces it differently depending on the penguin's personality.



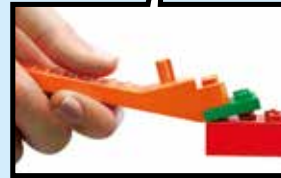

LEGO.com/brickseparator

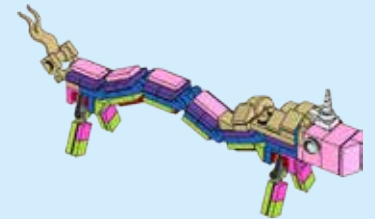
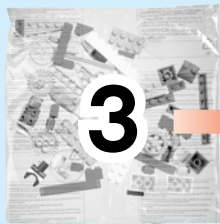
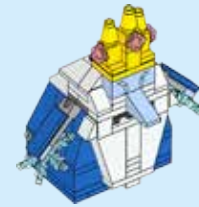
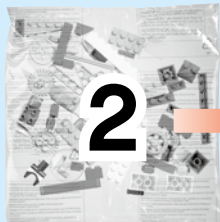
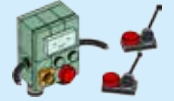

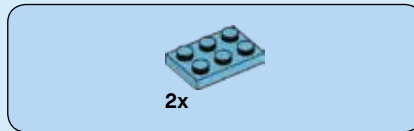
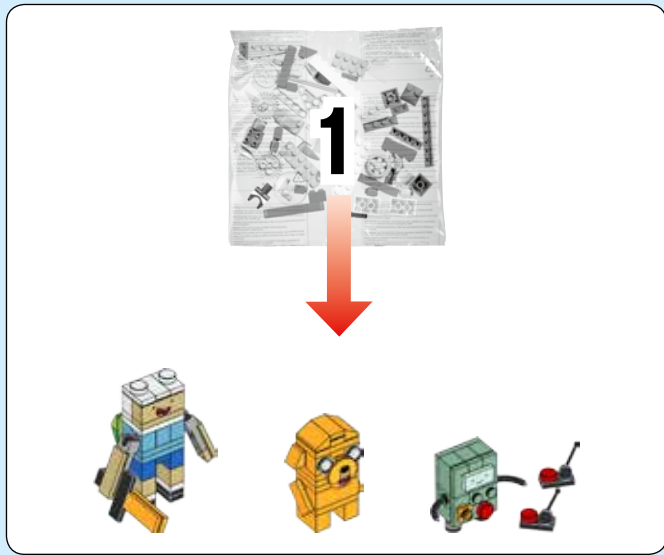

1

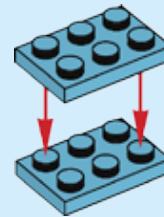



2

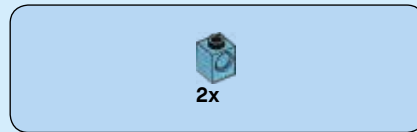
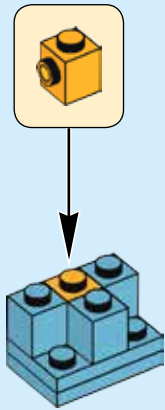

3

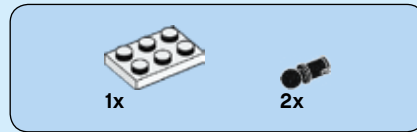
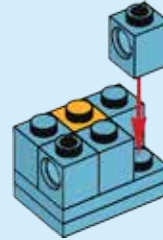

4

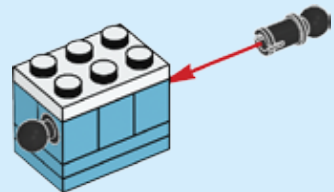

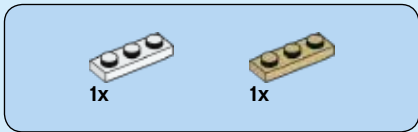

5

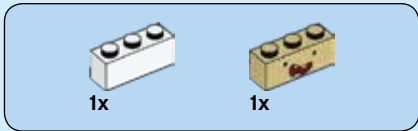
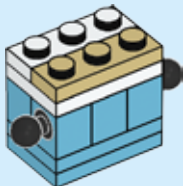

6

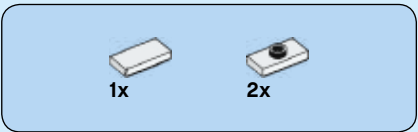
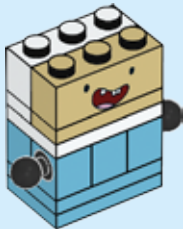

7

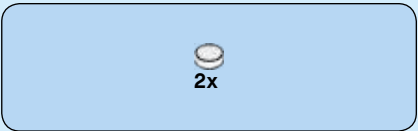
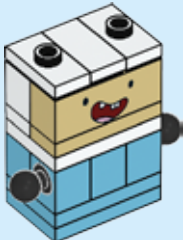

8

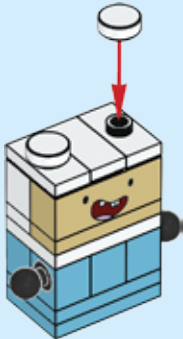



9

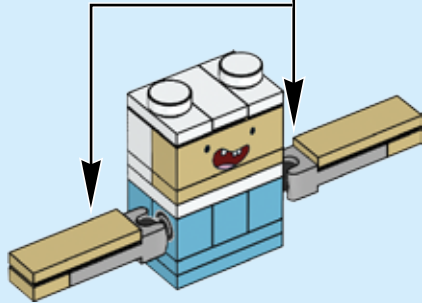
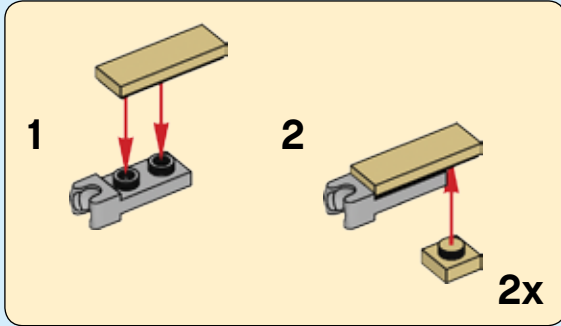

10

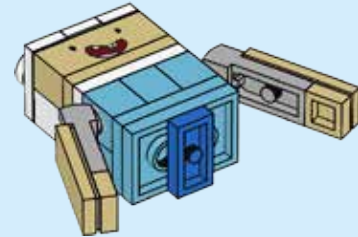
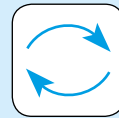

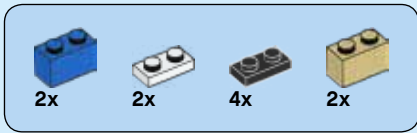

11

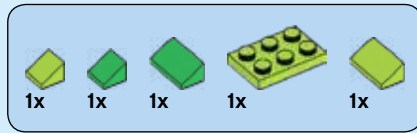
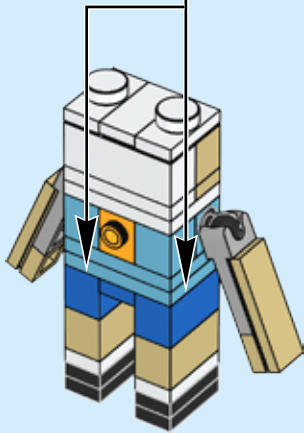
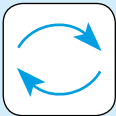
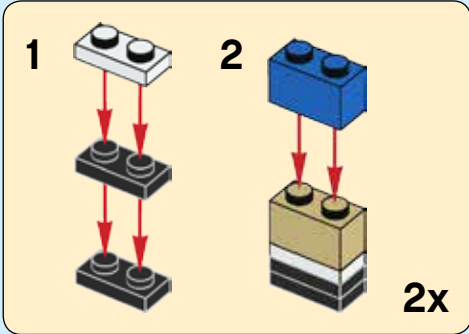

12

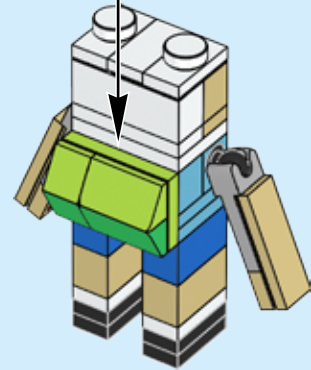
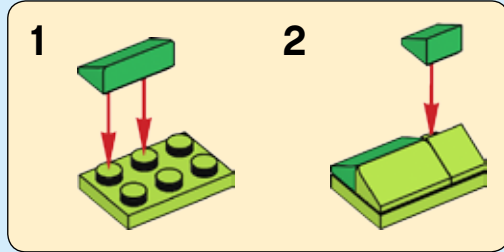

*"You're beautiful on the inside,
like, your brain and stuff"*

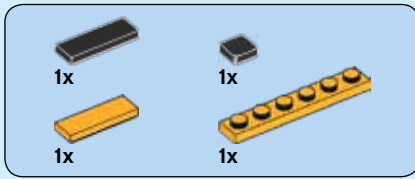
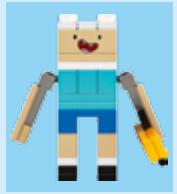

13

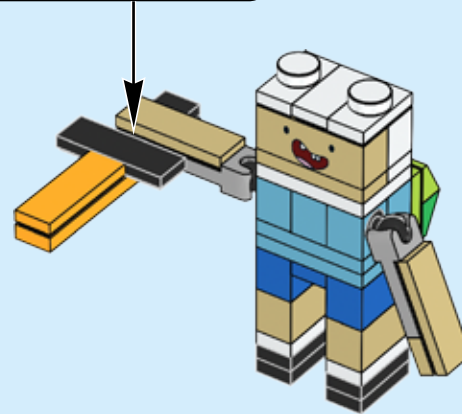
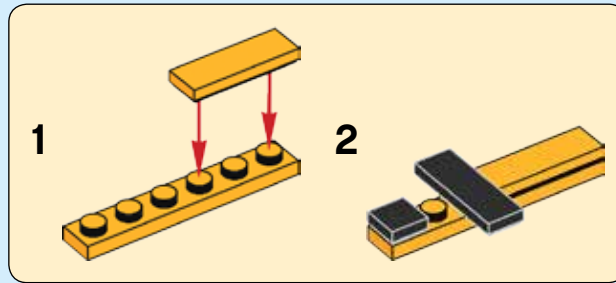
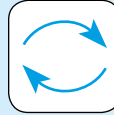



14



15

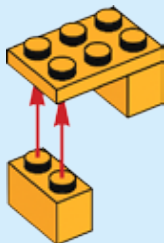

16

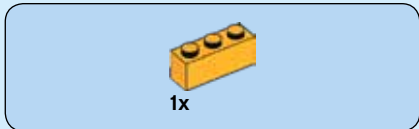
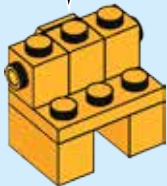
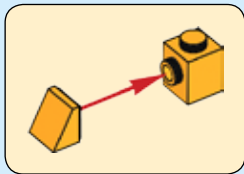

17





18

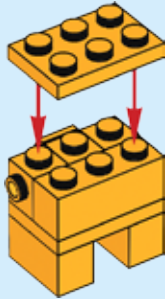

19

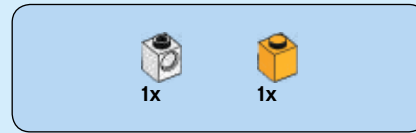
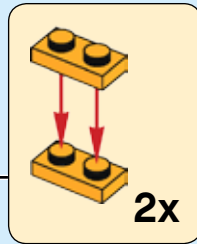
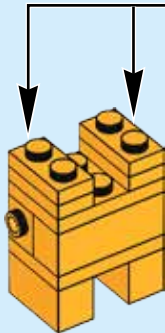

20

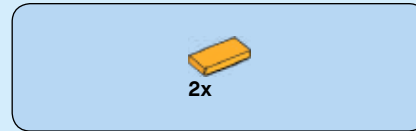

21

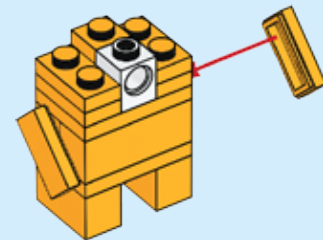



2x

22

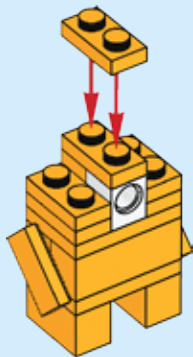

4x

23

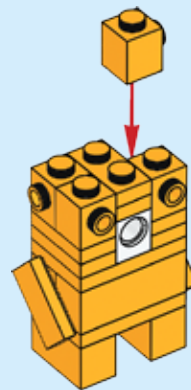



24

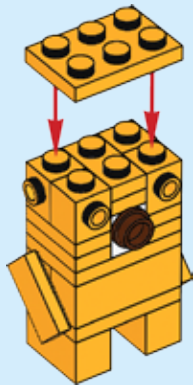

25

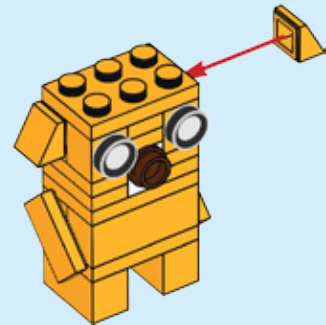



26

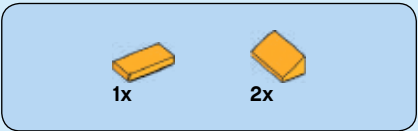

27

*"Just do whatever you want, man.
As long as it comes from the inside"*

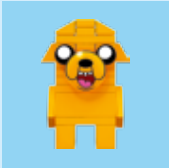

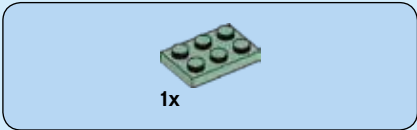
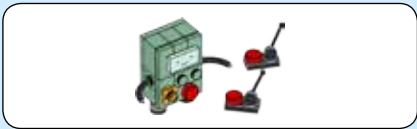

1x

28

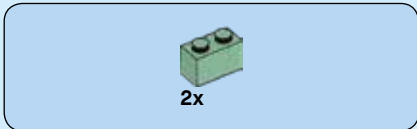

2x

29

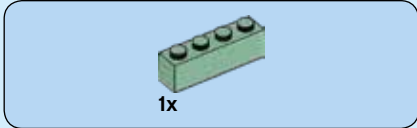
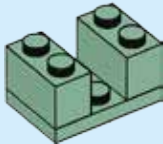

1x

30

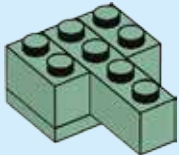



1x

31

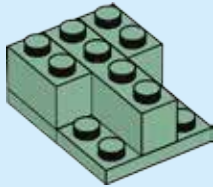

4x

32

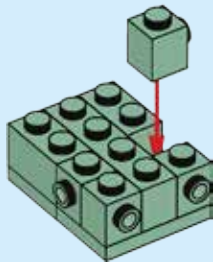

2x



1x



3x

33

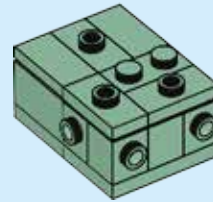

2x



1x



1x



1x

34

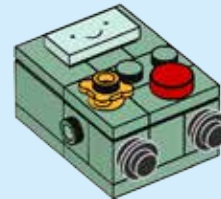



35

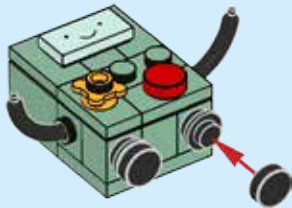

"Let's play video games!"

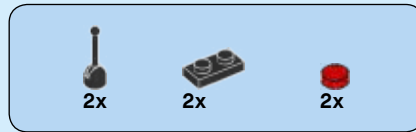
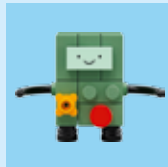

36

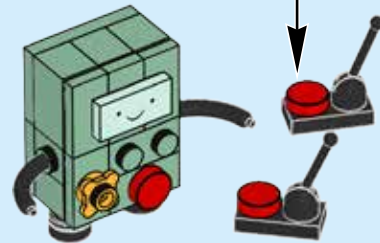
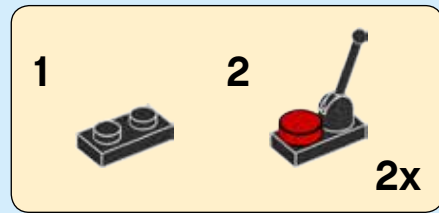
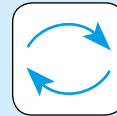

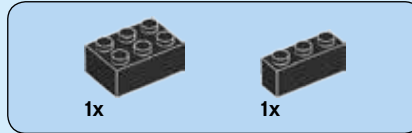
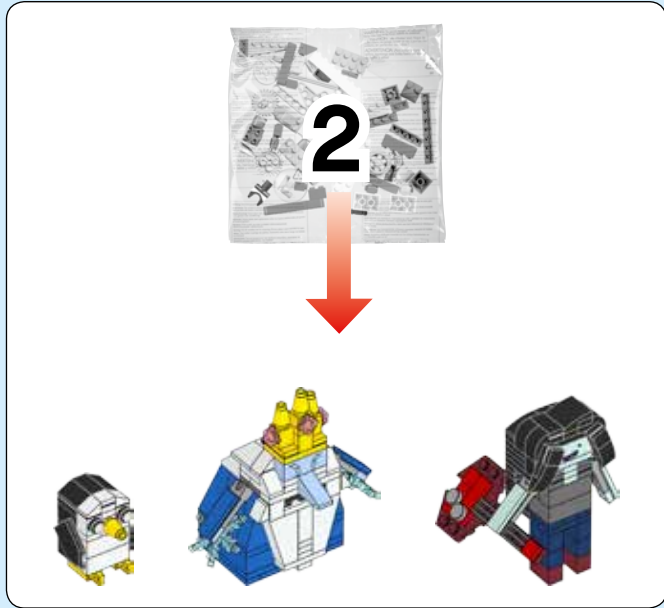

37

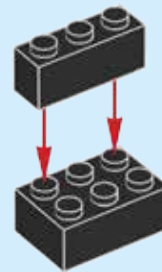

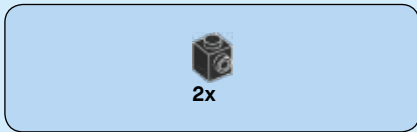

38

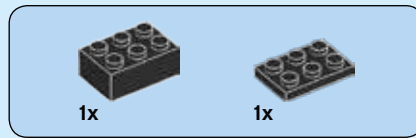
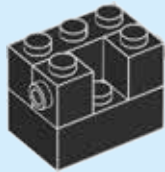

39

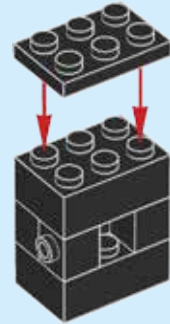

40

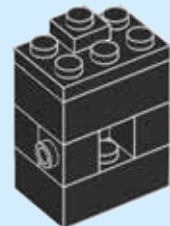

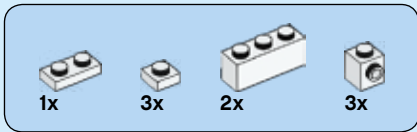

41

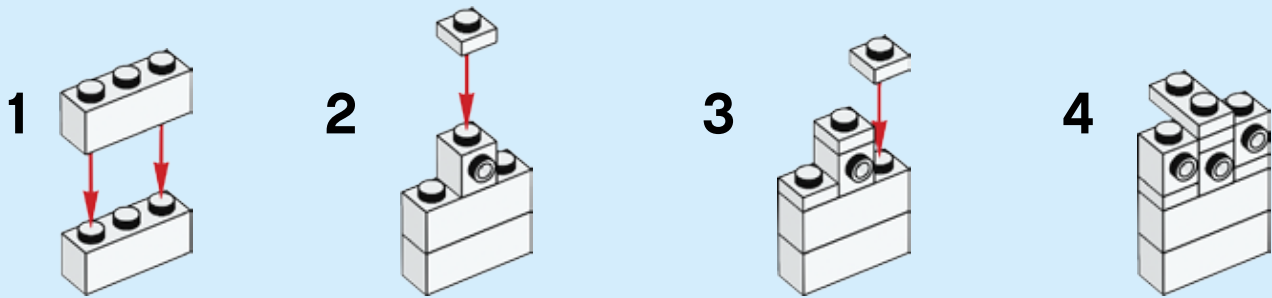

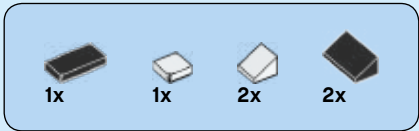

42

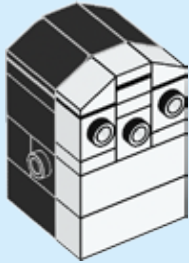
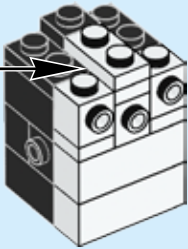



43

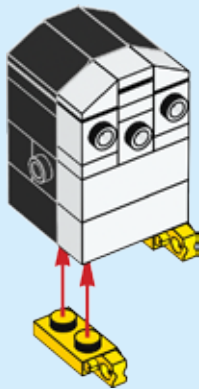

44

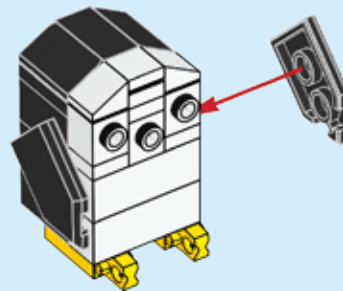



1x



2x

45

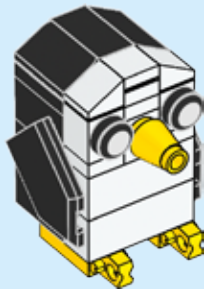

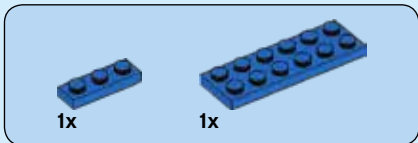
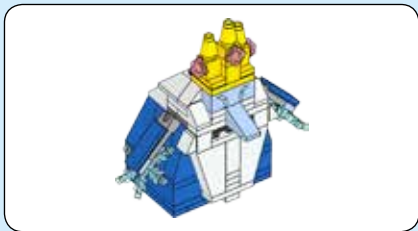

46

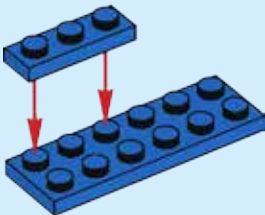

47

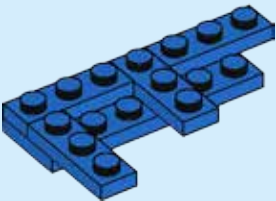

48

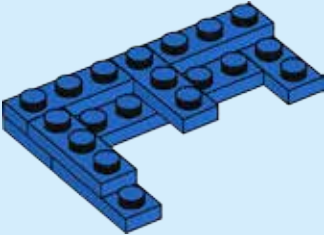

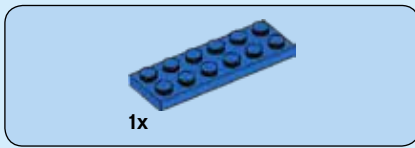

49

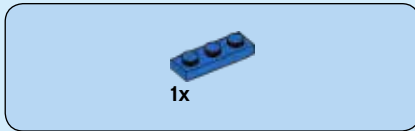
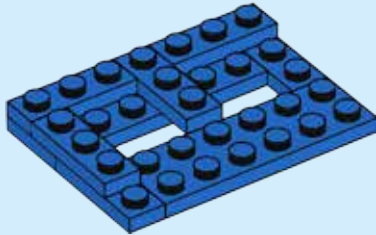

50

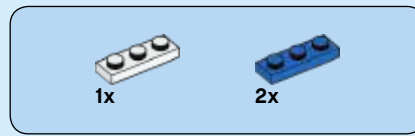
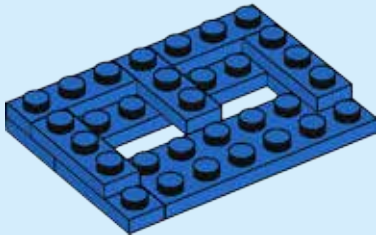

51

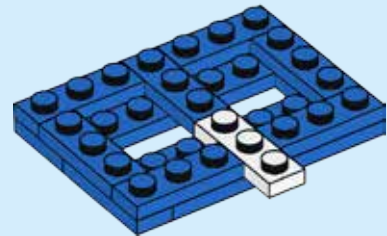

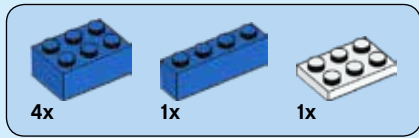

52

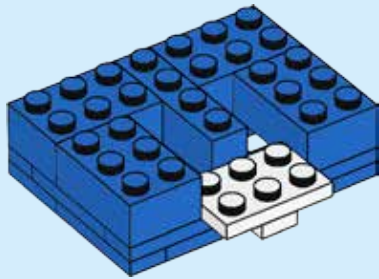

53

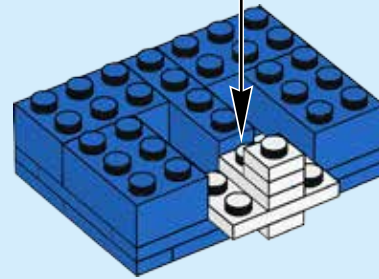
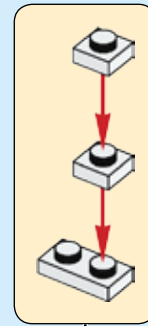

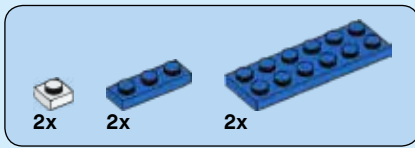

54

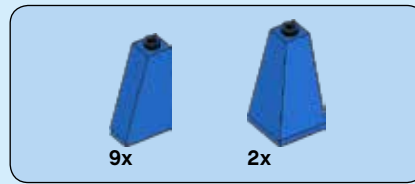
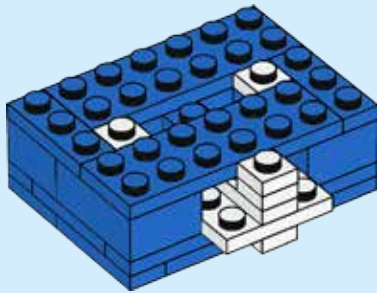

55

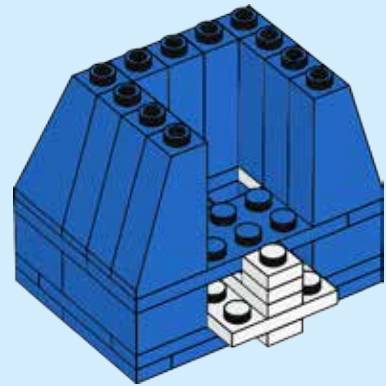

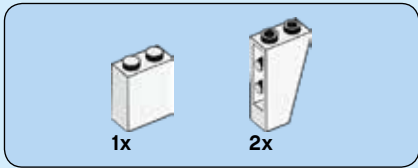

56

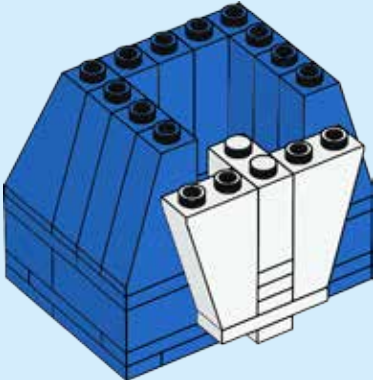

57

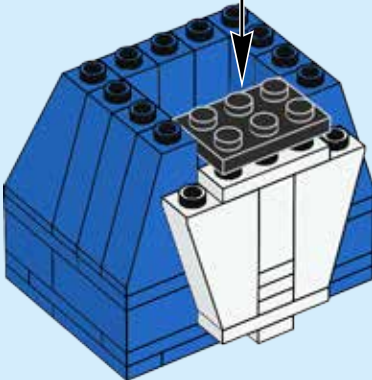
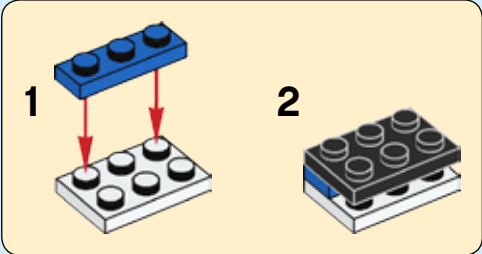

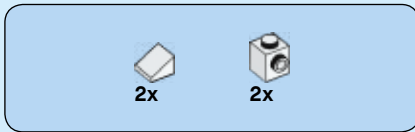

58

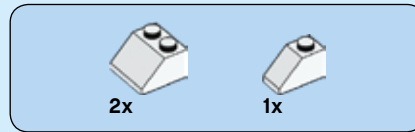
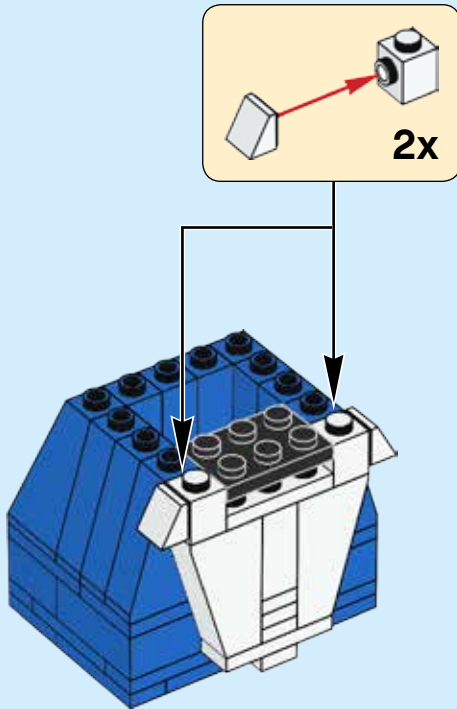

59

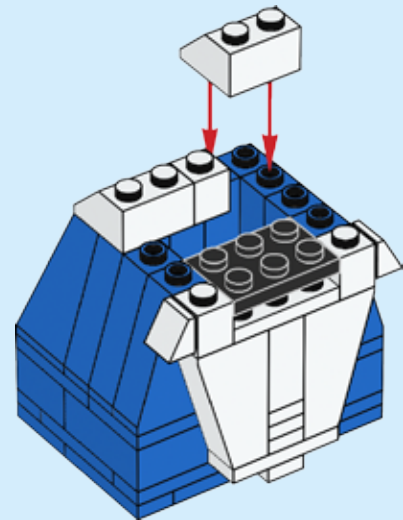

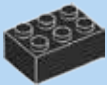

1x

60

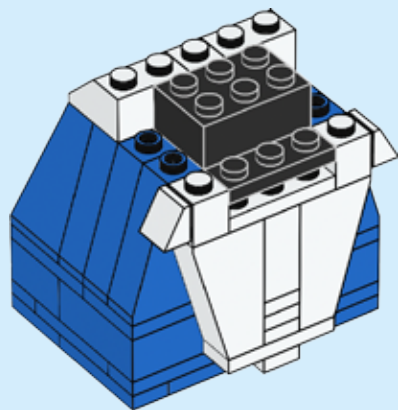

2x



2x

61

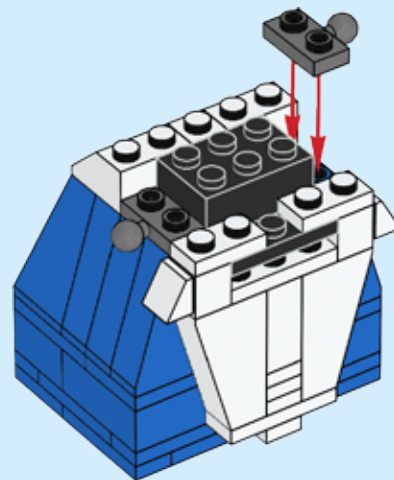

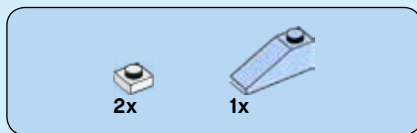

62

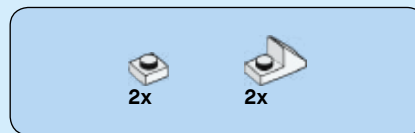
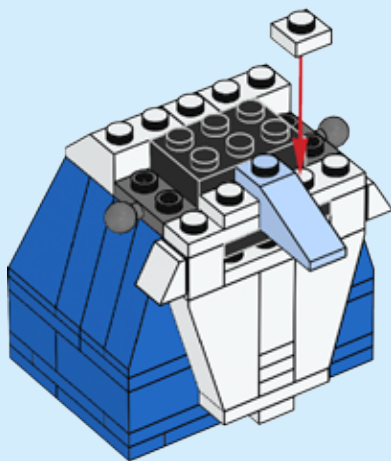

63

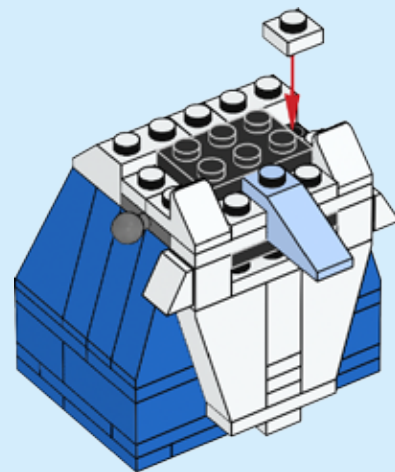

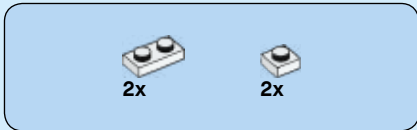

64

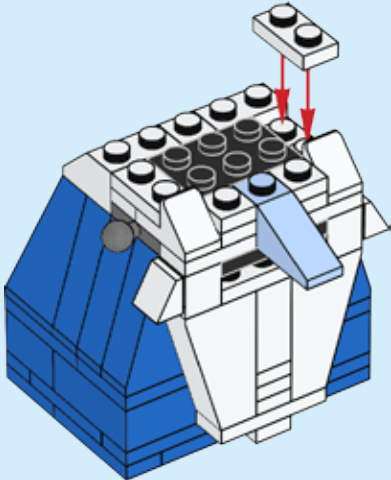

65

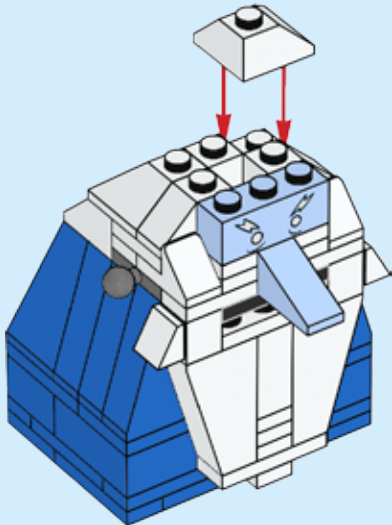



66

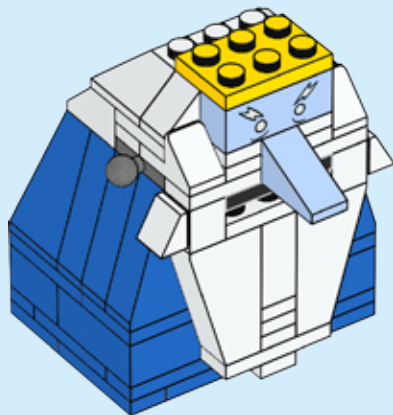

67

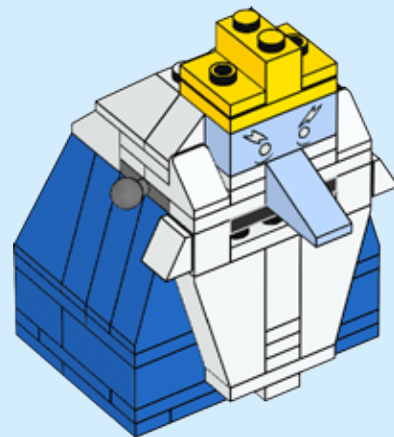



68

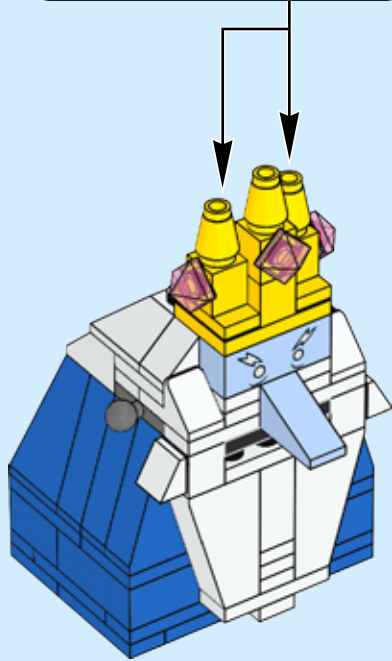
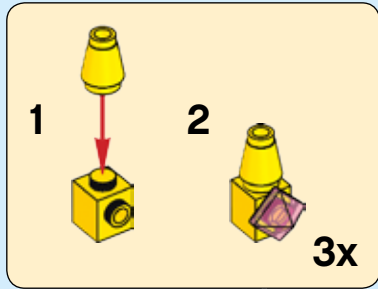

"I love you everything burrito"

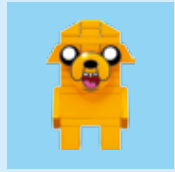

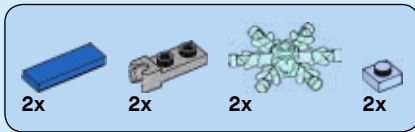

69

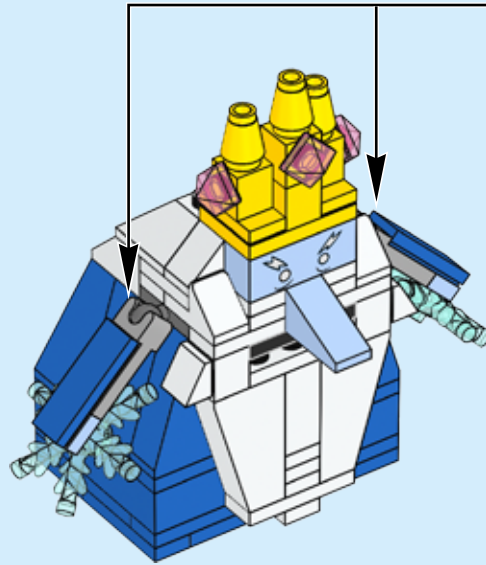
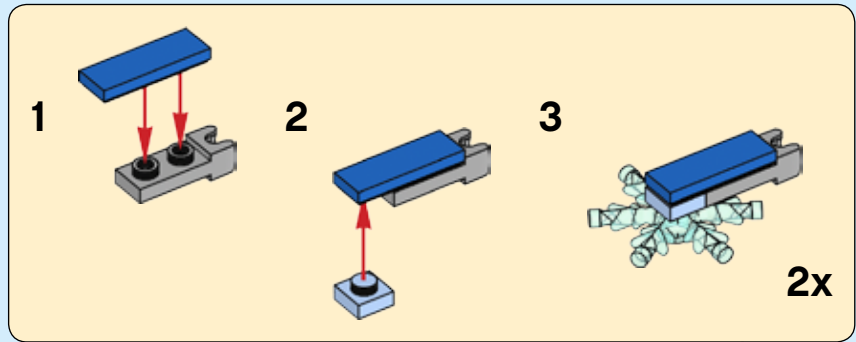

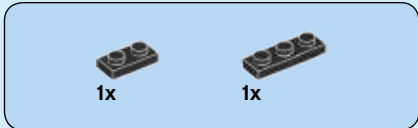
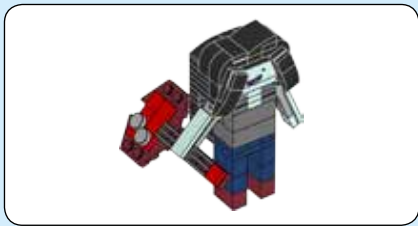

70

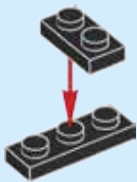

71

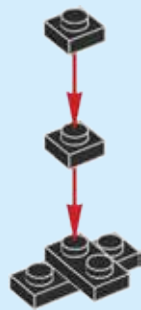

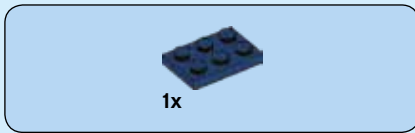

72

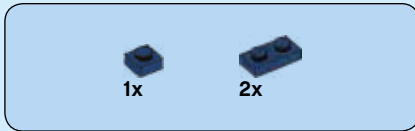
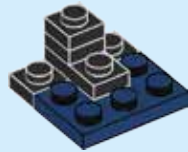

73

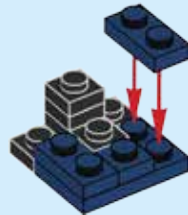

74

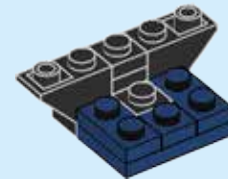

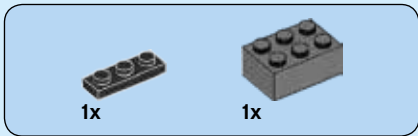

75

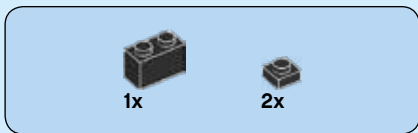
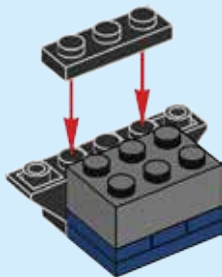

76

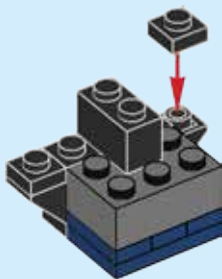

77

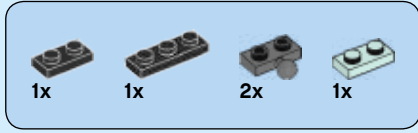
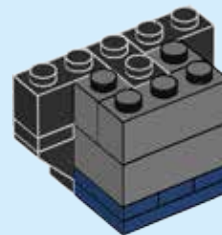

78

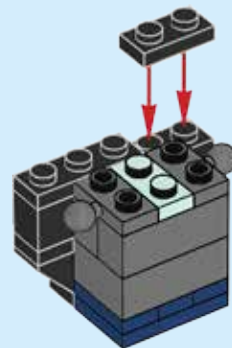

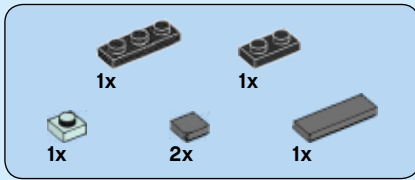

79

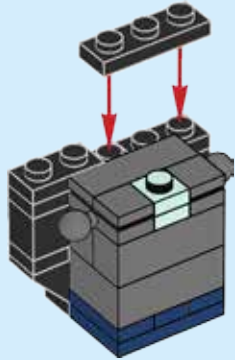

80

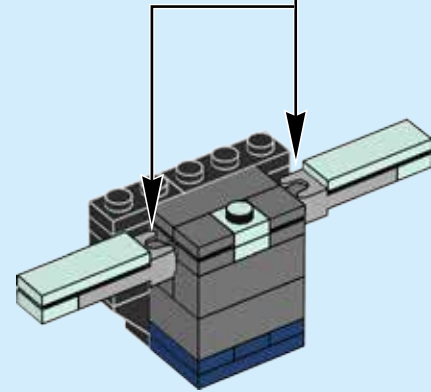
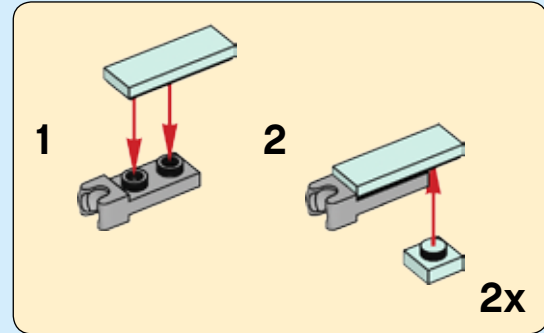



1x



1x

81

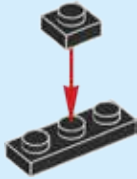

2x

82

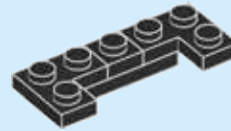

2x

83

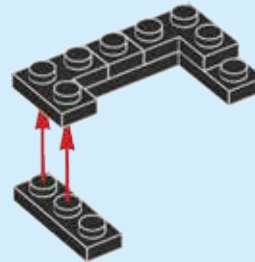

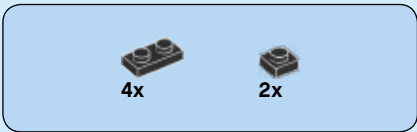

84

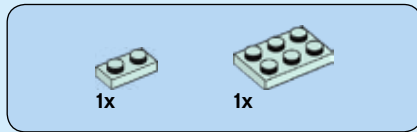
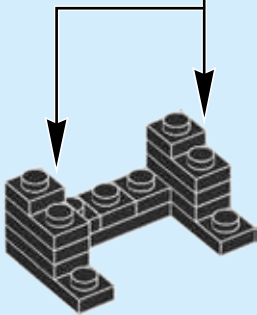
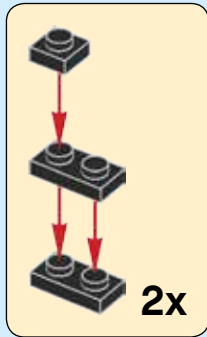

85

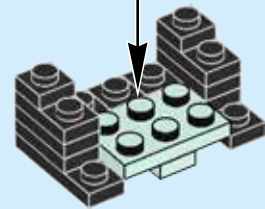
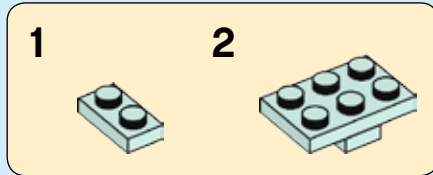

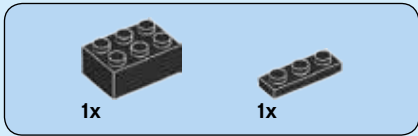

86

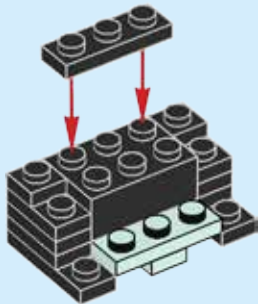

87

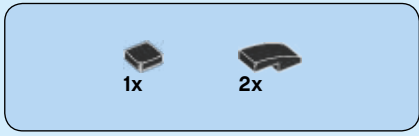
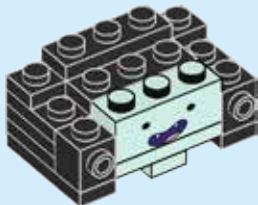

88

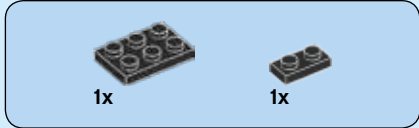
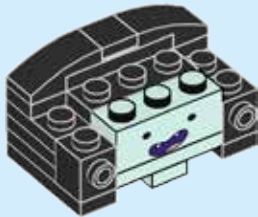

89

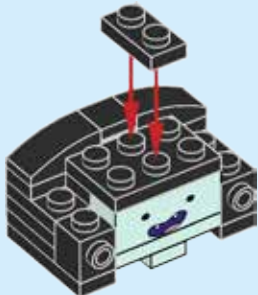



90

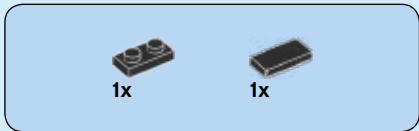
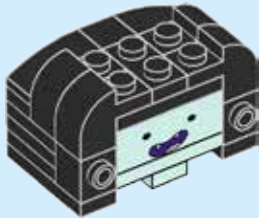

91

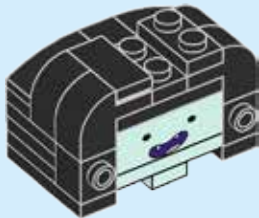

92

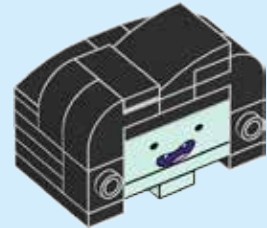

93

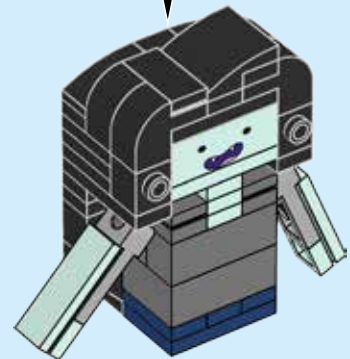



94

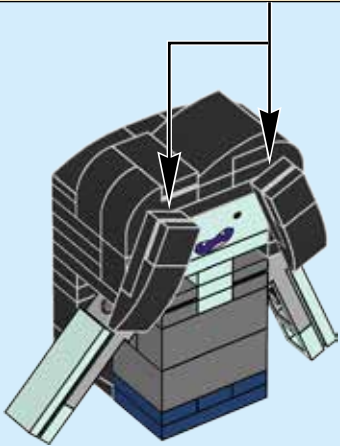
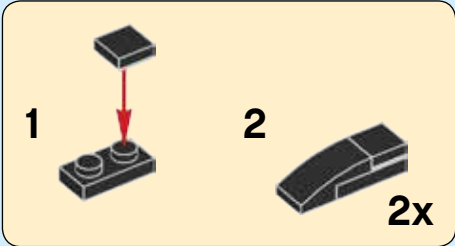

95

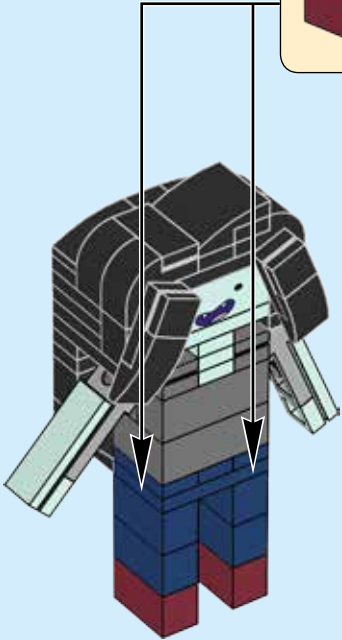
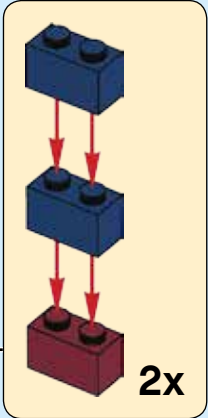



96



97

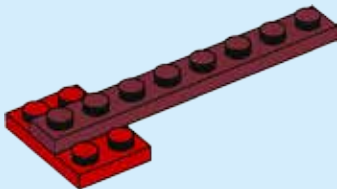

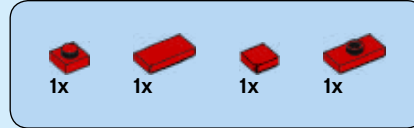
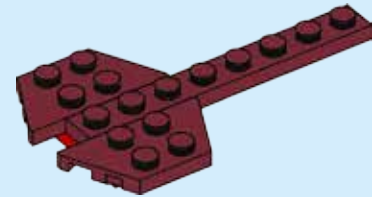

98

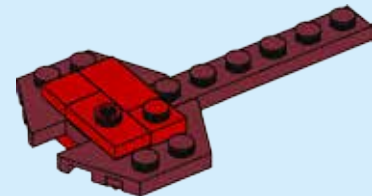

99



		
1x	2x	2x

100

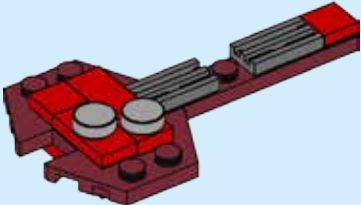

101

"Sorry I'm not made of sugar"

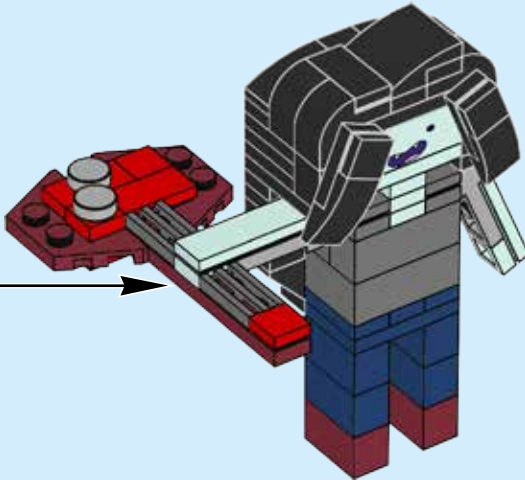
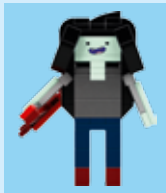

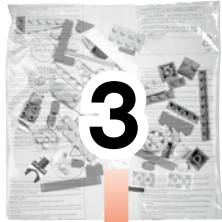

2x

102

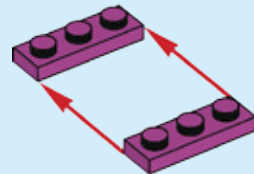



2x

103

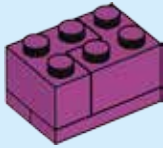

2x

104



2x



1x

105

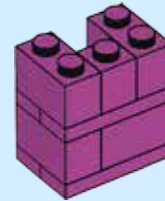

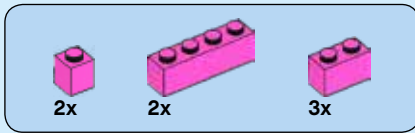

106

1

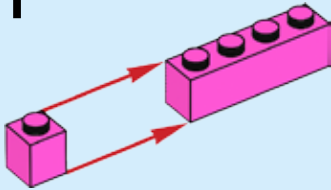

2

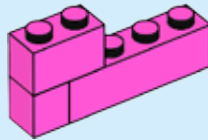

3

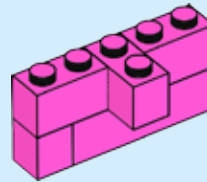

4

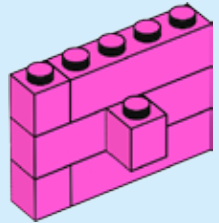

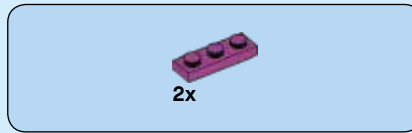
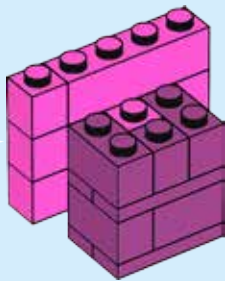

107

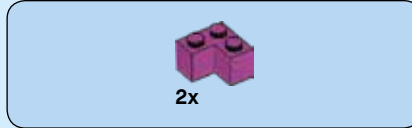
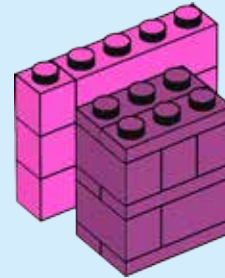

108

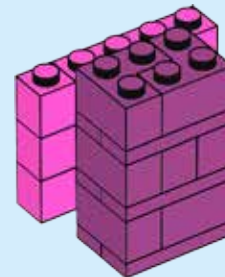

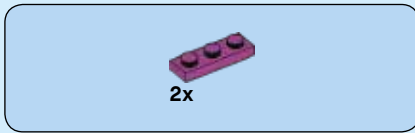

109

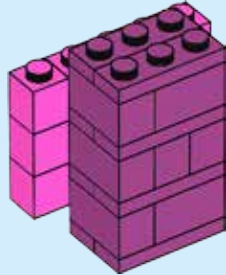

110



111



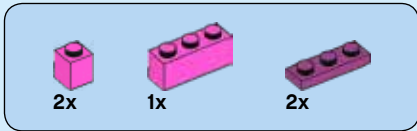

112

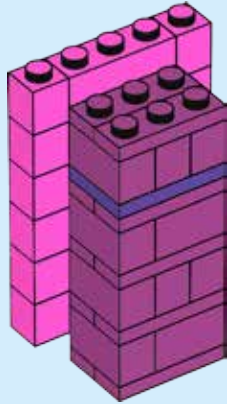

113

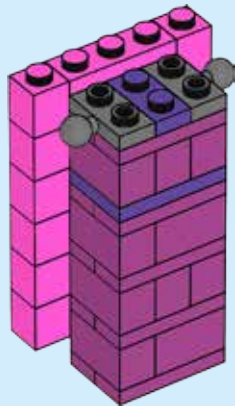

114

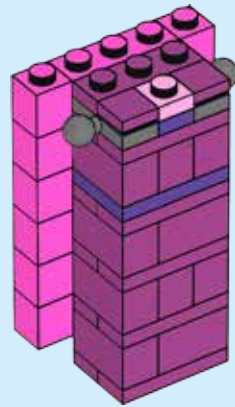



115

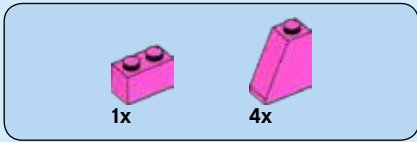
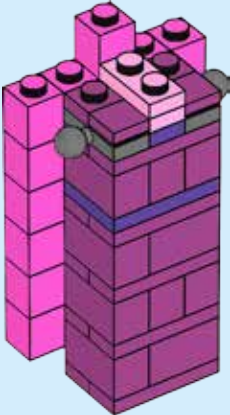

116

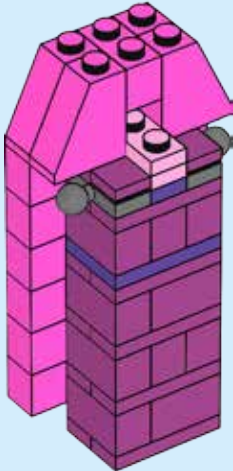

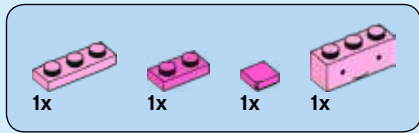

117

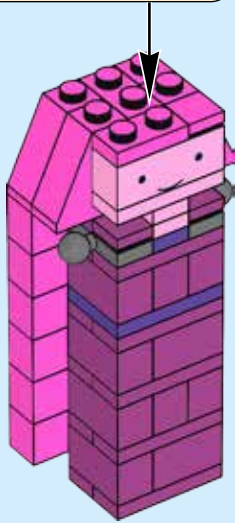
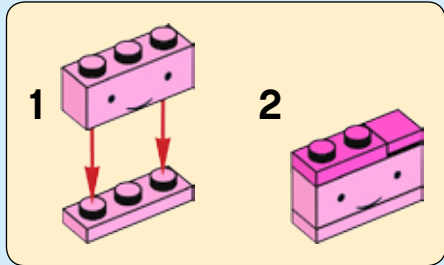

118

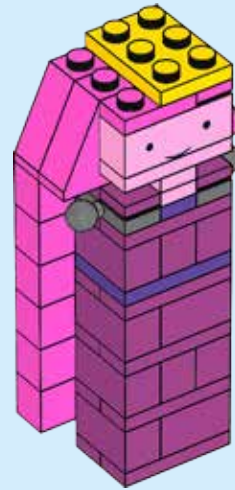



119

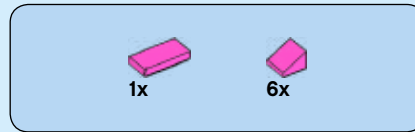
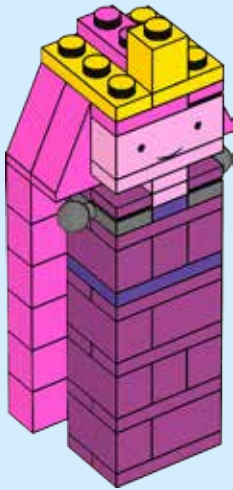

120

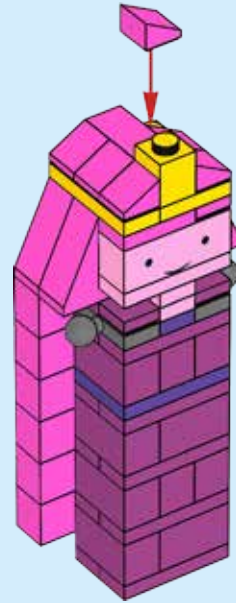



121

"Princess Power"

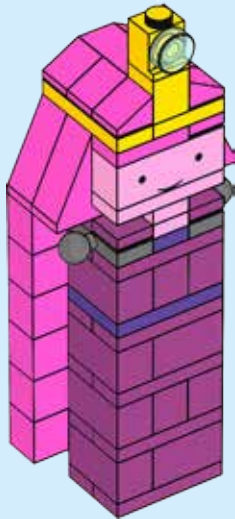
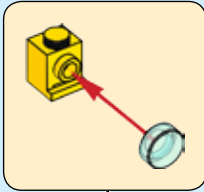
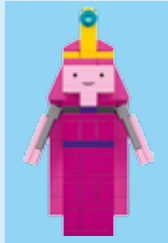

122

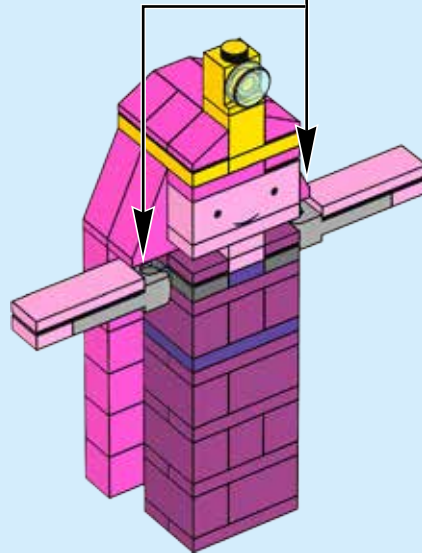
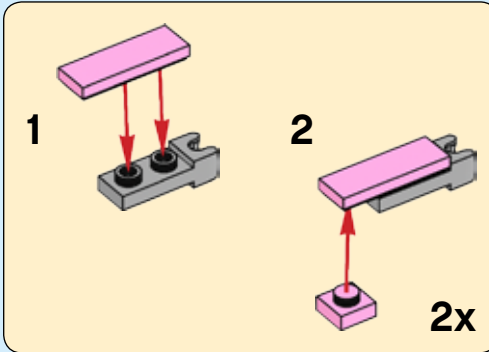

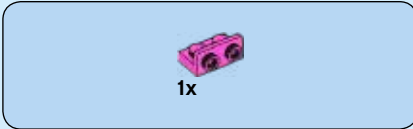
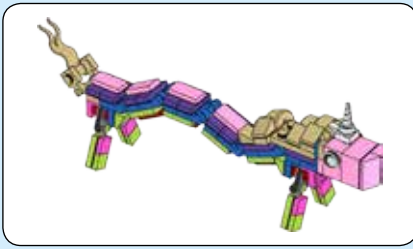

123



124



125



2x

126

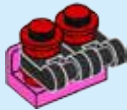

1x

1x

127

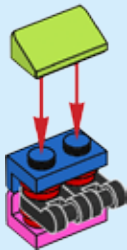

1x

1x

128

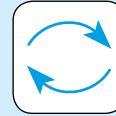

1x

2x

129

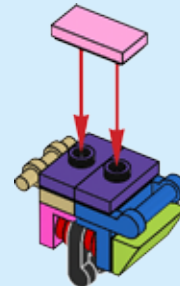

"Get your hero on, Dude!"

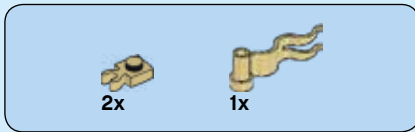

130

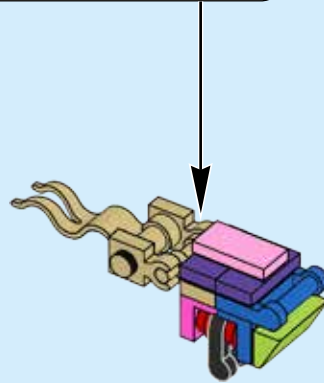
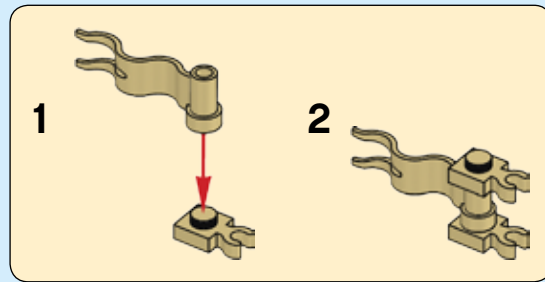



131

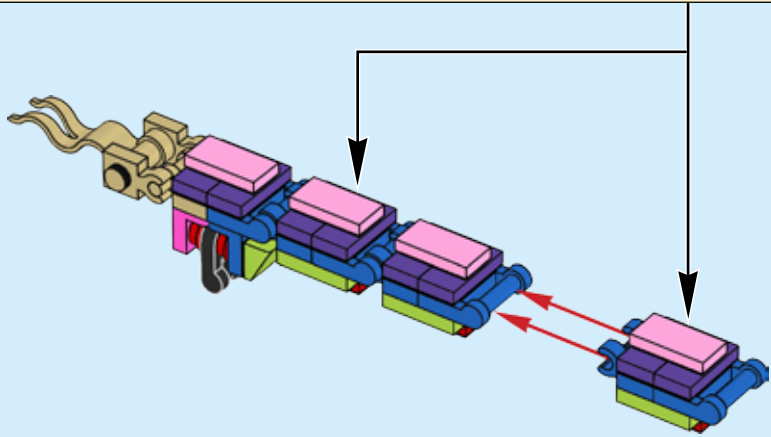
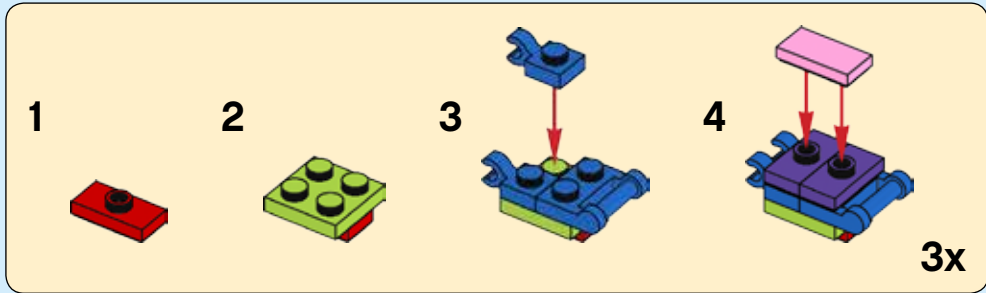



1x

132



1x

133



1x

2x

134

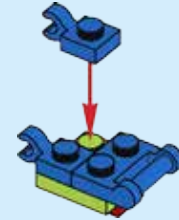

1x

1x

135

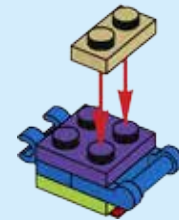



2x

136

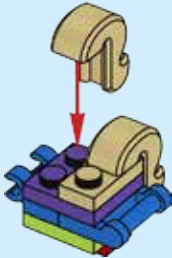

2x

137

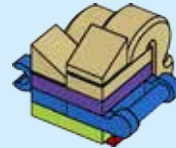

138

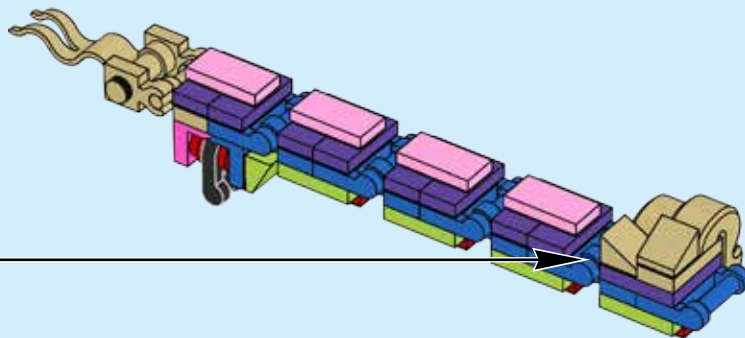



1x

139



2x

140

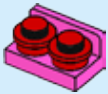

2x

141



2x

142

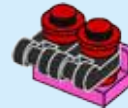



143

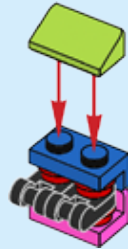

144

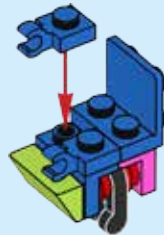
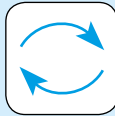

145

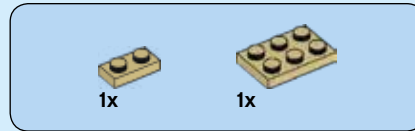
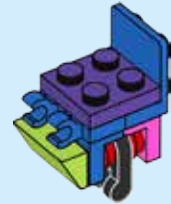

146

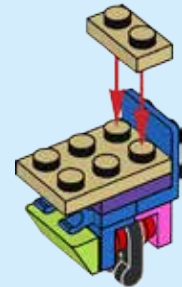



2x

147

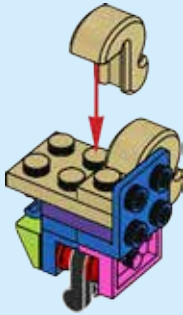

2x

148

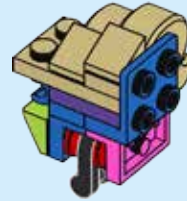



149

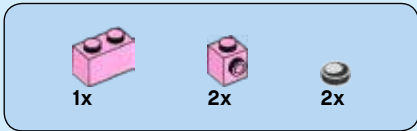
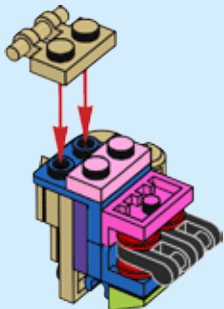
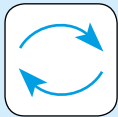

150

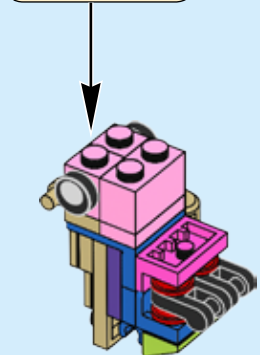
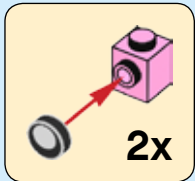



1x

151

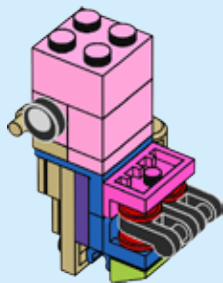

2x

152

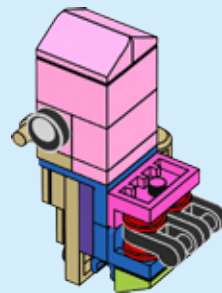

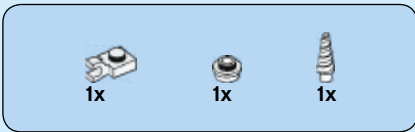

153

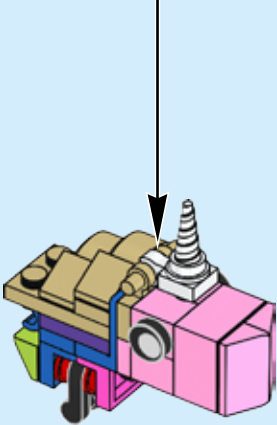
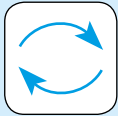
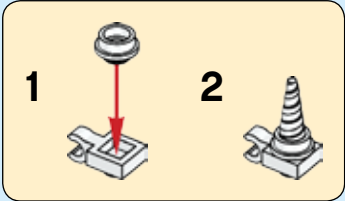

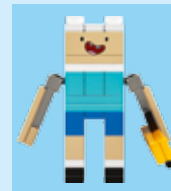

154

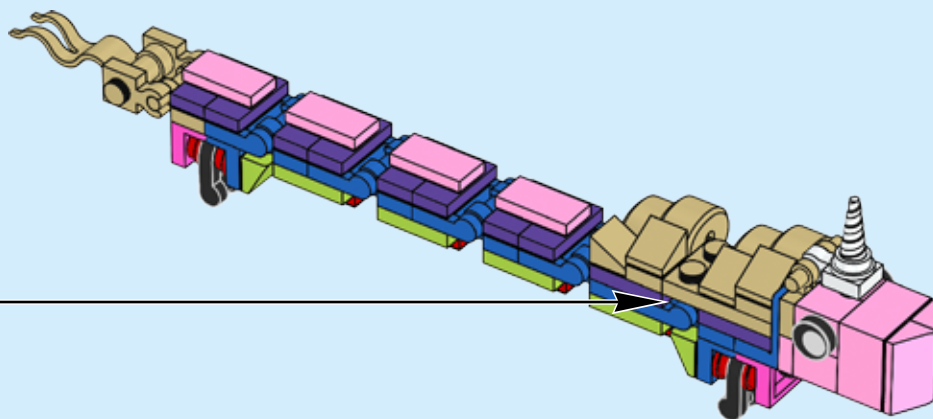

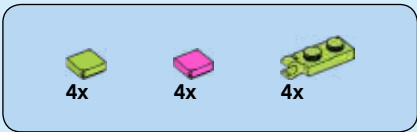

155

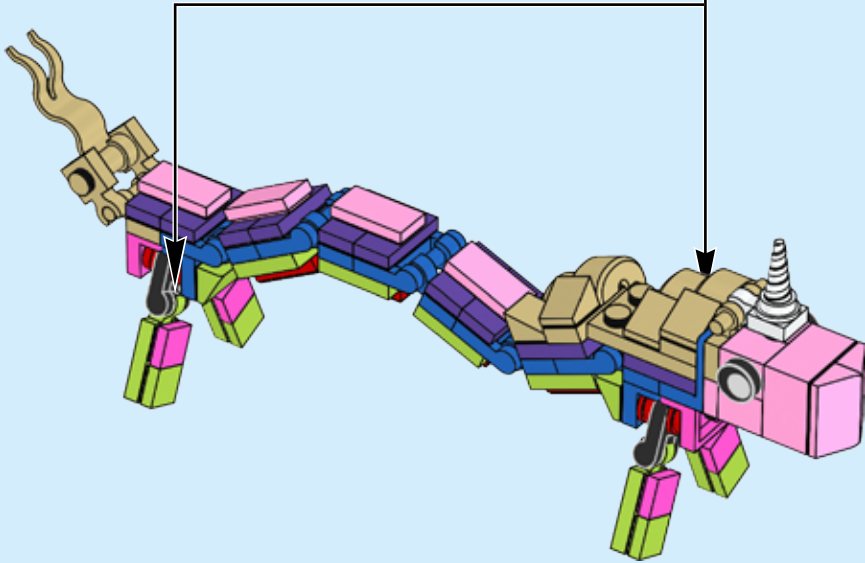
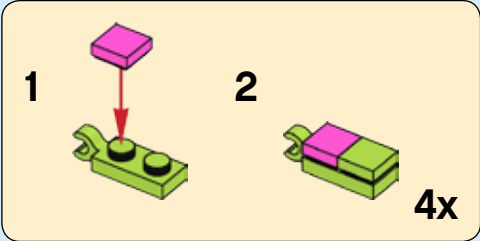

Fan designer

As a fan of both Adventure Time and LEGO® building, recreating the characters from the iconic cartoon series was a tough, but very satisfying task for Ludovic Piraud.

“I discovered Adventure Time after I’d read an article about a wacky cartoon series and decided to give the show a try. At first I was puzzled by it, then intrigued and finally completely hooked by its colorful universe and story.”

“The design of the characters in Adventure Time uses very round shapes, therefore LEGO® bricks don’t instantly feel like a good fit to reproduce these rounded shapes. However,

other elements like colors and proportions between shapes are often enough to make a character recognizable, so I thought I’d try to make block-like characters.”

“I’m just an occasional LEGO® builder, so I asked for input from other LEGO Ideas users. The feedback I received was very constructive. The last project update is the most accomplished and that’s all thanks to the support from the community.”



LEGO® designer

As a LEGO® designer, it was Adrian Florea's role to ensure the final model measured up to the exacting standards expected of all LEGO sets.

"I have followed the series since its first season and instantly liked the characters and the situations they found themselves in, so I was glad to be asked to work on this project."

"As Ludovic's original model was submitted as a 3D rendering and included some elements that were no longer available, I had to find ways to make everything work with the options we had. The same goes for colors, I had to make sure all the right elements were in the proper color."

"I love the line up of characters, but Marceline is my favorite. She has her own bass axe and she's a vampire. I'm from Transylvania and I play the bass in my spare time."



 1x 4113261	 1x 307001	 2x 4109995	 2x 300423	 10x 4520946	 3x 300426	 2x 306926	 1x 302421
 3x 362201	 13x 302401	 1x 6182793	 4x 300223	 2x 6163471	 1x 362226	 17x 302326	 2x 307021
 5x 4558952	 8x 302301	 4x 4516055	 1x 301023	 1x 6133720	 4x 300226	 2x 242026	 1x 306921
 1x 654101	 1x 306901	 2x 4159553	 1x 301023	 5x 4514398	 4x 300226	 2x 6128992	 5x 6092565
 4x 4504369	 2x 6051511	 2x 4113917	 9x 4121925	 1x 300524	 4x 4558954	 8x 362326	 1x 302121
 2x 6069002	 2x 6051511	 2x 6131896	 9x 4121925	 1x 300424	 2x 4548180	 1x 4558170	 8x 614121
 4x 4121932	 2x 362301	 1x 4121921	 2x 6184480	 3x 4624985	 2x 366526	 3x 302126	 3x 6063445
 2x 4532972	 3x 302101	 1x 4118790	 1x 302323	 1x 407024	 4x 6047276	 4x 6157554	 1x 4504372
 2x 4532972	 1x 4538353	 2x 6029889	 12x 362323	 4x 4525464	 4x 609126	 2x 614126	 3x 6025026
 2x 4233370	 1x 4547649	 2x 4140593	 2x 4587840	 2x 6092583	 1x 6053077	 2x 6139403	 4x 4537251
 2x 303901	 2x 4646844	 1x 6150130	 2x 4587840	 1x 362324	 6x 6182792	 2x 73587	 4x 4537937
80	 1x 6156242	 4x 6109586	 4x 379523	 2x 302124	 4x 307026	 2x 6156414	 1x 6013530
	 1x 6156242	 4x 6109586	 4x 379523	 2x 4588025	 8x 302426	 2x 4184169	 4x 6138122

1x 6022171	2x 4616581	1x 6061685	2x 4211098	6x 44922224	1x 4517993	8x 6092604	1x 6182795
2x 6136391	1x 4521947	2x 6003003	1x 4211104	7x 4621545	1x 4550359	1x 4655695	3x 6058016
1x 4546705	4x 6009656	1x 6061688	1x 4211105	1x 4618655	1x 6182796	2x 6047422	2x 6146701
1x 6000071	3x 6184432	8x 6092035	2x 4210848	3x 4621542	2x 4621554	1x 4225142	1x 6182789
2x 6022035	2x 4616578	3x 6023173	2x 4210848	6x 6127601	2x 4649749	3x 4619652	1x 6182789
4x 4519195	1x 4655080	2x 6024286	2x 4210631	4x 6062343	3x 6031883	2x 6145253	2x 6184485
4x 6109979	2x 6184348	3x 4622062	1x 4568734	4x 6062343	4x 4580010	2x 4619513	1x 6192108
2x 6099364	2x 4539102	7x 6028736	6x 6039479	5x 6133726	2x 4654128	1x 4654448	3x 6172693
11x 6022048	1x 4541507	1x 6099725	1x 6182794	1x 6056381	2x 6070317		
4x 4249891	2x 4541544	3x 6097503	1x 6182794	2x 6057387	1x 6036788		
1x 4184108	1x 4216581	1x 6020074	1x 6056239	2x 6099449			
2x 4528981	2x 4650260	1x 6182797	2x 6184484				
1x 4530028	8x 6043639	1x 6170304					

Customer Service

Kundenservice

Service Consommateurs

Servicio Al Consumidor

LEGO.com/service or dial



: 00800 5346 5555

: 1-800-422-5346

SHARE YOUR IDEA
TEILE DEINE IDEE
PARTAGE TON IDÉE
COMPARTE TU IDEA
PARTILHA A TUA IDEIA
TEDD KÖZZÉ AZ ÖTLETED
分享您的观点

LEGO® REVIEW
LEGO® PRÜFUNG
EXAMEN PAR LEGO®
REVISIÓN DE LEGO®
AVALIAÇÃO LEGO®
LEGO® VÉLEMÉNYEZÉS
乐高®评论



GATHER SUPPORT
HOL' DIR UNTERSTÜTZUNG
RASSEMBLE DES VOTES
GANA APOYOS
OBTÉM APOIO
SZEREZZ TÁMOGATÁST
获得更多支持



NEW LEGO® PRODUCT
NEUES LEGO® PRODUKT
NOUVEAU PRODUIT LEGO®
NUEVO PRODUCTO LEGO®
NOVO PRODUTO LEGO®
ÚJ LEGO® TERMÉK
新的乐高®产品



[LEGO.COM/IDEAS](https://www.lego.com/ideas)



Do you like this LEGO® Ideas set?

The LEGO® Group would like your opinion on the new product you have just purchased. Your feedback will help shape the future development of this product series. Please visit:

[LEGO.com/productsurvey](https://www.lego.com/productsurvey)



By completing our short feedback survey, you will be automatically entered into a drawing to win a LEGO® prize. See website for official rules and details. Open to all countries where not prohibited.

LEGO and the LEGO logo are trademarks of the LEGO Group. ©2017 The LEGO Group.

ADVENTURE TIME, CARTOON NETWORK, the logos, and all related characters and elements are trademarks of and © Cartoon Network. (s16)

6194759