

DIMENSIONS™

71264



PLAY THE COMPLETE MOVIE

LEGO DIMENSIONS Videogame software © 2017 TT Games Ltd. Produced by TT Games under license from the LEGO Group. LEGO, the LEGO logo, NINJAGO, the NINJAGO logo, DIMENSIONS, the DIMENSIONS logo, the Brick and Knob configurations and the Minifigure are trademarks and/or copyrights of the LEGO Group. ©2017 The LEGO Group. Ghostbusters™ & © 2017 CPlI. All Rights Reserved. A-Team™ & © 2017 Twentieth Century Fox Film Corporation. All Rights Reserved. ADVENTURE TIME and all related characters and elements are trademarks of and © Cartoon Network. (s17). TM, ® & ©2017 Paramount Pictures. All Rights Reserved. ©2017 Warner Bros Entertainment Inc. All Rights Reserved. Harry Potter and Fantastic Beasts Publishing Rights © JKR. (s17). © SEGA. All rights reserved. GREMLINS © &™ WBEl (s17).™ & © Universal Studios. E.T. THE EXTRA TERRESTRIAL is a trademark and copyright of Universal Studios. Licensed by Universal Studios Licensing LLC. All DC characters and related indicia™ & © DC Comics.™ & © WBEl. (s17). All other trademarks and copyrights are the property of their respective owners. All rights reserved.

Logiciel de jeu vidéo LEGO DIMENSIONS © 2017 TT Games Ltd. Produit par TT Games avec l'autorisation de LEGO Group. LEGO, le logo LEGO, NINJAGO, le logo NINJAGO, DIMENSIONS, le logo DIMENSIONS, les configurations de la Brique et du Bouton, ainsi que le Minifigure sont des marques de commerce ou des droits d'auteur de LEGO Group. ©2017 The LEGO Group. Ghostbusters™ et © 2017 CPlI. Tous droits réservés. A-Team™ et © 2017 Twentieth Century Fox Film Corporation. Tous droits réservés. ADVENTURE TIME et tous personnages et éléments associés sont des marques de commerce et droits d'auteur de Cartoon Network. (s17).™, ® et ©2017 Paramount Pictures. Tous droits réservés. ©2017 Warner Bros Entertainment Inc. Tous droits réservés. Droits d'édition sur Harry Potter et Les Animaux fantastiques © JKR. (s17). © SEGA. Tous droits réservés. GREMLINS © et™ WBEl (s17).™ et © Universal Studios. E.T. L'EXTRA-TERRESTRE est une marque de commerce d'Universal Studios, qui en détient également les droits d'auteur. Autorisé par Universal Studios Licensing LLC. Tous les personnages DC et indices associés sont des marques de commerce et © de DC Comics.™ et © WBEl. (s17). Toutes les autres marques de commerce et droits d'auteur sont la propriété de leurs propriétaires respectifs. Tous droits réservés.

LEGO DIMENSIONS Videogame software © 2017 TT Games Ltd. Producido por TT Games con licencia de LEGO Group. LEGO, el logotipo de LEGO, NINJAGO, el logotipo de NINJAGO, DIMENSIONS, el logotipo de DIMENSIONS, las configuraciones Brick y Knob y la Minifigura son marcas de fábrica y/o derechos de autor de LEGO Group. ©2017 The LEGO Group. Ghostbusters es™ y © 2017 de CPlI. Todos los derechos reservados. A-Team es™ y © 2017 de Twentieth Century Fox Film Corporation. Todos los derechos reservados. ADVENTURE TIME y todos los personajes y elementos relacionados son marcas registradas y © de Cartoon Network. (s17).™ es ® y © de 2017 Paramount Pictures. Todos los derechos reservados. ©2017 Warner Bros Entertainment Inc. Todos los derechos reservados. Harry Potter y Animales Fantásticos Derechos de publicación © JKR. (s17). © SEGA. Todos los derechos reservados. GREMLINS es © y™ de WBEl (s17).™ y © de Universal Studios. E.T. THE EXTRA TERRESTRIAL es una marca registrada y los derechos de autor son de Universal Studios. Con licencia de Universal Studios Licensing LLC. Todos los personajes y elementos relacionados de DC son™ y © de DC Comics.™ y © de WBEl. (s17). Todas las marcas comerciales y los derechos de autor son propiedad de sus respectivos titulares. Todos los derechos reservados.



WB GAMES LOGO, WBIE LOGO, WB SHIELD:™ & © Warner Bros. Entertainment Inc.
LOGO WB GAMES, LOGO WBIE, BOUCLIER WB :™ et © de Warner Bros. Entertainment Inc.
LOGOTIPO de WB GAMES, LOGOTIPO de WBIE, ESCUDO de WB:™ & © Warner Bros. Entertainment Inc.
(s17)

THE LEGO MOVIE © The LEGO Group & WBEl.
LE FILM LEGO © The LEGO Group et WBEl.
LA GRAN AVENTURA LEGO © The LEGO Group & WBEl.

© New Line.™ & © SZC lic. to WBIE.
© New Line.™ et © SZC lic. à WBIE.
© New Line.™ & © SZC con licencia de WBIE.
(s17)



All DC characters and related indicia™ & © DC Comics.™ & © WBEl.
Tous les personnages DC et toutes les marques associées™ et © DC Comics.™ et © WBEl.
Todos los personajes de DC e indicios relacionados™ & © DC Comics.™ & © WBEl.
(s17)

JOUEZ LE FILM EN ENTIER
JUEGA LA PELÍCULA COMPLETA

This device complies with part 15 of the FCC Rules. Operation is subject to the following two conditions:

(1) This device may not cause harmful interference, and (2) this device must accept any interference received, including interference that may cause undesired operation.

This device should be installed and operated with a minimum distance of 20 cm to your body.

NOTE: This equipment has been tested and found to comply with the limits for a Class B digital device, pursuant to part 15 of the FCC Rules. These limits are designed to provide reasonable protection against harmful interference in a residential installation. This equipment generates, uses and can radiate radio frequency energy and, if not installed and used in accordance with the instructions, may cause harmful interference to radio communications. However, there is no guarantee that interference will not occur in a particular installation. If this equipment does cause harmful interference to radio or television reception, which can be determined by turning the equipment off and on, the user is encouraged to try to correct the interference by one or more of the following measures:

- Reorient or relocate the receiving antenna.
- Increase the separation between the equipment and receiver.
- Connect the equipment into an outlet on a circuit different from that to which the receiver is connected.
- Consult the dealer or an experienced radio/TV technician for help.

Caution: changes or modifications not expressly approved by the party responsible for compliance could void the user's authority to operate the equipment.

This device complies with Industry Canada license-exempt RSS standard(s). Operation is subject to the following two conditions:

(1) this device may not cause interference, and (2) this device must accept any interference, including interference that may cause undesired operation of the device.

Le présent appareil est conforme aux CNR d'Industrie Canada applicables aux appareils radio exempts de licence. L'exploitation est autorisée aux deux conditions suivantes : (1) l'appareil ne doit pas produire de brouillage, et (2) l'utilisateur de l'appareil doit accepter tout brouillage radioélectrique subi, même si le brouillage est susceptible d'en compromettre le fonctionnement.



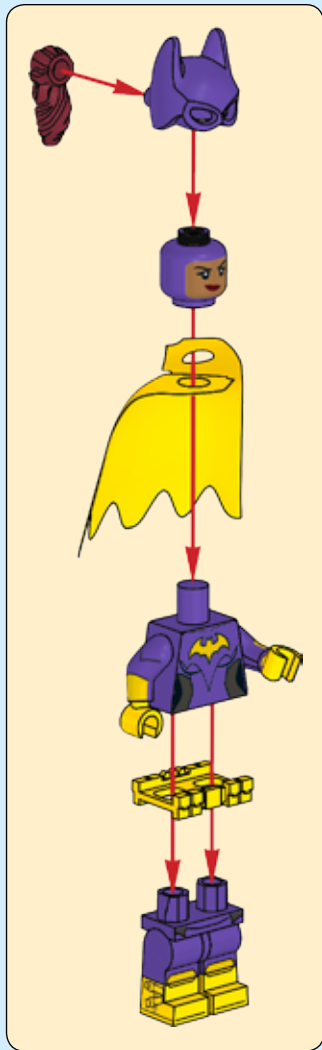
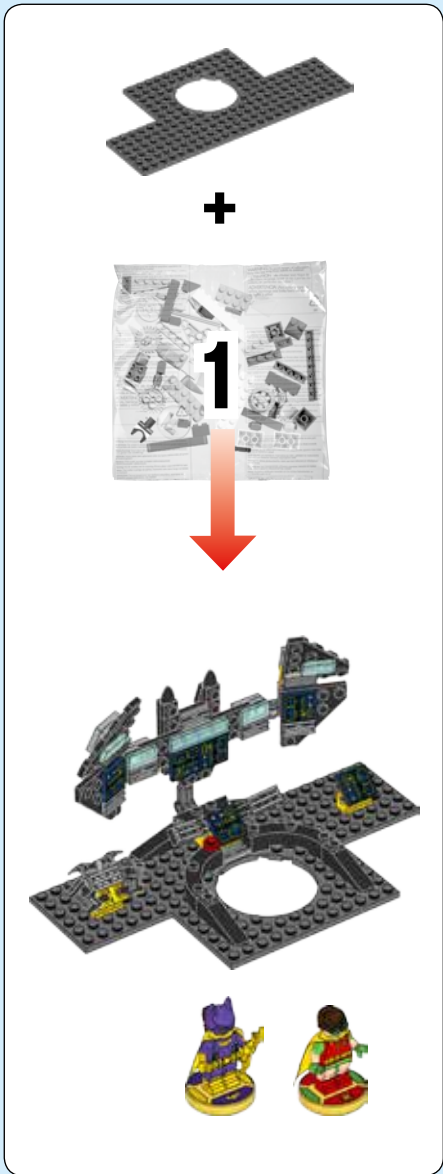

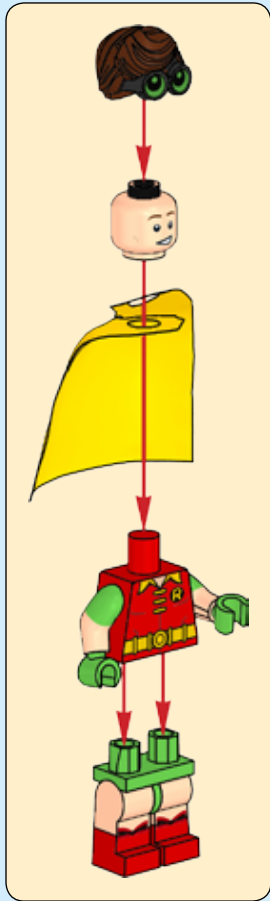

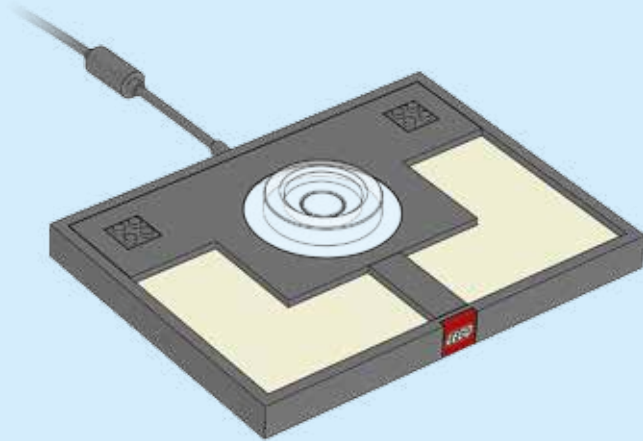

Download the latest game content to use this character

Télécharge le contenu le plus récent du jeu pour utiliser ce personnage

Descarga la última actualización de contenido para usar este personaje

Start game
Commence le jeu
Iniciar juego

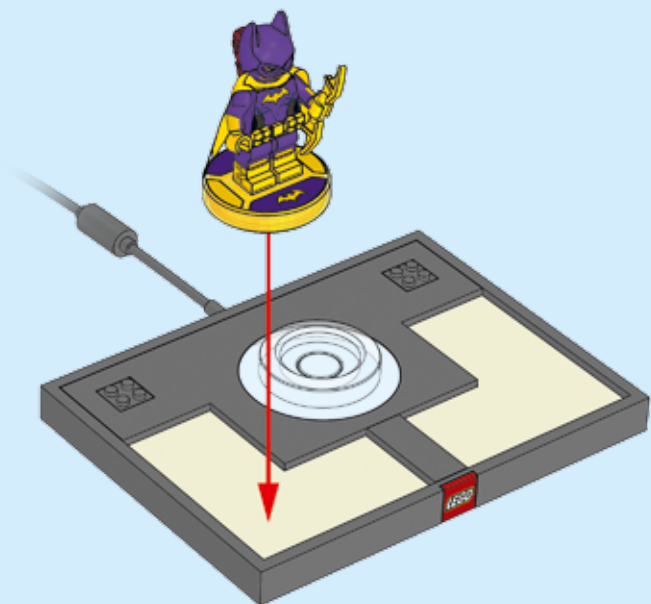



- **Building is part of playing the game**
- **La construction fait partie du déroulement du jeu**
- **Construir forma parte del juego**



1

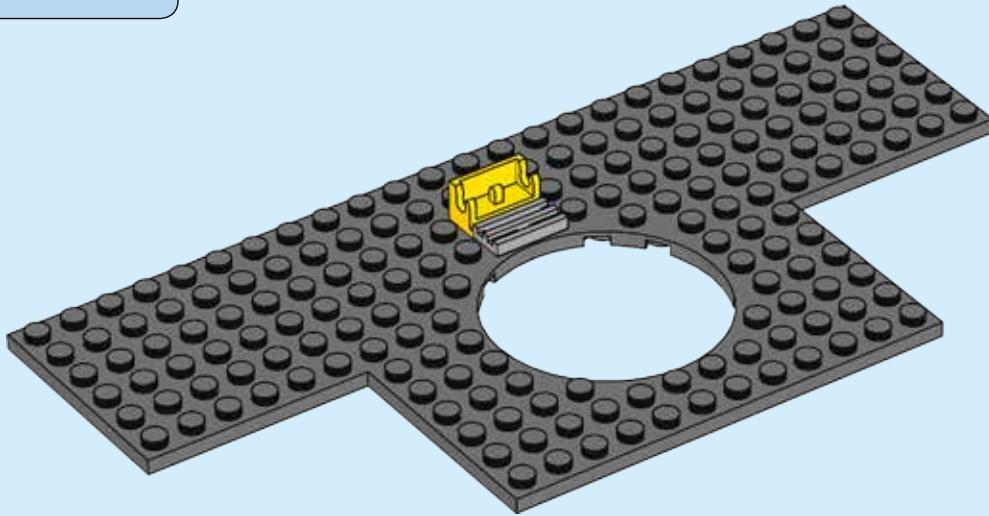

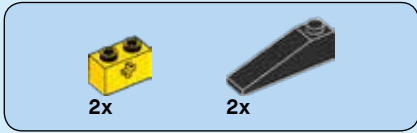

2

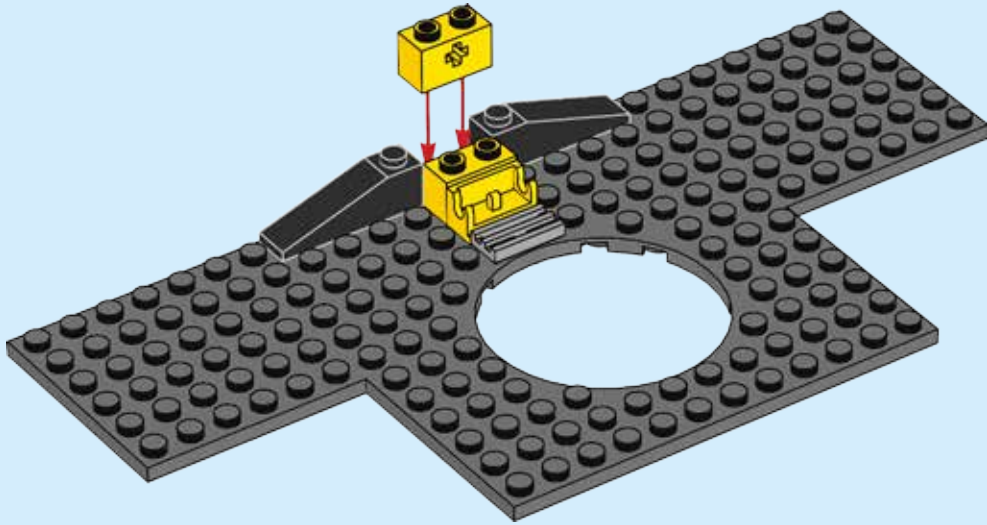

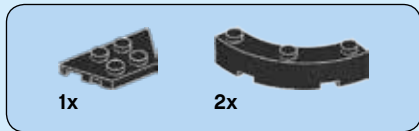

3

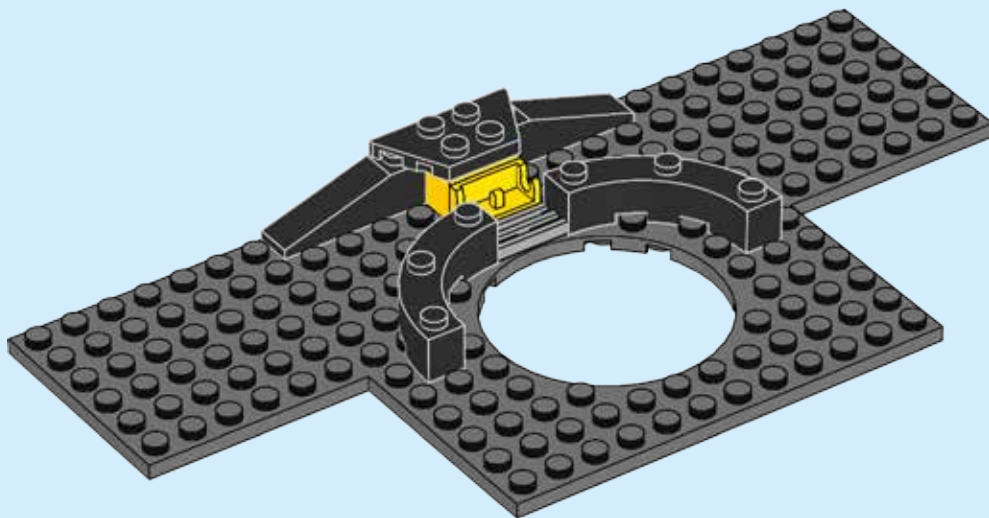

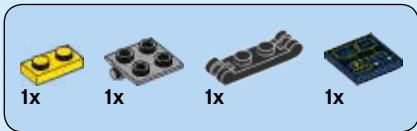

4

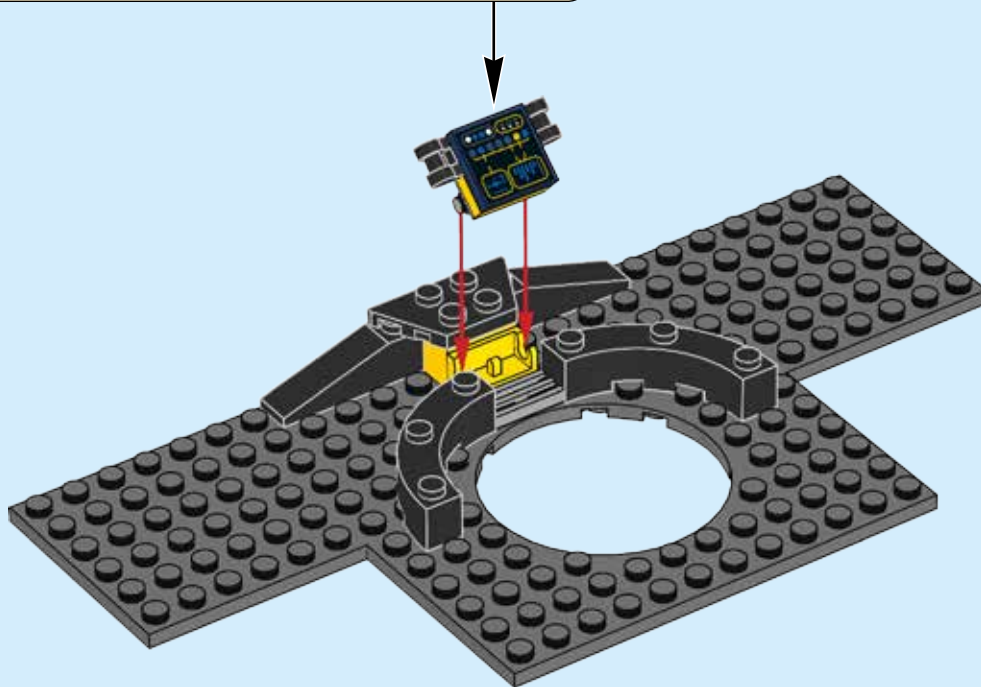



2x



2x

5

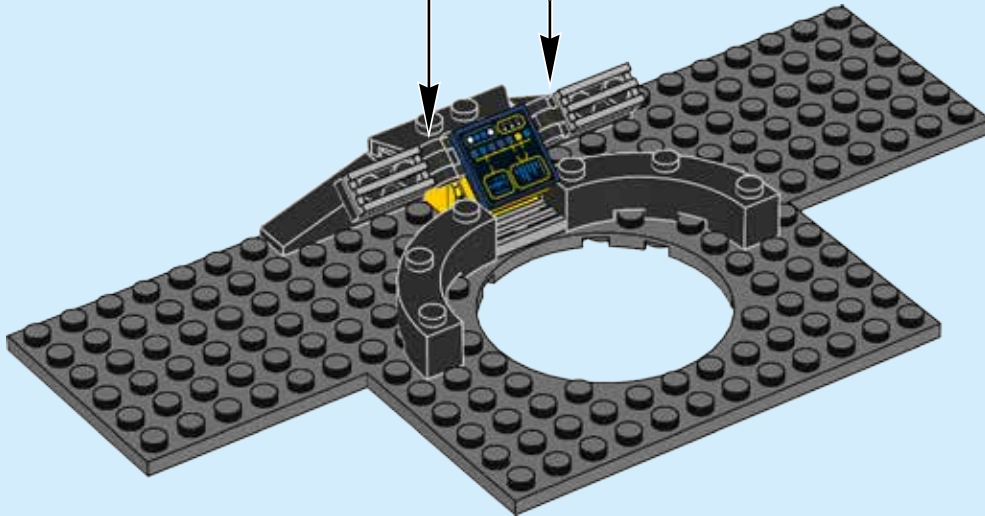
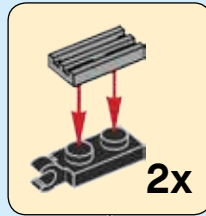

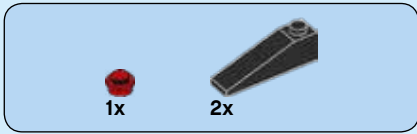

6

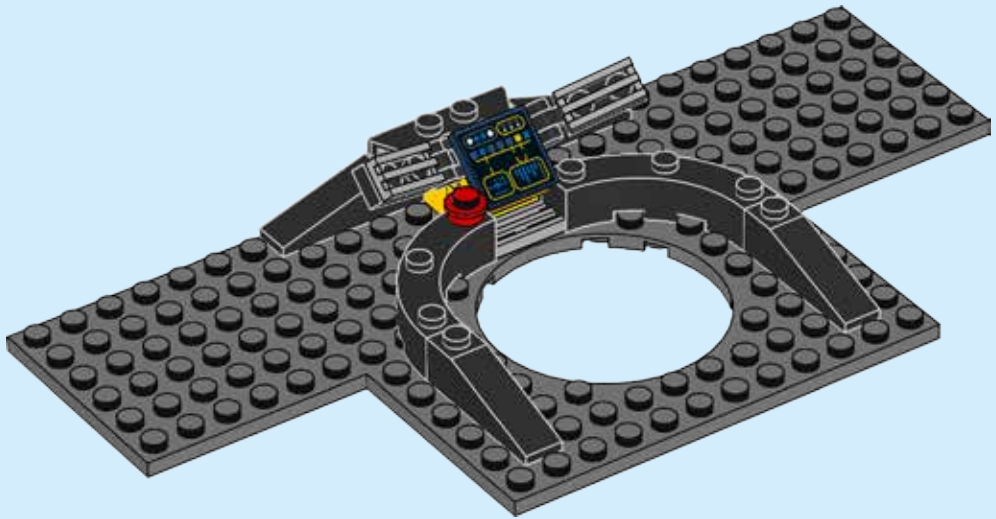



2x

7

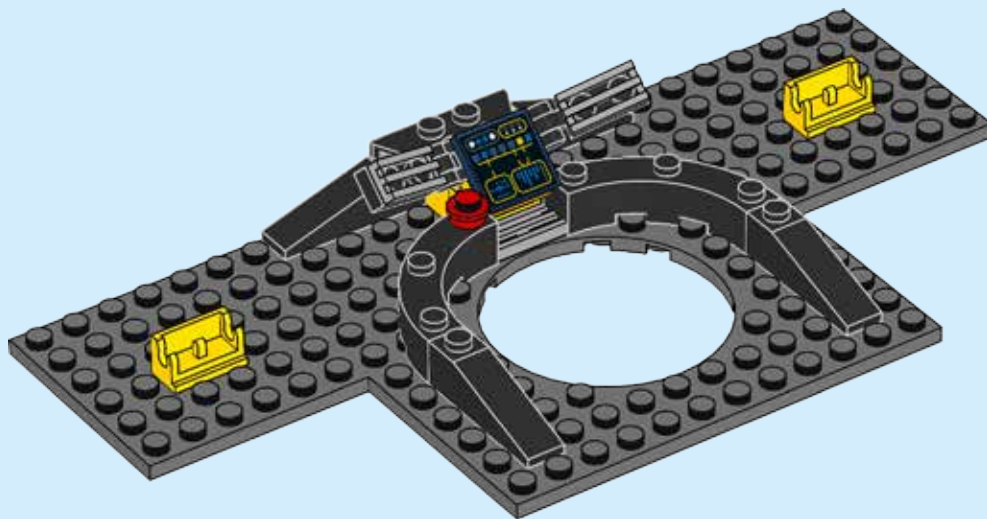



8

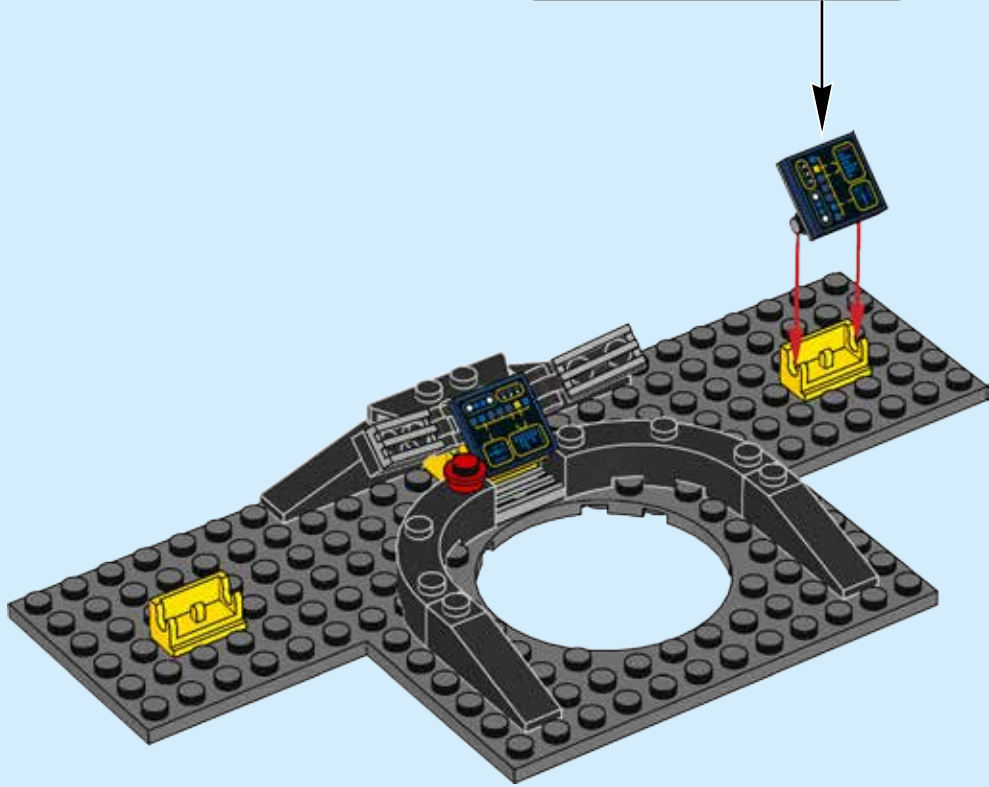
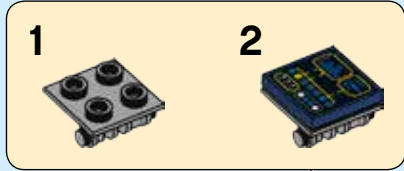

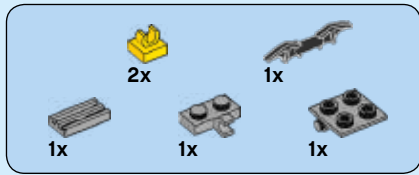

9

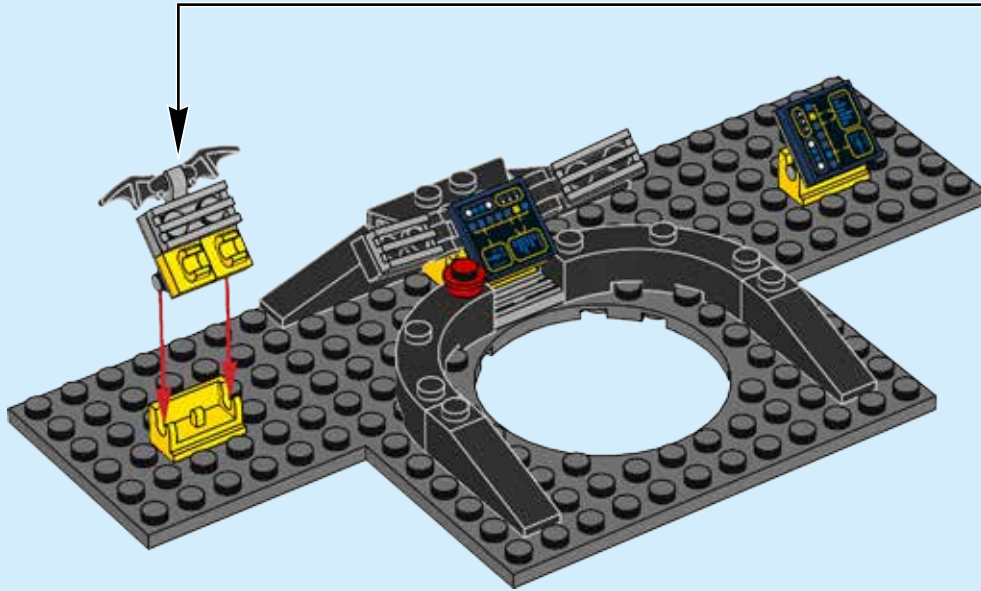
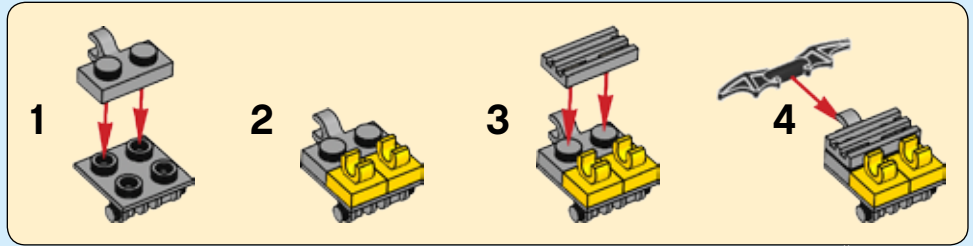

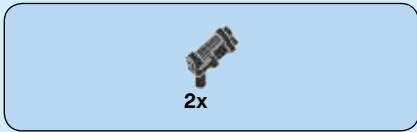

10

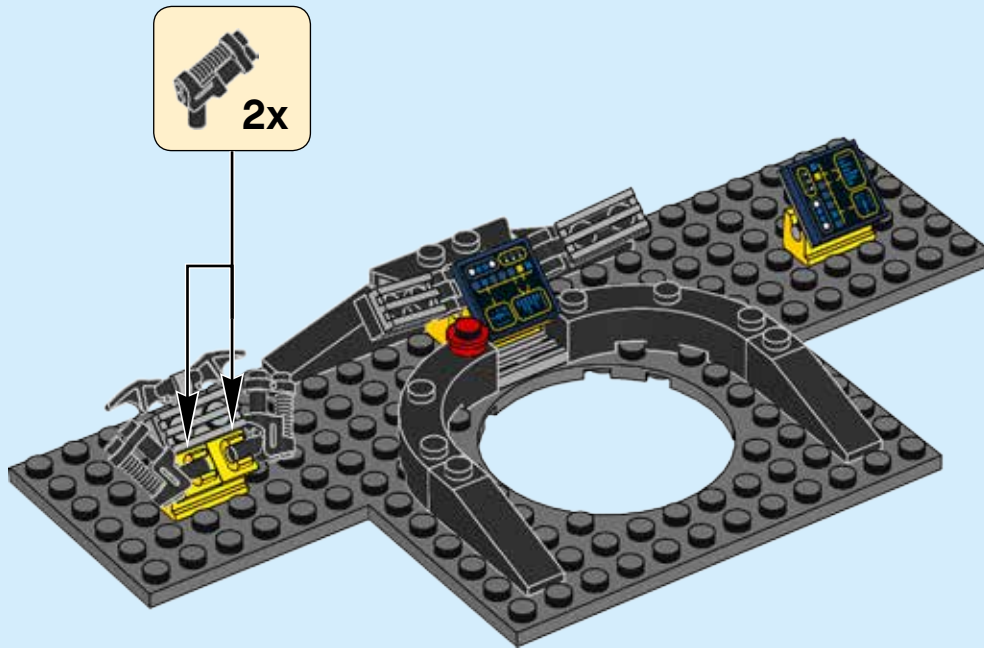

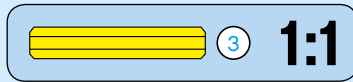
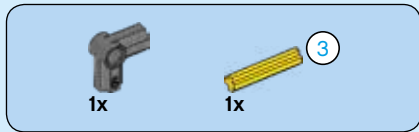

11

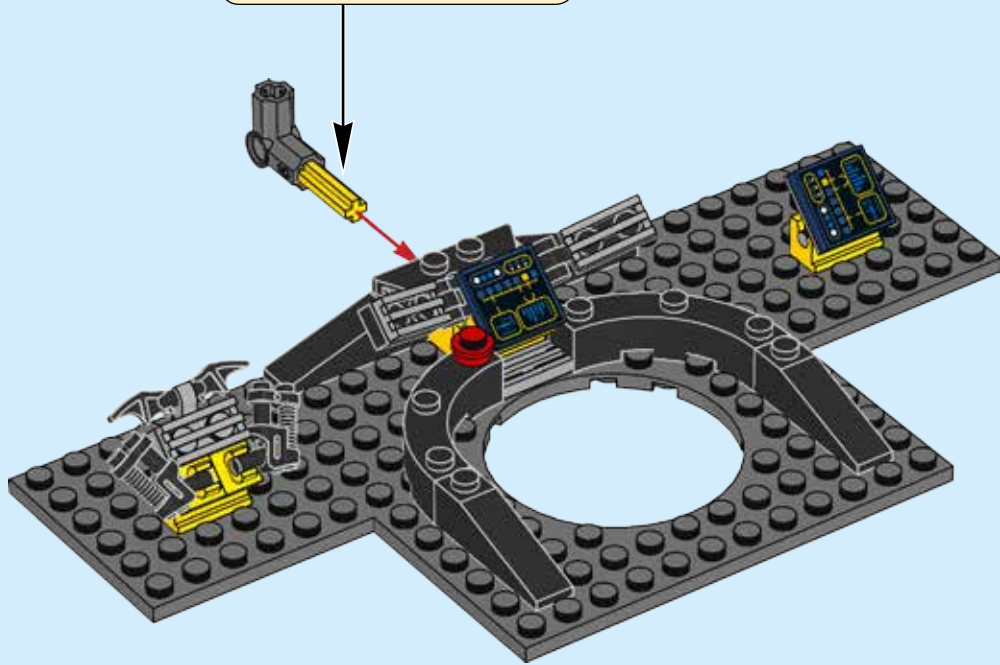
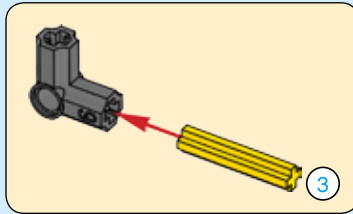

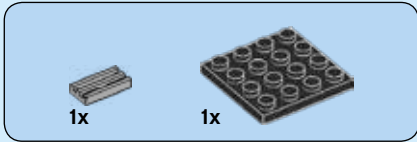
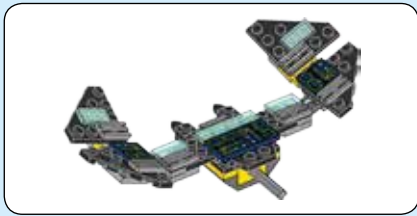

12

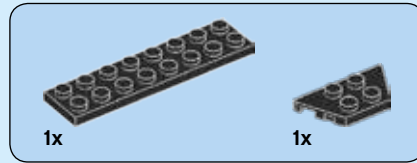
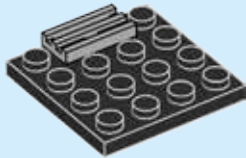

13

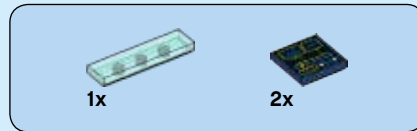
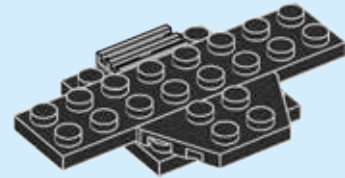

14

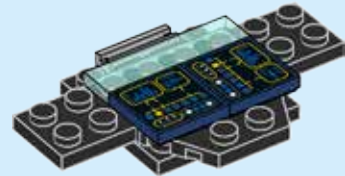



2x



2x

15

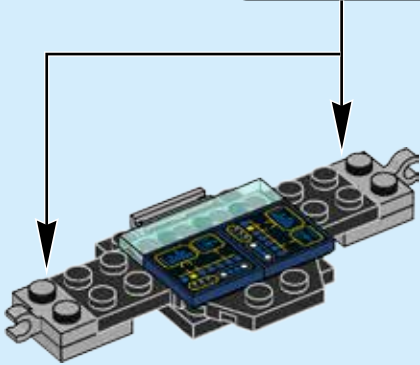
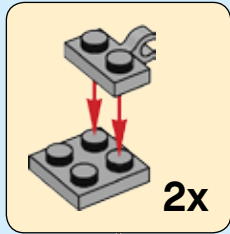

2x



2x

16

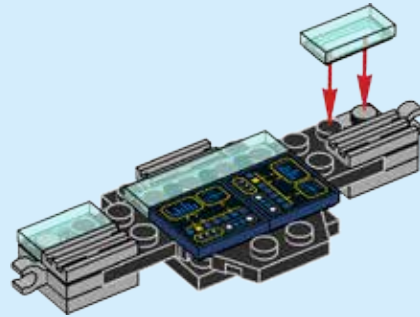

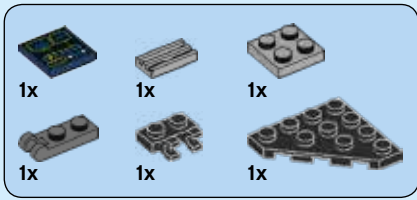

17

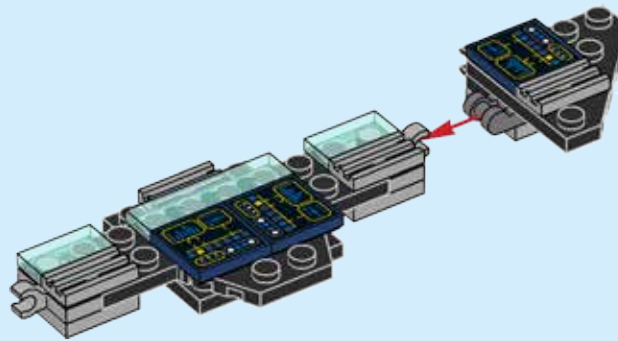
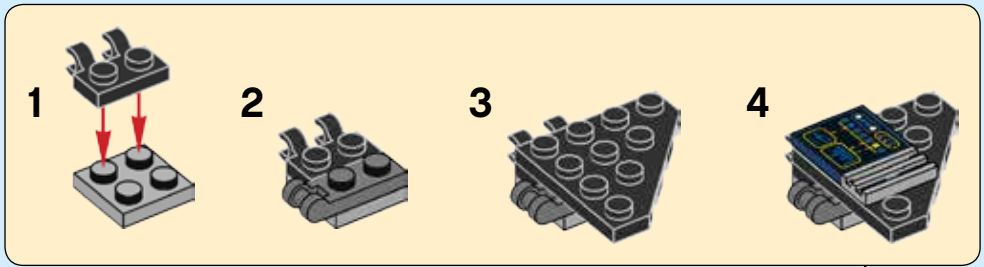

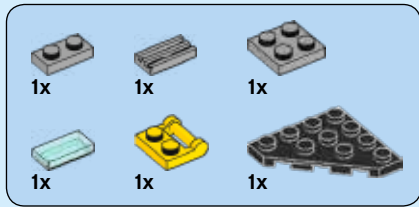

18

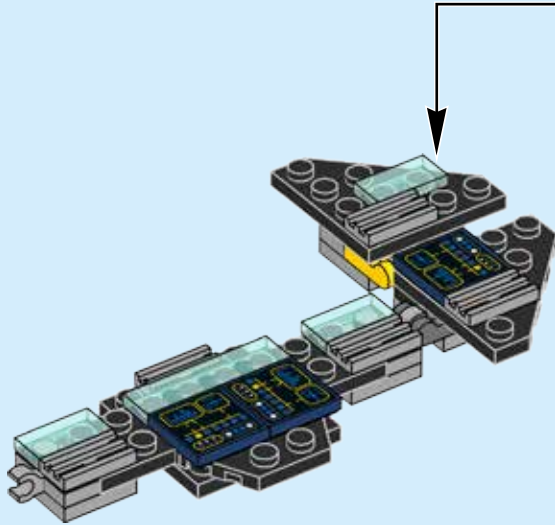
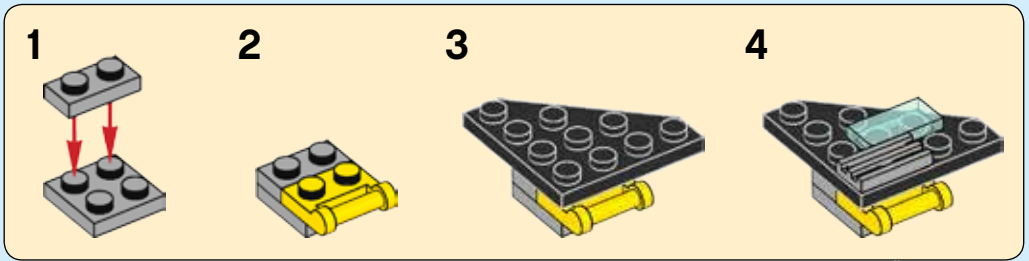

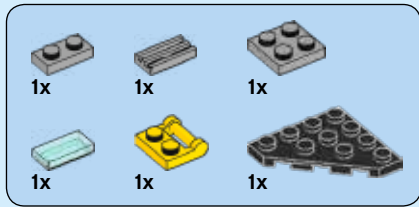

20

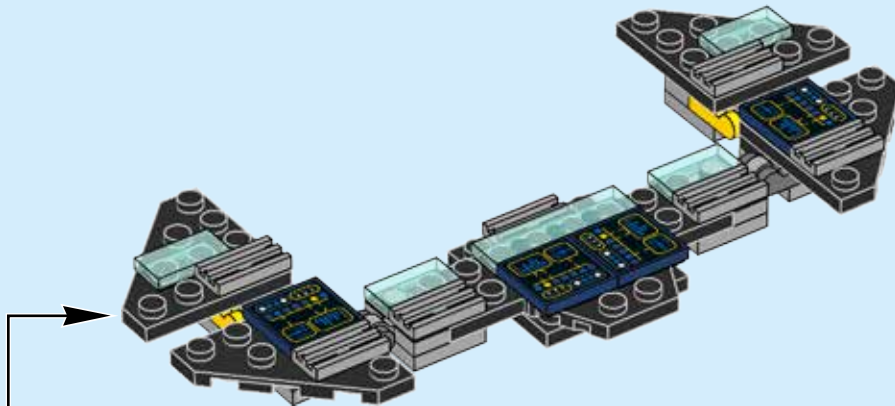
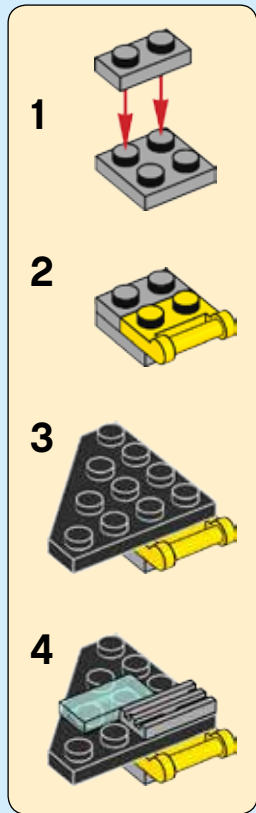



2x

21

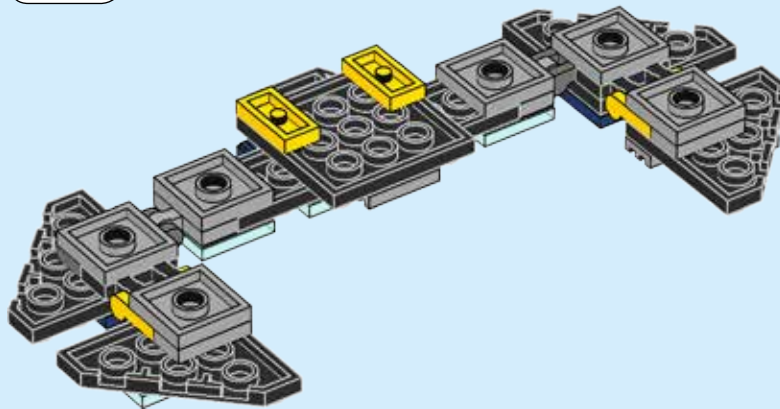
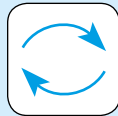

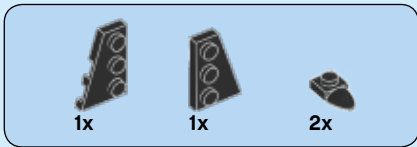

23

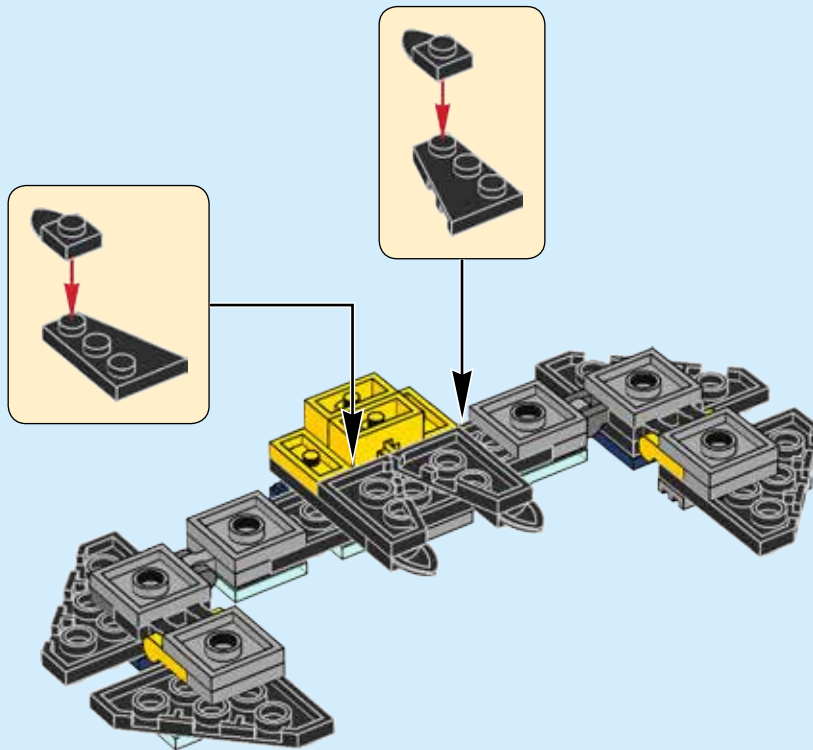

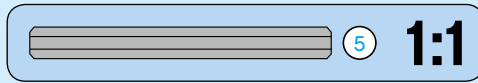
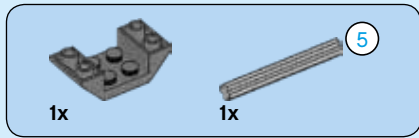

24

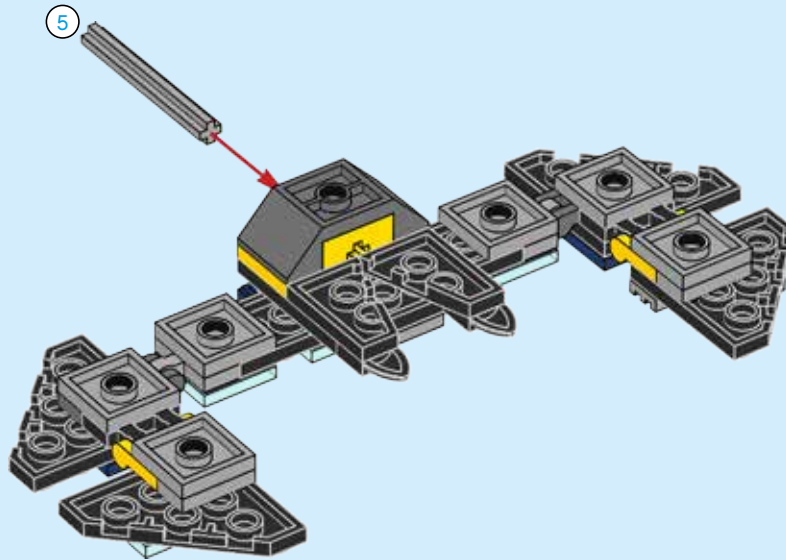

25

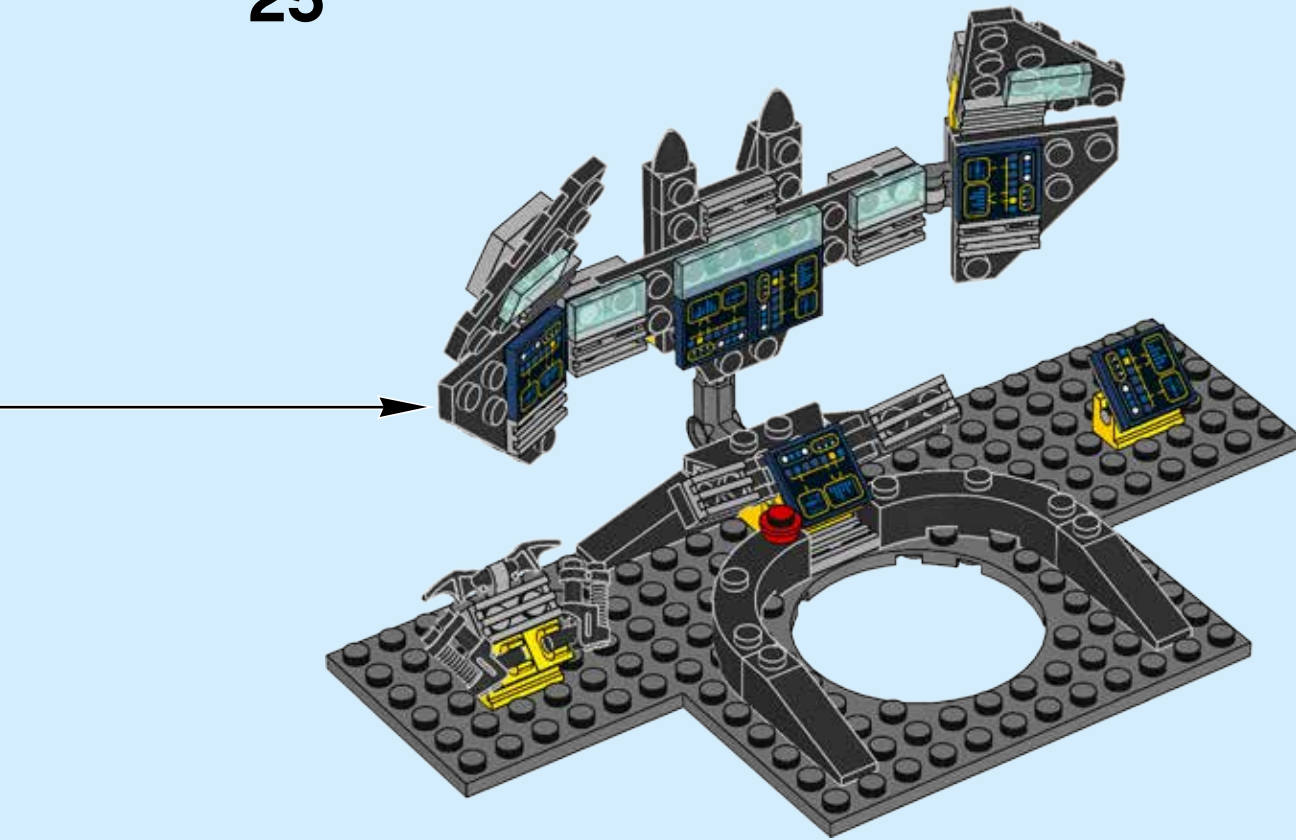



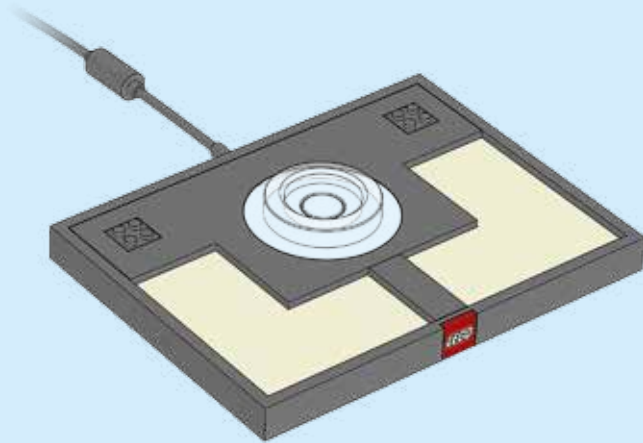

Start game
Commence le jeu
Iniciar juego

**Download the latest game
content to use this character**

**Télécharge le contenu le plus
récent du jeu pour utiliser ce
personnage**

**Descarga la última actualización
de contenido para usar este
personaje**

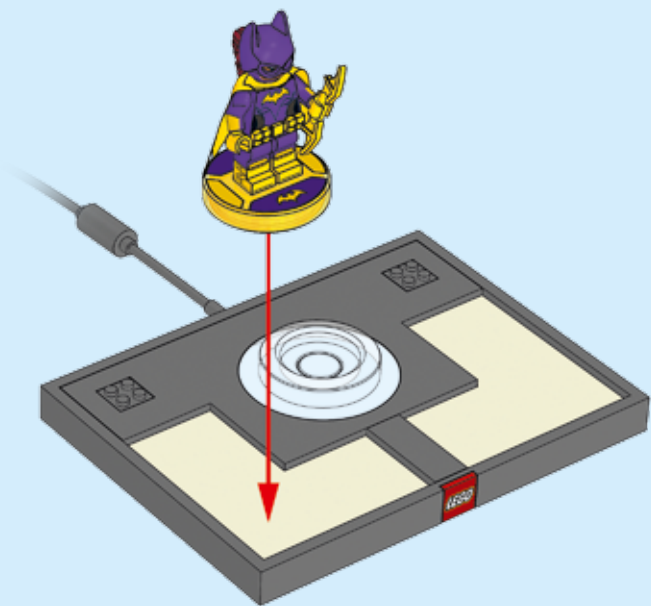



- **Building is part of playing the game**
- **La construction fait partie du déroulement du jeu**
- **Construir forma parte del juego**



DIMENSIONS™

LEVEL PACKS
ENSEMBLES NIVEAUX
PACKS DE NIVELES



71203



71204



71228



71235



DIMENSIONS™

LEVEL PACKS ENSEMBLES NIVEAUX PACKS DE NIVELES



71244



71245



71248



71267



DIMENSIONS™

TEAM PACKS
ENSEMBLES ÉQUIPES
PACKS DE EQUIPOS



71205



71206



71207



71229



DIMENSIONS™

TEAM PACKS
ENSEMBLES ÉQUIPES
PACKS DE EQUIPOS

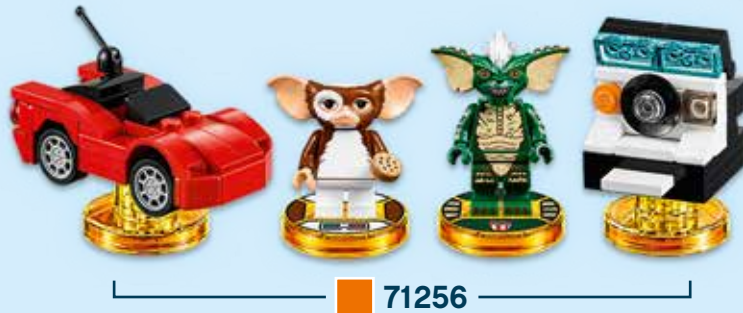



DIMENSIONS™

STORY PACKS
PACKS D'HISTOIRE
PAQUETES DE HISTORIA

GHOSTBUSTERS



71242

FROM J.K. ROWLING'S
WIZARDING WORLD

FANTASTIC BEASTS

AND WHERE
TO FIND THEM



71253



DIMENSIONS™

FUN PACKS
ENSEMBLES AMUSANTS
PACKS DE DIVERSIÓN



71230



71233



71234



71236



71237



71238



71239



71240



71241



DIMENSIONS™

FUN PACKS
ENSEMBLES AMUSANTS
PACKS DE DIVERSIÓN



71251



71257



71258



71285



71286



71344



Customer Service
Service Consommateurs
Servicio Al Consumidor
LEGO.com/DIMENSIONS/service

CHEAT CODES

GO TO LEGO.COM/DIMENSIONSfeedback AND
GIVE US YOUR SHORT **FEEDBACK** ABOUT THIS
LEGO® VIDEO GAME TO UNLOCK
AWESOME CHEAT CODES.



Terms & Conditions apply

LEGO.com/DIMENSIONSfeedback

GEHEIM-CODES

Geh auf LEGO.com/DIMENSIONSfeedback und verrate uns deine Meinung zu diesem LEGO® Videospiel, um tolle Geheim-Codes freizuschalten.

Es gelten die Nutzungsbedingungen.

COUPS DE POUCE

Rendez-vous sur LEGO.com/DIMENSIONSfeedback pour évaluer ce jeu vidéo LEGO® et débloquent de super coups de pouce !

Offre soumise à conditions.

CHEATCODES

Ga naar LEGO.com/DIMENSIONSfeedback, schrijf een kort commentaar op deze LEGO® video game en ontvang coole cheatcodes.

Er zijn algemene voorwaarden van toepassing.

CÓDIGOS DE TRUCOS

Visita LEGO.com/DIMENSIONSfeedback y envíanos una breve opinión sobre este videojuego LEGO® para desbloquear asombrosos códigos de trucos.

Sujeto a términos y condiciones.

LEGO and the LEGO logo are trademarks of the/son des marques de commerce du/son marcas registradas de LEGO Group. ©2017 The LEGO Group.

6210600