



TECHNIC™

42101



1



2

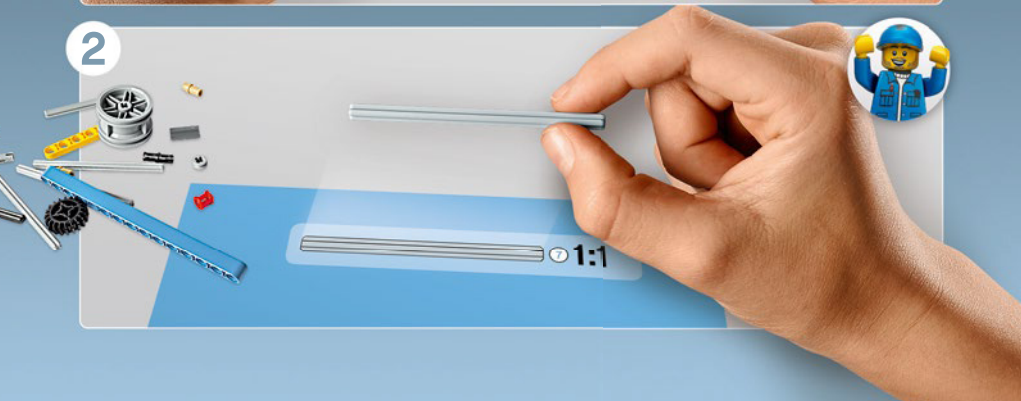

1:1



- 1** Scan the code on the front cover
Scanne den Code auf der Titelseite
Scanne le code sur la page de couverture
Scanner le code sur la page couverture
Scansiona il codice sulla copertina
Escanea el código de la portada
Faz scan do código na frente da capa
Olvasd be a borítón látható kódot!
Noskenë kodu uz priekšējā vāka
扫描封面上的二维码



- 2** Get Instructions PLUS
Hol dir Instructions PLUS
Obtiens les instructions PLUS
Obtenir les Instructions PLUS
Scarica Instructions PLUS
Descubre Instructions PLUS
Obtém Instruções PLUS
Szerezd be az Instructions PLUS
kiegészítőt!
Saņem "Instructions PLUS"
获取更多说明

LEGO.com/apps

Check for compatibility
Kompatibilität prüfen
Vérifier la compatibilité
Controlla la compatibilità
Comprueba tu compatibilidad

Verificar a compatibilidade
Ellenőrizd a kompatibilitást
Pārbaudīt saderību
检查兼容性

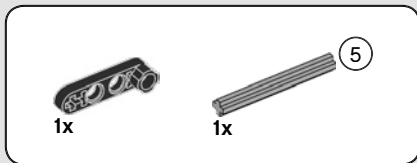

1

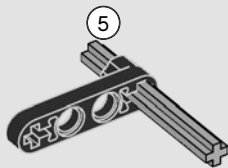

4

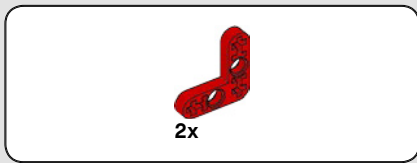
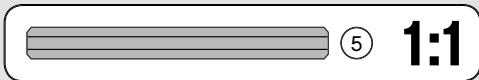

2

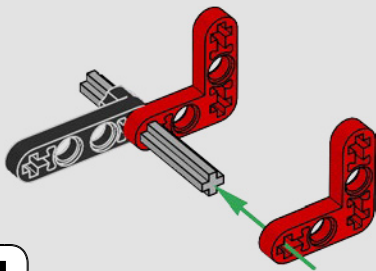



1x



1x

4

3

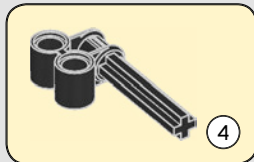

4

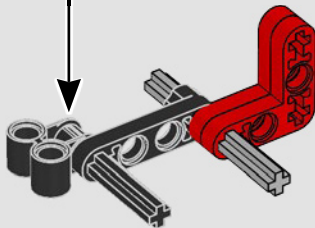

4

1:1



1x

4

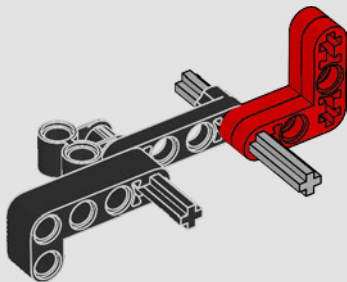

5



1x

6

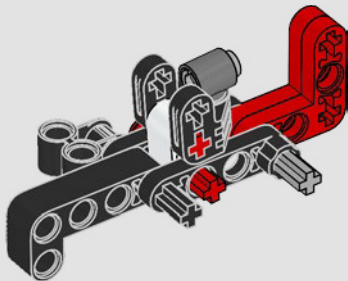

1x

7

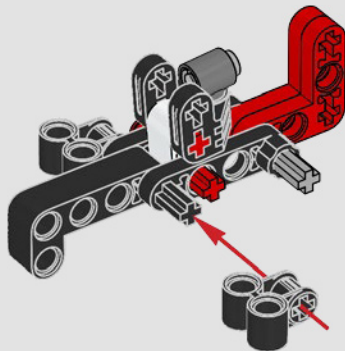

7

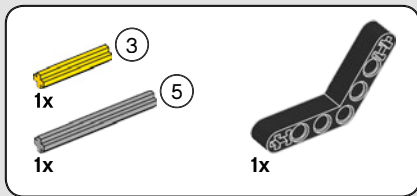

8

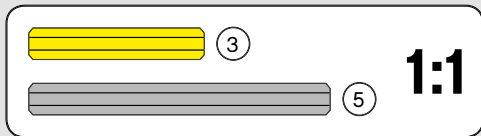
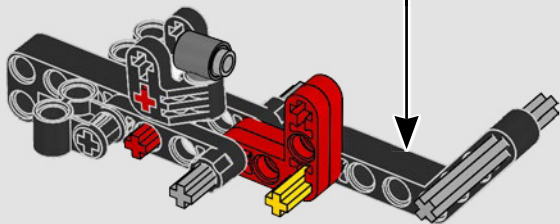
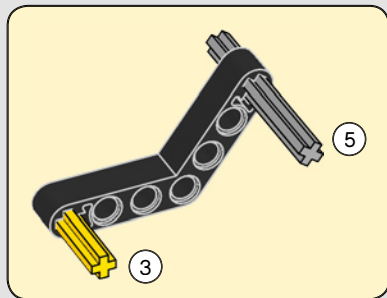

8

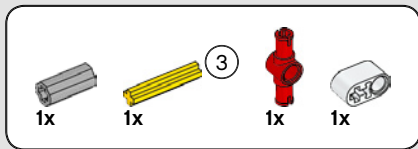

9

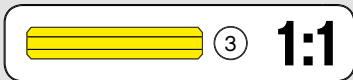
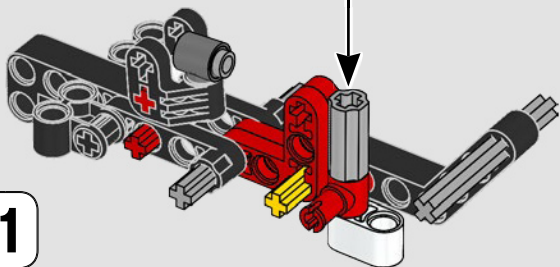
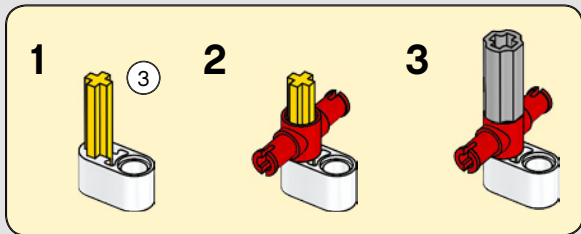

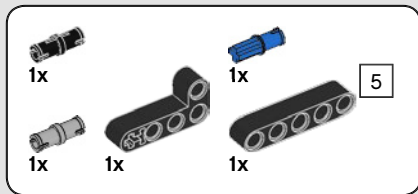

10

1



2

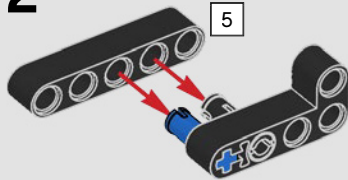

3

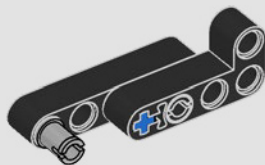

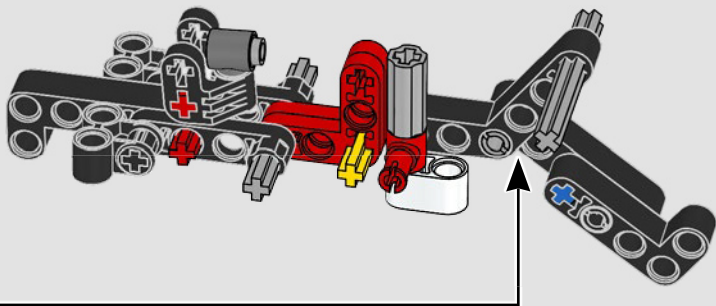



11

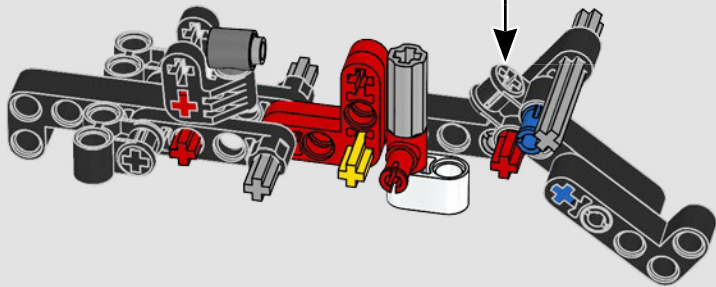
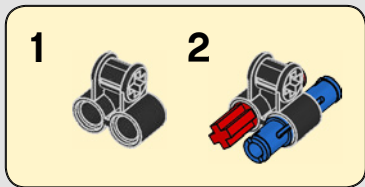

12

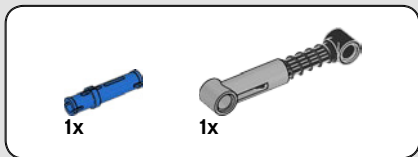

12

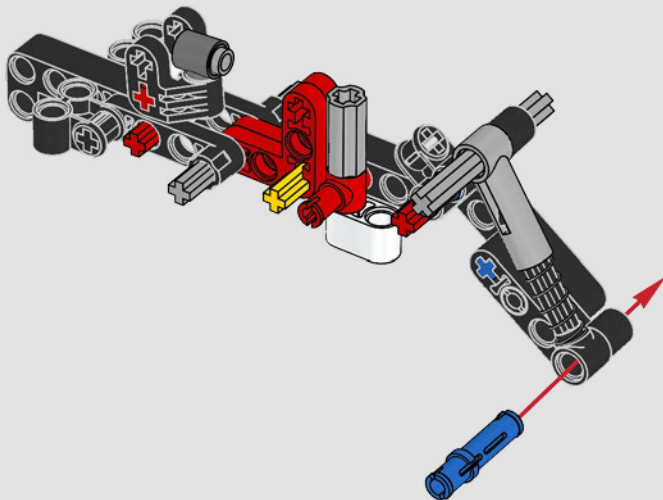

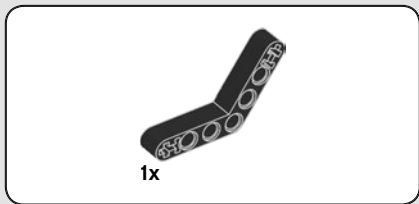

13

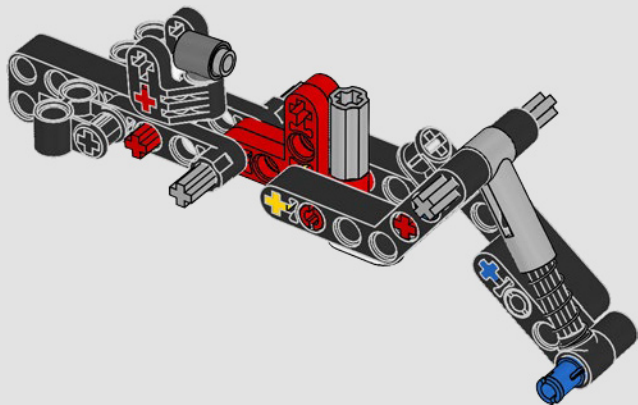

14

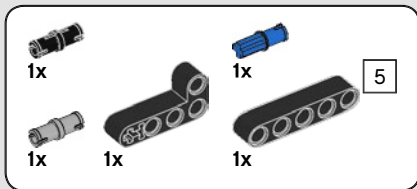

14

1

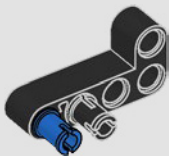

2

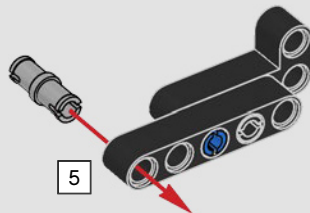

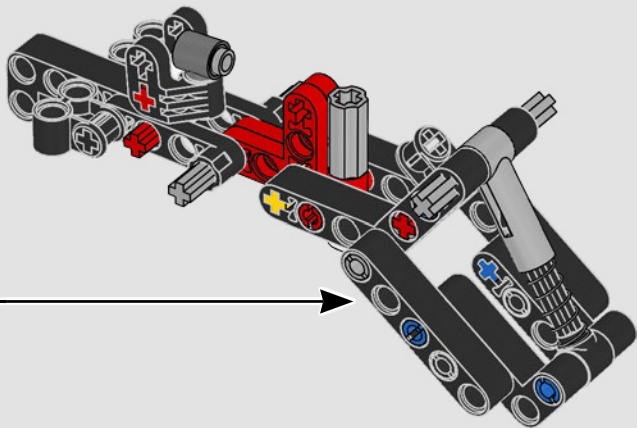



2x



1x



1x

15

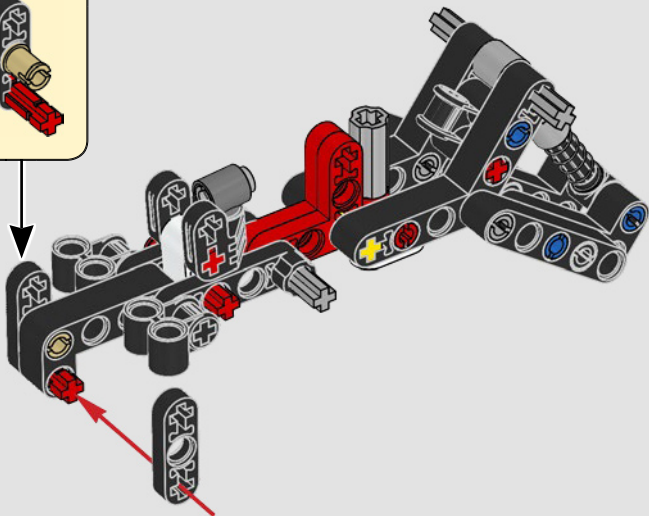
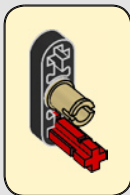

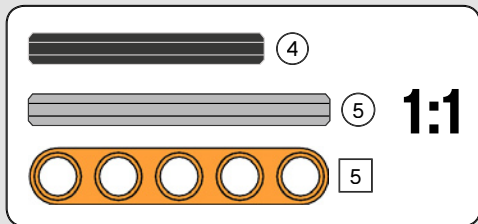
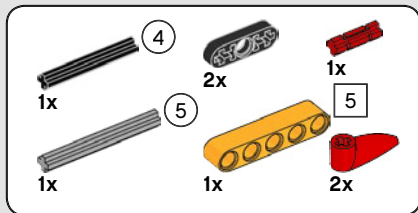

16

1

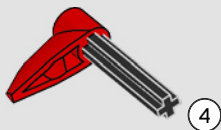

2

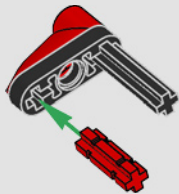

3

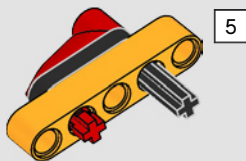

4

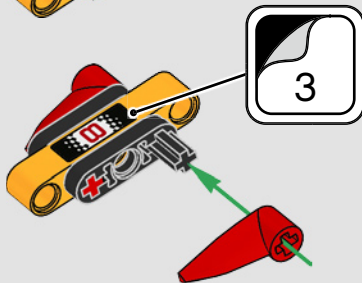

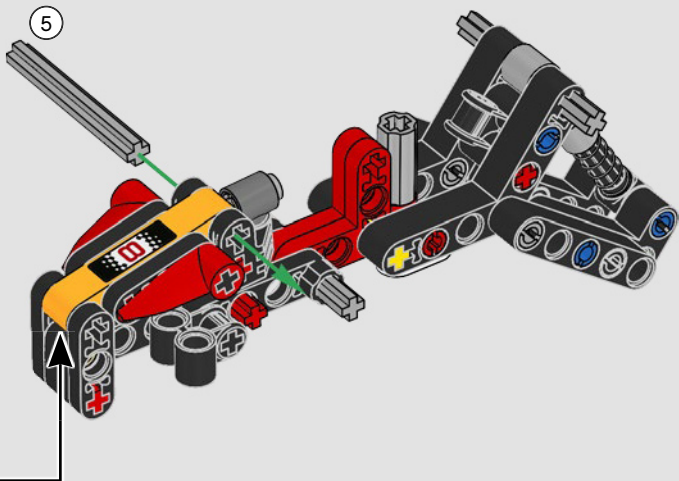

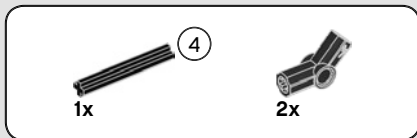

17

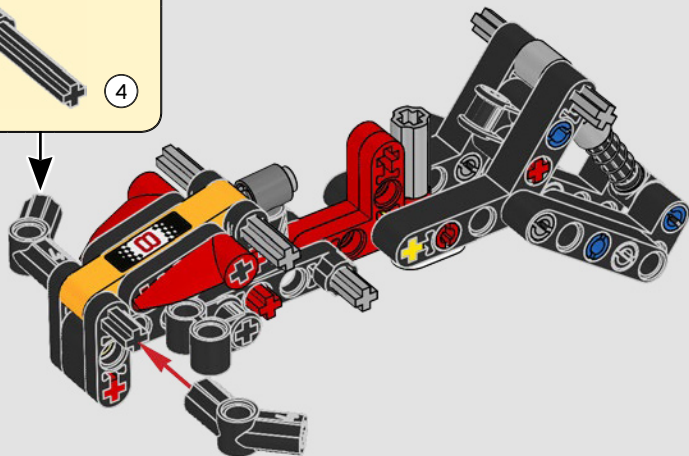
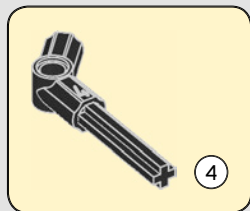



2x



1x

18

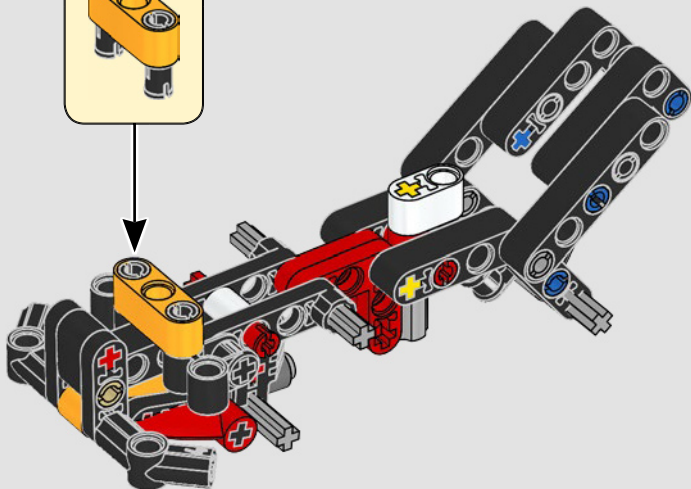
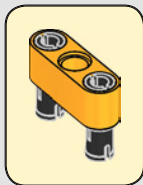

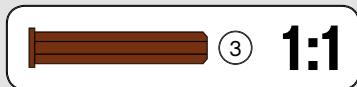
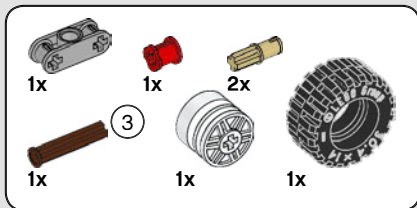

19

1

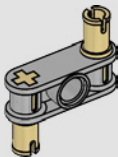

2

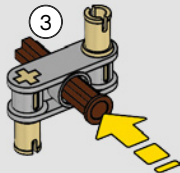

3

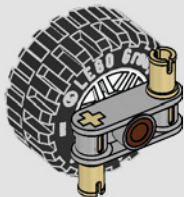

4

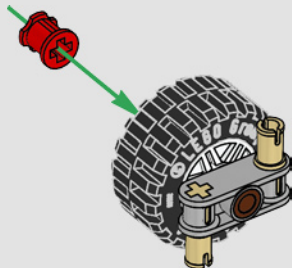

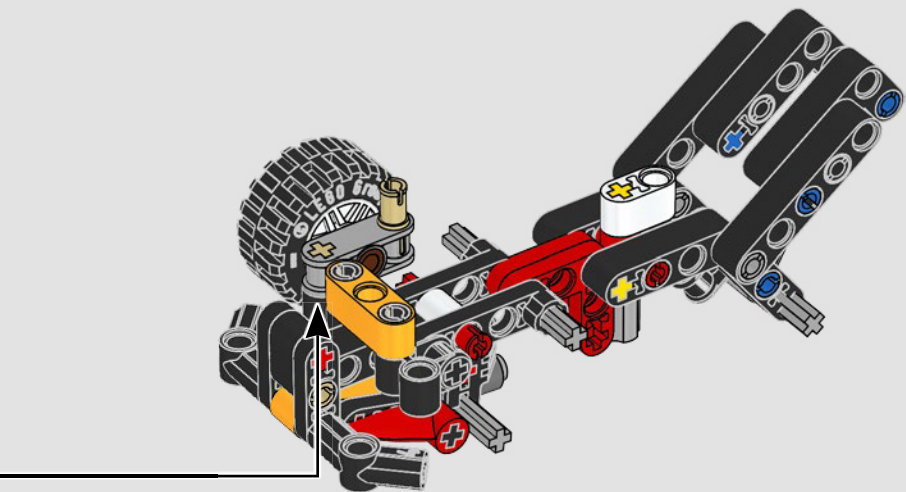

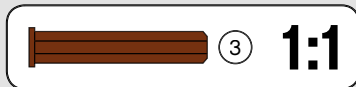
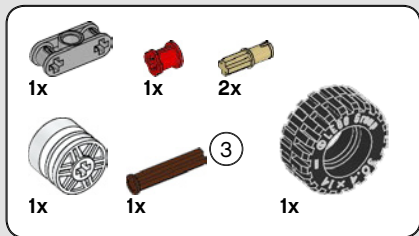

20

1

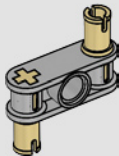

2

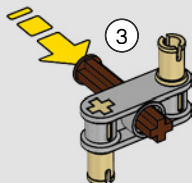

3



4



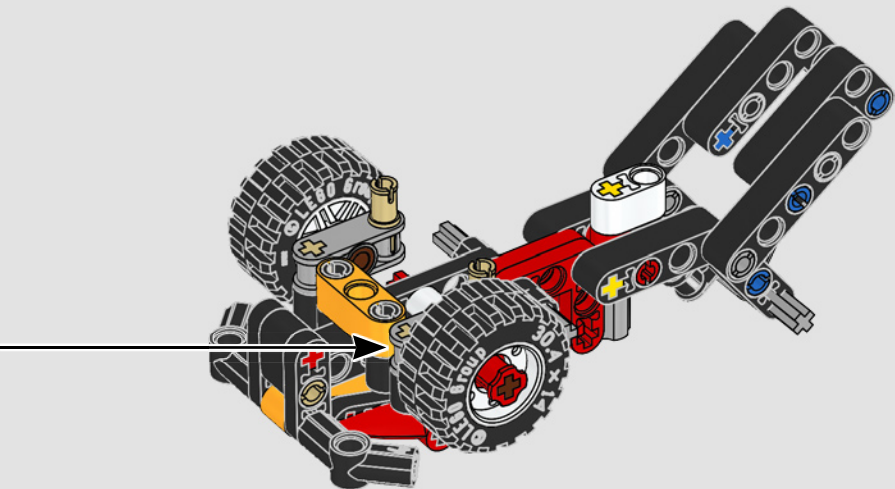

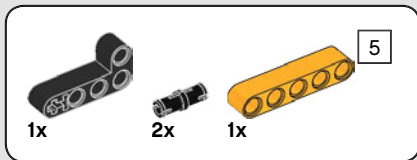

21

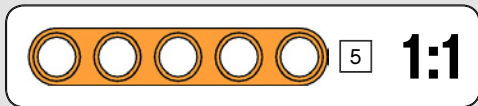
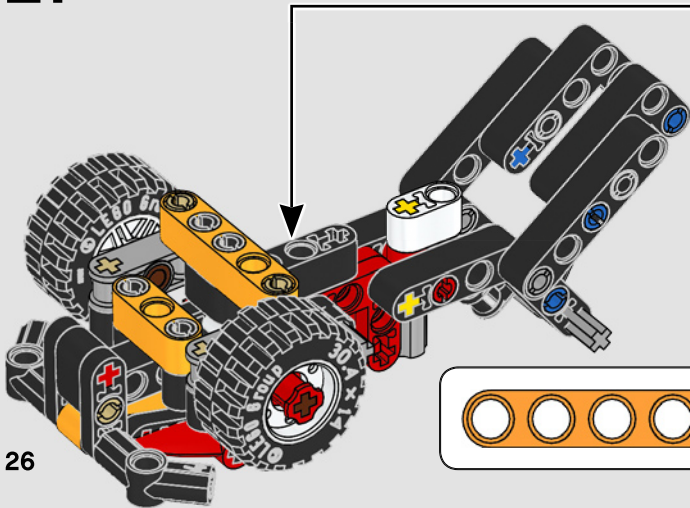
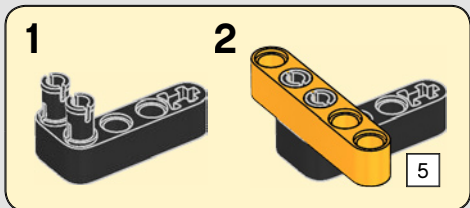



22

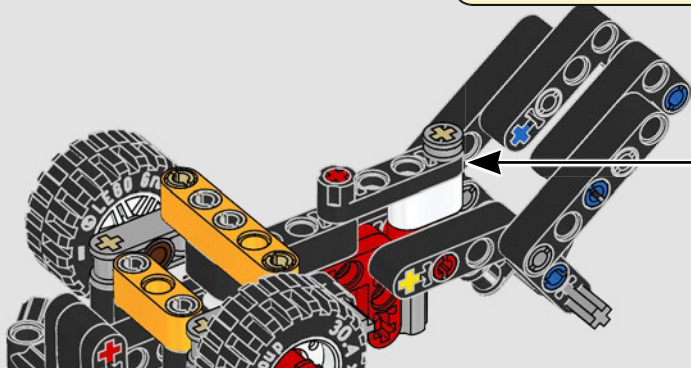
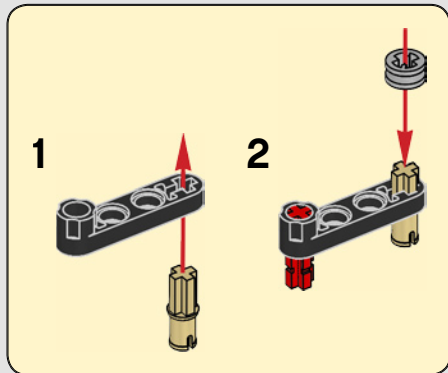

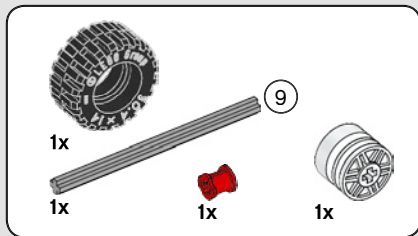

23

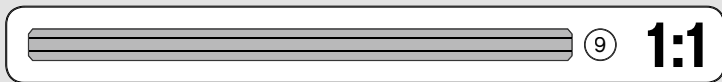
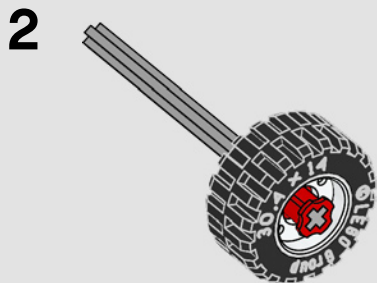
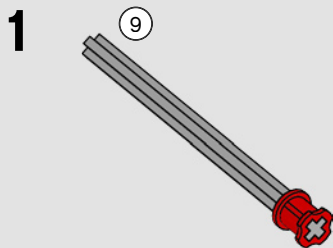

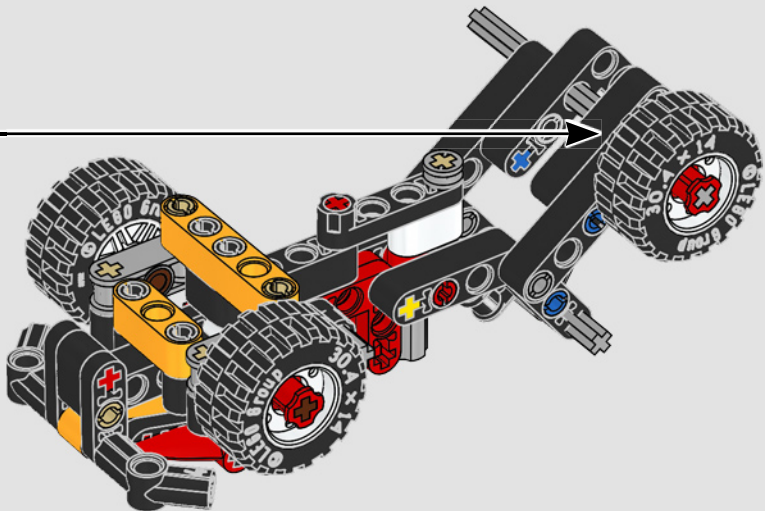

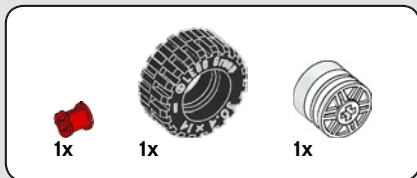

24

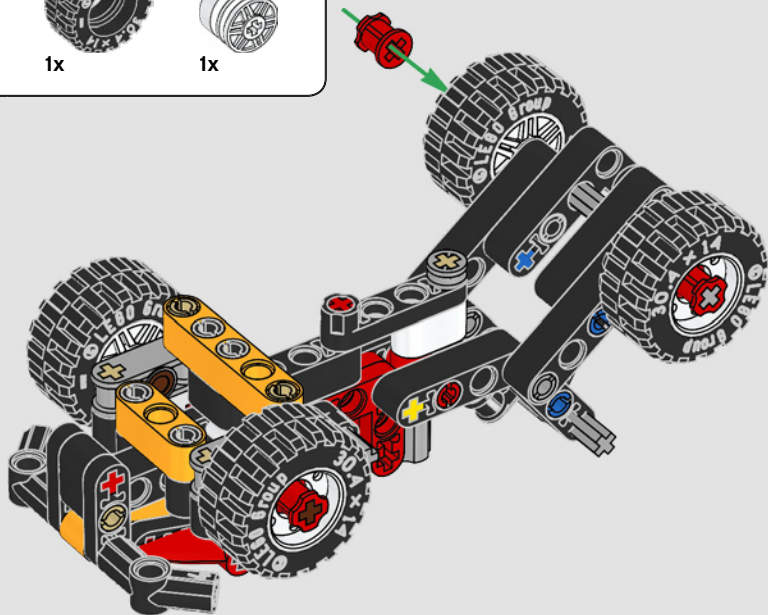

30

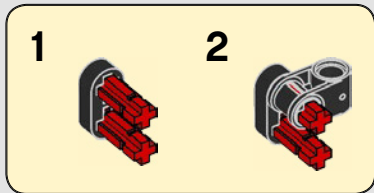

25

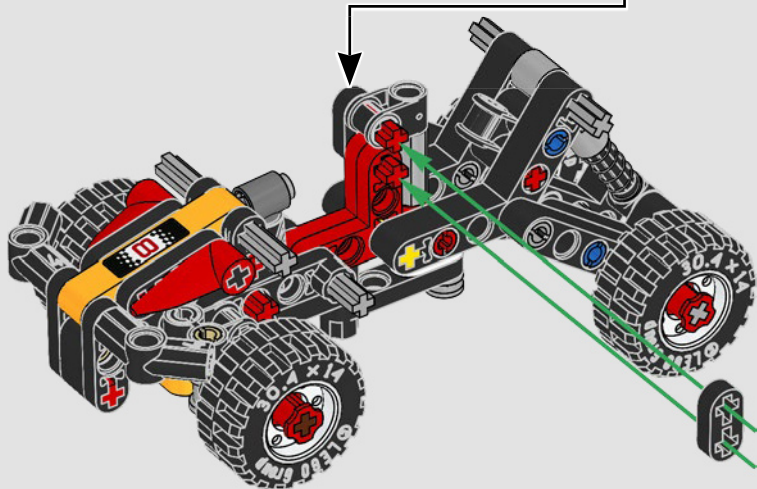



1x

26

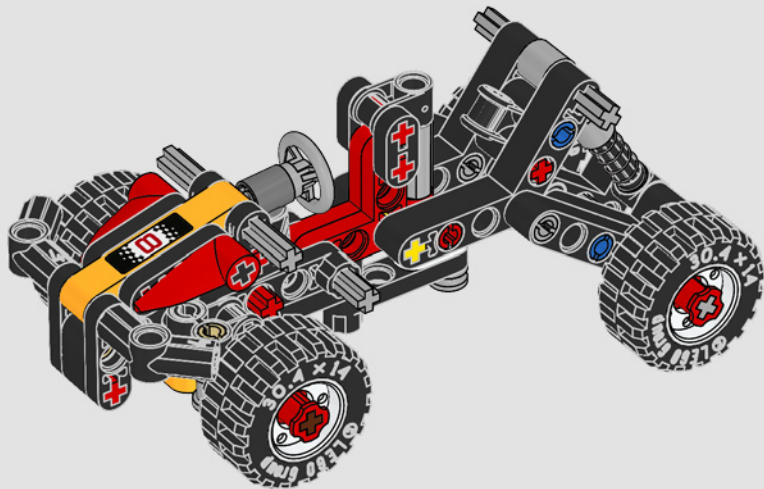

32

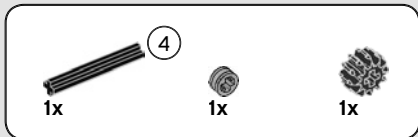

27

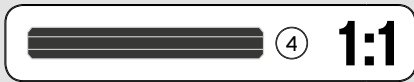
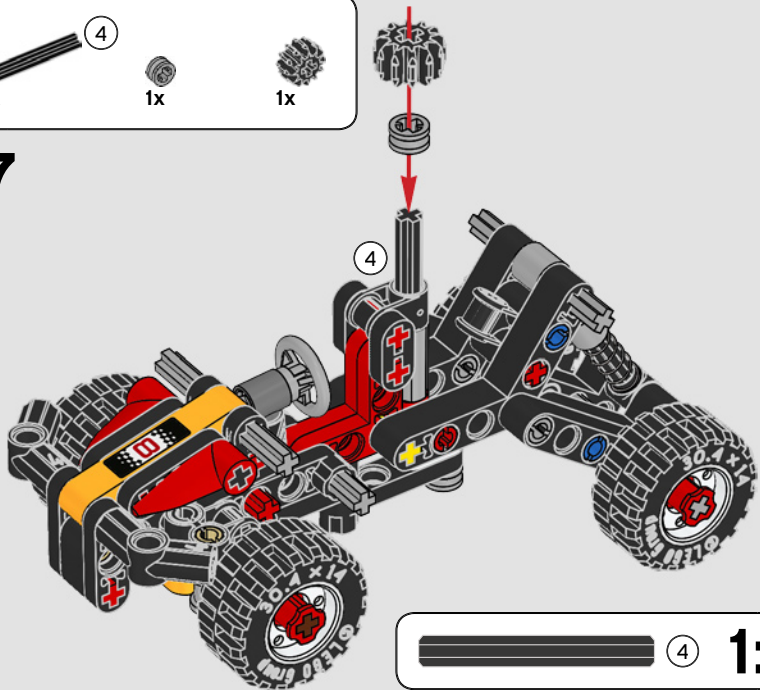

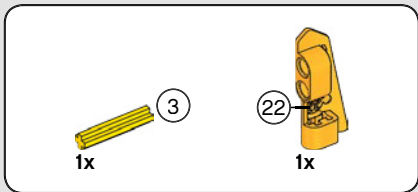
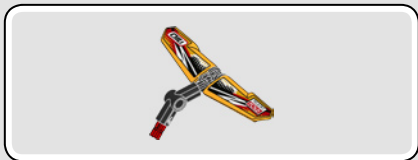

28

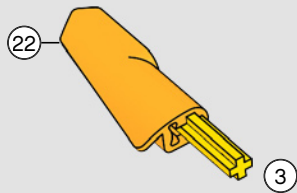

34

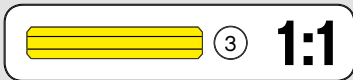



1x

29

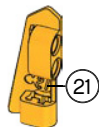
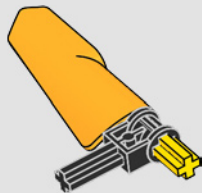

1x

30

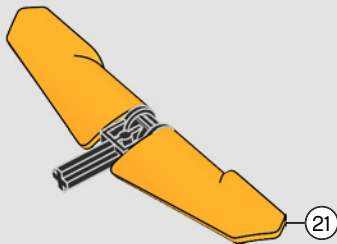



1x



1x

31

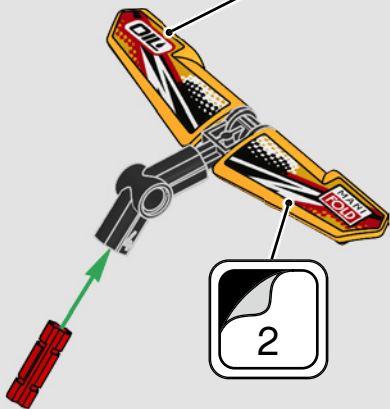

32

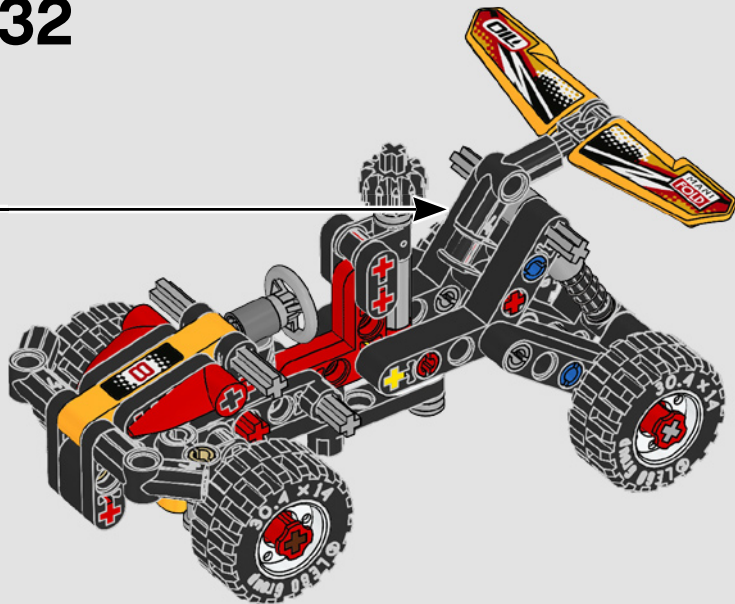

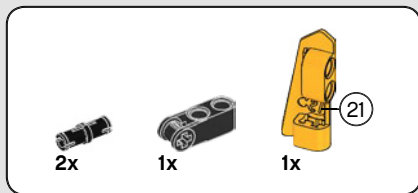

33

1

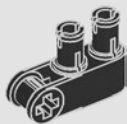

2

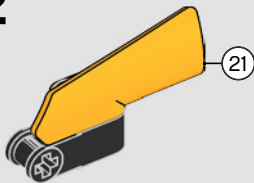

3

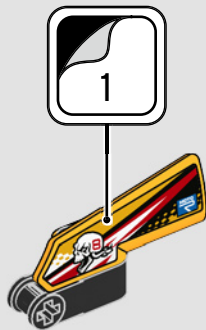

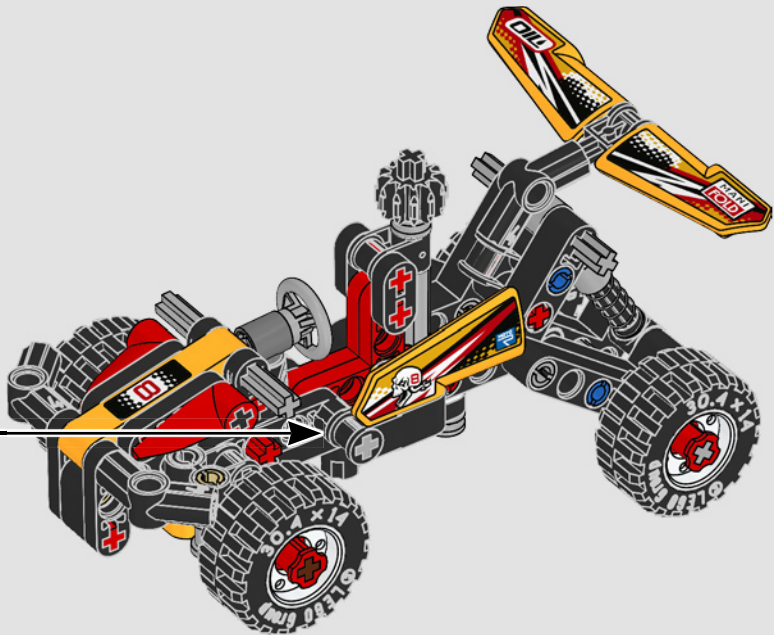

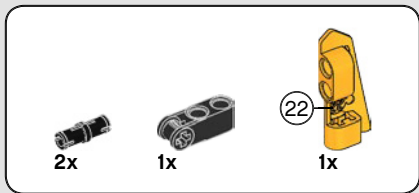

34

1



2



3

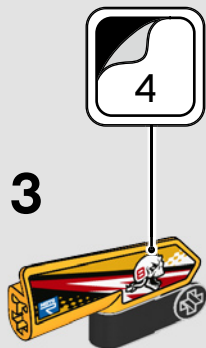

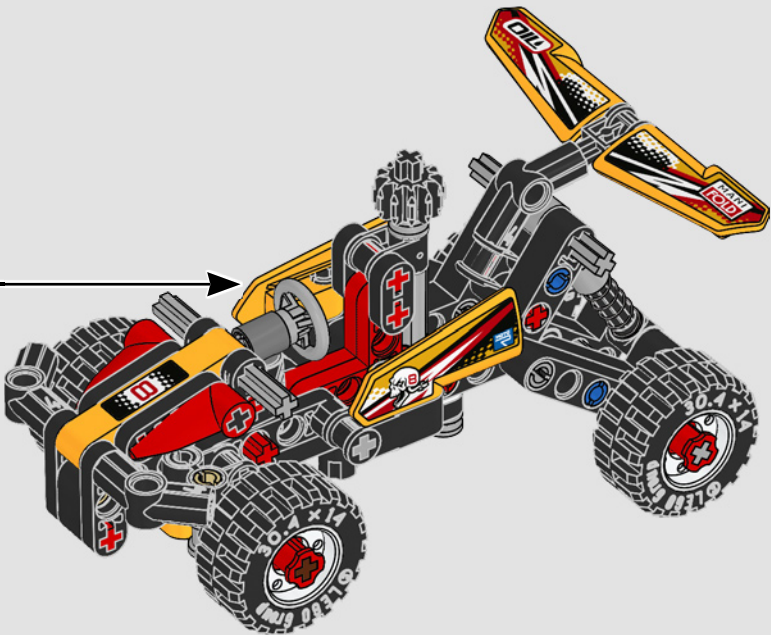

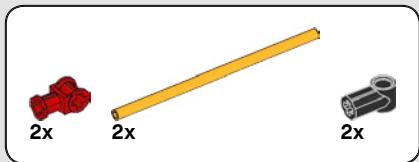

35

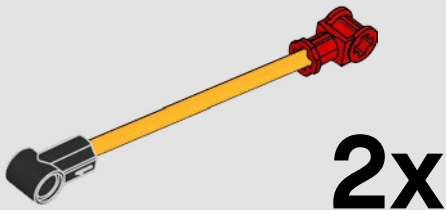

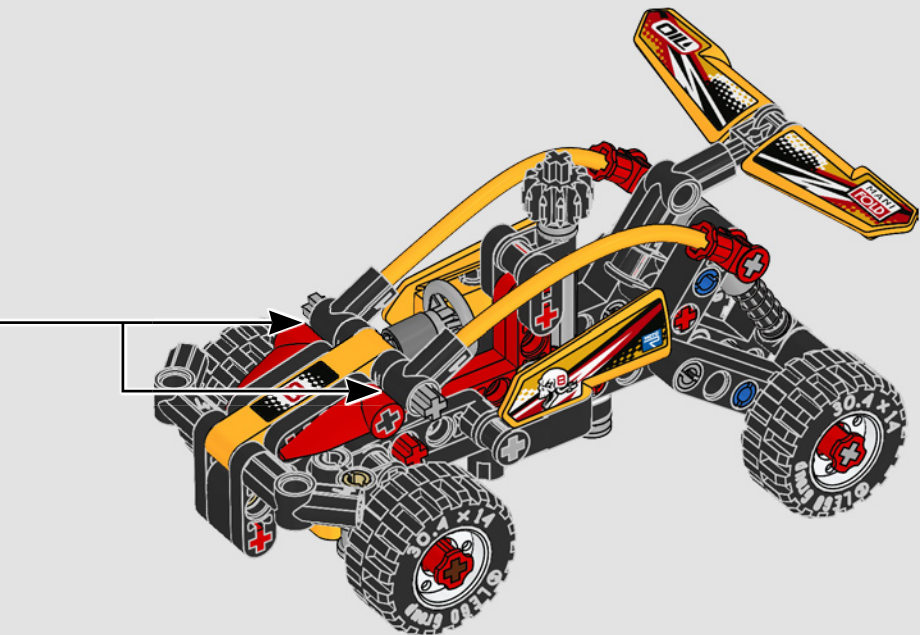



2x

36

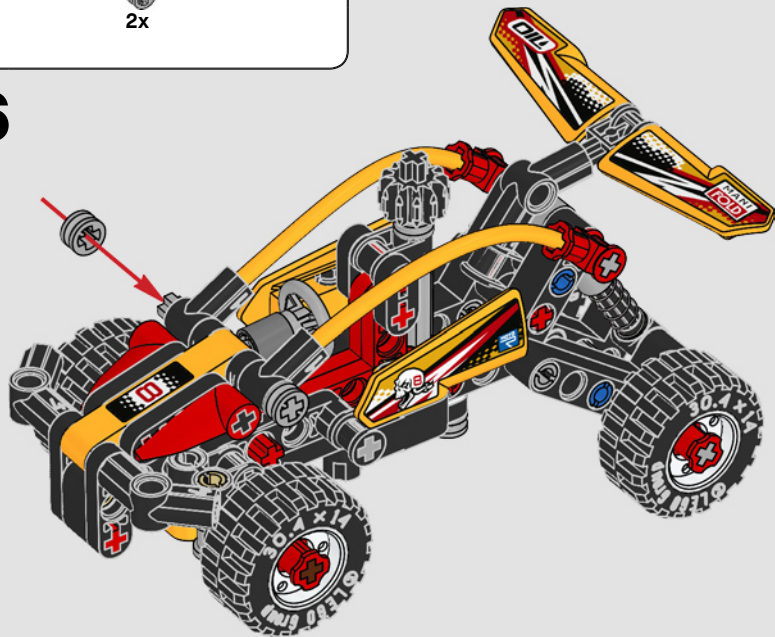

44



ManagerExcellentCrocodile



KingBummyCheetah



PrincessBossyRooster

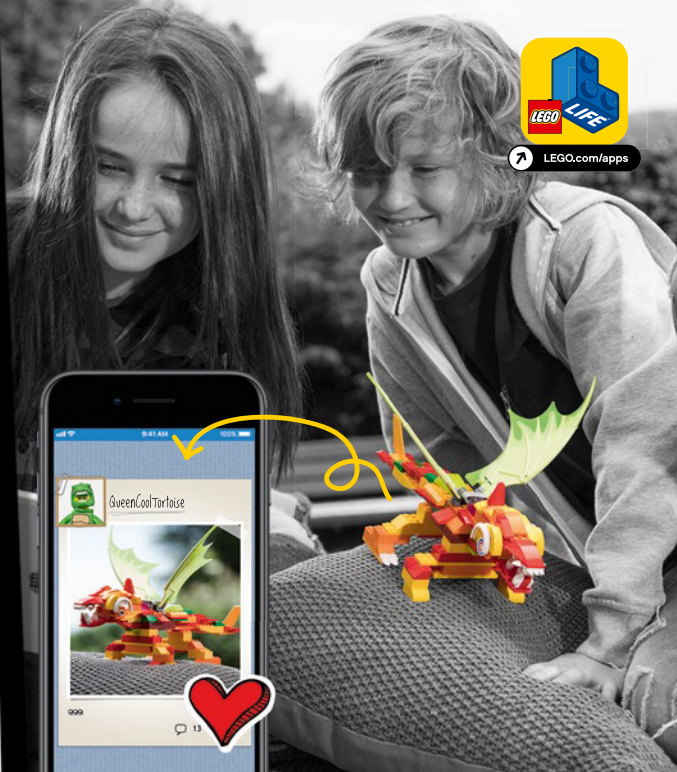

LEGO.com/apps



LEGO **TECHNIC**



42106



42104



42101



42102



42103

CLAAS

The trademarks CLAAS, XERION and the corresponding colour trademarks are owned by CLAAS KGaA mbH. They are used by LEGO System A/S under license.



Customer Service
Kundenservice
Service Consommateurs
Servicio Al Consumidor

LEGO.com/service or dial



WIN

GO TO WWW.LEGO.COM/PRODUCTFEEDBACK AND
GIVE US YOUR SHORT **FEEDBACK** ABOUT THIS
LEGO® SET FOR A CHANCE TO WIN
A COOL LEGO PRIZE.

Terms & Conditions apply



LEGO.com/productfeedback

GEWINNE

Erzähle uns auf
www.LEGO.com/productfeedback

etwas über die Erfahrungen, die du
mit diesem LEGO® Set gemacht hast,
und sichere dir die Chance auf einen
coolen LEGO Preis!

Es gelten die Teilnahmebedingungen

GAGNE

Rends-toi sur
www.LEGO.com/productfeedback

et donne-nous quelques commen-
taires sur ce produit LEGO® pour
avoir une chance de gagner un
prix LEGO !

Voir Conditions Générales

GANAN

Visita
www.LEGO.com/productfeedback

y envíanos tu opinión acerca de este
set LEGO®. ¡Participarás en el sorteo
de un premio LEGO!

Términos y Condiciones aplicables

获取奖品

登录
www.LEGO.com/productfeedback

给出关于此乐高®套装的简短反
馈，就有机会获得炫酷乐高奖品

《条款及条件》适用

LEGO and the LEGO logo are trademarks of the/sont des marques de commerce du/son marcas registradas
de LEGO Group. ©2020 The LEGO Group.

6306671/6306672