



40385



1



2



3



4



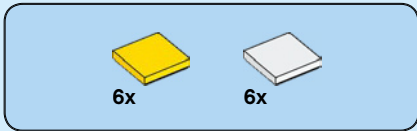

1

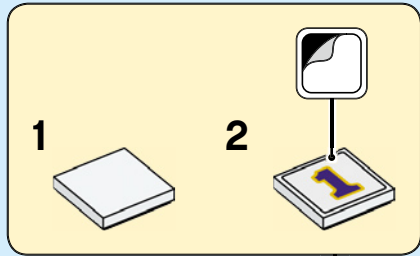

3

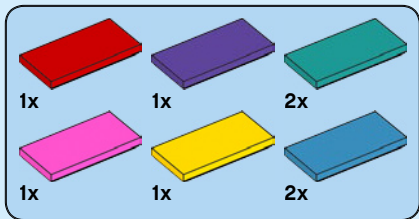

2

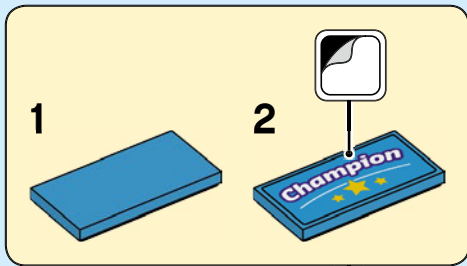

4

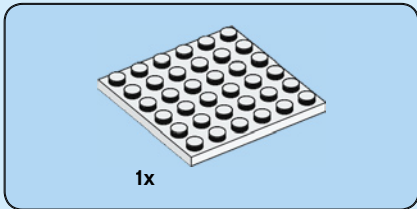

1

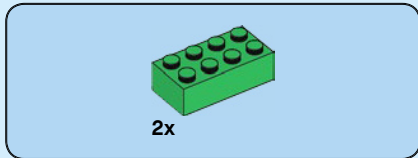
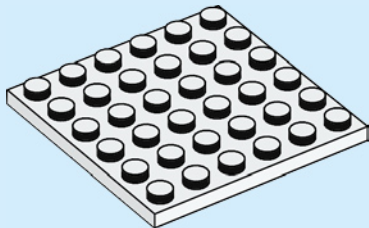

2

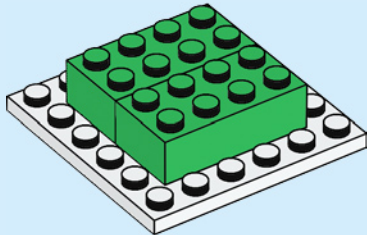

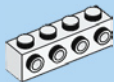

4x

3

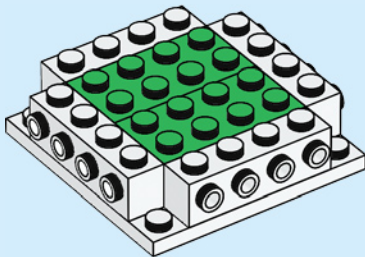

6



4x

4

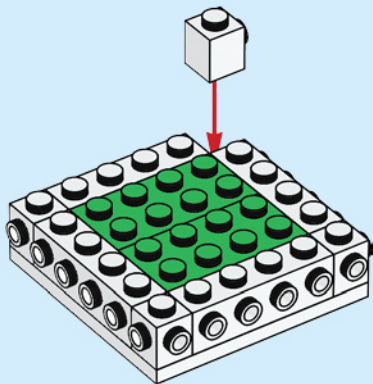

4x



4x

5

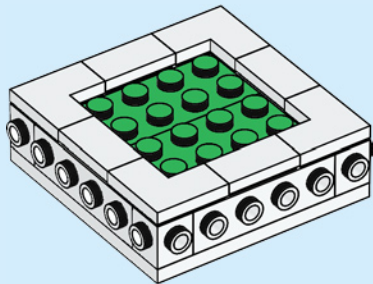



4x



8x

6

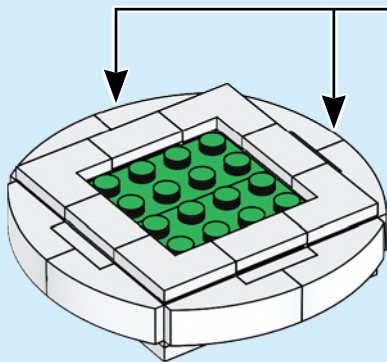

1

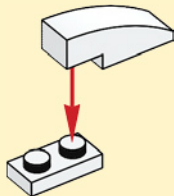

2

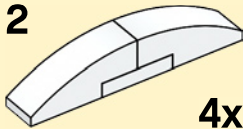

4x





1x

7

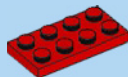
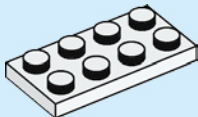

2x

8

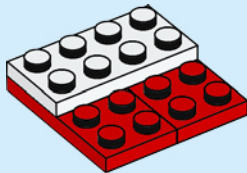



2x

9

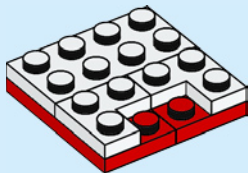

10

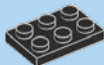

1x



2x

10

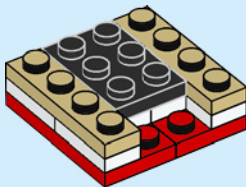



3x



1x

11

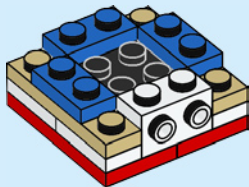

4x

12

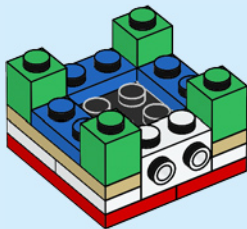



3x

13

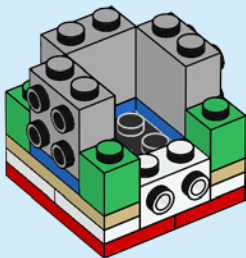

12



2x

14

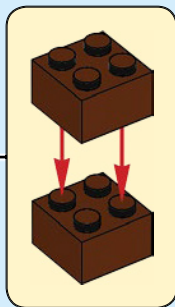
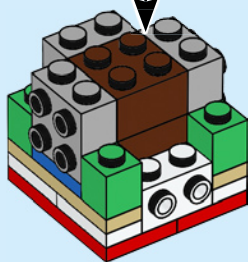



4x



1x

# 15

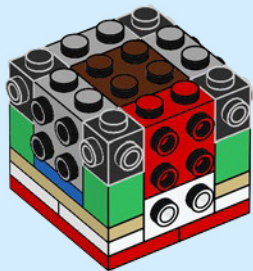

14



1x



2x

# 16

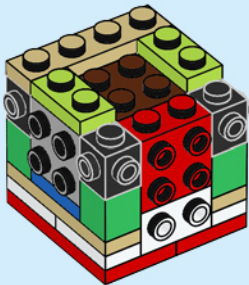



2x



1x

17

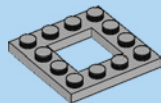
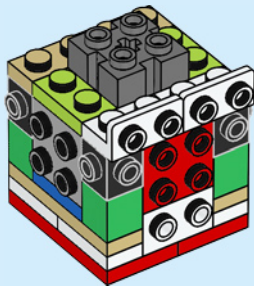

1x

18

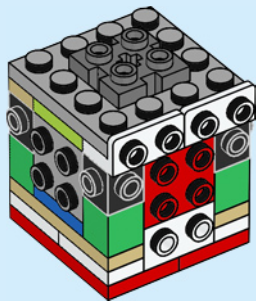



4x

19

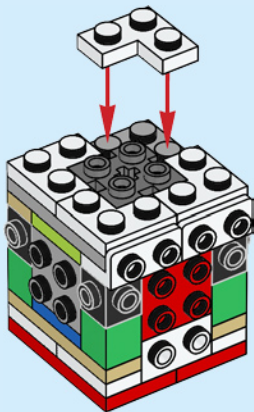



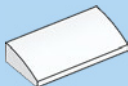

6x

20

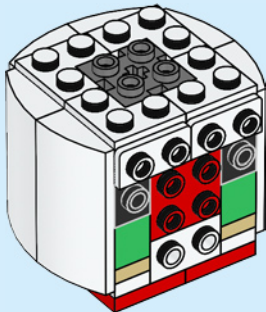

1x

21

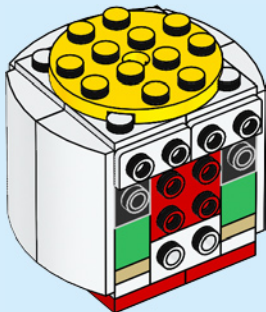



2x



2x

22

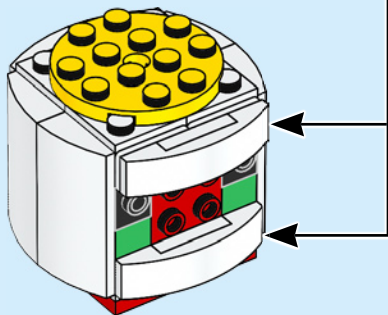
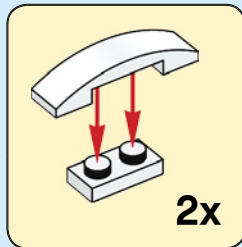

23



24

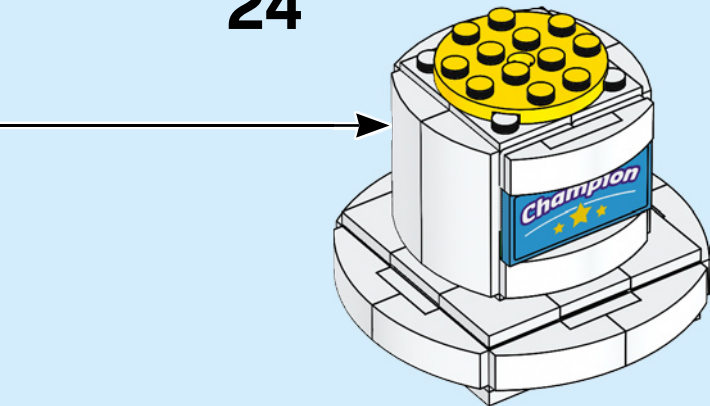

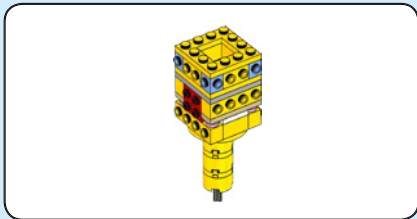

**25**

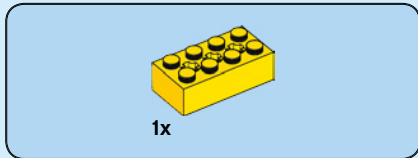

**26**

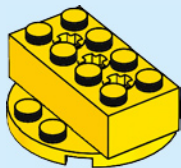



1x

27

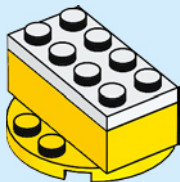

22

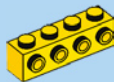

2x

28

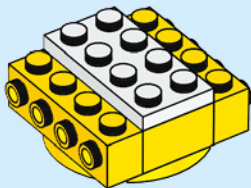



4x

29

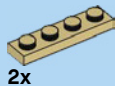
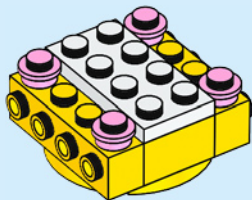

2x

30

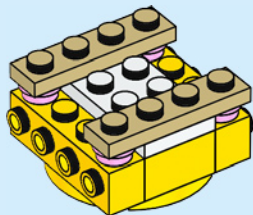

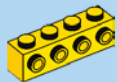

2x



2x

# 31

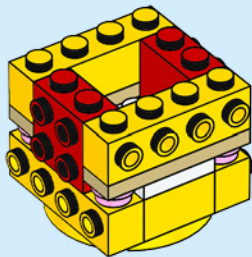

24

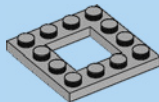

1x

# 32

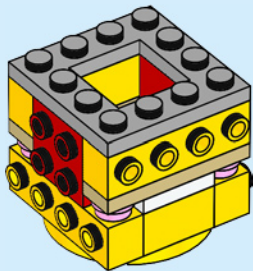



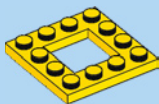

1x

33

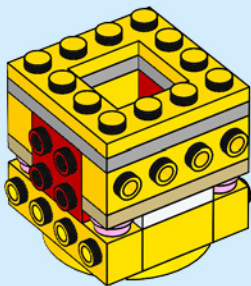

4x

34

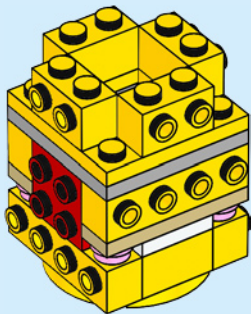



4x

35

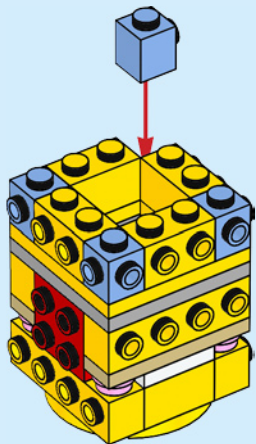

26

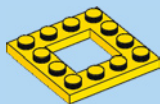

1x

36

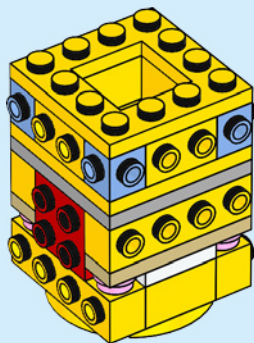

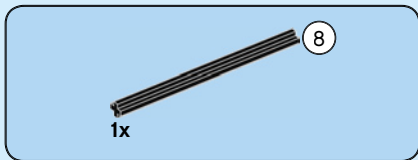

37

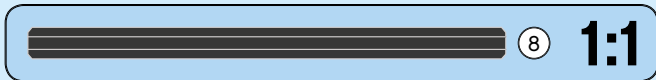
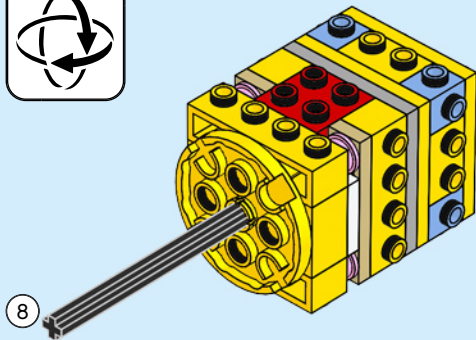
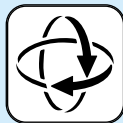



1x



1x

# 38

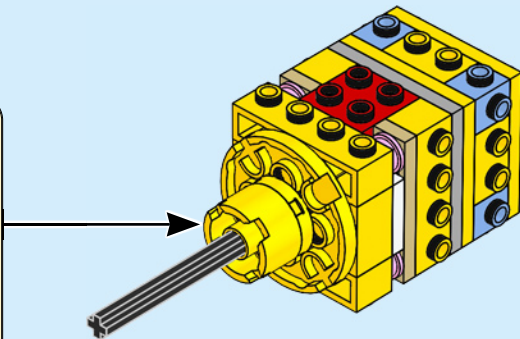
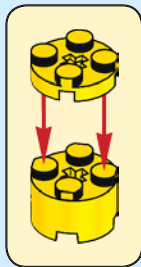



1x



1x

# 39

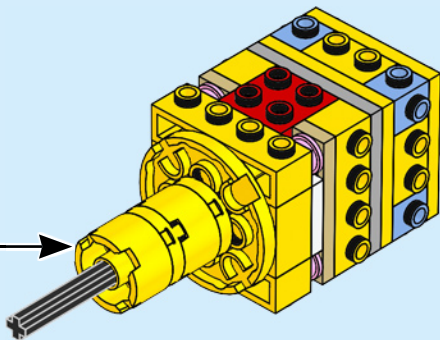
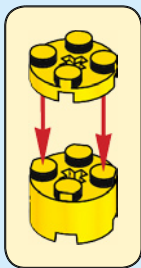



1x



1x

# 40

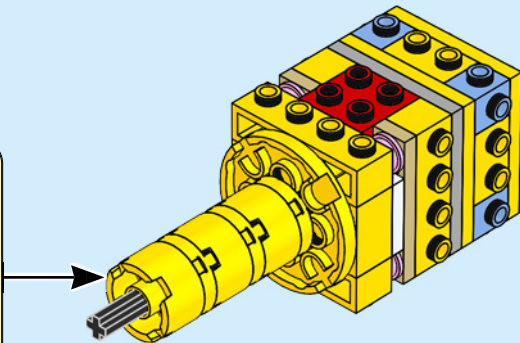
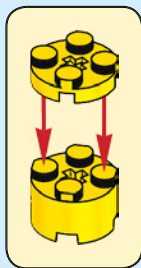

41

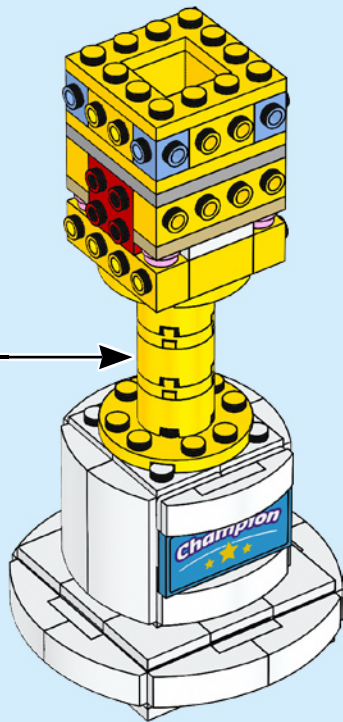

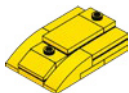

**2x**



1x



1x

**42**

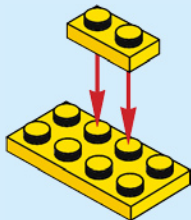

1x

**43**

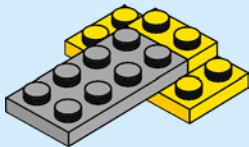





1x

44

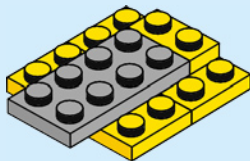

1x

45

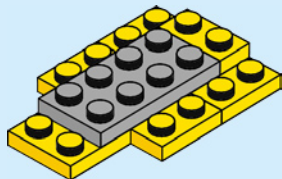



2x

# 46

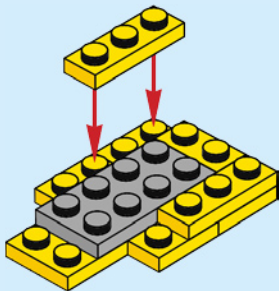

1x



2x



1x

# 47

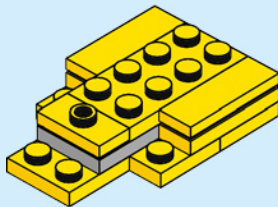



1x



1x



1x

**48**

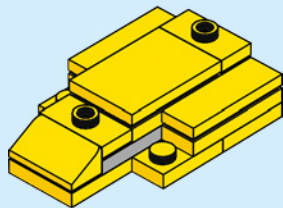

2x

**49**

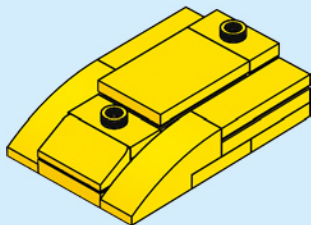

**2x**

50

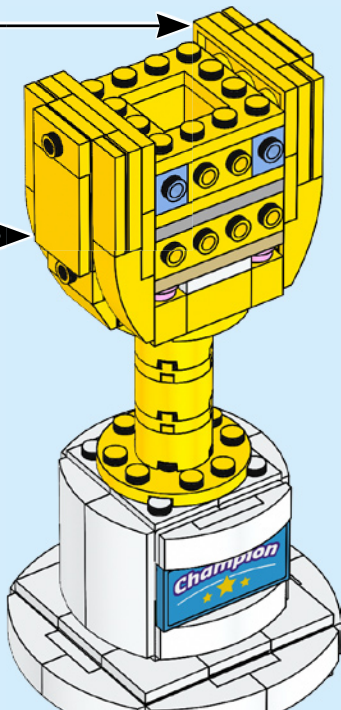

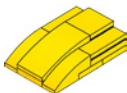

1x

**51**

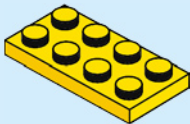

1x

**52**

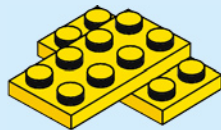



1x

53

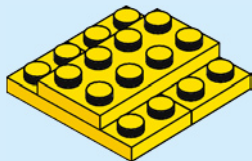

2x

54

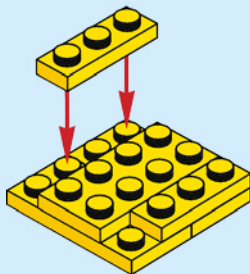



1x



1x



2x

# 55

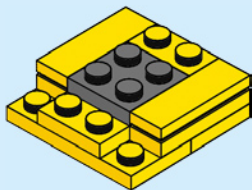

1x



1x

# 56

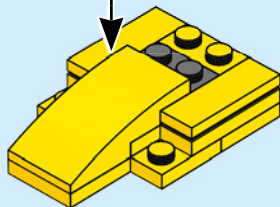
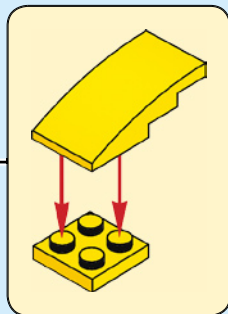



2x

57

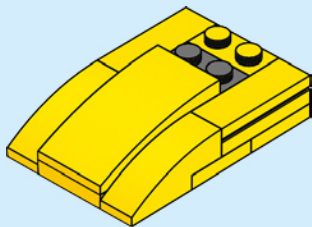

1x

58

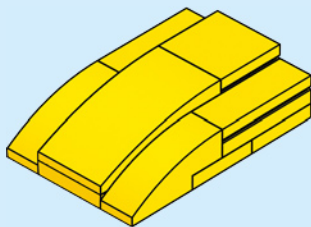



59

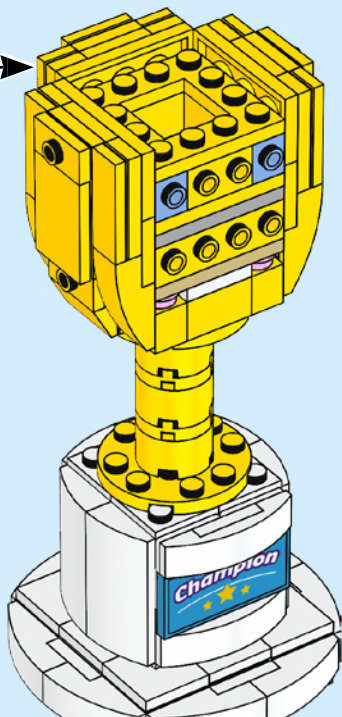



1x

60

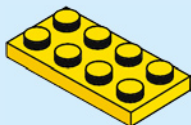

42



1x

61

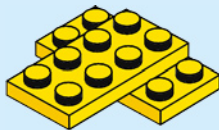



1x

62

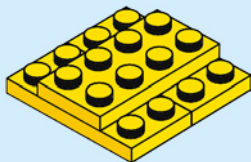

2x

63

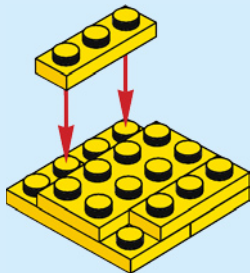

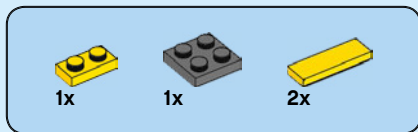

64

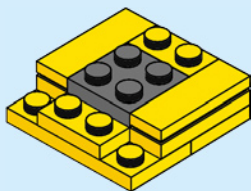



1x



1x

65

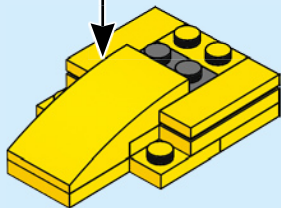
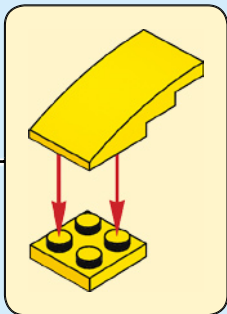

2x

66

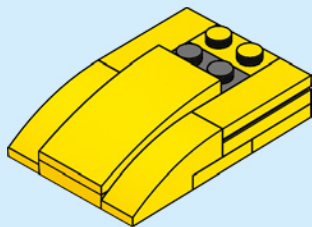

67

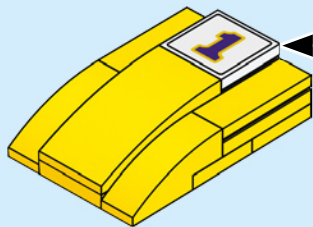

68

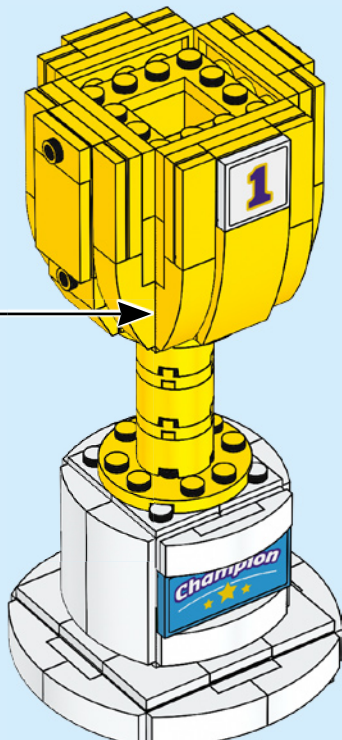

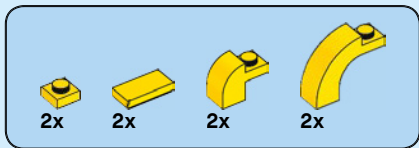

**69**

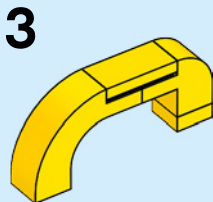
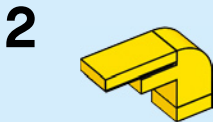
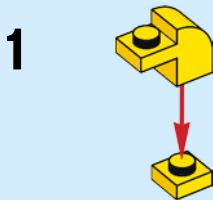



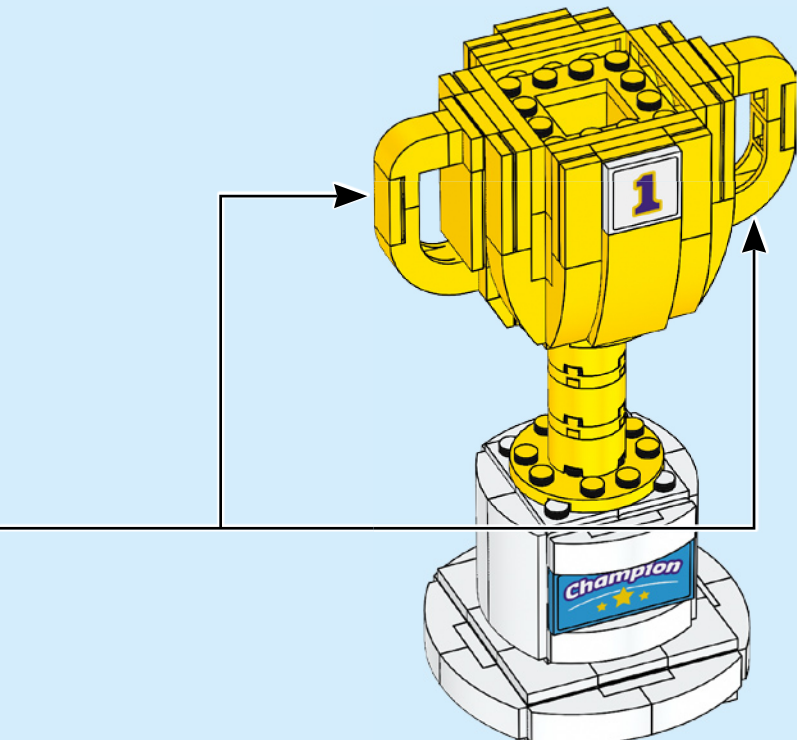





2x  
4515349



2x  
6079001



1x  
4560181



12x  
302024



1x  
6244914

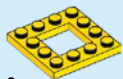

2x  
4549896



4x  
6187572



1x  
302126



1x  
370726



4x  
300528



2x  
4106356



2x  
4164037



4x  
6195548



2x  
4211210



3x  
6123809



2x  
4211395

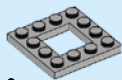

2x  
4612621



2x  
4211094



1x  
6236949



4x  
4517996



1x  
6056261



2x  
6223065



1x  
6167472



2x  
6206312



**Customer Service**

**Kundenservice**

**Service Consommateurs**

**Servicio Al Consumidor**

**LEGO.com/service or dial**



**: 00800 5346 5555**

**: 1-800-422-5346**

# WIN

GO TO [WWW.LEGO.COM/PRODUCTFEEDBACK](http://WWW.LEGO.COM/PRODUCTFEEDBACK) AND  
GIVE US YOUR SHORT **FEEDBACK** ABOUT THIS  
LEGO® SET FOR A CHANCE TO WIN  
A COOL LEGO PRIZE.

Terms & Conditions apply

## [LEGO.com/productfeedback](http://LEGO.com/productfeedback)



### GEWINNE

Erzähle uns auf  
[www.LEGO.com/productfeedback](http://www.LEGO.com/productfeedback)

etwas über die Erfahrungen, die du  
mit diesem LEGO® Set gemacht hast,  
und sichere dir die Chance auf einen  
coolen LEGO Preis!

Es gelten die Teilnahmebedingungen

### GAGNE

Rends-toi sur  
[www.LEGO.com/productfeedback](http://www.LEGO.com/productfeedback)

et donne-nous quelques commen-  
taires sur ce produit LEGO® pour  
avoir une chance de gagner un  
prix LEGO !

Voir Conditions Générales

### GANAN

Visita  
[www.LEGO.com/productfeedback](http://www.LEGO.com/productfeedback)

y envíanos tu opinión acerca de este  
set LEGO®, ¡Participarás en el sorteo  
de un premio LEGO!

Términos y Condiciones aplicables

### 获取奖品

登录  
[www.LEGO.com/productfeedback](http://www.LEGO.com/productfeedback)

给出关于此乐高®套装的简短反  
馈，就有机会获得炫酷乐高奖品

《条款及条件》适用

LEGO and the LEGO logo are trademarks of the/sont des marques de commerce du/  
son marcas registradas de LEGO Group. ©2020 The LEGO Group.

6310605