



# BRICK 'HEADZ

40479

Pets



 [LEGO.com/brickheadz](https://www.lego.com/brickheadz)

PUPPY

132

DALMATIAN

131



DALMATIAN  
LE DALMATIEN  
DALMATA  
DÁLMATA  
DALMÁCIETIS  
斑点狗

PUPPY  
WELPE  
LE CHIOT  
CUCCILO  
CACHORRITO  
CÃOZINHO  
KUTYUS  
KUCĚNS  
小狗

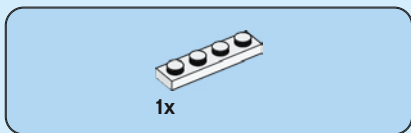
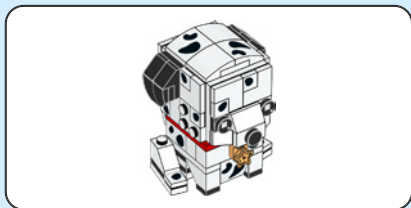

1

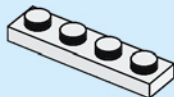



1x

2

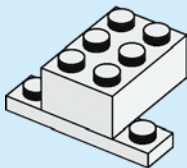

4



2x

3

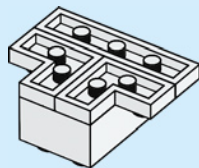

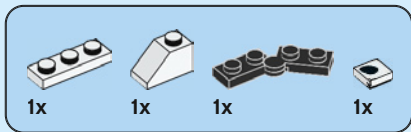

4

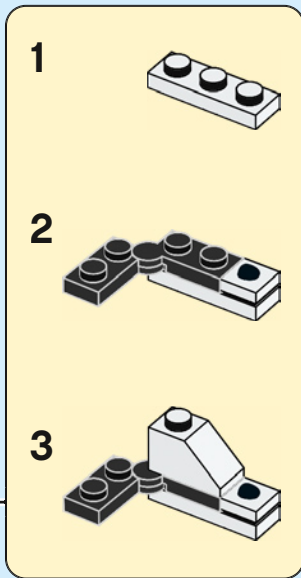
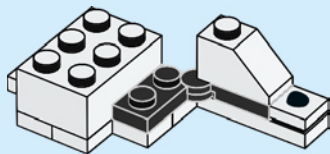

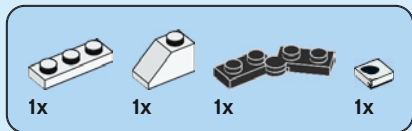

5

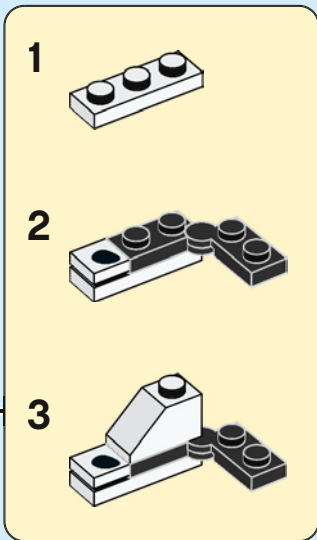
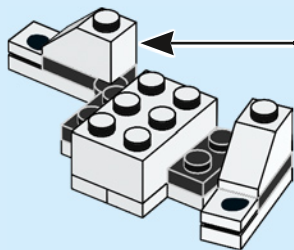

6



6

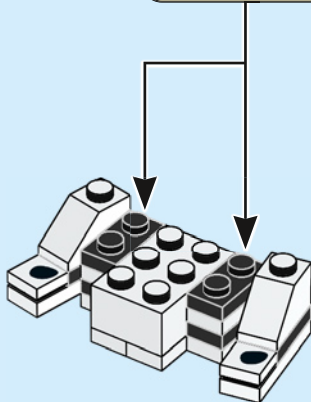
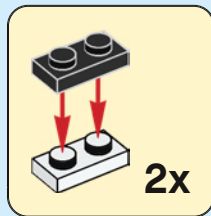



1x



2x

7

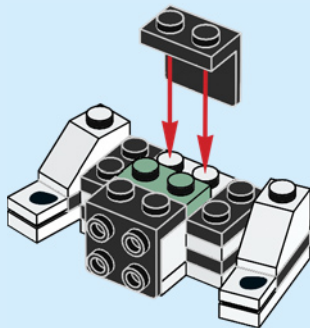

8



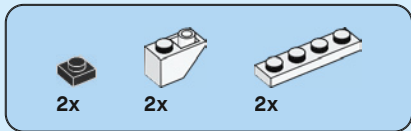

8

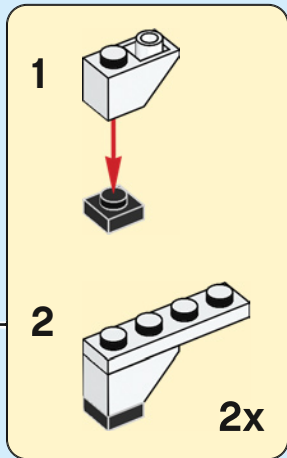
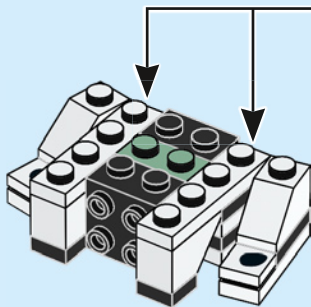



1x



1x

9

1

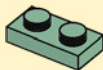

2

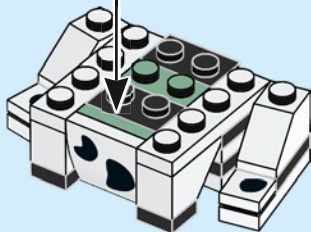



1x



1x



1x

# 10

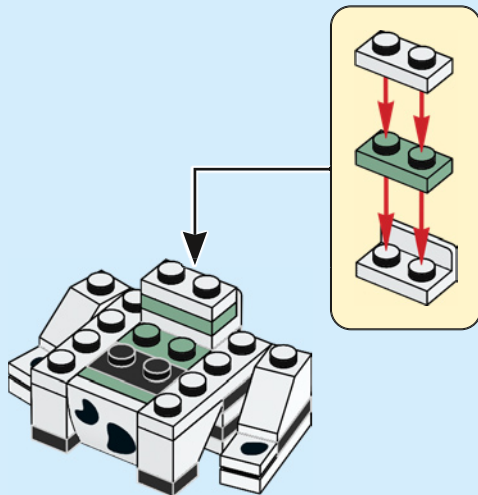



2x

11

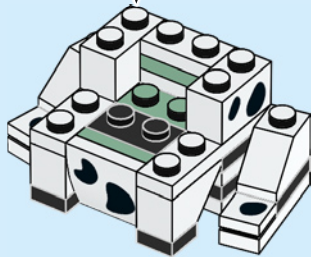
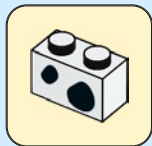

12



2x



1x



1x

# 12

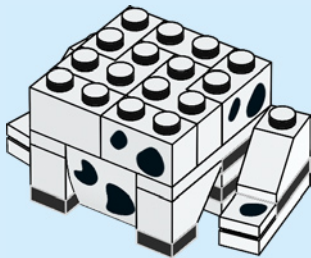

1x



2x



1x

# 13

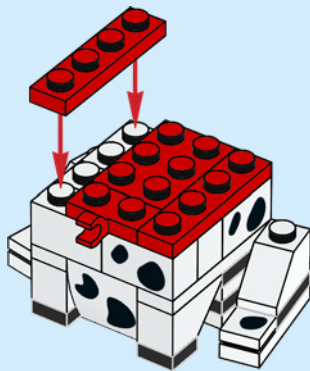

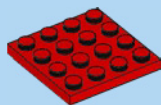

1x

14

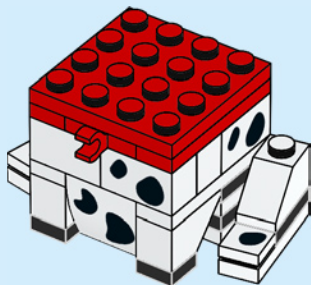

14



1x



1x

# 15

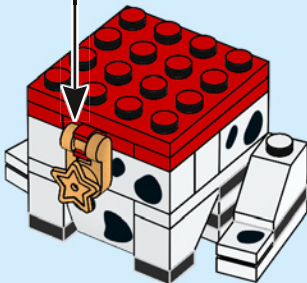

6x

# 16

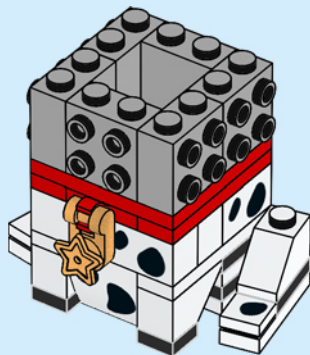

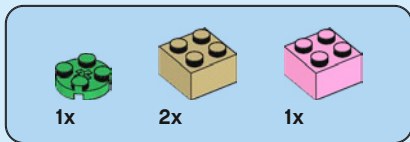

17

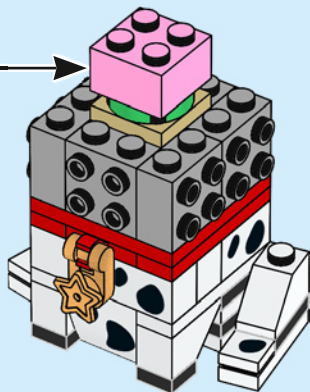
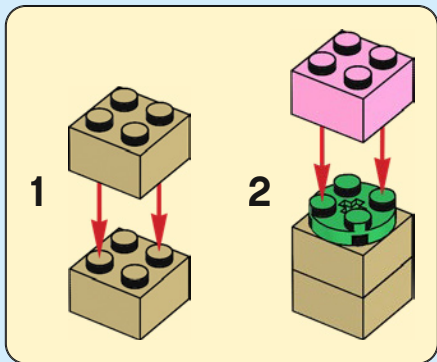





1x



2x

18

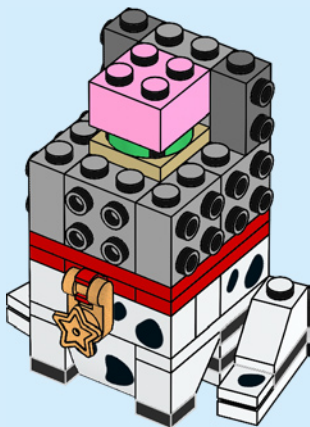

3x



2x

19

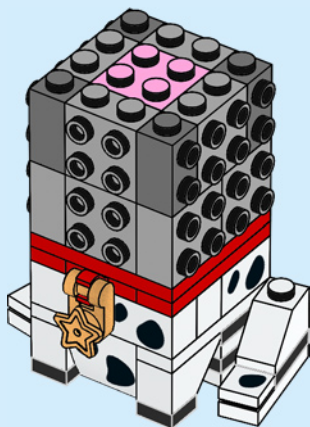



1x

20

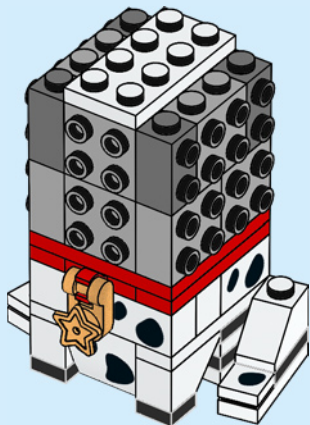

18



2x



2x

21

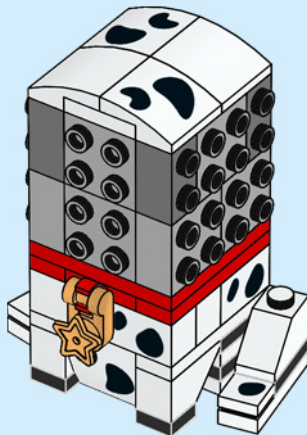

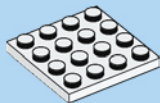

1x

22

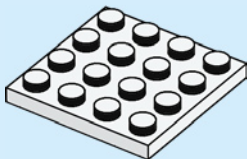

2x



2x

23

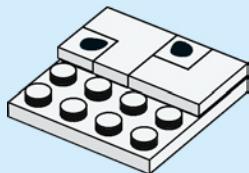



1x



1x



1x

# 24

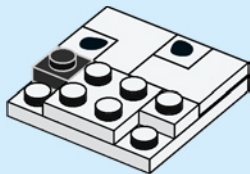

20



2x



2x

# 25

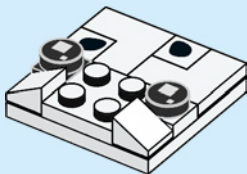



1x



1x

26

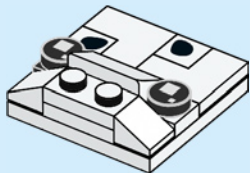

1x

27

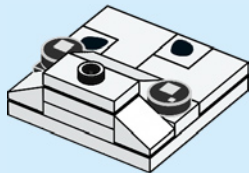



1x

28

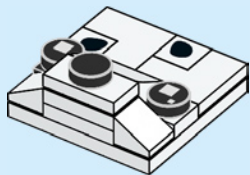

29

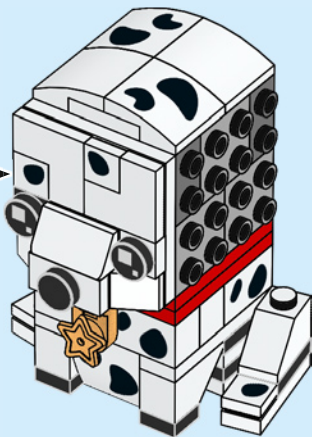



1x



2x



3x

# 30

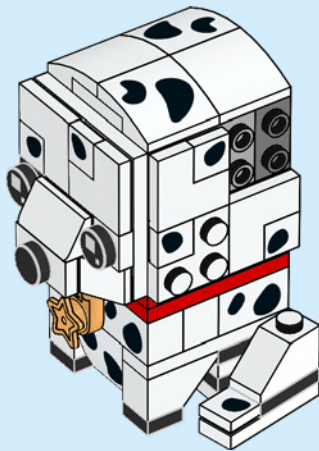

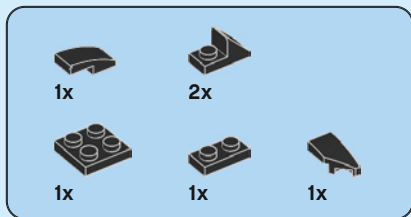

# 31

1

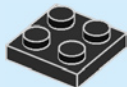

2

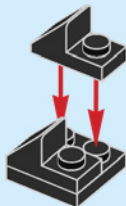

3

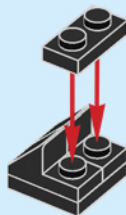



4

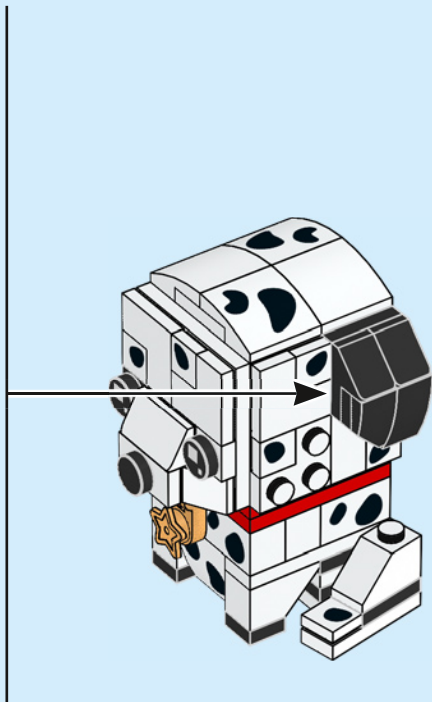



1x



1x



1x



1x

# 32

1

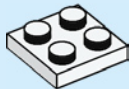

2



3



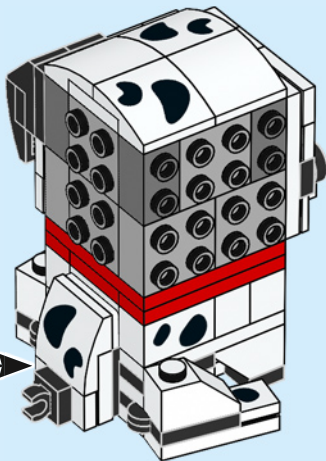

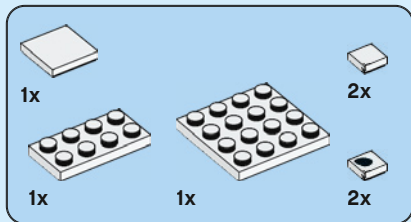

# 33

## 1

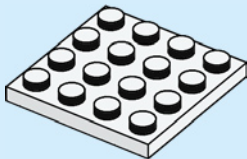

## 2

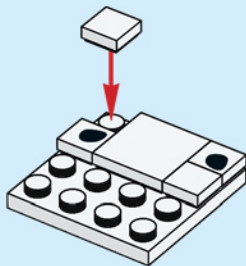

3

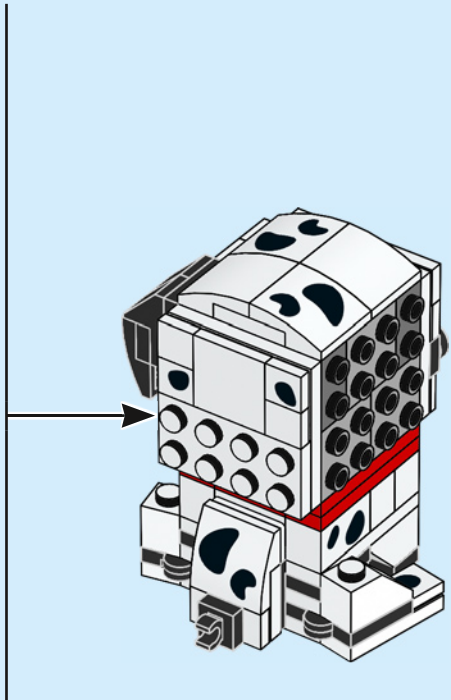
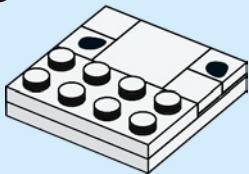

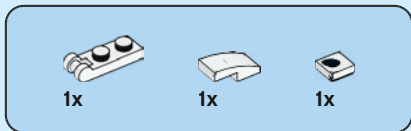

# 34

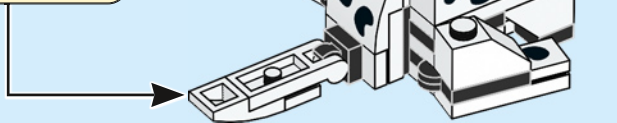
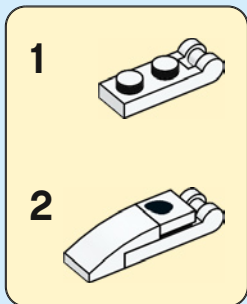



1x



2x



3x

# 35

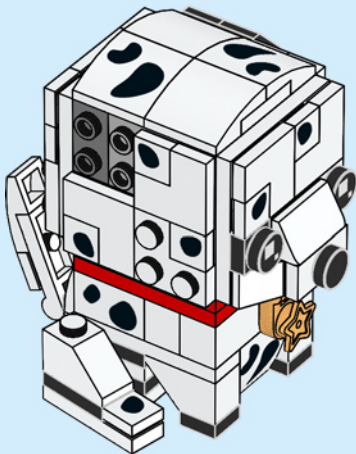

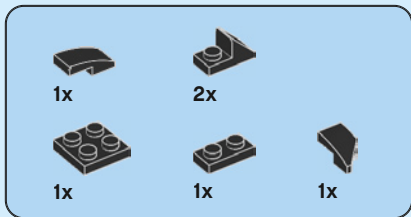

# 36

1

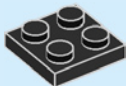

2

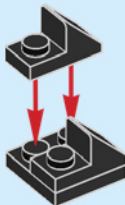

3

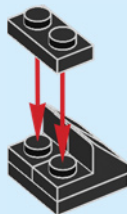



4

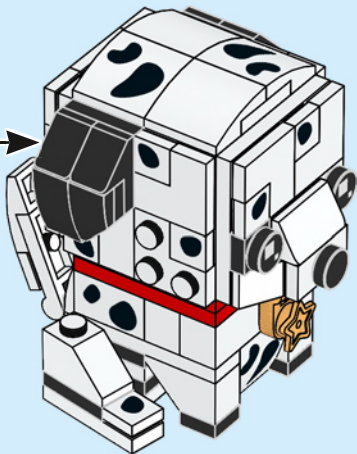
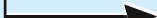

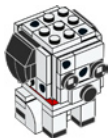

1x

1



1x

2

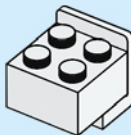



1x

**3**

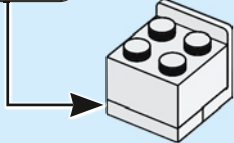
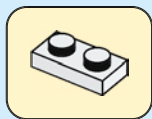

2x



1x

**4**

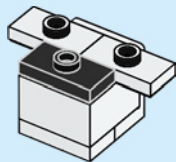

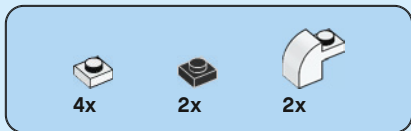

5

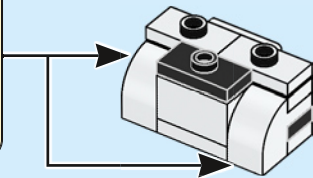
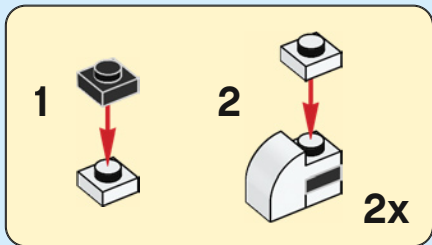

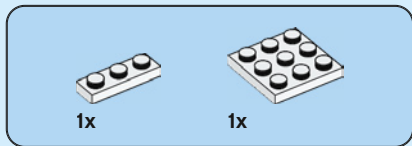

6

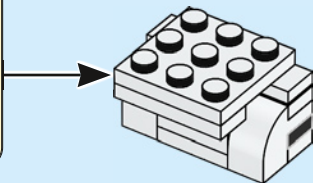
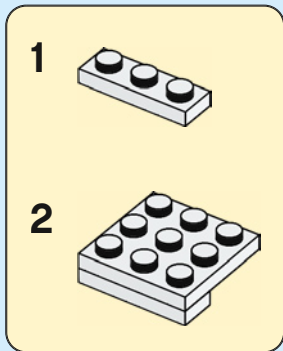



2x



2x

7



2x

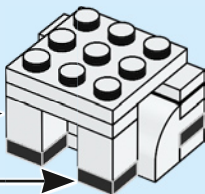

38



1x



1x

8

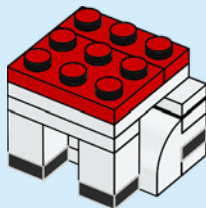



1x

9

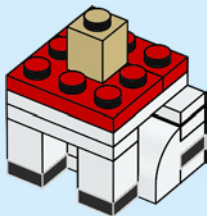

4x



4x

10

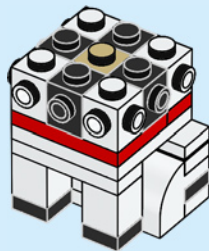



1x



1x

# 11

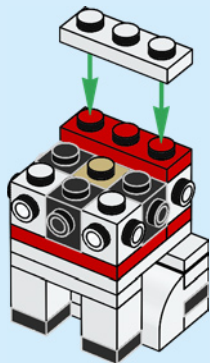

1x



2x

# 12

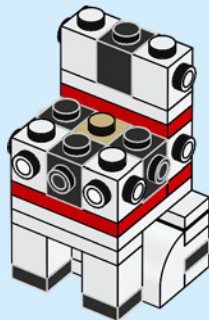





1x



1x



1x

# 13

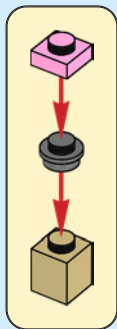



2x



1x

# 14

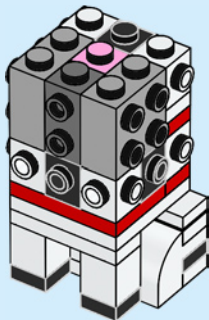

42



1x



1x



2x

# 15

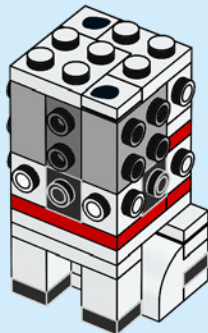

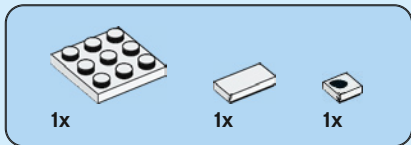

16

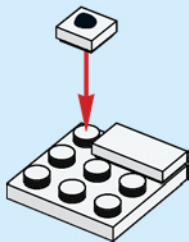

17

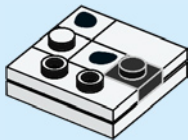



1x



2x

18



1x

19

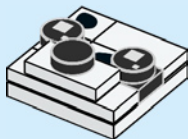

# 20

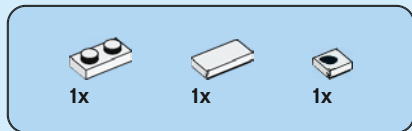
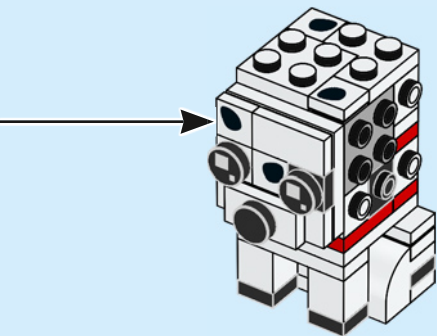

# 21

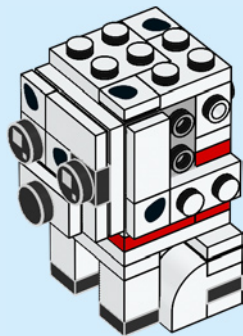

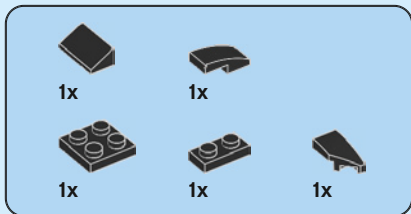

# 22

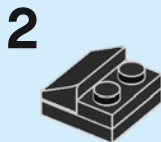
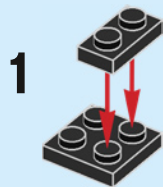

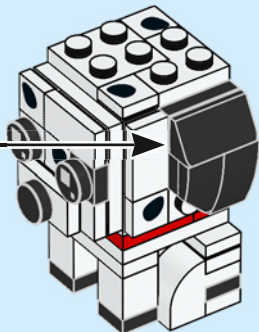

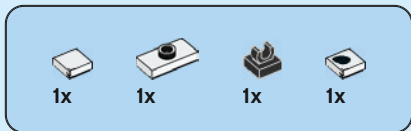

23

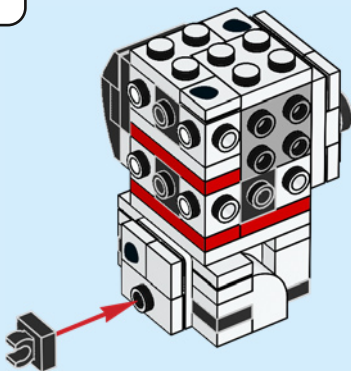





1x

# 24

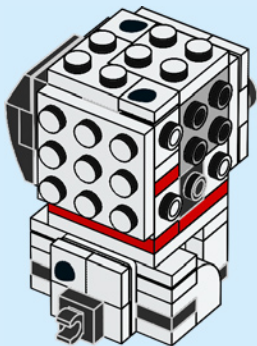

2x



1x



2x

# 25

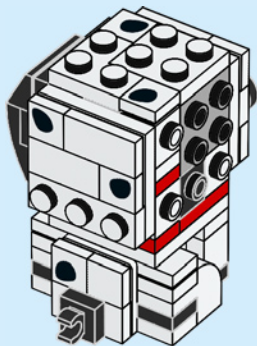



1x



1x

# 26

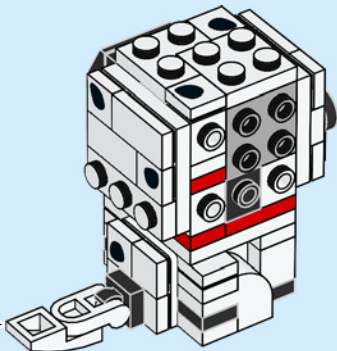
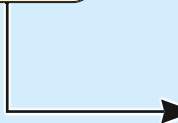
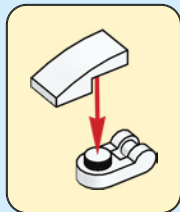



1x



1x



1x

27

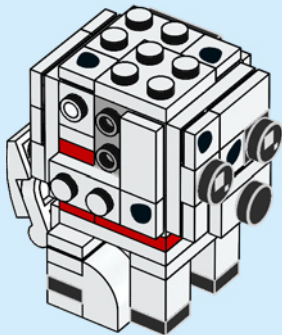

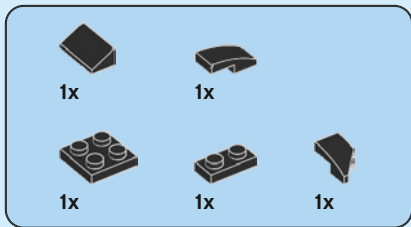

# 28

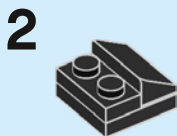
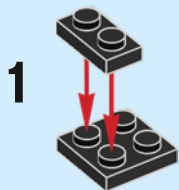

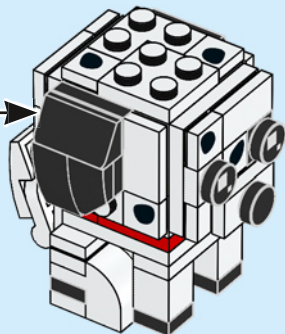

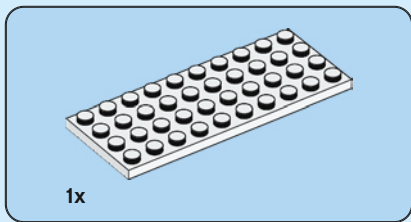
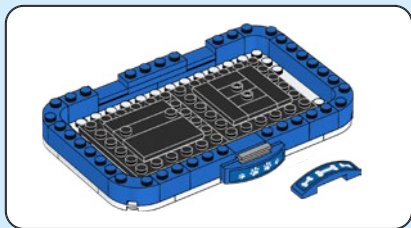

1

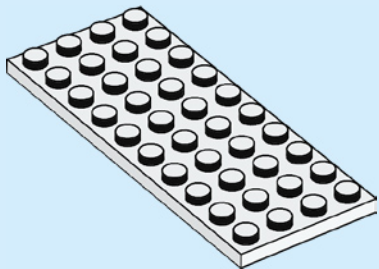

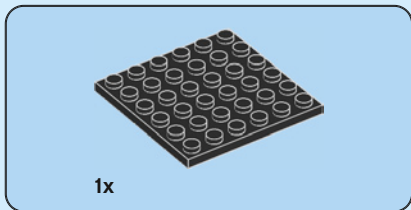

2

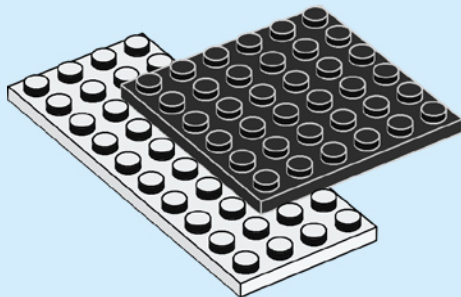

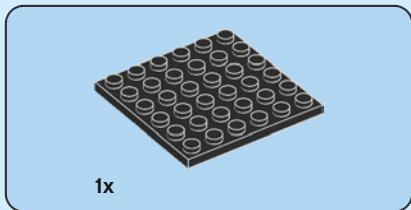

**3**

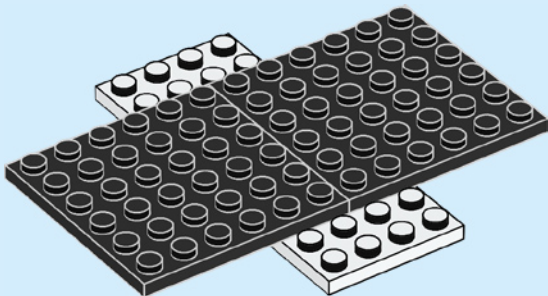



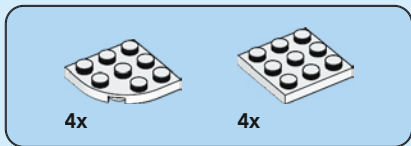

4

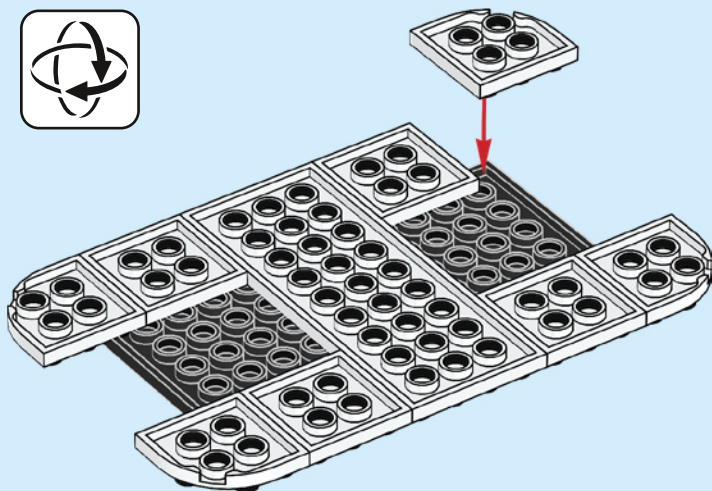

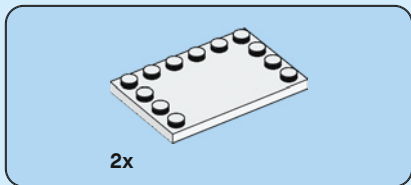

5

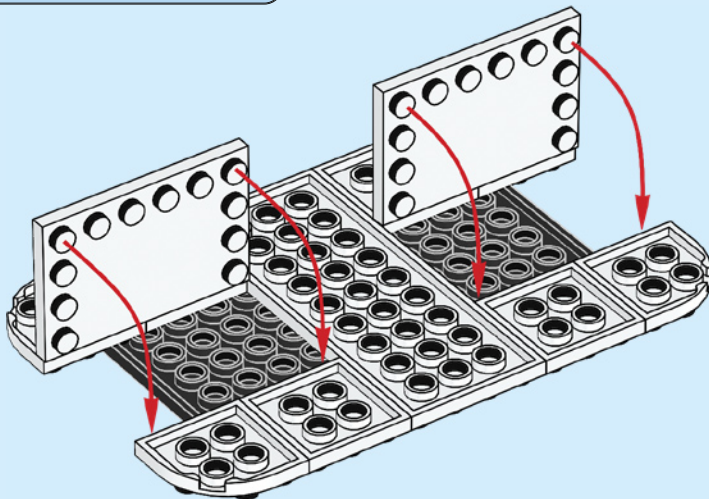

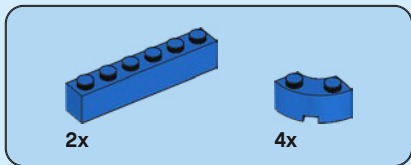

6

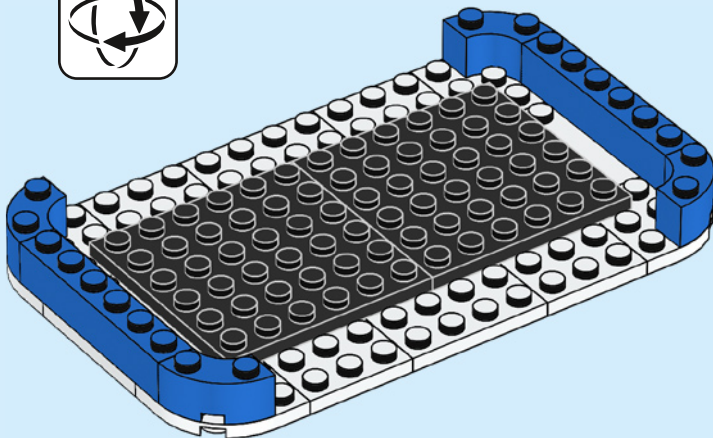



2x



2x

7

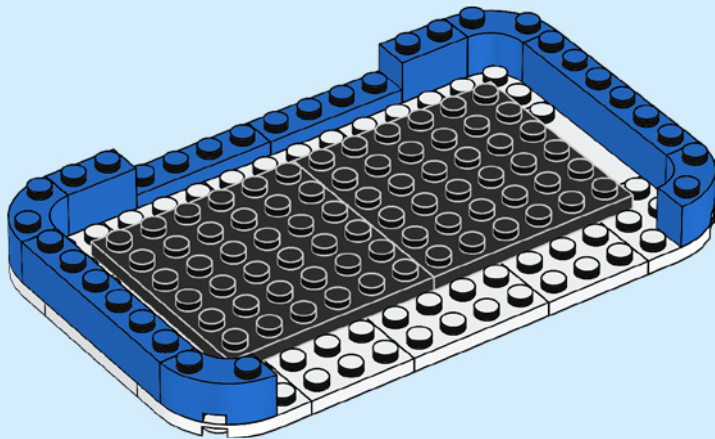

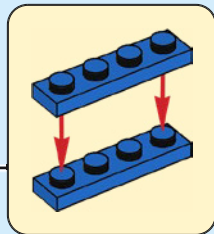
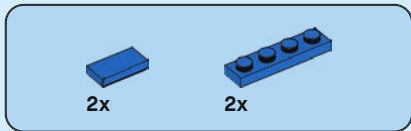

8

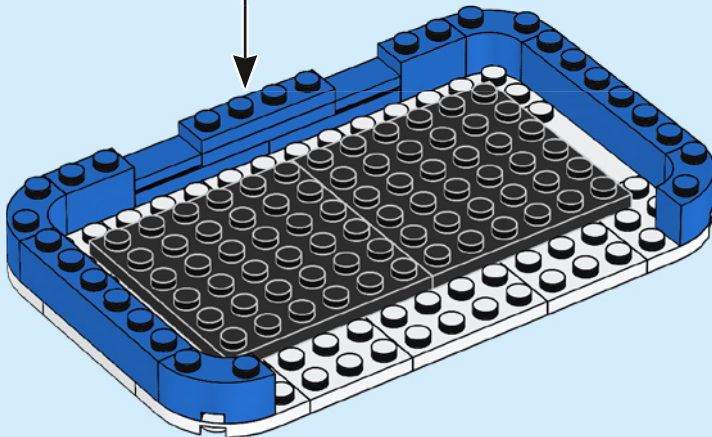

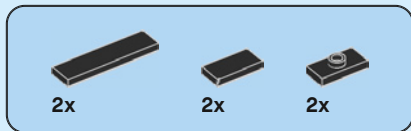

9

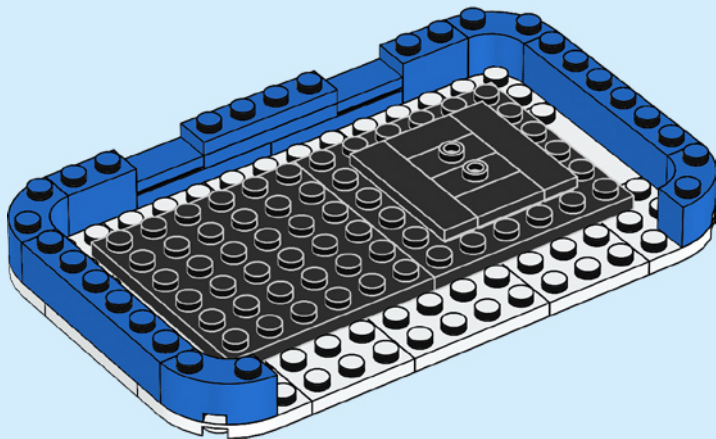





2x



1x



2x

# 11

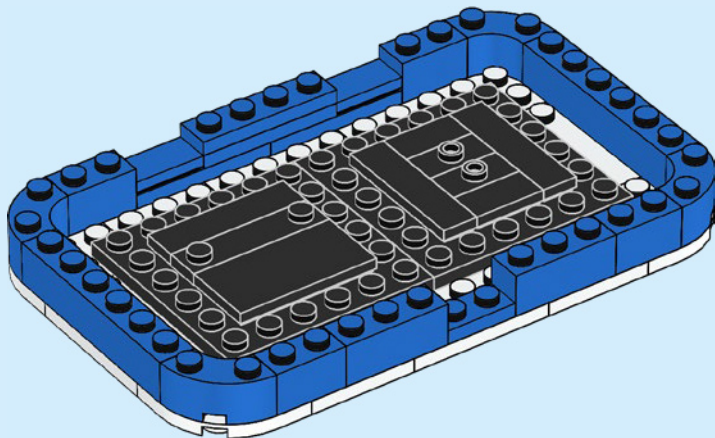



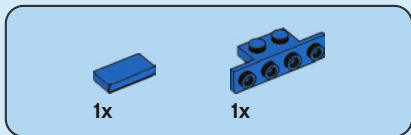

# 12

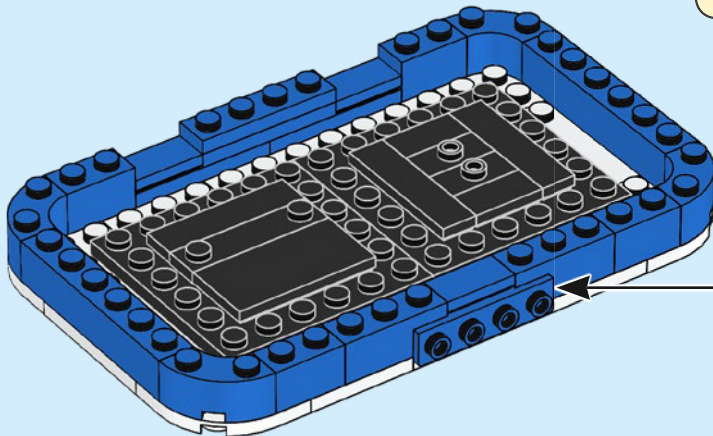
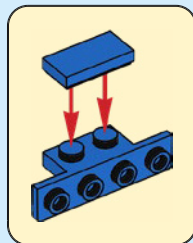



1x



1x

# 13

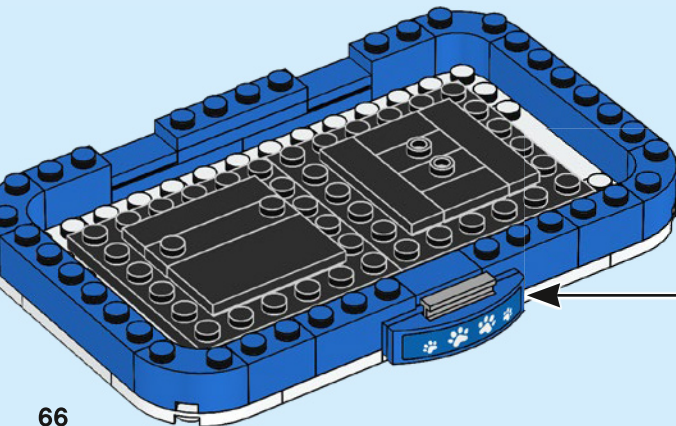

1

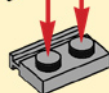

2



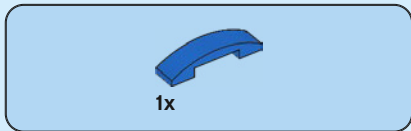

14

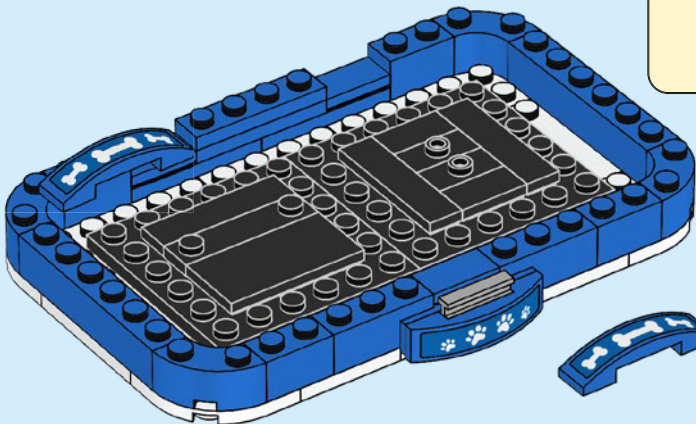
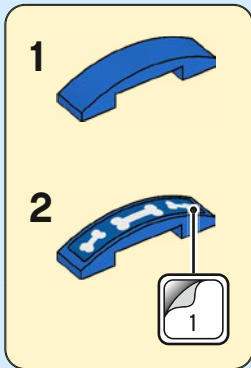

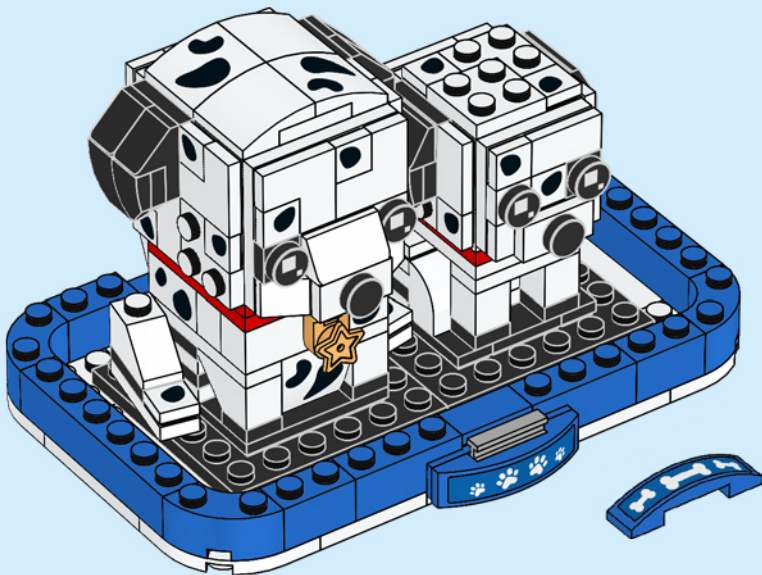



2x  
4504369



3x  
307001



6x  
302401



22x  
6350449



2x  
300501



6x  
6224811



1x  
6174937



1x  
4547489



2x  
366501



6x  
6051511



5x  
306901



7x  
302301



3x  
6351980



1x  
300401



2x  
6034044



2x  
4121932



1x  
6097637



1x  
306801



4x  
6350448



2x  
6047220



3x  
302201



1x  
300301



2x  
235701



5x  
242001



6x  
6058329



1x  
4515364



1x  
6195371



1x  
6070698



5x  
362301



3x  
371001



1x  
300201

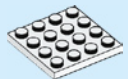

2x  
4243812

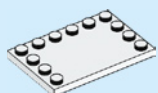

2x  
4163986

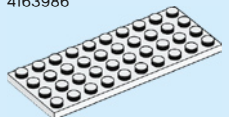

1x  
4503008



2x  
6285777



7x  
6104805



4x  
4550745



2x  
302001



2x  
4113915



2x  
4114306

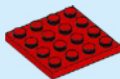

1x  
4243814



1x  
6313120



2x  
362321



2x  
302121



2x  
371021



2x  
4649773

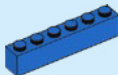

2x  
300923



4x  
371023



4x  
300423



3x  
306923



1x  
302323



4x  
6307922



2x  
362223



1x  
6271125



5x  
4558954



2x  
6181720



2x  
6181713



2x  
4548180



8x  
302426



2x  
306926

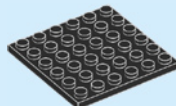

2x  
395826



2x  
6335388



2x  
6284070



4x  
6284077



6x  
302326



4x  
6069000



3x  
6092585



4x  
6047276



2x  
6117973



4x  
302226



3x  
243126



1x  
6254045



2x  
6102782



1x  
4560182



1x  
403228



3x  
4655080



12x  
6123809



1x  
4211568



1x  
4210633



5x  
6228923



1x  
6031883



1x  
4550359



1x  
6184647



1x  
6212377



Customer Service  
Kundenservice  
Service Consommateurs  
Servicio Al Consumidor

LEGO.com/service or dial



: 00800 5346 5555

: 1-800-422-5346

# WIN

GO TO [WWW.LEGO.COM/PRODUCTFEEDBACK](http://WWW.LEGO.COM/PRODUCTFEEDBACK) AND  
GIVE US YOUR SHORT **FEEDBACK** ABOUT THIS  
LEGO® SET FOR A CHANCE TO WIN  
A COOL LEGO PRIZE.

Terms & Conditions apply



## [LEGO.com/productfeedback](http://LEGO.com/productfeedback)

### GEWINNE

Erzähle uns auf  
[www.LEGO.com/productfeedback](http://www.LEGO.com/productfeedback)

etwas über die Erfahrungen, die du  
mit diesem LEGO® Set gemacht hast,  
und sichere dir die Chance auf einen  
coolen LEGO Preis!

Es gelten die Teilnahmebedingungen

### GAGNE

Rends-toi sur  
[www.LEGO.com/productfeedback](http://www.LEGO.com/productfeedback)

et donne-nous quelques commen-  
taires sur ce produit LEGO® pour  
avoir une chance de gagner un  
prix LEGO !

Voir Conditions Générales

### GANAN

Visita  
[www.LEGO.com/productfeedback](http://www.LEGO.com/productfeedback)

y envíanos tu opinión acerca de este  
set LEGO®, ¡Participarás en el sorteo  
de un premio LEGO!

Términos y Condiciones aplicables

### 获取奖品

登录  
[www.LEGO.com/productfeedback](http://www.LEGO.com/productfeedback)

给出关于此乐高®套装的简短反  
馈，就有机会获得炫酷乐高奖品

《条款及条件》适用

LEGO and the LEGO logo are trademarks of the LEGO Group. ©2021 The LEGO Group.

6372346