

**LEGO**

4514

World City ↑

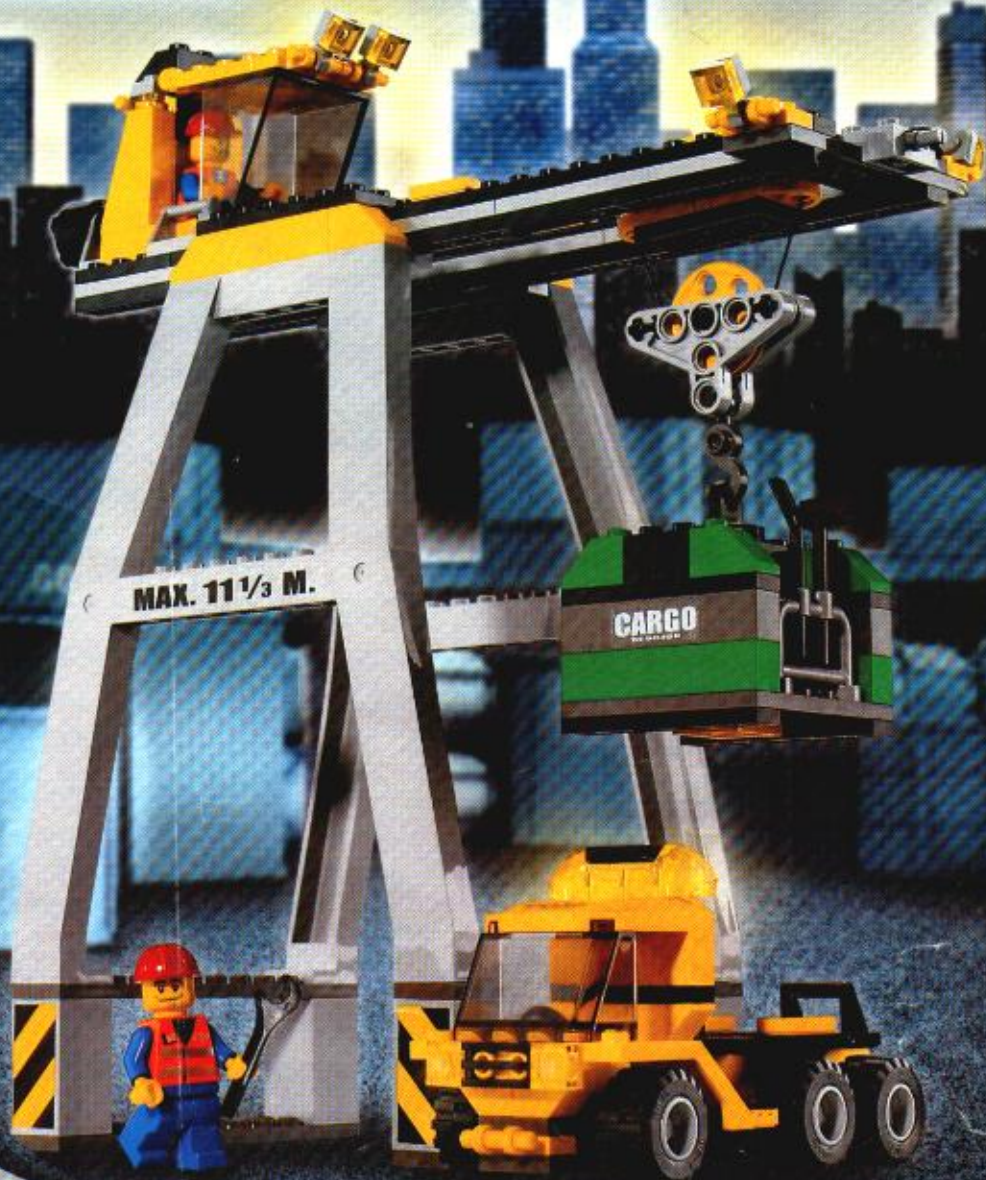

4213016





1

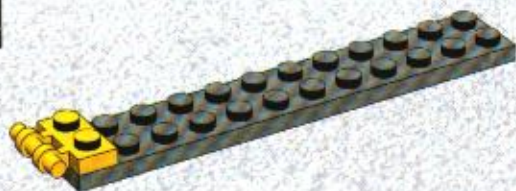

2



3

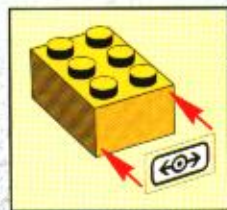

4

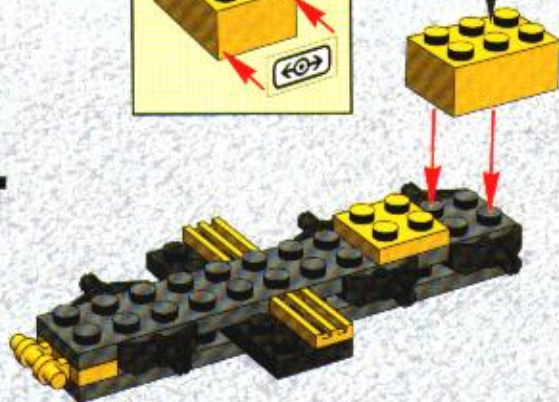

5

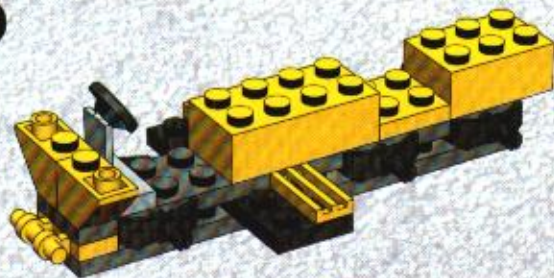

6

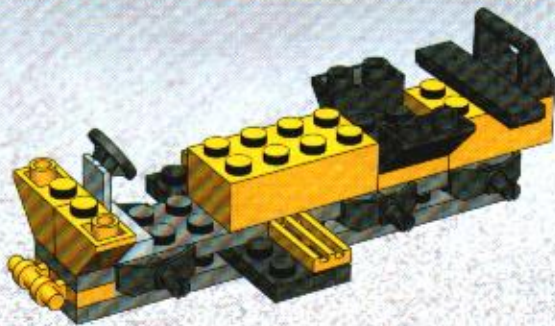

8

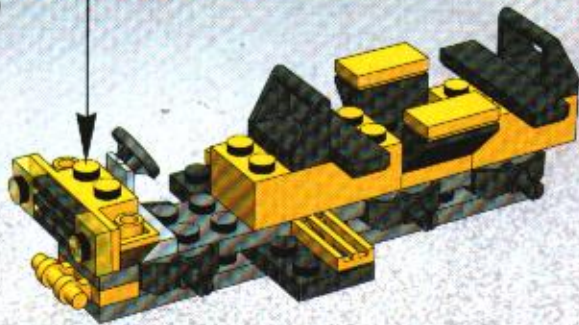

7

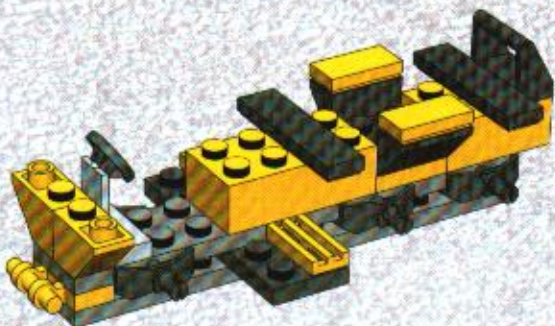

9

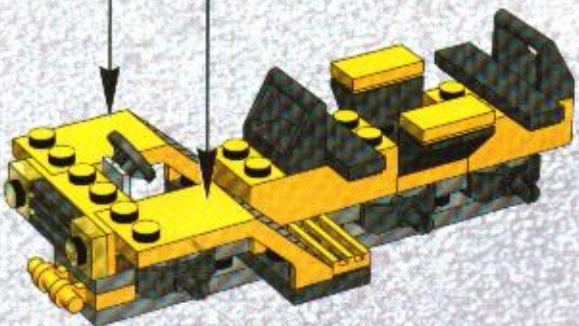
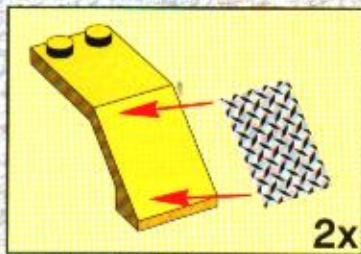

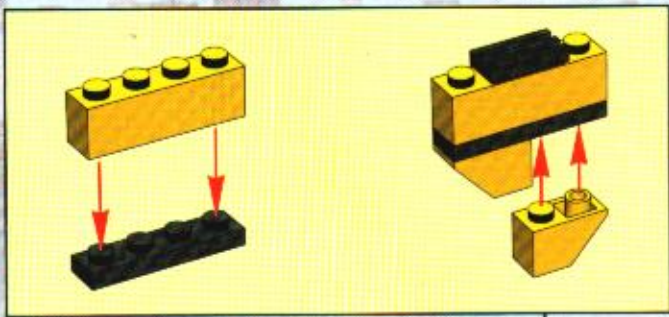

10

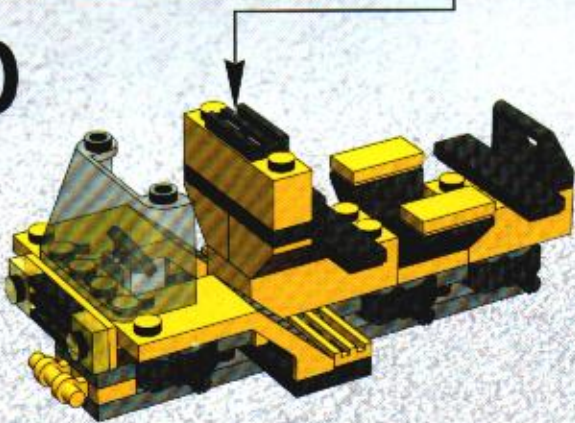

11



12

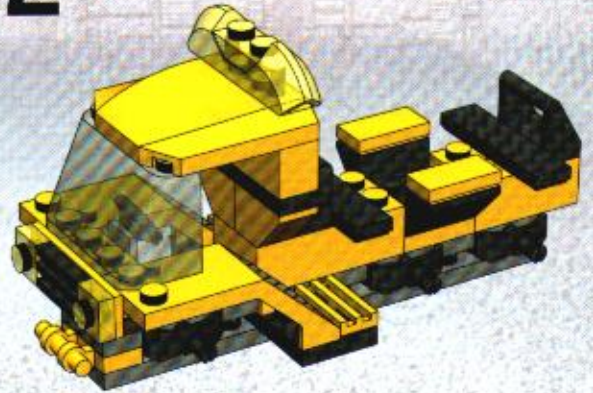

13





1

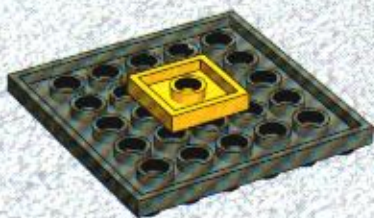

2

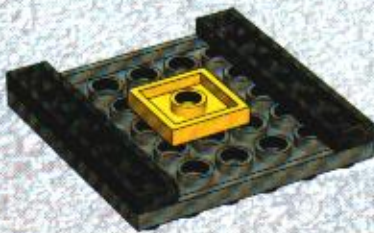

3

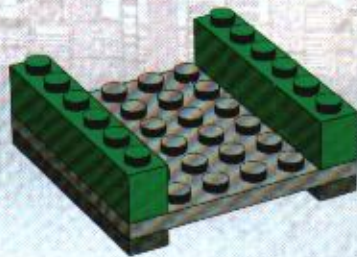

4

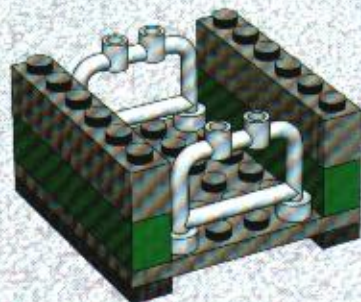

5

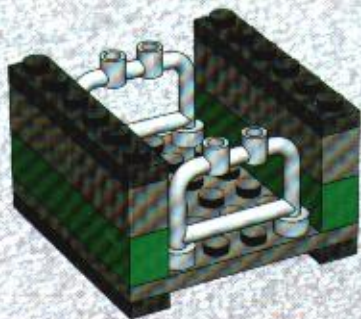

6

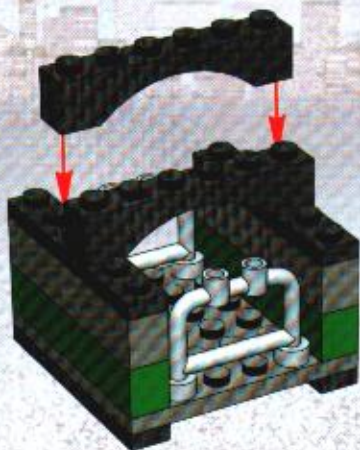

8

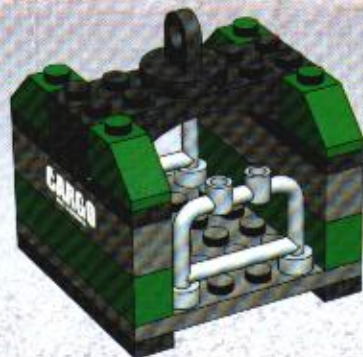

7

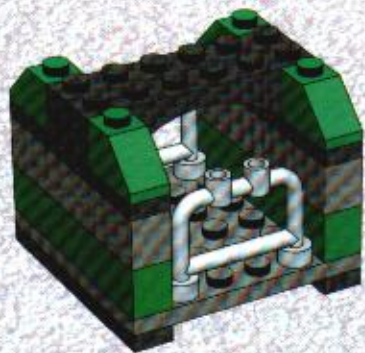

9



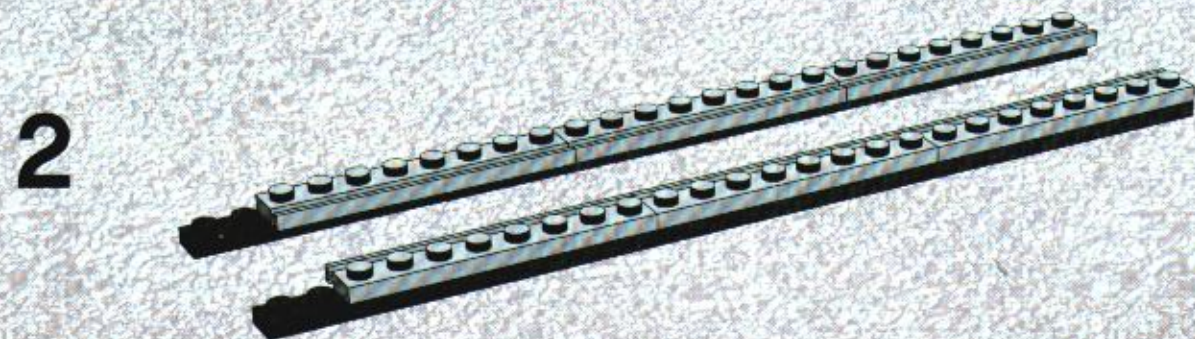



3

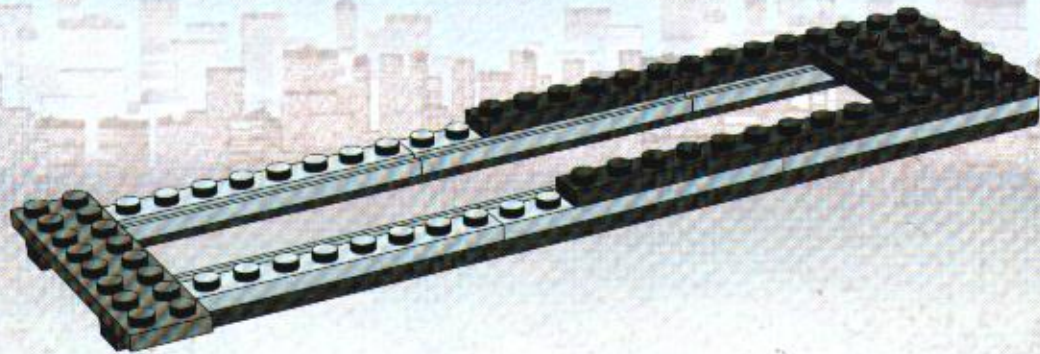

4

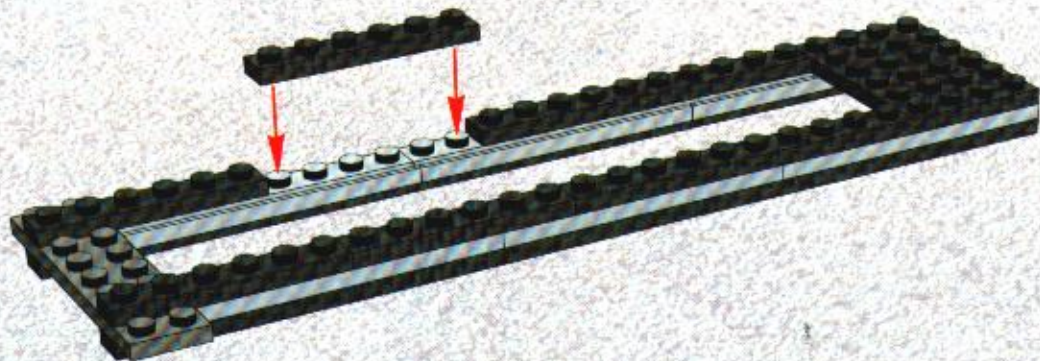

5

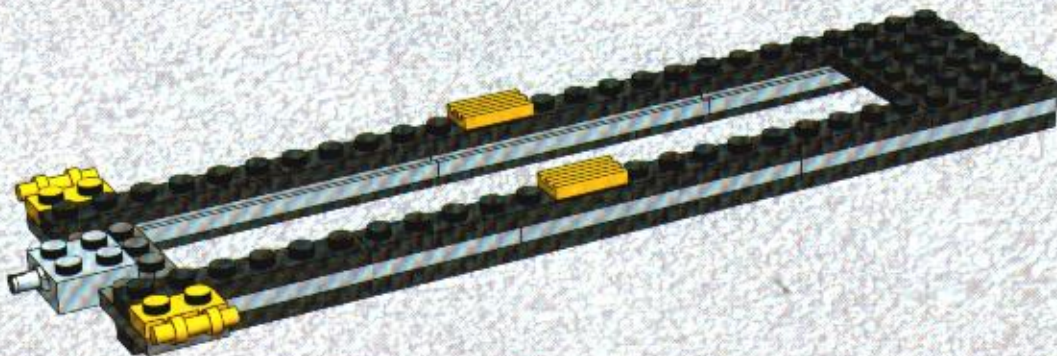

1



2



3



4

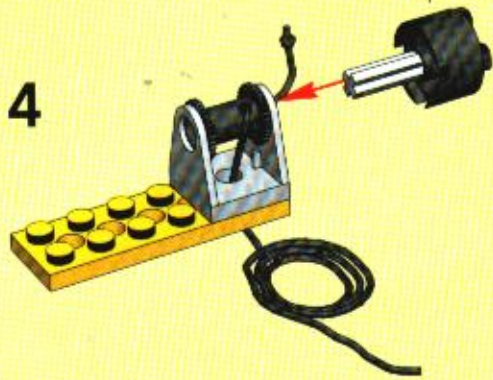

6

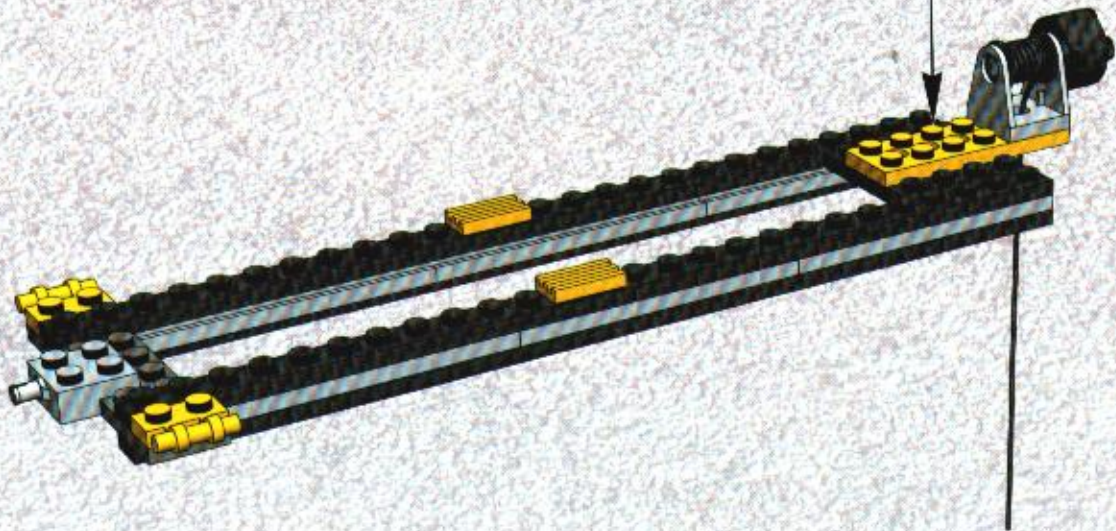

7

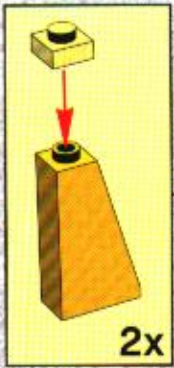
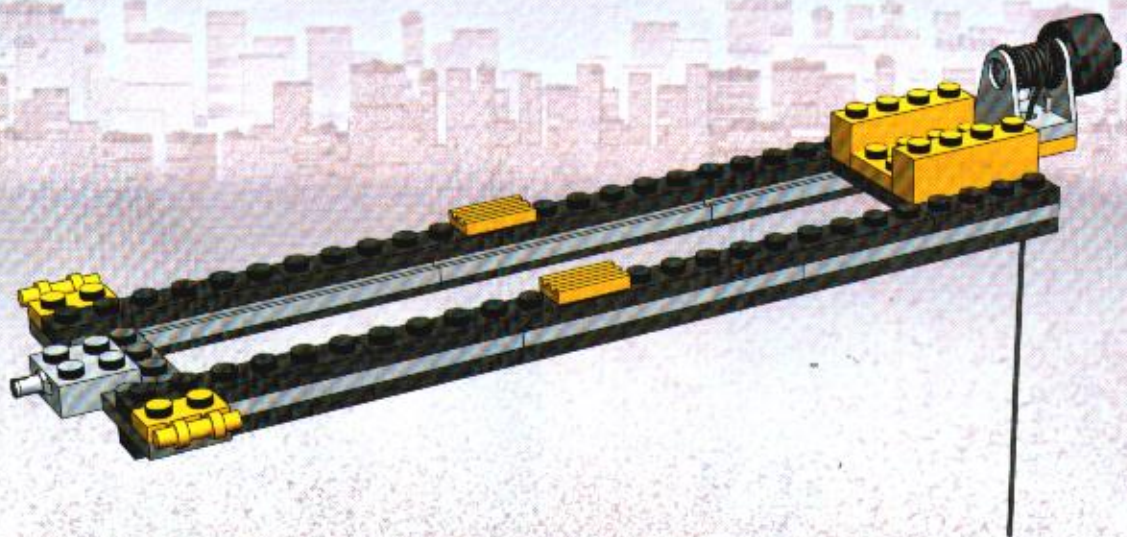

8

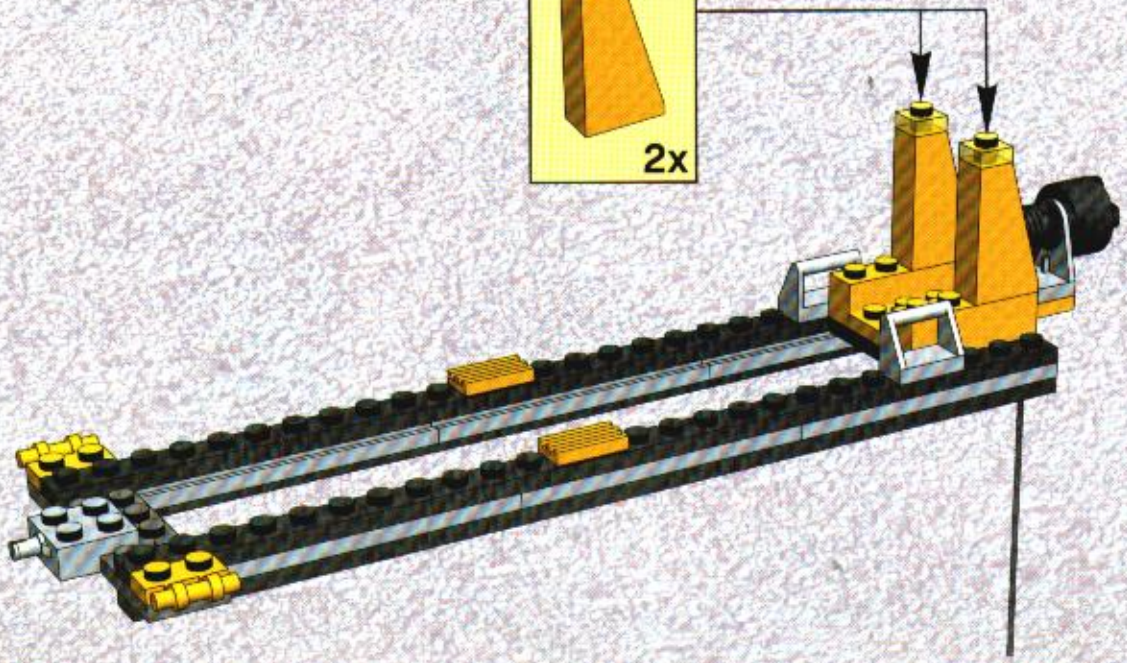

9

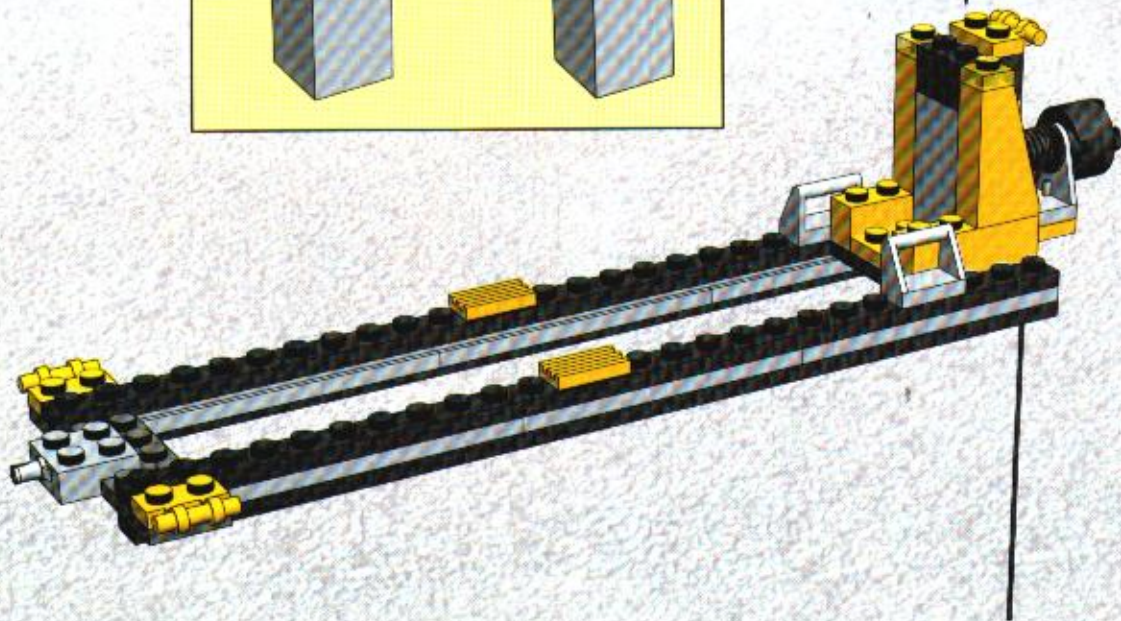
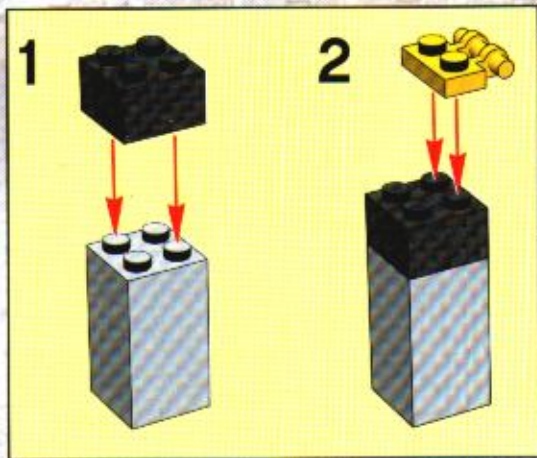

1

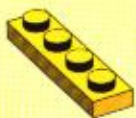

2

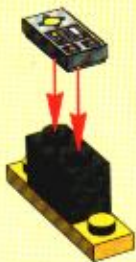

3

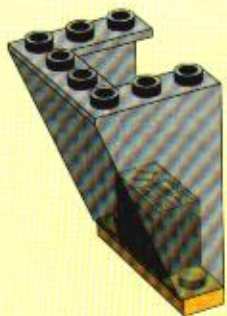

4

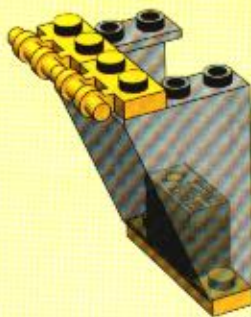

5

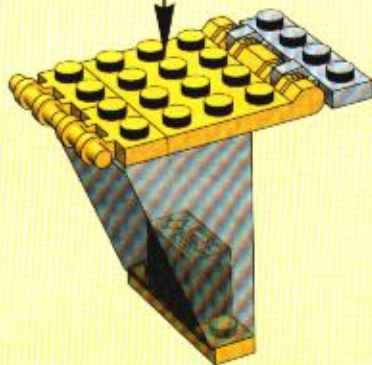
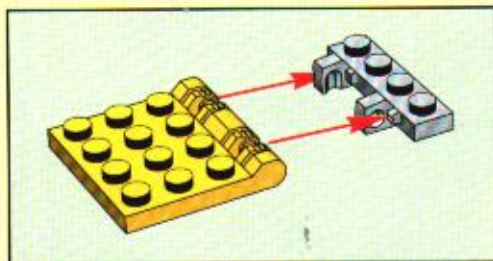

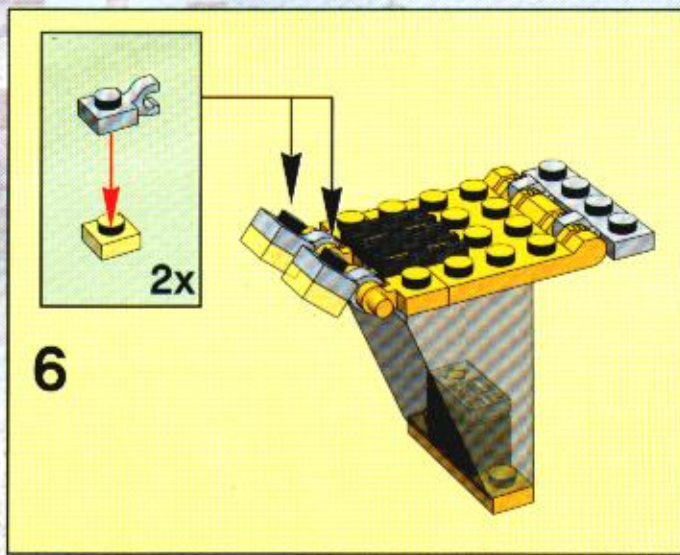

10

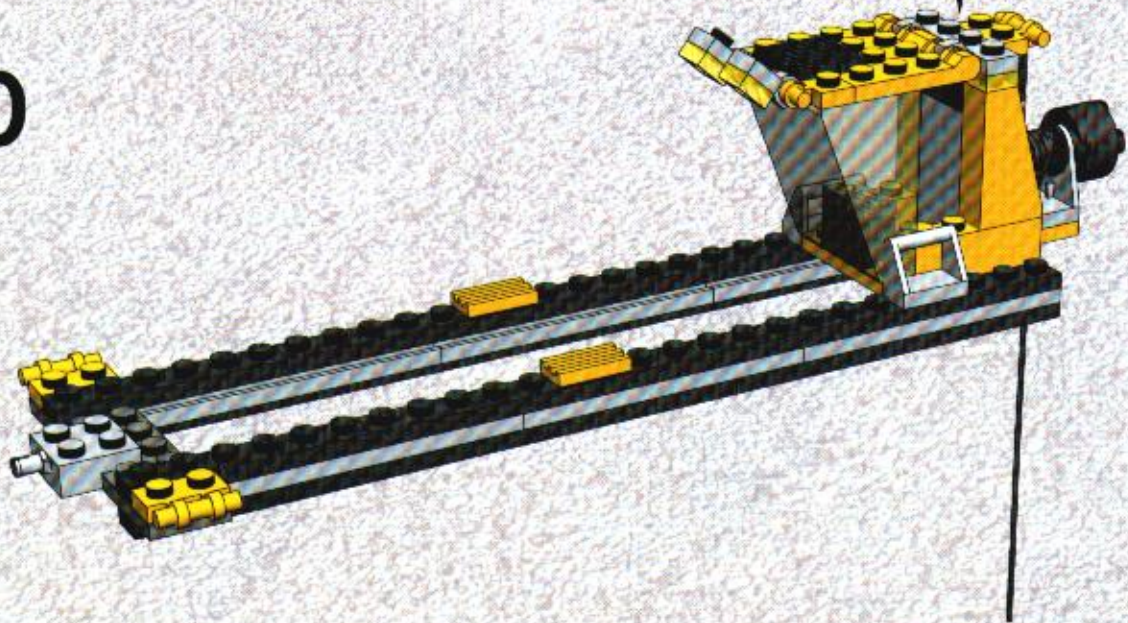

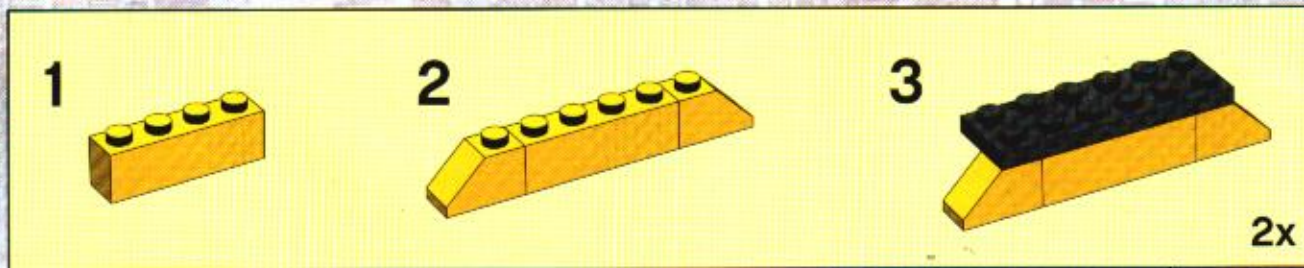

11

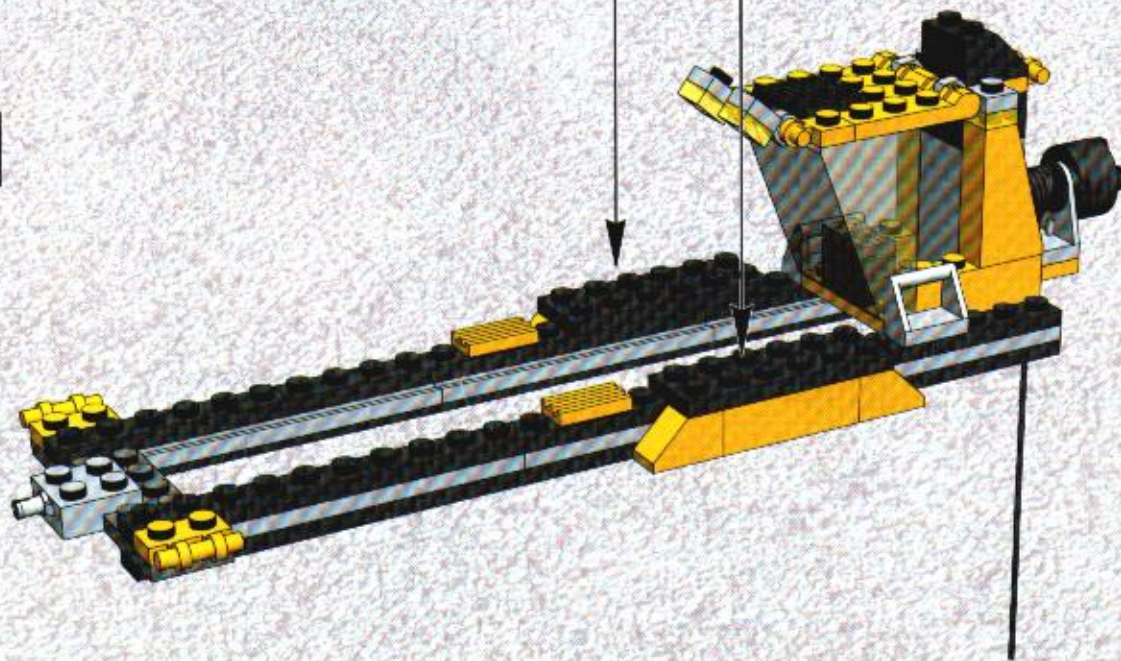

1

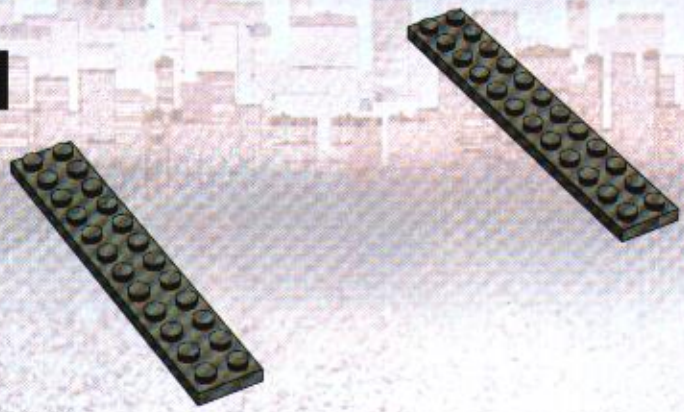

2

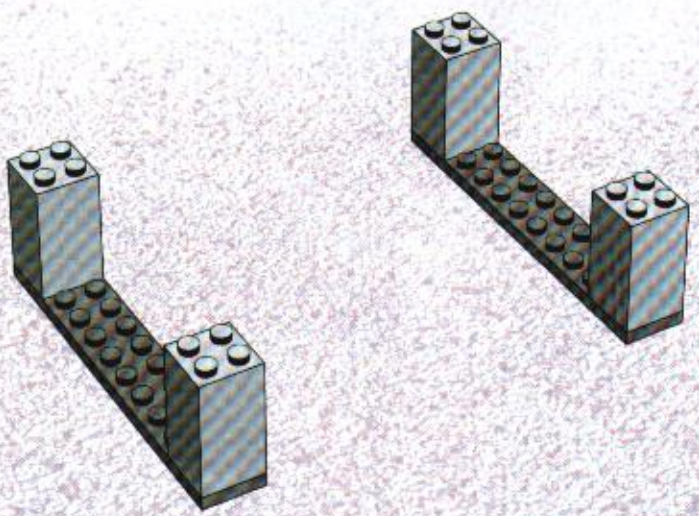

3

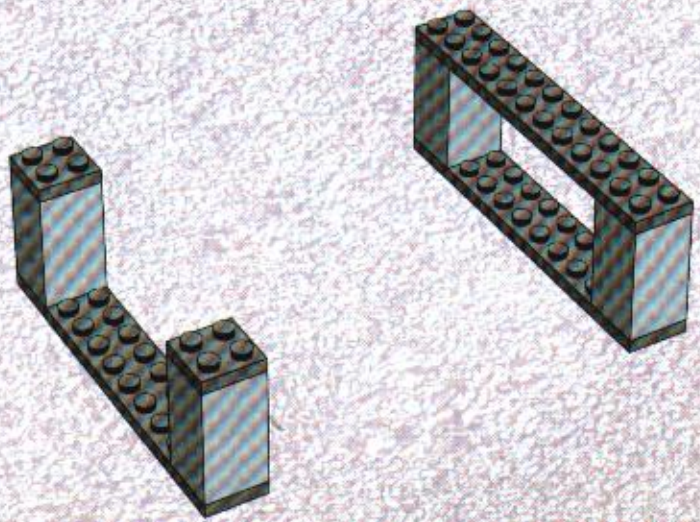



4

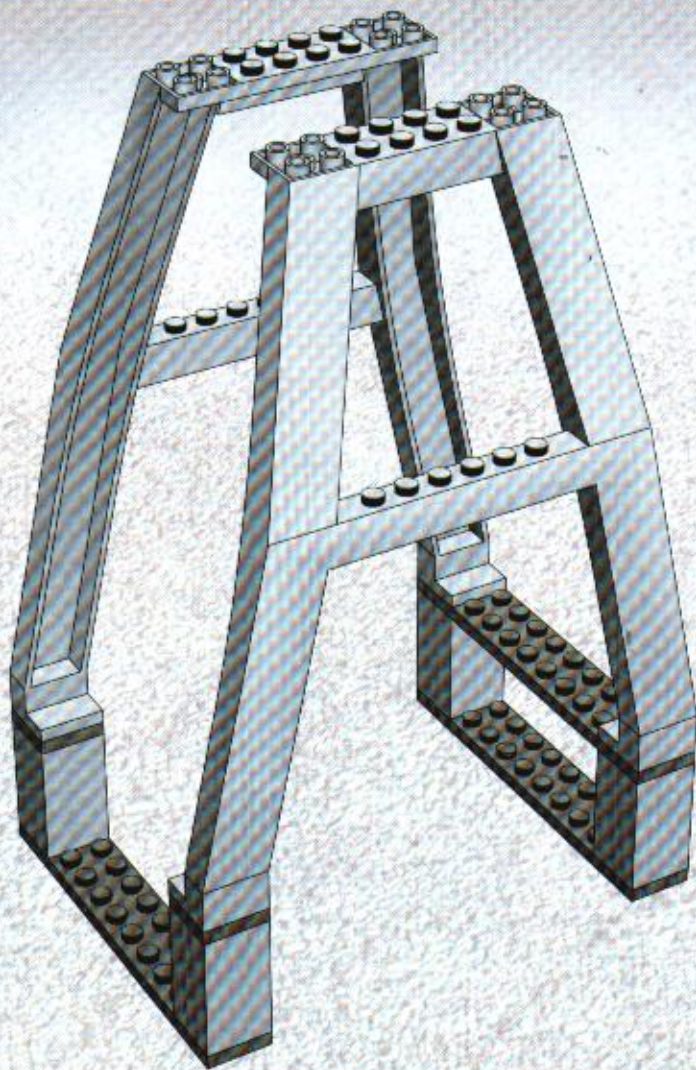

12

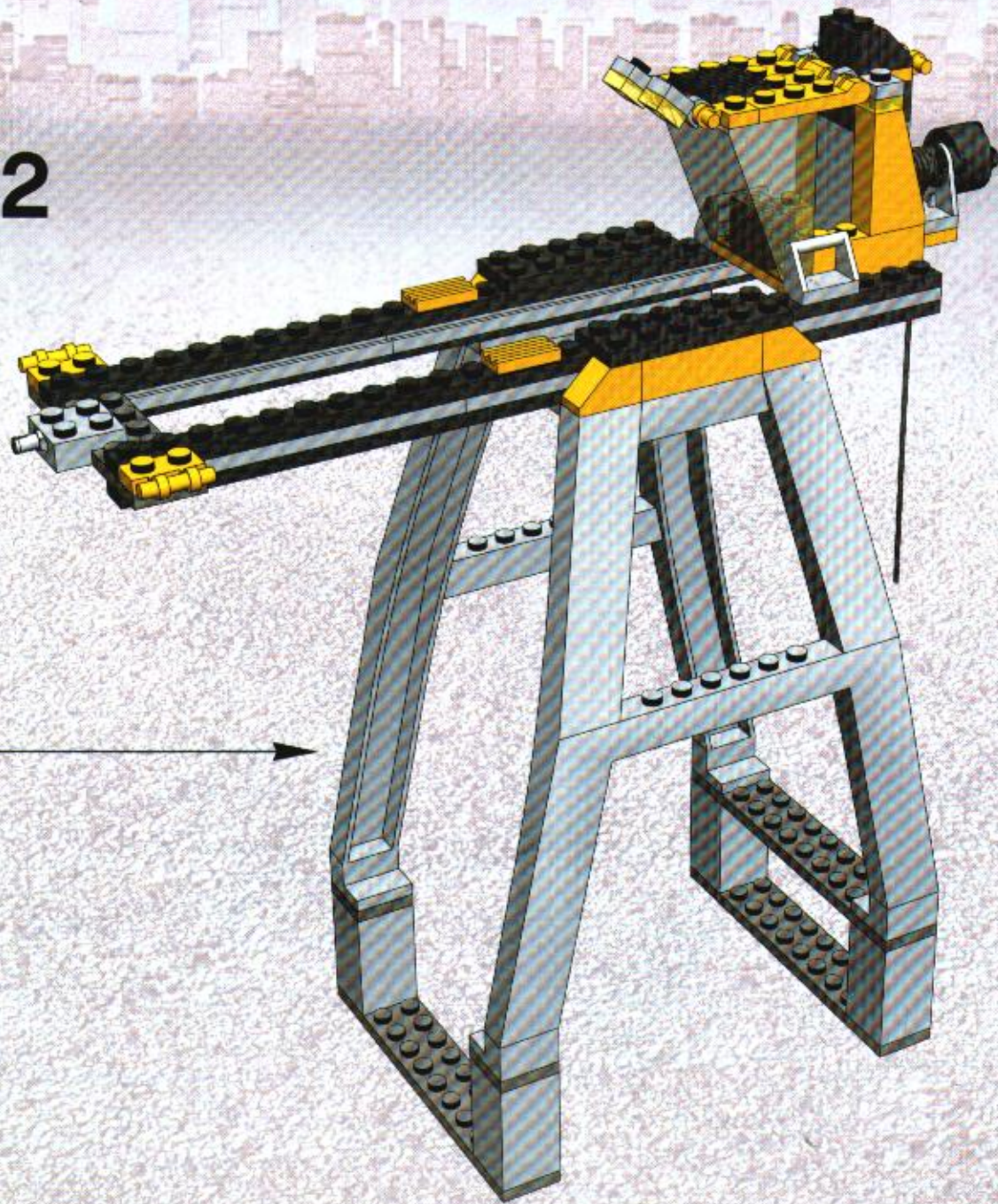

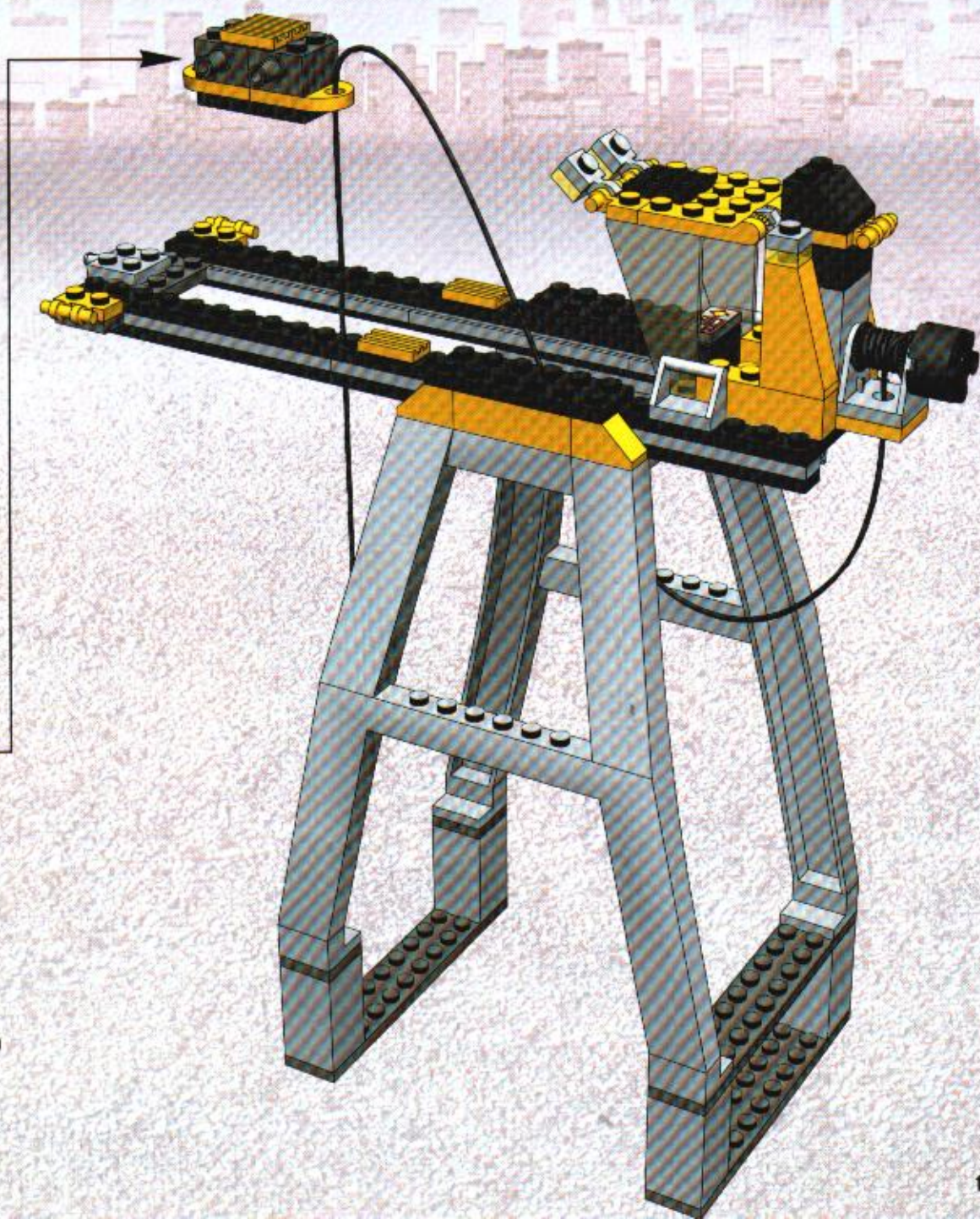
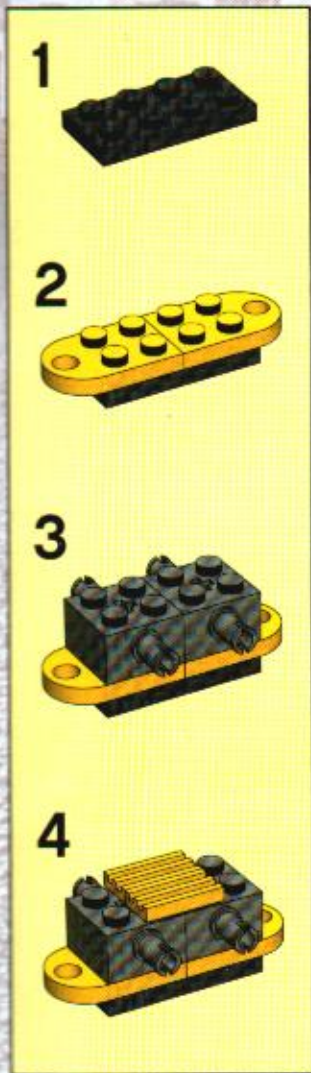

13

1



2

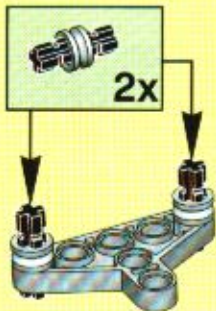

3

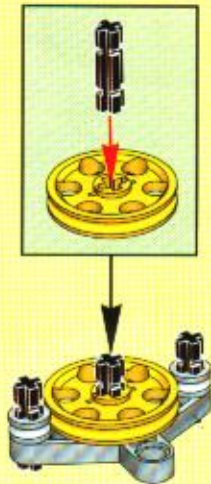

4

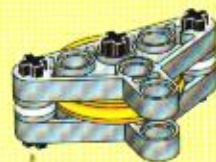

5

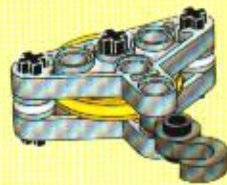

14



15



16

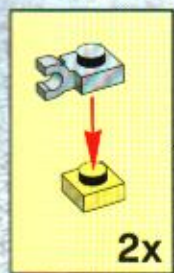





**LEGO**

World City ↑

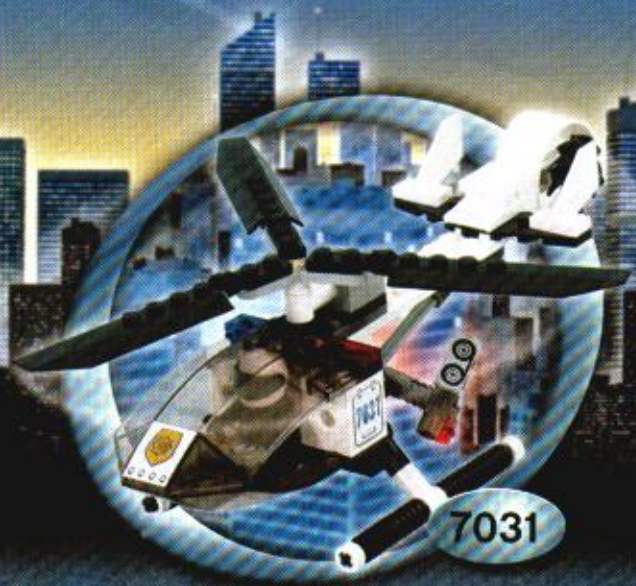
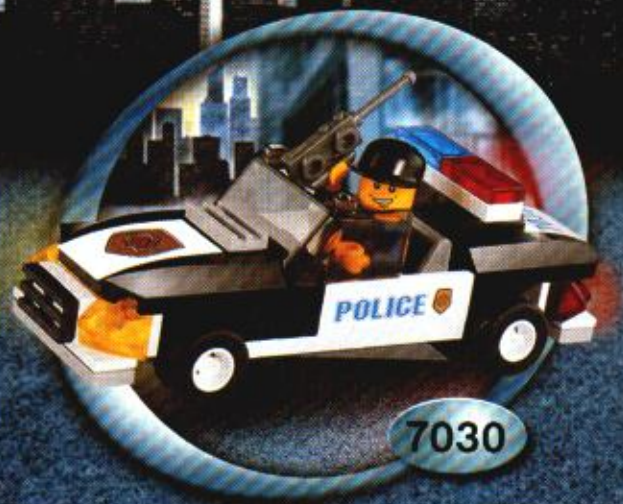

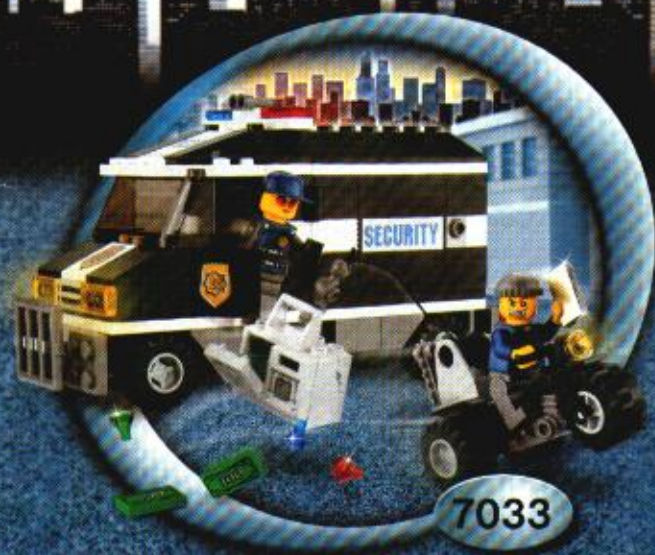

# Win! Gagne! Gewinne! 当たります



## Win LEGO® products

We would really like to know what you think about your new LEGO® product.

You could help us by answering a few questions at [www.ach Nielsen.aim.dk/lego](http://www.ach Nielsen.aim.dk/lego) and you are in with a chance of winning an exciting LEGO prize.

It only takes you about 3 minutes!



## Responde usuario LEGO®

Responde a algunas preguntas en inglés, francés, alemán o japonés en [www.ach Nielsen.aim.dk/lego](http://www.ach Nielsen.aim.dk/lego) para participar en el sorteo de algunos valiosos premios LEGO®.



## Gagne des produits LEGO®

Nous aimerions beaucoup savoir ce que tu penses de ton nouveau produit LEGO®.

Si tu veux bien nous aider en répondant à quelques questions sur [www.ach Nielsen.aim.dk/lego](http://www.ach Nielsen.aim.dk/lego), tu recevras peut-être bientôt l'un des nombreux super-pris offerts par LEGO aux participants.

Et cela ne te prendra que 3 minutes environ!



## Kövesd újul LEGO® Vásárló

Ha eldögtetsz a [www.ach Nielsen.aim.dk/lego](http://www.ach Nielsen.aim.dk/lego) honlapon az új LEGO® termékkel, német vagy japán nyelven megválaszolsz néhány kérdést, akkor részt veszél egy versenyben, amelyben értékes LEGO® díjakat nyarhatsz.



## Gewinne LEGO® Produkte

Wir sind sehr an deiner Meinung über dein neues LEGO® Produkt interessiert.

Wenn du uns den Gefallen tust und unter [www.ach Nielsen.aim.dk/lego](http://www.ach Nielsen.aim.dk/lego) Fragen beantwortest, kannst du einen tollen LEGO Preis gewinnen.

Das Ganze dauert nur etwa 3 Minuten!



## Cete Consumidor da LEGO®

Ào responder a algumas perguntas em inglês, francês, alemão ou japonês no endereço [www.ach Nielsen.aim.dk/lego](http://www.ach Nielsen.aim.dk/lego) irá participar num concurso para ganhar valiosos prémios da LEGO®.



## 抽選でレゴ製品が当たります

私たちは、皆さんがレゴ製品についてどんな感想をお持ちか、是非知りたいと思っています。

[www.ach Nielsen.aim.dk/lego](http://www.ach Nielsen.aim.dk/lego)にアクセスいただき、質問にご回答いただきますと、抽選で楽しいレゴ製品が当たります。

アンケートの回答には、ほんの3分ほどしかかかりません!

