

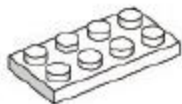

1

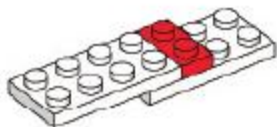

2



3



4

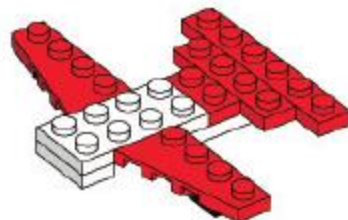

5

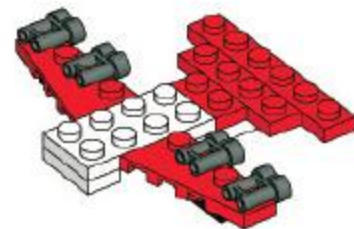

6

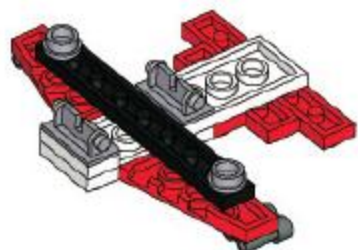

7

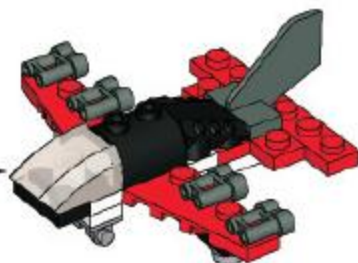
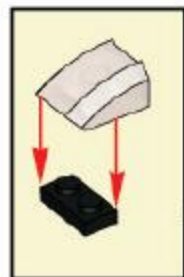

8

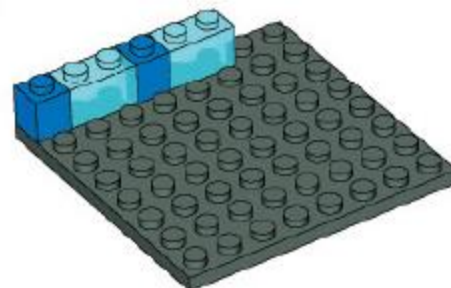

9

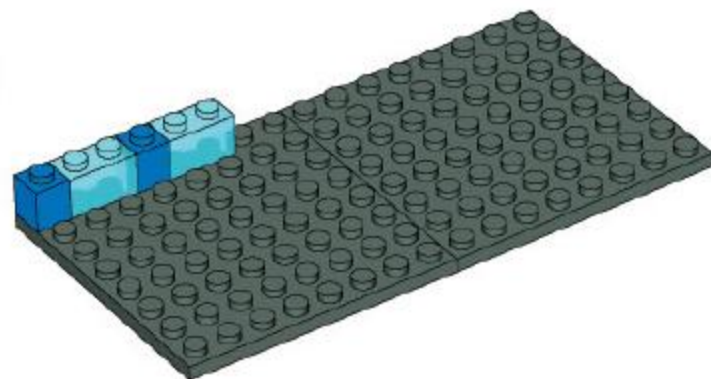

10

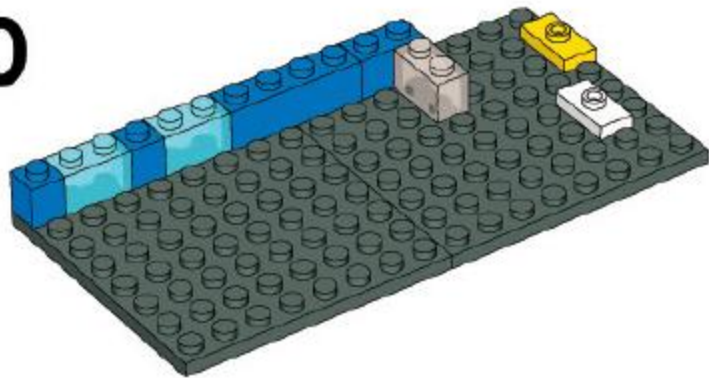

11

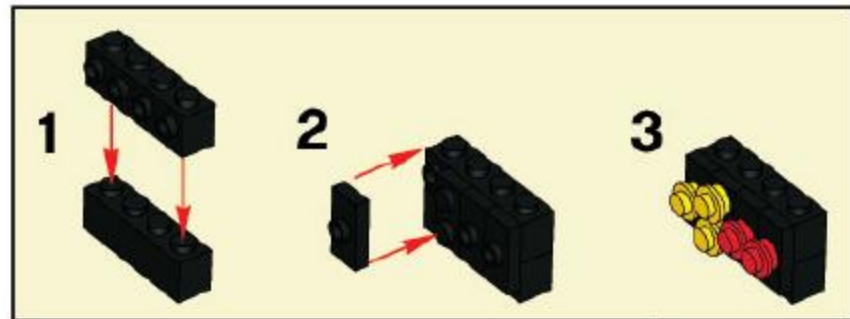
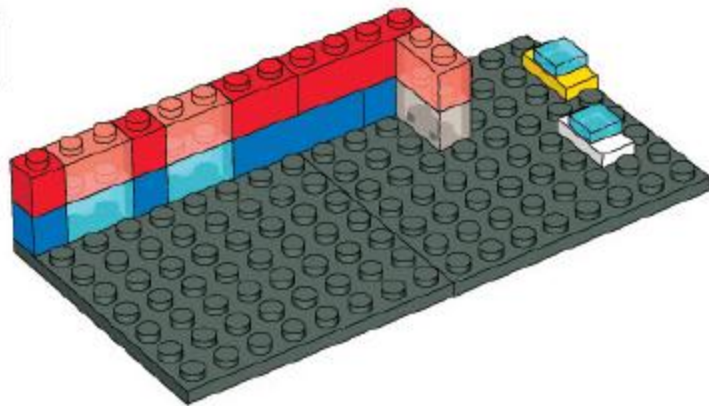

12

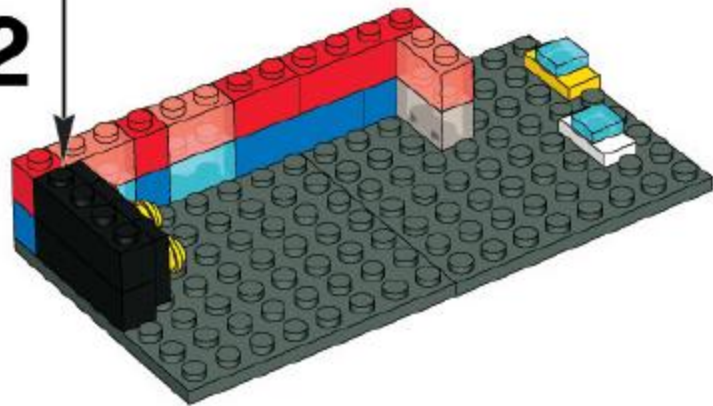

13

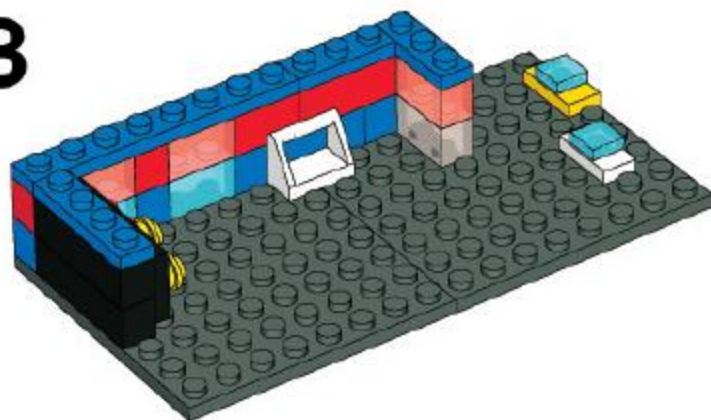

14

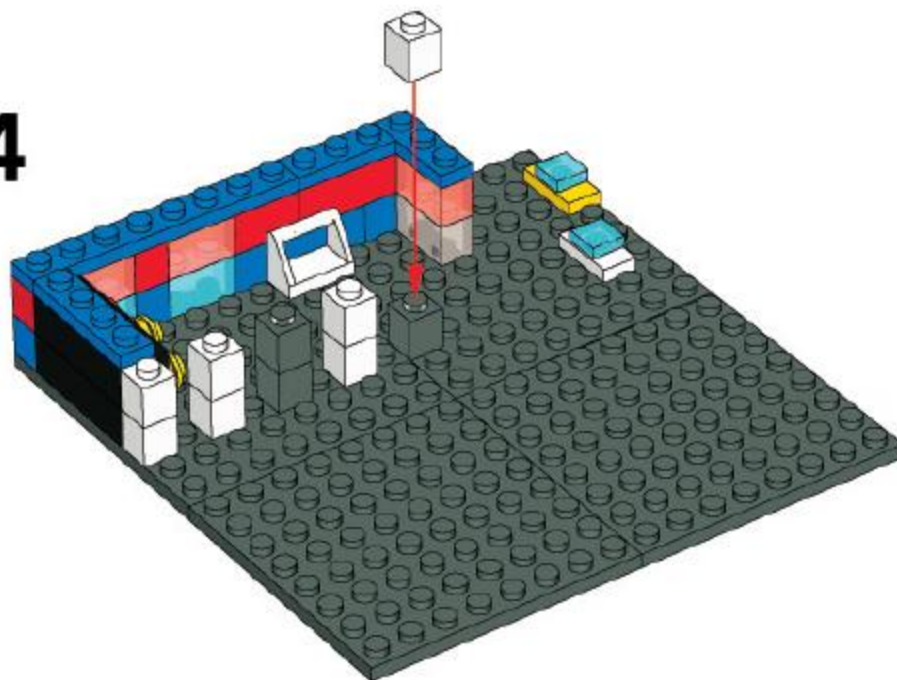

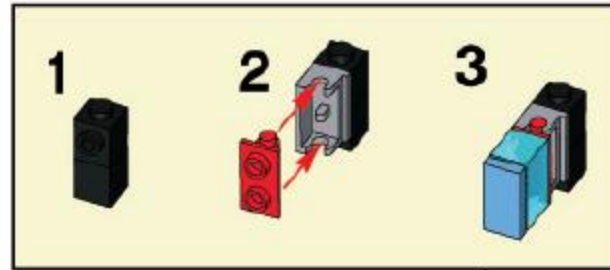

15

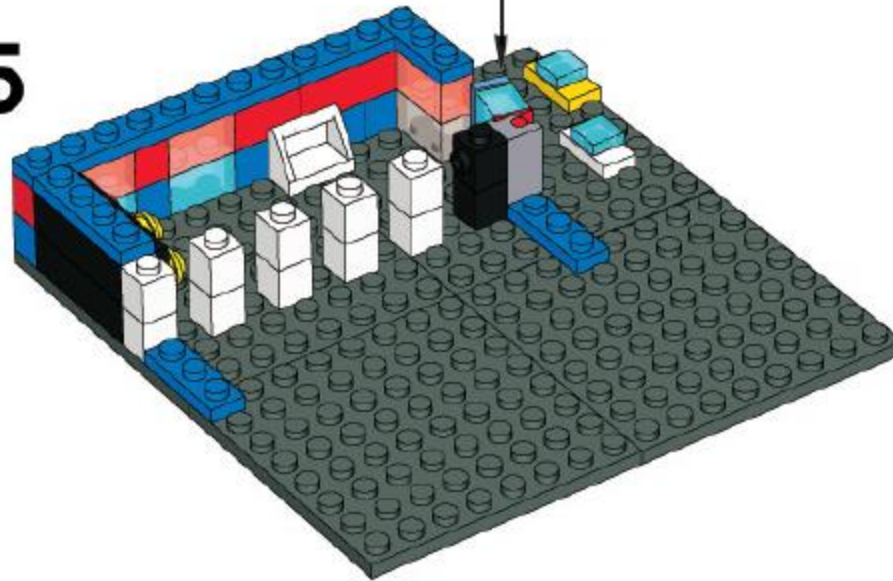

16

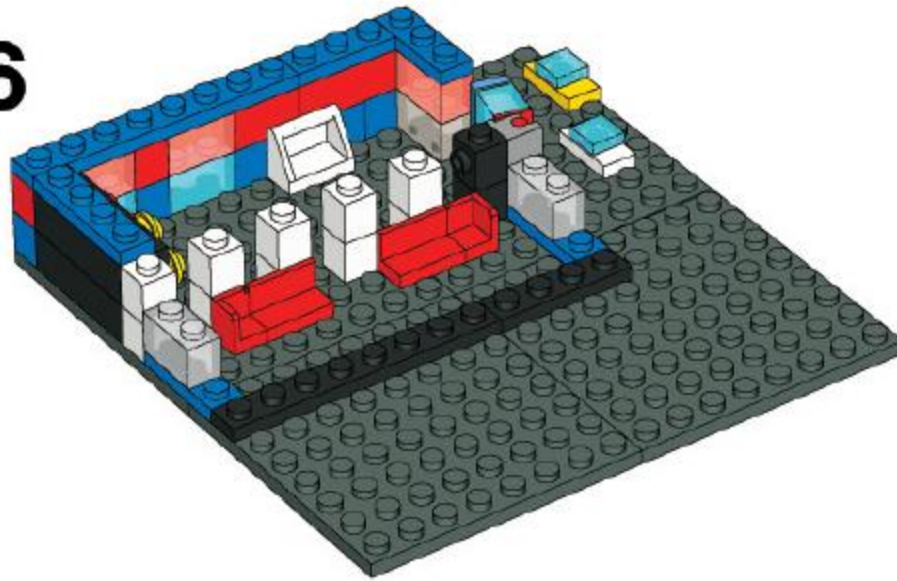

17

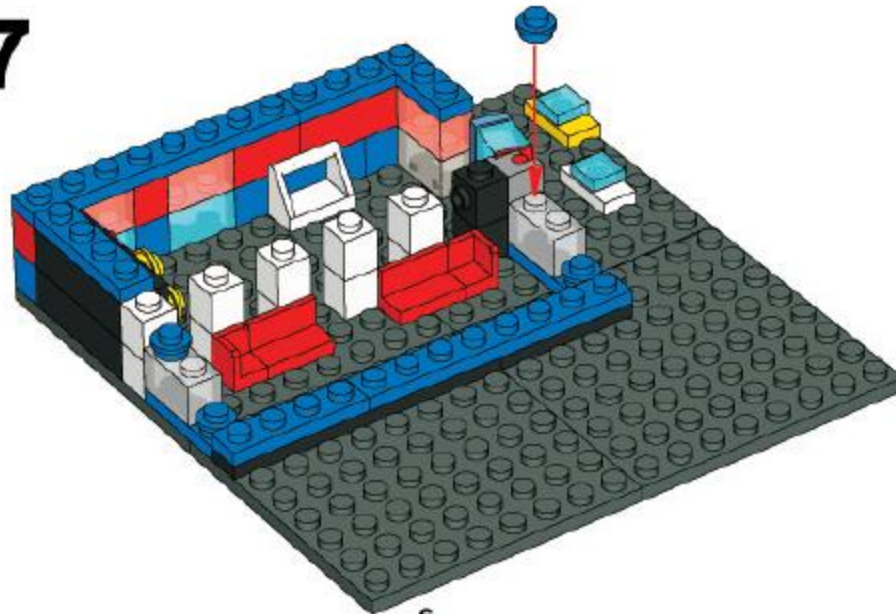

18

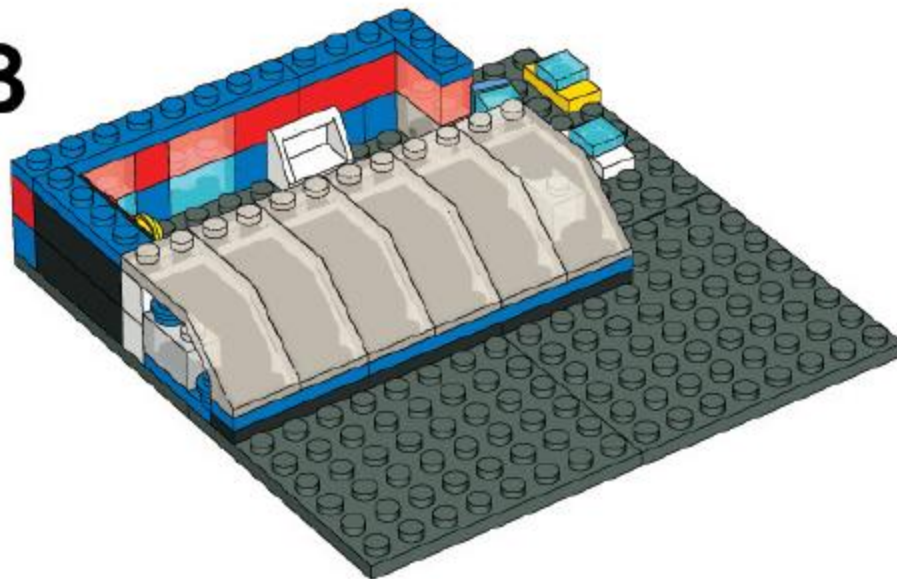

19

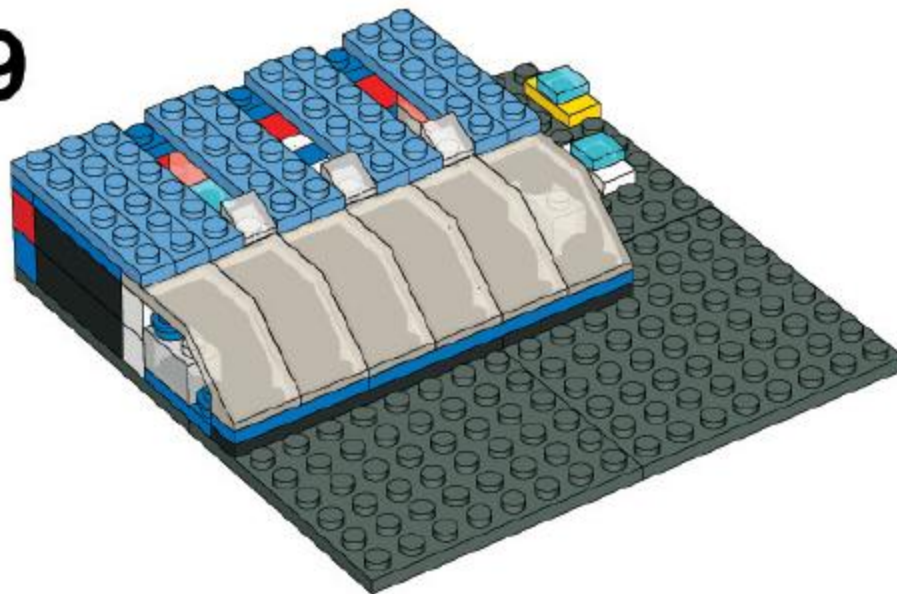

20

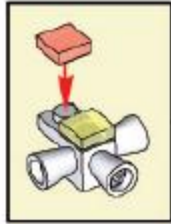
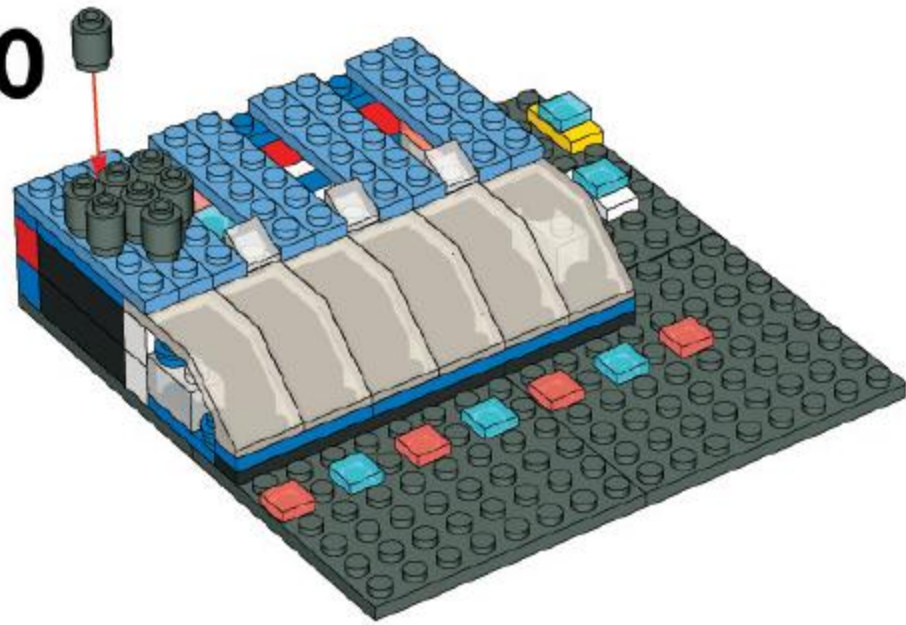

21

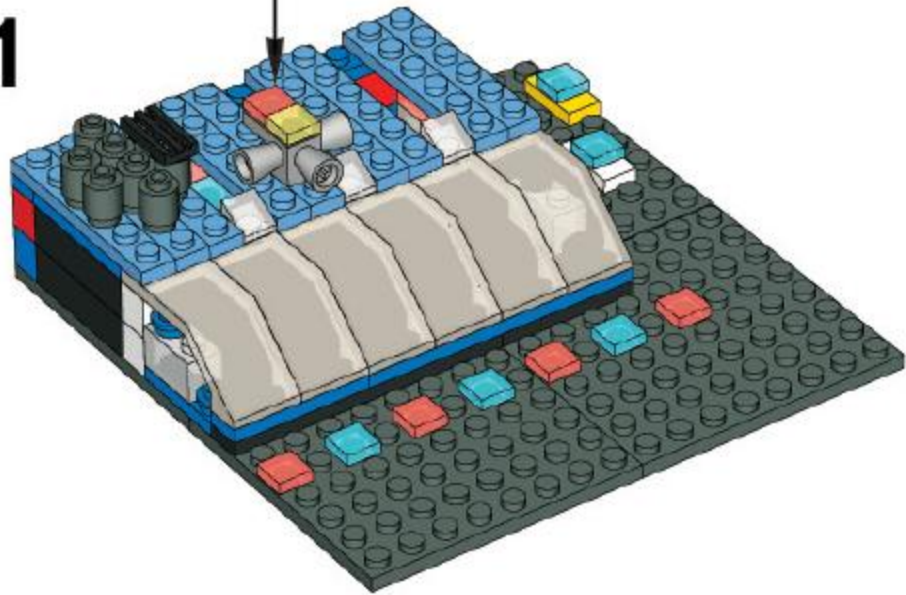

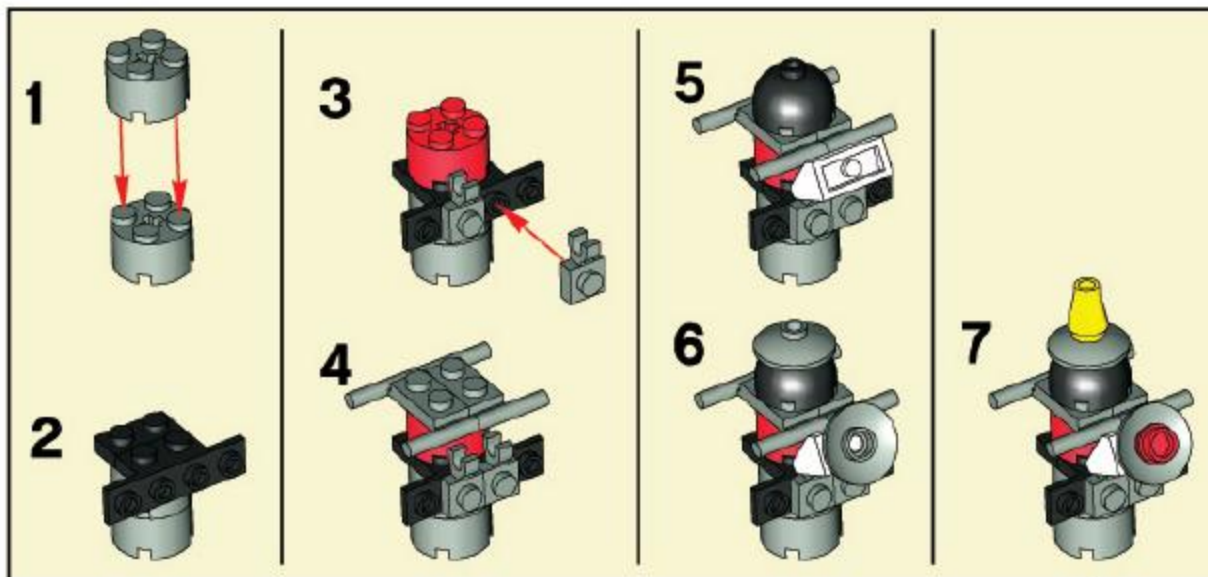

22

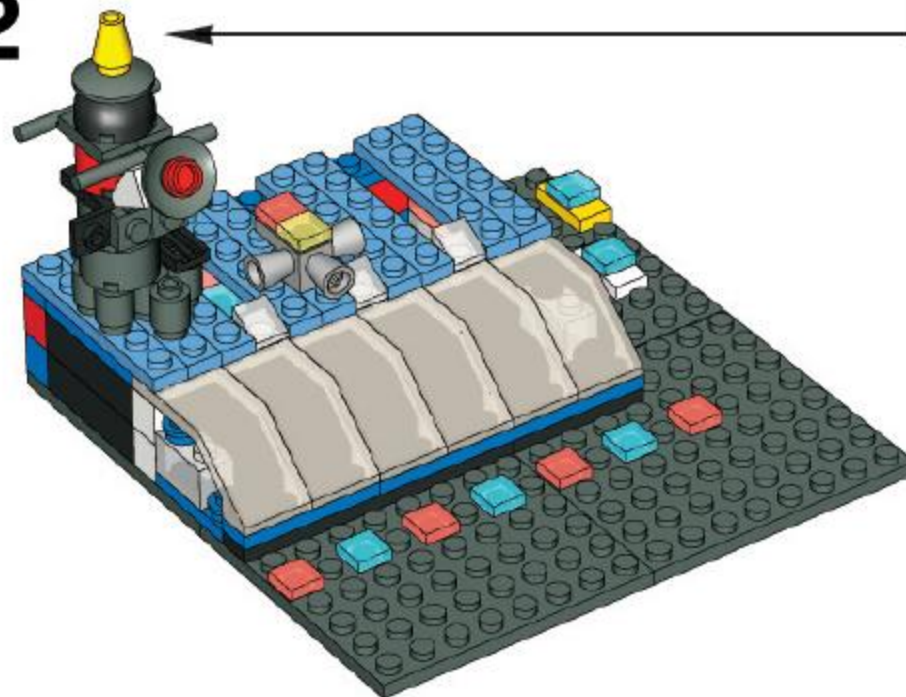

23

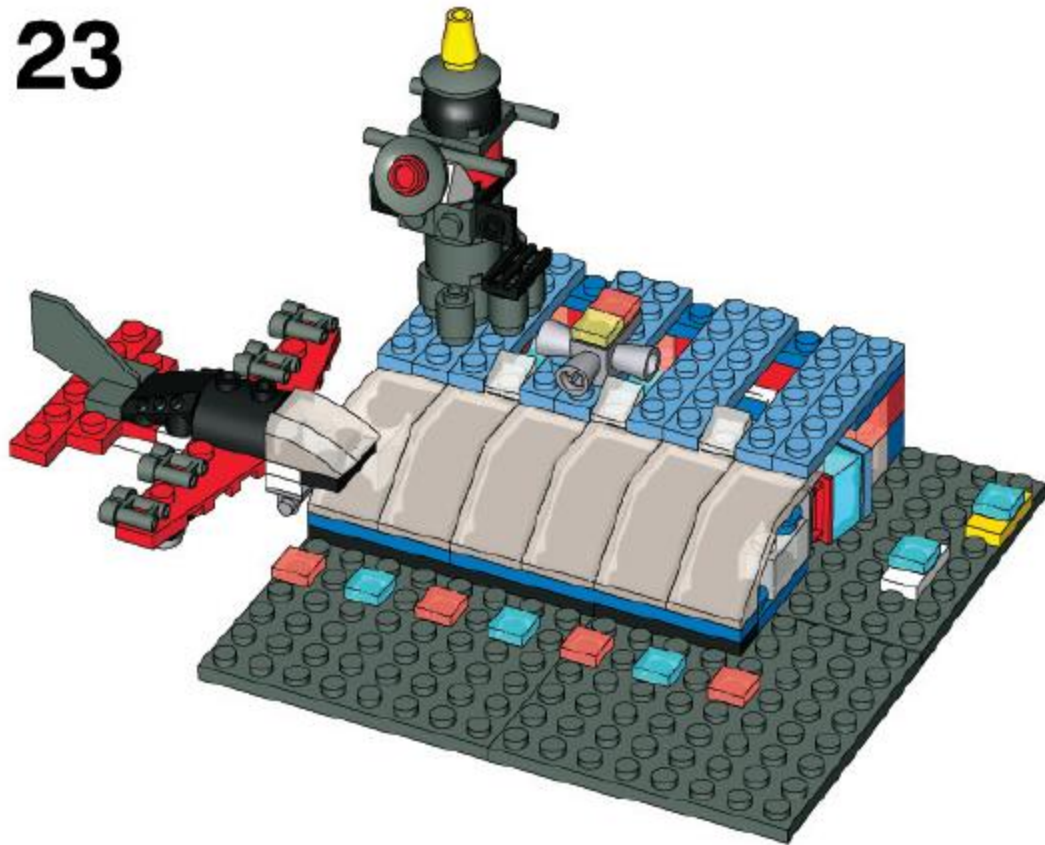

10x 300501
2x 243201
1x 302301
1x 379401
2x 302001
1x 4226179
1x 4217722
6x 4204624
1x 3003944
5x 4218438
3x 306543
5x 3003941
3x 306541
3x 4244362
2x 306540

3x 614121
2x 4190219
2x 486621
2x 300521
1x 300421
1x 301021
1x 614321
1x 302321
1x 393621
1x 371021
1x 366621
1x 4161329
1x 4160866

4x 614123
2x 300523
1x 300423
1x 301023
4x 362323
2x 371023
2x 346023
1x 4166345
9x 4179629
3x 614124
1x 458924
1x 379424

1x 300526
1x 4214559
1x 301026
1x 4162443
1x 4200023
1x 4216660
1x 4163524
1x 241226
3x 302326
3x 379426
1x 371026
2x 346026
1x 4282746

2x 4211526
2x 4211470
1x 4211469
1x 4223363

8x 4211090
2x 4249139
2x 4211010
2x 4216973
4x 4211051
1x 4184299
2x 4263176
4x 4210802

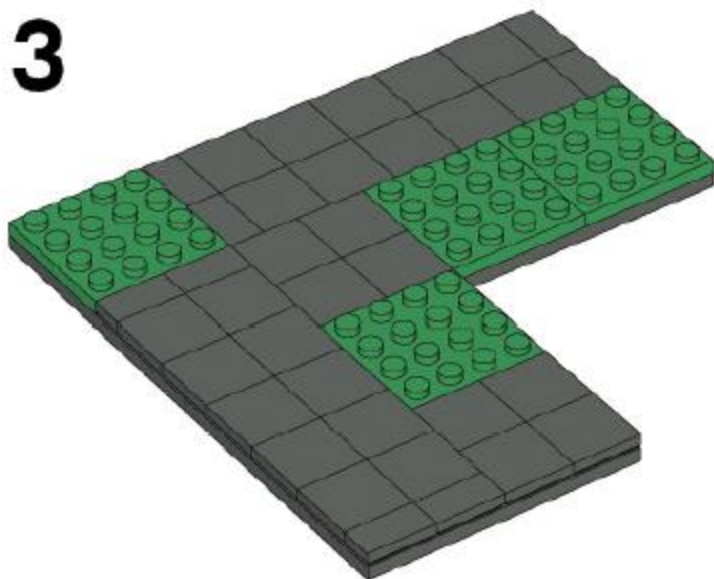
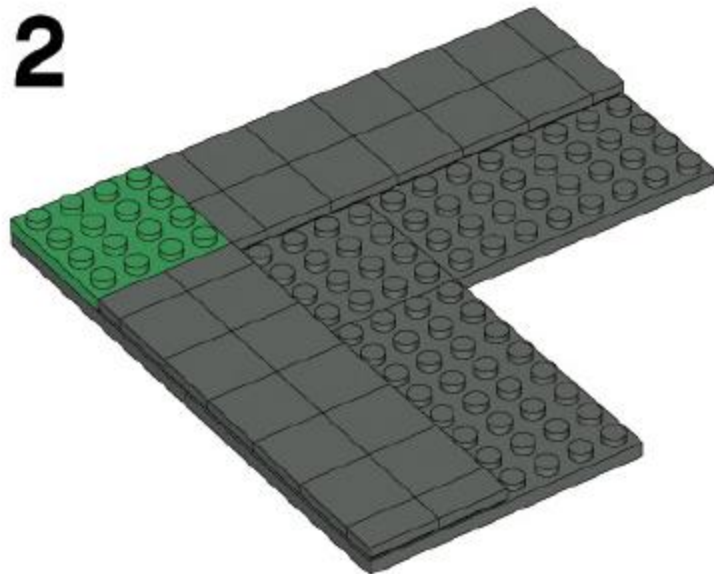
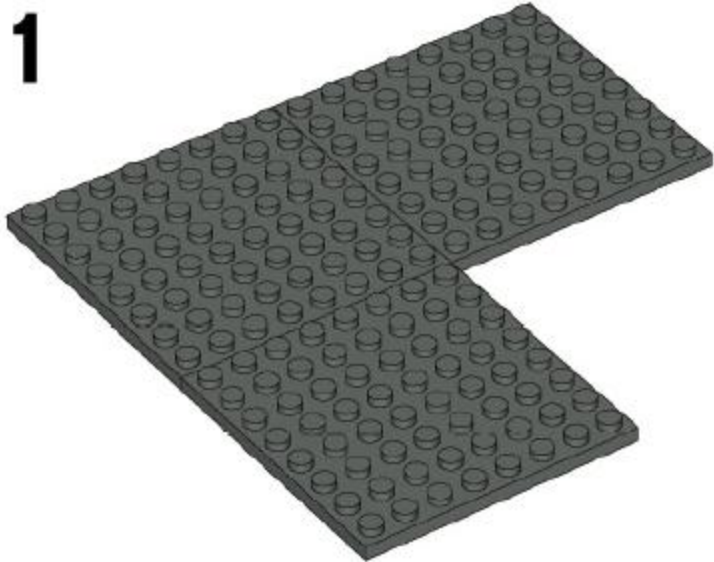

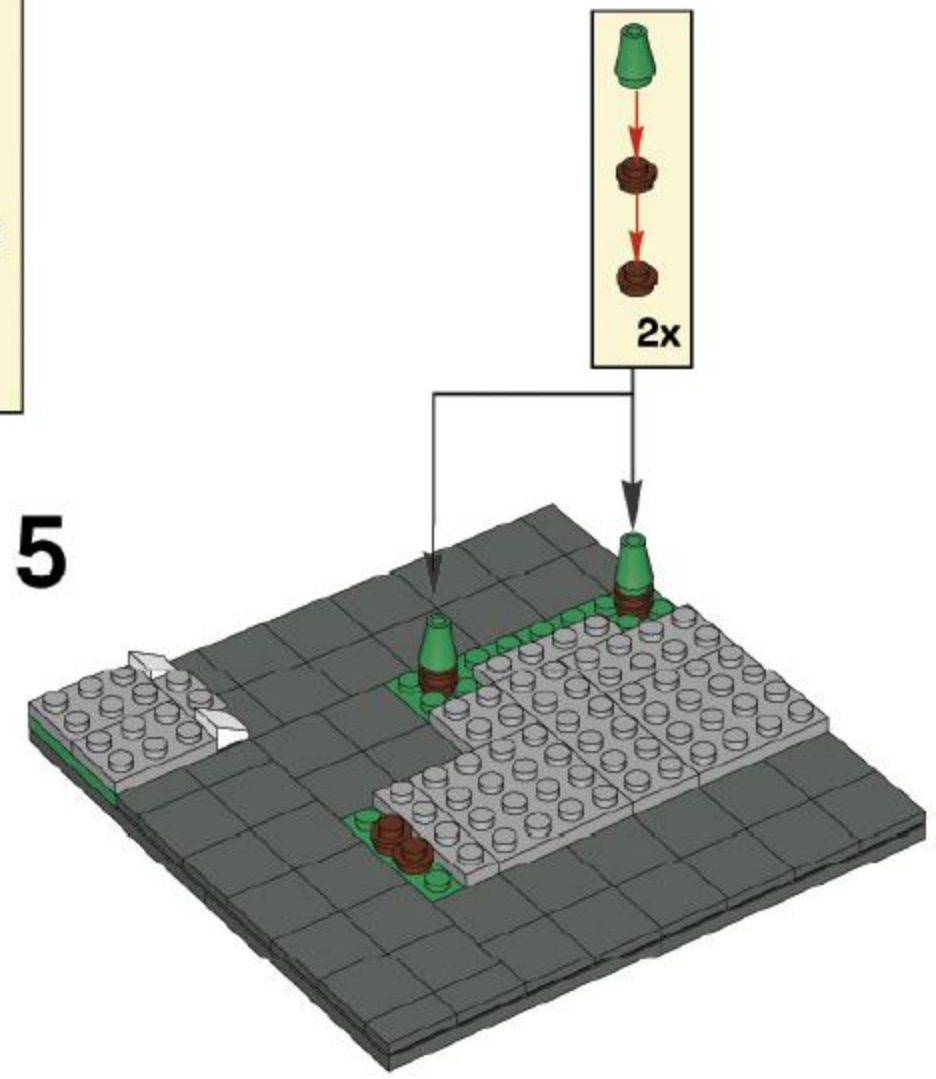
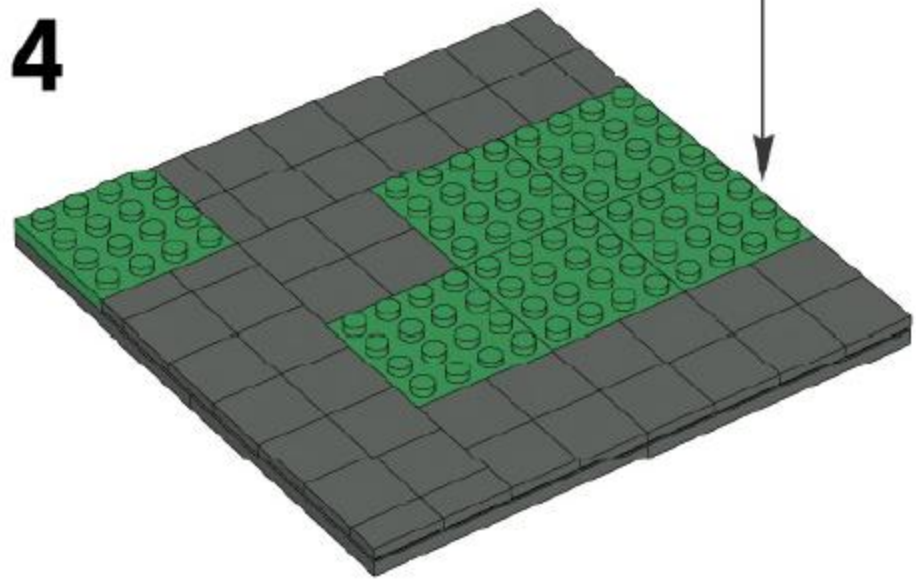
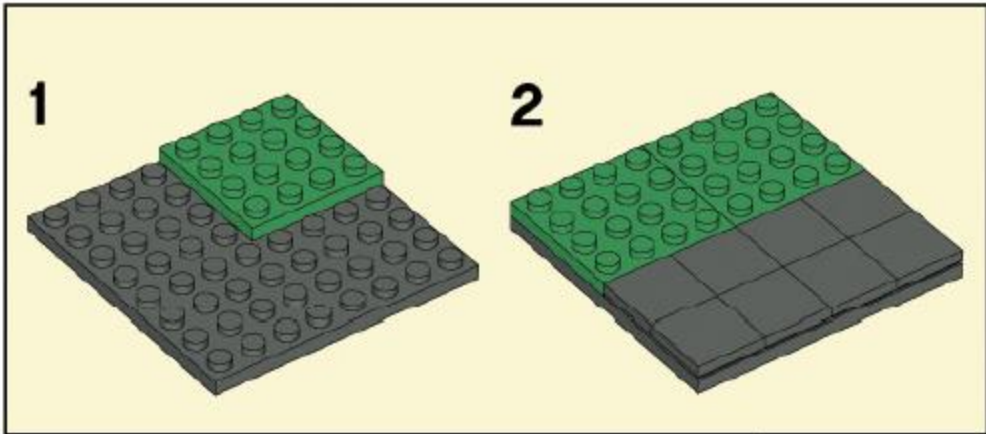

6

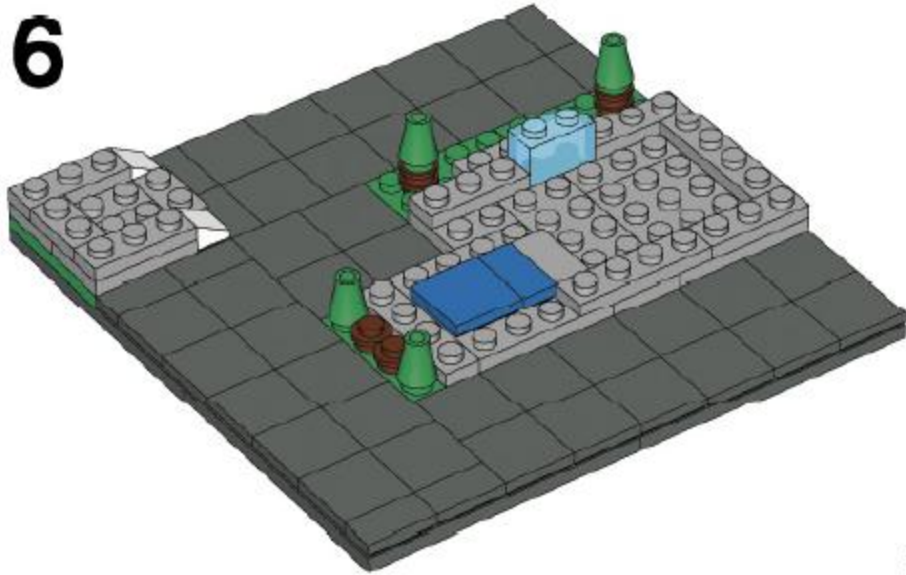

7

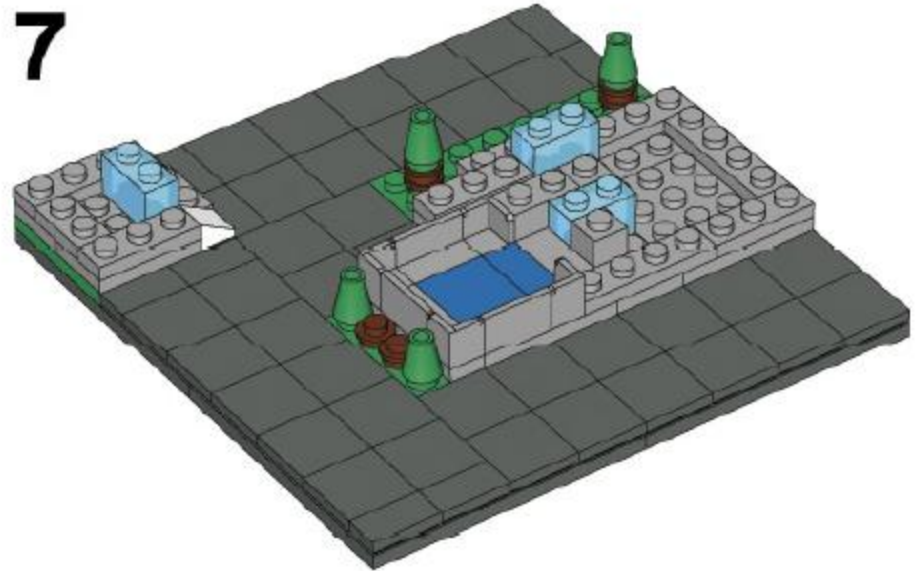

8

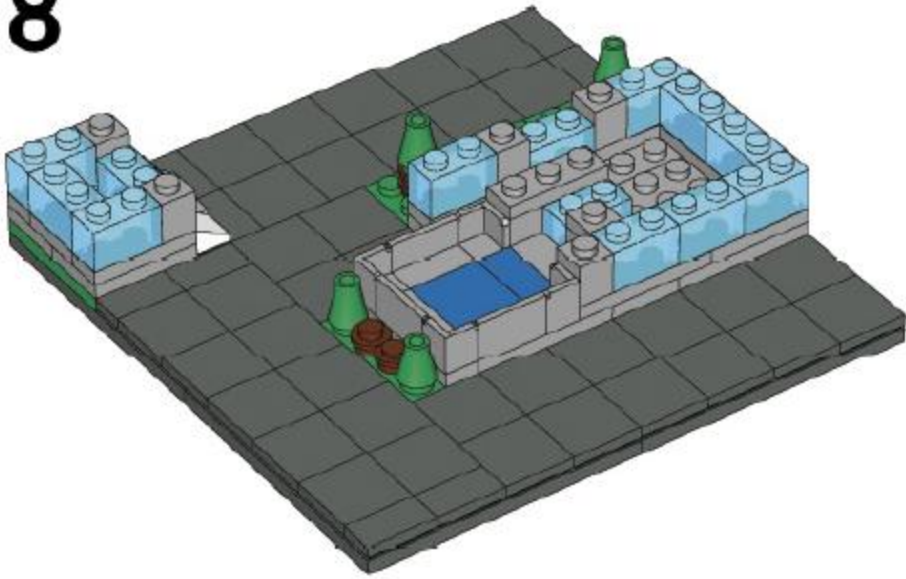

9

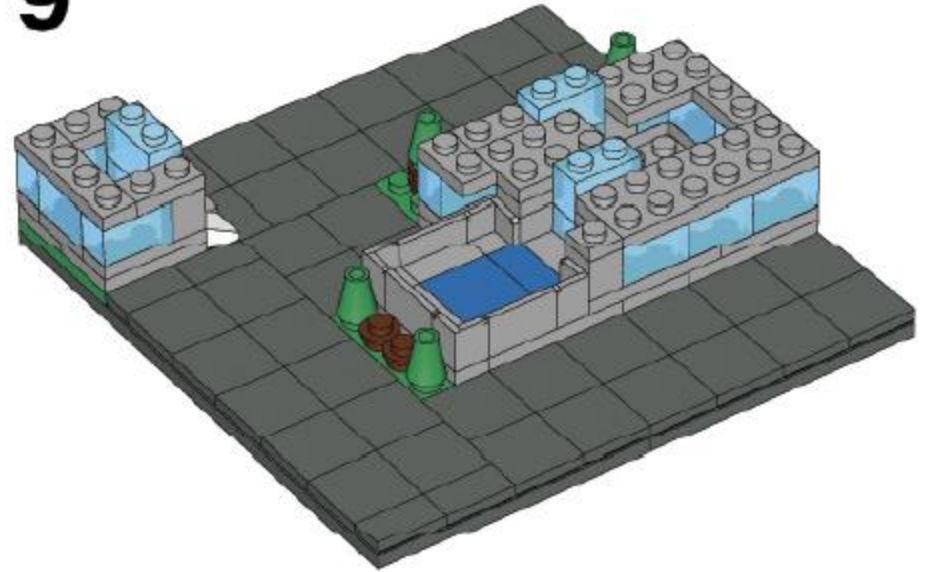

10

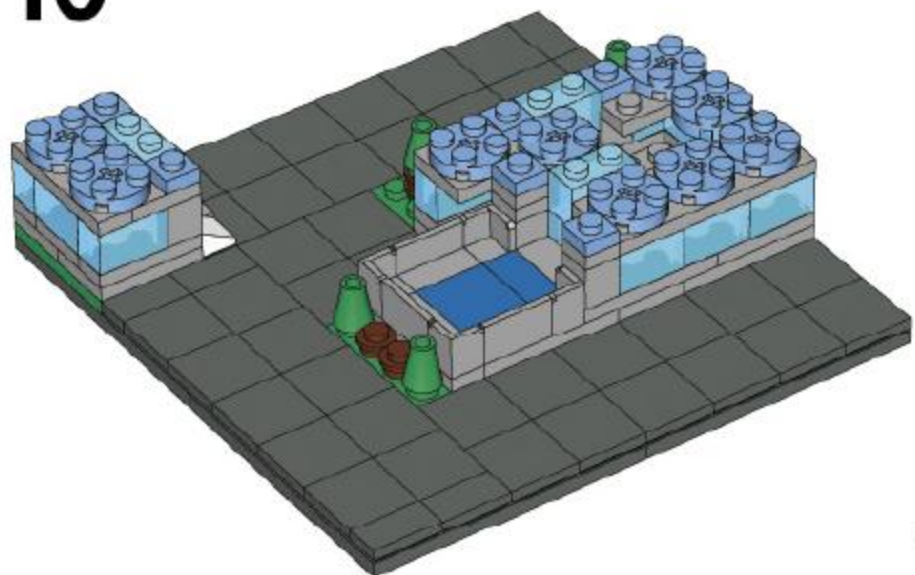

11

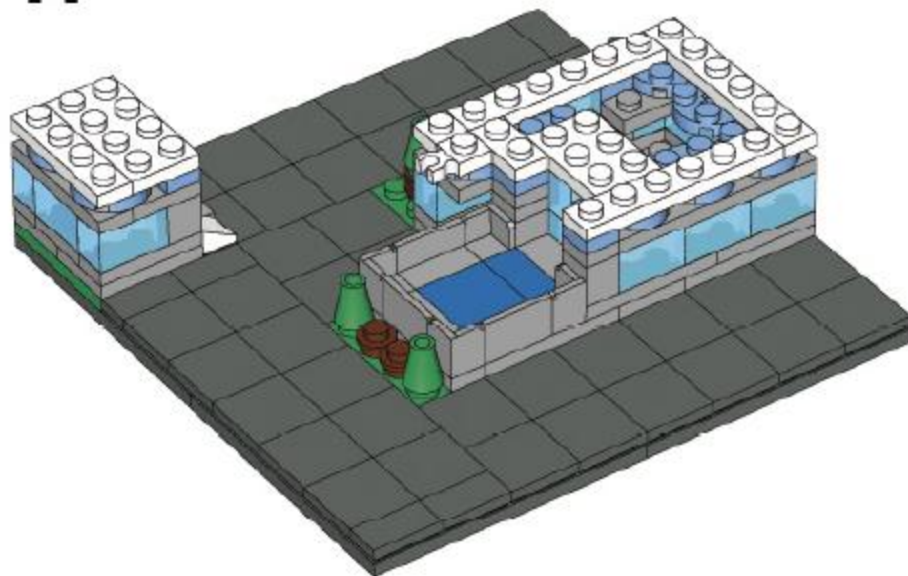

12

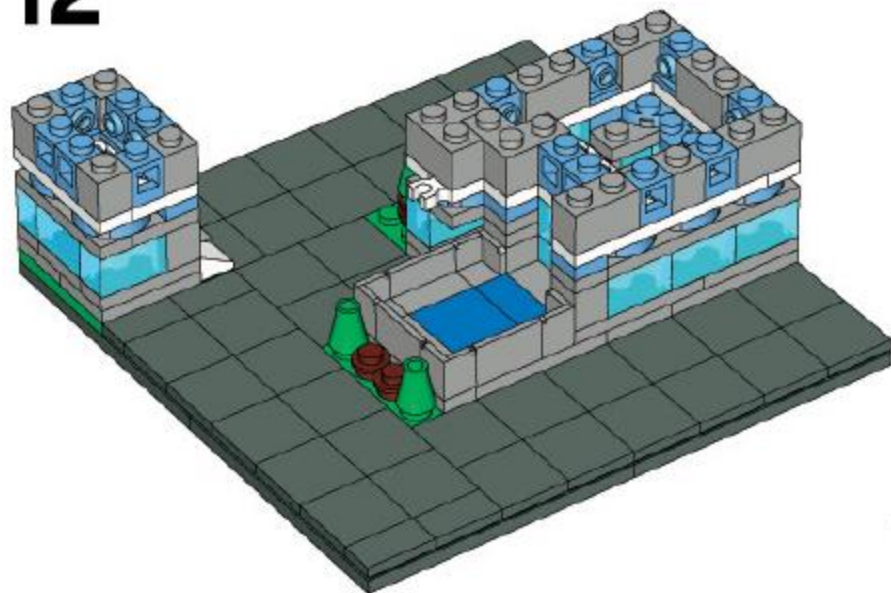

13

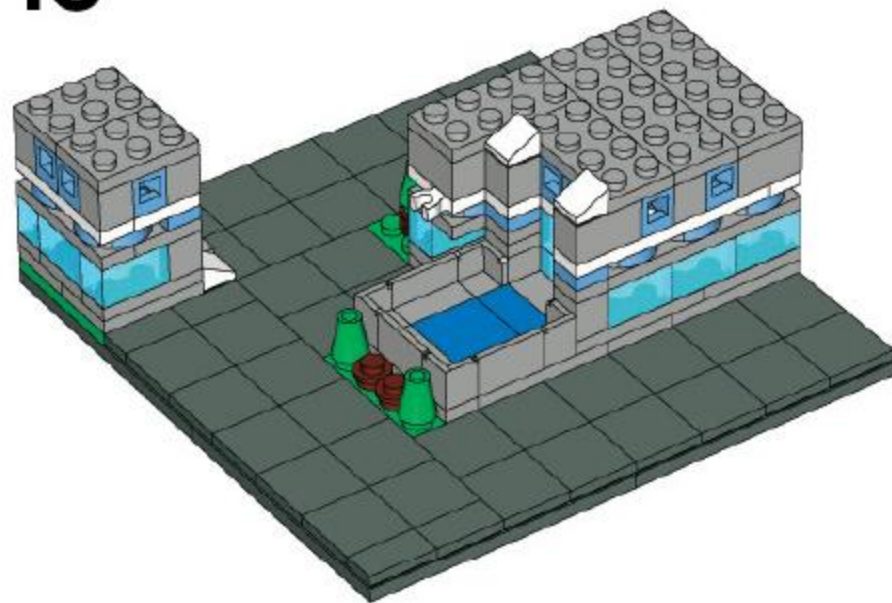

14

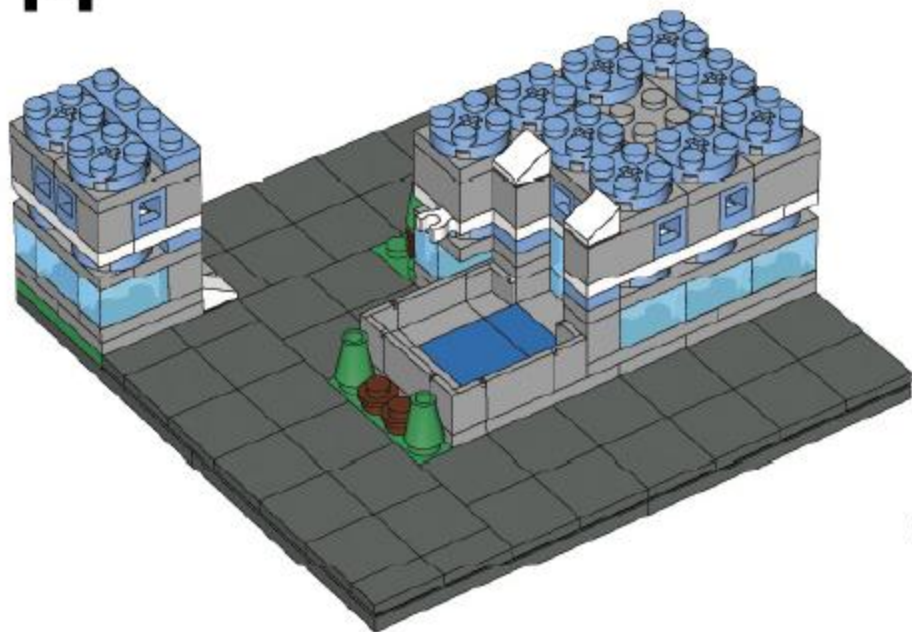

15

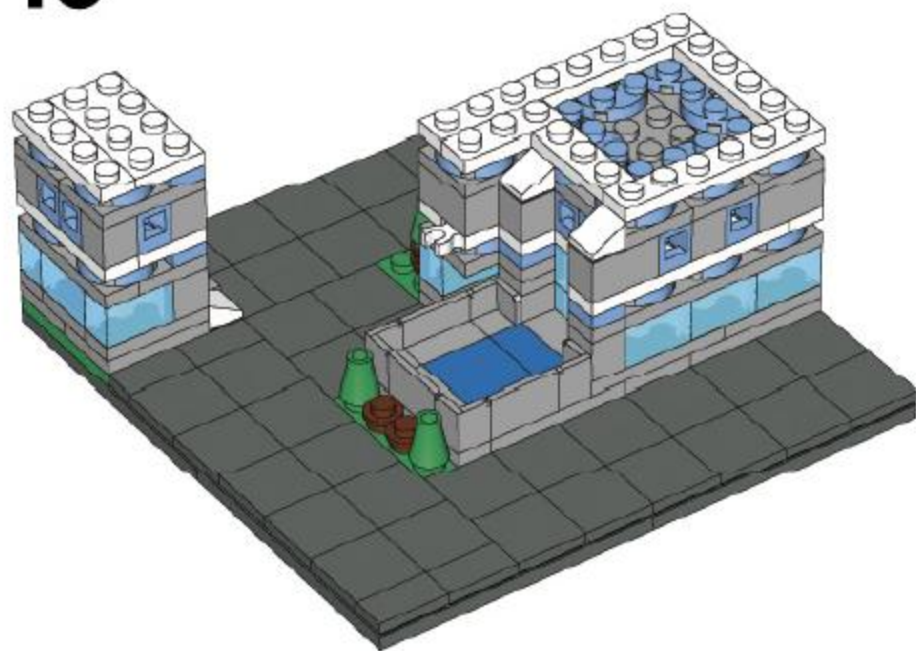

16

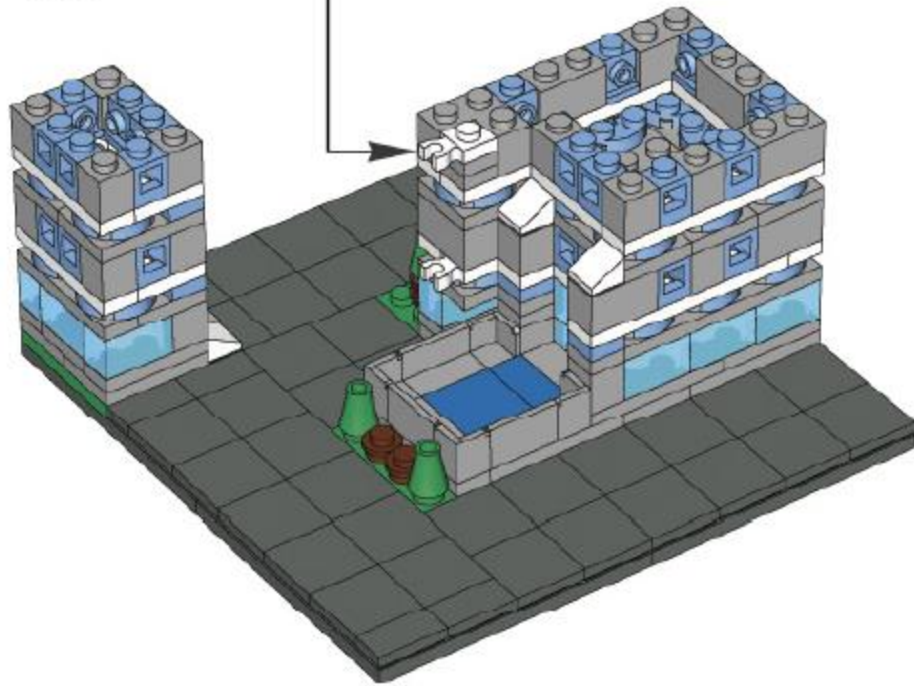
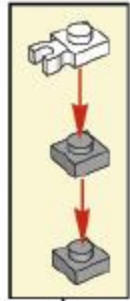

17

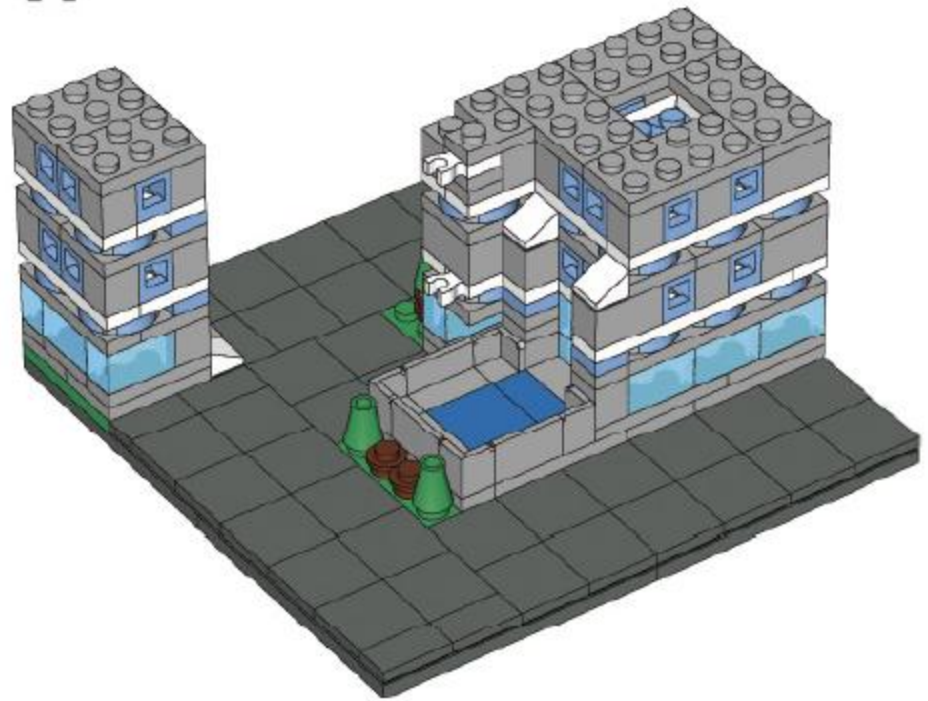

18

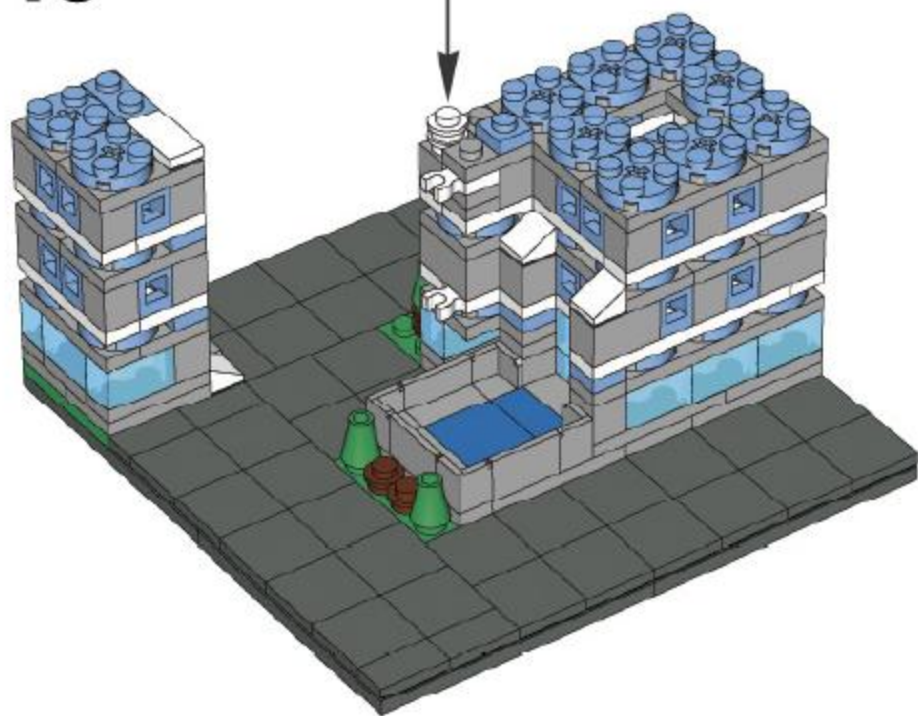
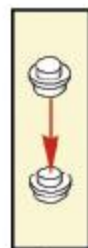

19



20

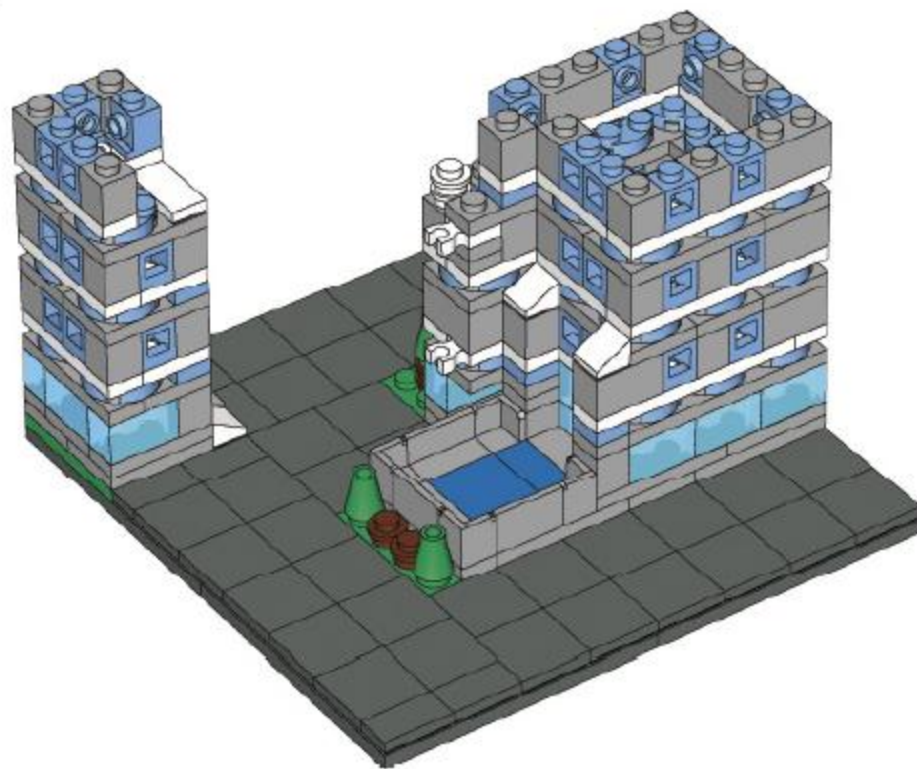

21

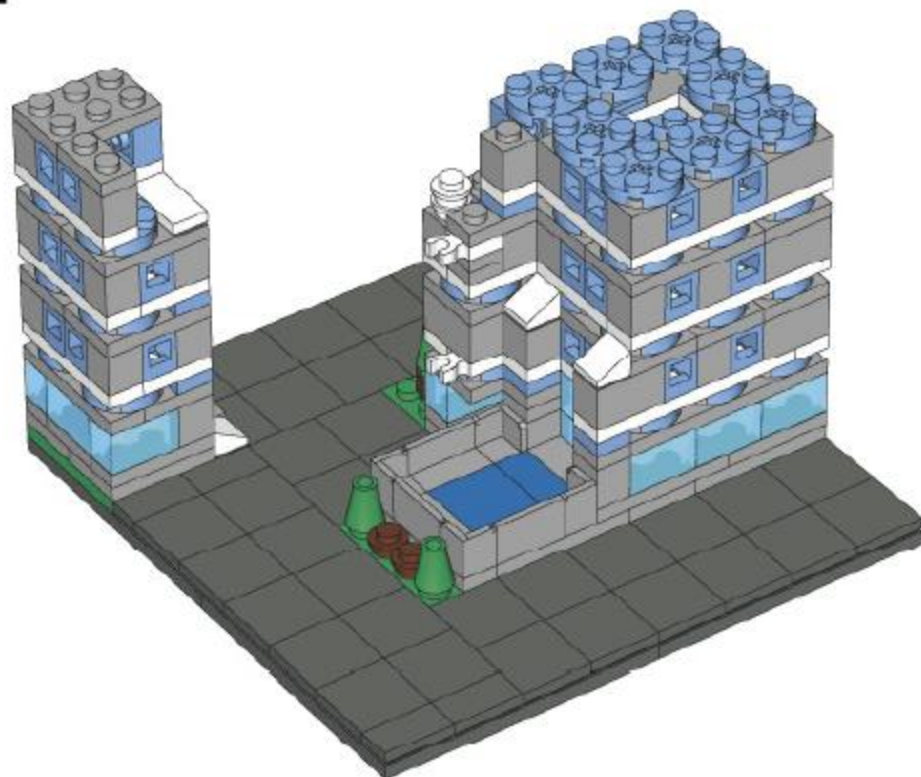

1

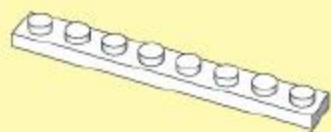

2

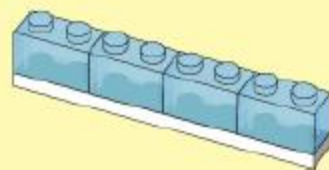

3

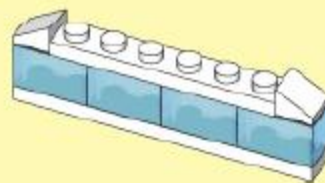

4

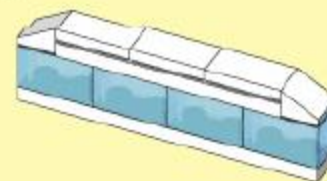

22

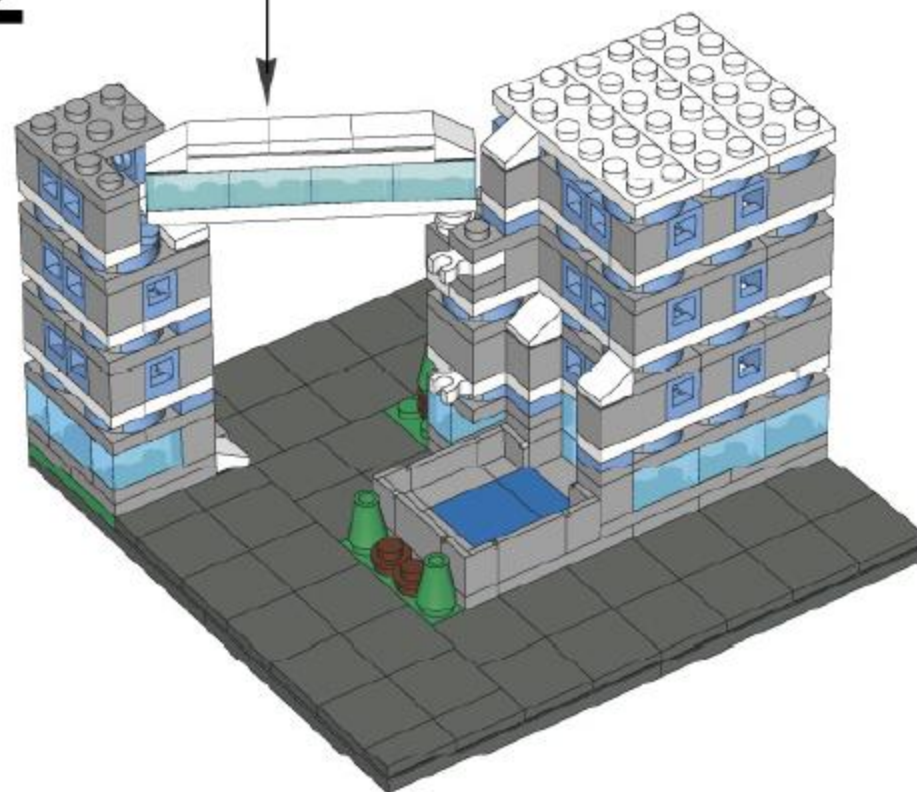

23

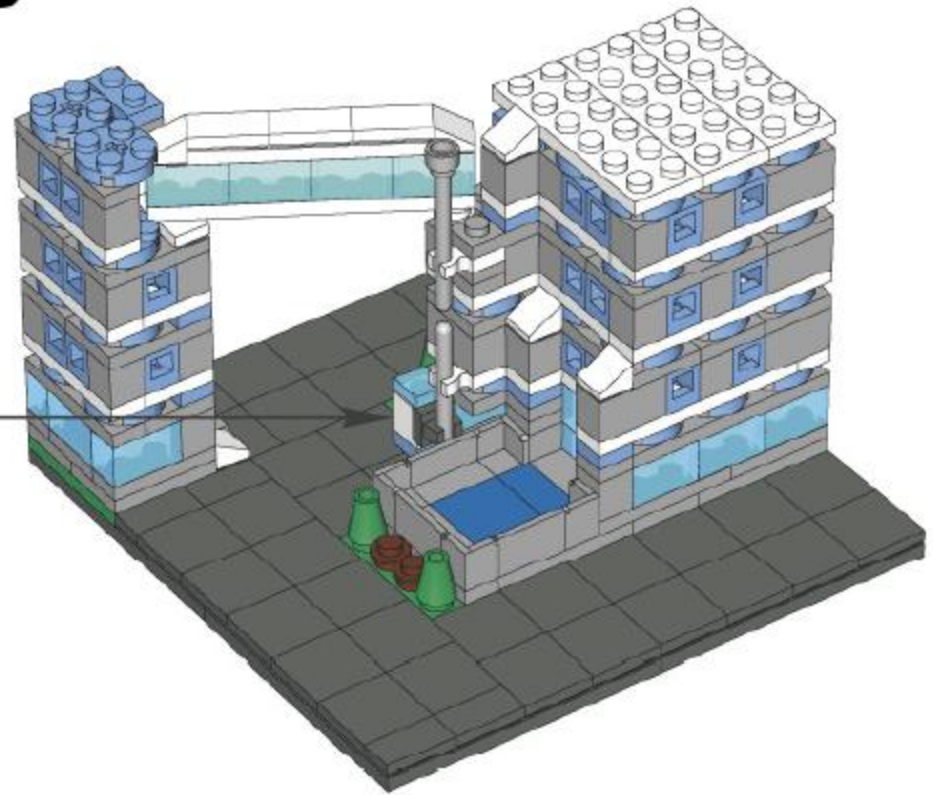
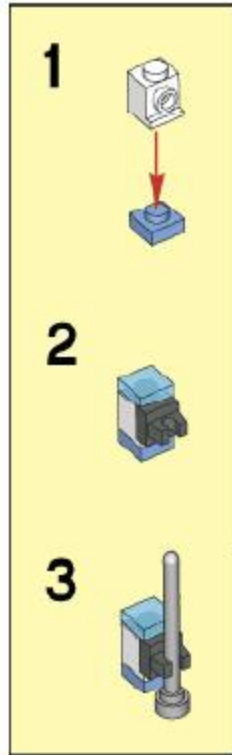

24

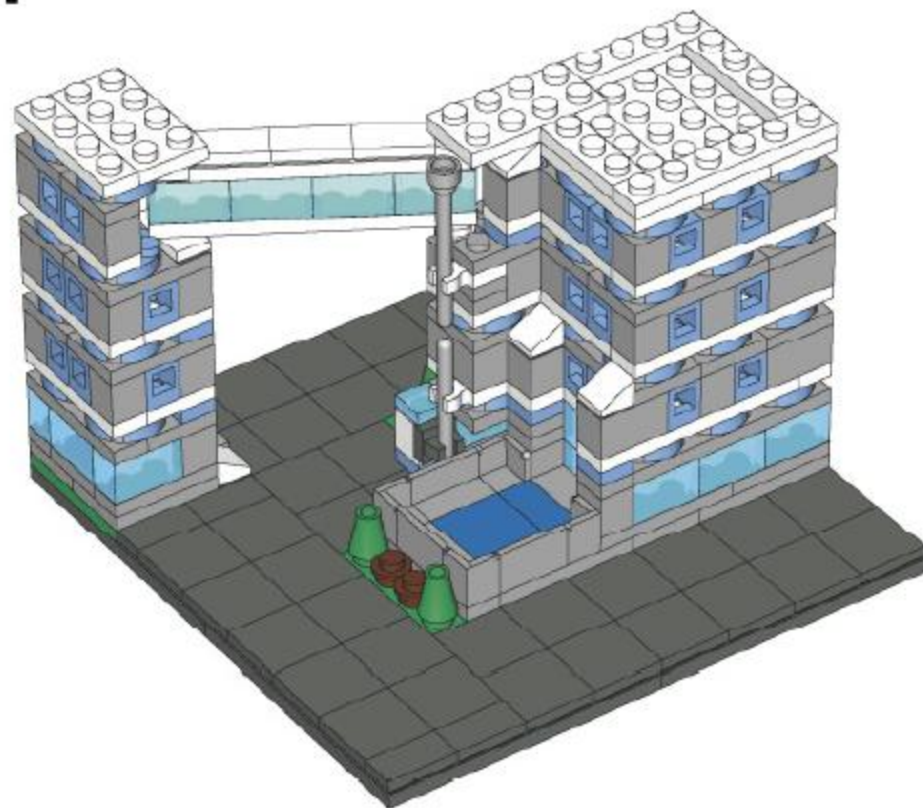

25

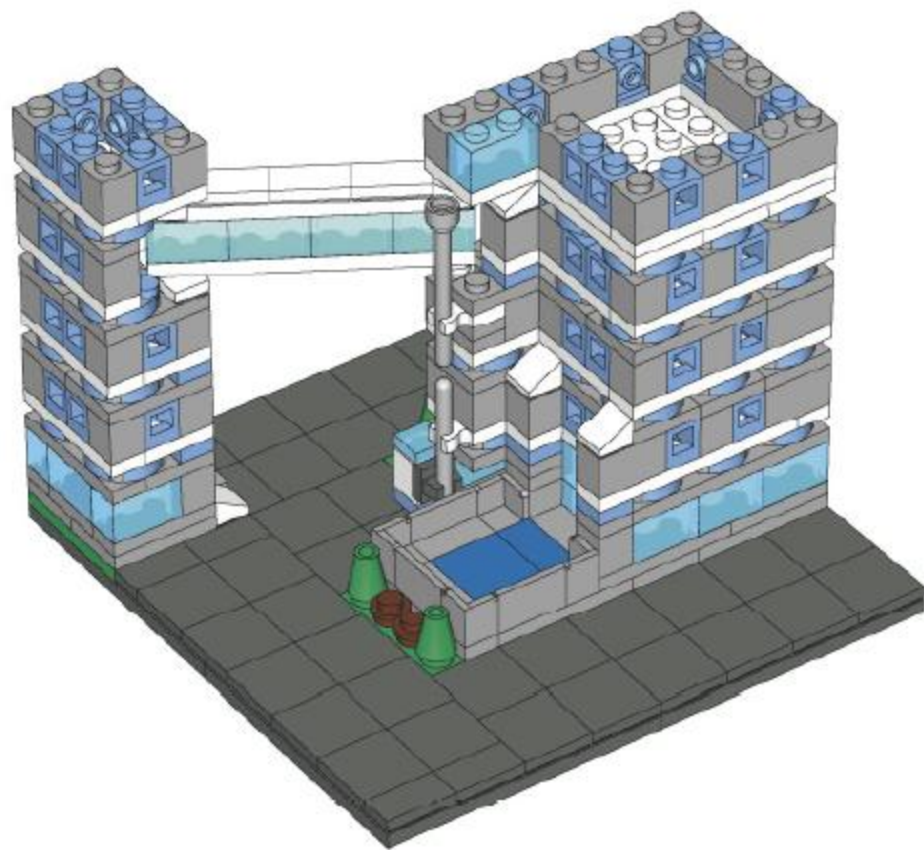

26

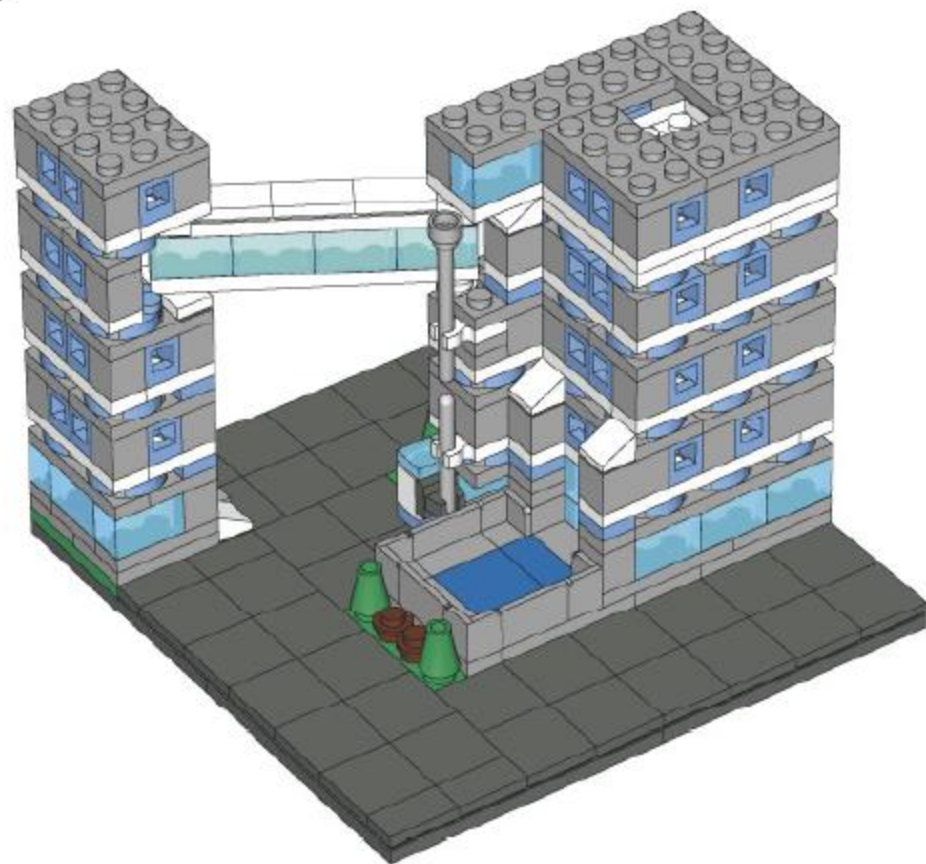

27

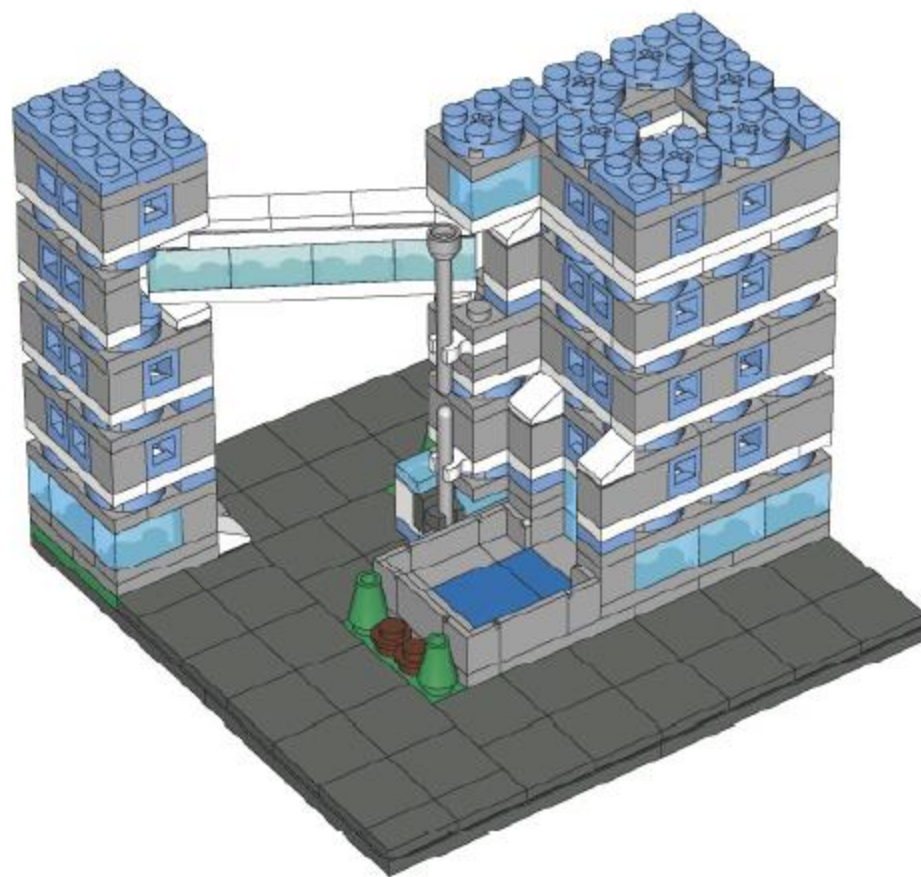

28

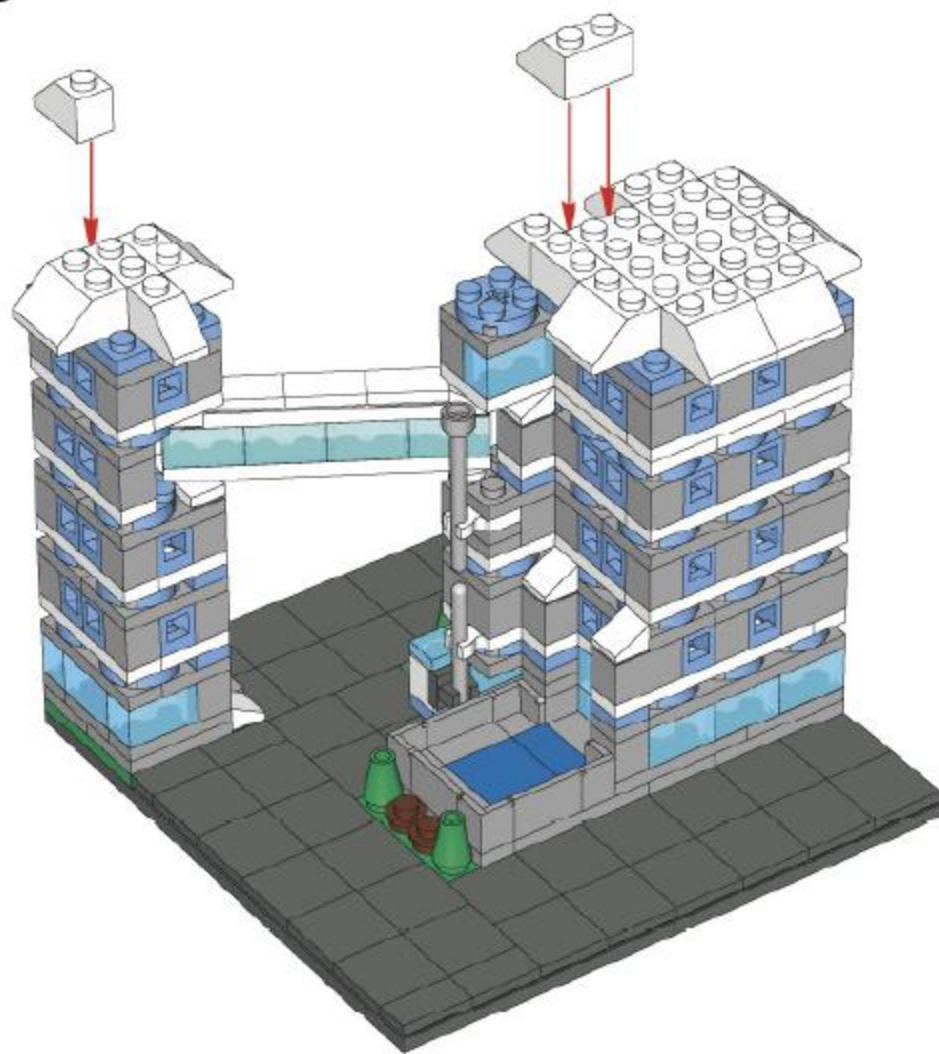

29

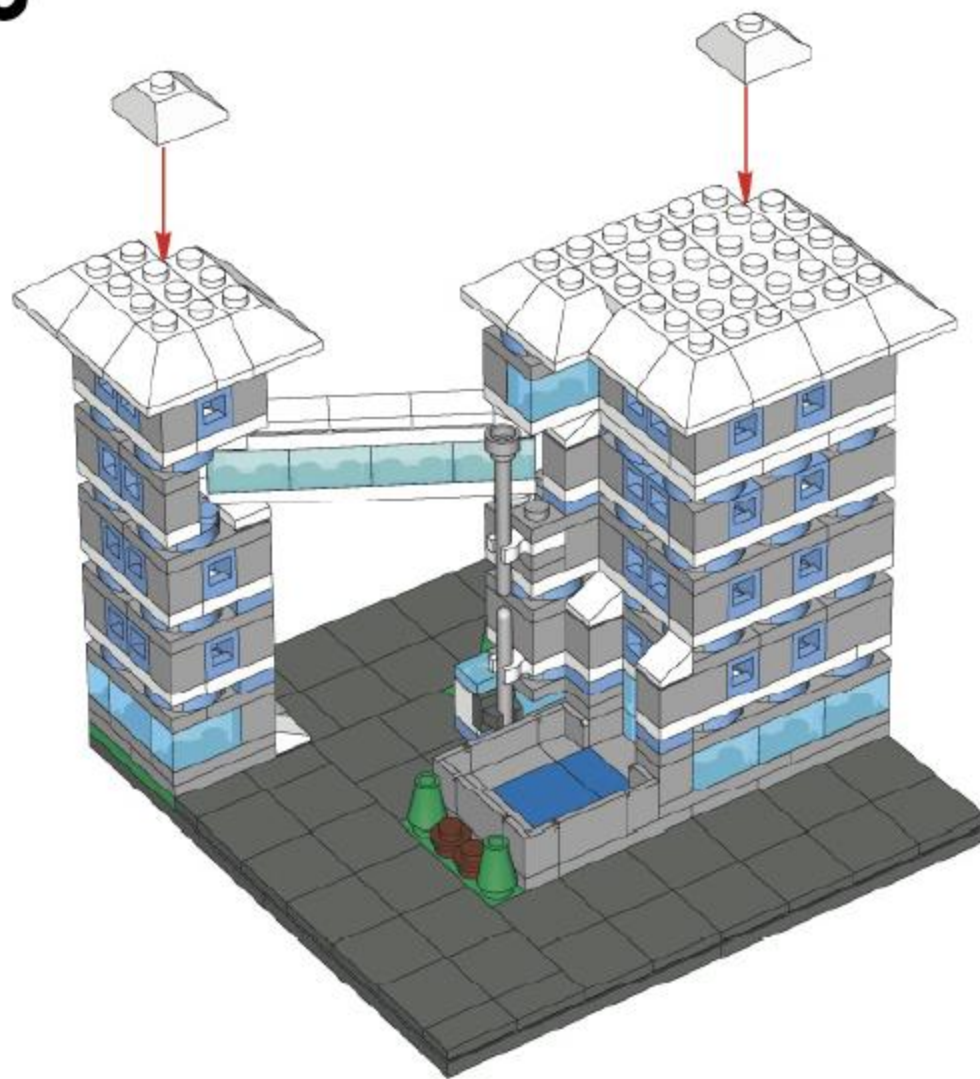

30

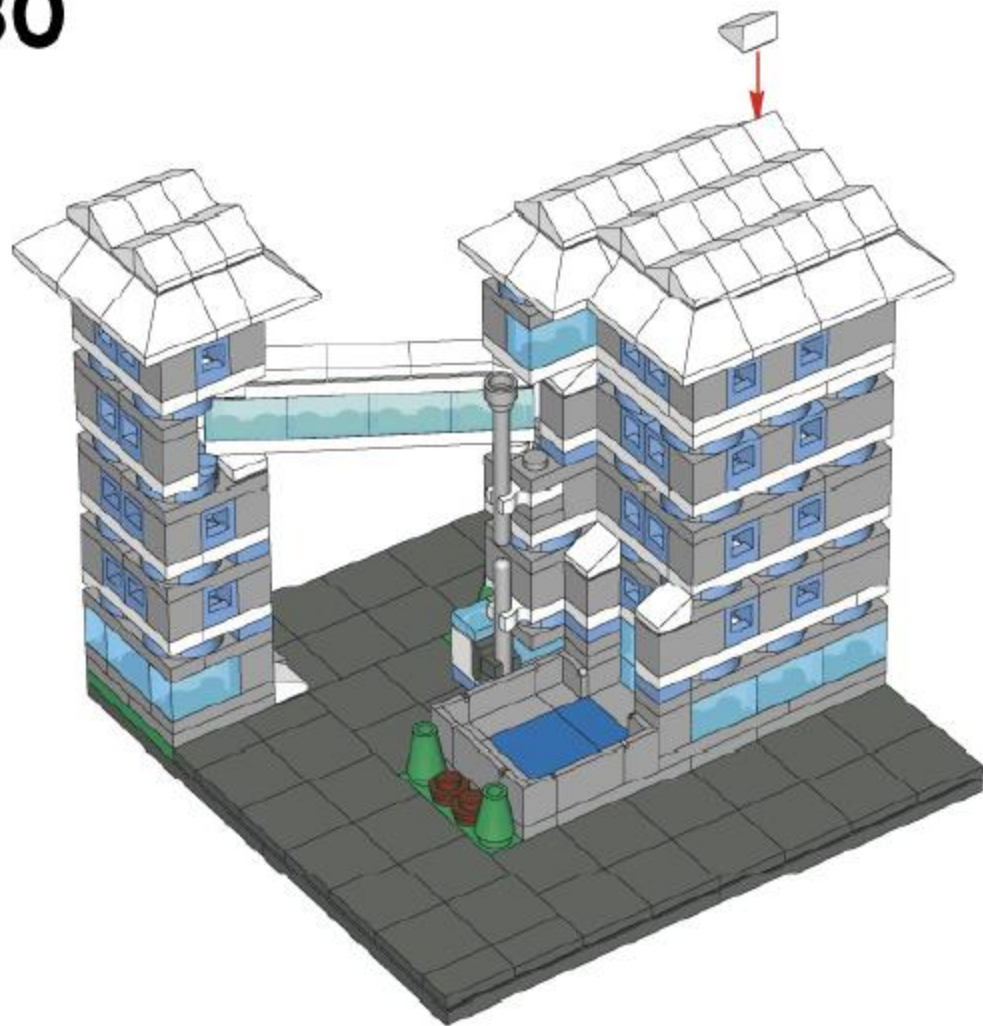

31

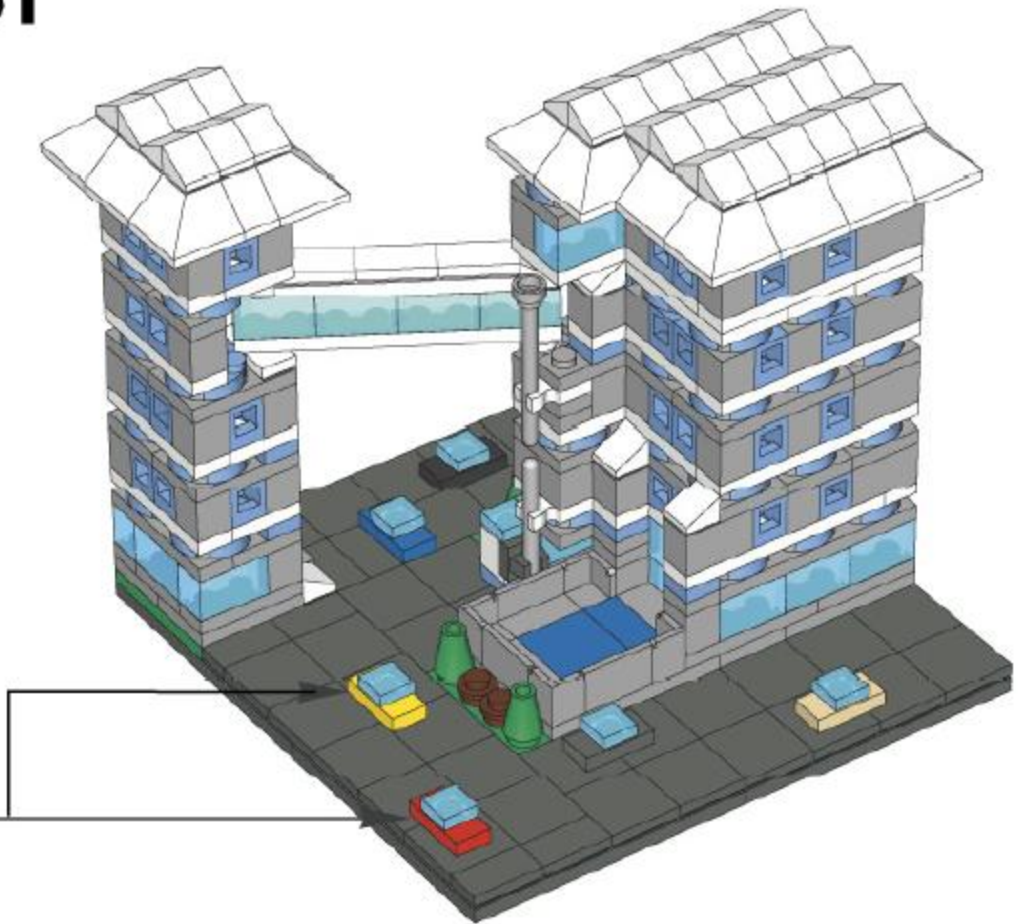
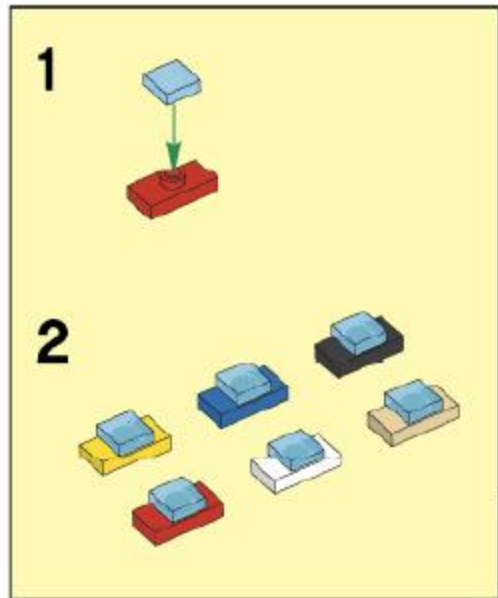



2x
614101



2x
302401



2x
406501



1x
302301



1x
379401



4x
306901



3x
362301



9x
371001



8x
366601



2x
346001



1x
302201



1x
302101



4x
302001



3x
379501



57x
4244370



3x
4121932



9x
4233370



1x
407001



2x
300401



2x
300101



9x
303901



6x
4216581



1x
379421



1x
379423



1x
306923



1x
308823



7x
4218438



21x
306543



54x
4179834



6x
4179825



6x
4179825



4x
4179828



47x
4183996



1x
4155708



1x
379424



1x
379426



4x
4188820



6x
4243621



2x
4211473



33x
4211369



19x
4211368



3x
4211349



4x
4215513



3x
4211616



1x
4211414



4x
4211399



8x
4211396



6x
4211429



5x
4211445



1x
4211397



11x
4211396



10x
4211395



5x
4211452



2x
4243797



1x
4211353



8x
4211052



36x
4211056



1x
4211069



4x
4210802