

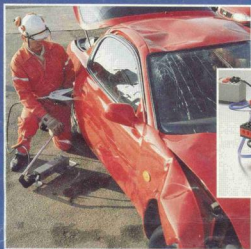

dacta™

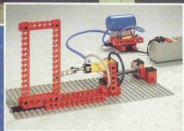

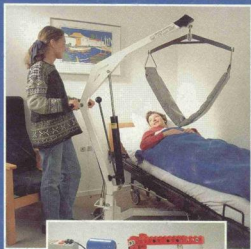
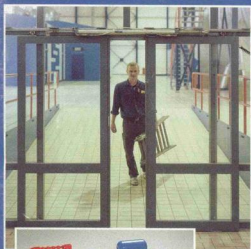
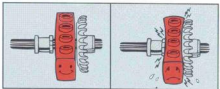
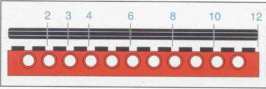

A

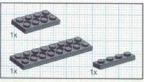
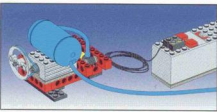

1

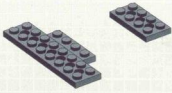

2

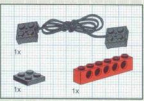
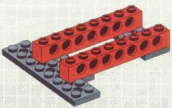

3

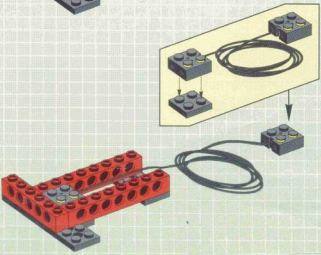



4

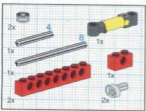
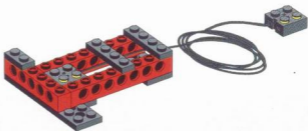

5

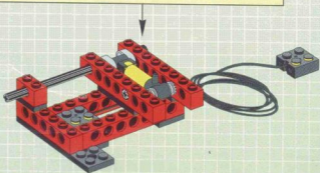
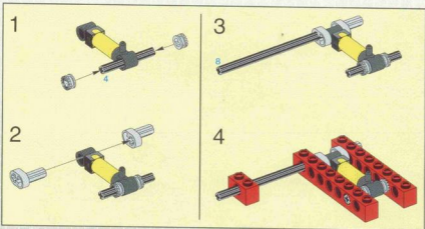

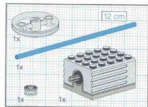

6

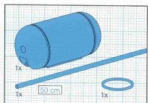

7

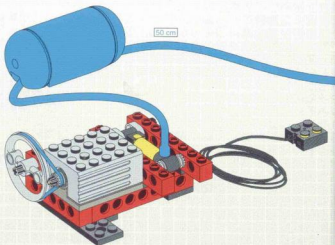

8

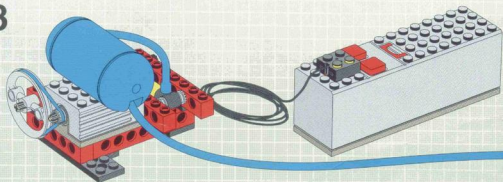

0 1 2 3 4 5 6 7 8 9 10 11 12 13 14 15 16 17 18 19 20 21 22 23 24 25 26 27 28

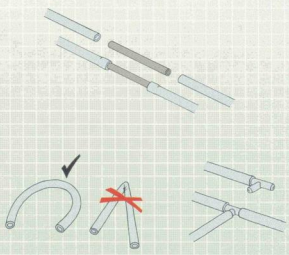
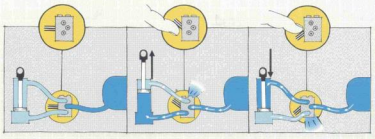
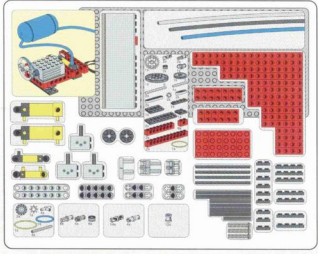

D

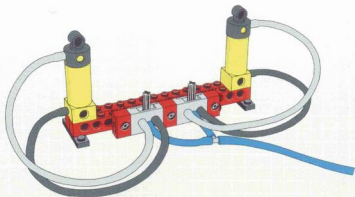

E

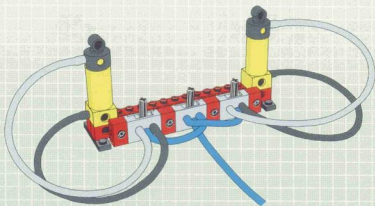



1

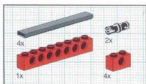
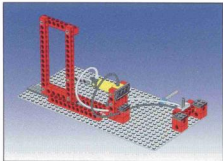

1

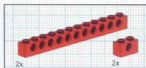
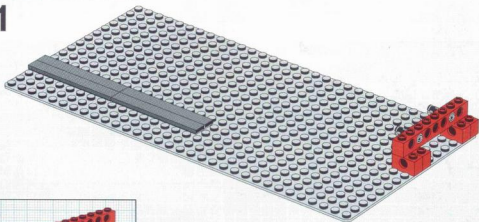

2

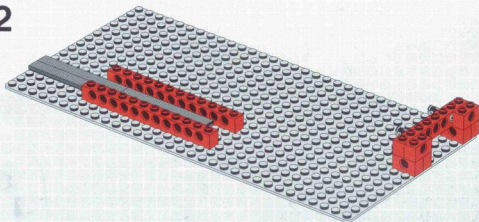

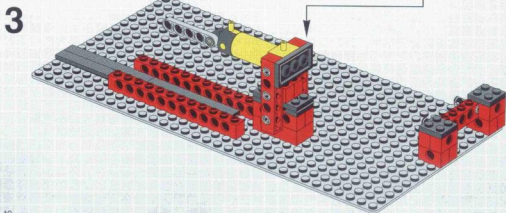
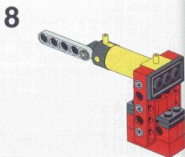
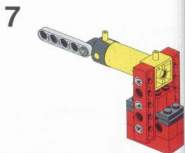
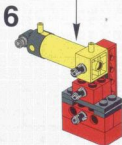
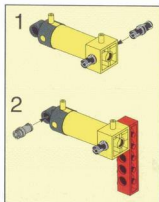
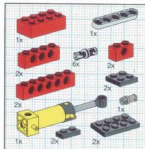

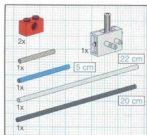

4

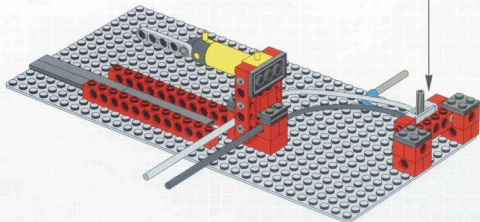
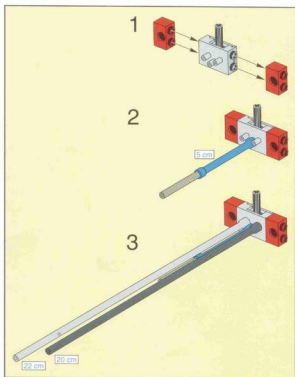

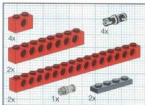

5

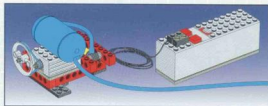
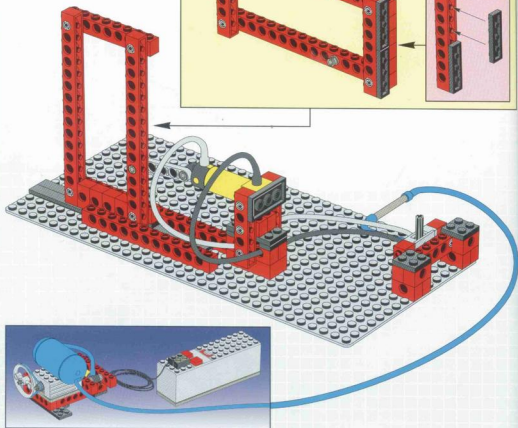
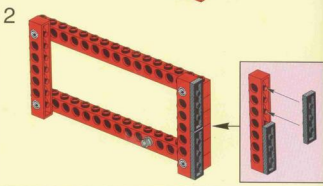
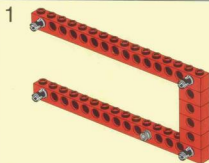

6

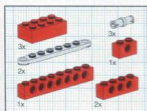
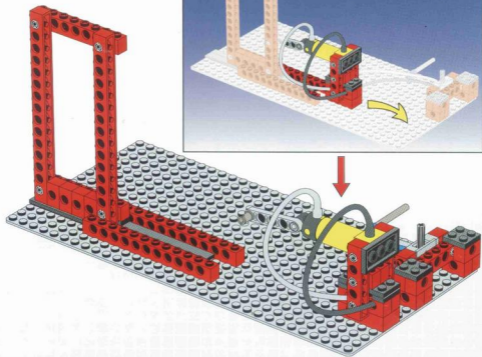

3

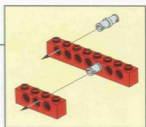
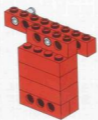

1



2

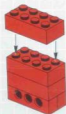

4

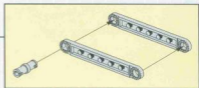
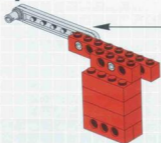

7

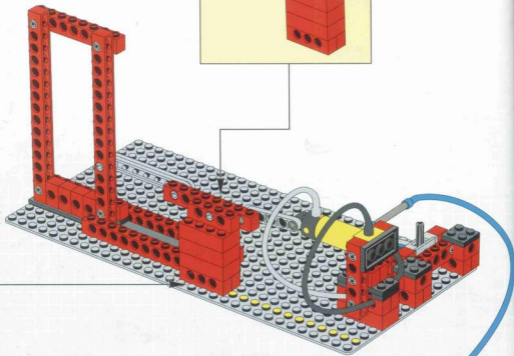
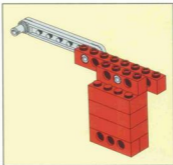

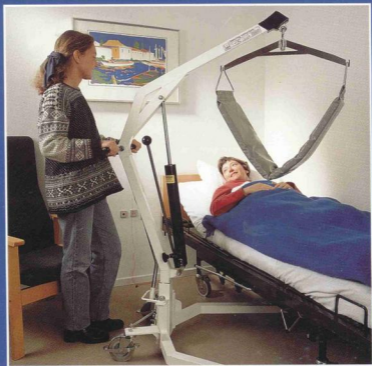

2

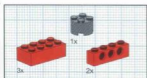
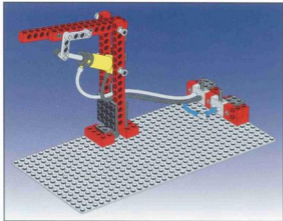

1

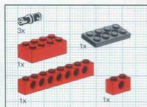
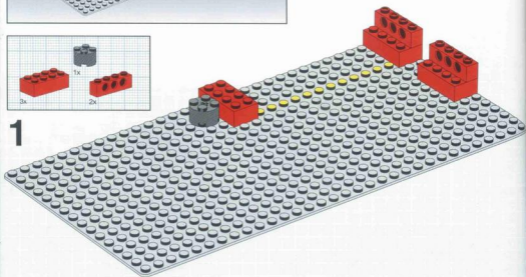

2

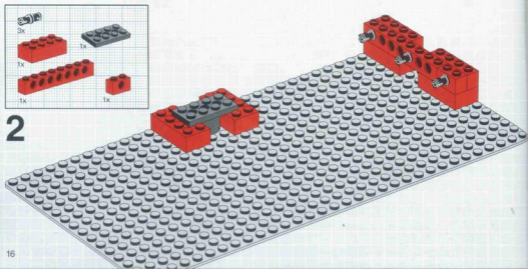

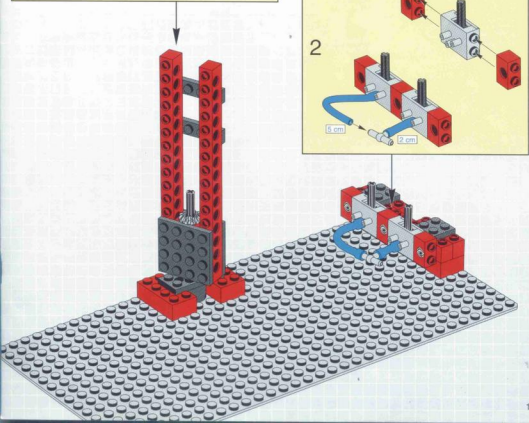
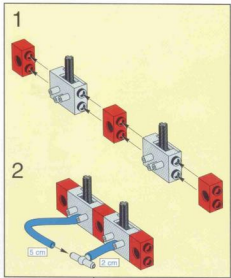
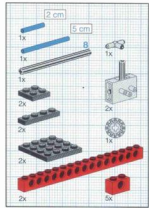
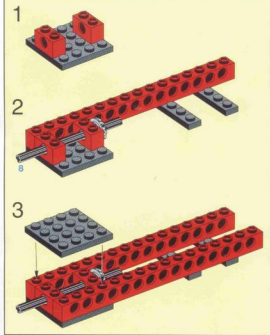

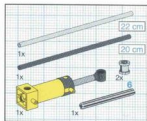

4

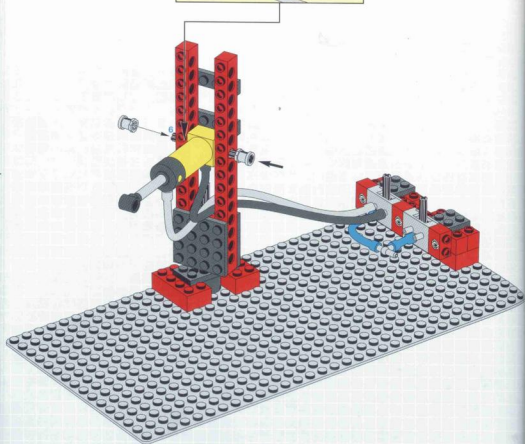
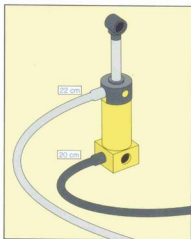

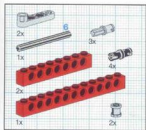

5

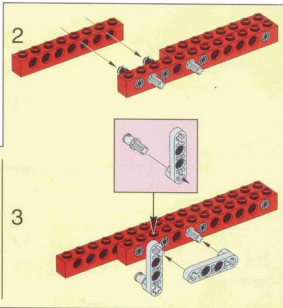
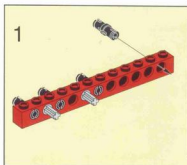

3

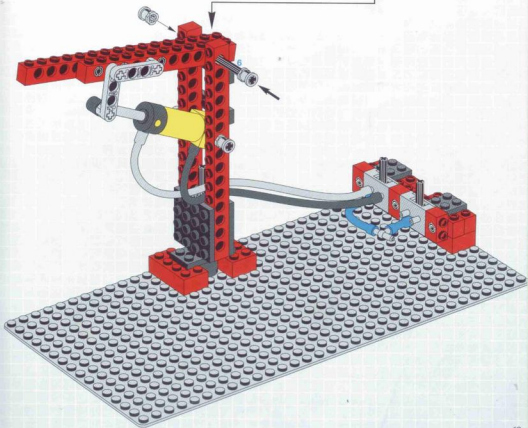
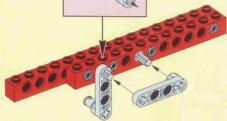



6

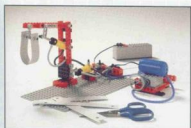
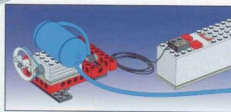
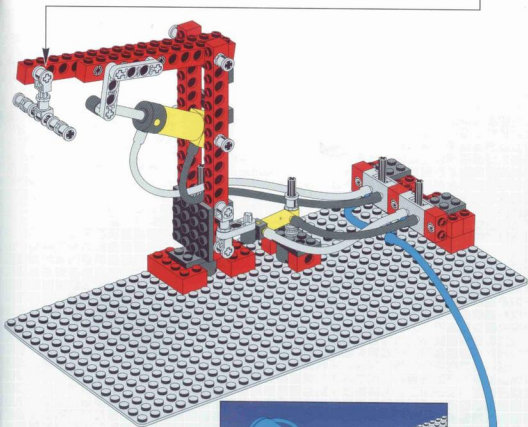
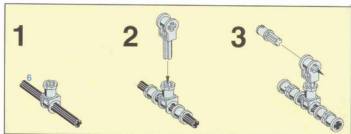

7

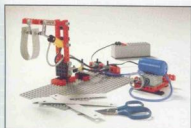
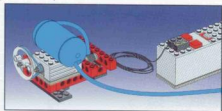
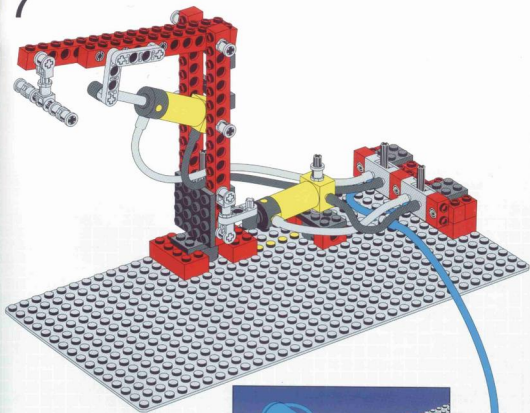

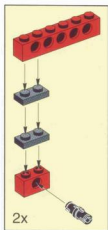
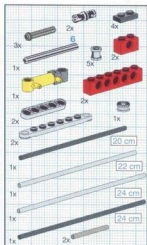
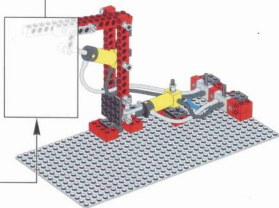
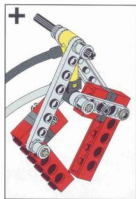

1

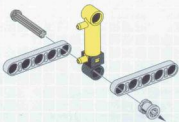

2

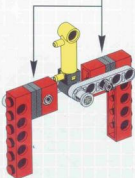

3

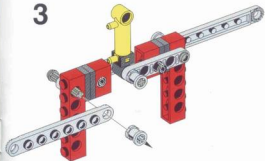

4



5

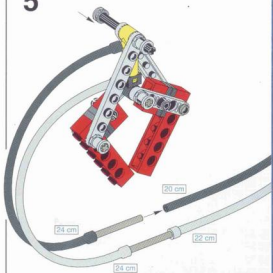

8

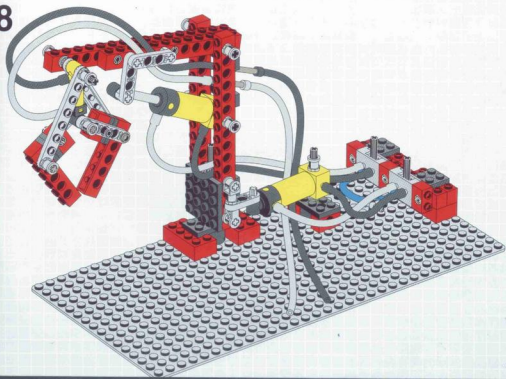

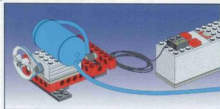
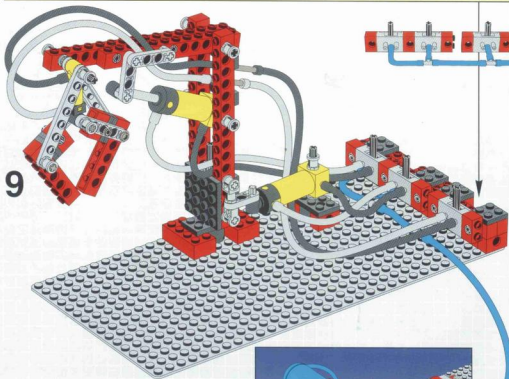
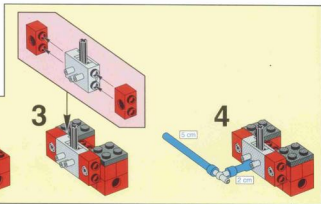
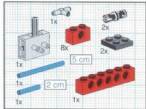

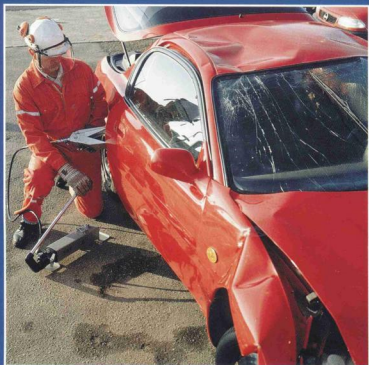

3_A

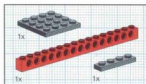
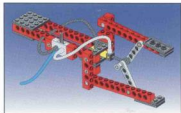

1

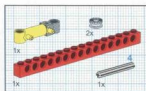

2

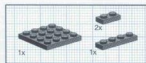
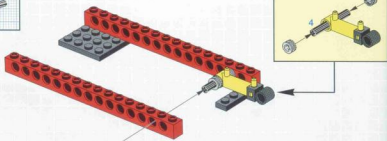

3

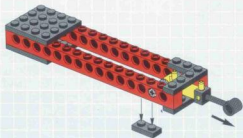

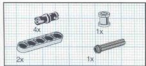

4

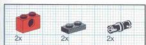
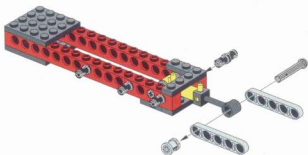

5

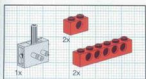
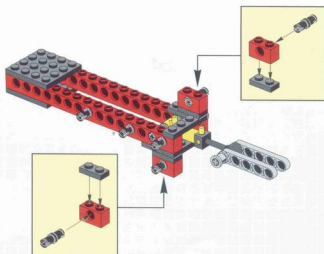

6

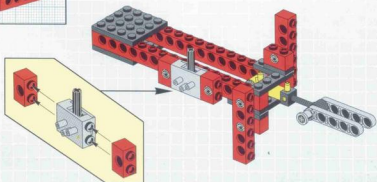

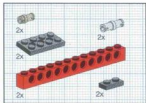

7

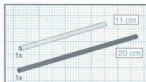
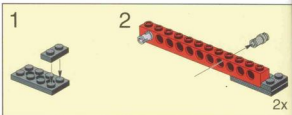
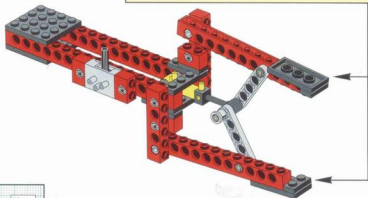

8

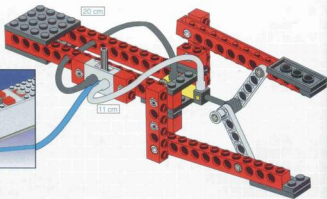
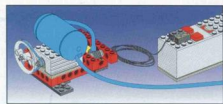

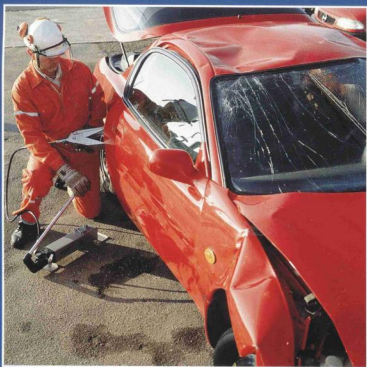

3_B

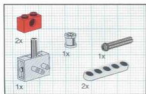

4

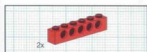
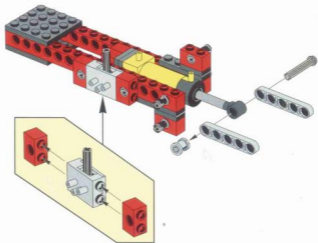

5

