



INDIANA JONES

7622



1

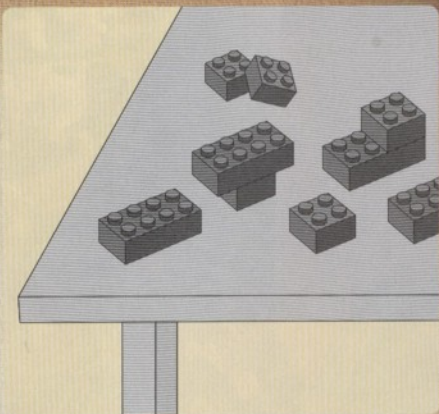
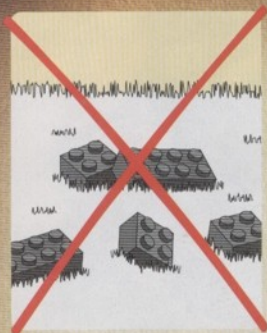

2

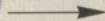



1

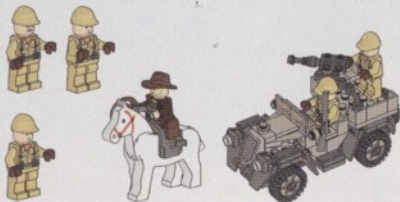

3

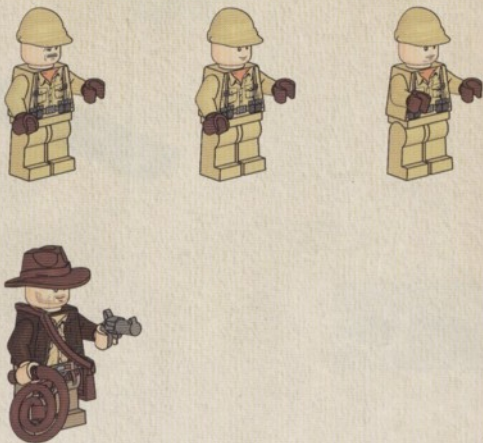
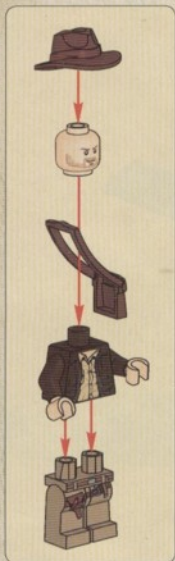

1



2



3



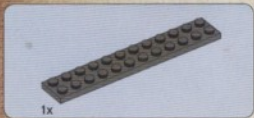

1x

1

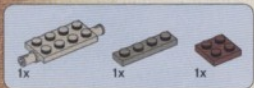
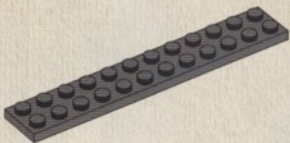

1x

1x

1x

2

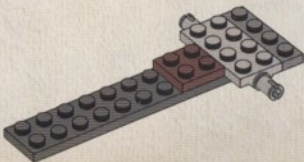

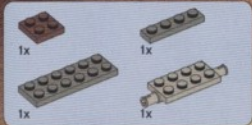

3

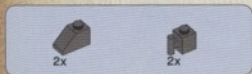
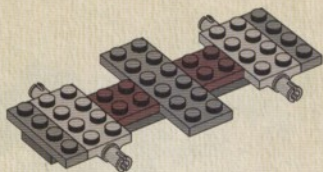

4

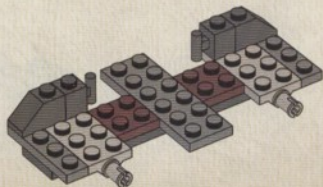



5

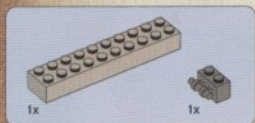
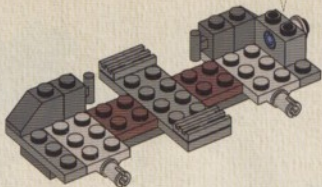
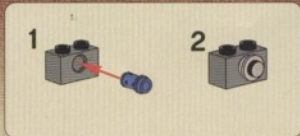

6

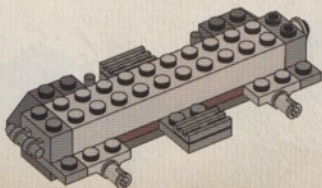



2x



2x

7

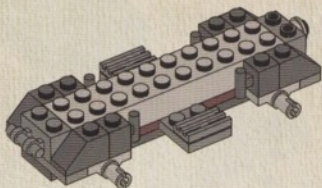

2x



1x



2x

8

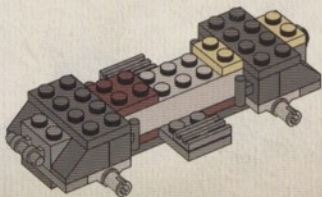

1x

1x

9

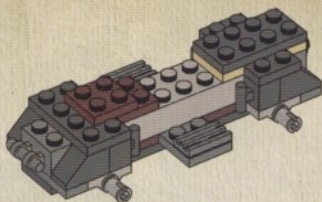

3x



3x

10

1

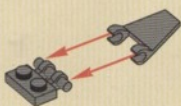

2



3x

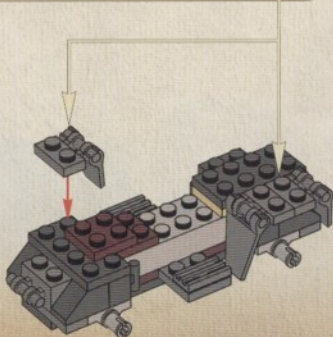

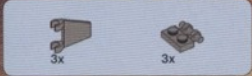

11

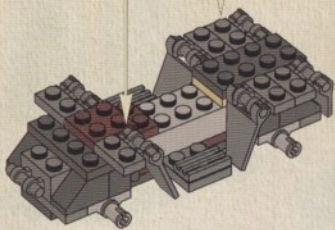
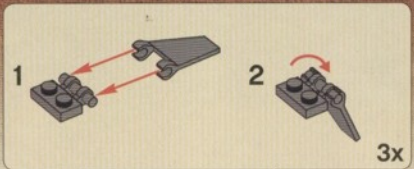

12

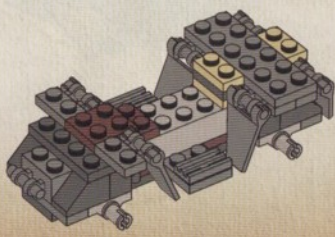



13

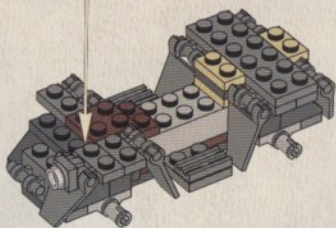
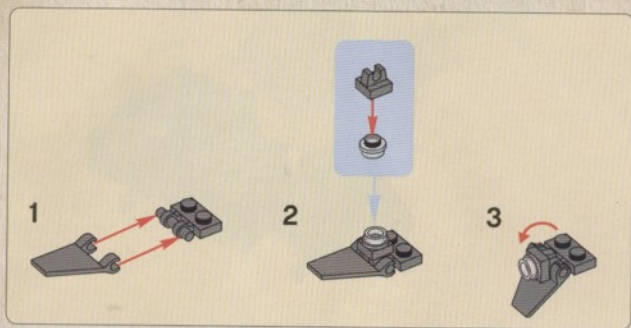

- 
1x
- 
1x
- 
1x

14

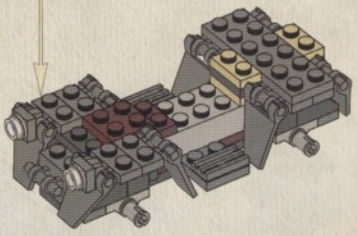
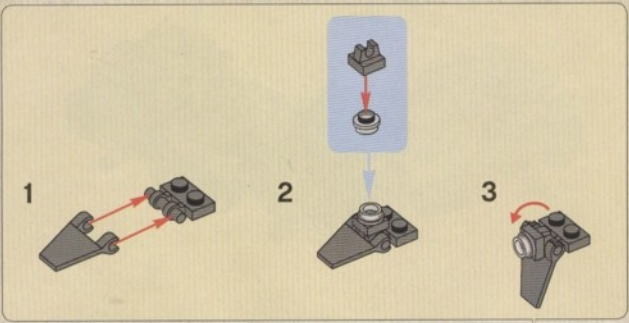



4x



2x



2x

15

1



2

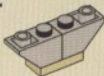

3

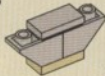

2x

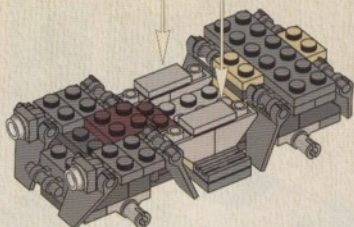

1x



2x

16

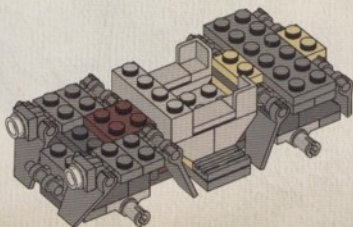



1x



1x



1x

17

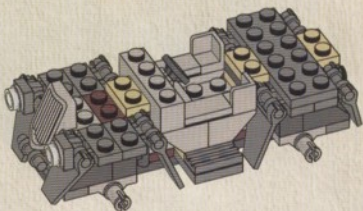

1x



1x

18

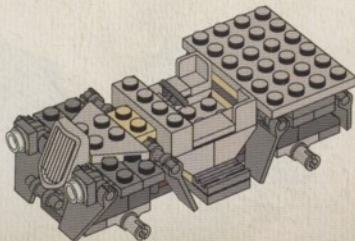



2x



2x



2x

19

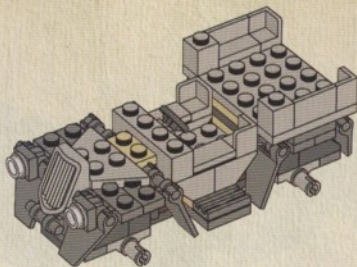

1x



2x



1x

20

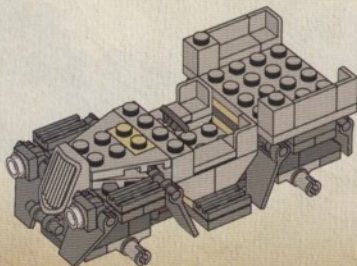

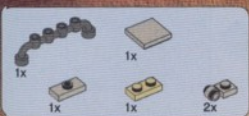

21

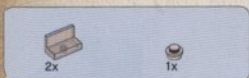
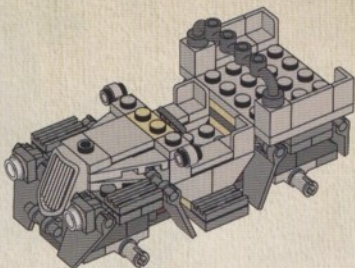

22

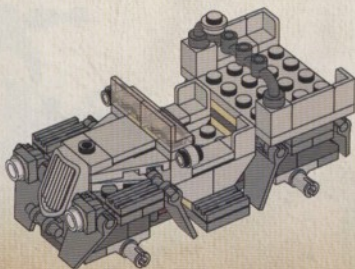

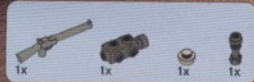

23

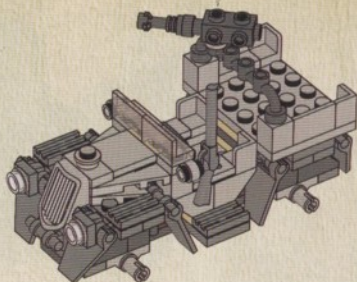
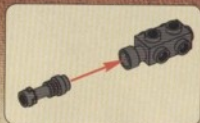

24

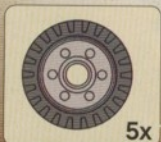
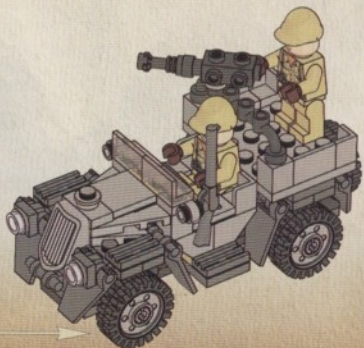



1x

1



2x



1x



1x

2

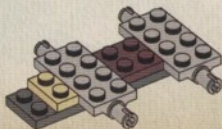



1x

3

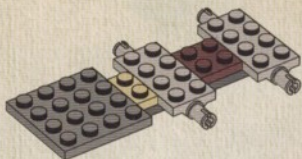

1x

4

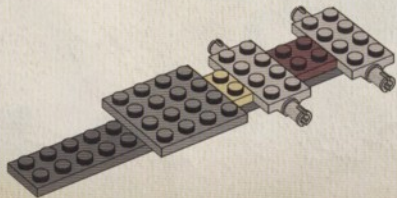



5

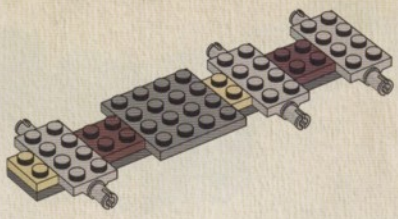

6

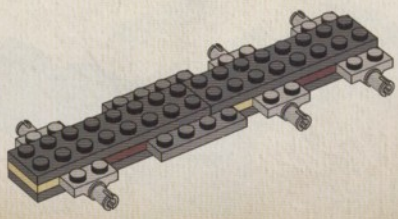



7

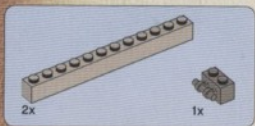
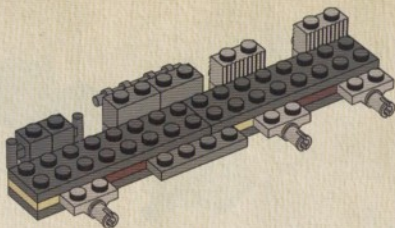

8

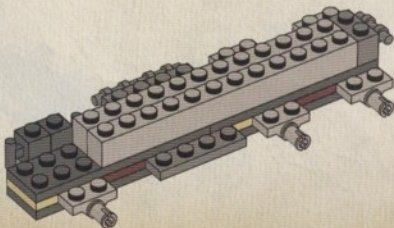



2x



2x



2x

9

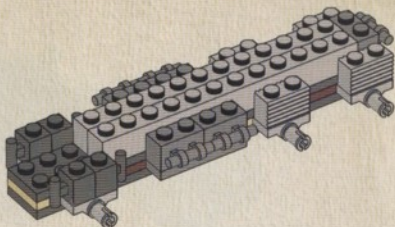

2x



8x

10

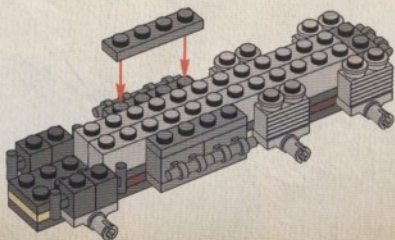



2x

11

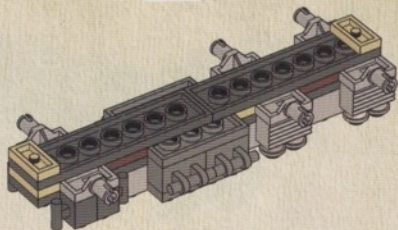

1x



1x

12

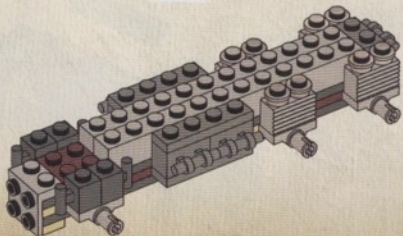



1x

13

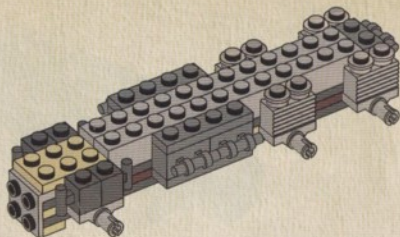

1x



4x

14

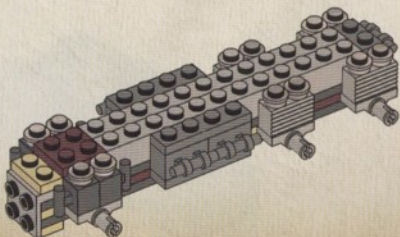



1x



1x

15

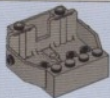
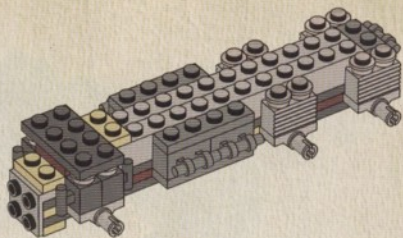

1x

16

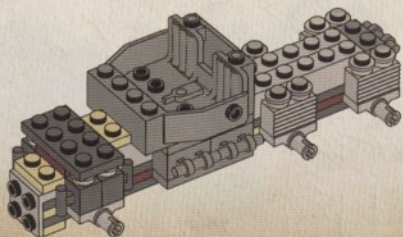

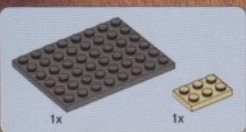

17

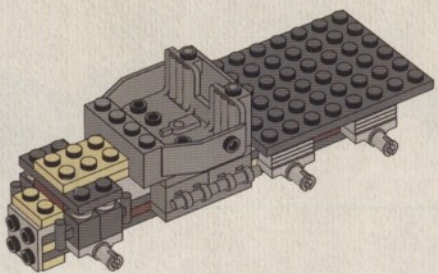

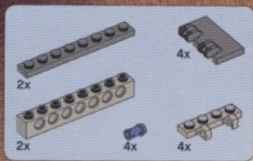

18

1

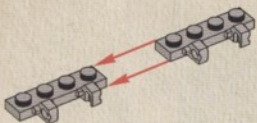

2

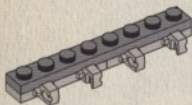

3

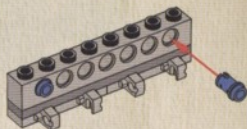

4

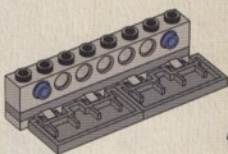

2x

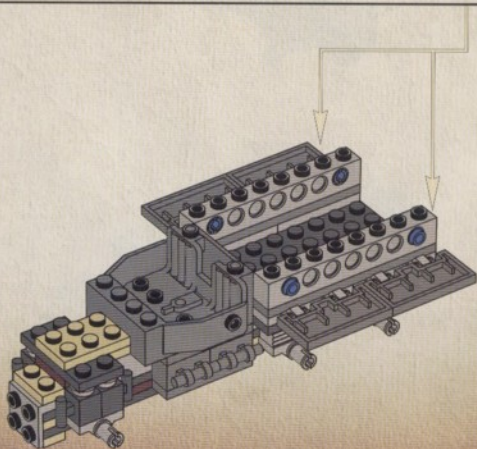



1x



2x



2x



2x

19

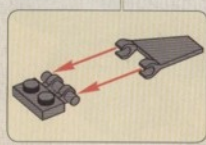
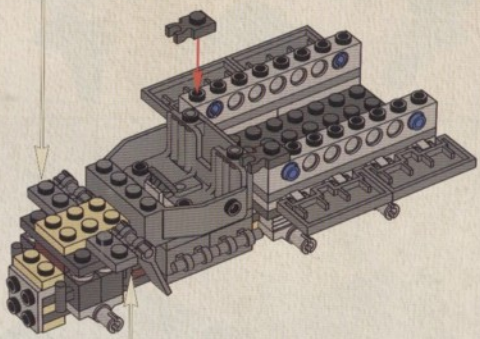
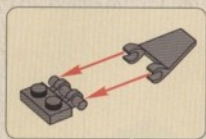

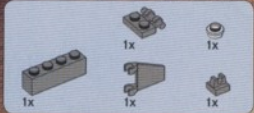

20

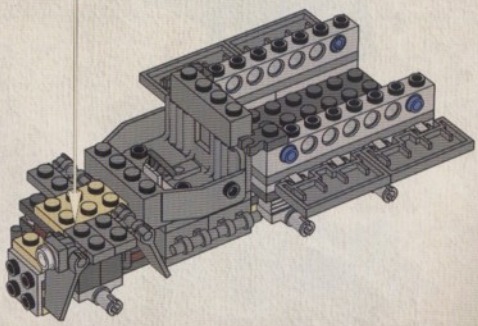
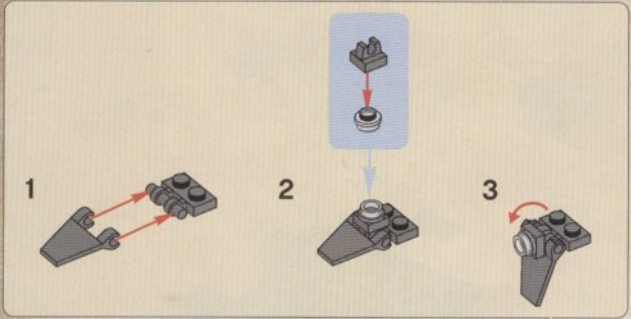

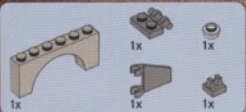

21

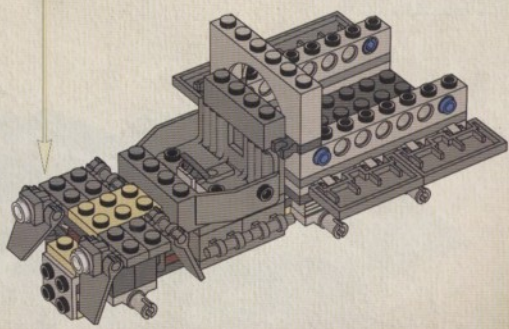
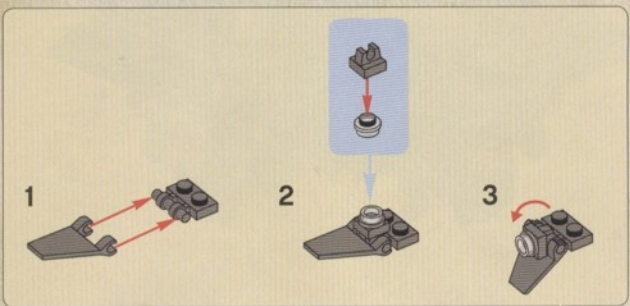

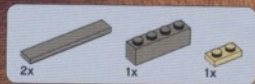

22

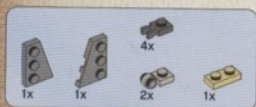
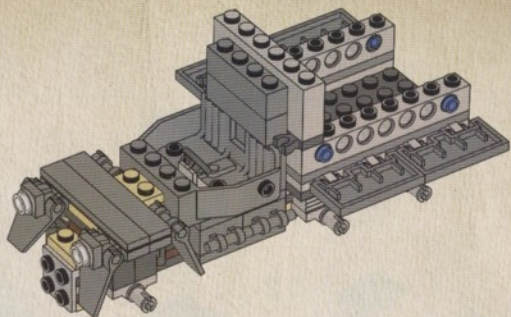

23

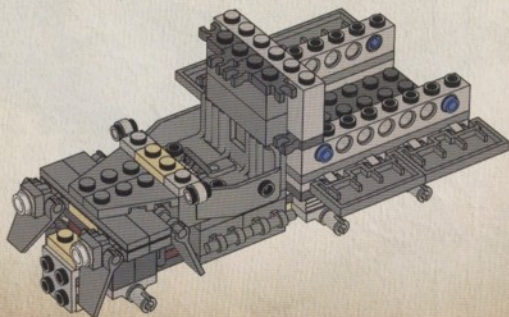

24

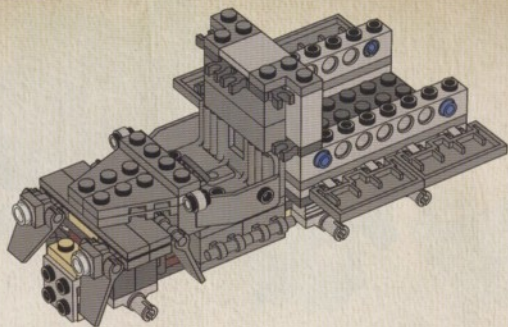
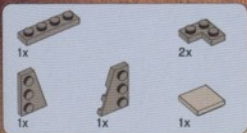

25

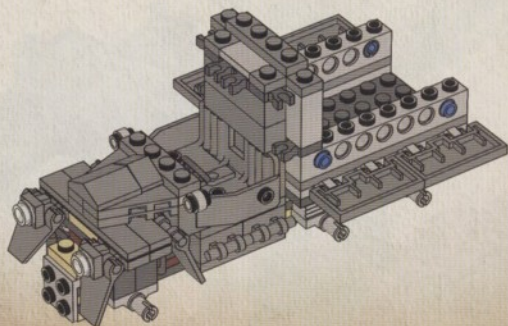



2x



1x



1x



2x

26

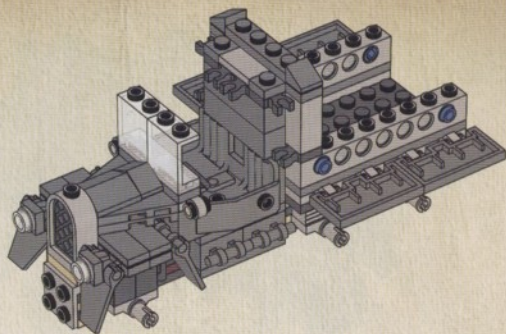

1x



1x



1x

27

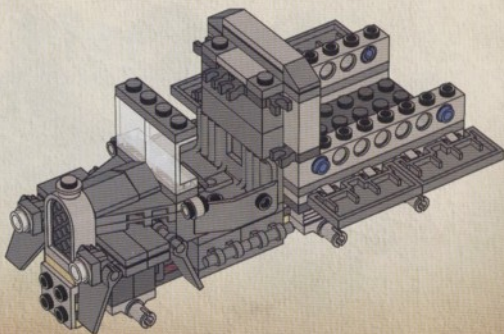

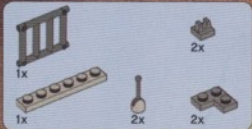

28

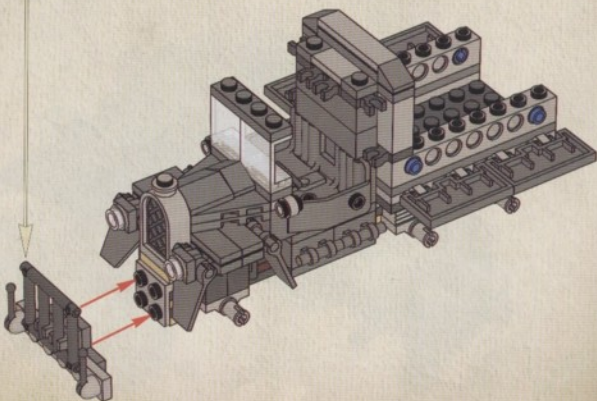
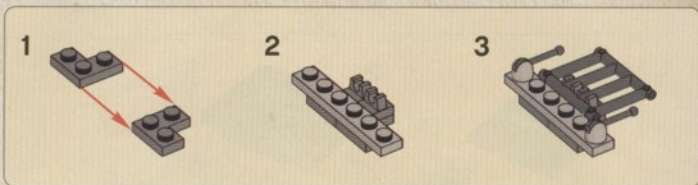



29

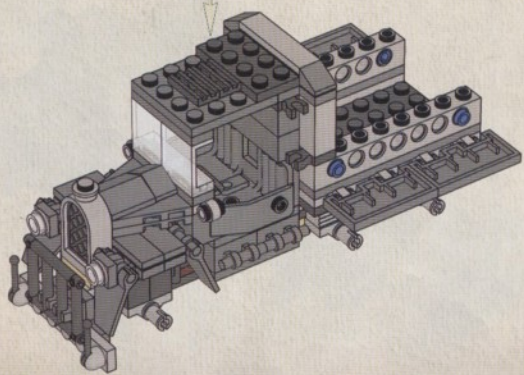
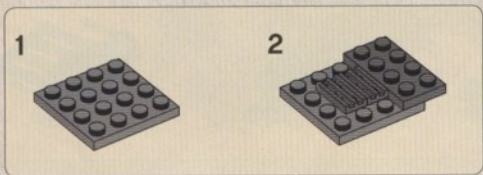



30

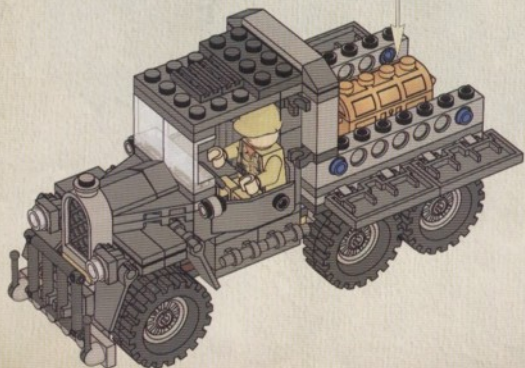
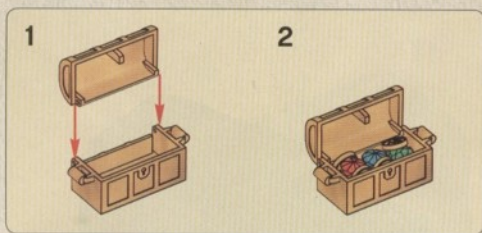

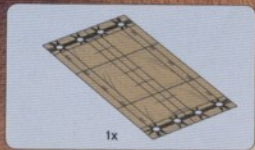

31

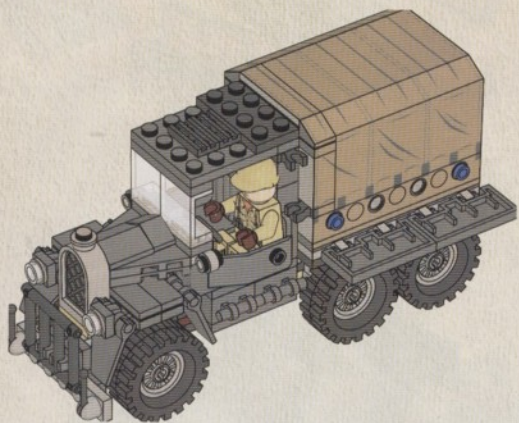

32

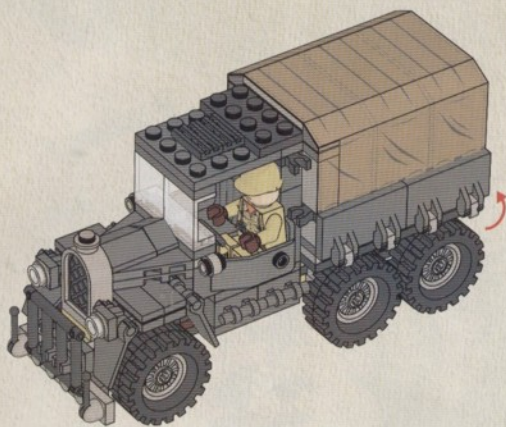





- 1x 420890
- 2x 4200798
- 1x 4520723
- 8x 4216695
- 1x 4521276
- 1x 4521275
- 1x 4524912
- 1x 4521495
- 1x 4524961
- 1x 4296305
- 1x 4113954
- 1x 4140005
- 1x 4119483
- 3x 407623
- 1x 4524592
- 16x 4113917
- 2x 4118790
- 3x 4524434
- 1x 4525445

- 1x 4526006
- 8x 392126
- 1x 3004626
- 1x 614026
- 1x 4521681
- 1x 4523775
- 1x 4523339
- 6x 408526
- 1x 244526
- 5x 302026
- 4x 303426
- 1x 303626
- 2x 241226
- 4x 4121966
- 6x 234626
- 5x 4501048
- 2x 4113955
- 1x 79601

- 1x 4277927
- 2x 4211389
- 6x 4528278
- 2x 4211522
- 1x 4211394
- 1x 4211390
- 1x 4221600
- 2x 4226995
- 2x 4211414
- 1x 4211356
- 2x 4211413
- 4x 4211477
- 2x 4221775
- 1x 4211451
- 4x 4211840
- 1x 4211438
- 1x 4507056
- 1x 4240013
- 1x 4210948

- 4x 4211383
- 1x 4523369
- 5x 4499259
- 4x 4211437
- 2x 4211442
- 4x 4211513
- 2x 4211515
- 5x 4211572
- 1x 4523353
- 12x 4215387
- 6x 4211128
- 2x 4211103
- 4x 4210635
- 2x 4210651
- 1x 4267282
- 6x 4211069
- 12x 4210660
- 1x 4211001
- 2x 4210918

- 1x 4210872
- 2x 4210869
- 2x 4211002
- 2x 4243831
- 4x 4210631
- 1x 4211029
- 1x 4523365
- 1x 4523773
- 4x 4504378
- 1x 4211111
- 1x 4210853
- 4x 4523342
- 4x 3005740
- 2x 4113028
- 16x 4249039
- 1x 4524041
- 1x 4524042
- 1x 4821702

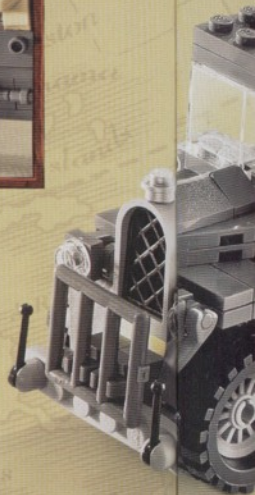





AVAILABLE NOW

PRODUCTS RANGE FROM
RATING PENDING TO EVERYONE 10+

RP-E
ESRB

CONTENT RATED BY
ESRB

T
games

LEGO Star Wars: The Complete Saga
available on Wii™, Nintendo DS™,
PlayStation® 3 and Xbox 360™.

www.lucasarts.com

LUCASARTS

LEGO, the LEGO logo and the Minifigures are trademarks of The LEGO Group. © 2005-2007 Lucasfilm Entertainment Company Ltd. or Lucasfilm Ltd. and/or its affiliates. All rights reserved.



INDIANA JONES

THE VIDEO GAME



COMING
SUMMER 2008

Coming to Xbox 360™ video game and entertainment system, Wii™, PC, PLAYSTATION®3 computer entertainment system
PlayStation®2 computer entertainment system, PSP® (PlayStation®Portable) system and Nintendo DS™.

www.LEGOINDY.com





7620

7623





7622





YES! I want to join the LEGO® Club FREE!

OUI ! Je veux m'abonner au Club LEGO® GRATUITEMENT !

Ja! Ich möchte Mitglied im kostenlosen LEGO Club werden. Ja! Ik wil graag GRATIS lid worden van de LEGO Club.

BG27

First Name

Prénom

Vorname

Voornaam

Last name

Nom de famille

Familienname

Achternaam

Date of Birth

Date de naissance

Geburstag

Gebortedatum

Boy

Garçon

Junge

Jongen

Girl

Fille

Mädchen

Meisje

Street, No.

Rue

Straße, Hausnr.

Straat, huisnr.

City/County

Ville

Stadt

Woonplaats

State

Prov.

Zip/Postcode

Code Postal

PLZ

Postcode

Country

Pays

Land

Telephone

No de Téléphone

Telefonnr.

Telefoonnummer

Parent's signature

Signature d'un parent

Unterschrift Erziehungsberechtigte/r

Handtekening ouders

The English version of the magazine can only be mailed to addressees in the US, Canada, the UK, and Republic of Ireland. Club membership is valid for 2 years and includes free copies of the LEGO Magazine. In the US and Canada please allow up to 6 weeks for delivery of your first magazine. By signing this form you consent to the LEGO Club to use your child's data for LEGO mailings. The data will only be used for LEGO mailings and will not be sold, rented or otherwise disclosed to any company outside the LEGO Company except for disclosure to companies acting as our agents to help us provide services requested by the child. This coupon good for one free membership per person, group or organization (photocopies not accepted).
La version française du magazine peut être postée uniquement au Canada. L'abonnement est valide pour 2 ans et inclut des exemplaires gratuits du Magazine LEGO. Aux E-U et au Canada, allouer 6 semaines pour la livraison initiale. En remplissant ce formulaire, vous consentez à ce que LEGO utilise les informations de votre enfant pour des envois postaux de LEGO et ne sera en aucun cas, vendue, louée, échangée ou divulguée à d'autres compagnies autres que la compagnie LEGO, à l'exception des compagnies affiliées qui nous procurent des services auxquels l'enfant en a fait la demande.

Das deutschsprachige Angebot gilt nur für die Länder D, AU und CH. Die kostenlose Mitgliedschaft beinhaltet die Zusendung des LEGO Magazins und endet nach zwei Jahren. Für die Mitglieder entstehen keine Verpflichtungen. Es kann bis zu drei Monate dauern, bis das erste Magazin zugestellt wird. Mit Ihrer Unterschrift erklären Sie sich einverstanden, dass die Daten Ihres Kindes zum Zweck einer LEGO Club-Mitgliedschaft von der LEGO Gruppe gespeichert werden. Die Daten werden vertraulich behandelt und nicht an Dritte weitergegeben, außer an Dienstleister des LEGO Clubs. Wenn Sie außer vom LEGO Club keine weiteren Informationen von der LEGO Company bekommen möchten bitte hier ankreuzen:

Door dit formulier te tekenen geeft u de LEGO Club toestemming om bovenstaande gegevens te gebruiken voor het toesturen van LEGO mailings. Uw gegevens worden uitsluitend gebruikt voor mailings van LEGO en zullen niet worden verkocht, verhuurd of op welke wijze dan ook verstrekt aan derden buiten de LEGO Groep, uitgezonderd de organisaties die namens ons optreden om de service te verlenen waar uw kind om gevraagd heeft.



Mail to: / Poster à:

LEGO Club

P.O. Box 1157

Enfield, CT USA

06083-1157



Mail to:

LEGO Club

33 Bath Road

Slough SL1 3UF

United Kingdom



Per Post an:

LEGO® Club

Postfach 14 15

D-36243 Niederaula



Stuur op naar:

LEGO® Club

Postbus 40252

3504 AB Utrecht



club™



FREE LEGO Magazine • GRATUIT • GRATIS LEGO Magazin



Join Today!
Abonne-toi dès aujourd'hui!

Meld je nu aan!

Jetzt anmelden!



US & Canada only

1-866-534-6258

1-877-518-5346

(en Français)

00800 5346 5555

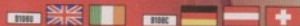

www.LEGOclub.com

**VISIT THE WORLD'S
BIGGEST LEGO® SHOP!**
www.LEGOshop.com

WIN LEGO® PRODUCTS

No purchase necessary.
Open to residents of all countries where
not prohibited.
Go to www.lego.com for official rules and details.



www.acnielsen.aim.dk/LEGO



WIN LEGO® PRODUCTEN

Kopen niet nodig.
Open voor alle leeftijden, en in alle landen
waar geen verbod geldt.
Ga naar www.lego.com voor officiële regels en details.

GEWINNE LEGO® PRODUKTE

Die Teilnahme am Gewinnspiel führt zu
keinerlei Kaufverpflichtungen.
Sie können in allen nicht ausgeschlossenen
Ländern teilnehmen.
Die offiziellen Regeln und nähere Informationen
finden Sie unter www.lego.com.

GAGNE DES PRODUITS LEGO®

Aucun achat n'est nécessaire.
Ouvert à tous les âges et aux résidents de
tous les pays, sauf en cas d'interdiction.
Rendez-vous sur www.lego.com pour obtenir plus
de détails et le règlement officiel.

レゴ®製品を「当てよう」

購入は不要です
禁止されていない限り、あらゆる
年代およびあらゆる国の居住者の
方々にご利用いただけます。
公認規則および詳細につきましては、
www.lego.comをご覧ください

LEGO, the LEGO logo and the Minifigure are trademarks of/
sont des marques de commerce de/son marcas registradas de LEGO Group.
©2008 The LEGO Group. 4527306

© 2008 Lucasfilm Ltd. & TM. All rights reserved/Tous droits réservés/
Todos los Derechos Reservados. Used under authorization/Utilisé sous autorisation/
© 2008 The LEGO Group.

