



STAR WARS

TM



20021



 BrickMaster™



1

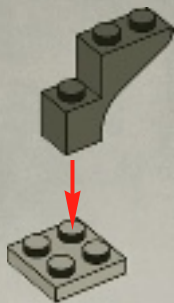

2

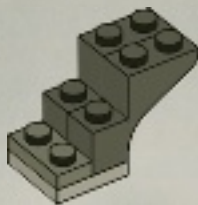

3

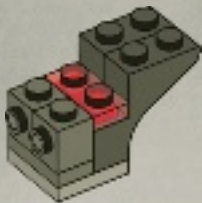

4

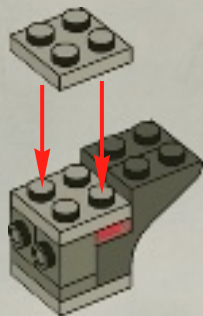

5

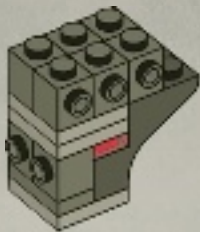

6

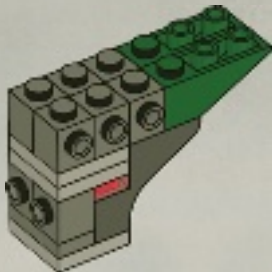

1



2



3



7

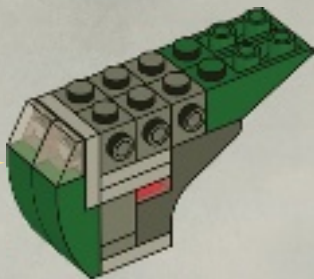

1

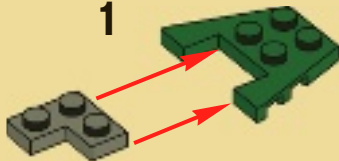

2



3



8

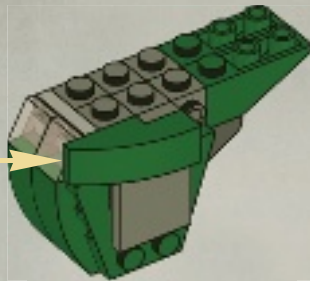

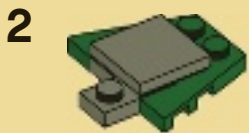
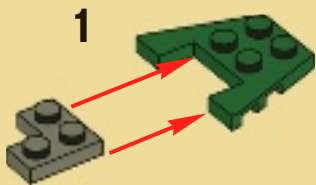

9

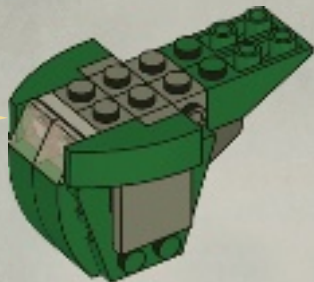

10

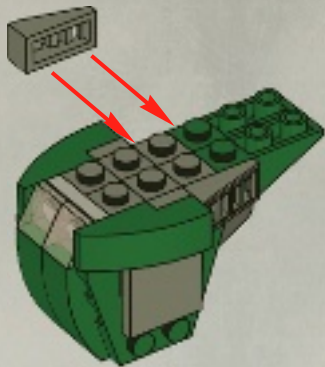



1

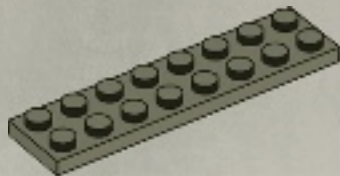

2

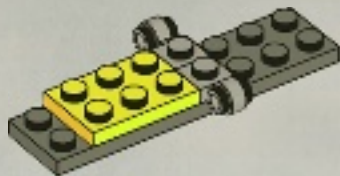

3

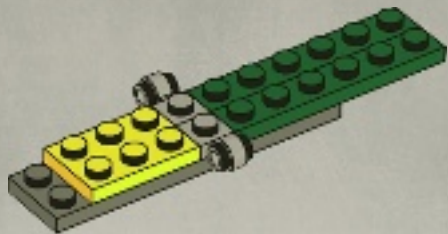

4

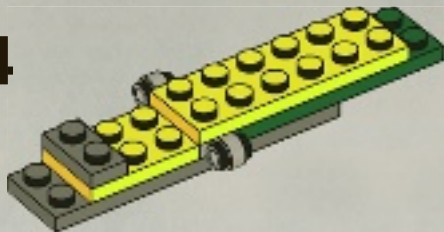

5

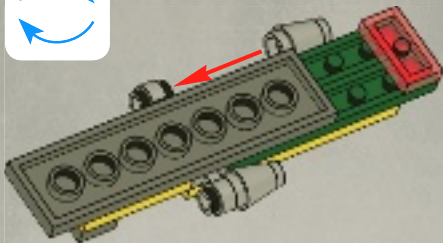

6

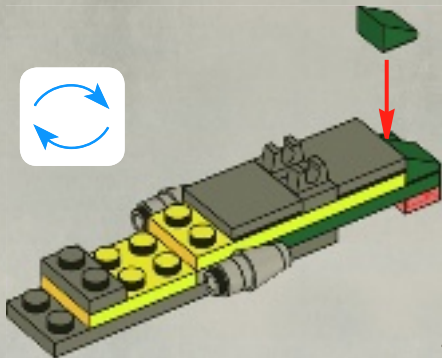

7

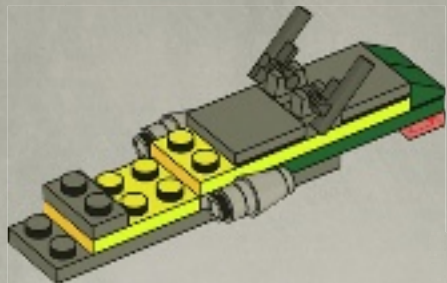

11

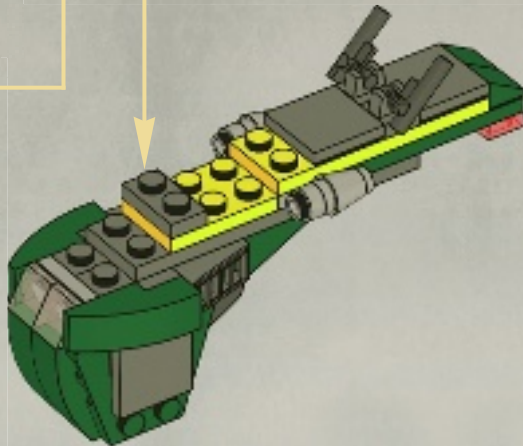

12

12

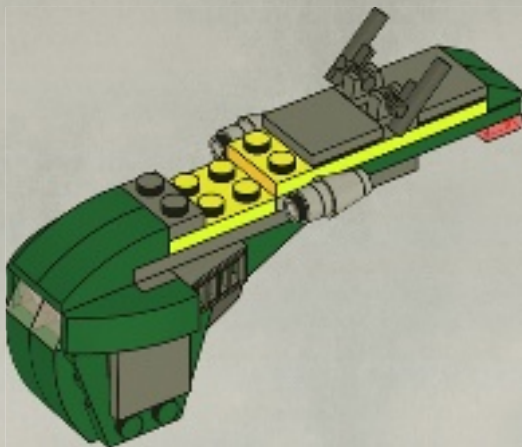



1

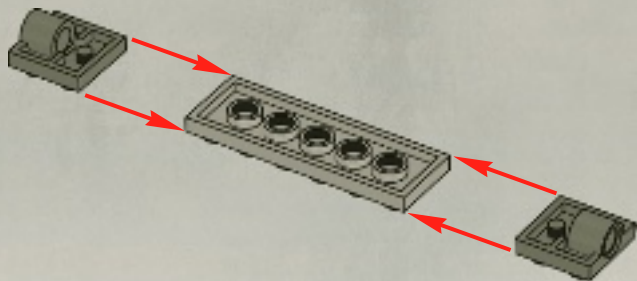

2

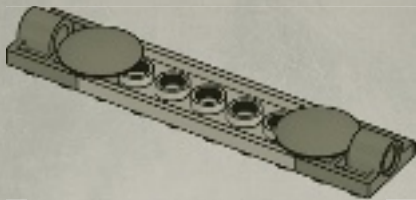

3

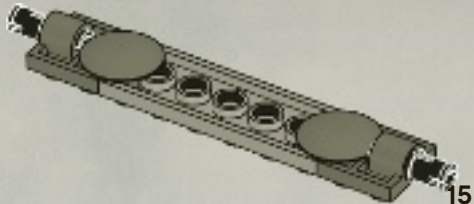

4

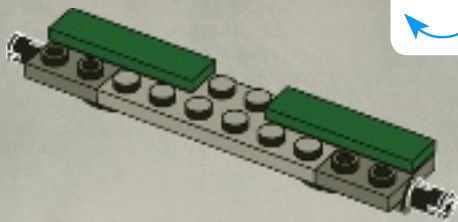

5

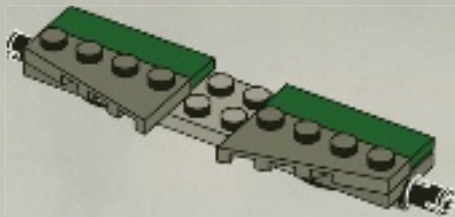

13

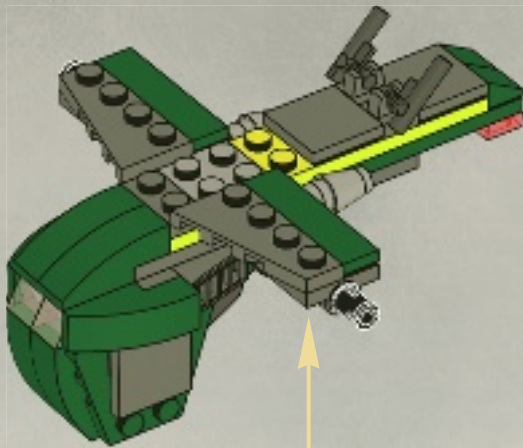

14

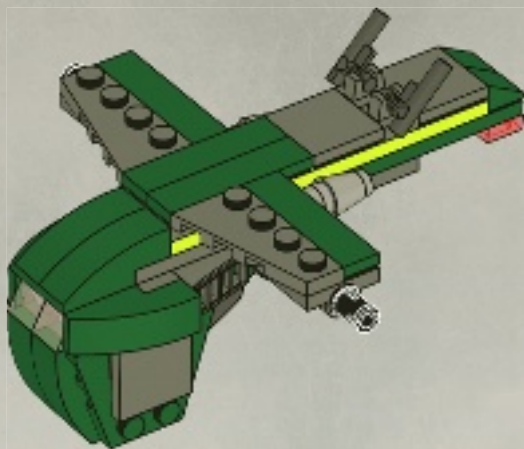

15

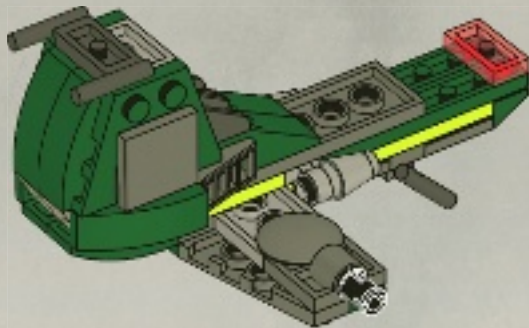



2x

1



2



3



4



5



7



6



2x

16

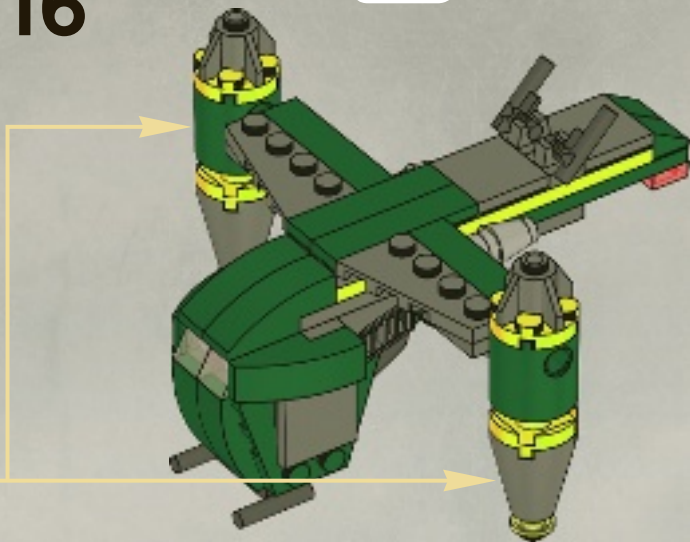



1x
302124

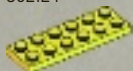

1x
379524



4x
403224



2x
4244368



1x
383926



2x
4537551



2x
4581280



2x
4121715



2x
370526



2x
4201019



2x
3005744



2x
4504375



2x
4583837



6x
4267850



2x
4520300



2x
4506417



4x
4543949



2x
4245566



1x
4211452



2x
4529241



4x
4211397



2x
4632575



8x
4558955



2x
4211108



2x
4196768



2x
4210635

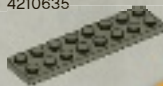

1x
4210997



4x
4211055



2x
4540386



2x
4211063



2x
4278274



2x
4211069



1x
4210788



1x
4210782



2x
4212352



Customer Service

Kundenservice

Service Consommateurs

Servicio Al Consumidor

www.lego.com/service or dial



: 00800 5346 5555



: 1-800-422-5346



7913



7914



7915



7929



7930



7931

LEGO, the LEGO logo and the Minifigure are trademarks of the/sont des marques de commerce de/son marcas registradas de LEGO Group. ©2011The LEGO Group. 4625191

©2010 Lucasfilm Ltd. & TM. All rights reserved. Used under authorization./Tous droits réservés. Utilisé sous autorisation./Todos los derechos reservados. Usado bajo autorización.