



# MARVEL SUPER HEROES



6868



1

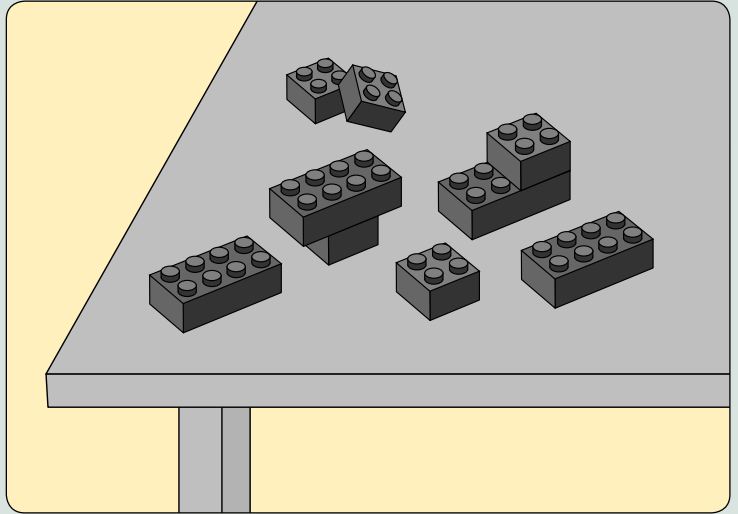
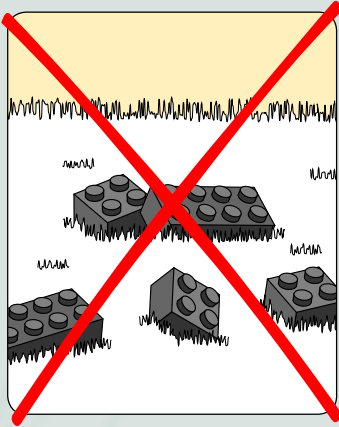

2

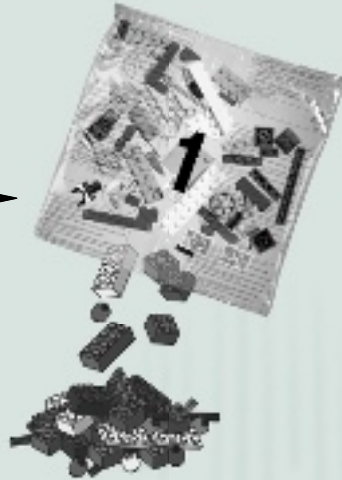

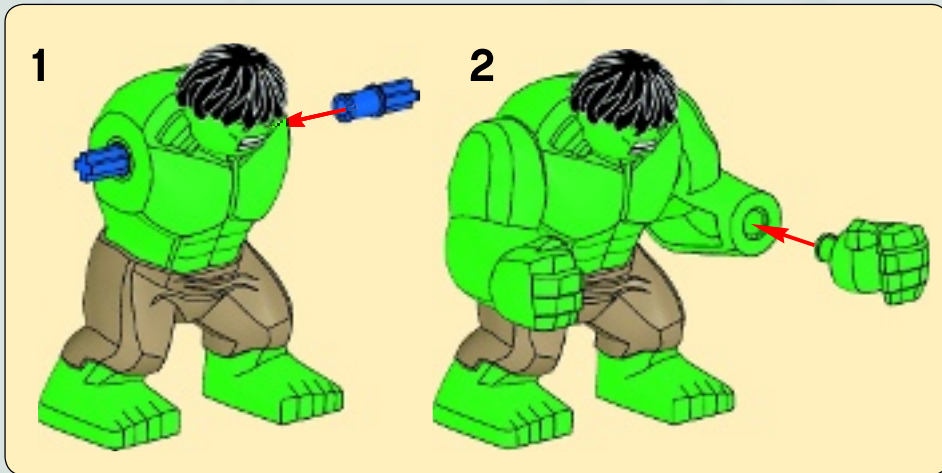
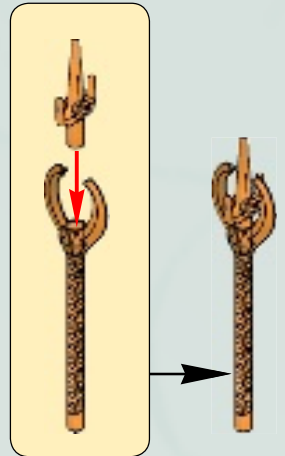
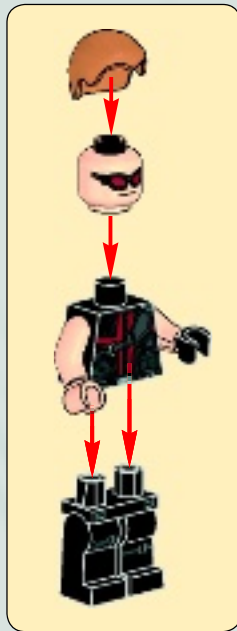

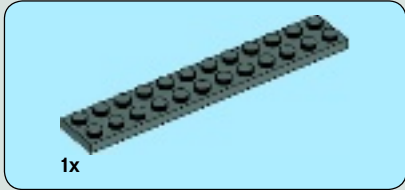

1

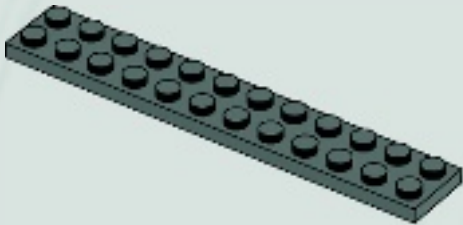

2

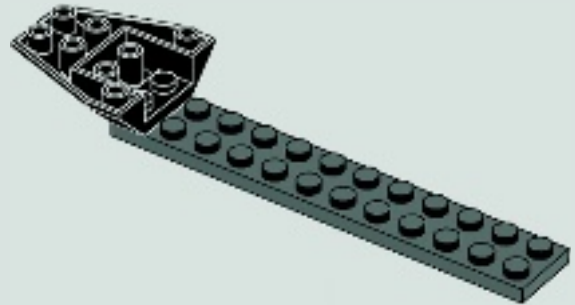



2x

3

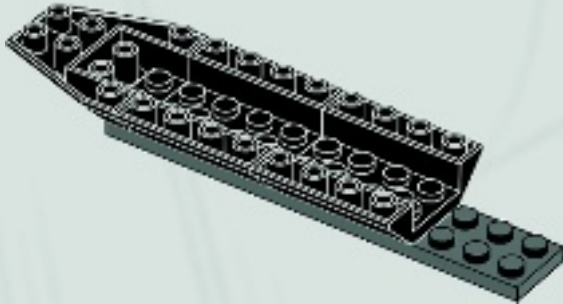

1x



1x

4

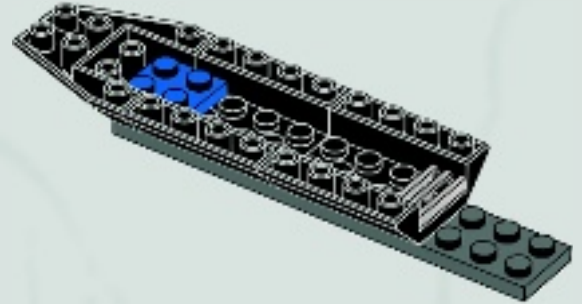



5

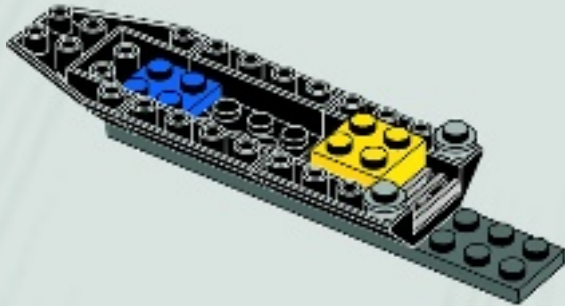

6

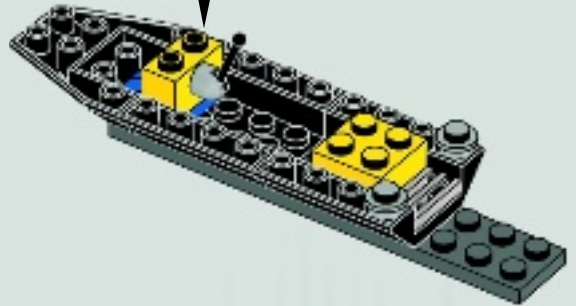
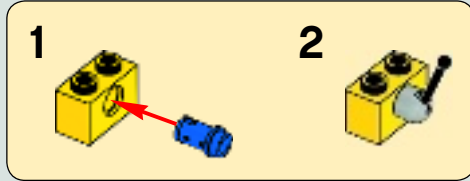

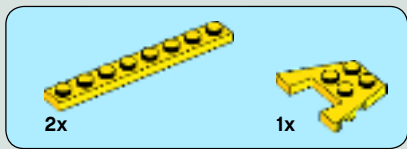

7



8

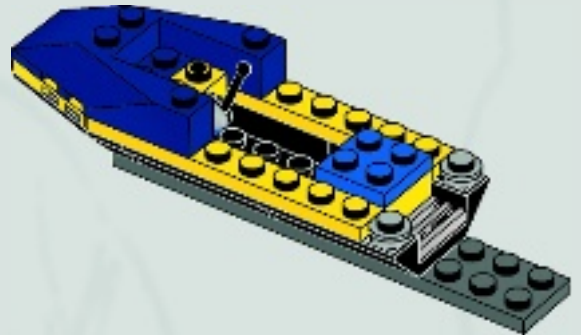
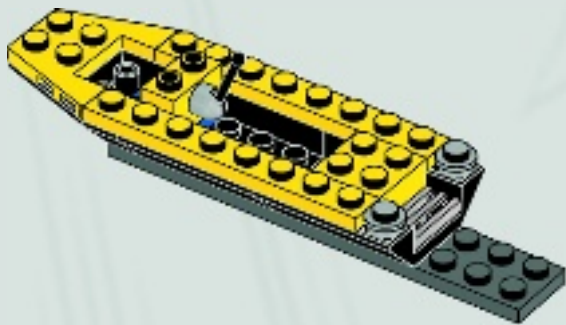



1x

# 9

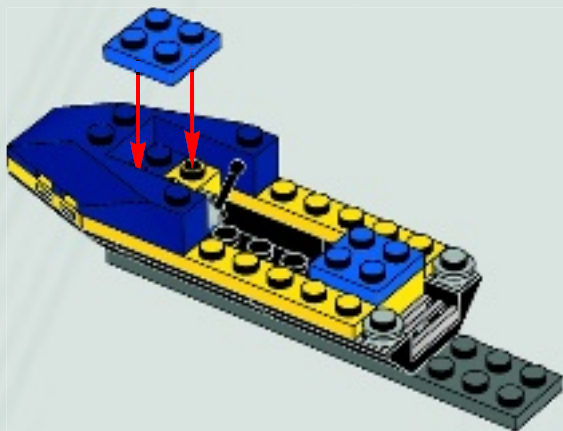

1x



1x

# 10

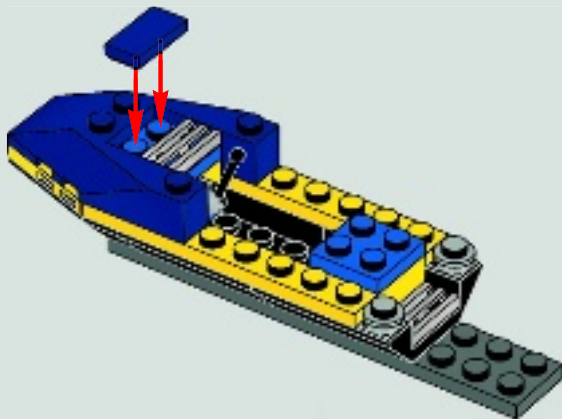



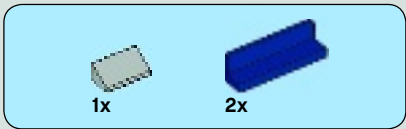

11

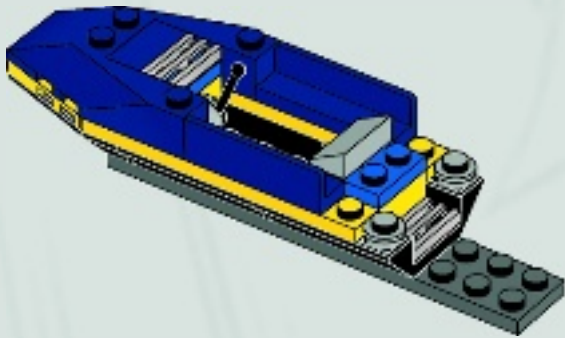

12

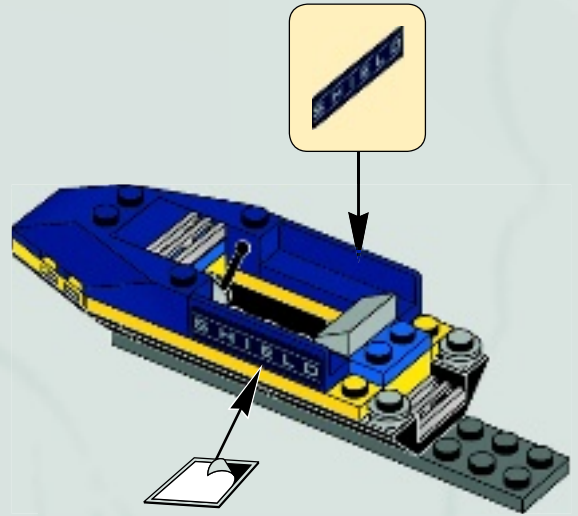



1



2



3





4

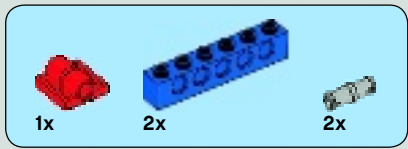

5

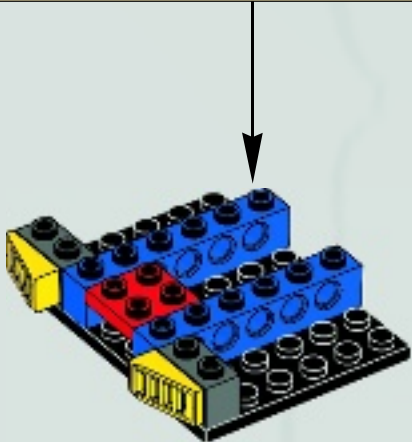
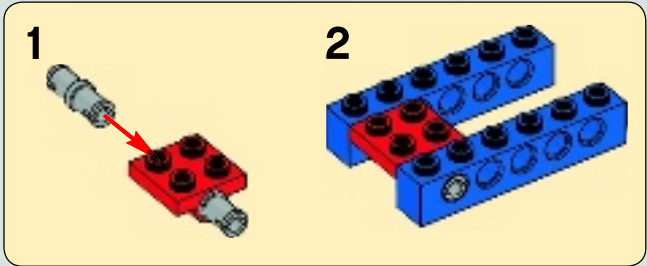



6

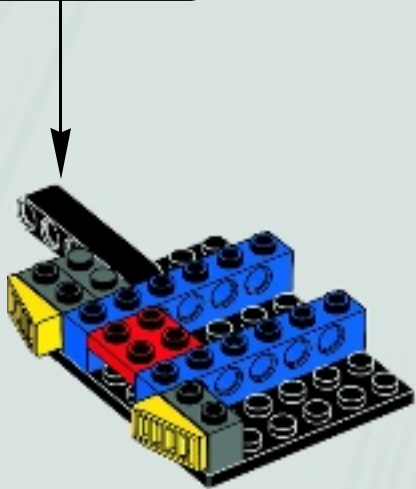
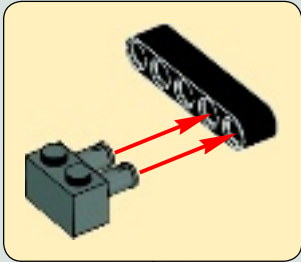

7

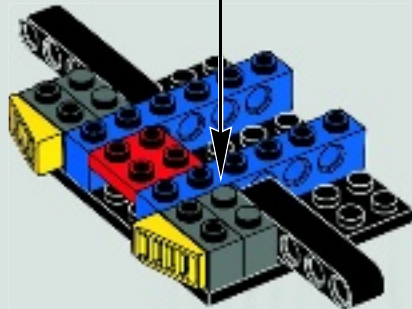
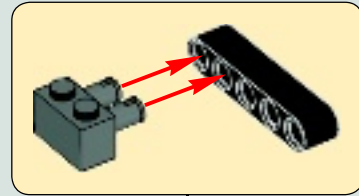

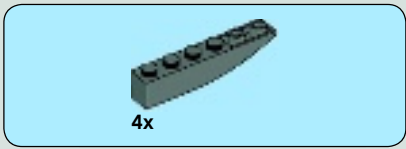

8

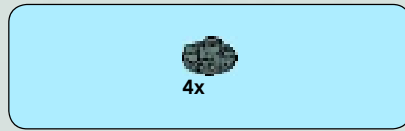
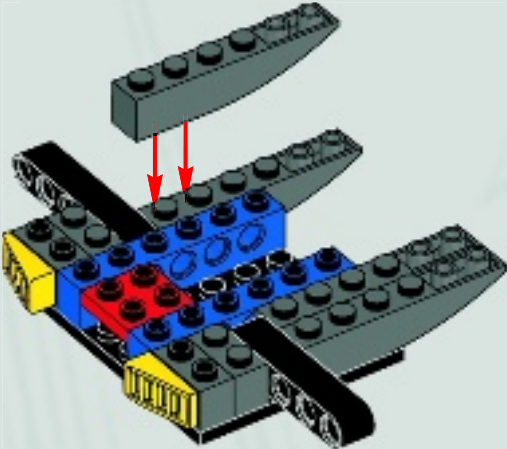

9

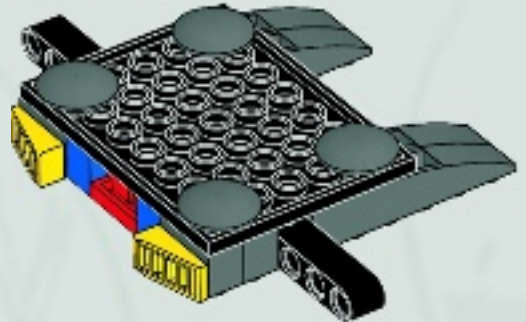
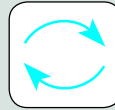

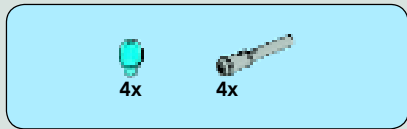

10

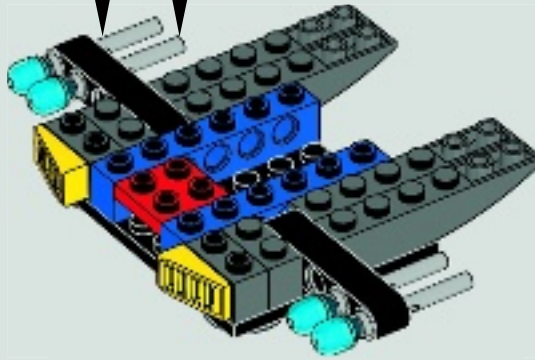
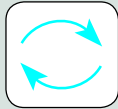
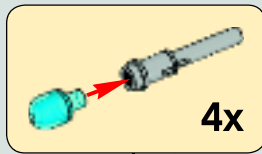

13

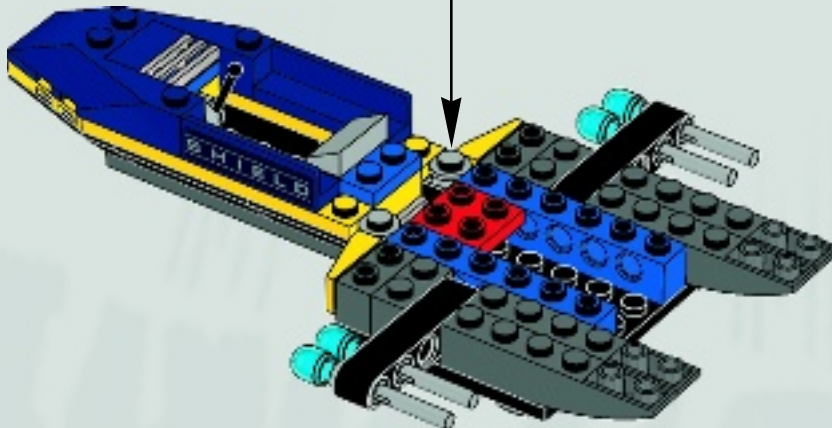

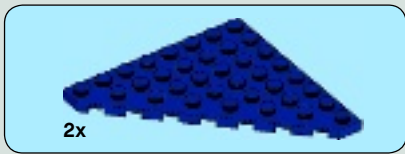

14

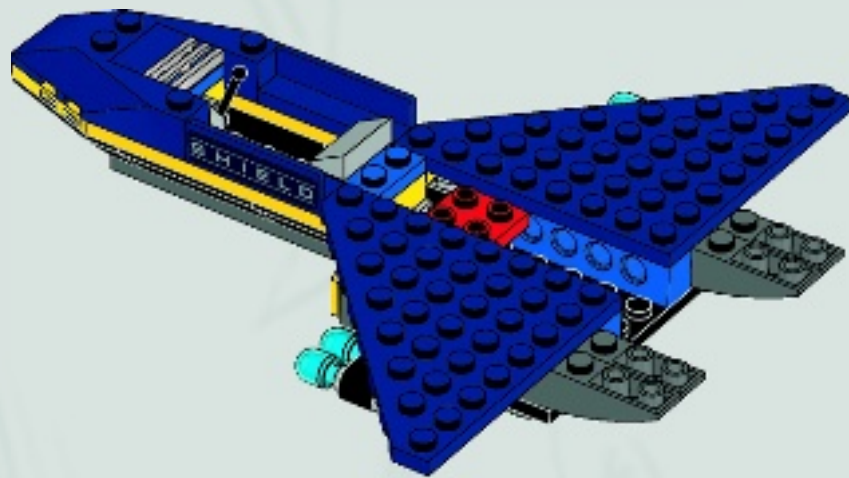



1x



2x

# 15

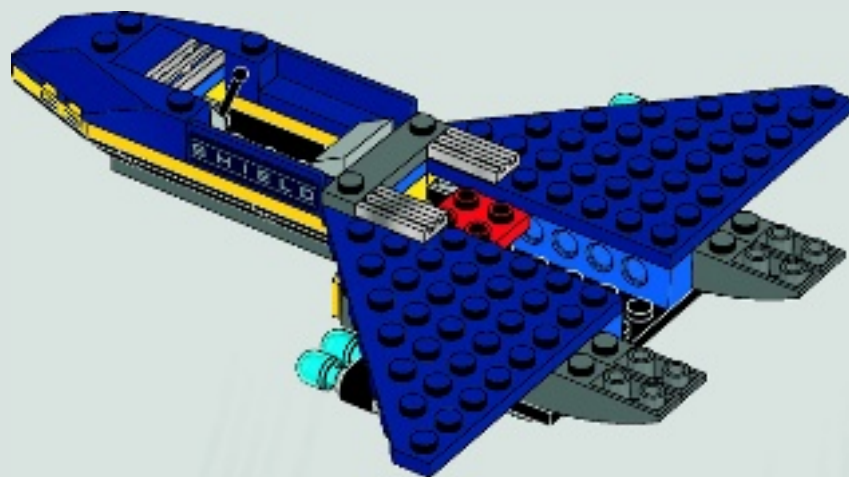



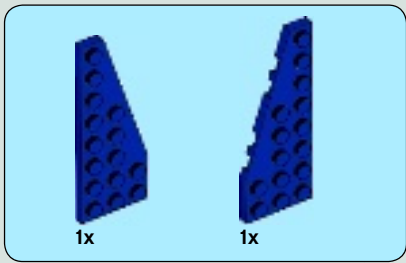

16

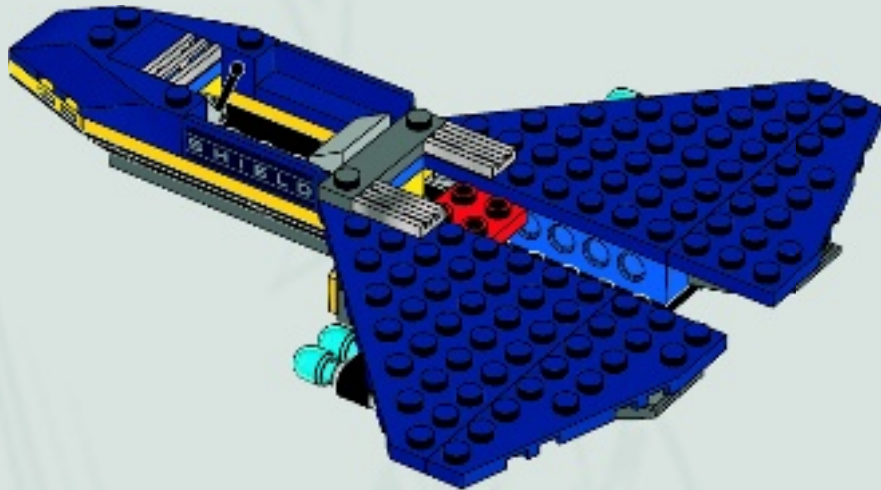

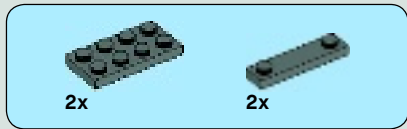

17

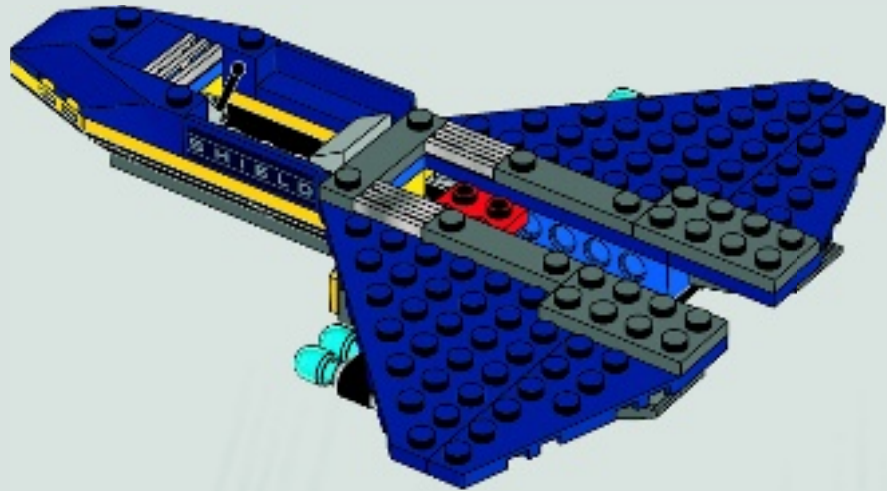

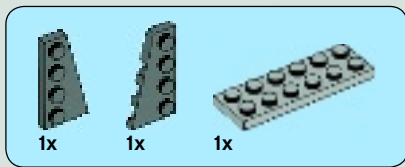

18

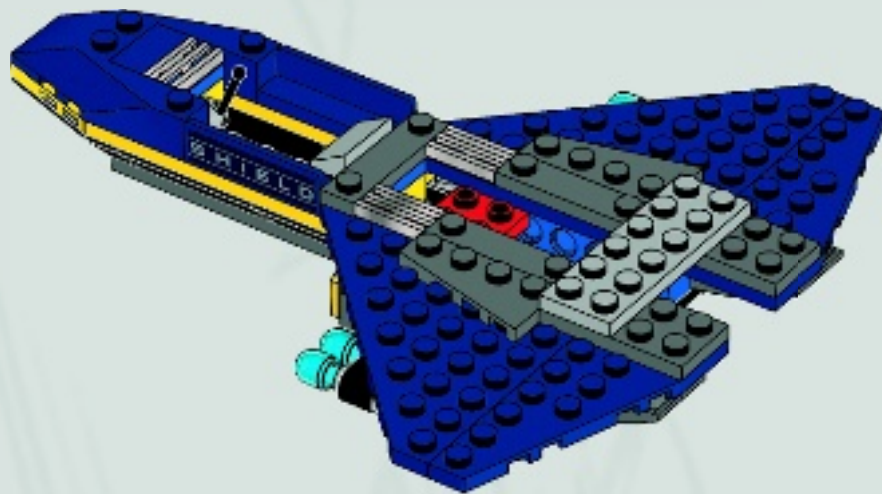



2x



2x



2x

# 19

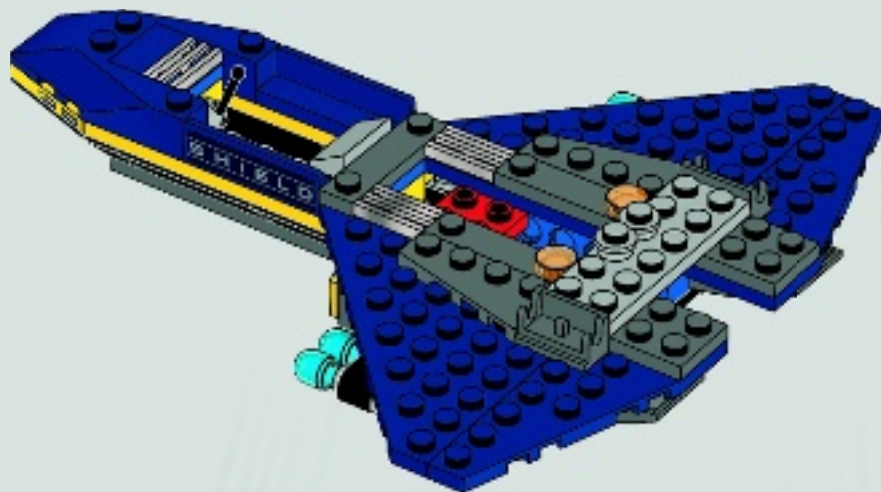

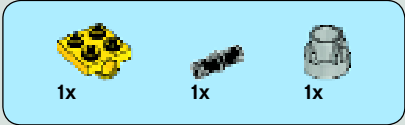

# 20

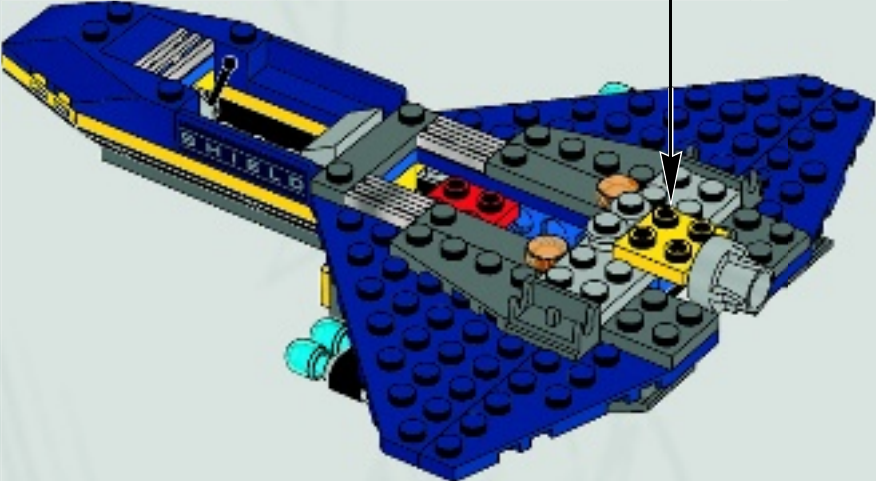
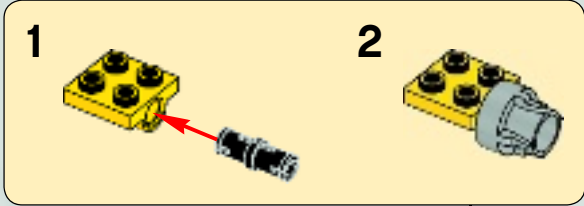



2x



2x

# 21

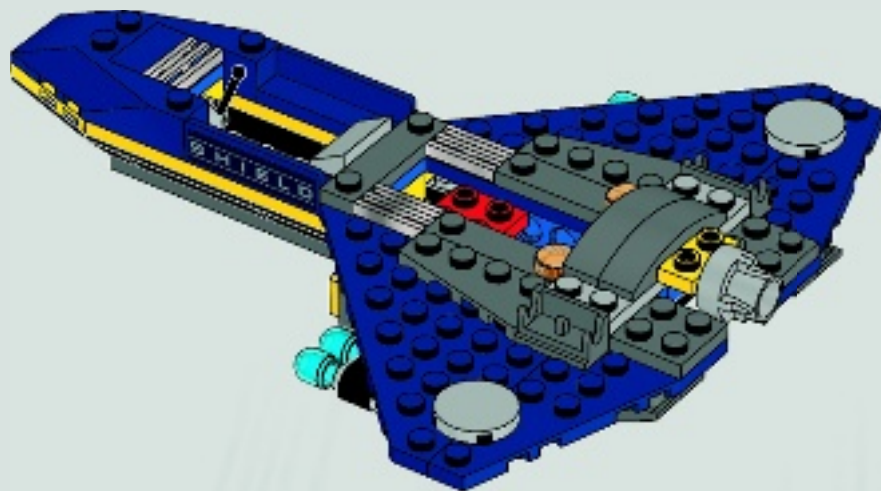



2x



2x

# 22

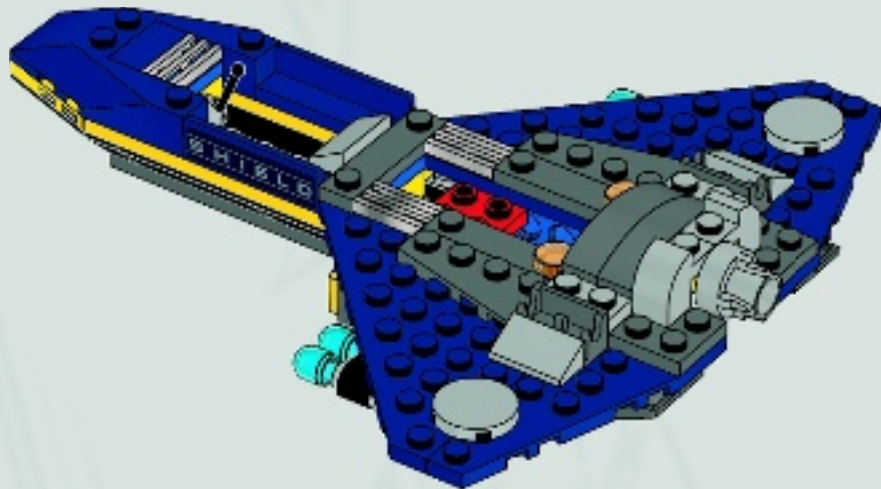



1x



2x

# 23

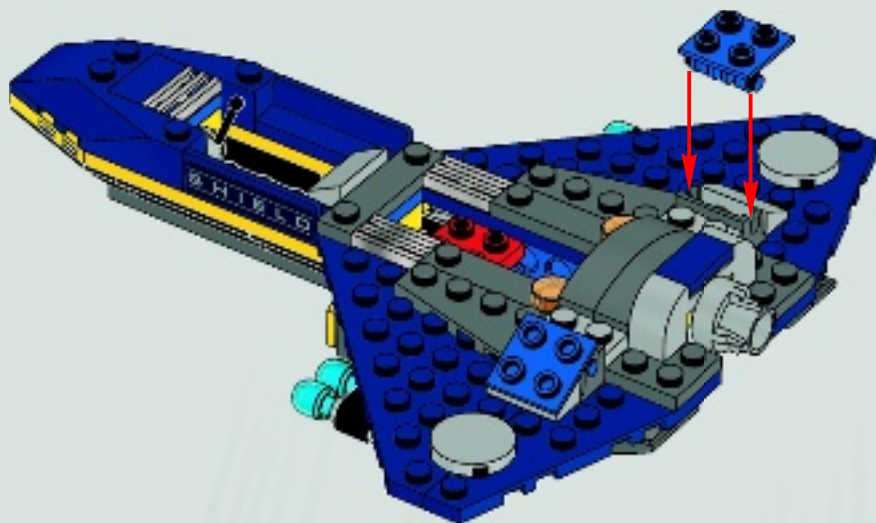





4x

# 24

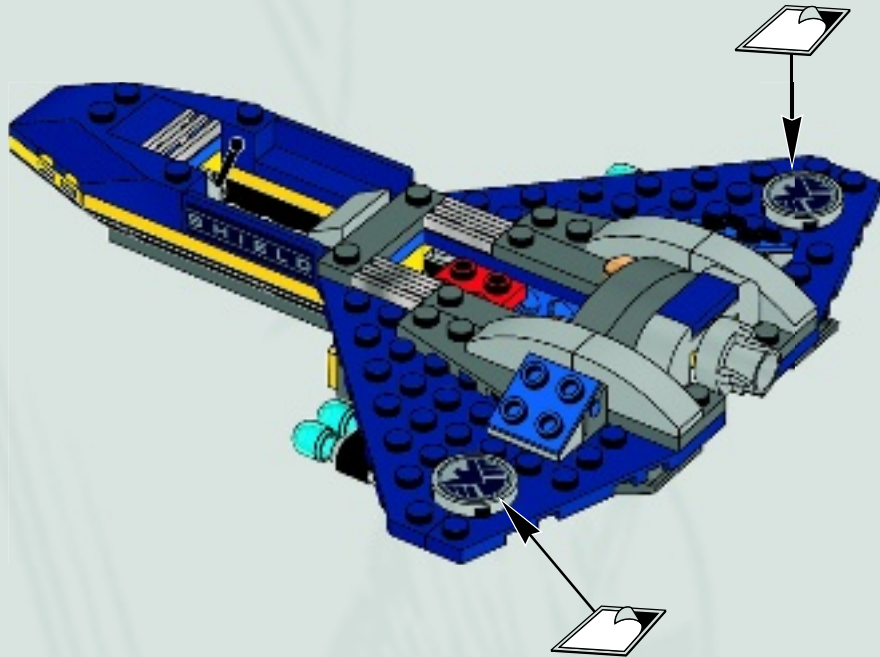

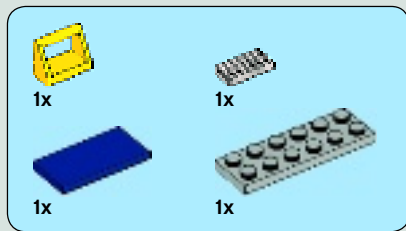

# 25

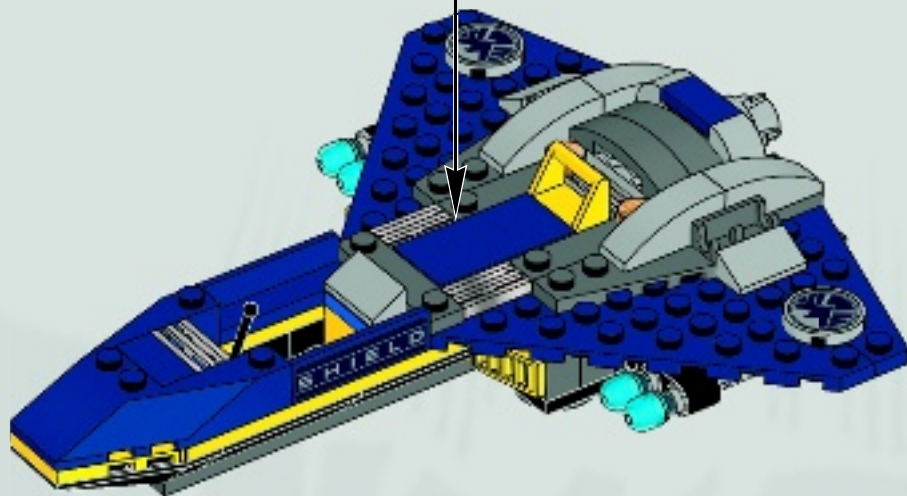
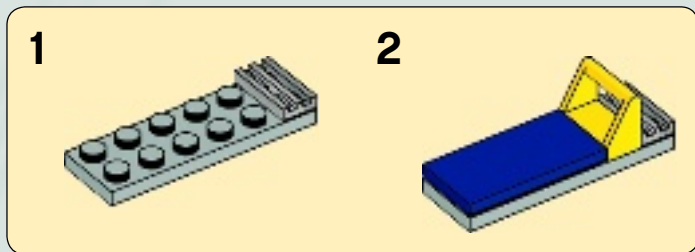

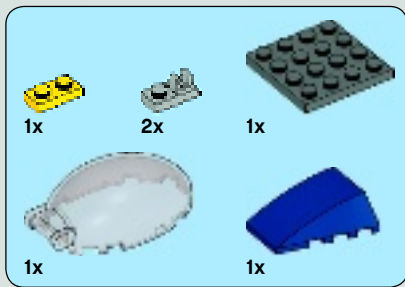

# 26

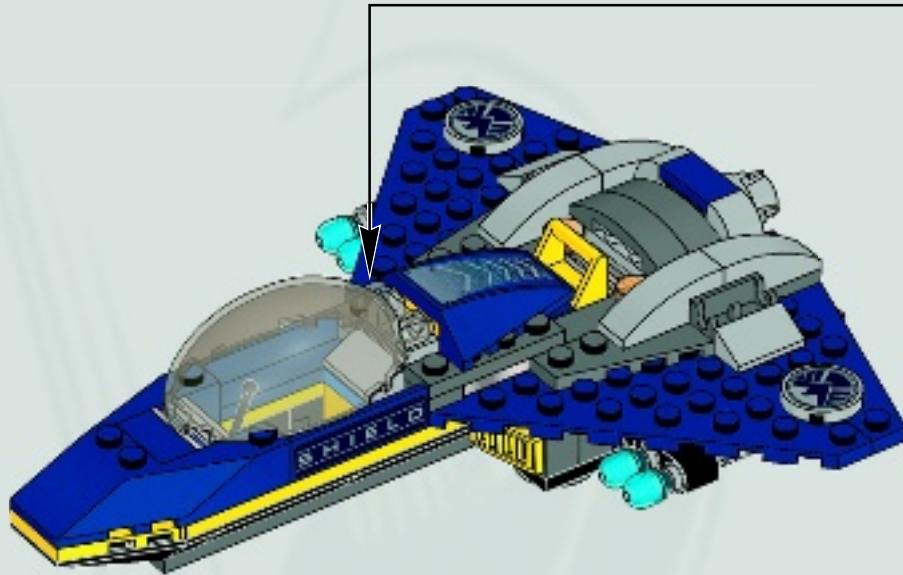
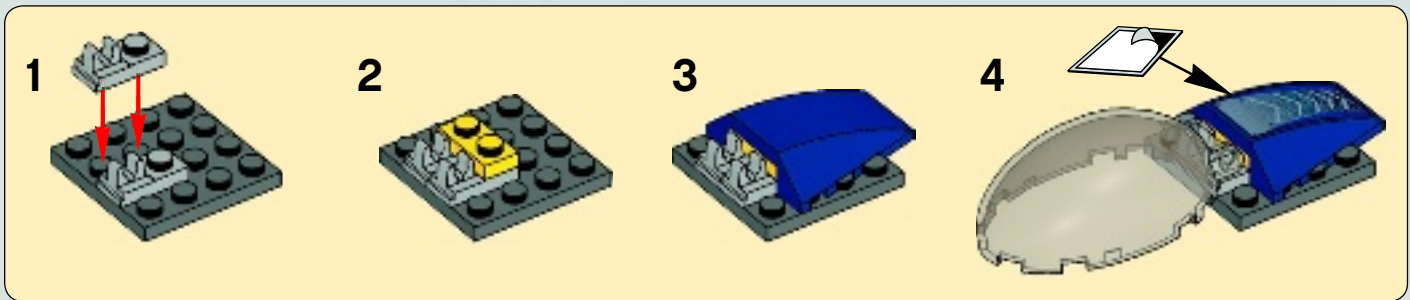



27

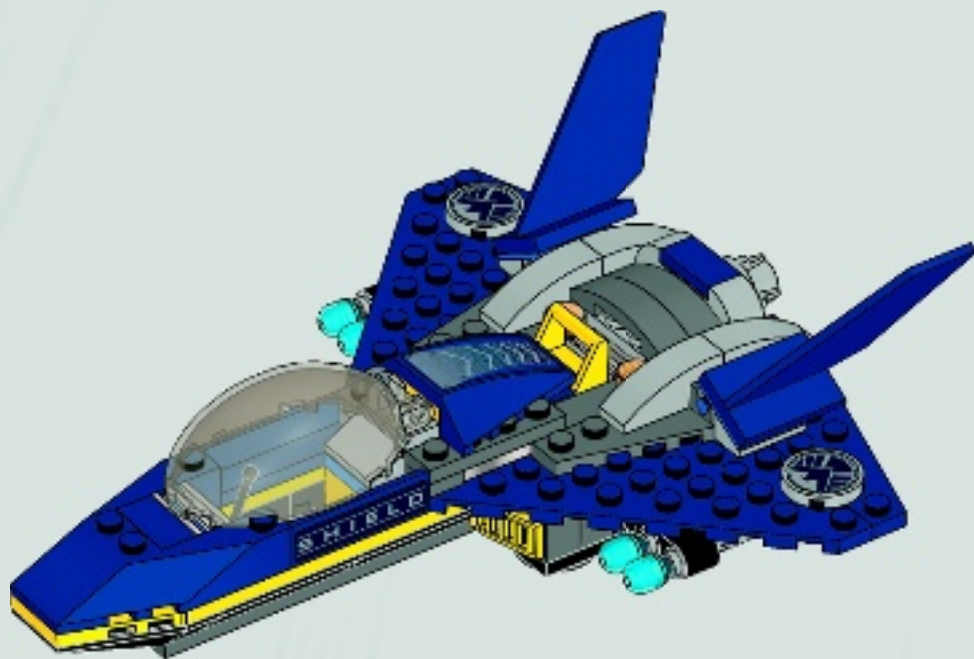



1

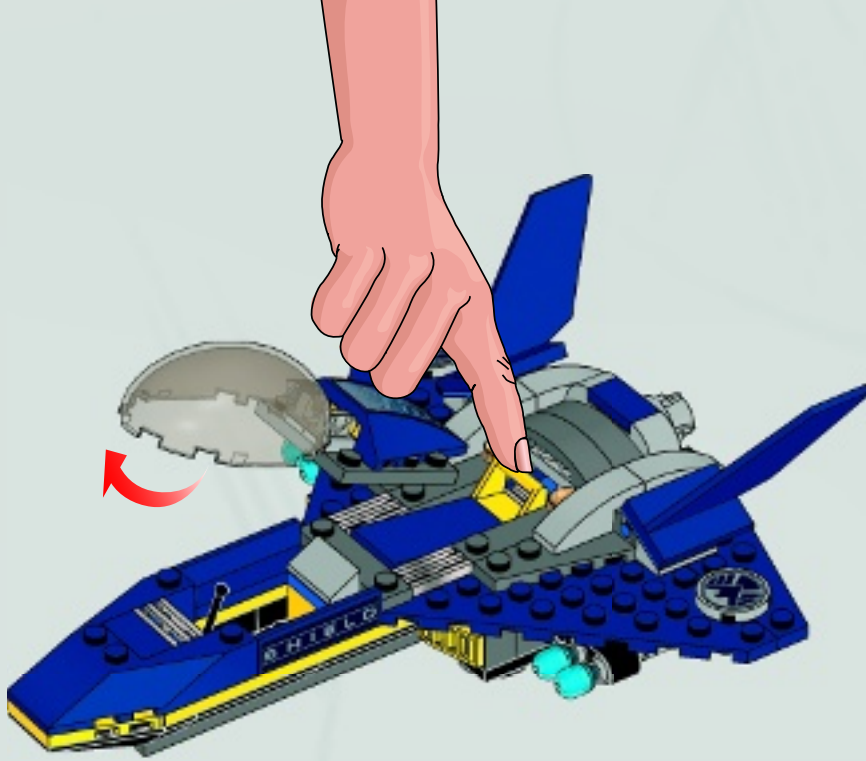

2



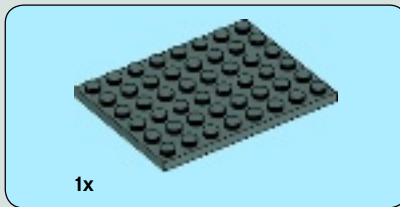

1

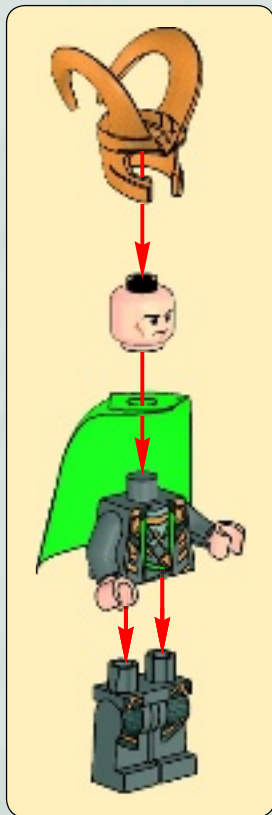



1x

**2**



1x



1x

**3**

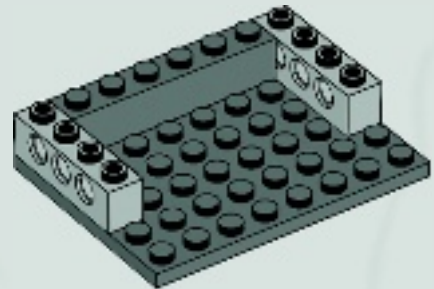



1x



2x

4

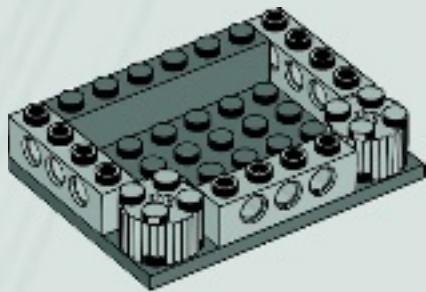

4x

5

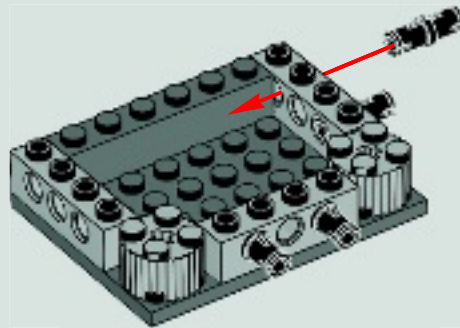



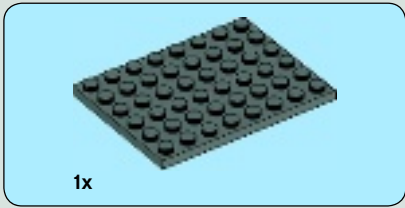

6

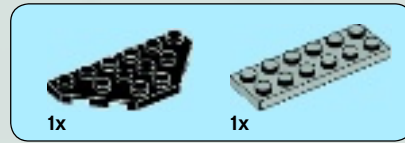

7



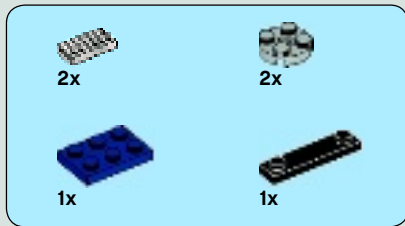

8



9

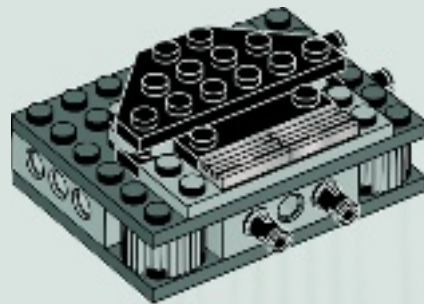



4x



2x

# 10

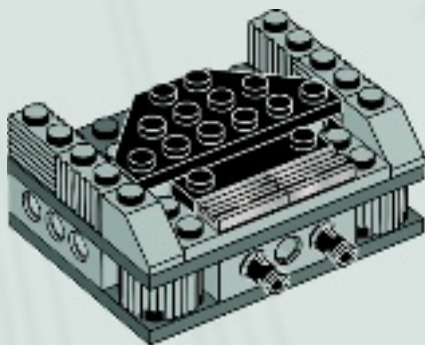

2x

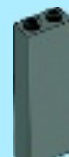

4x

# 11

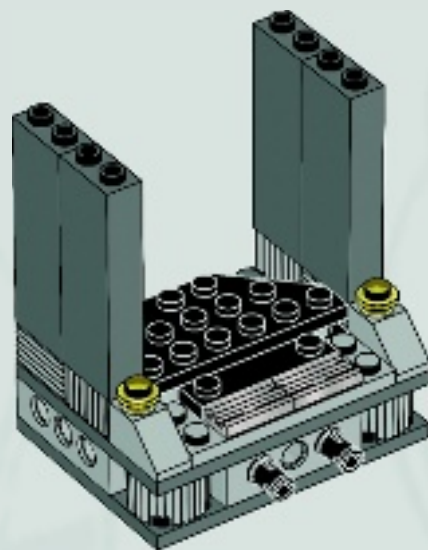



# 12

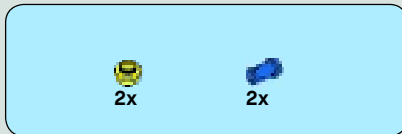
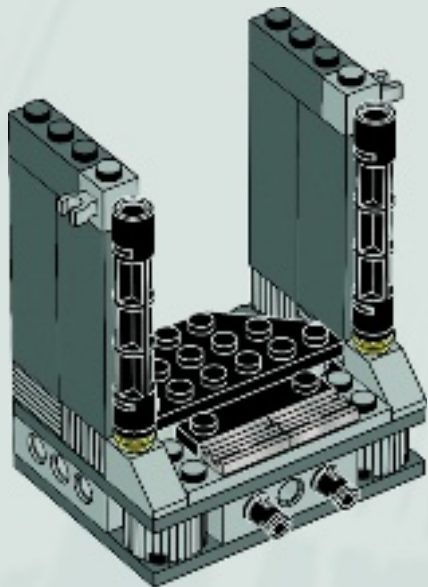

# 13

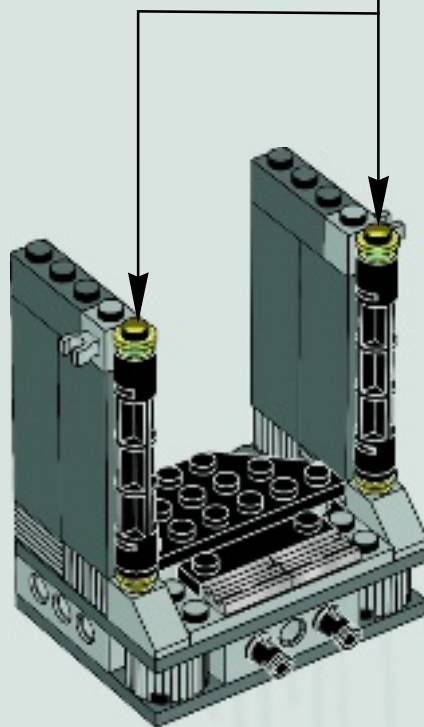

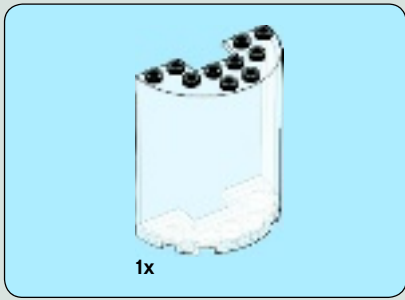

14

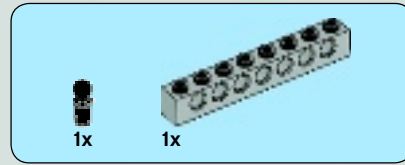
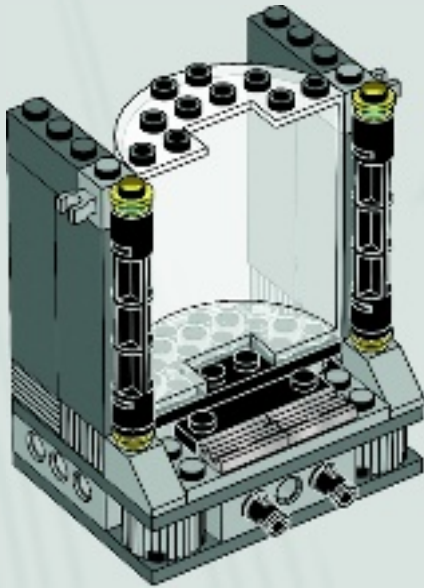

15

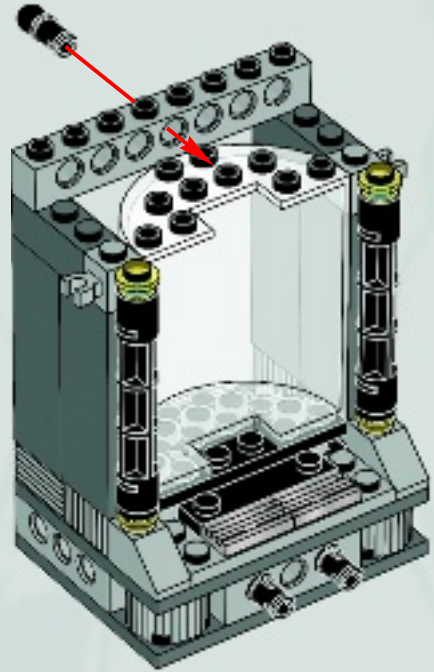



2x



1x

# 16

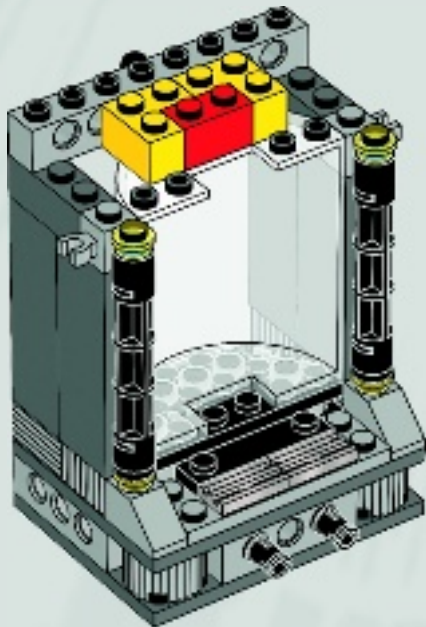

2x



2x

# 17

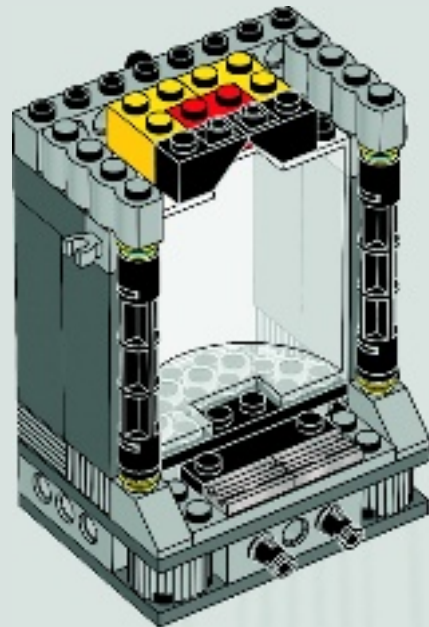

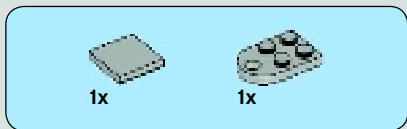

18

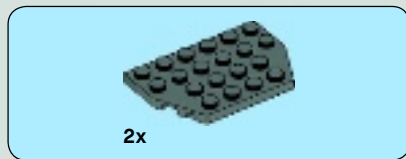
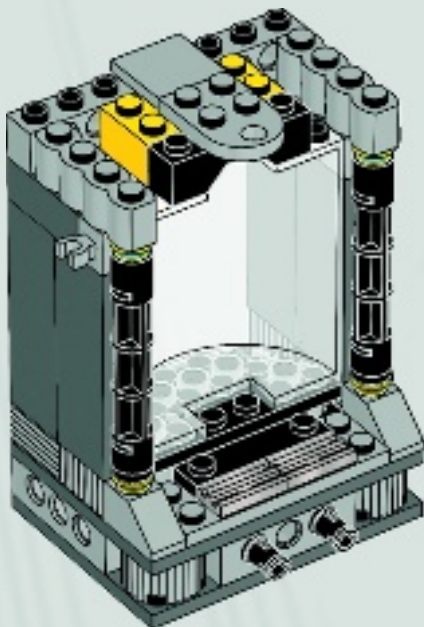

19

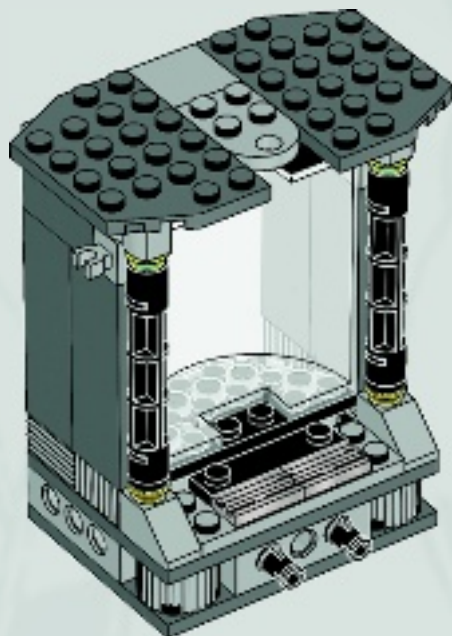



20

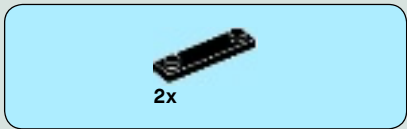
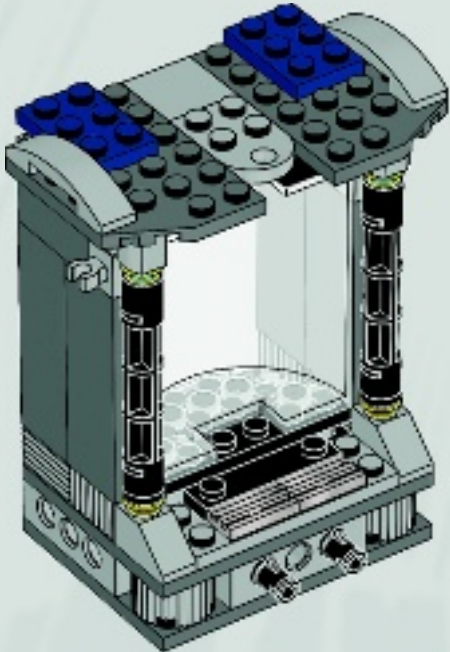

21

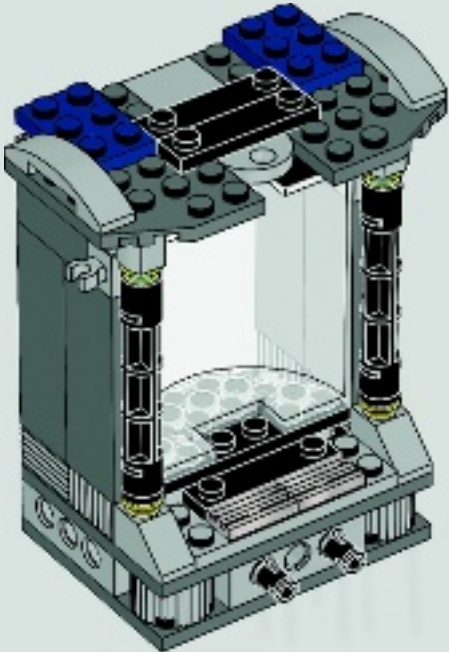





# 22

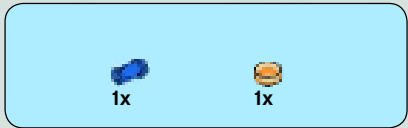
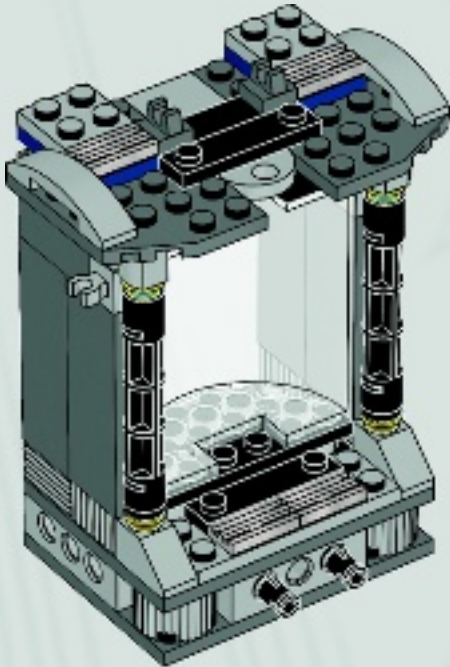

# 23

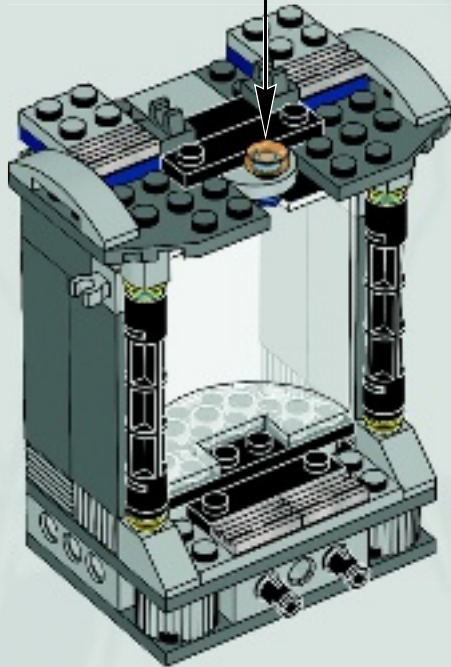
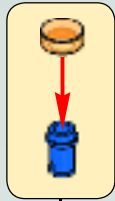



1x

# 24

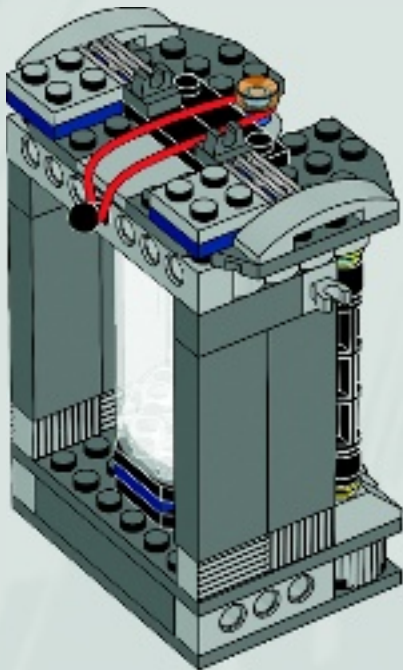

1x

# 25

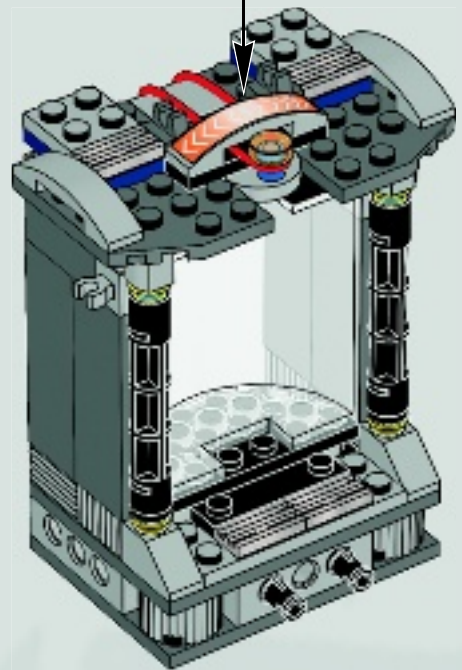
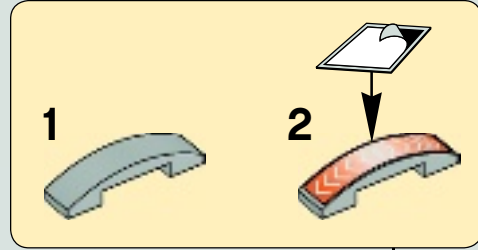

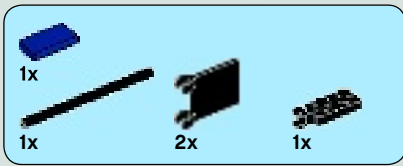

# 26

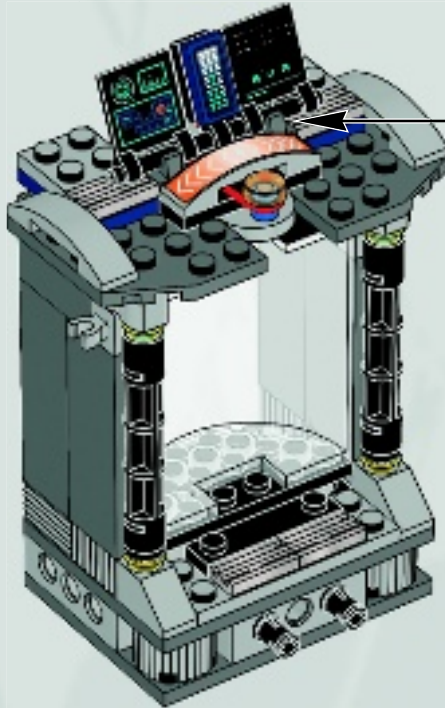
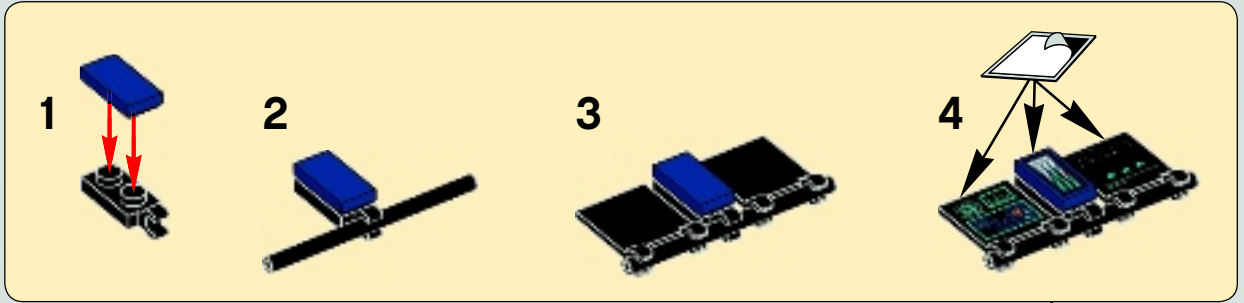

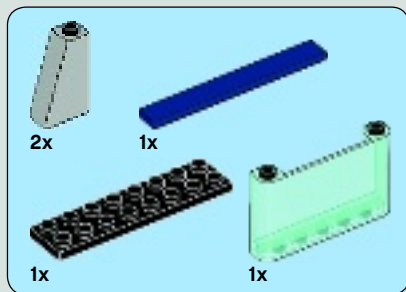

27

1

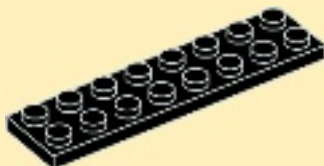

2

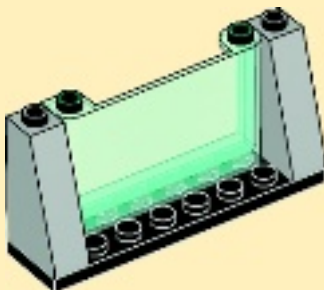

3

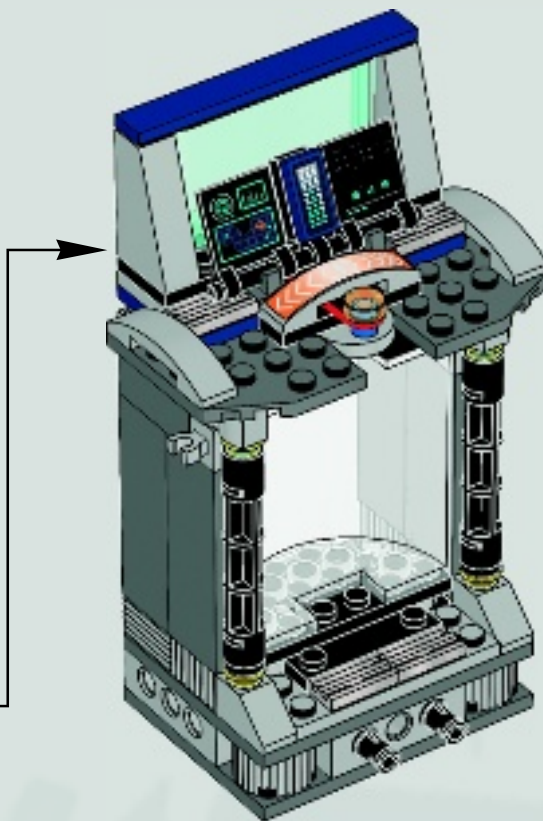
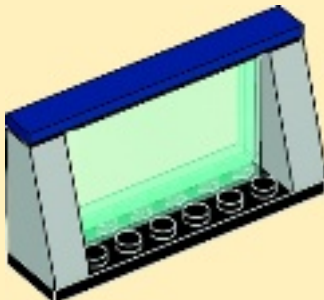



2x

# 28

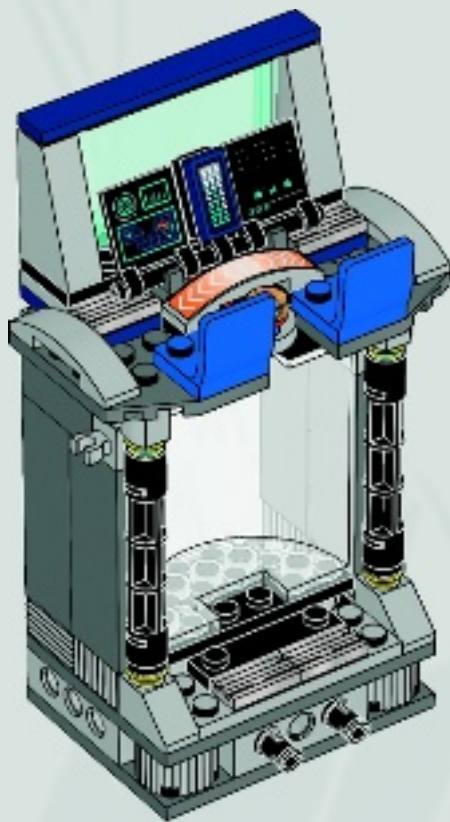

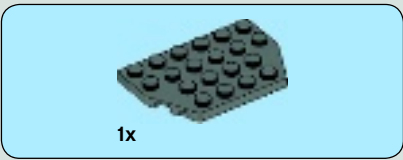

1

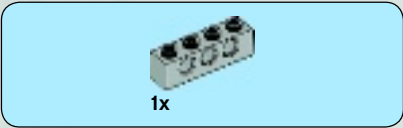
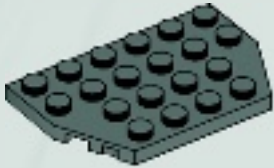

2

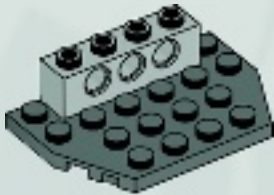

3

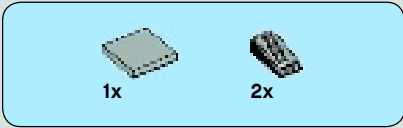
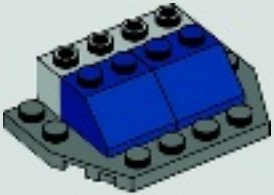

4

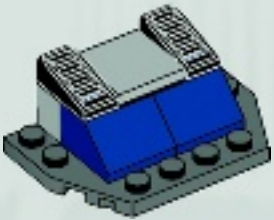

29

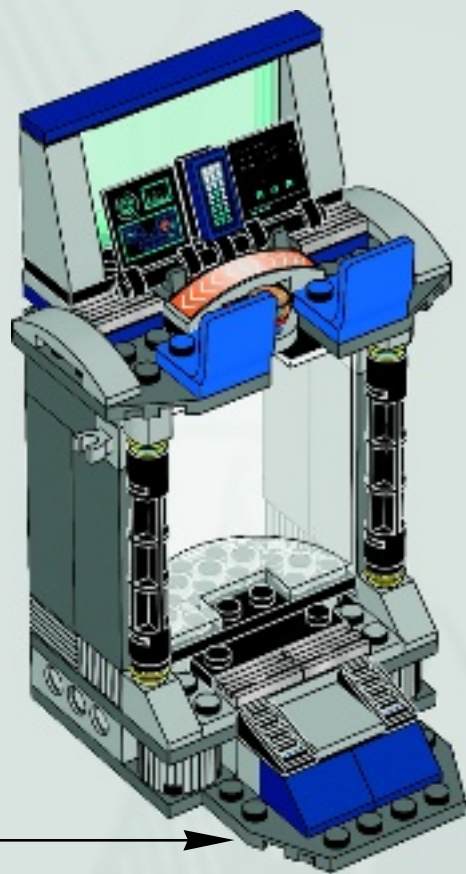



1



2

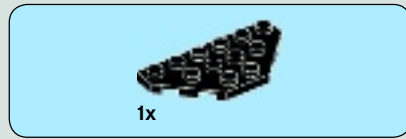

3

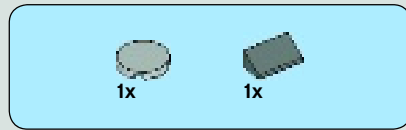

4





5



30

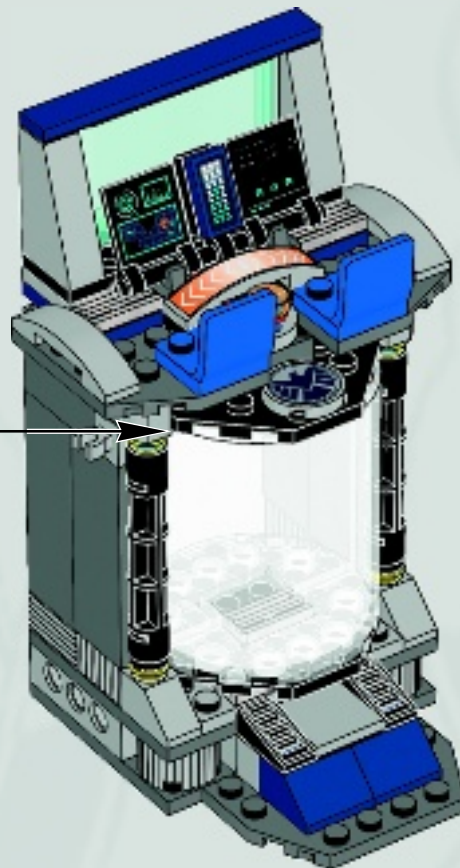

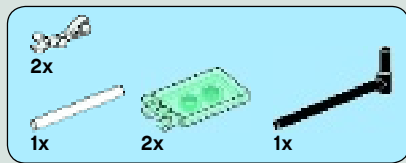

# 31

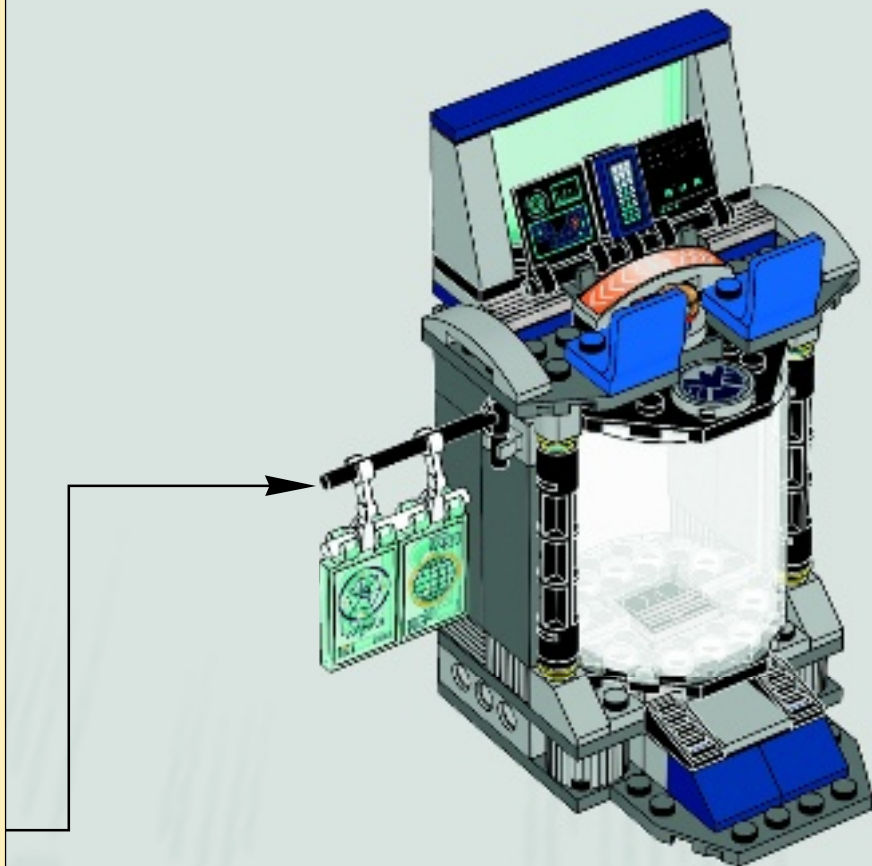
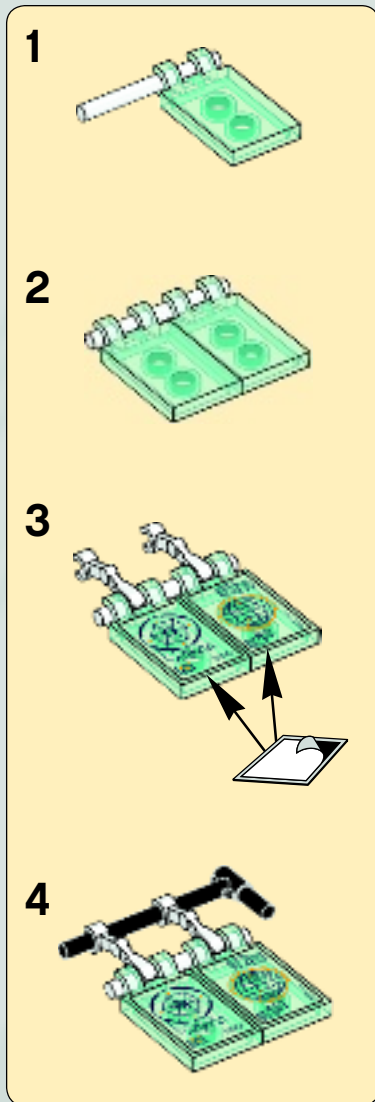



1x



1x

# 32

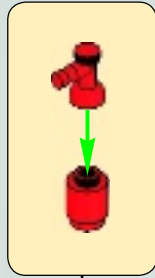



1

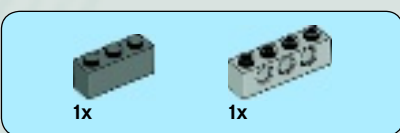

2

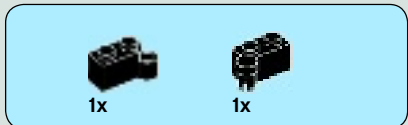

3

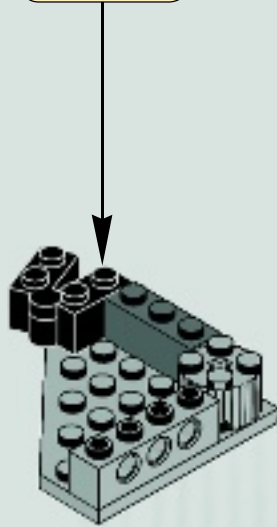
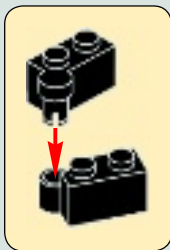



1x



1x

4



1x

5



1x

6



1x



1x

7





1x

8



1x



2x



2x

9

1

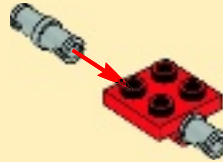

2

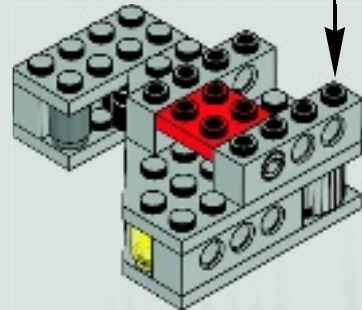
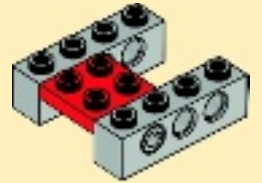



2x

10



2x

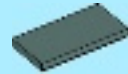

1x

11

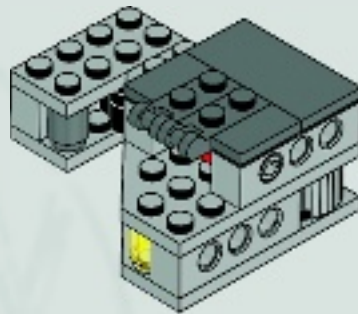

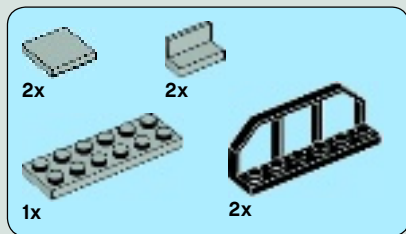

# 12

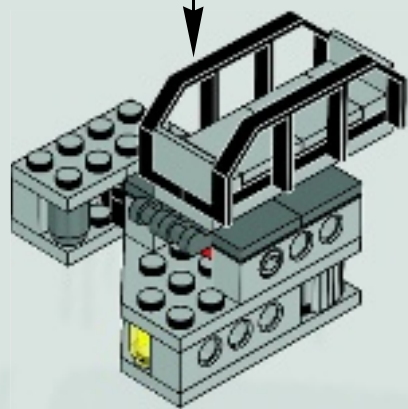
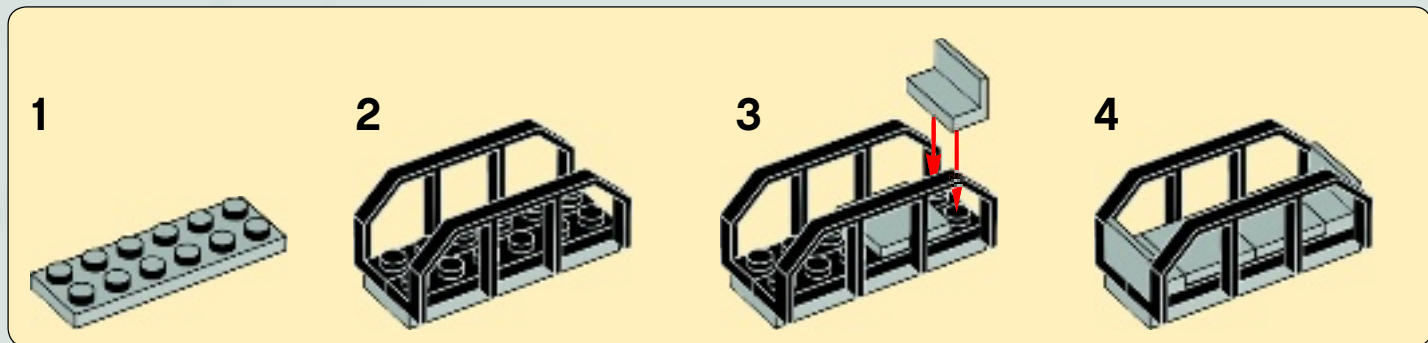



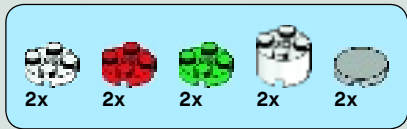

13

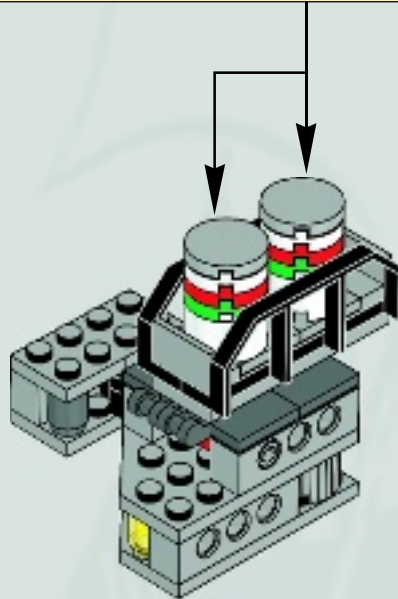
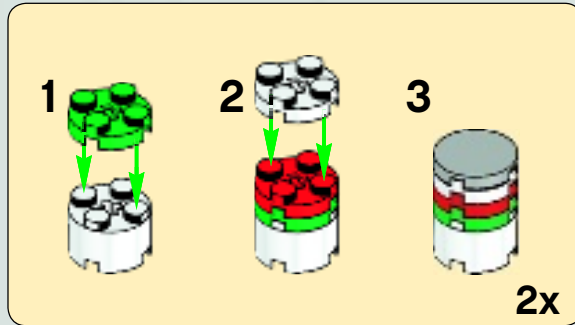

# 33

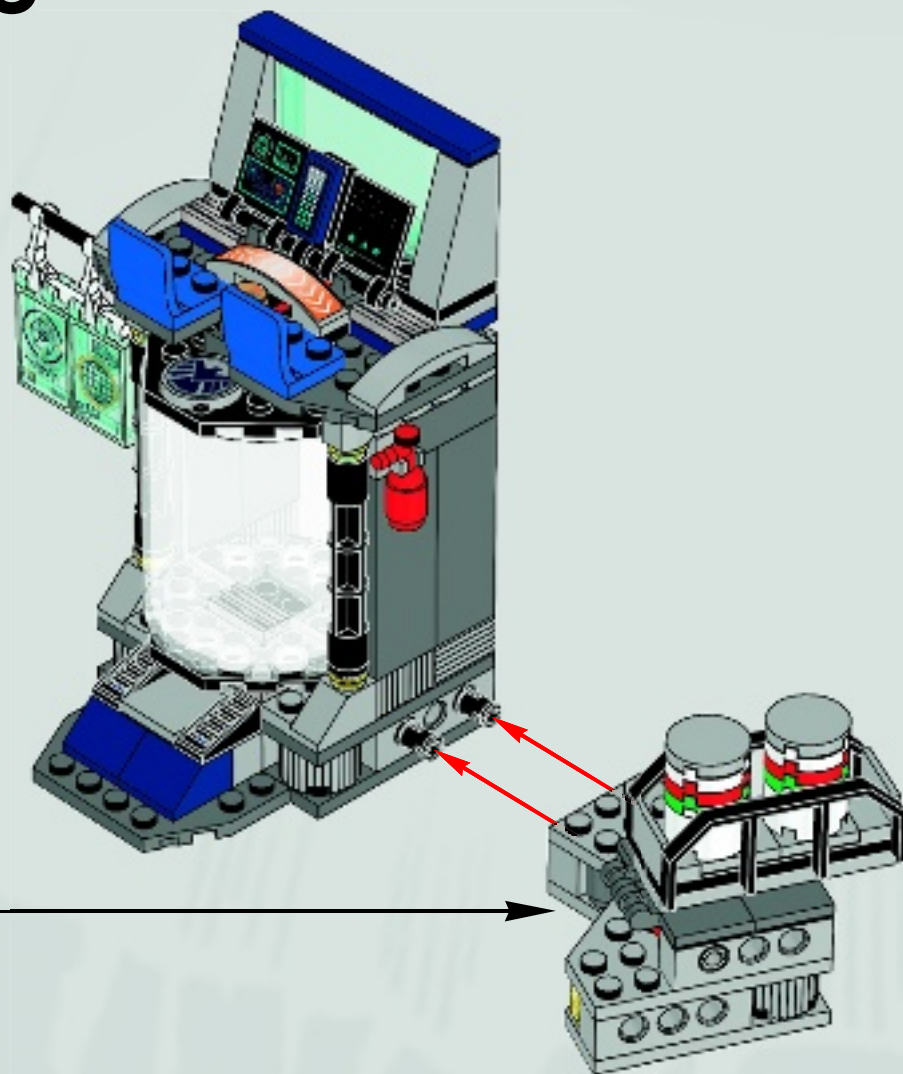



3

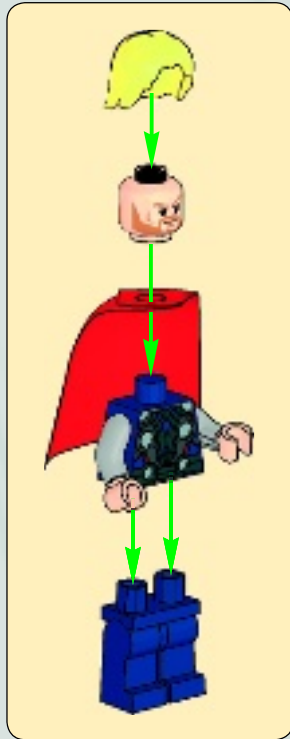



1

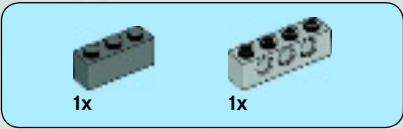

2

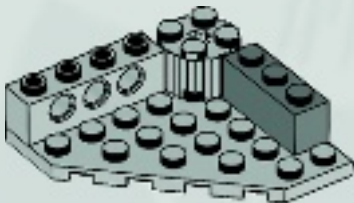

3

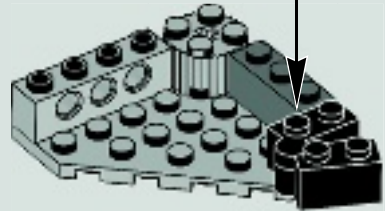
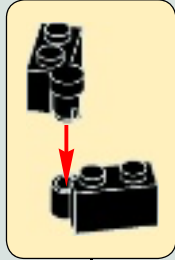



1x



1x

4

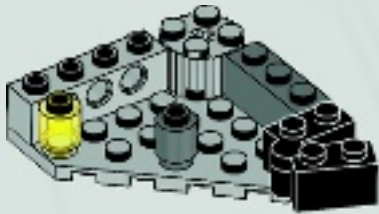

1x

5



1x

6



1x

1x

7





1x

8

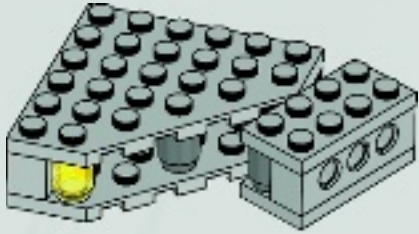

2x



1x

9

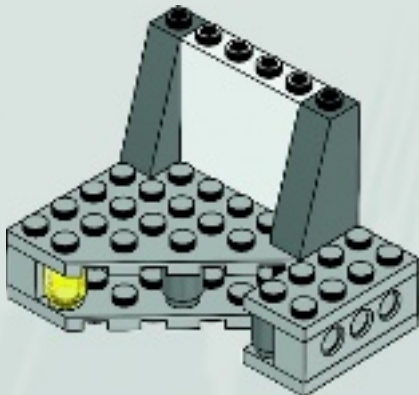

2x



1x

10

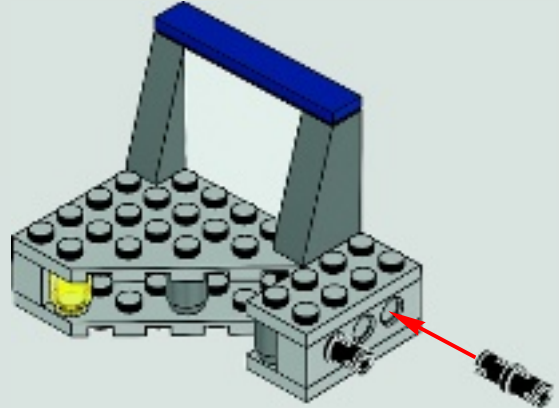

34

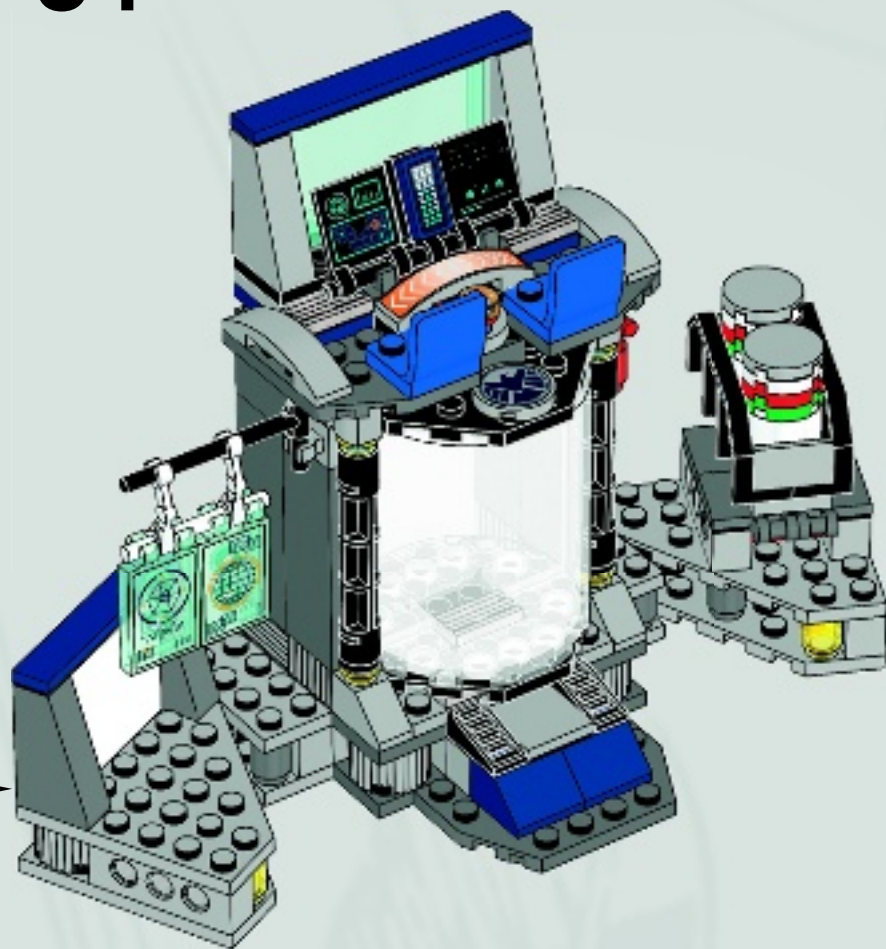



4x

# 35

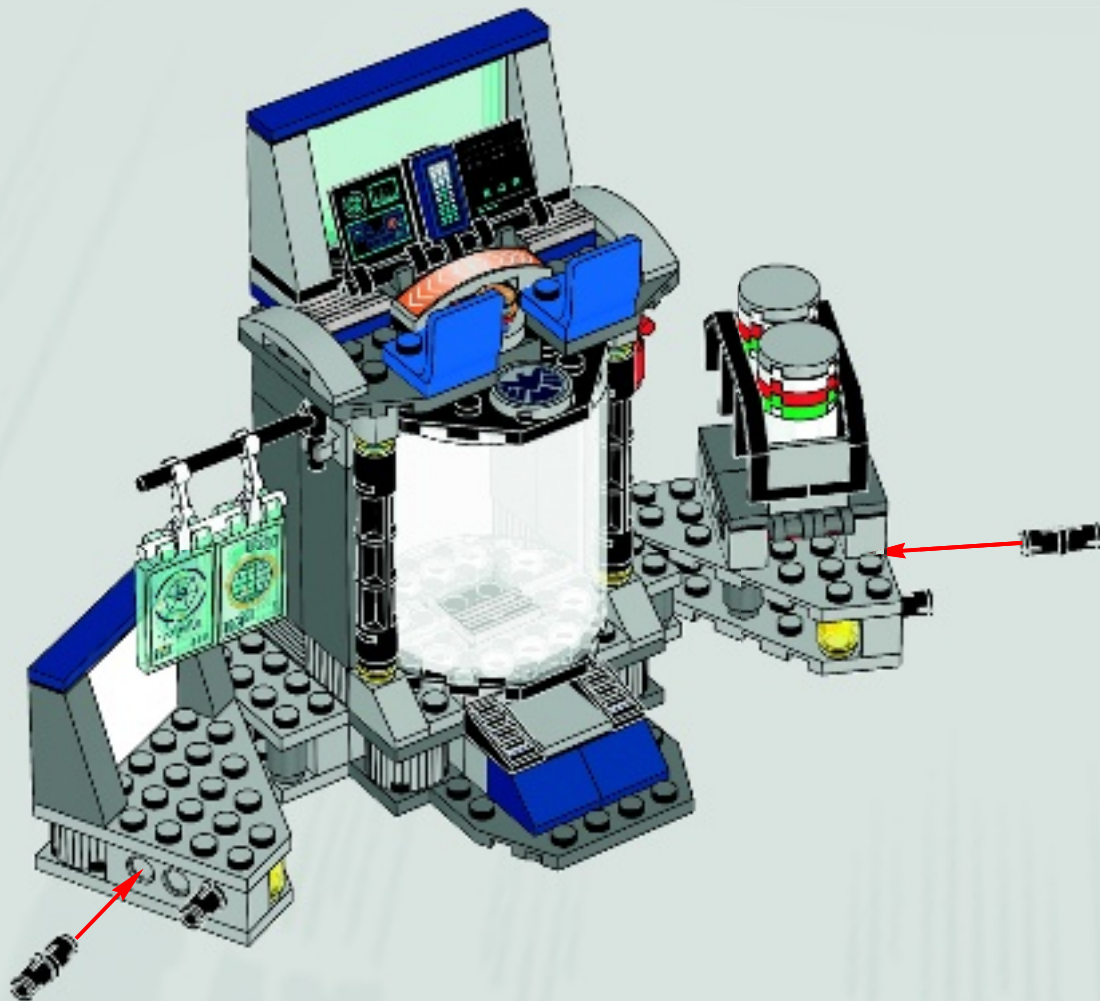



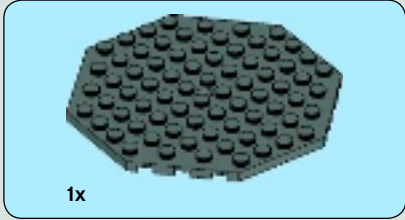
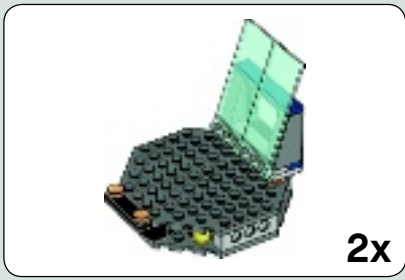

1

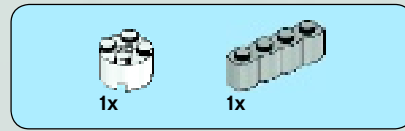

2

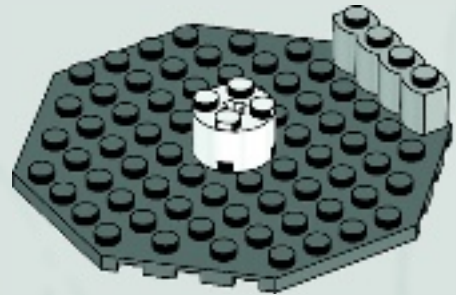



2x

3

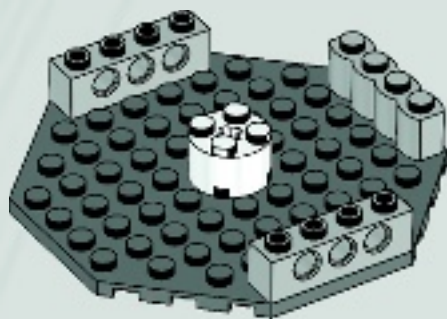

4x

4

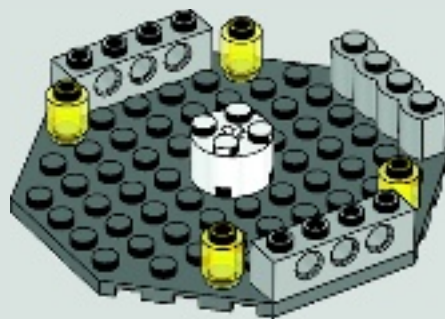



2x

5

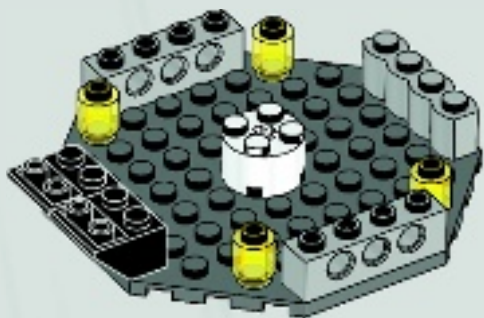

1x

6

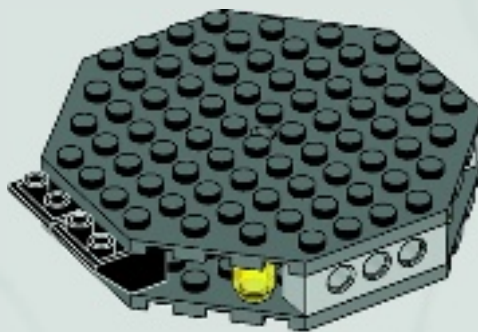



3x

7

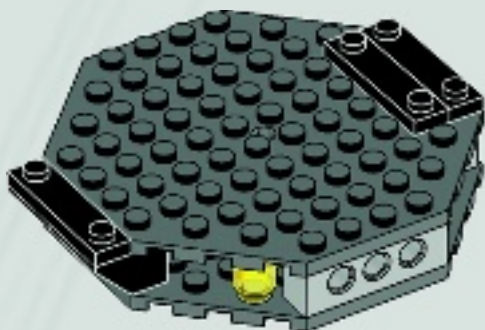

4x

8

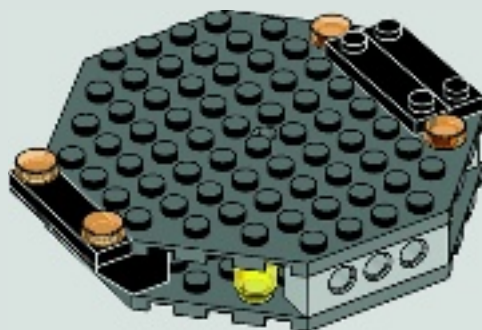

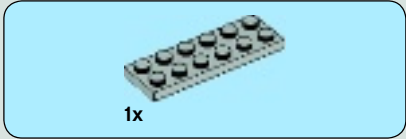
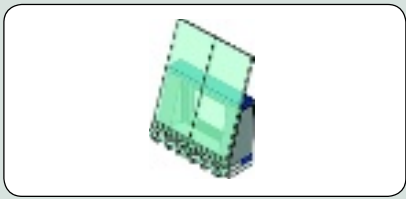

1x

1

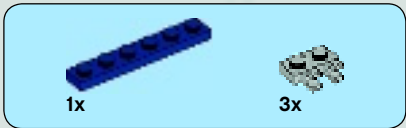
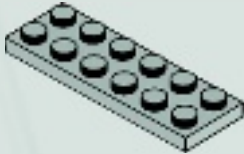

1x

3x

2

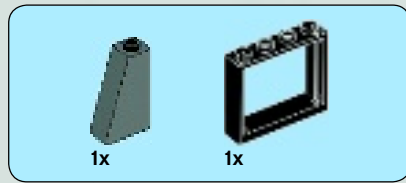

1x

1x

3

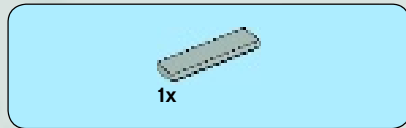
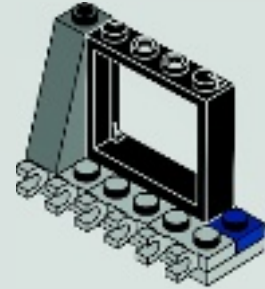

1x

4

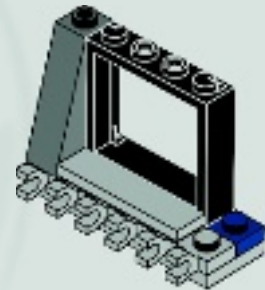

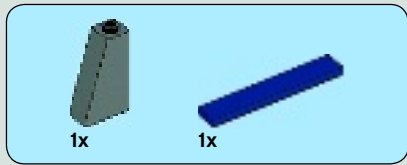

5

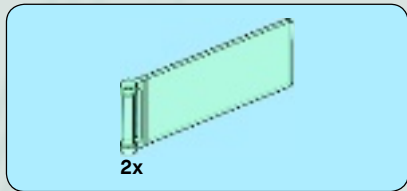
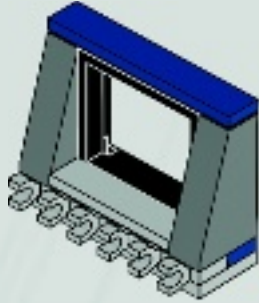

6

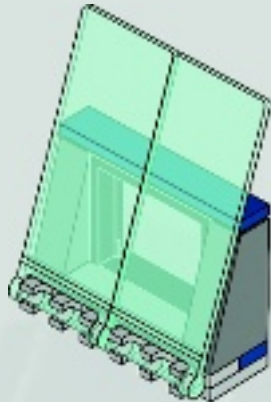

7

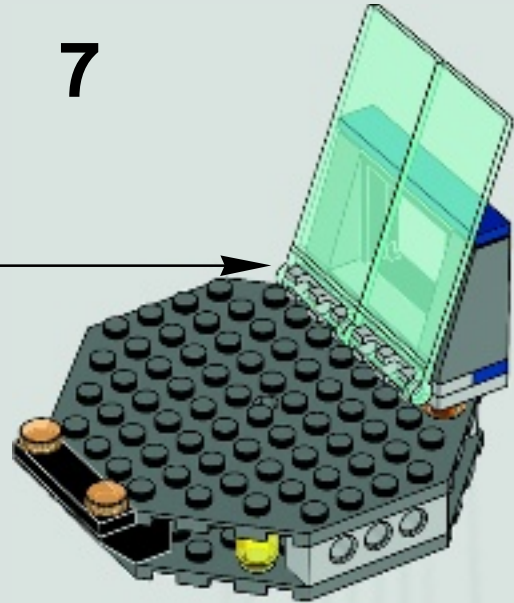

2x

36

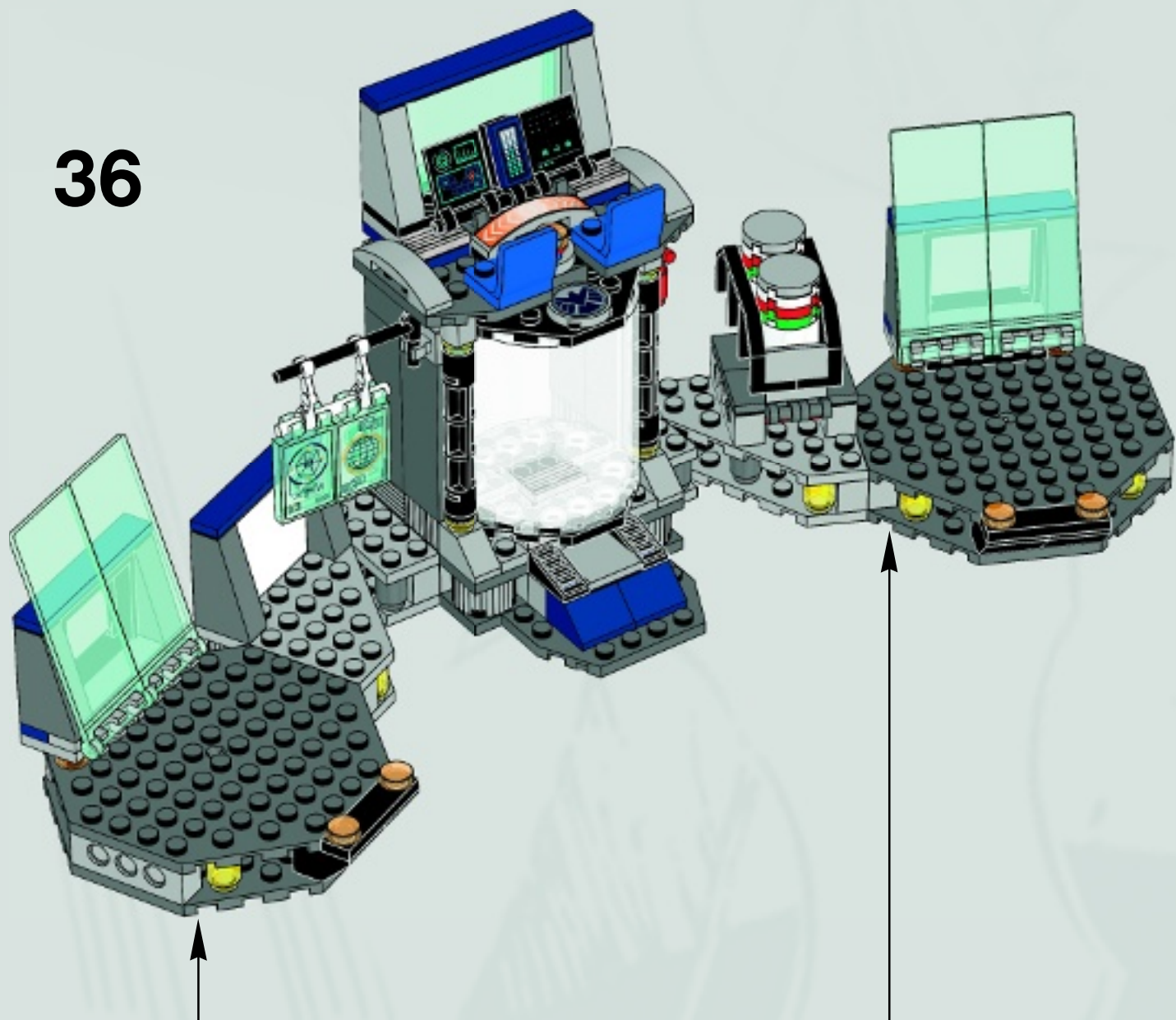



1x



1x

1



1x

2



1x

3



1x



1x



1x



1x

4

1



2



3

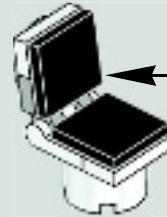

5

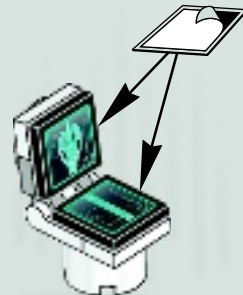



37

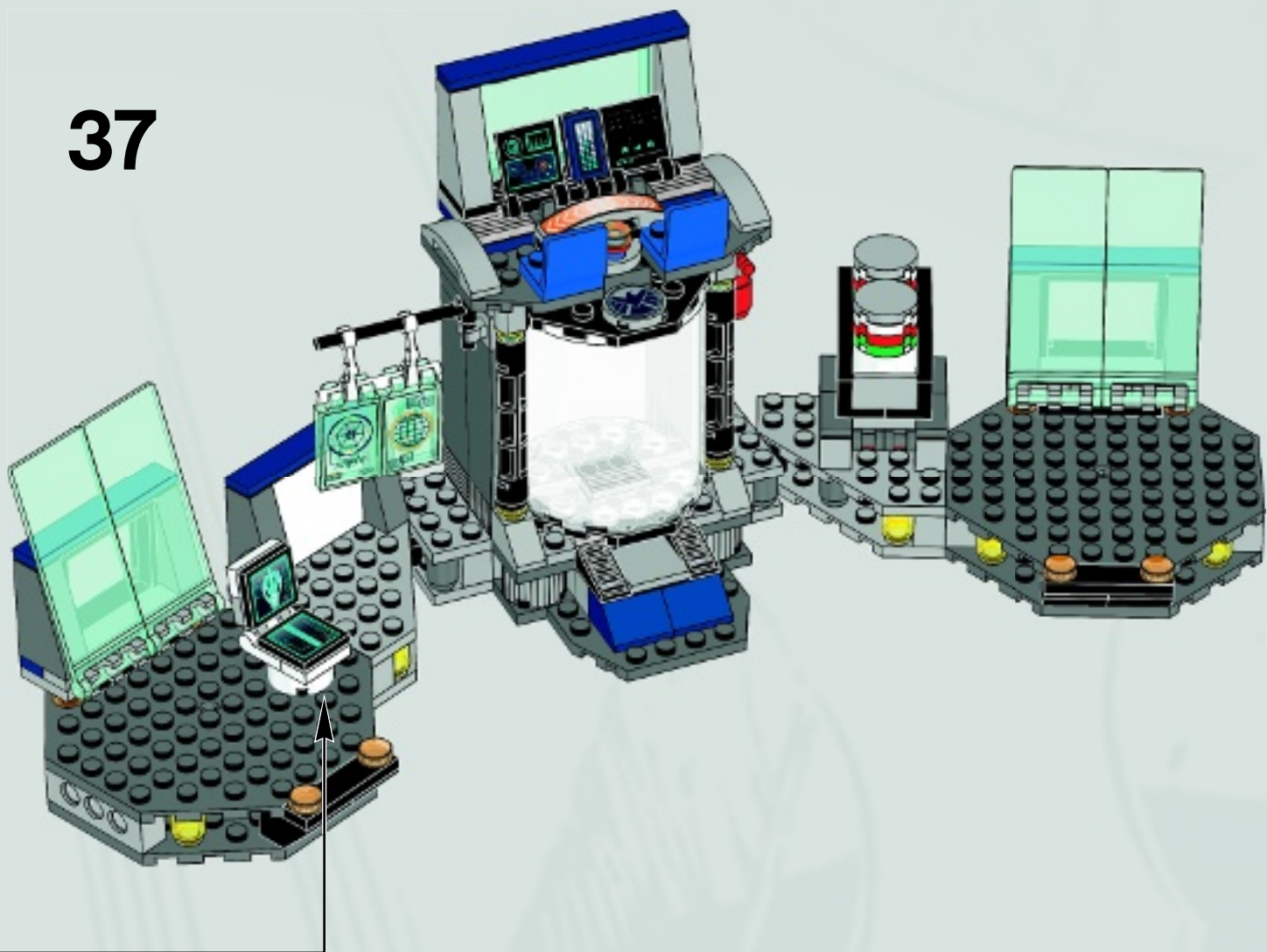



**1**

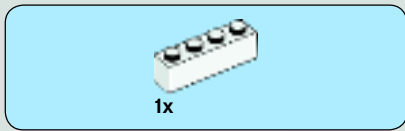

**2**

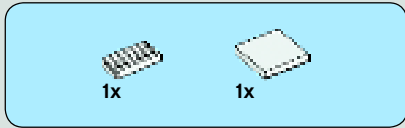

**3**





2x

4

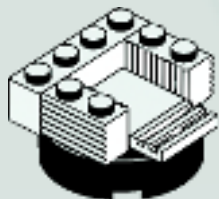

1x



1x



1x

5

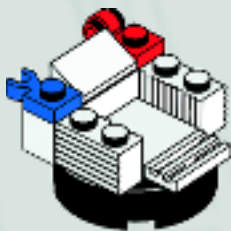

2x

6

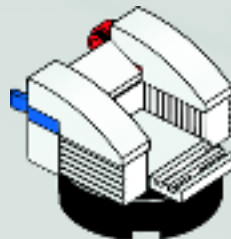

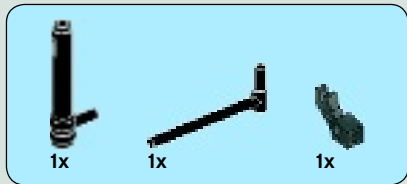

7

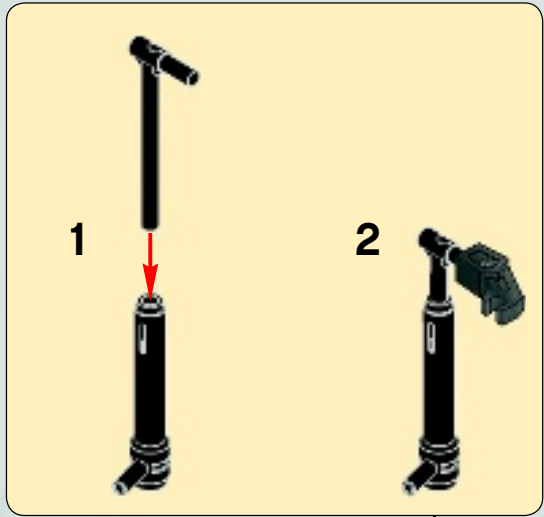

8

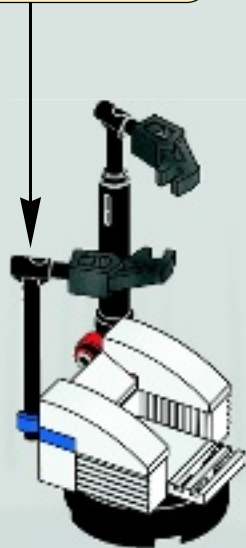

38

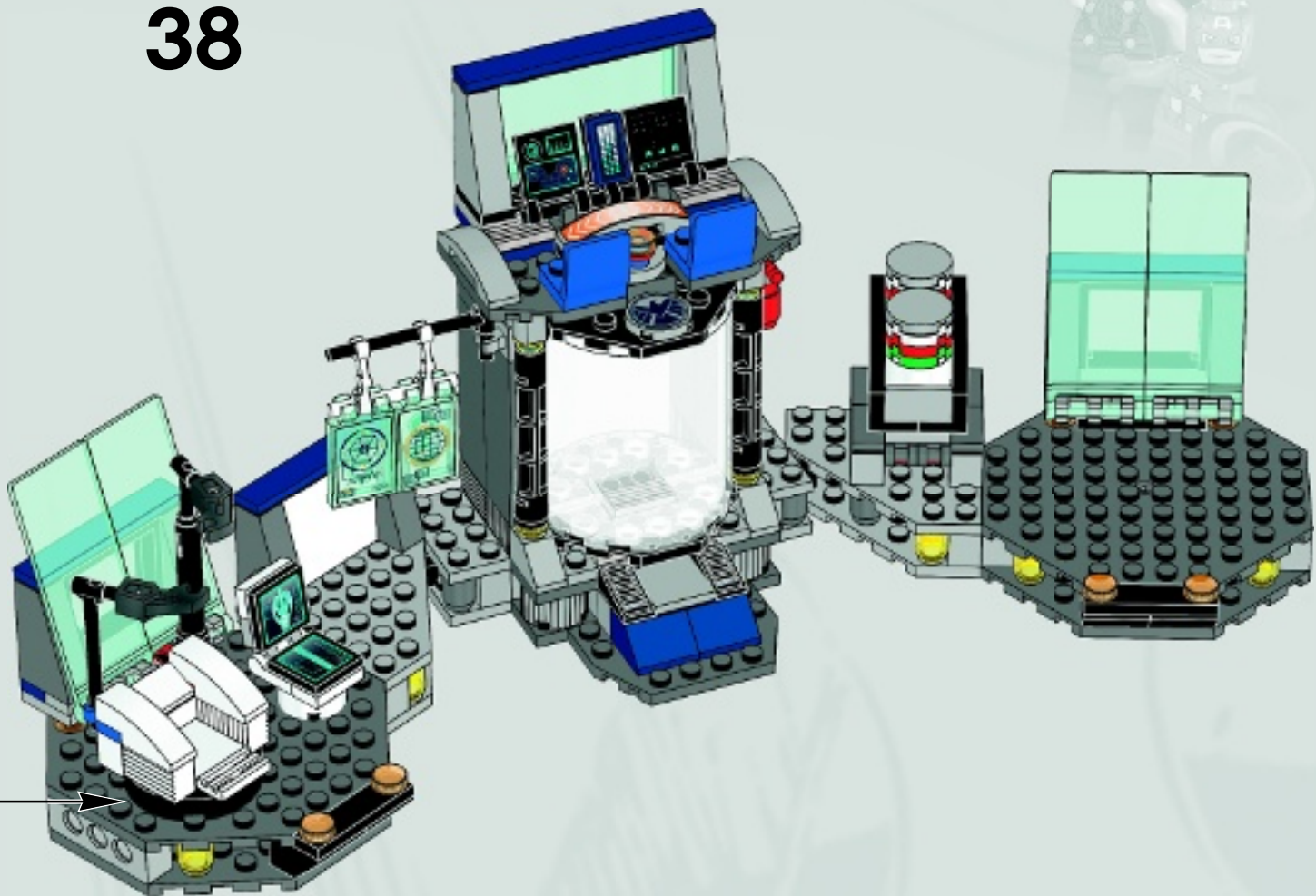

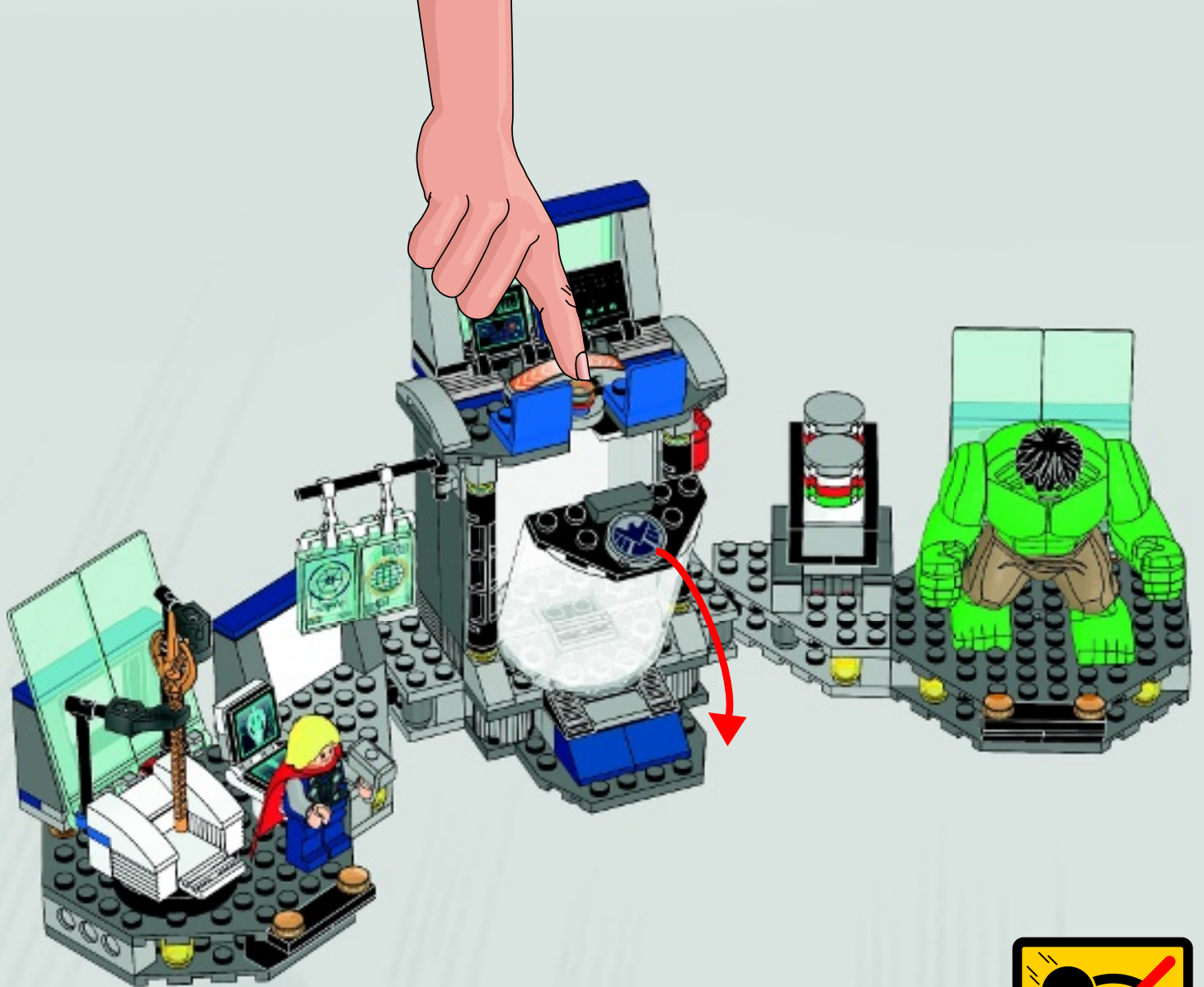

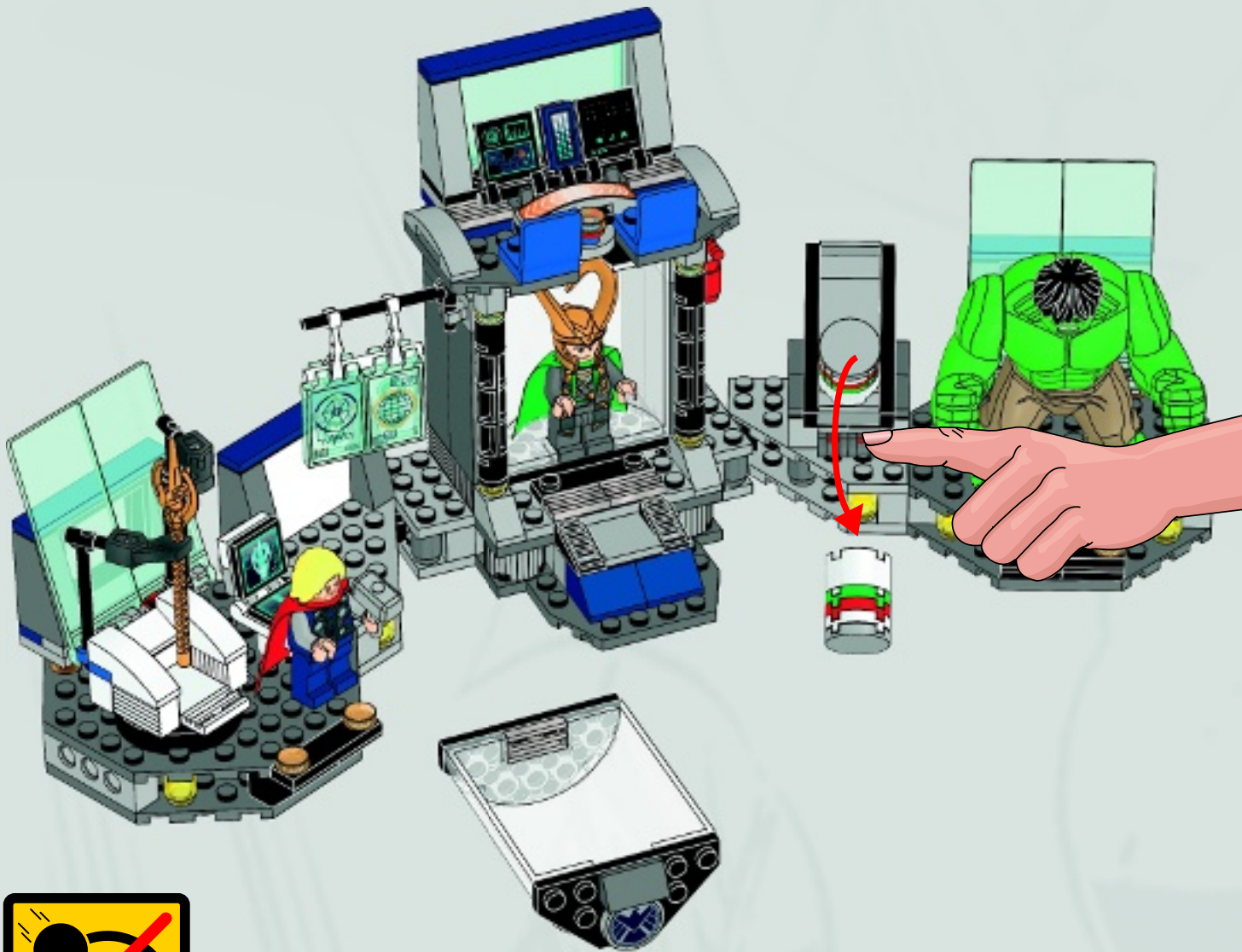

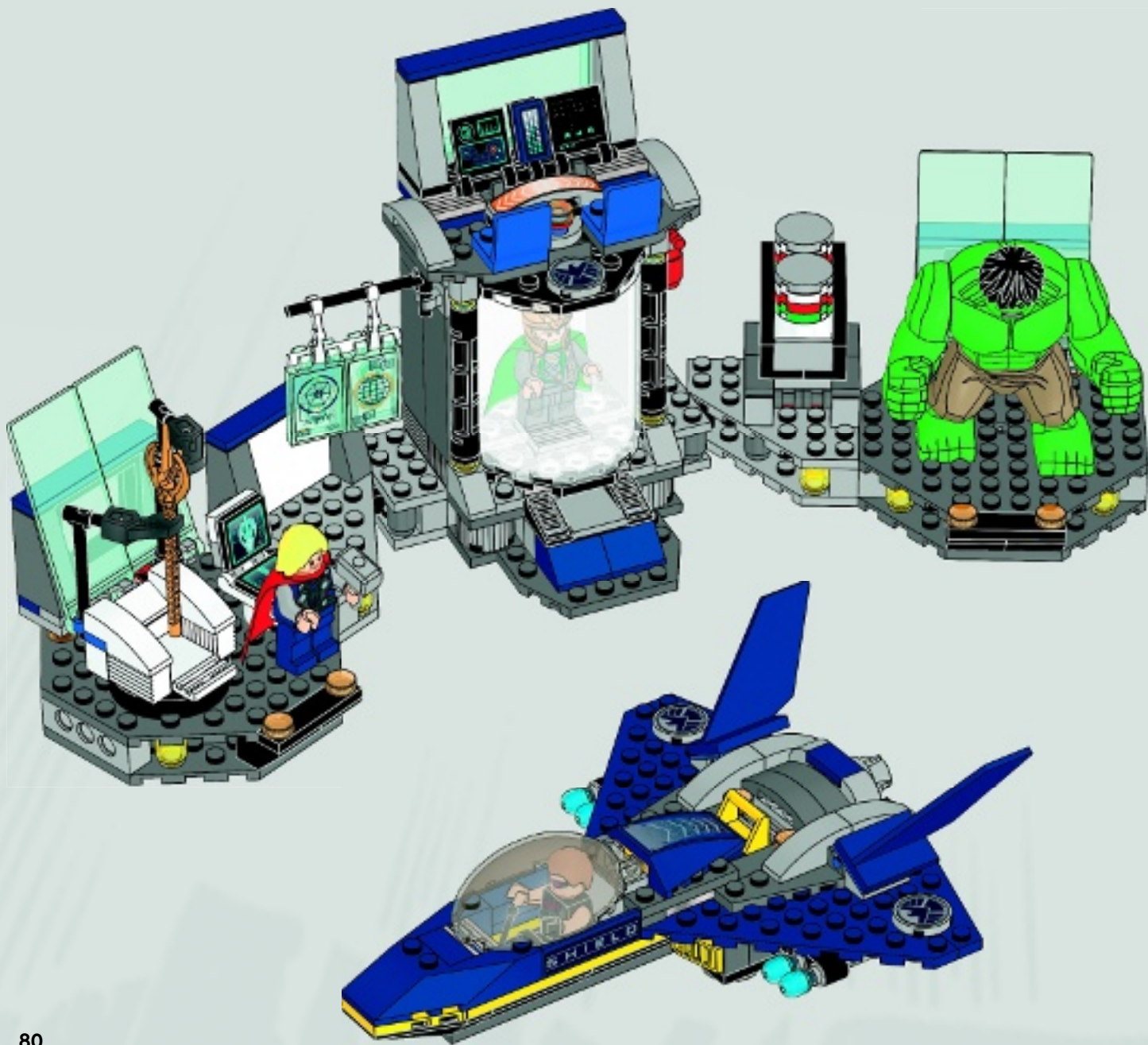



1x 301001  
2x 287701  
5x 614301  
1x 4547489  
2x 4249112  
2x 302301  
1x 241201  
1x 4222017  
1x 306801  
2x 403201  
1x 4558208  
1x 4129836  
2x 4260649  
1x 300421  
1x 306221

1x 4632572  
2x 281721  
2x 403221  
1x 459921  
1x 4143210  
1x 4544143  
2x 389423  
3x 302223  
1x 4613257  
2x 407923  
2x 4195007  
8x 4143005  
2x 4206482  
1x 300324  
2x 235724

1x 370024  
1x 302324  
2x 346024  
1x 244424  
1x 4649050  
1x 243224  
2x 4540384  
1x 4558957  
2x 366526  
4x 366026  
2x 4658977  
1x 4550004

9x 4599499  
2x 4541191  
1x 4535739  
2x 306826  
4x 241926  
2x 4530589  
2x 658326  
2x 6011815  
3x 4623113  
1x 303426  
1x 303626

1x 6004895  
1x 6005447  
1x 6004944  
1x 4569407  
2x 6011458  
2x 383126  
2x 4155558  
2x 4142135  
1x 4184169  
11x 4121715  
1x 4640742  
2x 403228  
1x 4636676

1x 6016965  
1x 6005101  
1x 6005102  
1x 6005099  
1x 6005100  
4x 4497952  
2x 4603191  
4x 4508534  
1x 4546691  
2x 6003198

10x 3006844  
4x 3005744  
1x 4621774  
2x 4153653  
1x 6003092  
1x 4226924  
3x 4530028  
2x 4508313  
3x 4528488  
1x 4569836  
3x 4252437  
1x 4654448



1x  
6004896



1x  
4162916



2x  
6003091



1x  
4651373



1x  
4651377



2x  
4647626

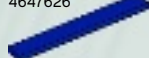

1x  
4507080



2x  
6003093



**Customer Service**

**Kundenservice**

**Service Consommateurs**

**Servicio Al Consumidor**

**LEGO.com/service or dial**



**00800 5346 5555 :**



**1-800-422-5346 :**



11x  
4646865



2x  
4533772



4x  
4211383



4x  
4211833



4x  
4650645



14x  
4211441



2x  
4211614



3x  
4568637



2x  
4211494



2x  
4211519



1x  
4211442



4x  
4251163



3x  
4622803



2x  
4211397



4x  
4211395



6x  
4211452



5x  
4211480



2x  
4598526



7x  
4556157



4x  
4211413



1x  
4211419



2x  
4211356



4x  
4211525



2x  
4211475



1x  
4278273



4x  
4211520



2x  
4211515



1x  
4221775



1x  
6004729



4x  
4520320



4x  
4211807



1x  
4278756



4x  
4211075



4x  
4211104



1x  
4211100



2x  
4210697



4x  
4211090



2x  
4210762



1x  
4567887



6x  
4221745



2x  
4648256



4x  
4210779



3x  
4598769



2x  
4211065

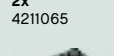

1x  
4243831



1x  
4210782



1x  
4210788



1x  
4210788



2x  
4210794



1x  
4211067



4x  
4583688



1x  
6005446



2x  
4211069



2x  
4211052



2x  
4521187



1x  
4560184



4x  
4278274



3x  
4521572



1x  
6004894



2x  
4211066



1x  
6004439



1x  
4662141



1x  
6003614



1x  
6003616



1x  
6008348



1x  
4610762



1x  
4646866



1x  
6005435



10x  
4619636



2x  
6008484

**MARVEL**



www.LEGOclub.com/marvel

**FREE\*!**  
**GRATIS!**  
**GRATUIT !**

\*Paid subscription in Australia and New Zealand

\*Abonnement payant en Australie et Nouvelle-Zélande



**club**

LEGO and the LEGO logo are trademarks of the/sont des marques de commerce de/son marcas registradas de LEGO Group. ©2012 The LEGO Group. TM & © 2012 Marvel & Subs.



# WIN!

Go to [www.LEGOsurvey.com/product](http://www.LEGOsurvey.com/product) to fill out a survey for a chance to win a cool LEGO® Product.

No purchase necessary.

Open to all residents where not prohibited.



LEGO.com



## [www.LEGOsurvey.com/product](http://www.LEGOsurvey.com/product)

### GEWINNE! WIN!

Nimm an der Umfrage auf [www.LEGOsurvey.com/product](http://www.LEGOsurvey.com/product) teil und hab die Chance ein cooles LEGO® Produkt zu gewinnen!

Die Teilnahme am Gewinnspiel führt zu keinerlei Kaufverpflichtungen. Teilnahme in allen nicht ausgeschlossenen Ländern möglich.

Ga naar [www.LEGOsurvey.com/product](http://www.LEGOsurvey.com/product), vul een enquêteformulier in en maak kans op een cool LEGO® product.

Geen aankoopverplichting. Iedereen mag deelnemen, uitgezonderd ingezetenden van landen waar een enquêteverbod geldt.

### GAGNE! 当てよう!

Visite [www.LEGOsurvey.com/product](http://www.LEGOsurvey.com/product) pour répondre à un questionnaire et avoir une chance de gagner un produit LEGO® très cool!

Aucune obligation d'achat. Ouvert à tous les résidents des pays autorisés.

[www.LEGOsurvey.com/product](http://www.LEGOsurvey.com/product) にアクセスしアンケートにご記入ください。当選者には1製品を差し上げます。

お買い上げの必要はありません。

禁止されていない限り、すべての皆様にご利用いただけます。



[www.marvel.com](http://www.marvel.com)

TM & © 2012 Marvel & Subs.

LEGO and the LEGO logo are trademarks of the/sont des marques de commerce de/son marcas registradas de LEGO Group. ©2012 The LEGO Group.

6046992 / 6046993