



40059



6043507

- | | | | | | |
|------------|------------|------------|------------|------------|------------|
| 2x 300521 | 2x 4209159 | 2x 4504378 | 2x 4113917 | 1x 9342 | 1x 4275872 |
| 1x 4157223 | 1x 4140303 | 1x 4521512 | 2x 4520947 | 2x 302323 | 1x 4540429 |
| 2x 4504379 | 1x 396226 | 1x 4218642 | 1x 306928 | 2x 379423 | 1x 4504369 |
| 2x 365921 | 1x 4289538 | 1x 4211740 | 1x 4522673 | 2x 4523159 | 1x 302401 |
| 2x 371021 | 2x 4210700 | 3x 4211242 | 2x 4109679 | 2x 302424 | 2x 302301 |
| 1x 4140585 | 1x 4211069 | 2x 4211190 | 2x 4142717 | 1x 4651441 | 1x 4119410 |
| 1x 4617549 | 2x 4210998 | 1x 4205469 | 2x 302428 | 1x 4200908 | 3x 614101 |
| 1x 4550797 | 1x 303221 | 1x 4205470 | 1x 379428 | 2x 302426 | 1x 613201 |
| | | | 2x 4107736 | 1x 614126 | |

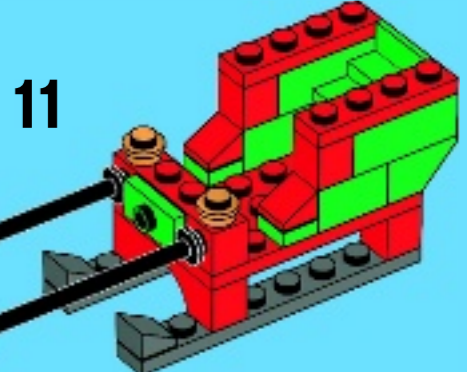
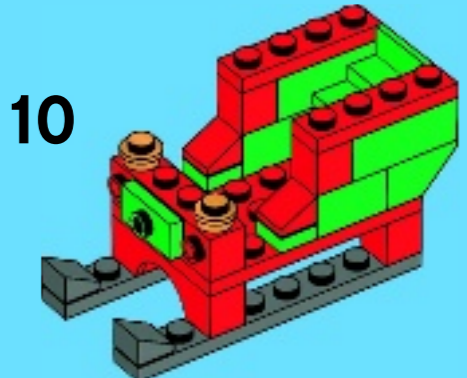
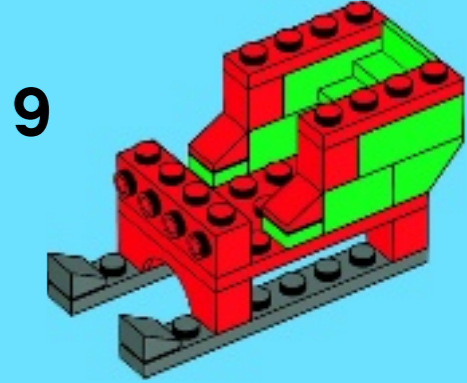
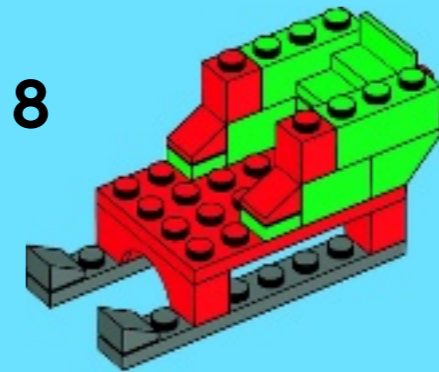
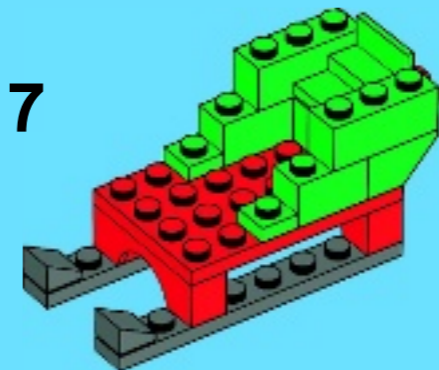
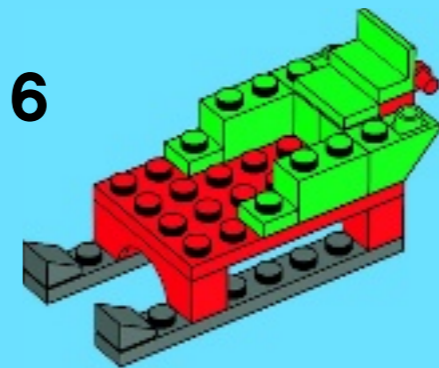
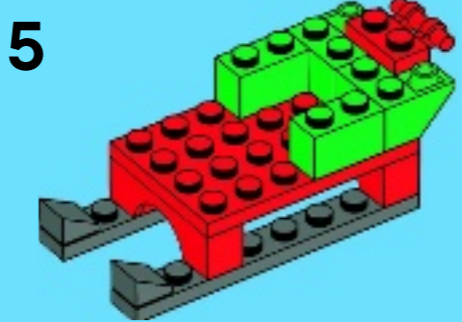
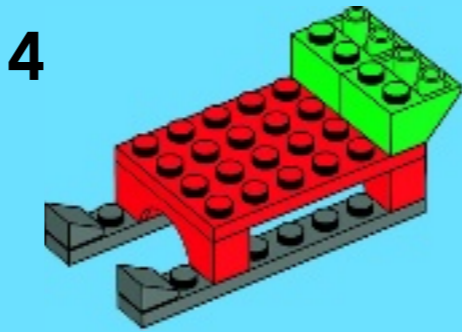
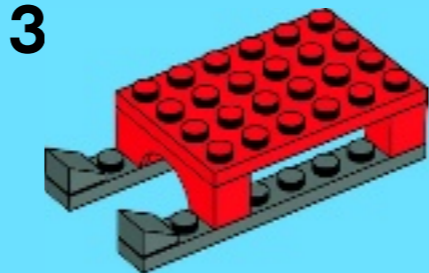
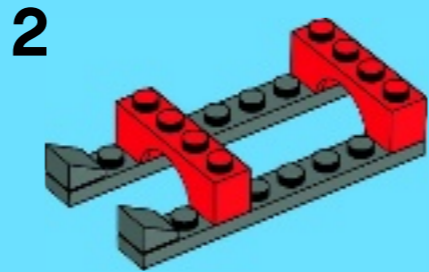
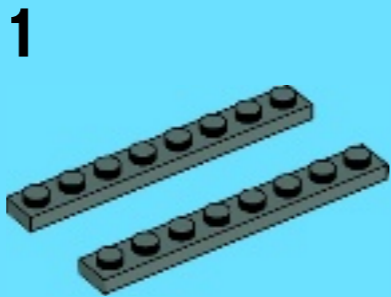
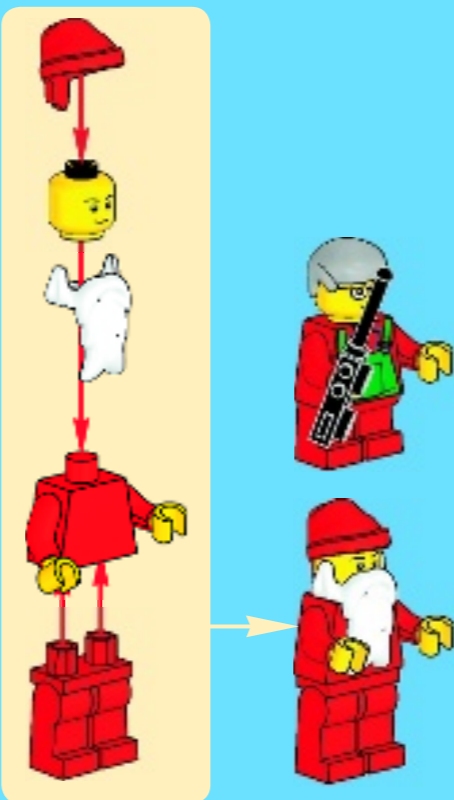

12

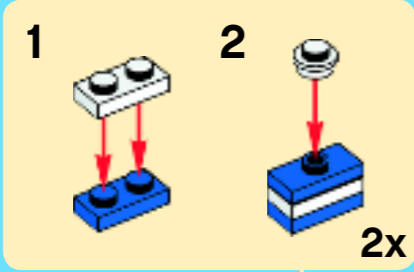
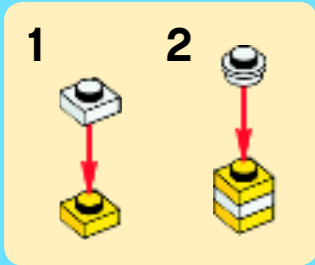
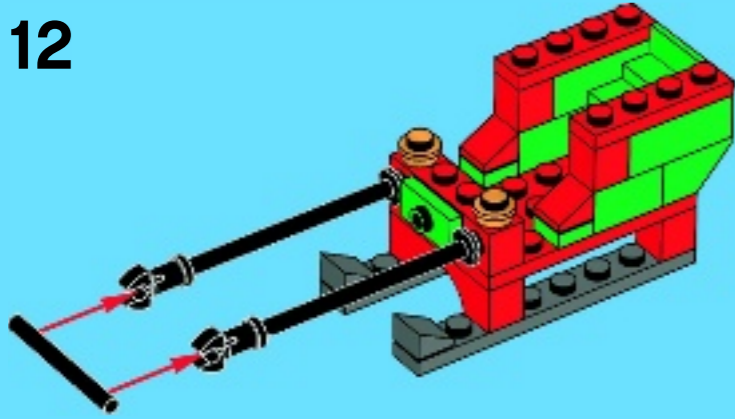

13

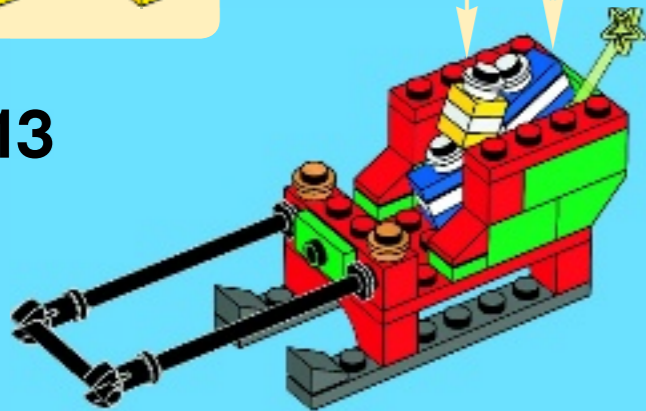

1

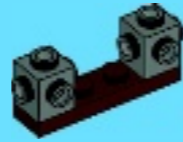

2

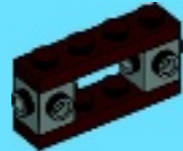

3



4



5

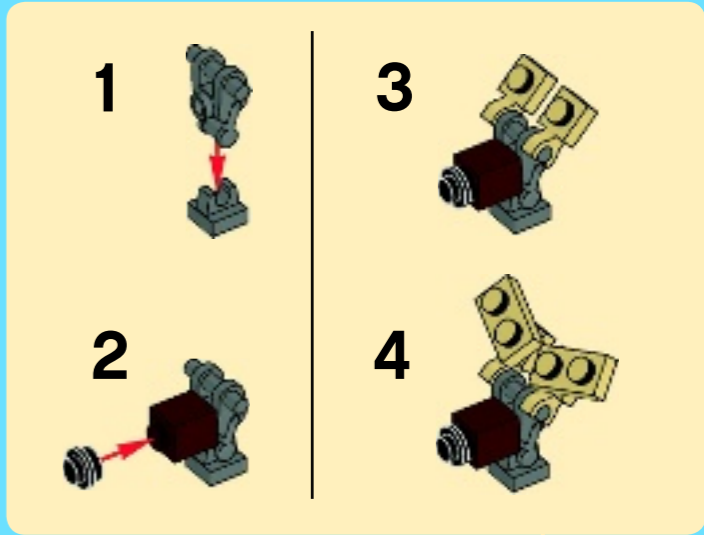
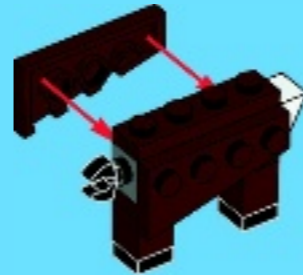

6

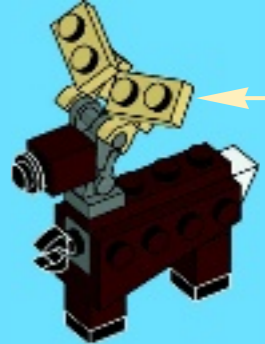

14

