

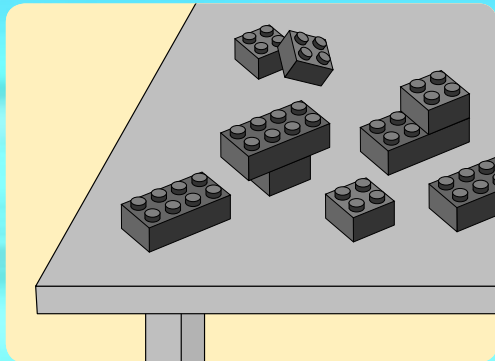

60007

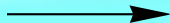

1

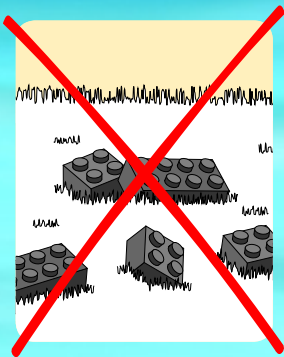

2

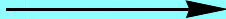

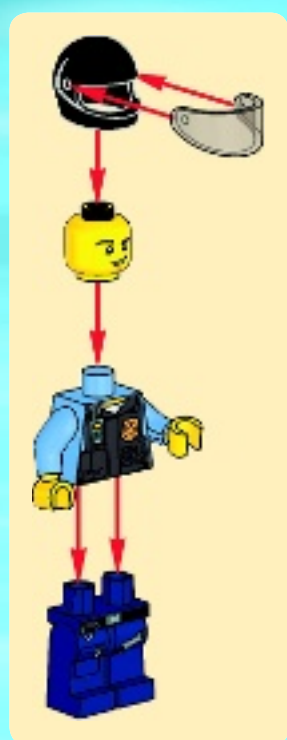

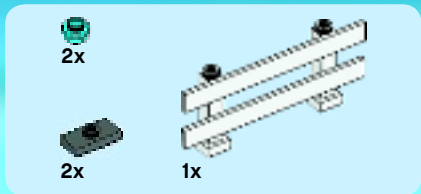

1

1

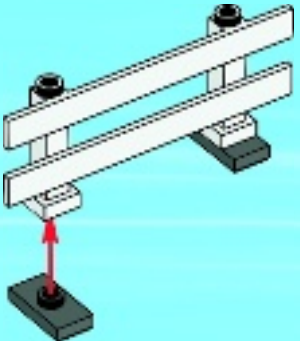

2

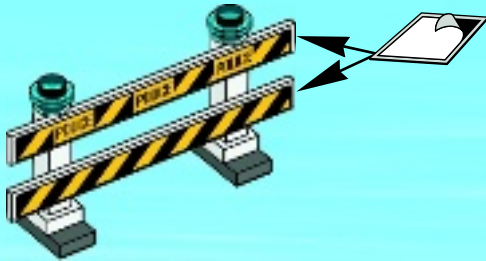



2x



1x

1





2x



2x

2



1x

3





2x



1x

4

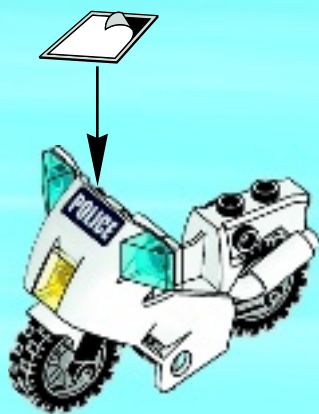

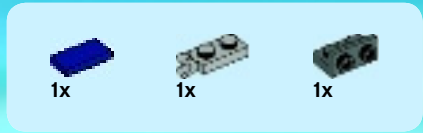

5

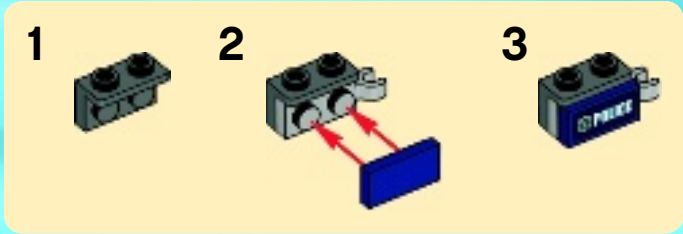





1x



1x



1x

# 6

1



2

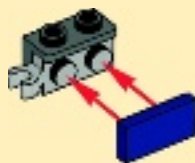

3





1x

7



1x



1x



1x



1x

8





1x



1x

9

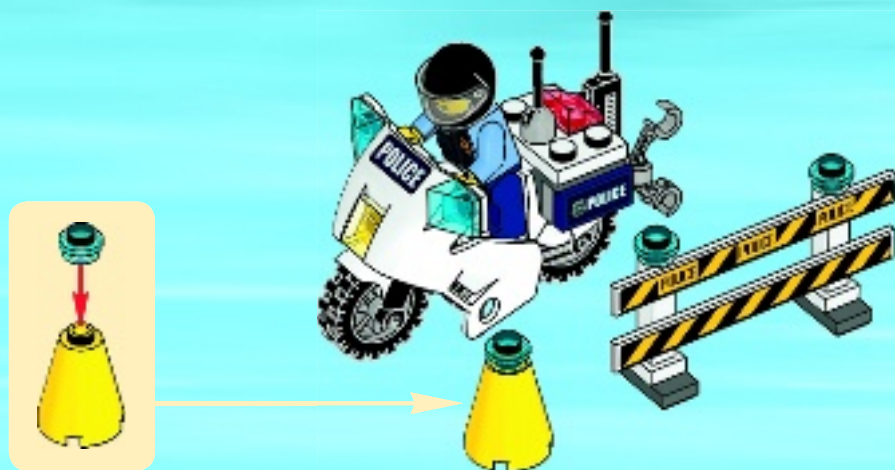



CITY



6008



6007



6006



CITY



60004



60003





























































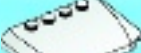









60002



60001



60000

 2x 301001	 2x 4222017	 2x 4599983	 1x 379521	 1x 4220515	 2x 243224	 4x 302126	 1x 663626
 6x 366501	 1x 663601	 4x 4504379	 5x 241221	 1x 4597912	 1x 74156	 2x 371026	 1x 486526
 2x 4515359	 1x 4541808	 2x 4651524	 4x 4612575	 3x 302223	 1x 6021844	 1x 302026	 1x 243226
 1x 302101	 1x 4541808	 2x 428621	 2x 4533742	 1x 4282744	 1x 6021851	 1x 366626	 1x 658326
 2x 371001	 4x 4170457	 2x 4259678	 1x 4113858	 1x 300424	 1x 6021614	 2x 379526	 1x 9339
 2x 366601	 4x 4646576	 2x 4571075	 2x 4565431	 2x 300124	 2x 9553	 2x 307026	 1x 4298619
 1x 379501	 1x 4261565	 4x 302321	 2x 4190219	 1x 6022159	 4x 4121966	 2x 306926	 2x 396226
 1x 6030476	 1x 4579412	 2x 371021	 1x 389921	 1x 407924	 1x 4548180	 1x 4225201	 2x 396226
		 3x 302021	 4x 4294734		 3x 302326	 2x 4535739	 4x 4568644



4x  
4550937



2x  
4244953



1x  
4530673



2x  
4541191



4x  
371028



3x  
4295260



1x  
4244363



2x  
4201019



2x  
4189801



2x  
4640026



1x  
6051432



1x  
6051437



2x  
4244366



3x  
4113854



3x  
3005743



3x  
4260942



4x  
3005744



2x  
6018507



1x  
4163306



1x  
6003573



4x  
4255413



4x  
4264569



5x  
4502089



3x  
4508313



2x  
4528488



2x  
6018588



1x  
6018438

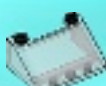

1x  
4496442



4x  
4542673



4x  
4558953



1x  
4211636



2x  
4211676



1x  
4599498



2x  
4211568



2x  
4211486



2x  
4535738



1x  
4221775



2x  
4641048



4x  
4299119



2x  
4590443



4x  
6018081



12x  
6005669



2x  
4211508



2x  
4211508



2x  
4211508



2x  
4211508



2x  
4211508



2x  
4211508



2x  
4210636



4x  
4211096



4x  
4211000



2x  
4211119



2x  
4211001



7x  
4211065



2x  
4211056



2x  
4211085



2x  
4211085



2x  
4211085



2x  
4211085



2x  
4211085



2x  
4211085



1x  
4211134

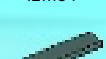

2x  
4211053



3x  
4210631



2x  
6000606



1x  
4509911



1x  
4509911



1x  
4509911



1x  
4509911



1x  
4509911



1x  
4509911



1x  
4509911



1x  
4509911



2x  
4210633



1x  
4210934



1x  
6018686



1x  
4528605



1x  
4528605



1x  
4528605



1x  
4528605



1x  
4528605



1x  
4528605



1x  
4528605



1x  
4528605



1x  
4528605



1x  
4528605



1x  
4528605



Customer Service  
Kundenservice  
Service Consommateurs  
Servicio Al Consumidor

LEGO.com/service or dial



: 00800 5346 5555

: 1-800-422-5346



3

[www.LEGOclub.com/Max](http://www.LEGOclub.com/Max)

**LEGO** club™

**FREE\*! GRATIS! GRATUIT!**

\*Paid subscription in Australia and New Zealand.

LEGO and the LEGO logo are trademarks of the LEGO Group. ©2013 The LEGO Group. 6052381







60007





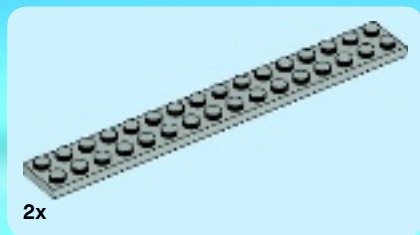

1

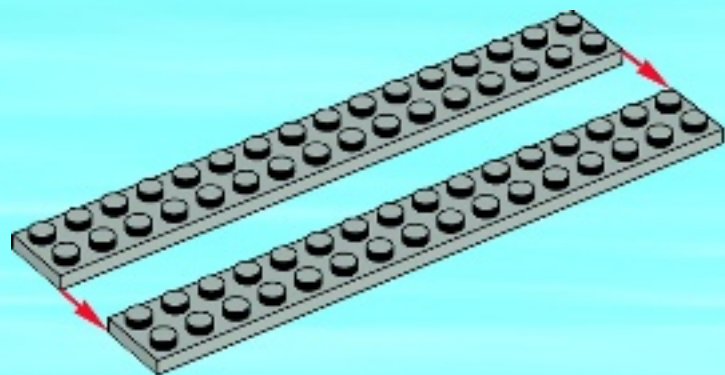



1x



2x

2

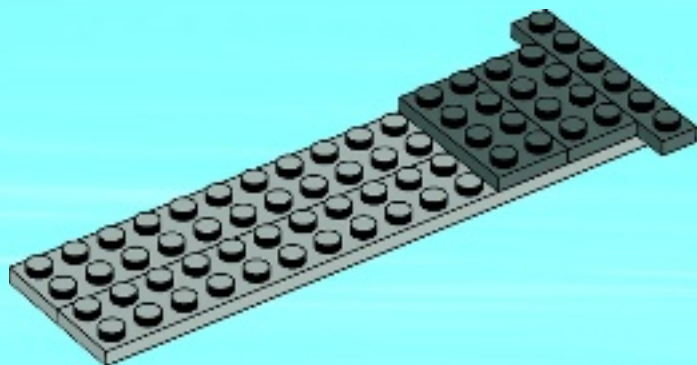

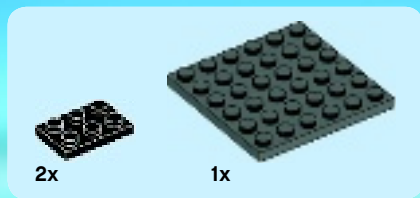

3

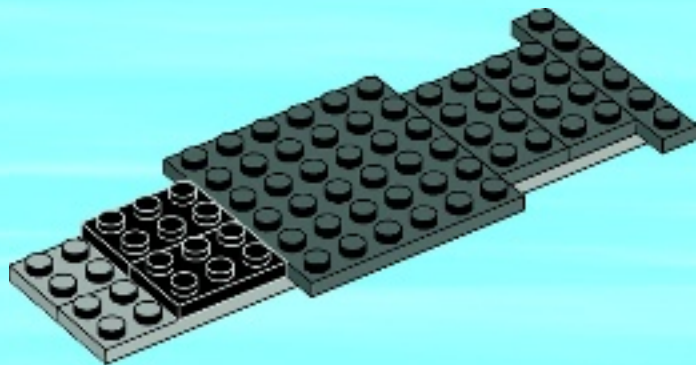



2x



1x

4

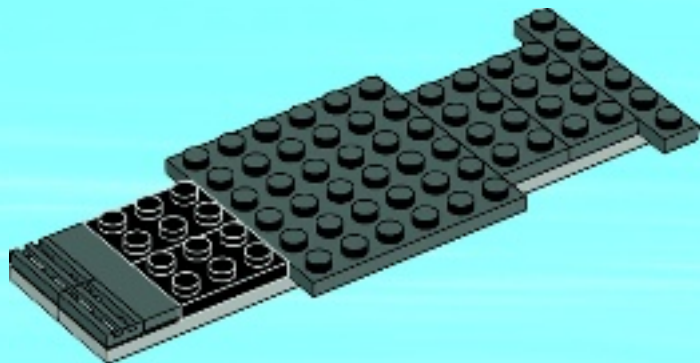

6



2x



1x

5

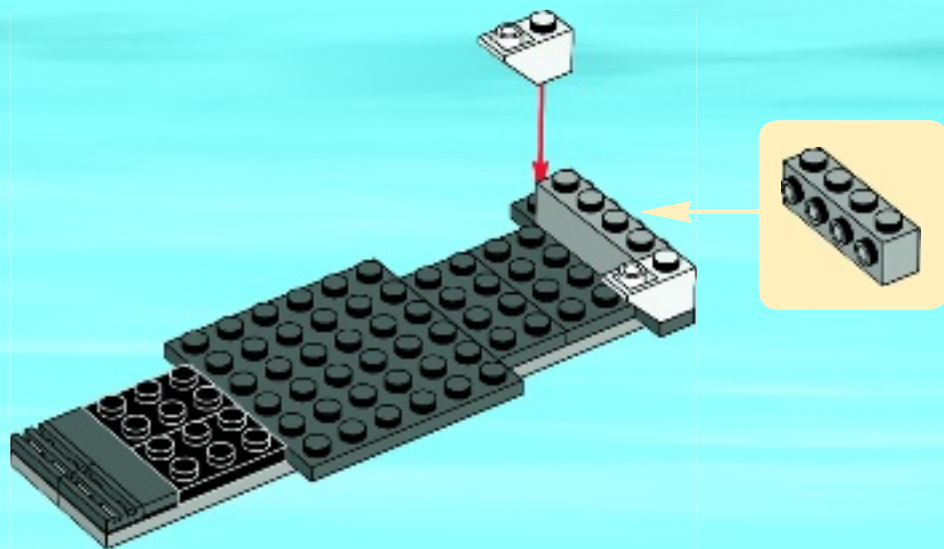



1x



2x



1x

# 6

1



2

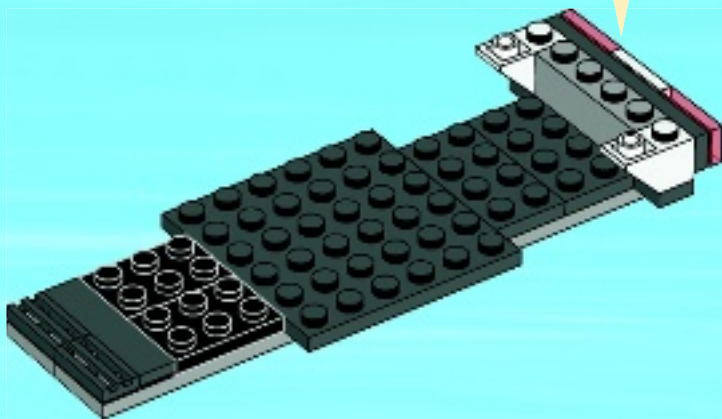





2x

7

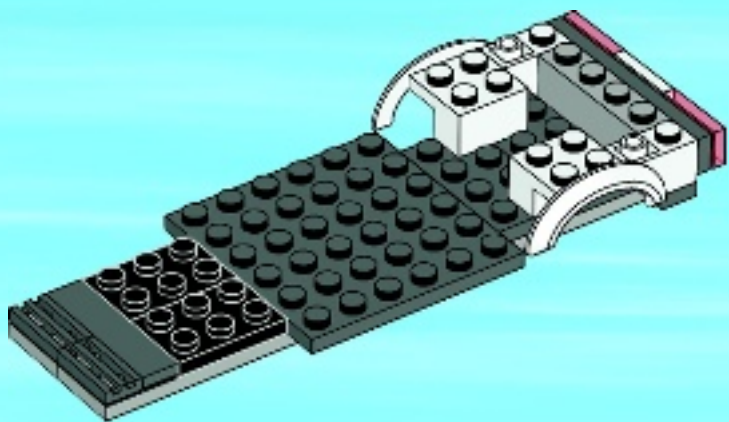



2x



1x

8

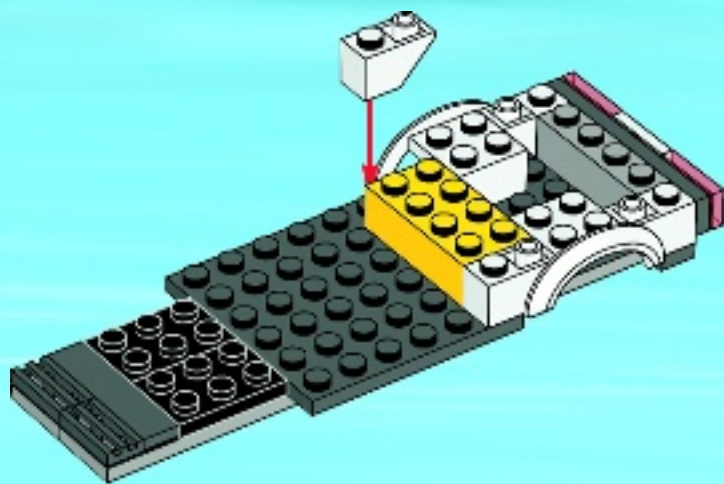



1x



2x



1x

9

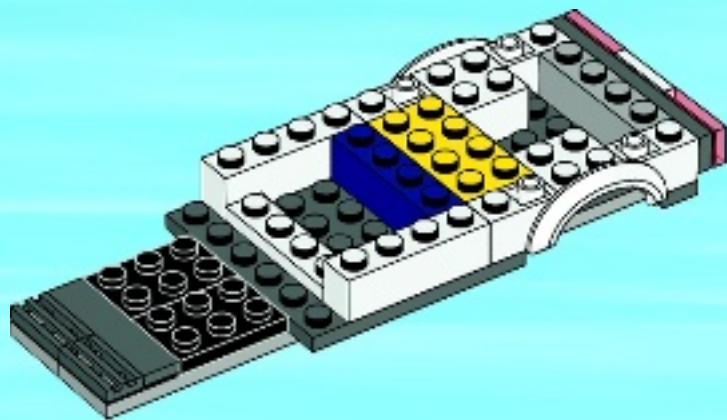



2x

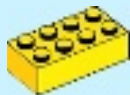

1x

# 10

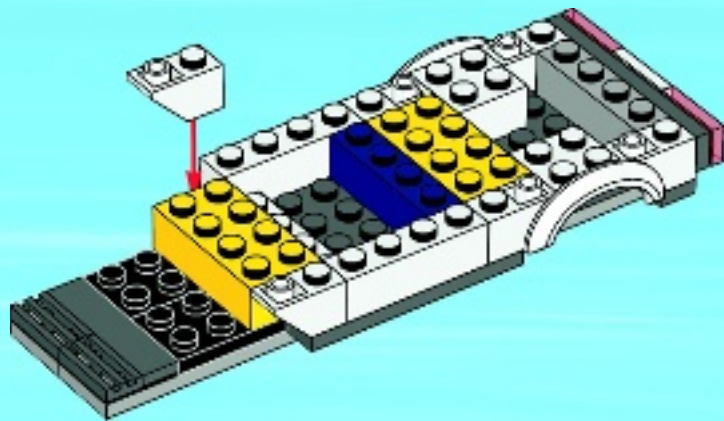



2x



1x

# 11

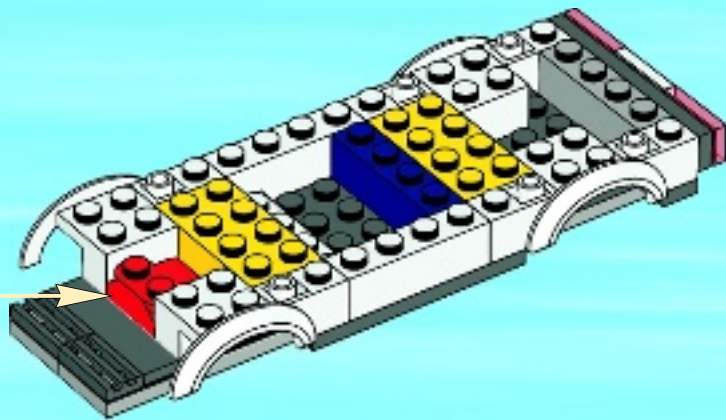

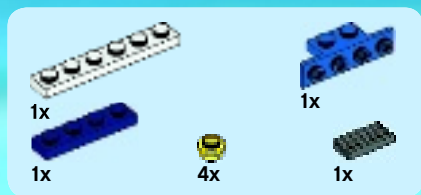

# 12

## 1

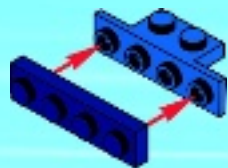

## 2

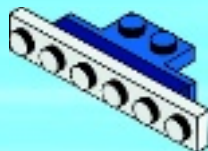

## 3



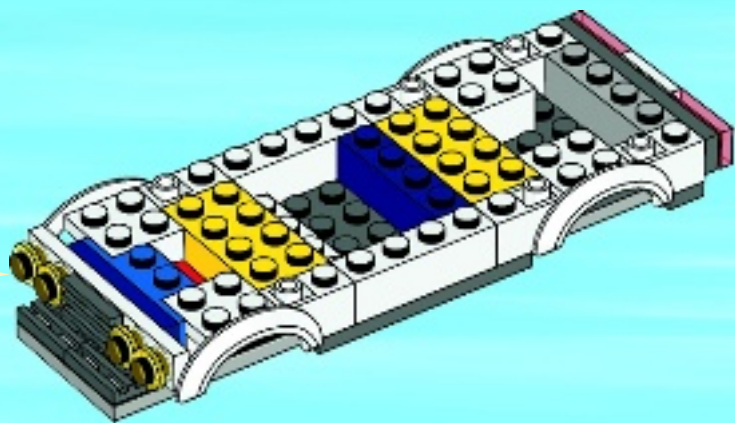



3x

# 13

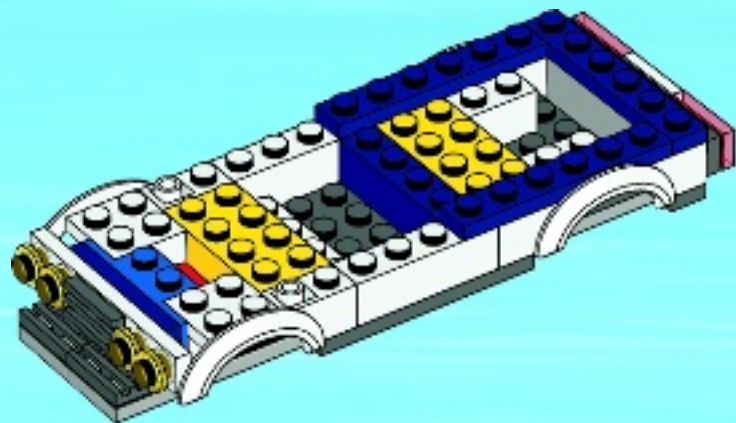





2x

14

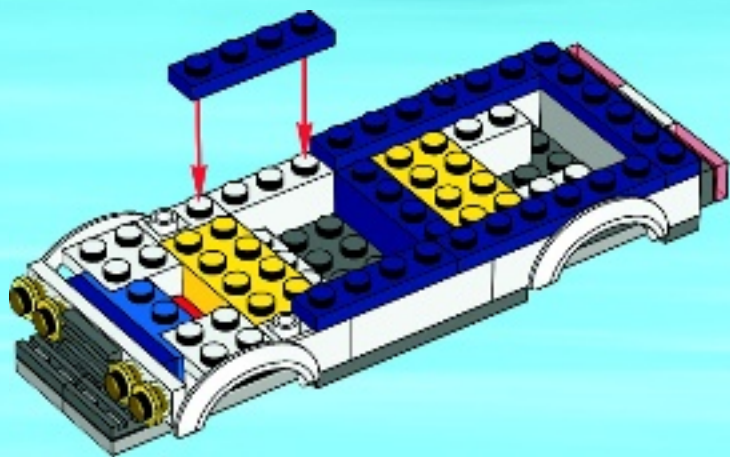



2x

15

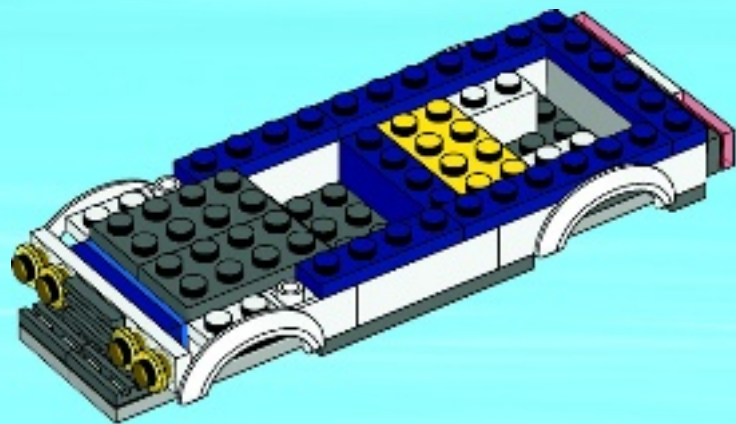



2x

# 16

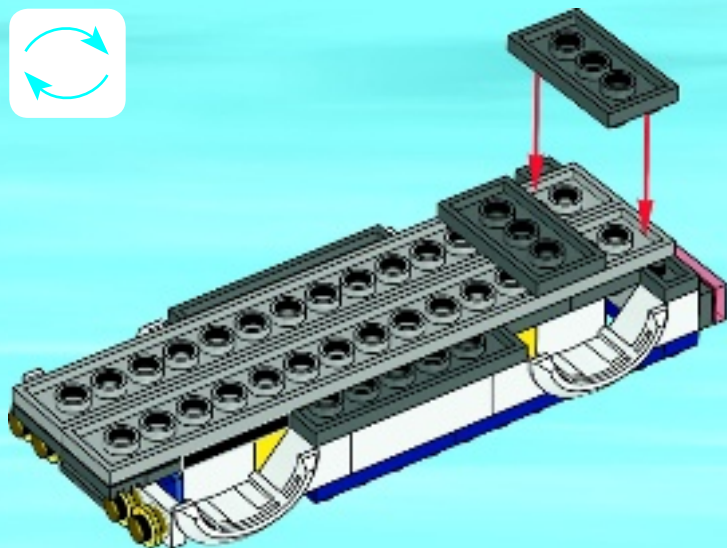



2x



1x

17

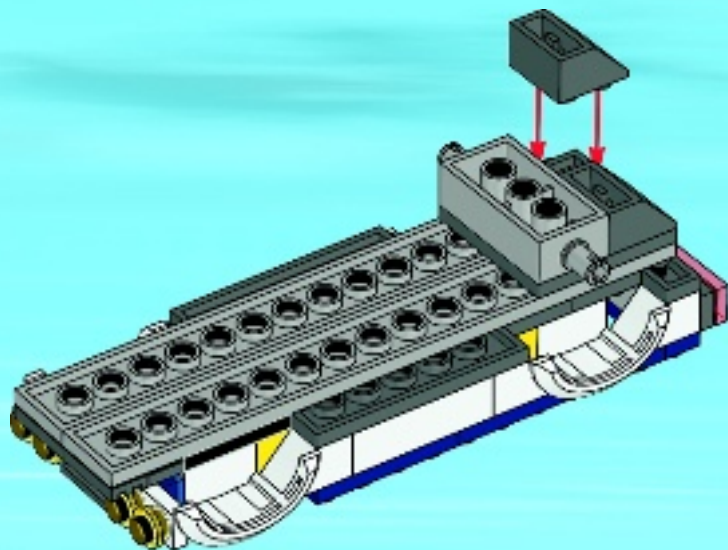



1x

18

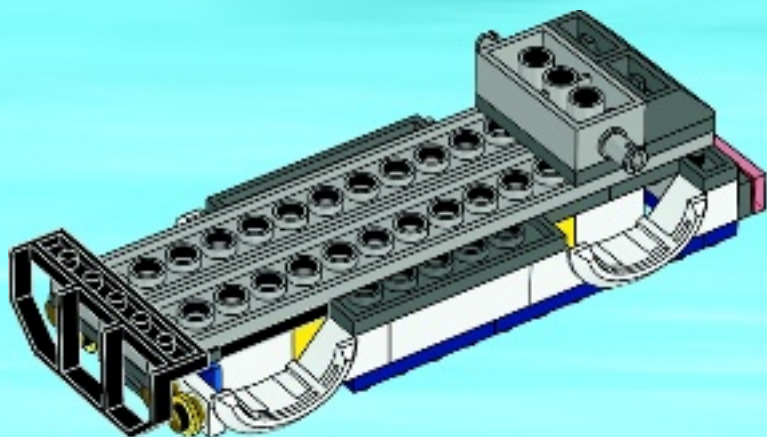



2x



2x



4x

# 19

1

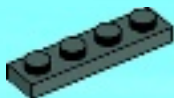

2

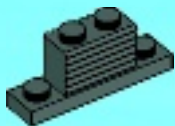

3

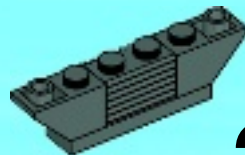

2x

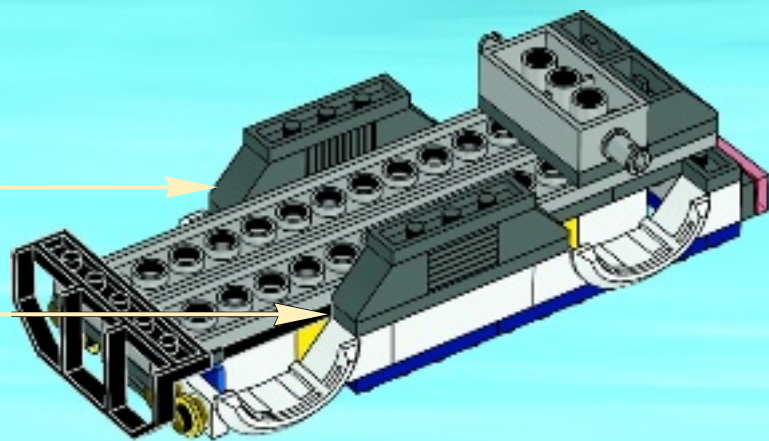



2x

20

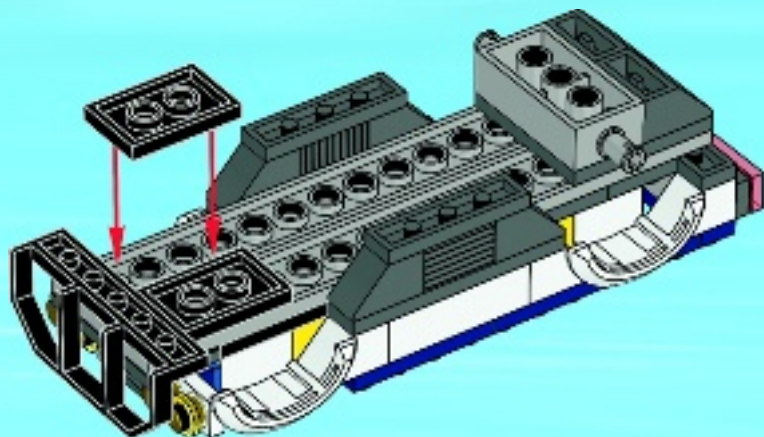





2x

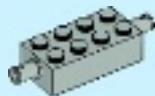

1x

# 21

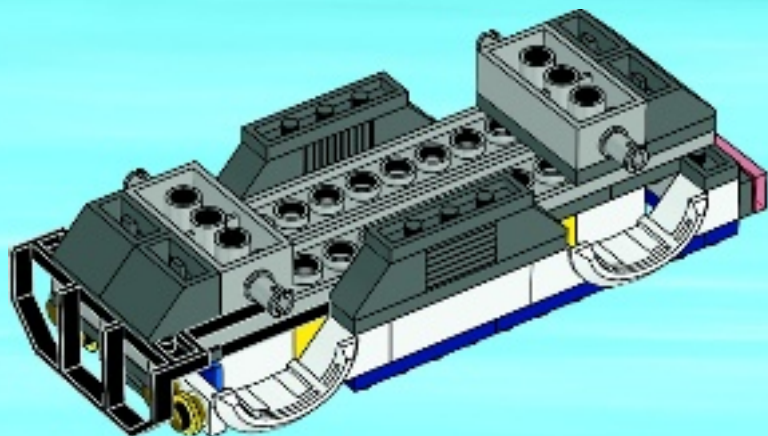



1x

22

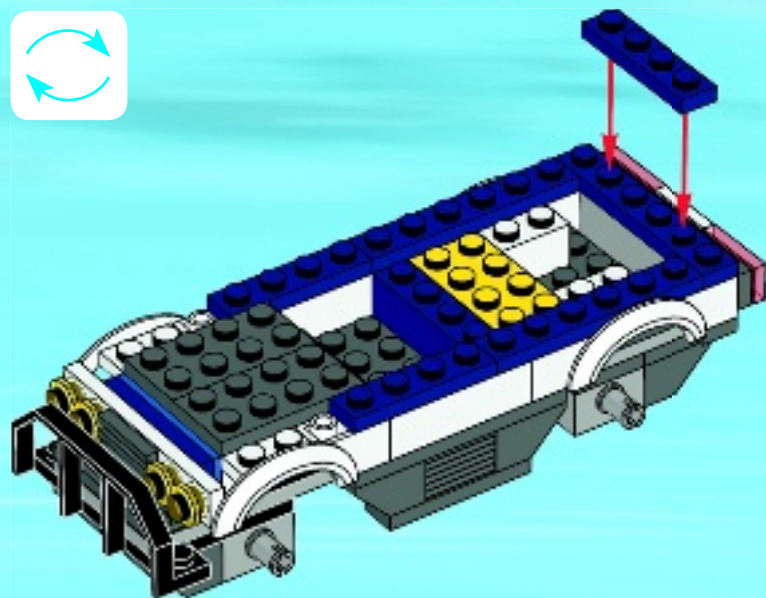



2x

23

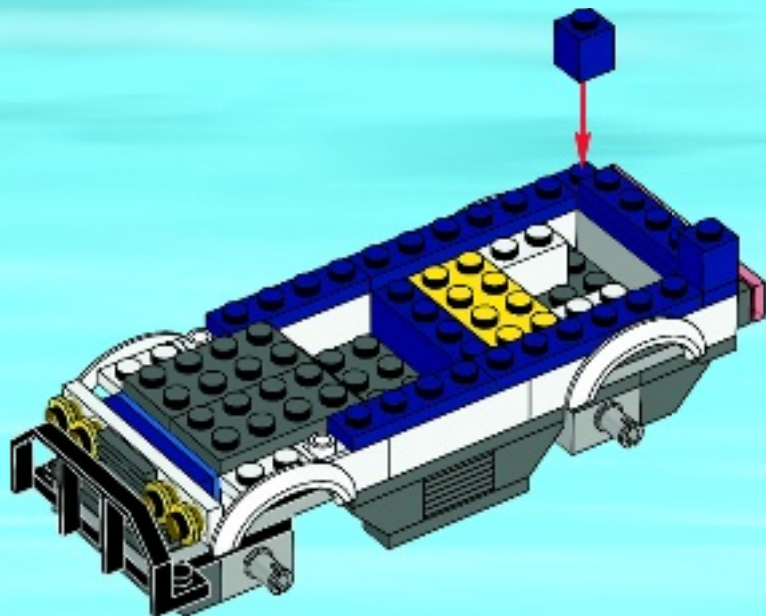

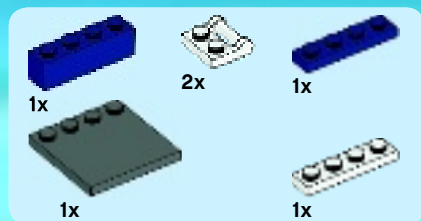

# 24

## 1

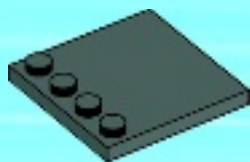

## 2

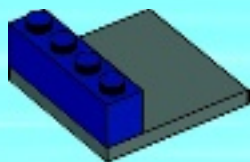

## 3

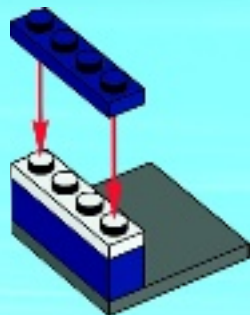

4

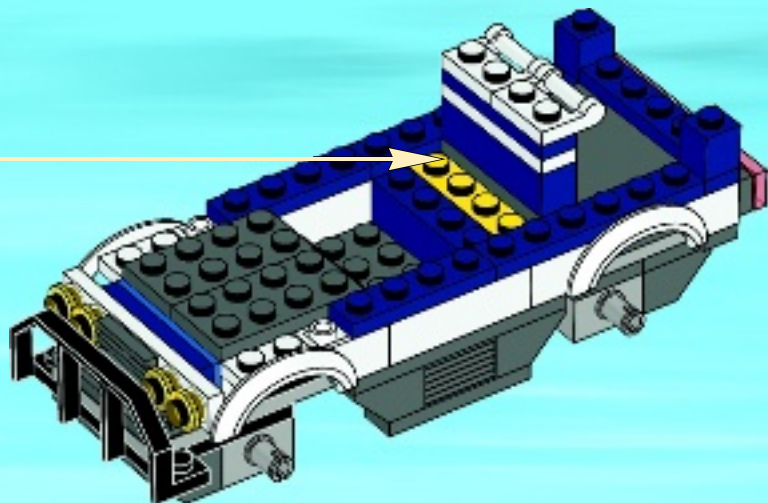



2x

25

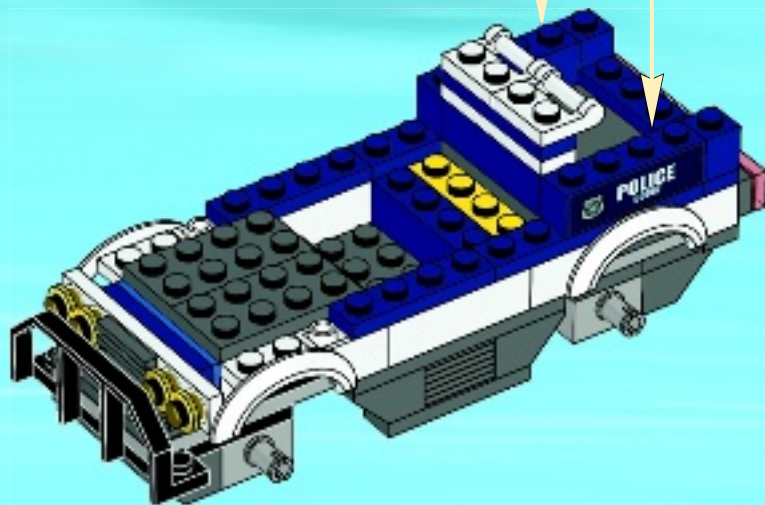



2x



2x

# 26

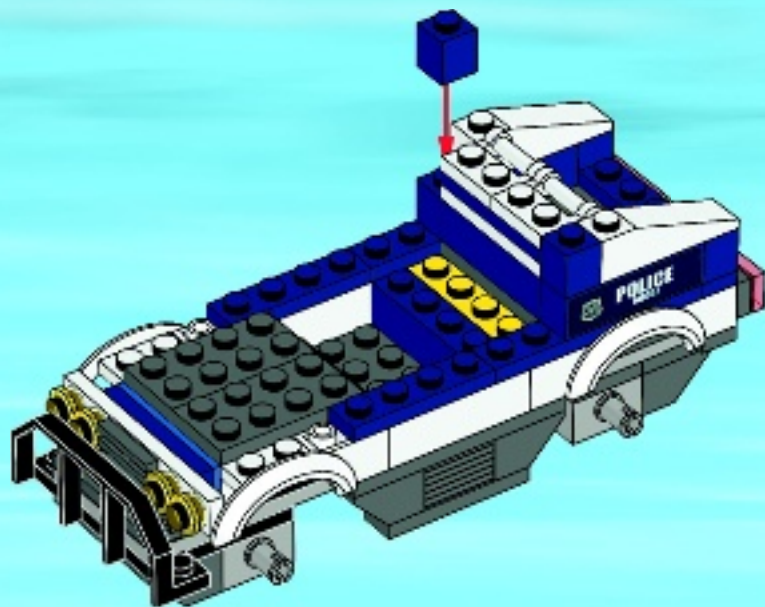



1x

27

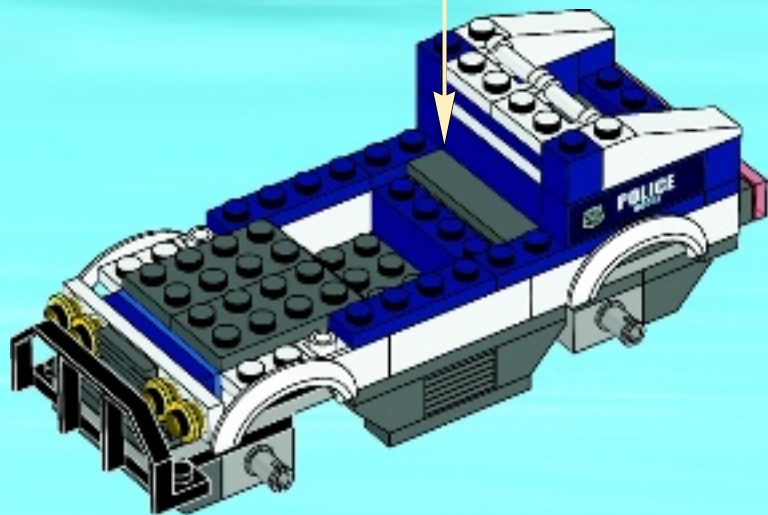
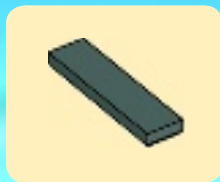





1x



1x



1x

# 28

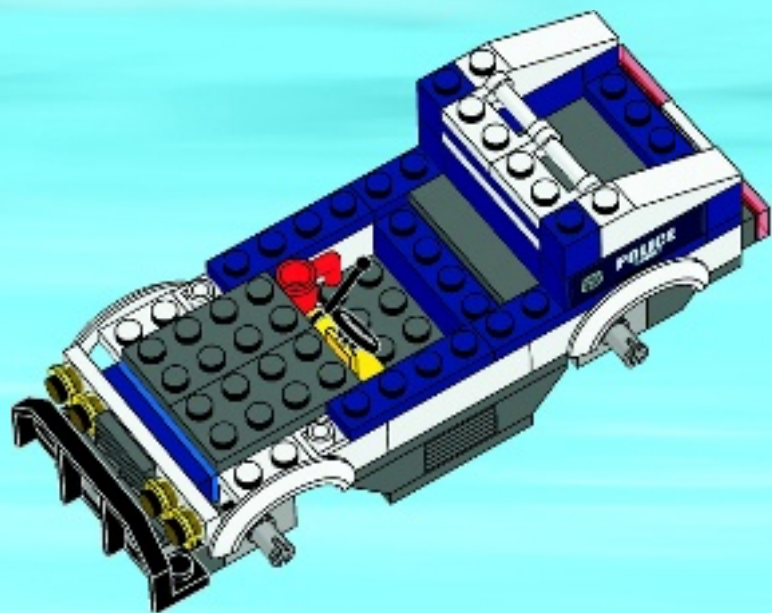



2x



2x

# 29

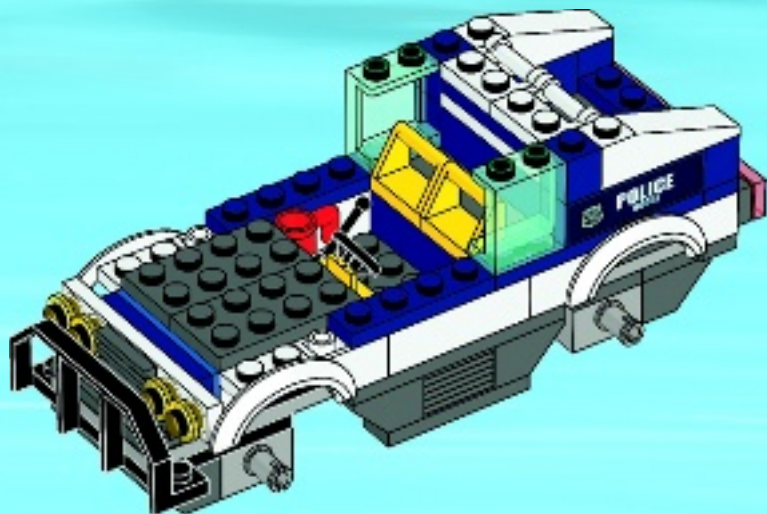



1x

# 30

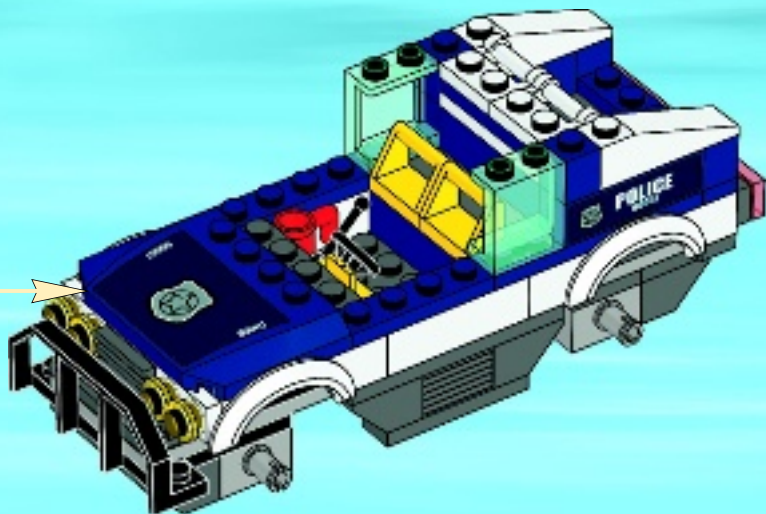

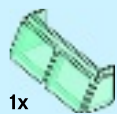

1x



1x

# 31

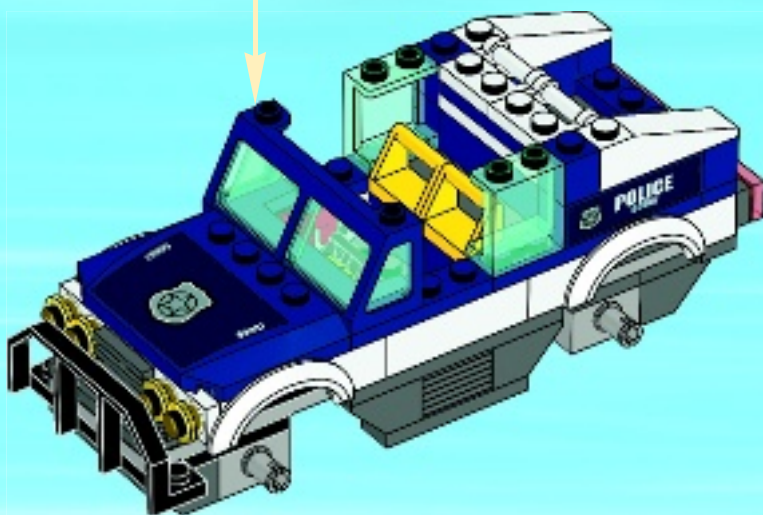
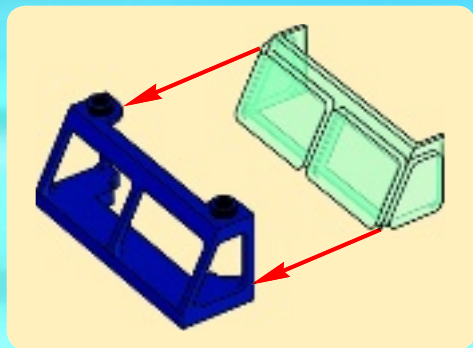



1x

32

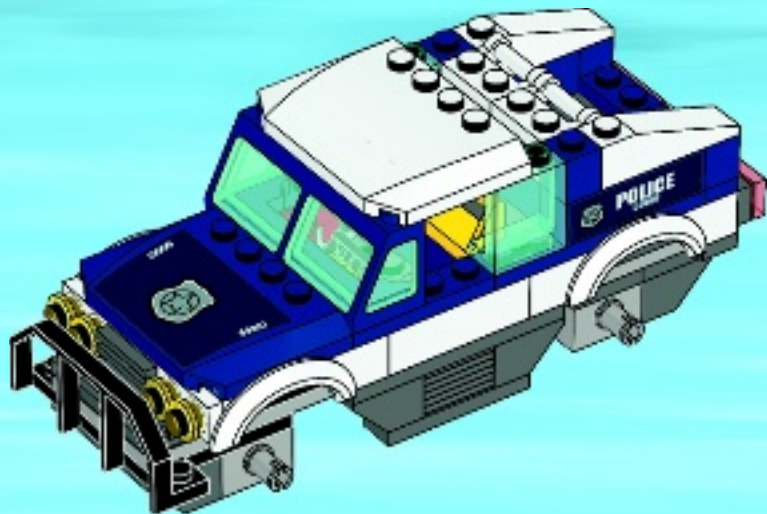

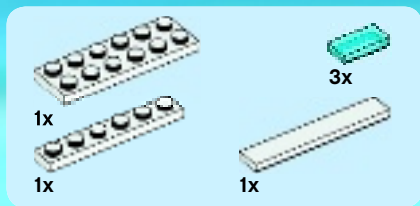

# 33

1



2



3

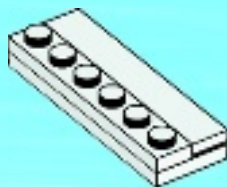

4

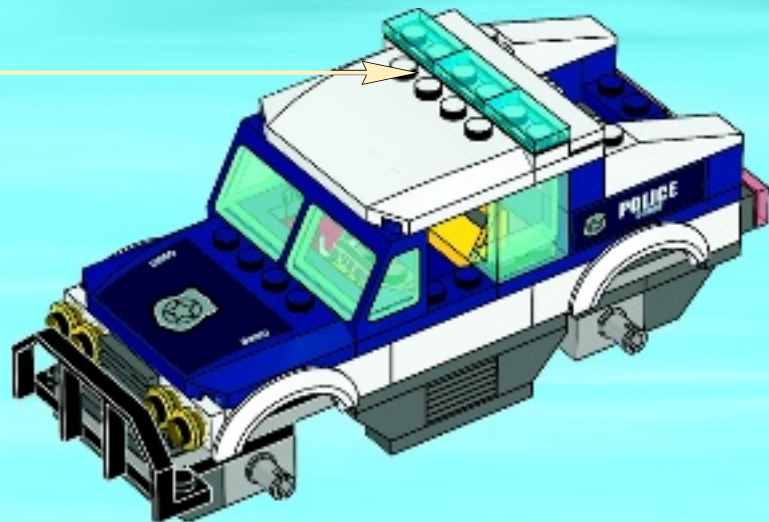
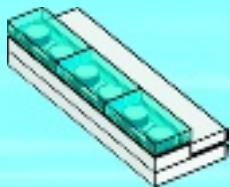

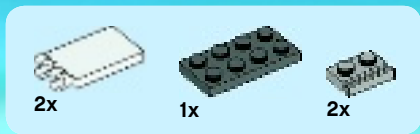

# 34

1



2

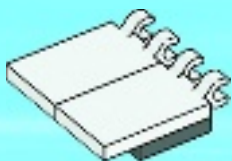

3

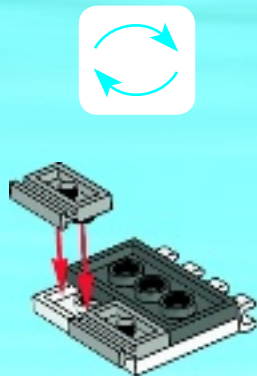



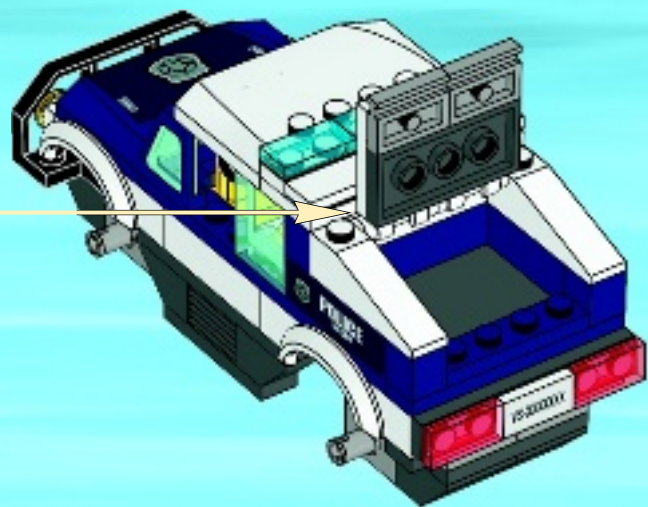



1x



1x

# 35

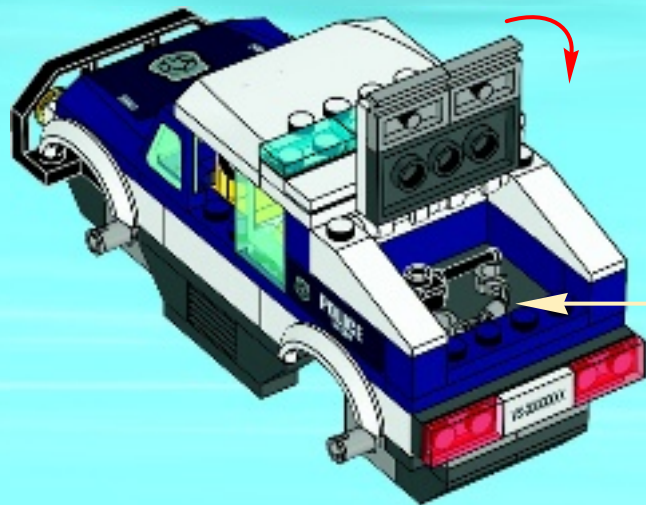



4x



4x

# 36

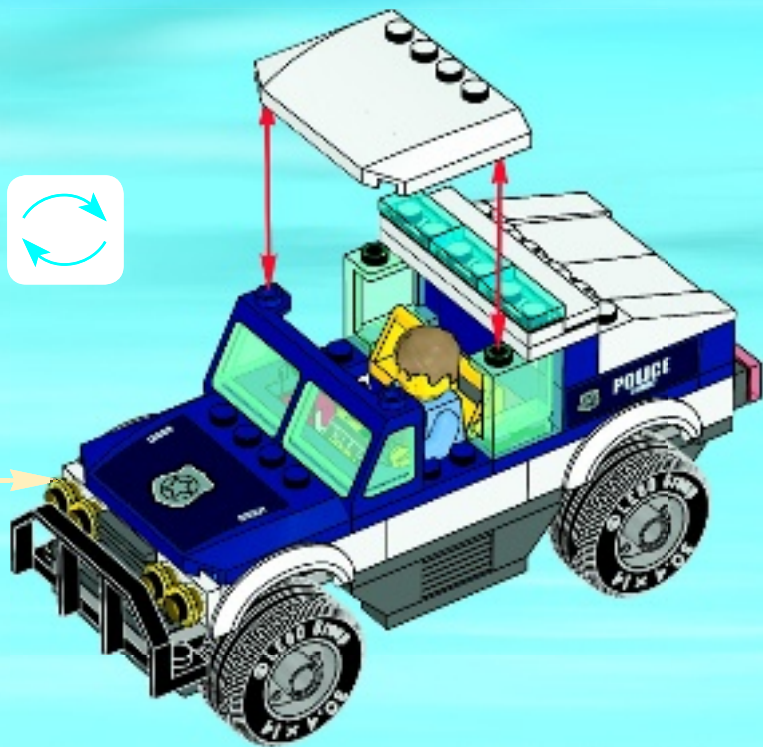



# CITY

UNDERCOVER

Wii U



[www.pegi.info](http://www.pegi.info)



# GAME CODE INCLUDED

ACTIVATES COOL VEHICLES AND SECRET MISSIONS IN WII U GAME AND ON [LEGO.COM/CITY](http://LEGO.COM/CITY)  
LEGO CITY UNDERCOVER: AVAILABLE ON [LEGO.COM/SHOP](http://LEGO.COM/SHOP)

Wii U game sold separately



**INKLUSIVE CODE ZUM FREISCHALTEN VON BONUSMATERIAL**  
SCHALTET COOLE FAHRZEUGE UND GEHEIME MISSIONS IM WII  
U SPIEL UND AUF [LEGO.COM/CITY](http://LEGO.COM/CITY) FREI  
LEGO CITY UNDERCOVER: ERHÄLTlich AUF [LEGO.COM/SHOP](http://LEGO.COM/SHOP)  
Wii U Spiel einzeln erhältlich

**CODE DE JEU INCLUS**  
DÉBLOQUE DES VÉHICULES SUPER COOL ET DES MISSIONS  
SECRETES DANS LE JEU WII U ET SUR [LEGO.COM/CITY](http://LEGO.COM/CITY)  
LEGO CITY UNDERCOVER: DISPONIBLE SUR [LEGO.COM/SHOP](http://LEGO.COM/SHOP)  
Jeu Wii U vendu séparément

**CÓDIGO DE JOGO INCLuíDO**  
ATIVA SUPER VEÍCULOS E MISSÕES SECRETAS NO JOGO WII U  
E NA [LEGO.COM/CITY](http://LEGO.COM/CITY)  
LEGO CITY UNDERCOVER: DISPONÍVEL EM  
[LEGO.COM/SHOP](http://LEGO.COM/SHOP)  
Jogo Wii U vendido separadamente

**INCLUYE UN CÓDIGO DE JOGO**  
ACTIVA FANTÁSTICOS VEHÍCULOS Y MISIONES SECRETAS EN EL  
JUEGO PARA WII U Y EN [LEGO.COM/CITY](http://LEGO.COM/CITY)  
LEGO CITY UNDERCOVER: DISPONIBLE EN [LEGO.COM/SHOP](http://LEGO.COM/SHOP)  
El juego para Wii U se vende por separado

**JÁTÉKKÓD DAL**  
VAGÁNY JÁRMŰVEKET ÉS TITKOS KÜLDETÉSEKET INÓT EL A WII U  
JÁTÉKBAN ÉS A [LEGO.COM/CITY](http://LEGO.COM/CITY) HONLAPON  
LEGO CITY UNDERCOVER: KAPHATÓ A [LEGO.COM/SHOP](http://LEGO.COM/SHOP) HONLAPON  
Wii U játék külön kapható



CITY

LEGO.com/city

**EXPLORE TONS OF GAMES,  
MOVIES AND FUN CHALLENGES**



Entdecken Sie Spiele, Filme und spannende Herausforderungen  
Découvrez de nombreux films, jeux et défis amusants  
Explora abundantes juegos, películas y desafíos divertidos  
Explora una increíble variedad de juegos, filmes e oportunidades de divertimento  
Pokužite tu širok izbor igr, filmov, in izzivov odprebrat

**LEGO**

**CITY**

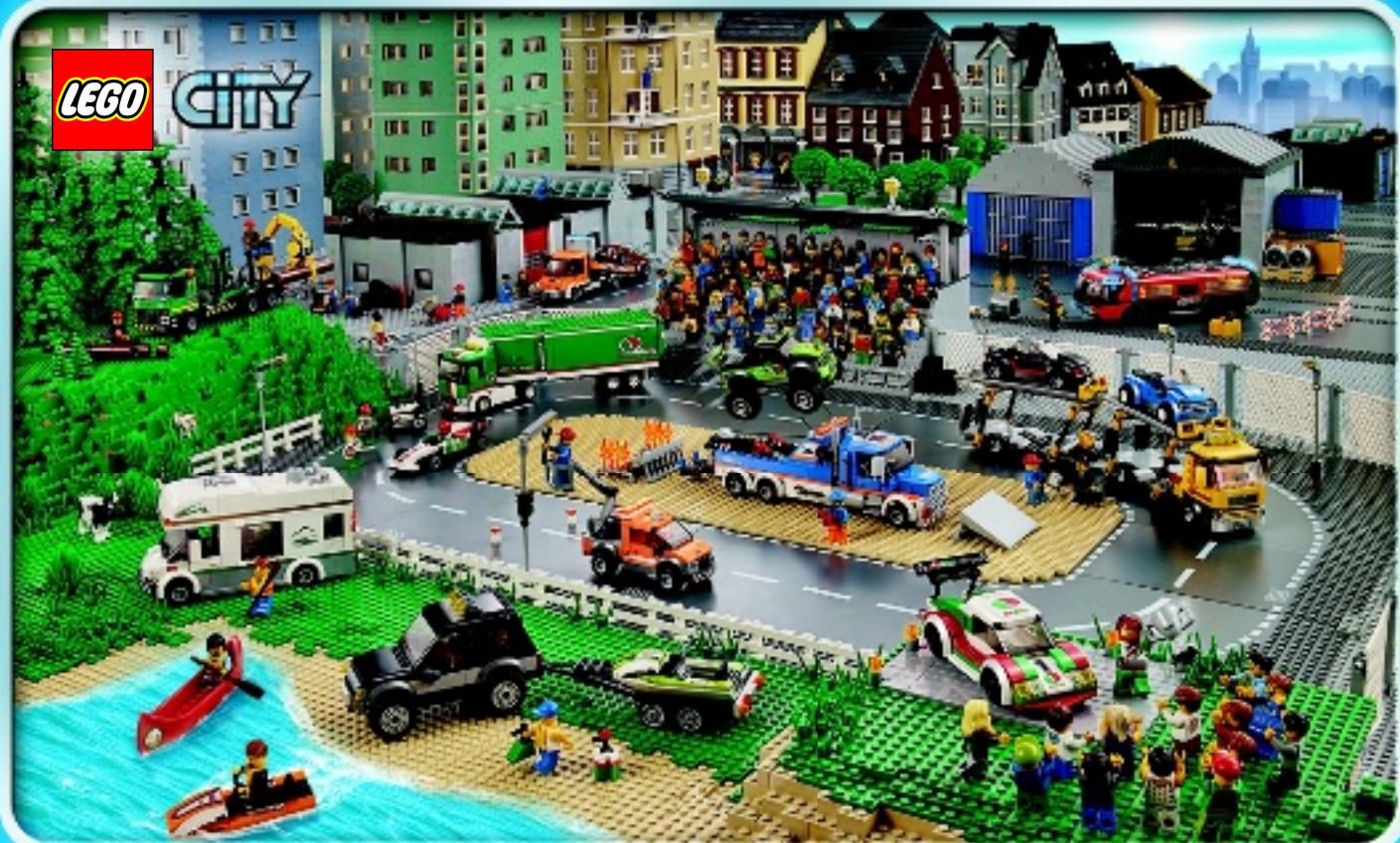



# WIN!

Go to [LEGO.com/productfeedback](http://LEGO.com/productfeedback) to fill out a survey for a chance to win a cool LEGO® Product.

No purchase necessary.  
Open to all residents where not prohibited.



## LEGO.com/productfeedback

### GEWINNE!

Nimm an der Umfrage auf [LEGO.com/productfeedback](http://LEGO.com/productfeedback) teil und hab die Chance ein cooles LEGO® Produkt zu gewinnen!

Die Teilnahme am Gewinnspiel führt zu keinerlei Kaufverpflichtungen. Teilnahme in allen nicht ausgeschlossenen Ländern möglich.



6084385

### WIN!

Ga naar [LEGO.com/productfeedback](http://LEGO.com/productfeedback), vul een enquêteformulier in en maak kans op een cool LEGO® product.

Geen aankoopverplichting.  
Iedereen mag deelnemen, uitgezonderd ingezetenden van landen waar een enquêteverbod geldt.

### GAGNE!

Visite [LEGO.com/productfeedback](http://LEGO.com/productfeedback) pour répondre à un questionnaire et avoir une chance de gagner un produit LEGO® très cool!

Aucune obligation d'achat.  
Ouvert à tous les résidents des pays autorisés.

### 当てよう!

[LEGO.com/productfeedback](http://LEGO.com/productfeedback) にアクセスして、アンケートにご記入ください。当選者にはレゴ®製品を差し上げます。

お買い上げの必要はありません。  
禁止されていない限り、すべての皆様にご利用いただけます。





60007



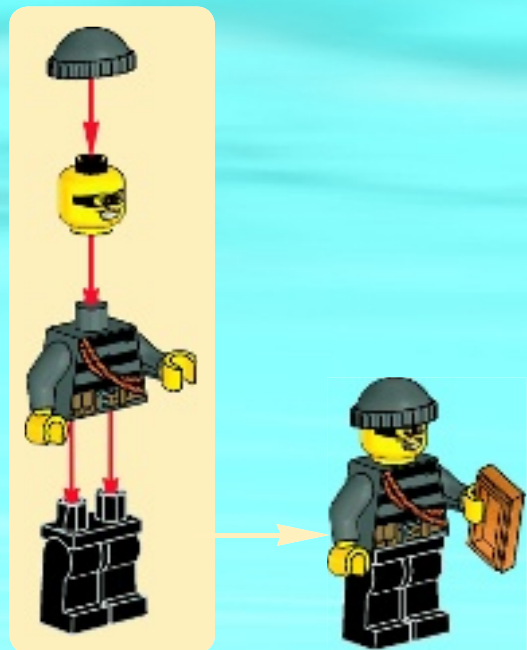

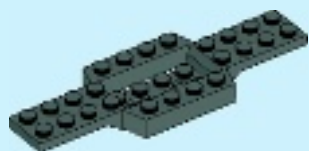

1x

1

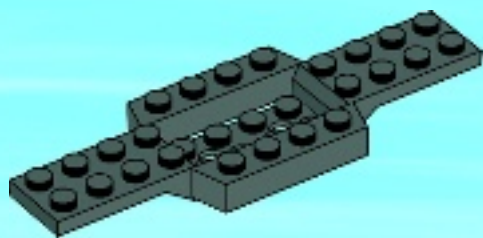



2x

2

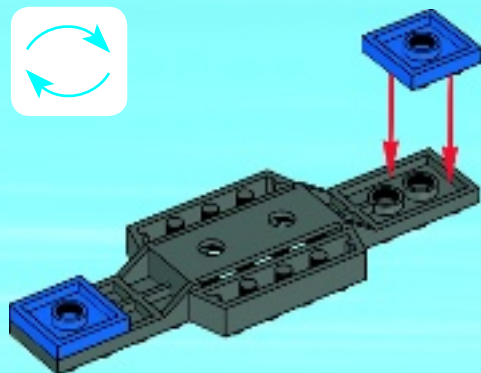



1x



1x



1x

# 3

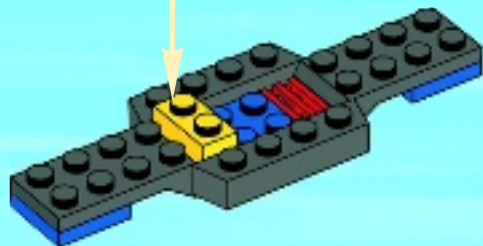

2x



2x

# 4

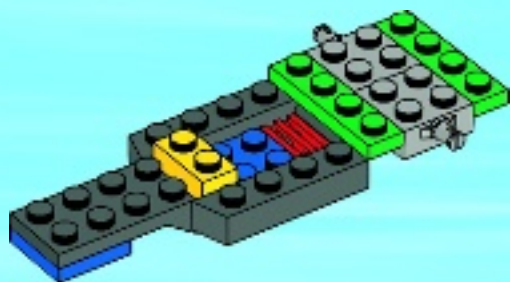



2x

5



6





2x

8



2x

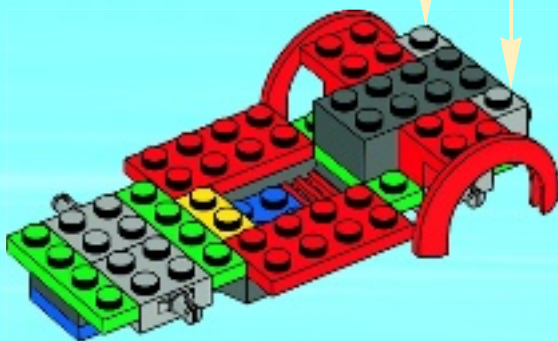





1x



1x

9

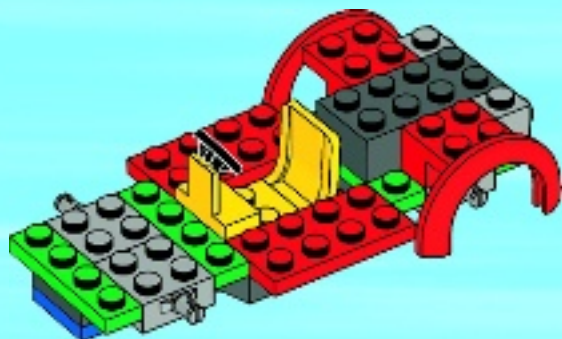

2x



4x

10

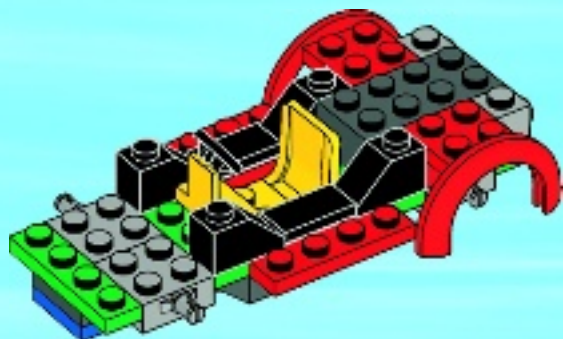



2x



1x



2x

# 11

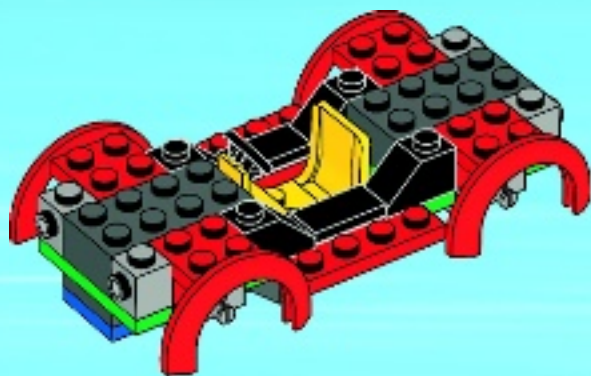



2x



2x



2x

# 12

1

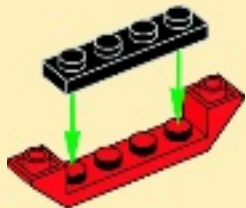

2



2x

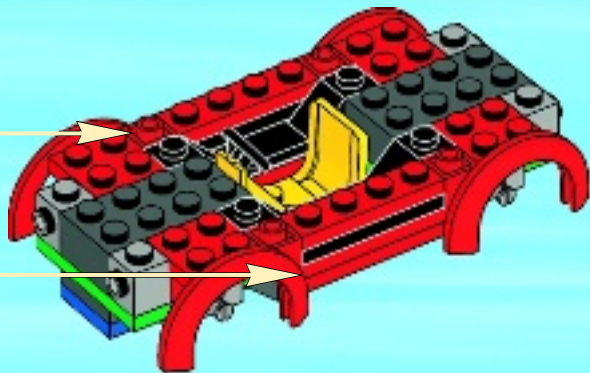

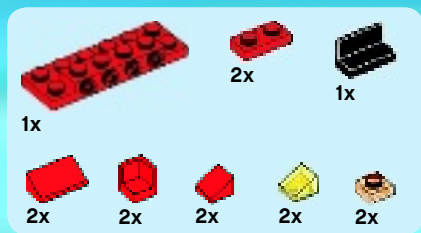

# 13

1

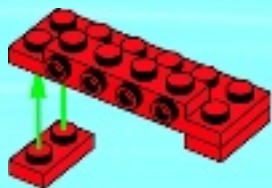

2

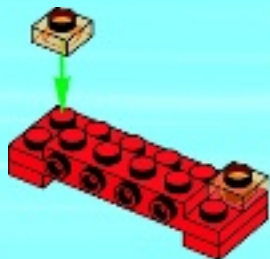

3

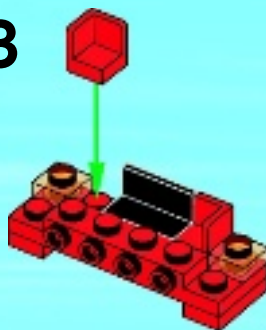

4

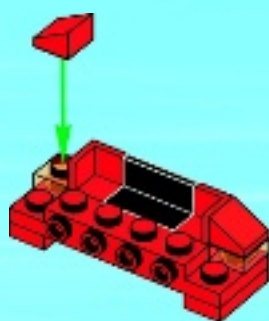

5

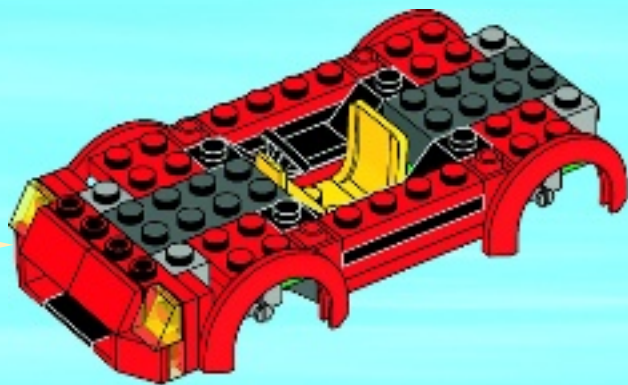
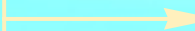
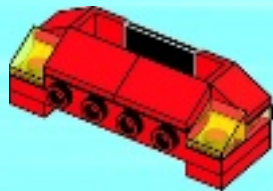

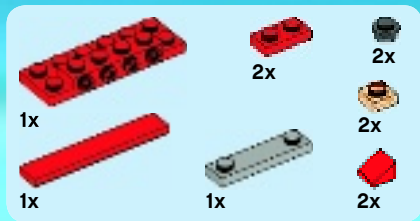

# 14

1

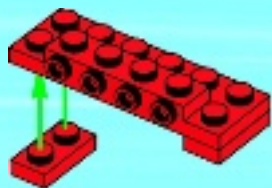

2

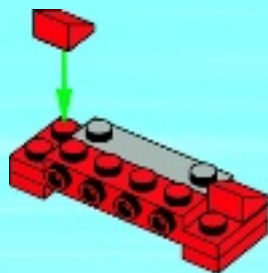

3

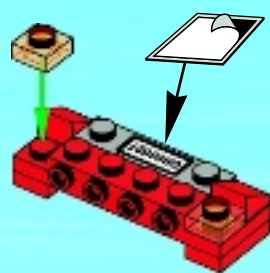

4

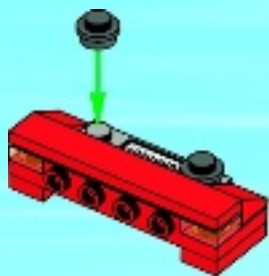



1x



2x

# 15

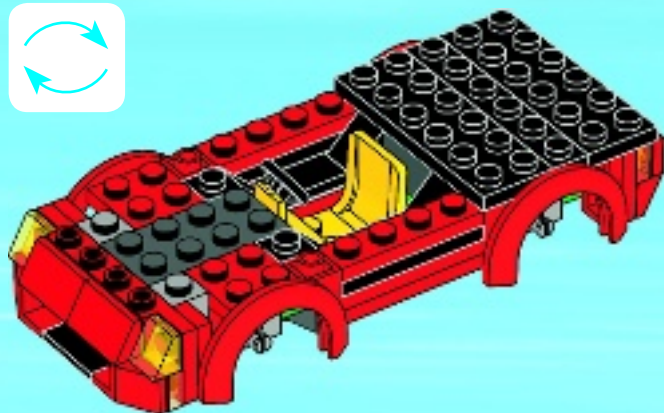





2x

16

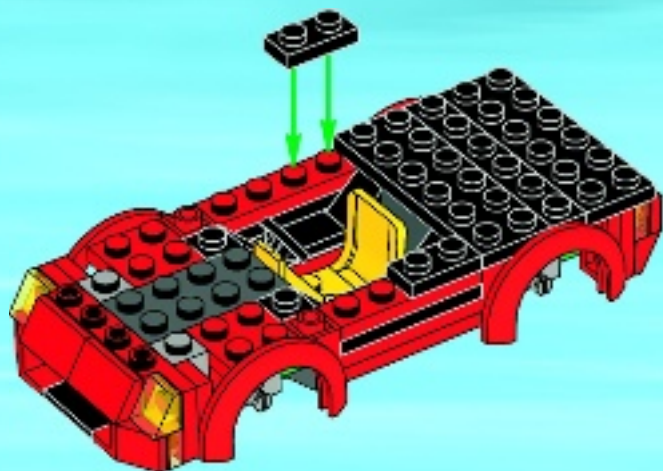



2x



1x

17

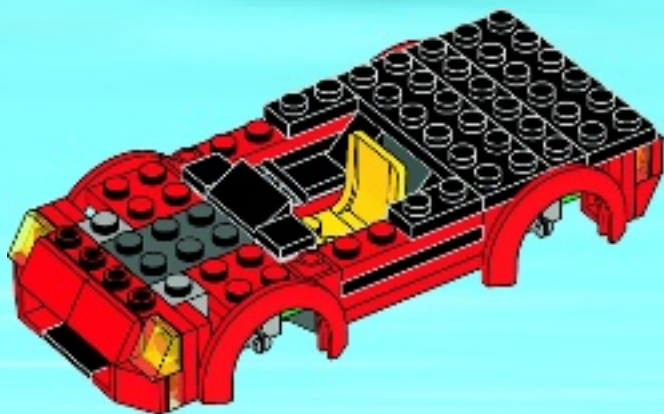



1x



1x

# 18

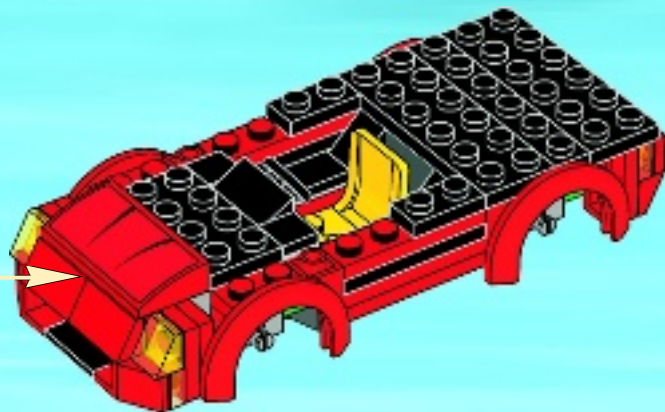
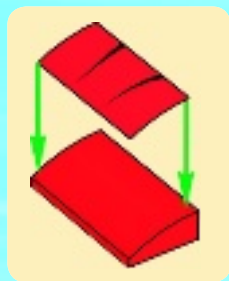



1x



1x



2x

# 19

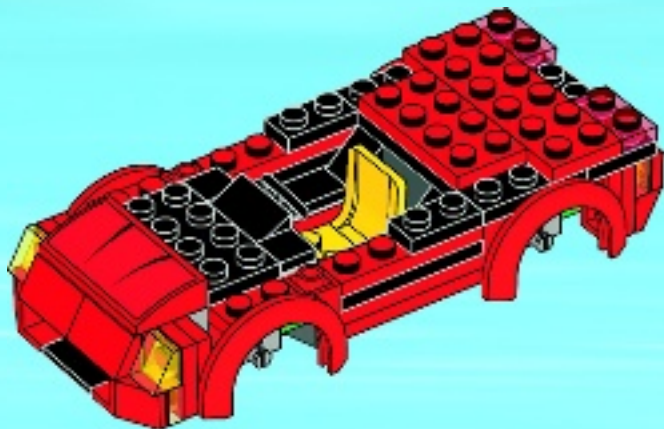



2x

20

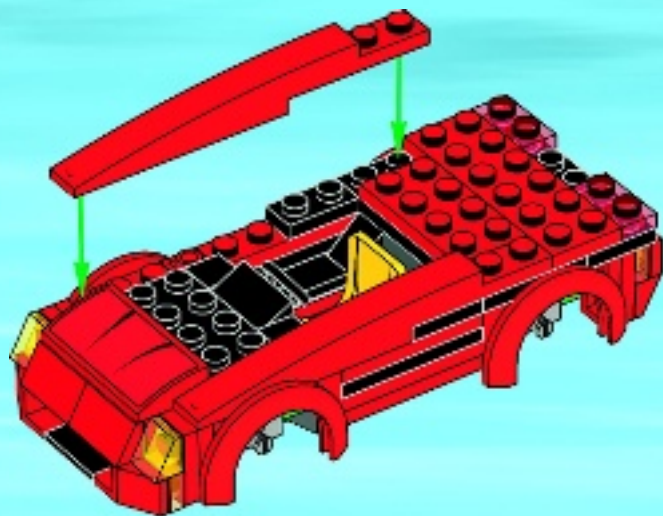



1x

21

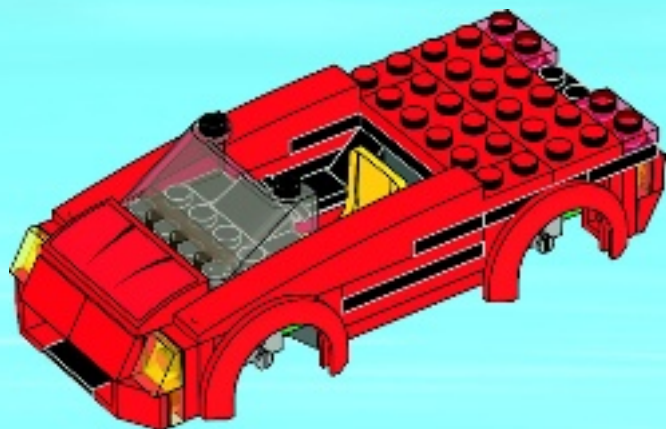

22



4x



2x

# 22

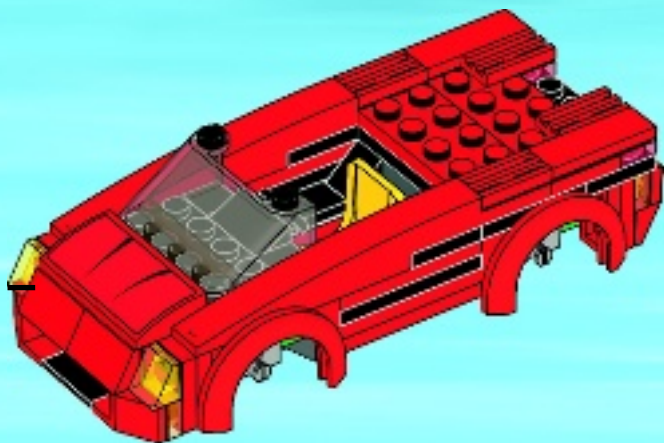



1x



1x

# 23

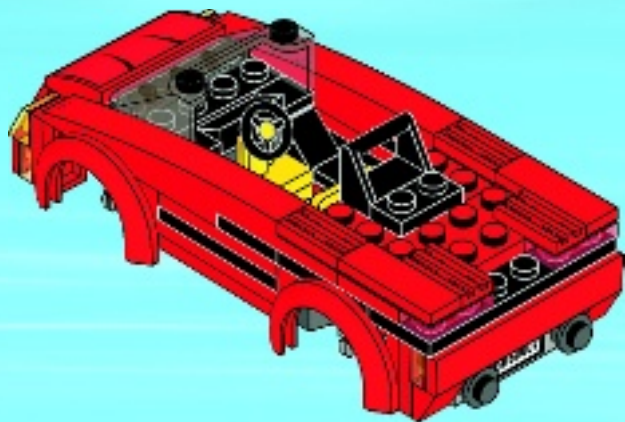

24





2x

24

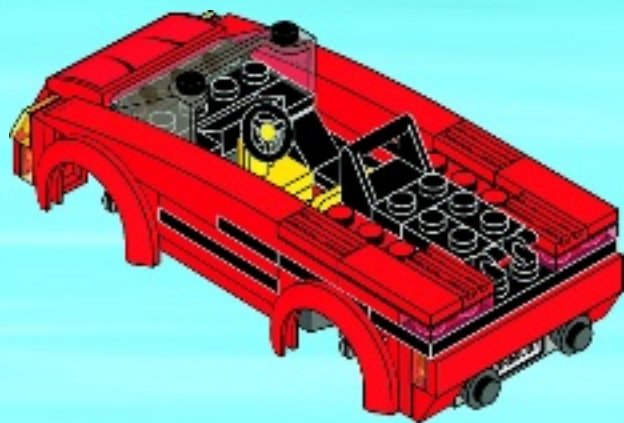



2x

25

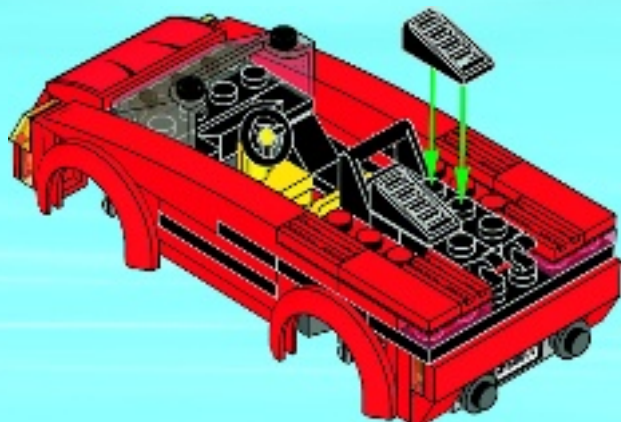

26



2x

26

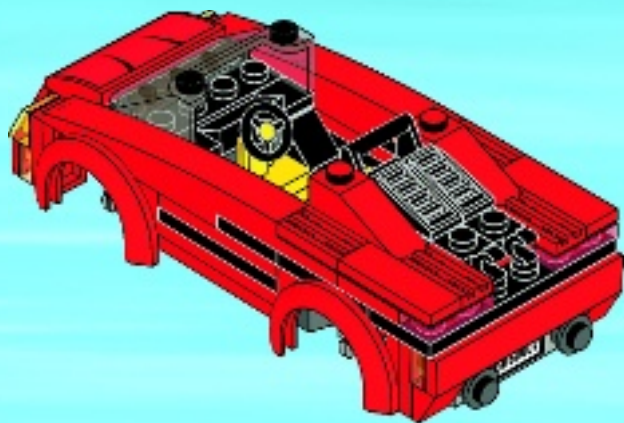



1x



1x

27

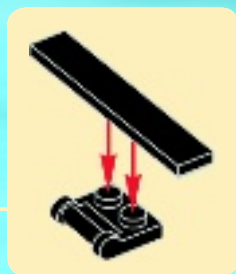
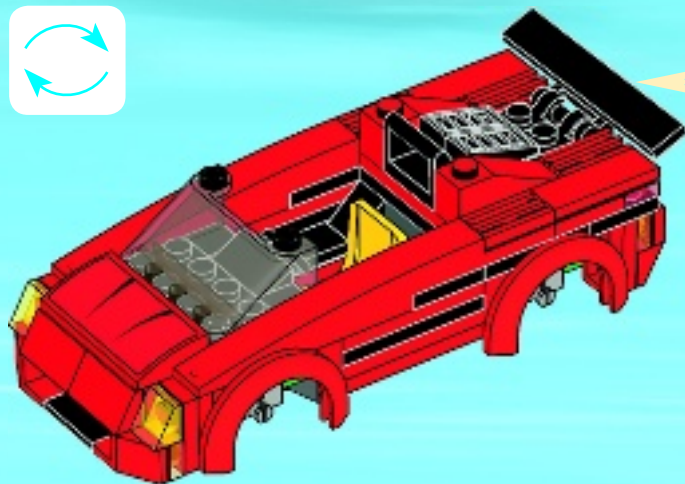

28



4x

28



2x

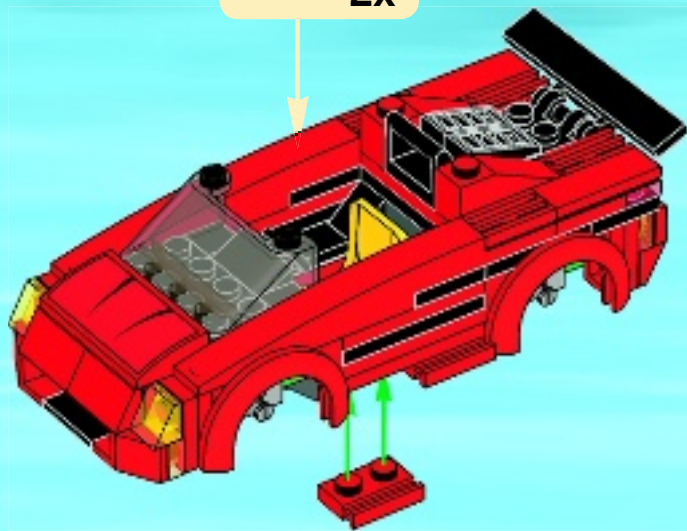



4x



4x

# 29



4x

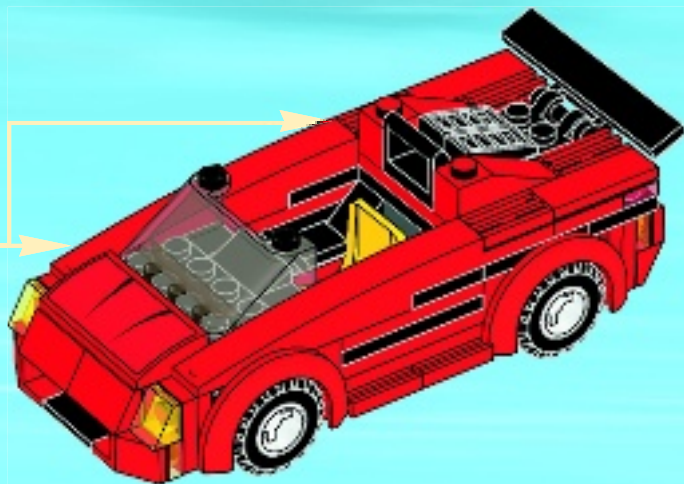



12x



3x

# 30

## 1

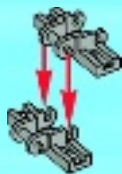

## 2

