

9

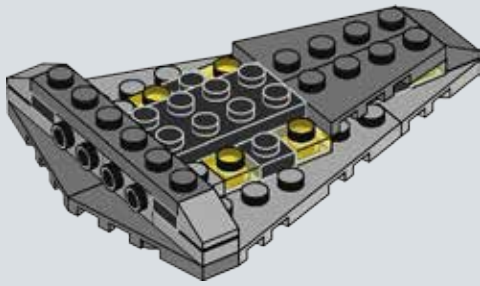

10

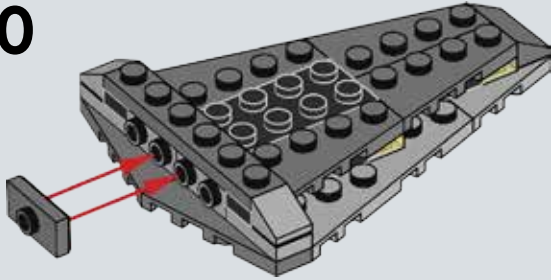

11

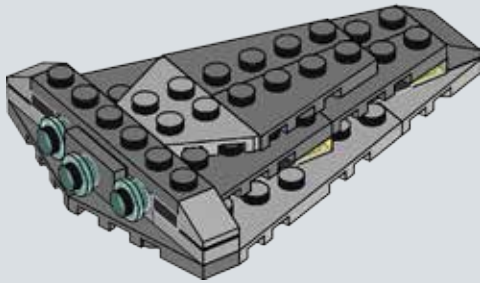

12

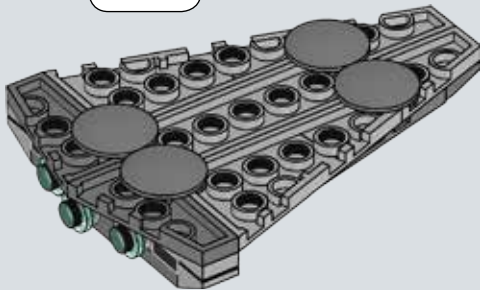

13

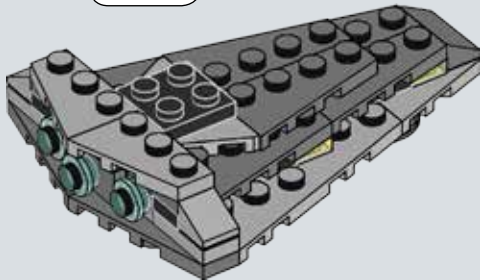

14

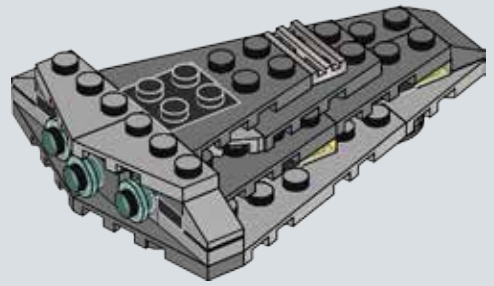

15

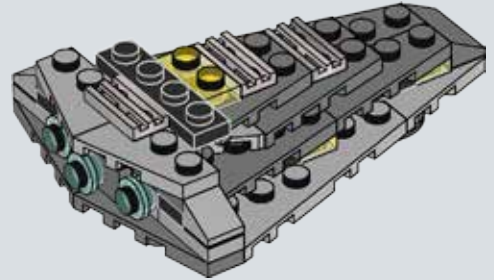

16

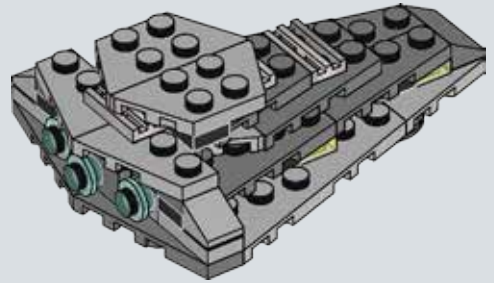

17

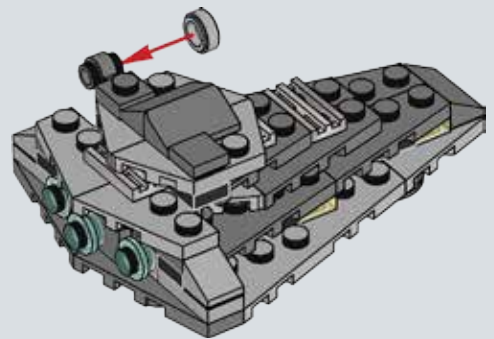

LEGO.com/service



LEGO and the LEGO logo are trademarks of the LEGO Group. ©2016 The LEGO Group.

© & ™ Lucasfilm Ltd.

6142965