



# CITY

60069



[LEGO.com/city](http://LEGO.com/city)





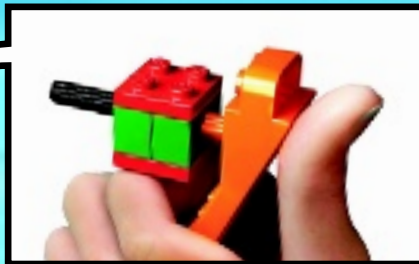

[LEGO.com/brickseparator](https://LEGO.com/brickseparator)

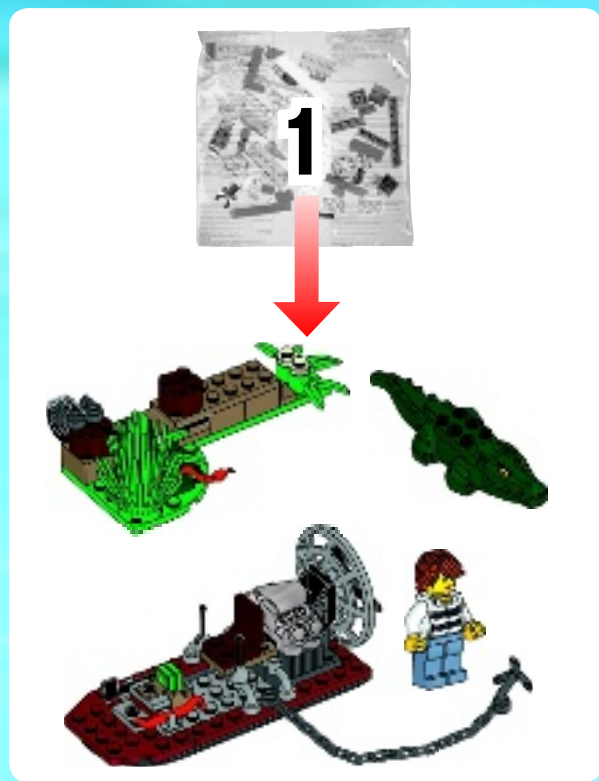

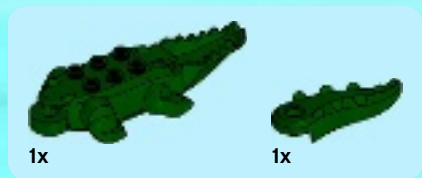

1

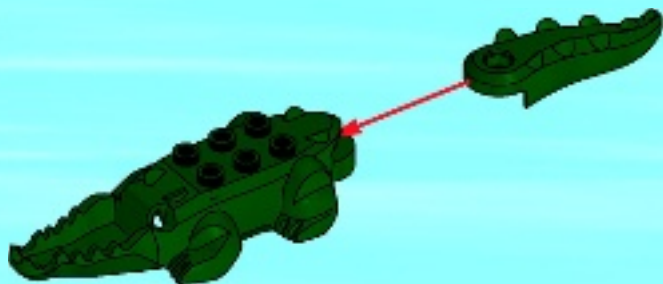



1x

2

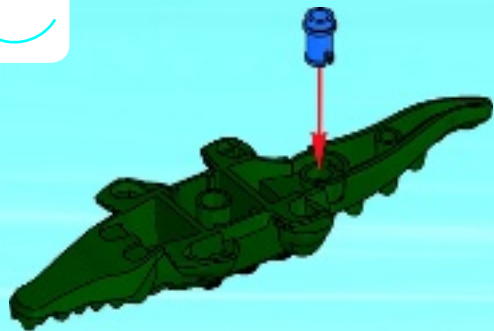

1x

3





1





2x

2

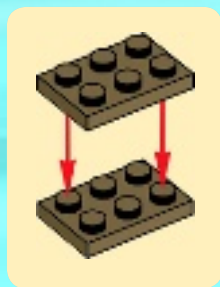





1x



1x

3

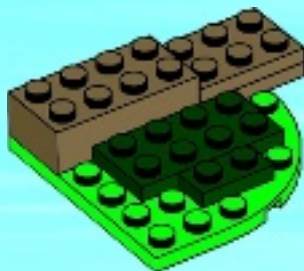

1x



1x

4

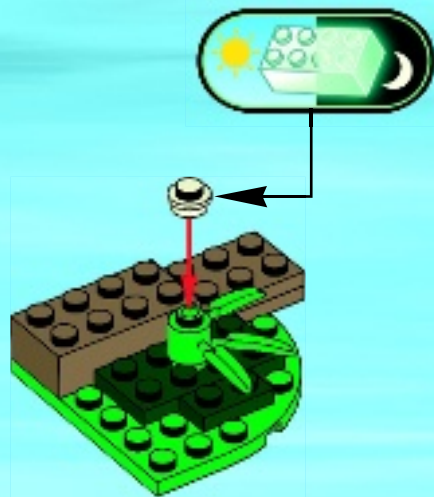

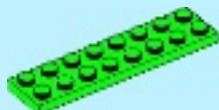

1x

5

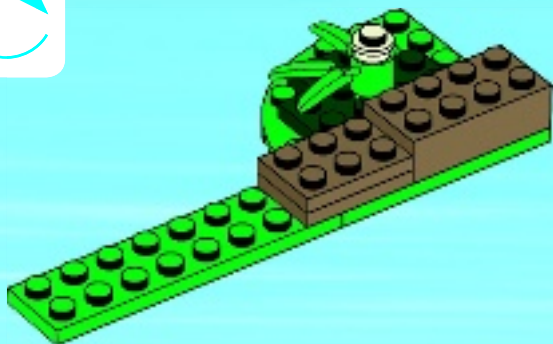



1x



1x



1x

6

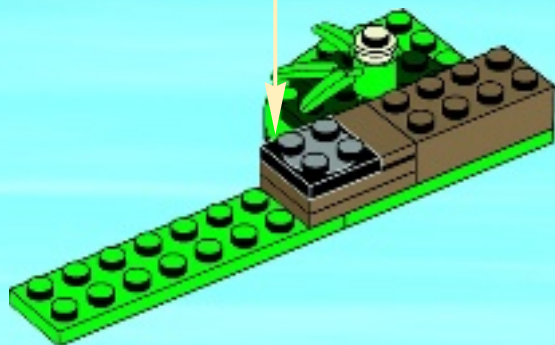





3x

8

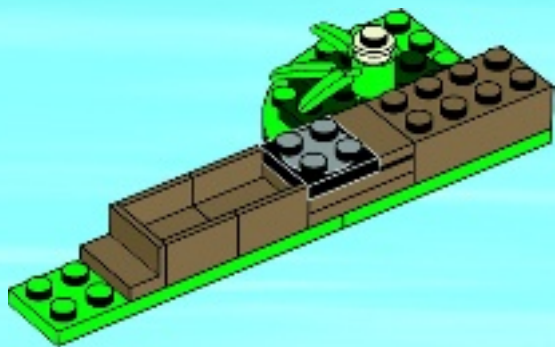

1x

9

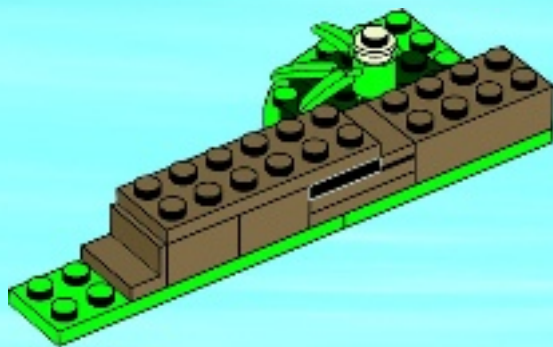



2x

10

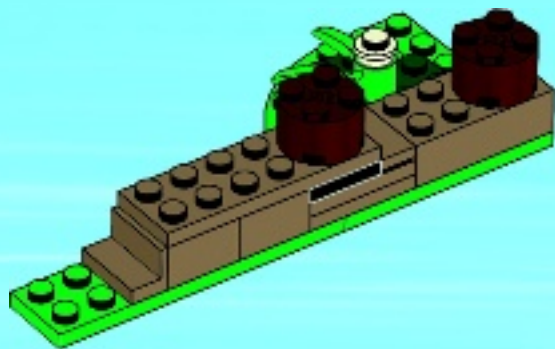



1x



1x

# 11

1



2

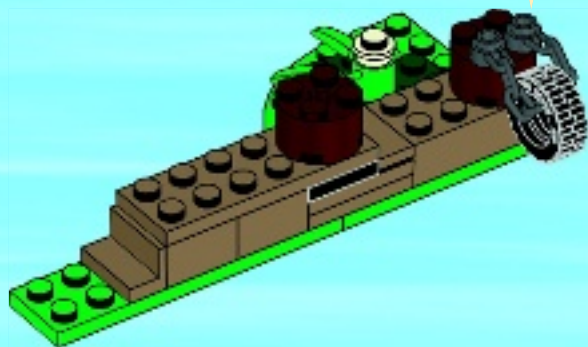



1x



2x



2x

# 12

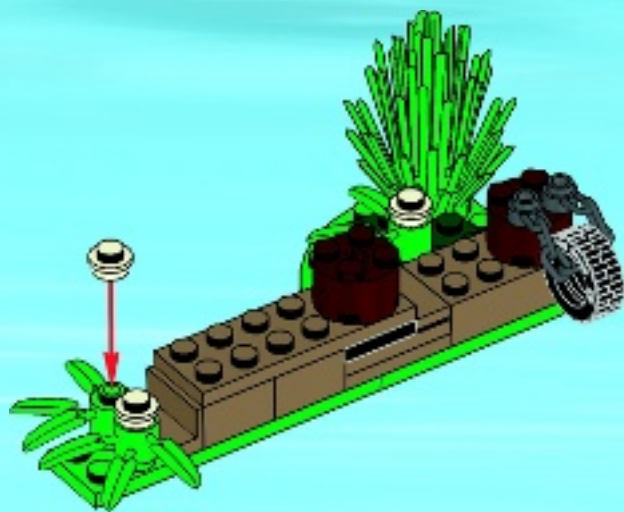





3x



1x

# 13

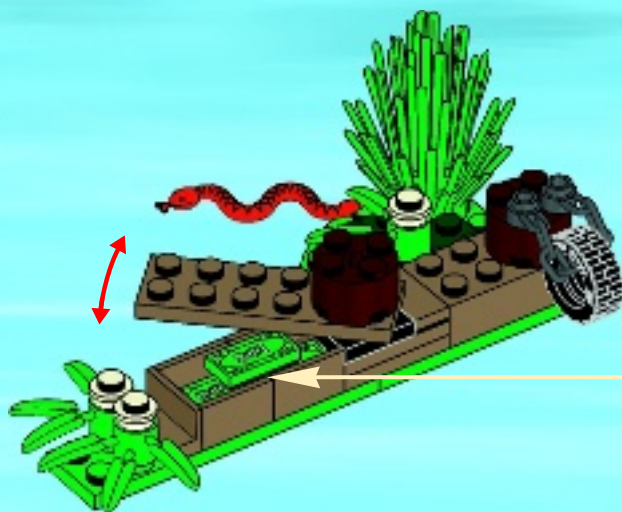

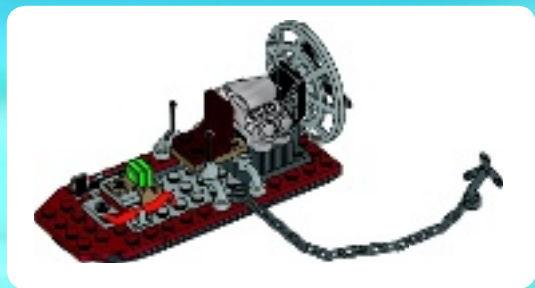

1





1x

2



2x

3

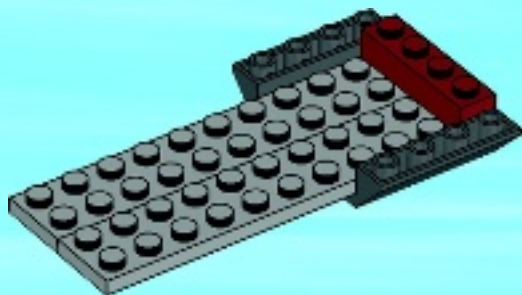



2x

4

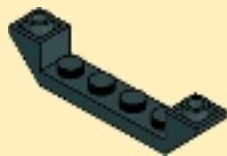

2x

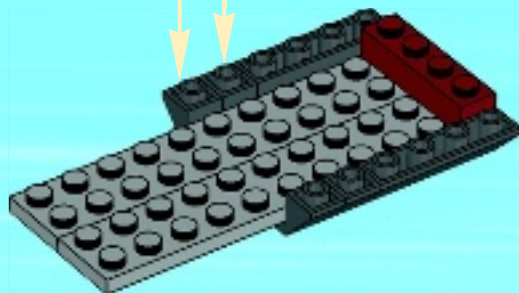



1x

5

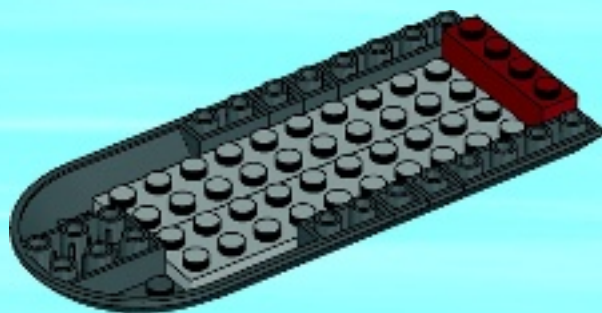



1x

6

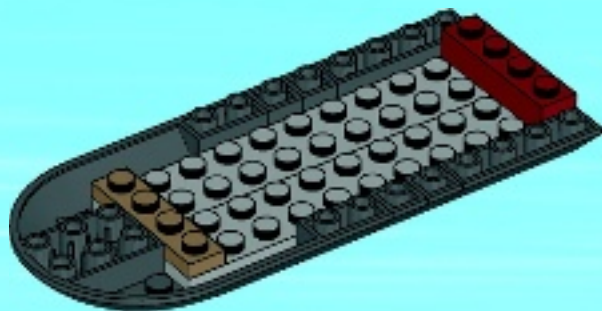



2x

7

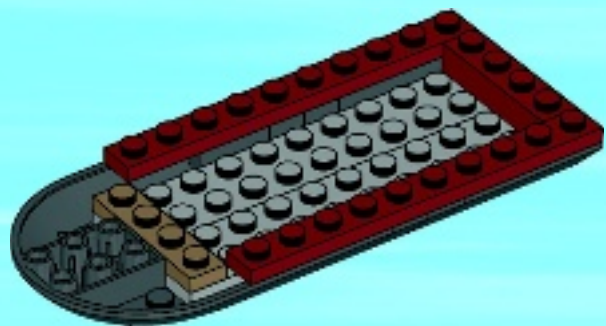

1x

8





1x

9

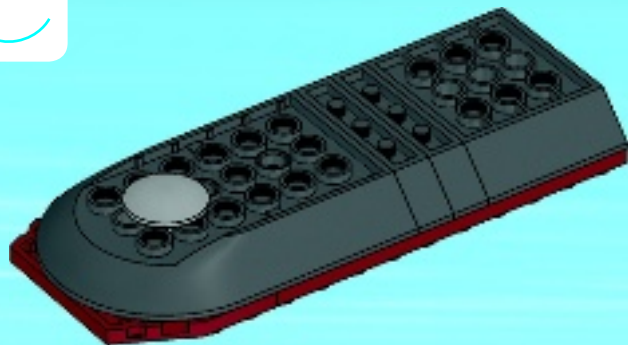





2x

# 10



2x



1x

# 11

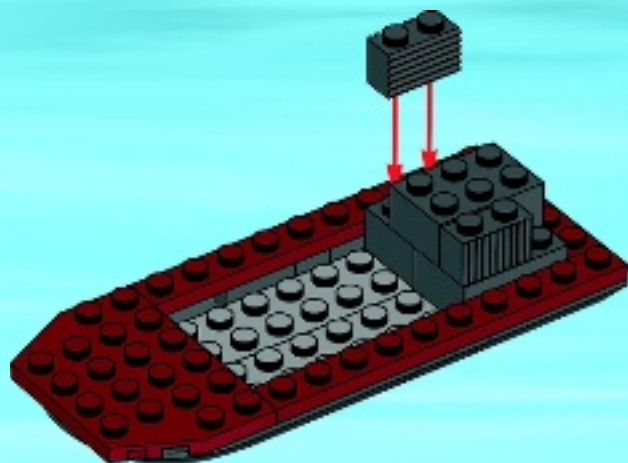



1x

# 12

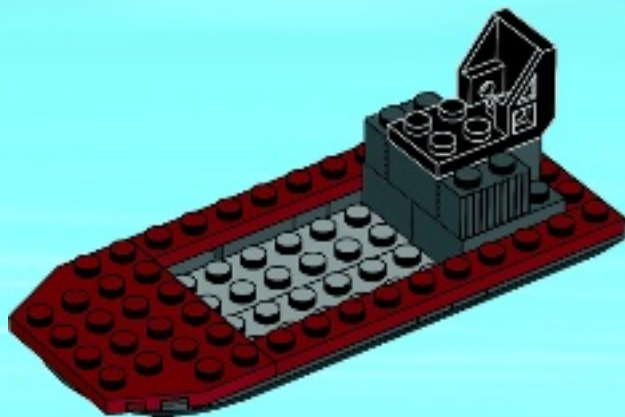



2x

13

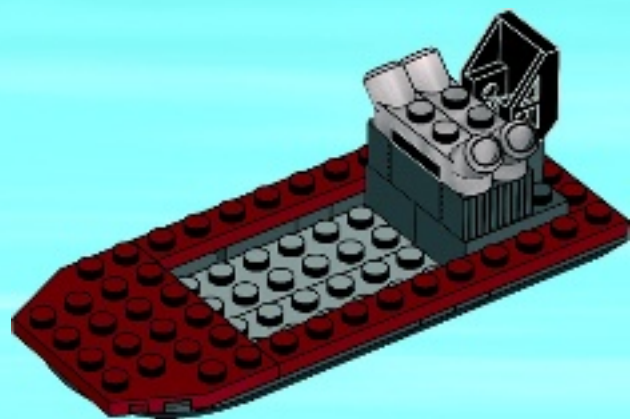

1x

14

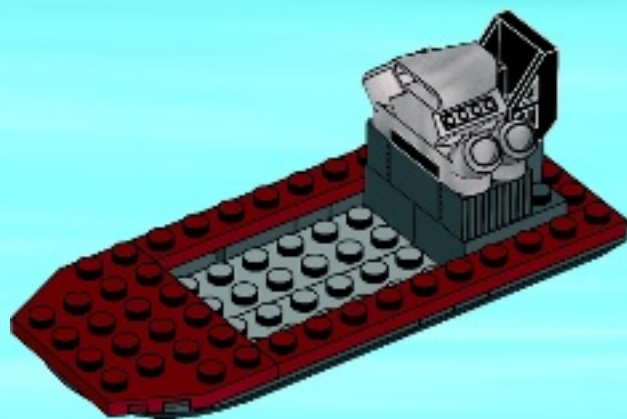



# 15

1



2



3



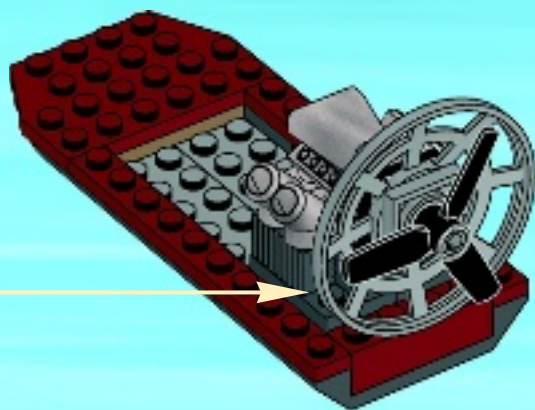



1x

16

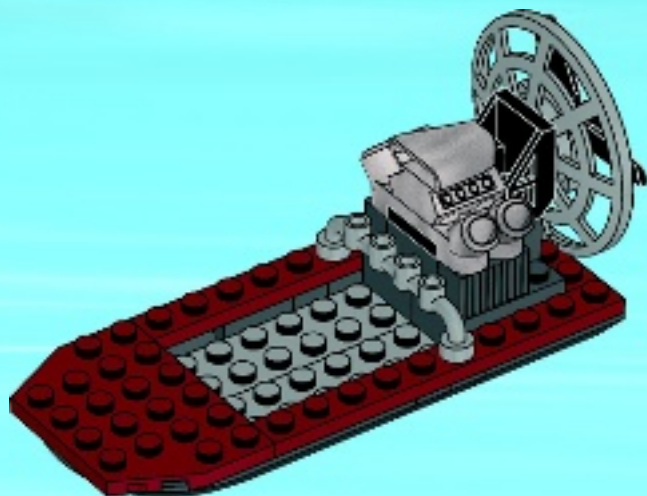

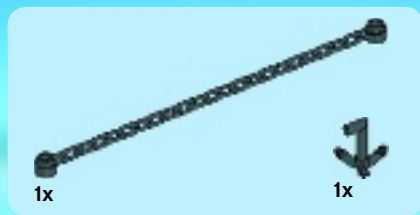

17

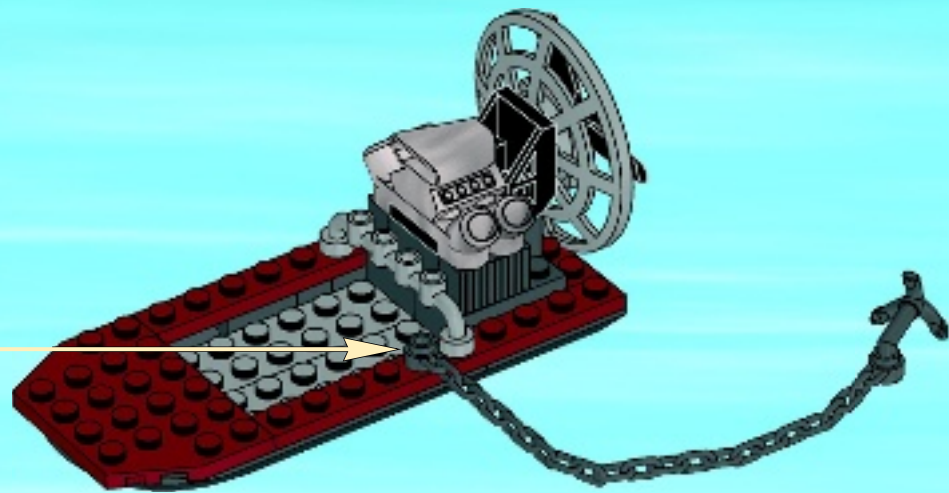



1x

18

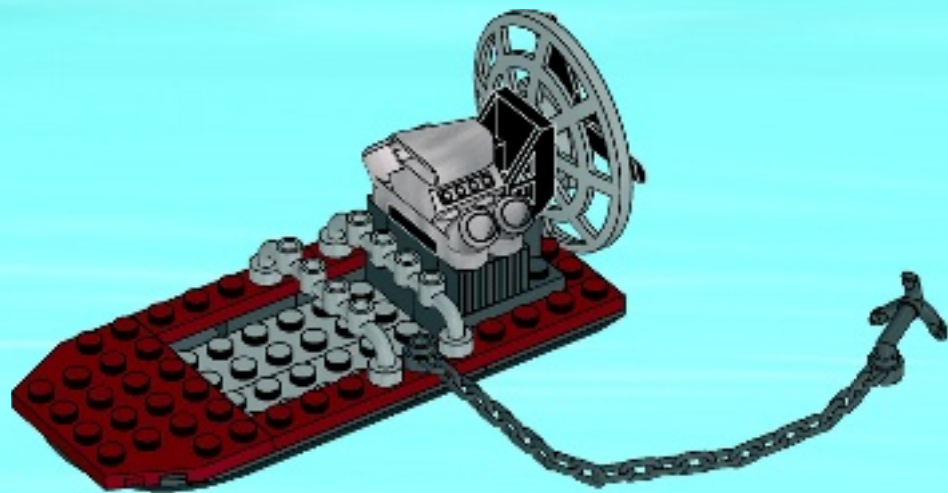





1x

19

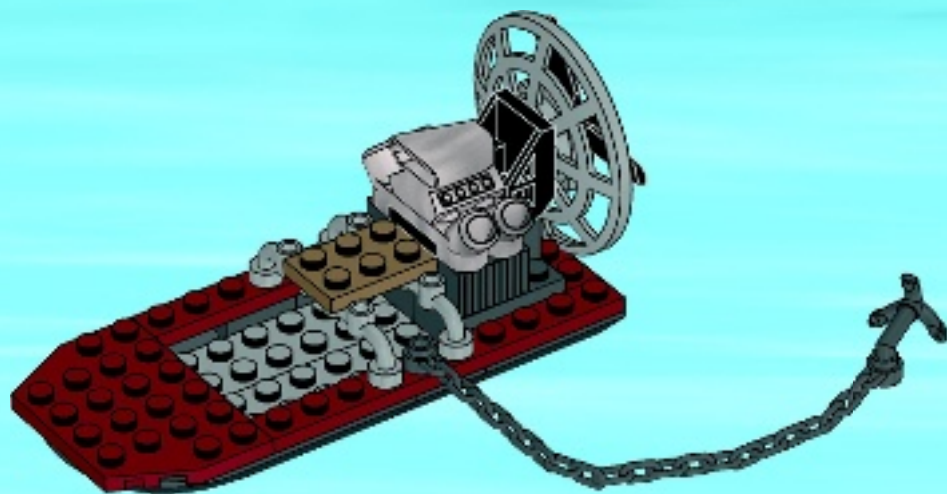



1x



2x

20

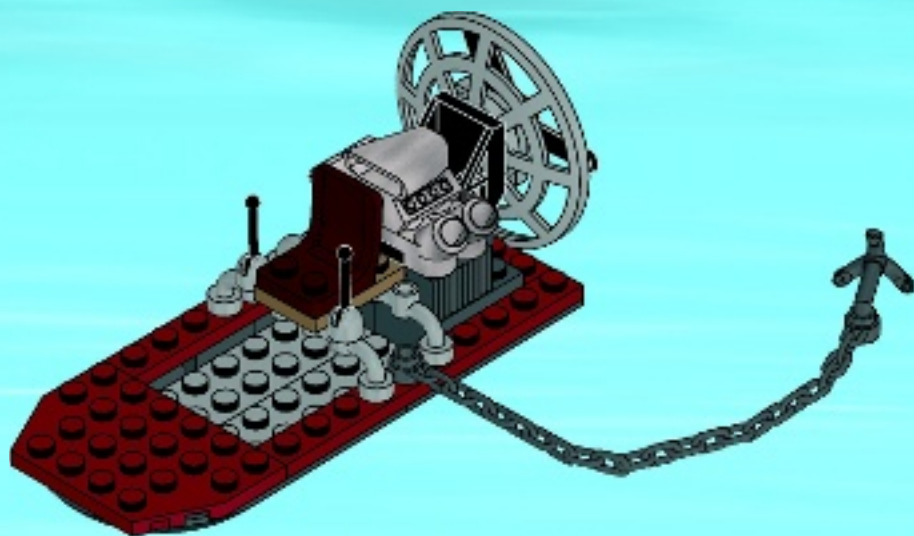



2x

# 21

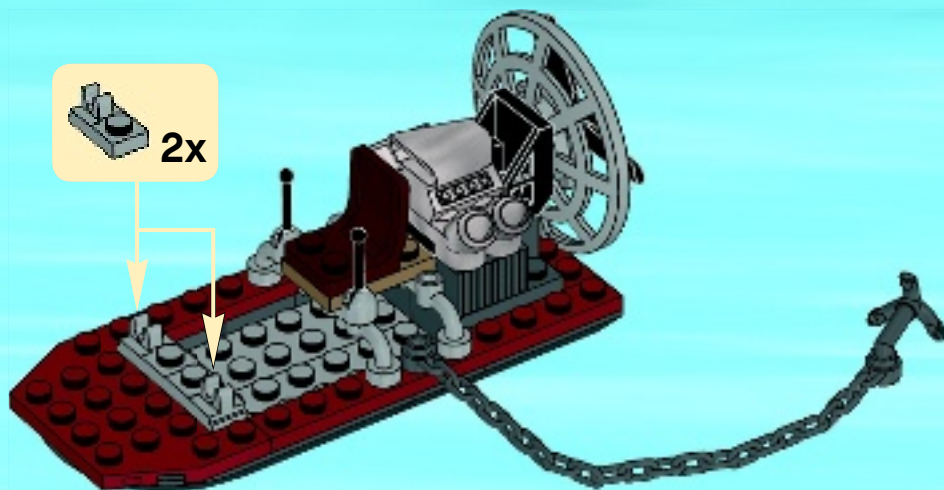



1x



1x

# 22

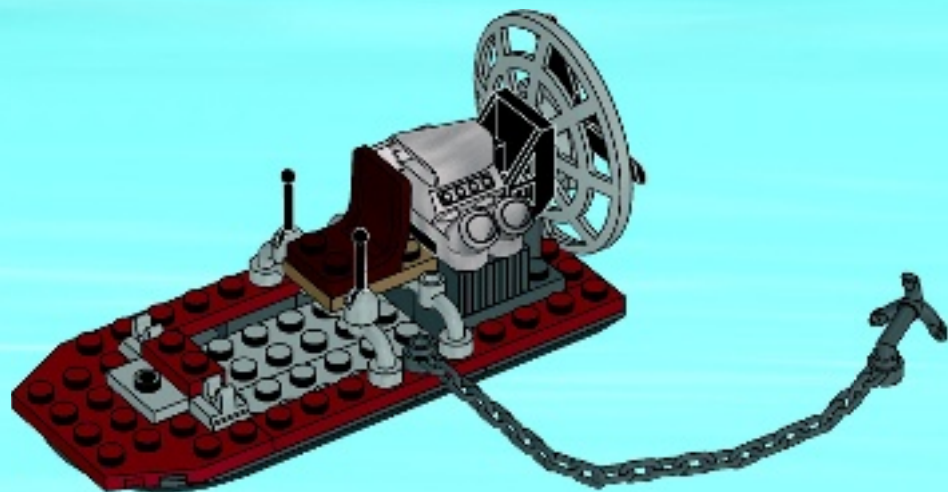



1x

23

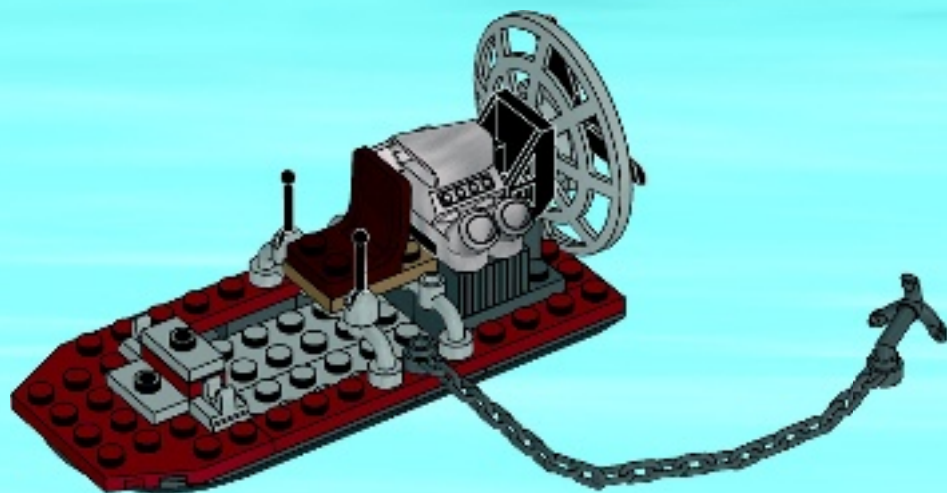

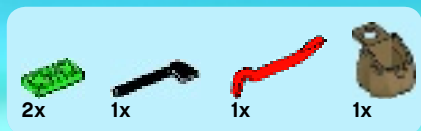

24

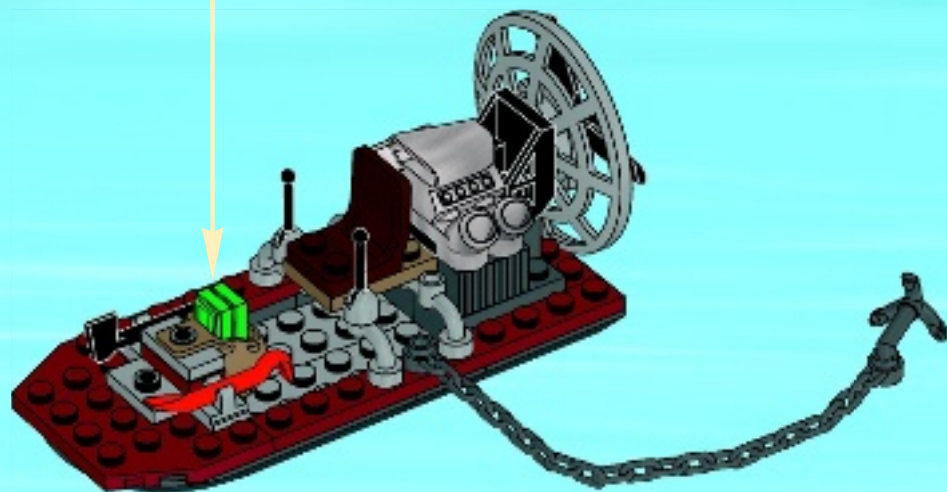



1x



1x

# 25

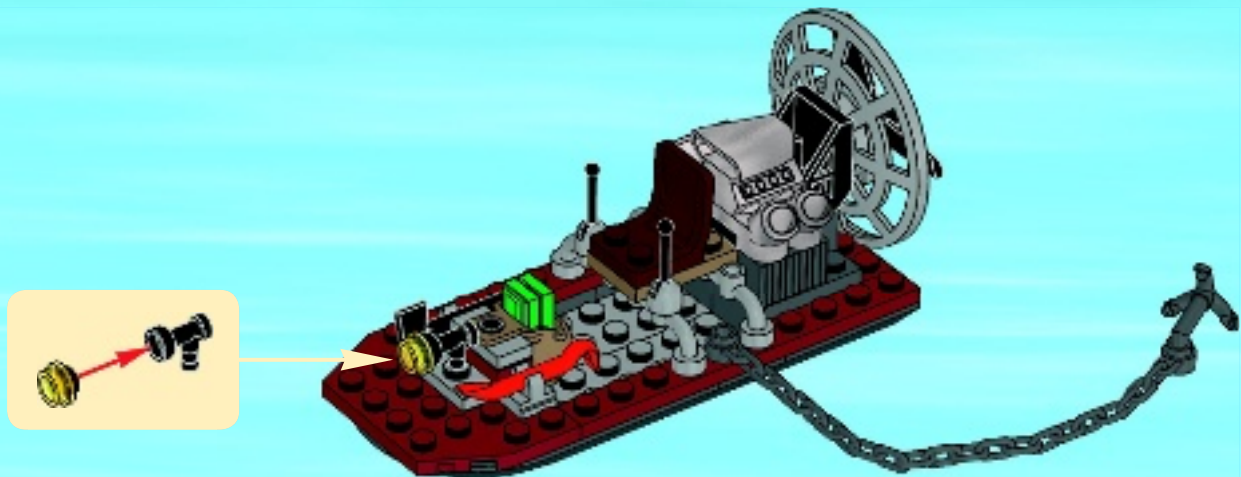

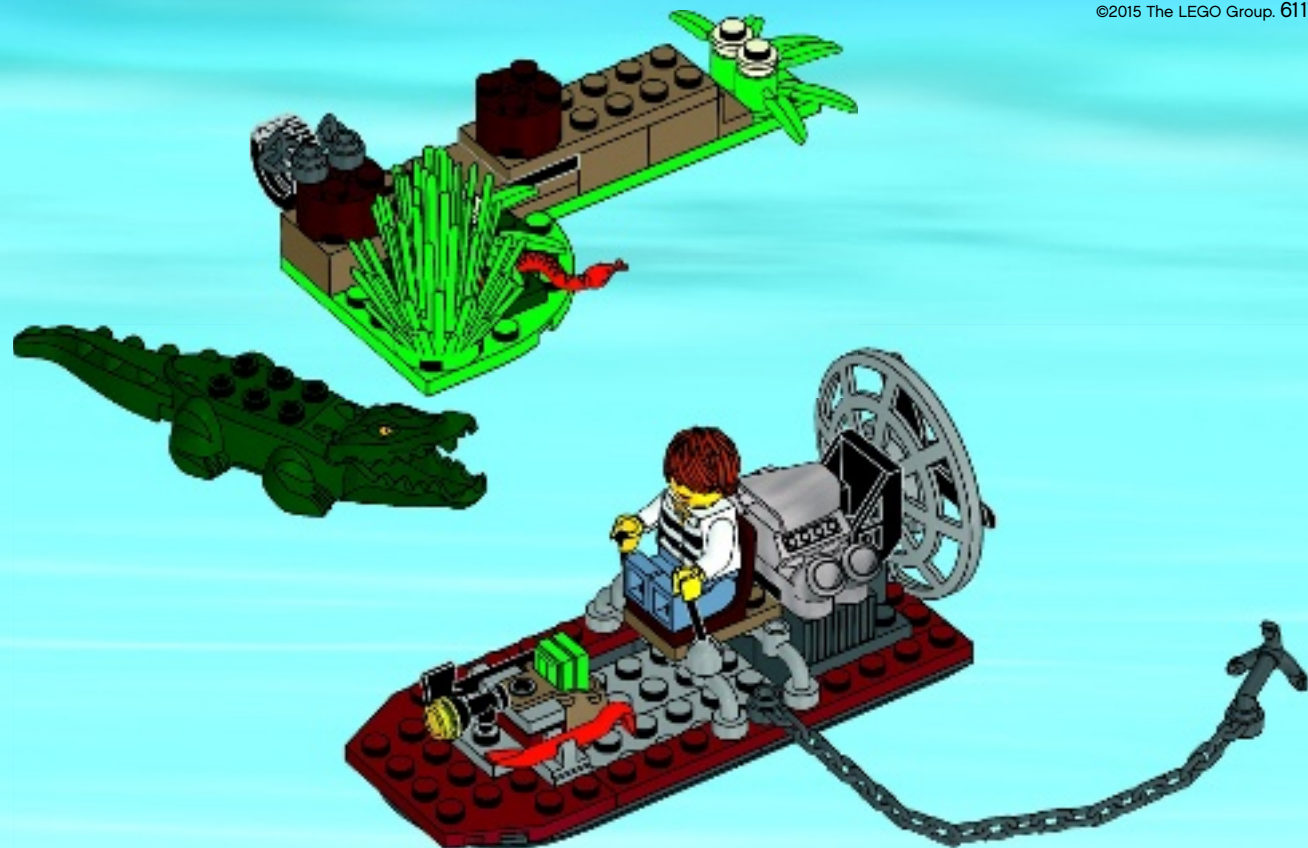





# CITY

60069

 [LEGO.com/city](http://LEGO.com/city)



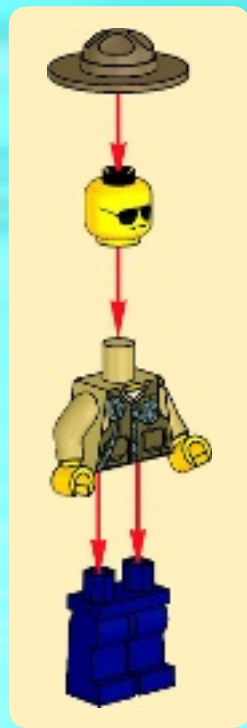



1x

1



2x



1x

2

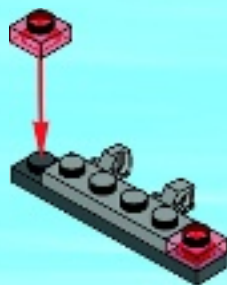



1x

3



4



1x

4

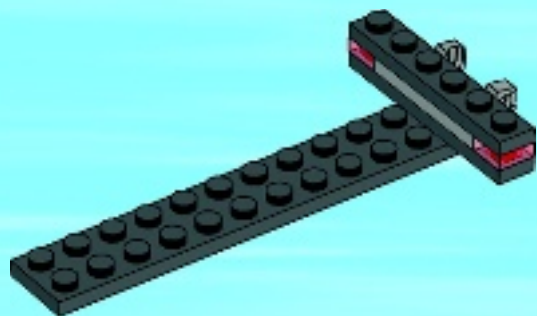

1x



1x

5

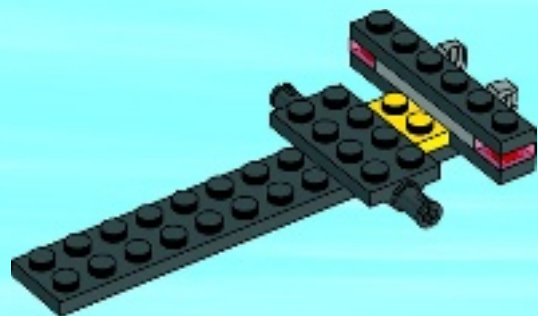



1x



1x

6

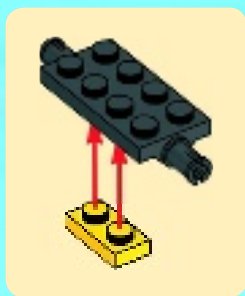



1x

7



2x

8

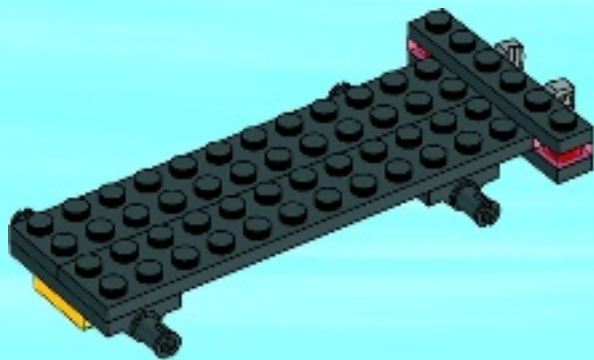



1x

9

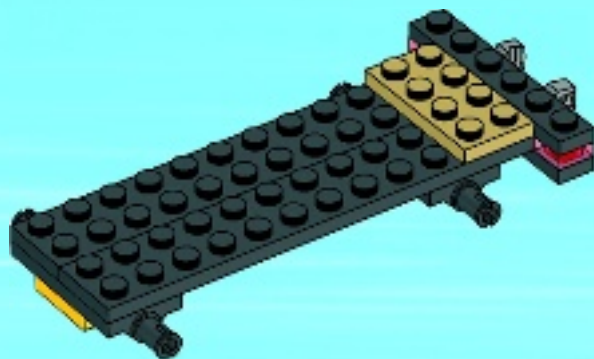

8





1x



1x

# 10

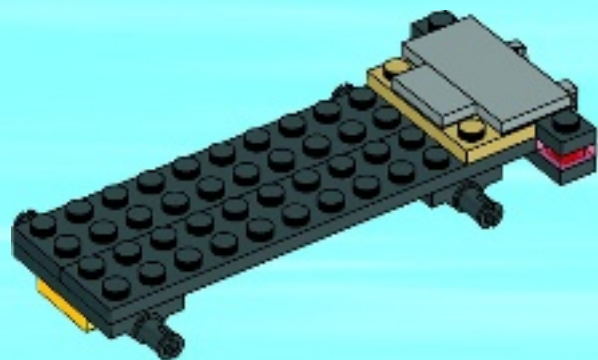

1x



2x



1x

# 11

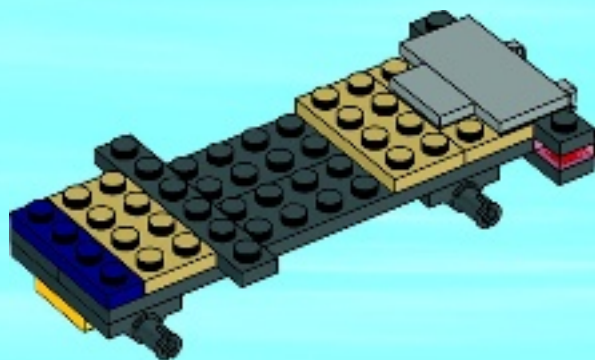



1x

12

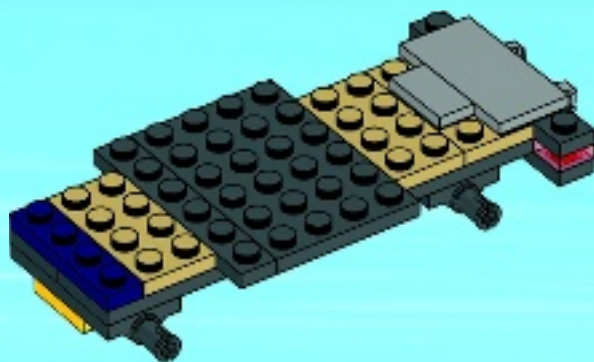



4x

# 13

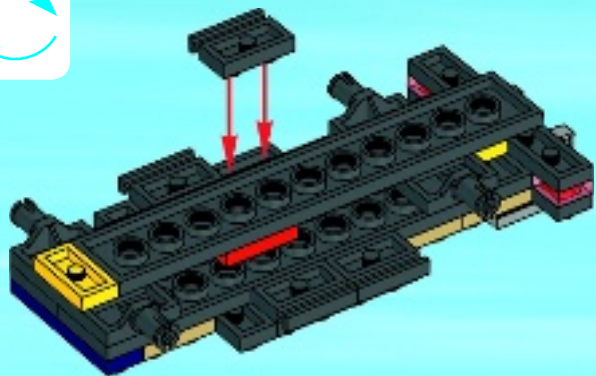

2x

# 14

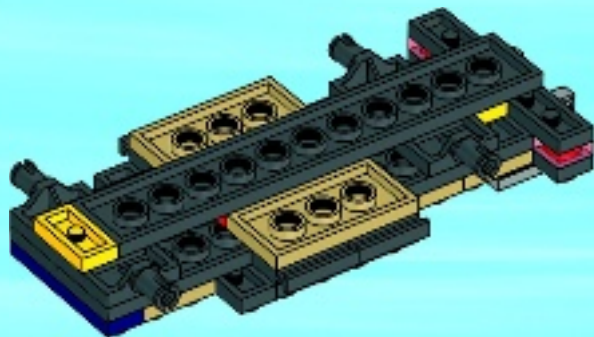



1x

# 15

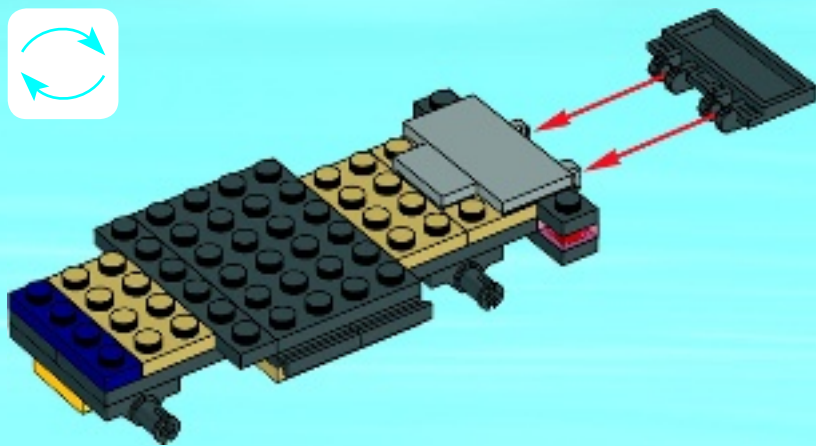



2x

# 16

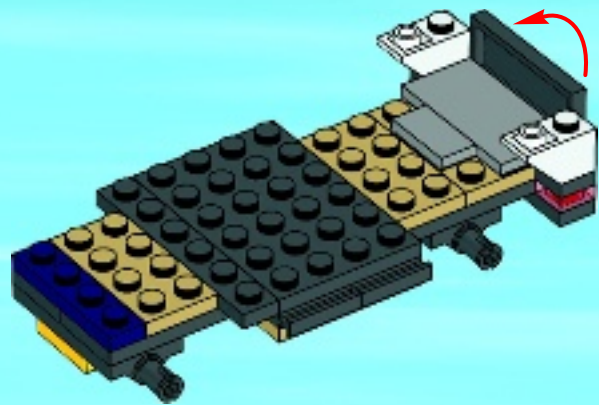

1x



1x

# 17

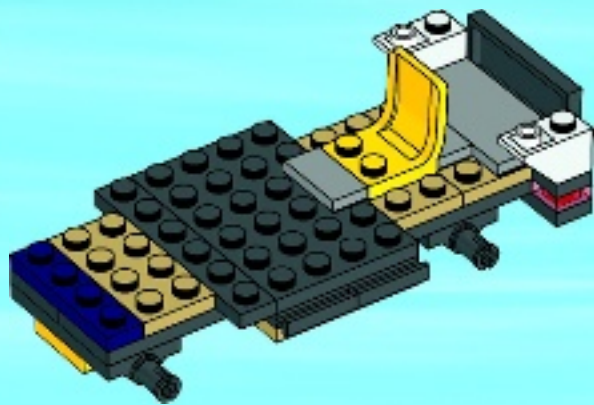



2x

18

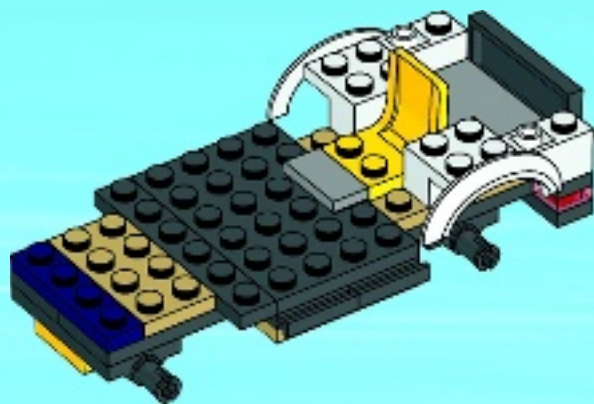



2x

# 19

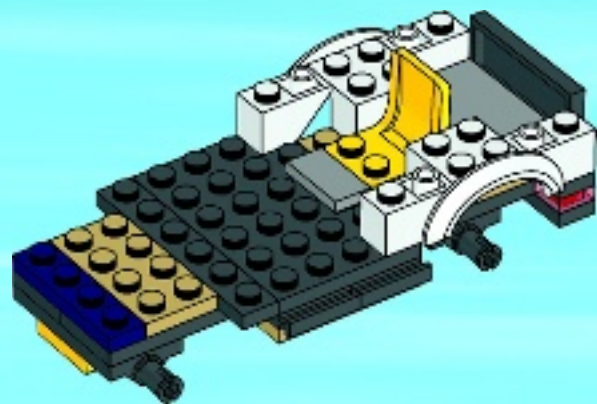

1x



1x

# 20

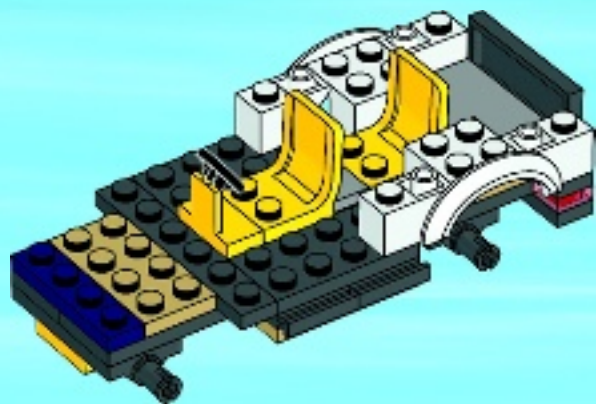



2x



2x

# 21

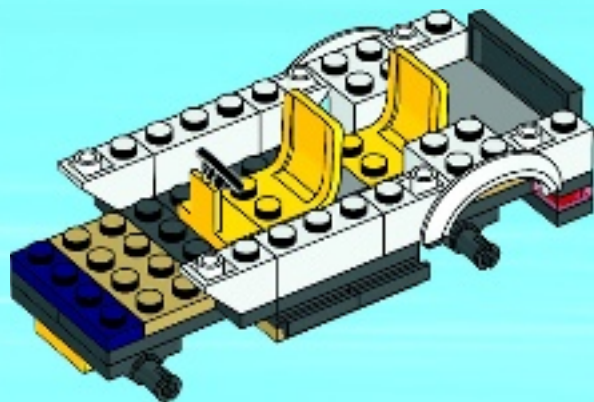





1x

# 22

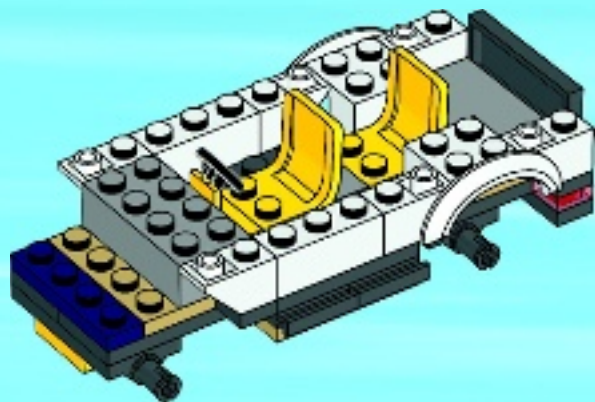

1x



1x

# 23

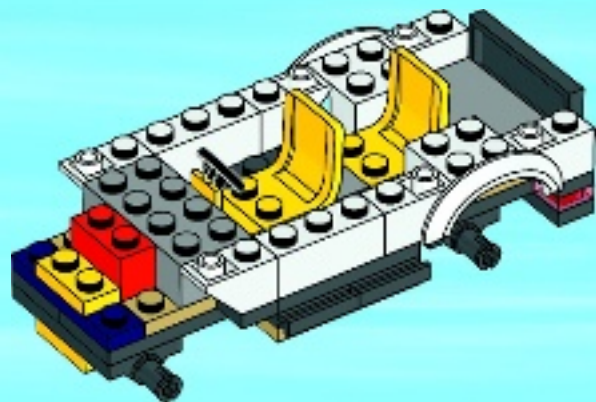



2x

24

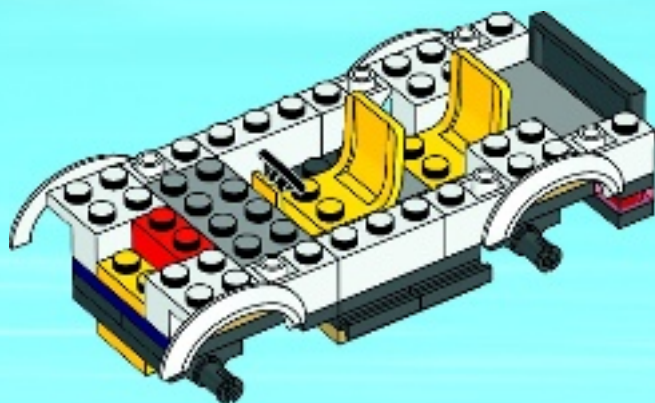



2x

# 25

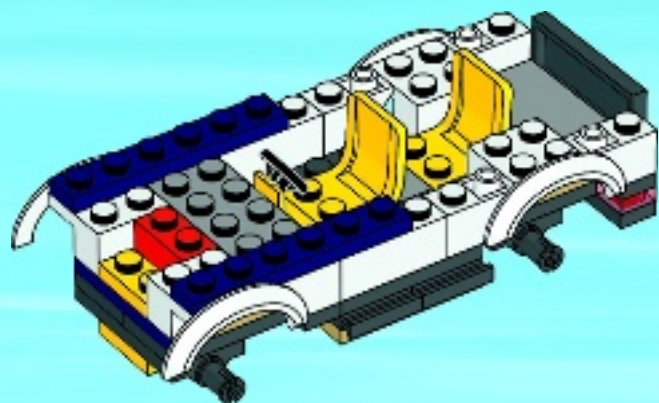

2x



2x

# 26

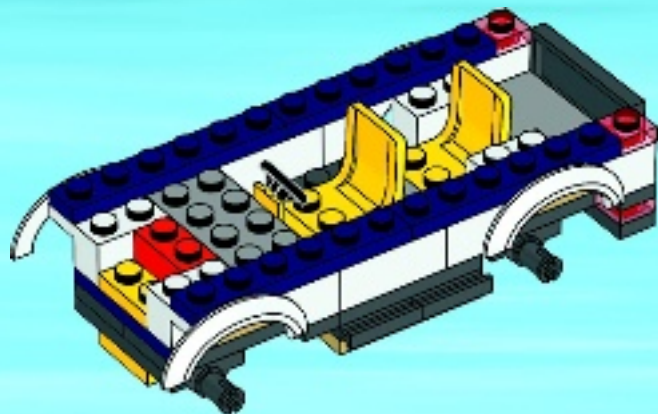



2x



2x

27

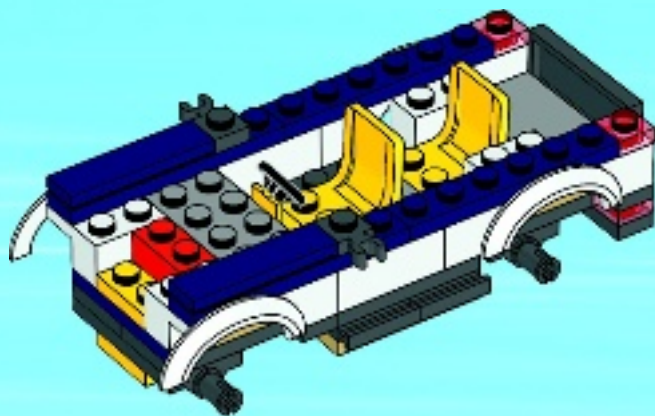



2x

# 28

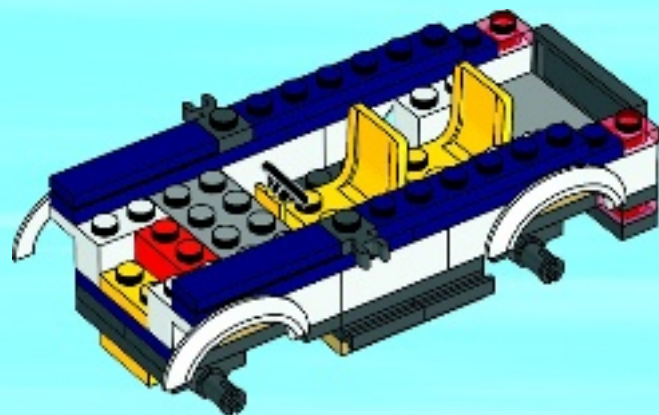

1x



1x

# 29

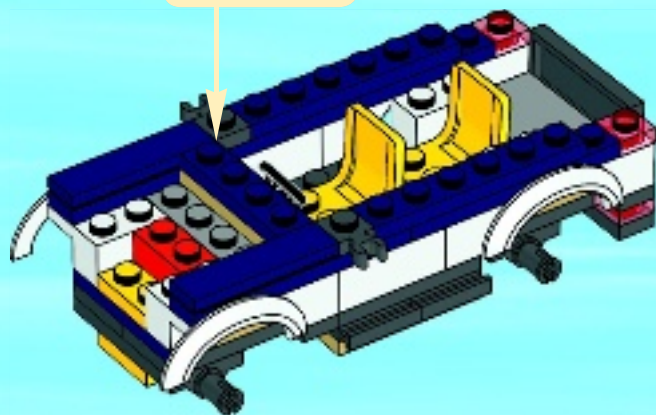
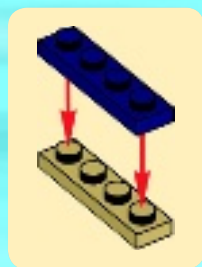

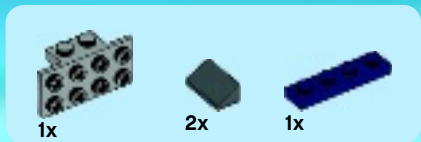

# 30

1



2

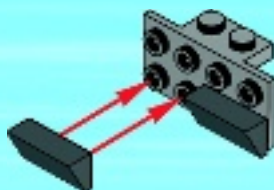

3

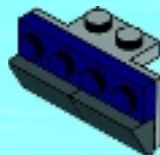

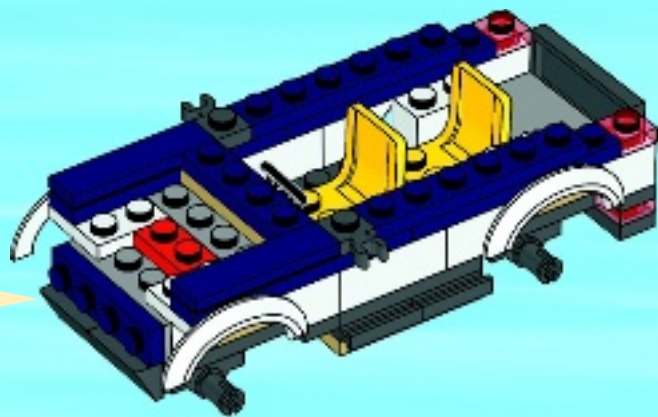



1x

31

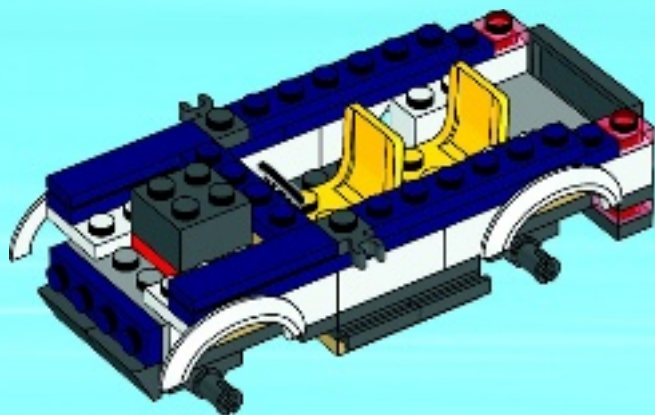





1x



1x

# 32

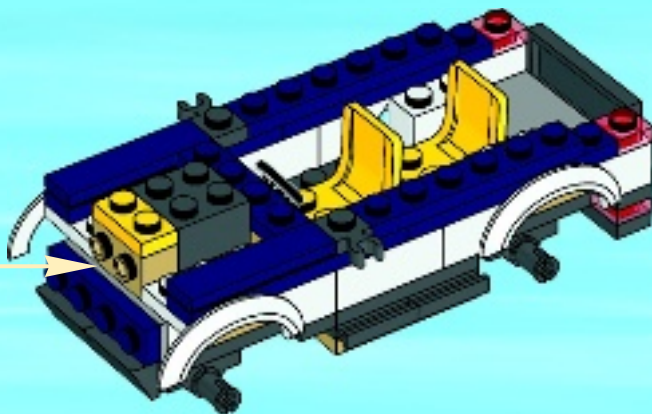
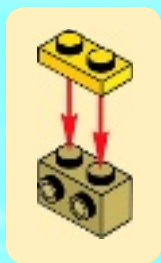



33

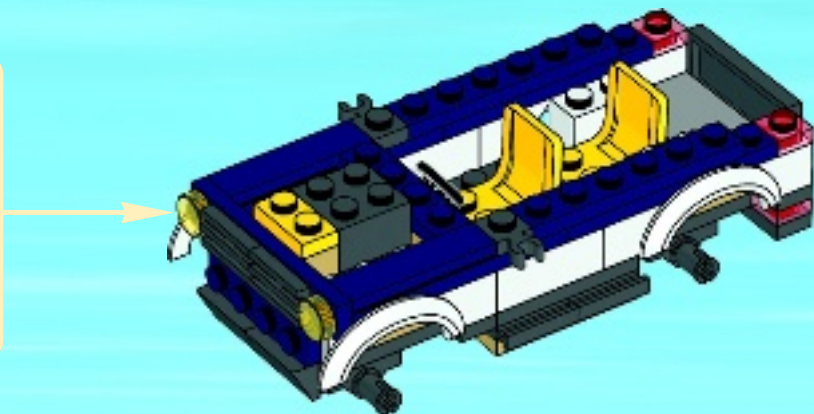
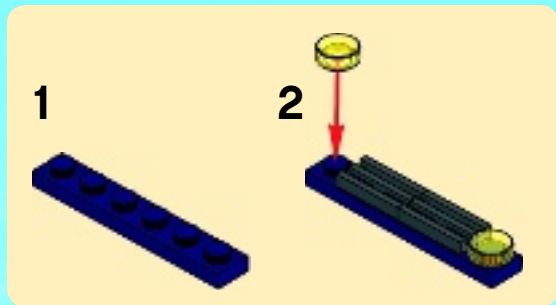



2x



1x



1x



4x

# 34

1



2

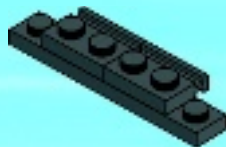

3



4

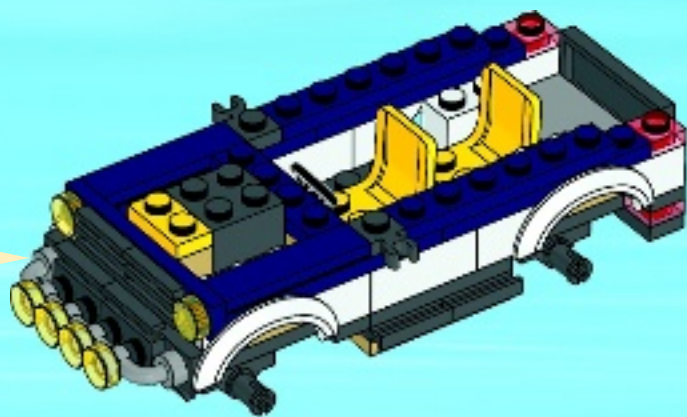



2x

35

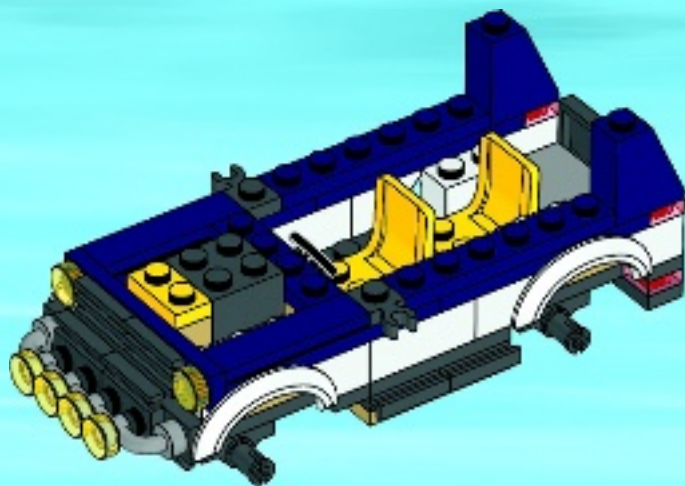



1x

36

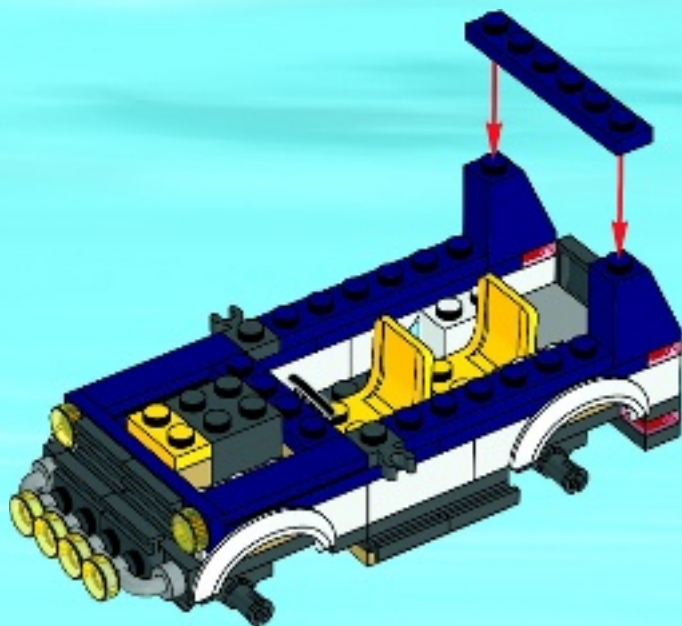



4x

37



2x

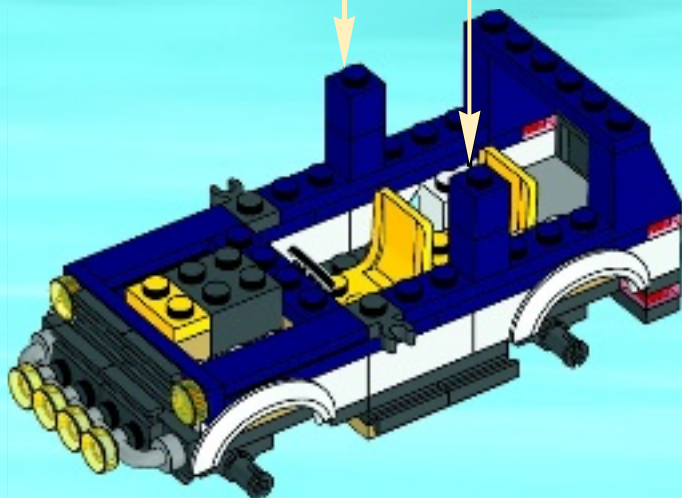

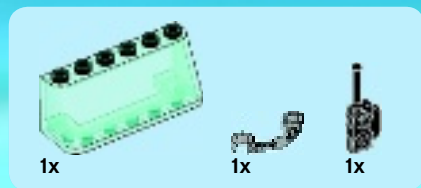

38

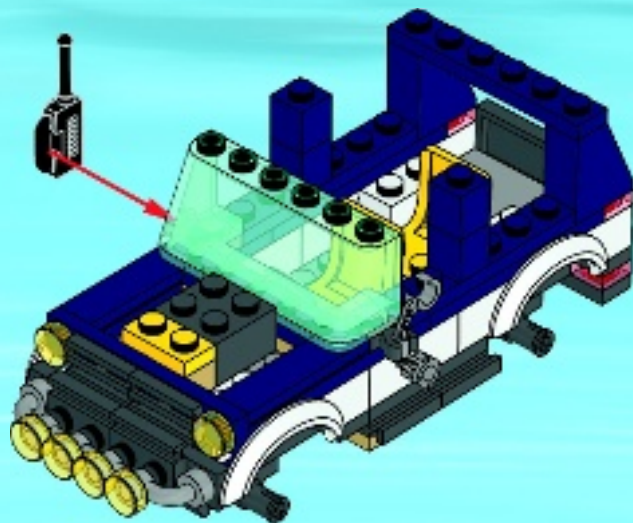



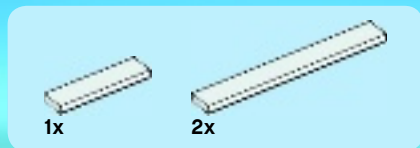

39

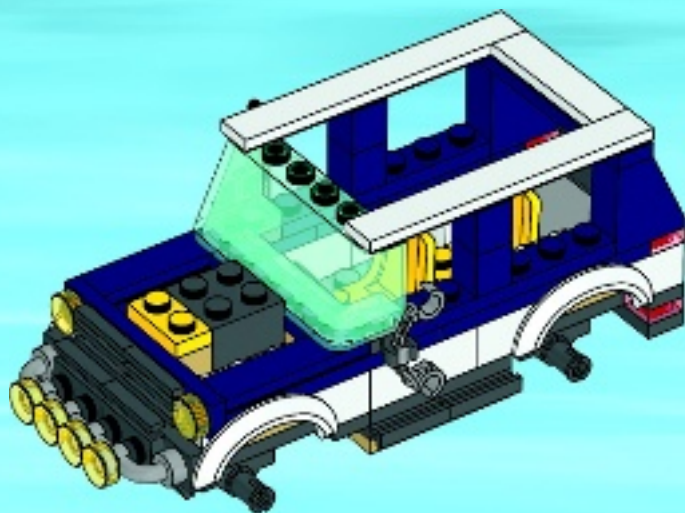



4x



2x

# 40

1



2



2x

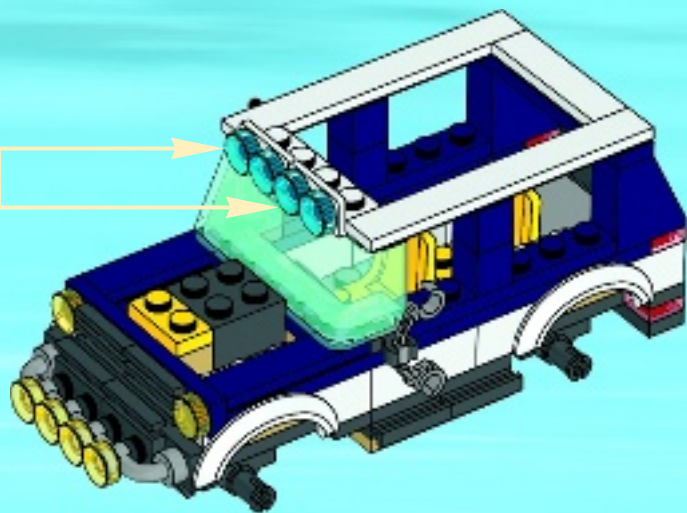



1x

# 41

1



2

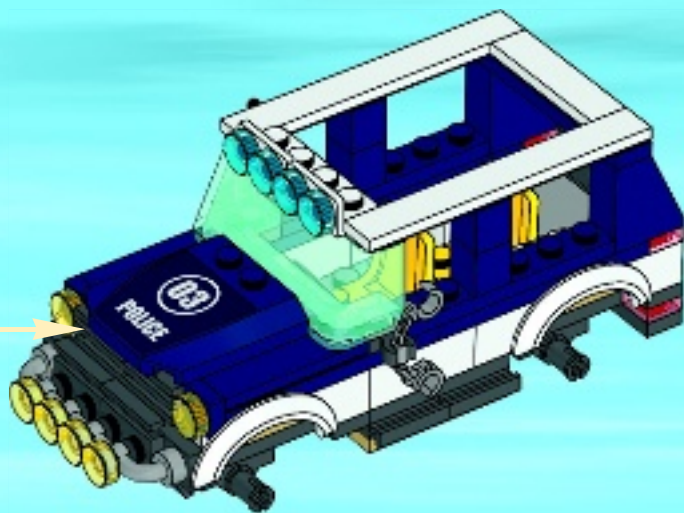



4x



4x

# 42

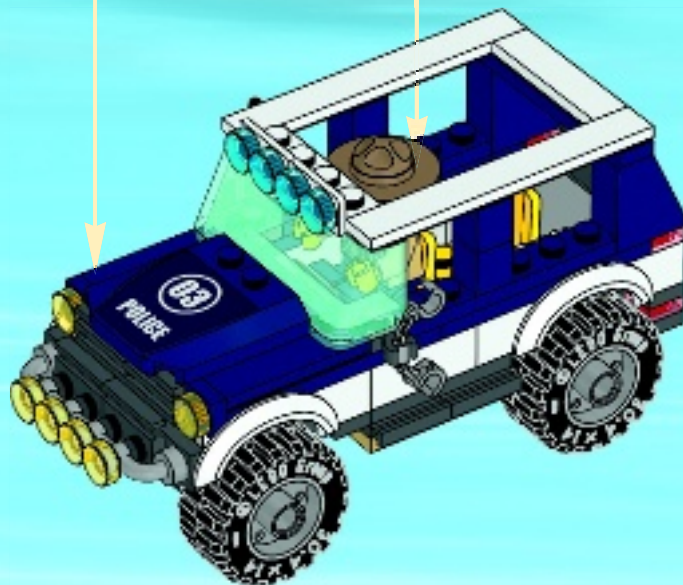

4x



# CITY

60069





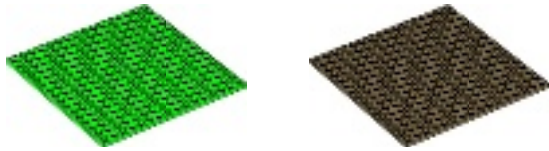

+

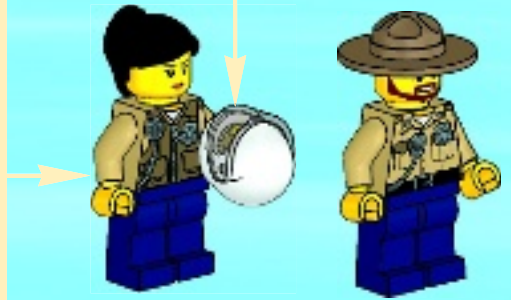
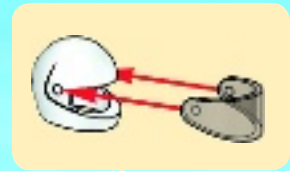
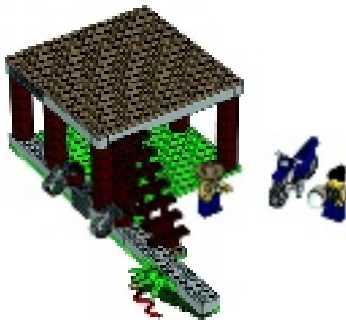



1x



2x

# 1

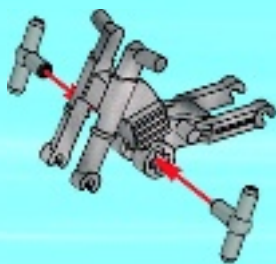

2x



2x

# 2



2x



1:1





1x

3



4

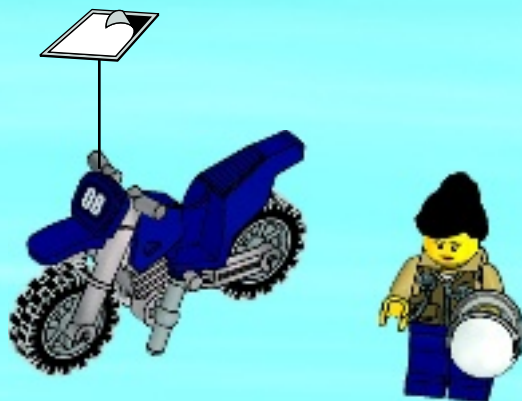

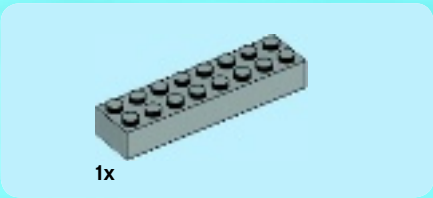

1x

**1**

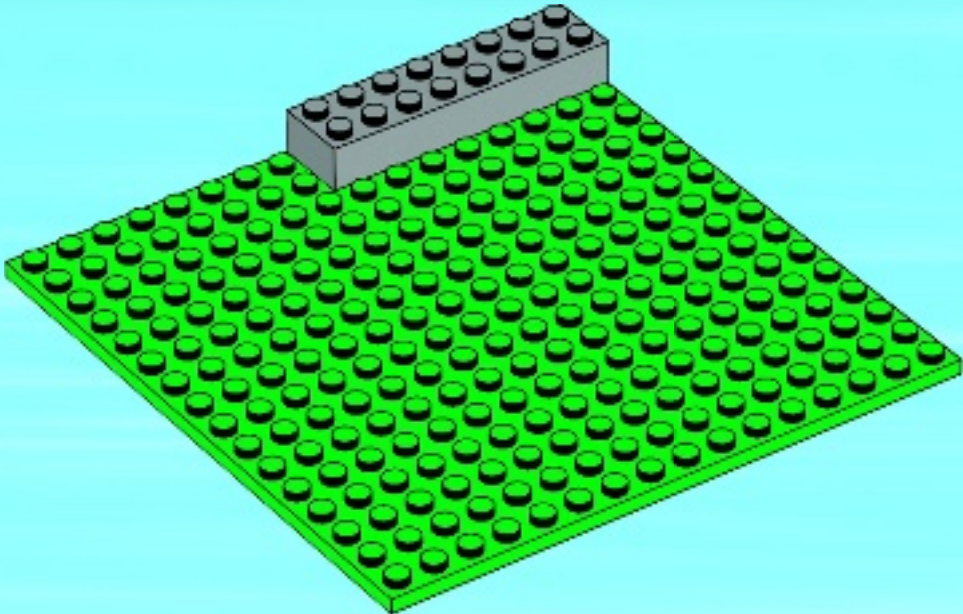



12x

2

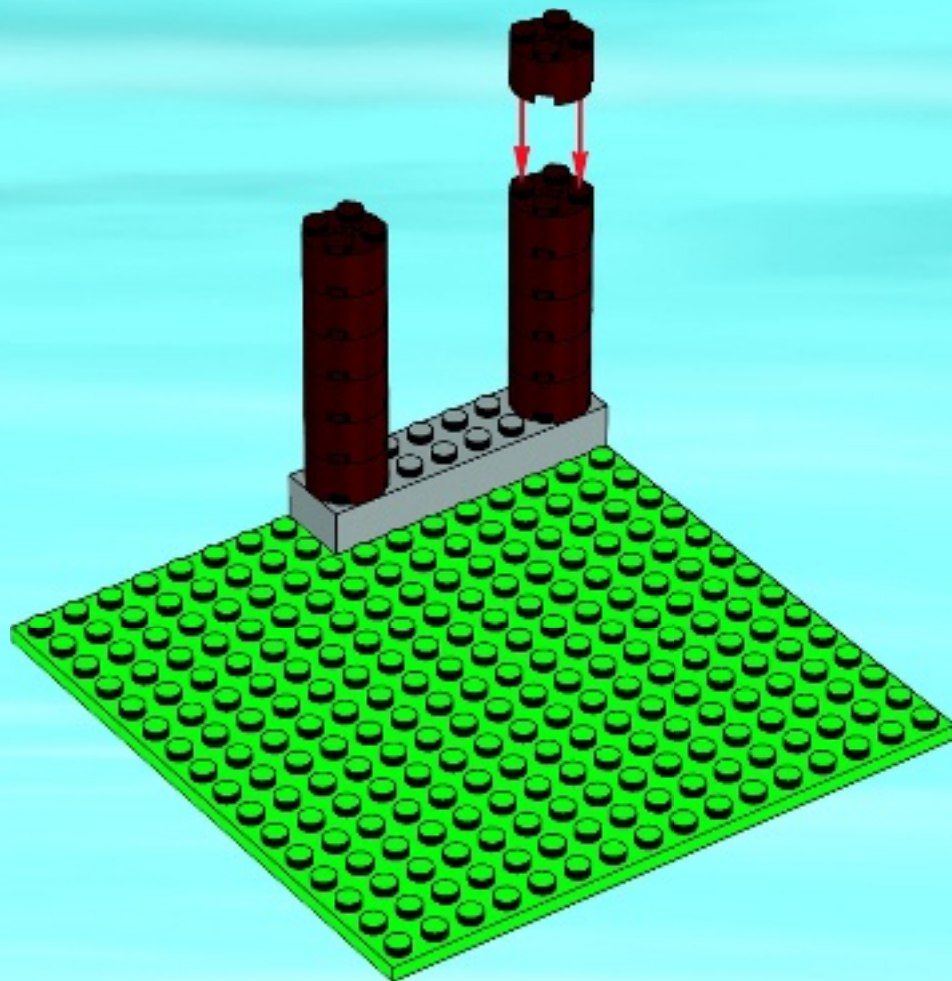



2x



1x

3

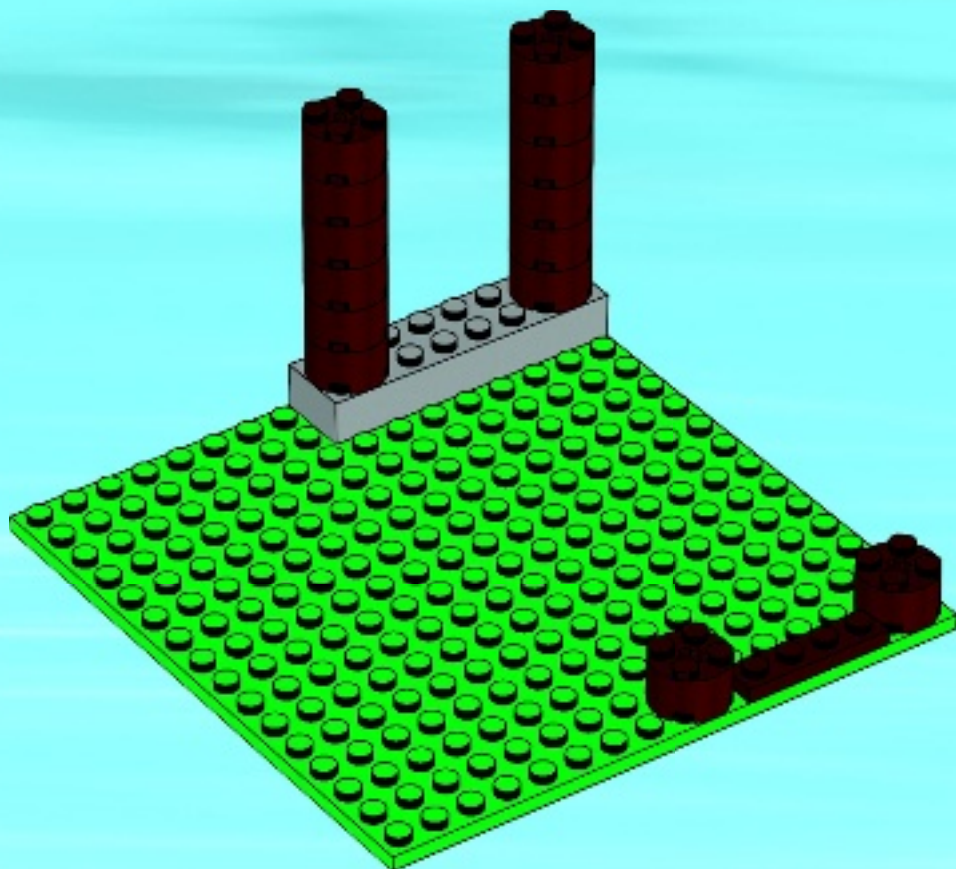



12x

4

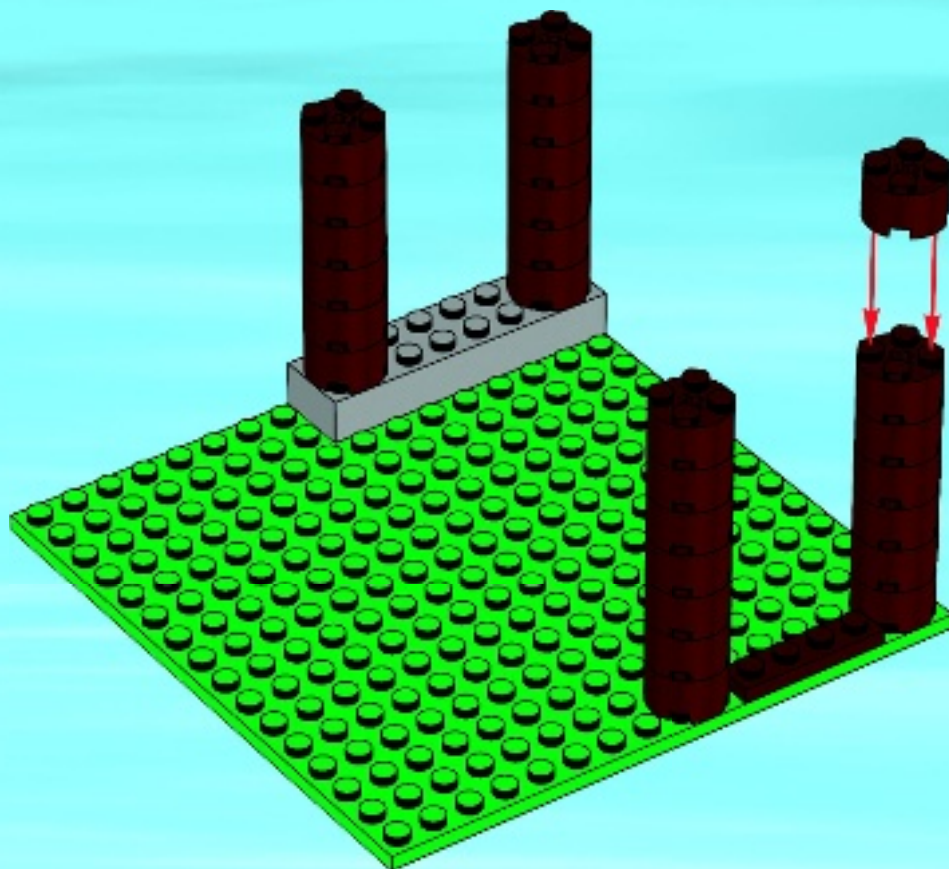

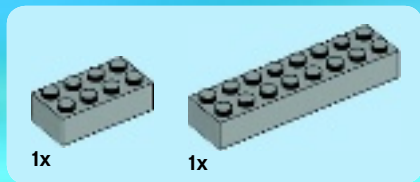

5

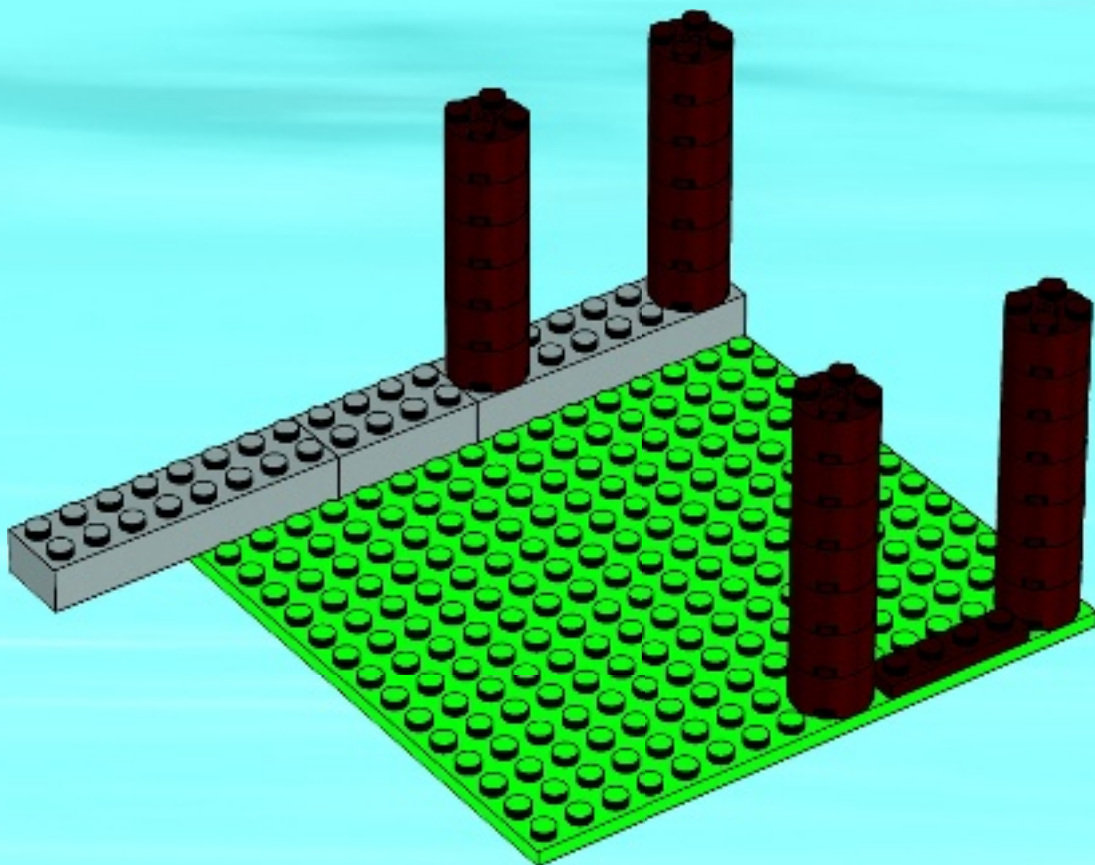



6x

6

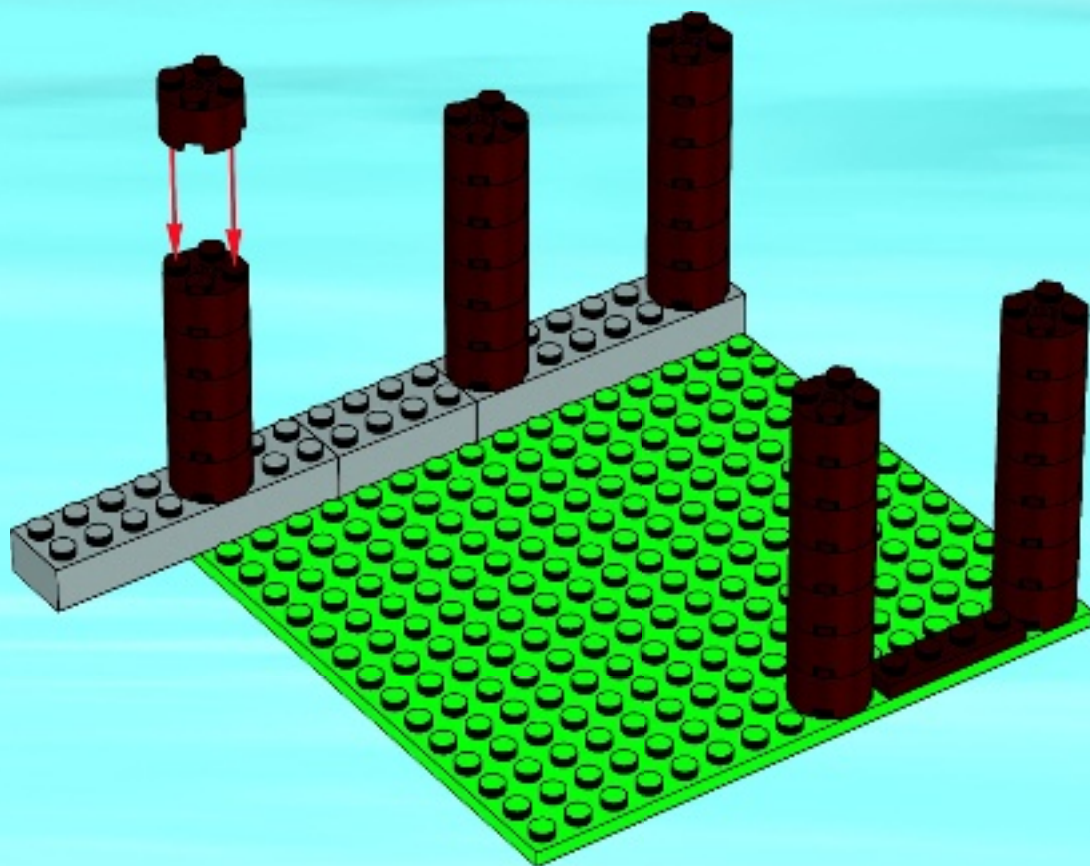



7x

7

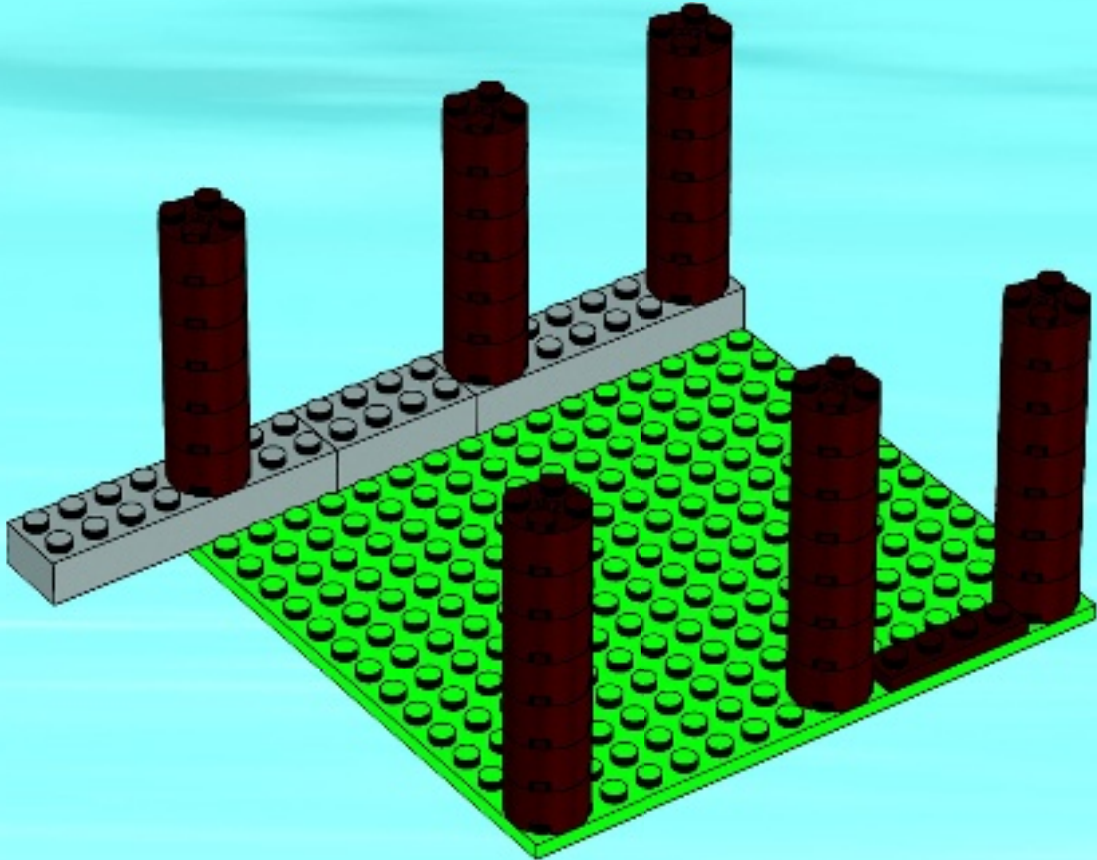



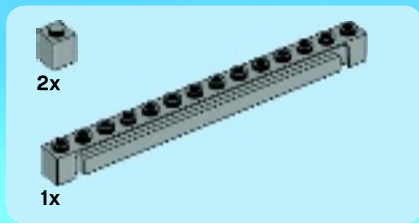

8

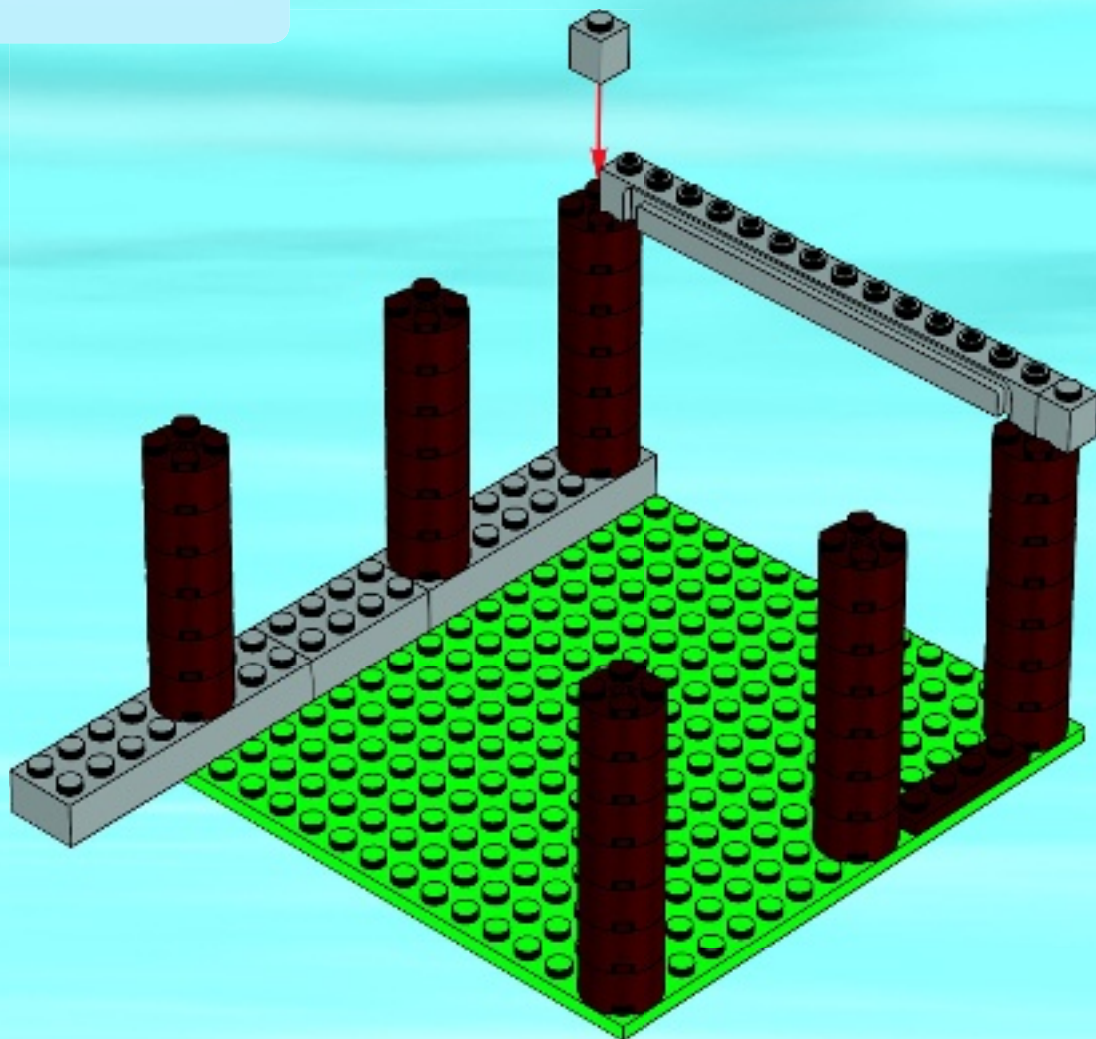



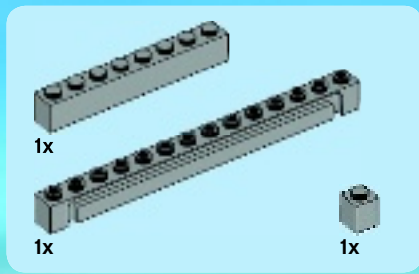

10

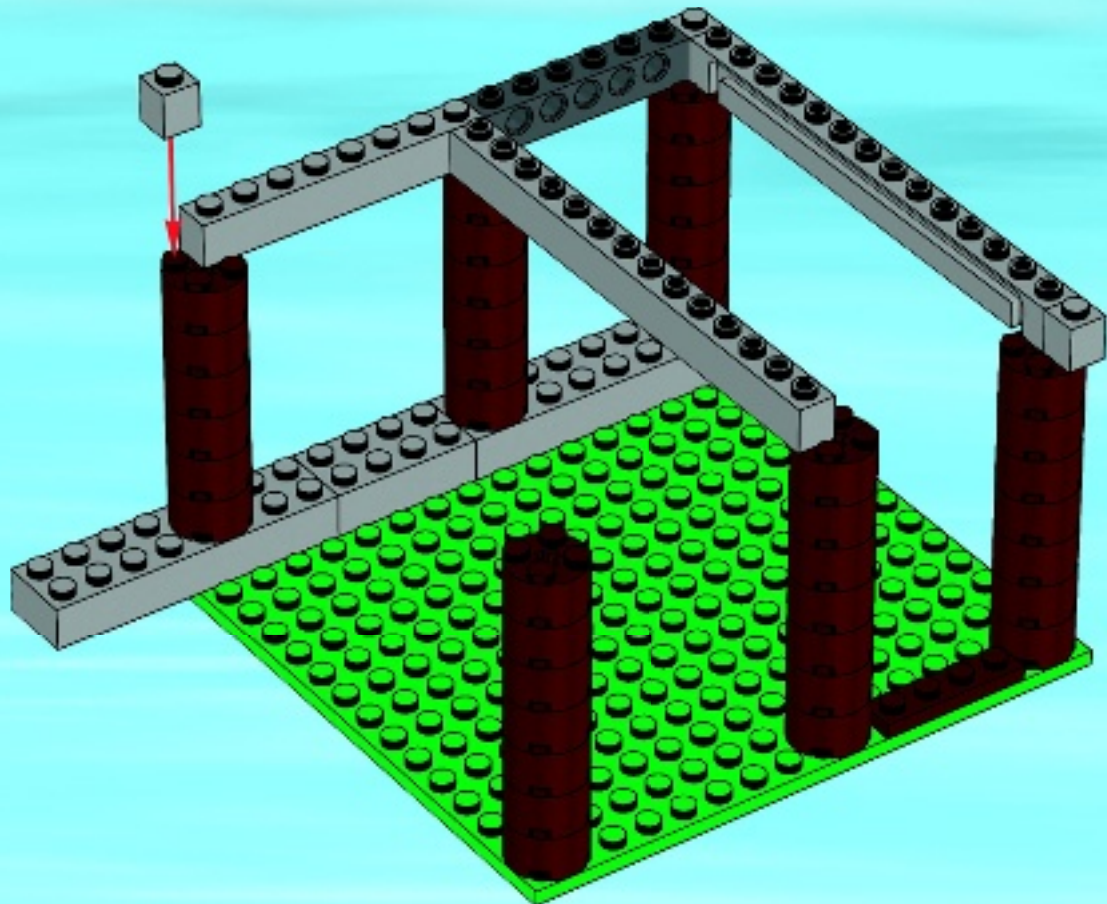

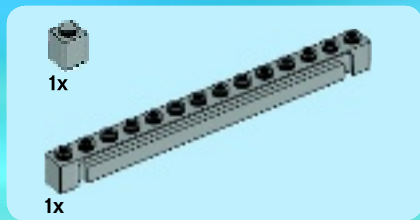

11

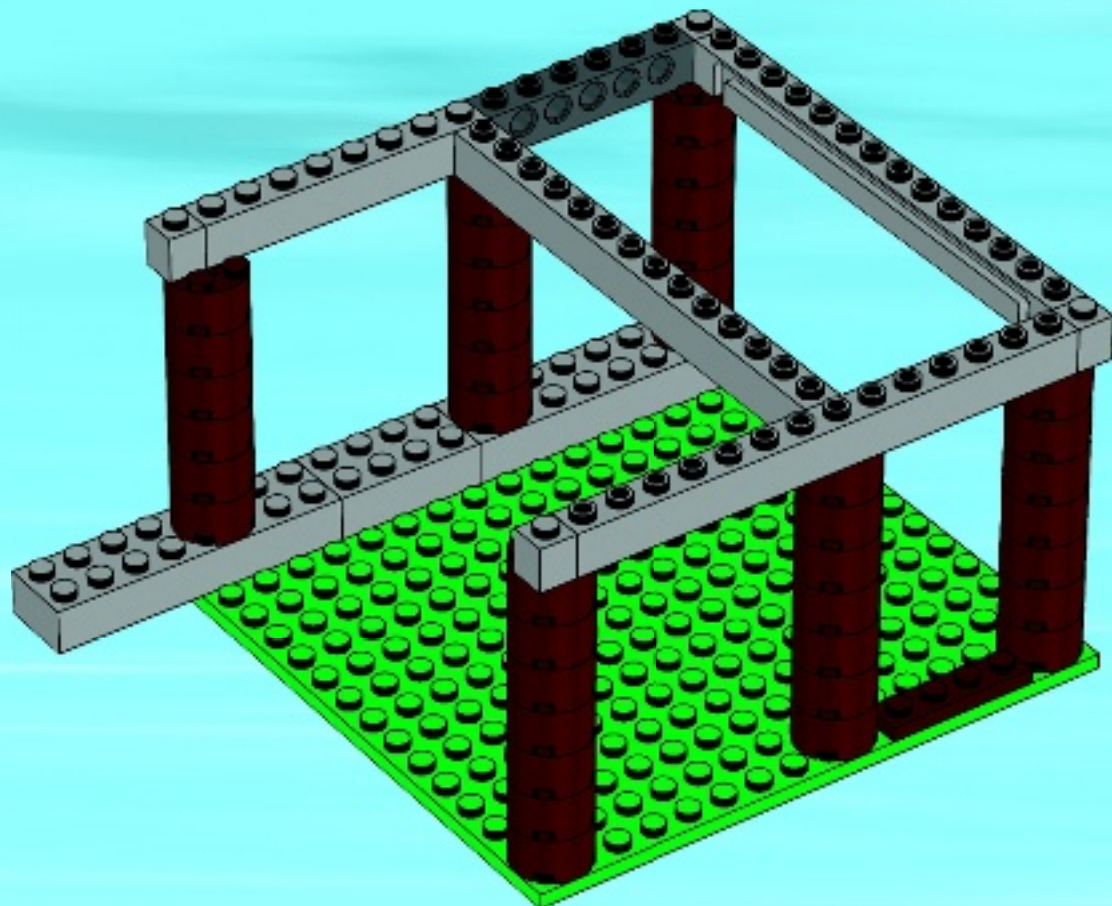

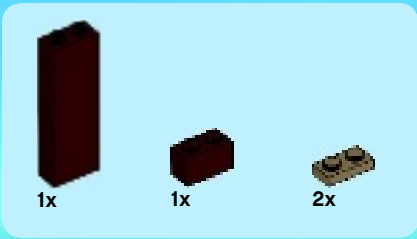

# 12

1

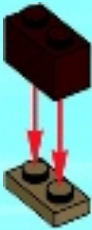

2



3



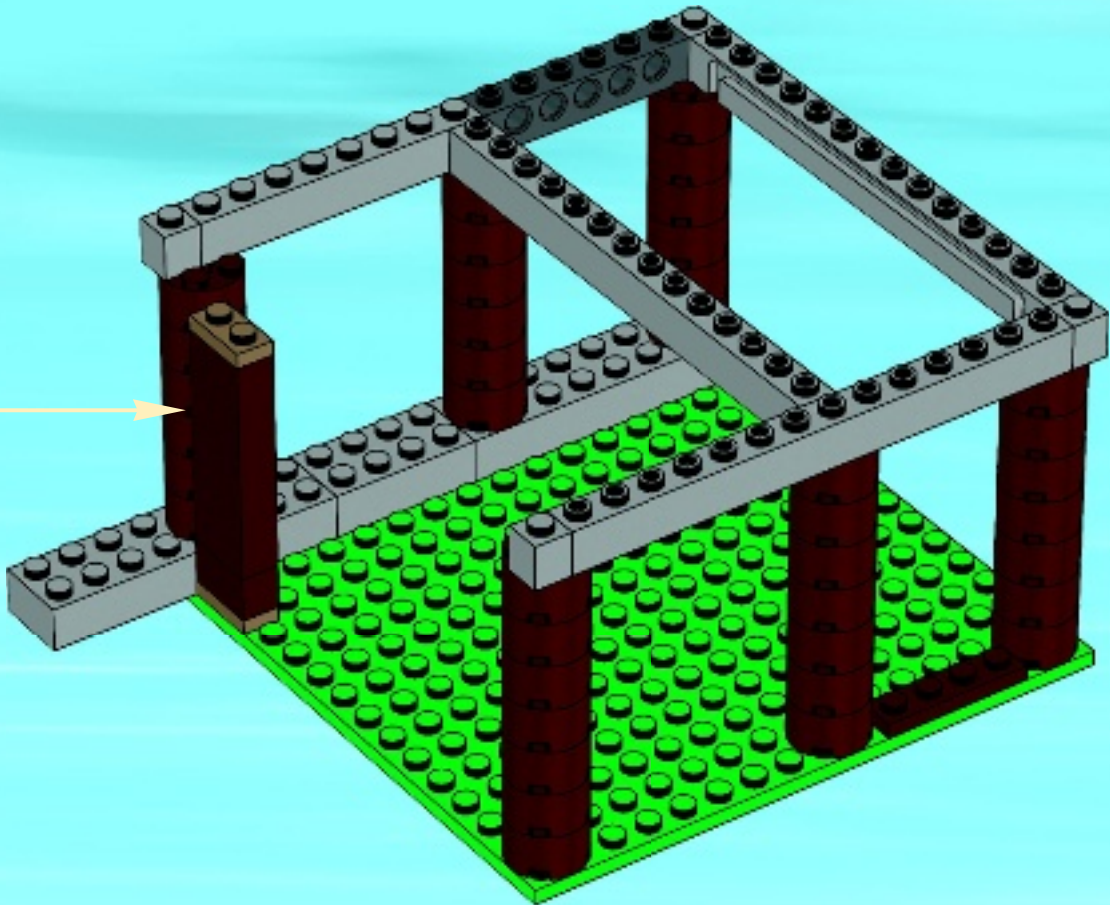

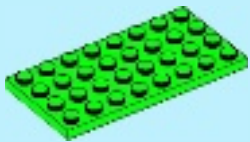

1x

# 13

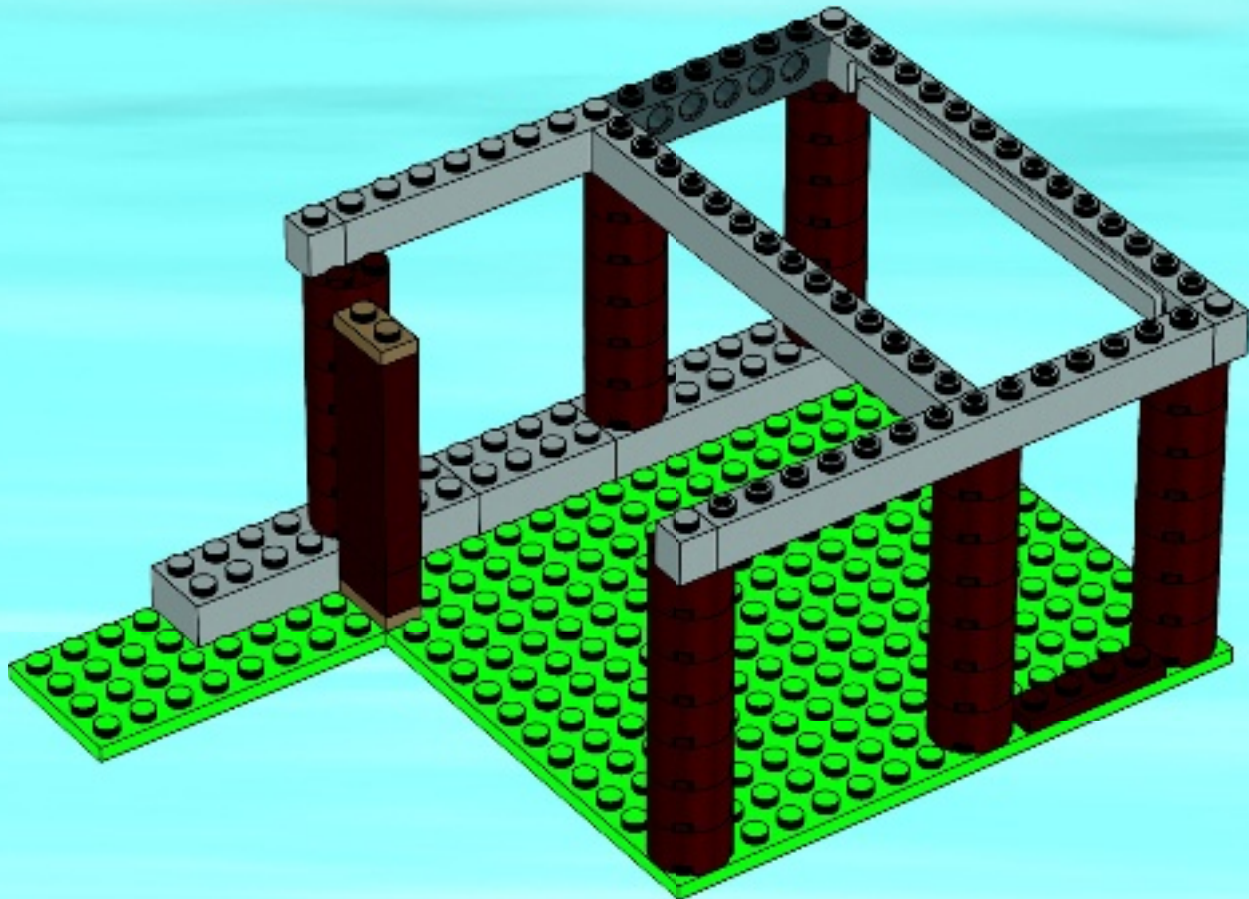

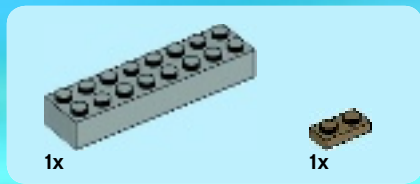

14

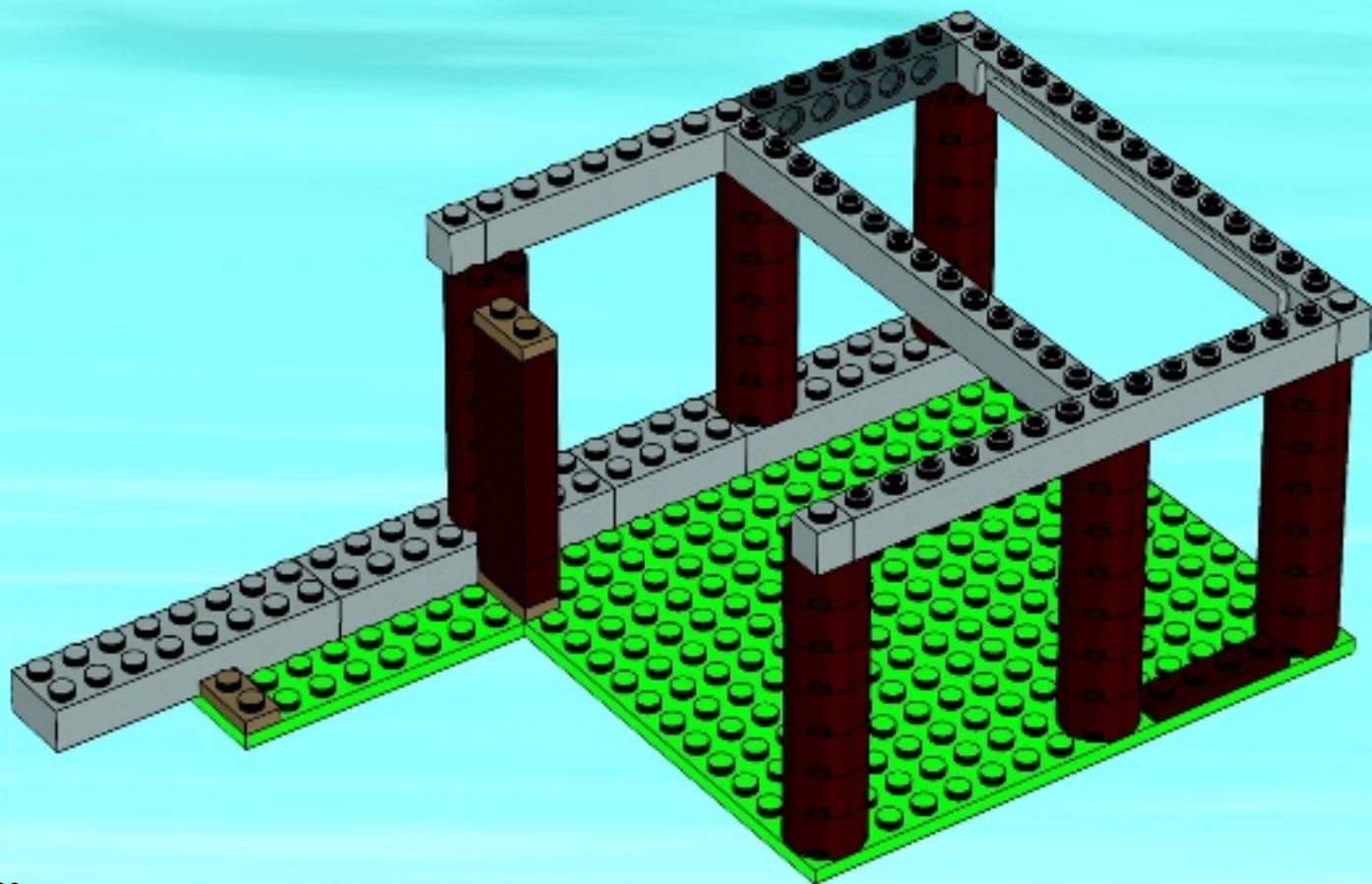



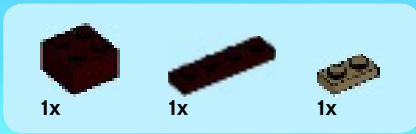

# 15

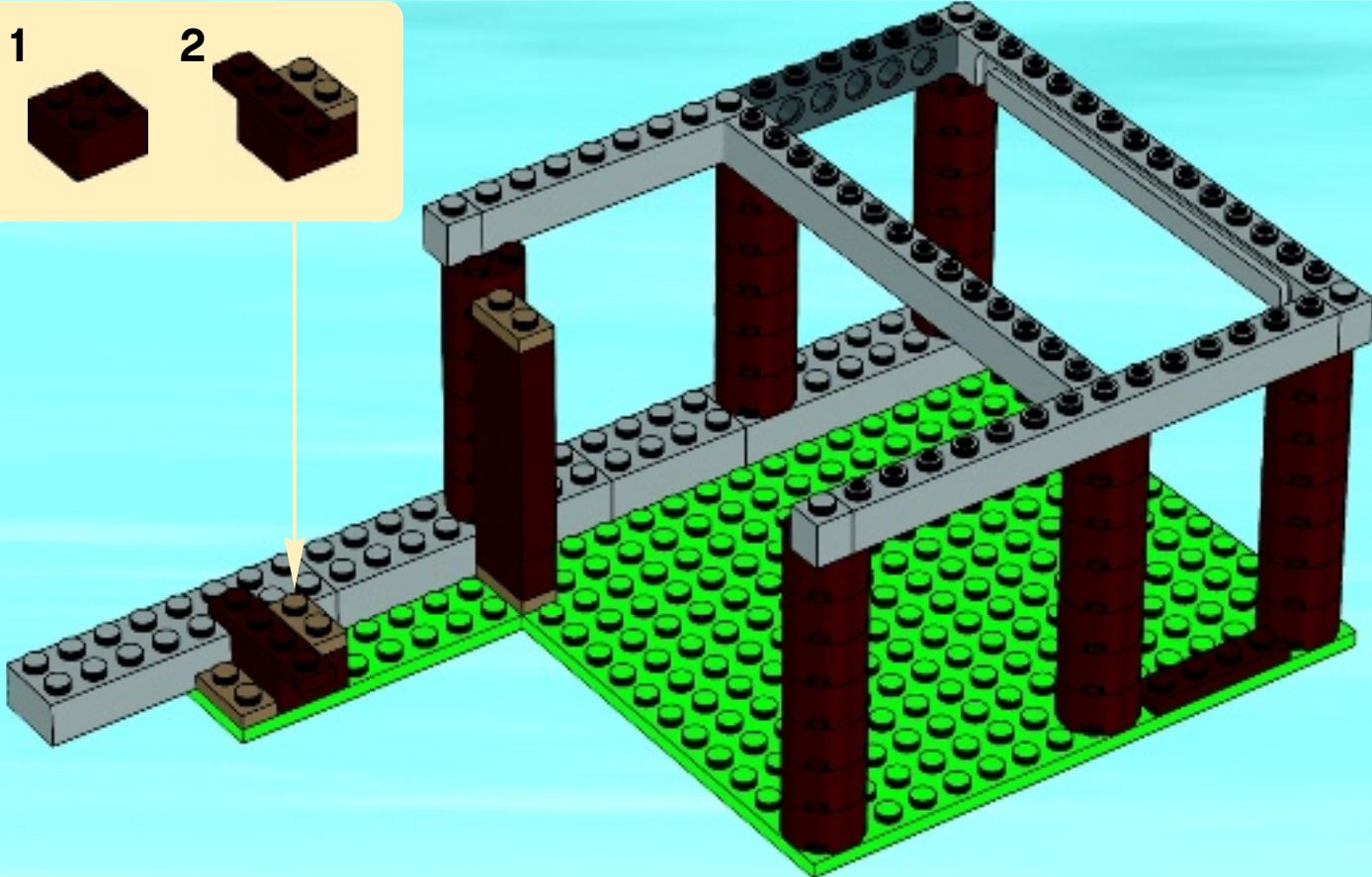
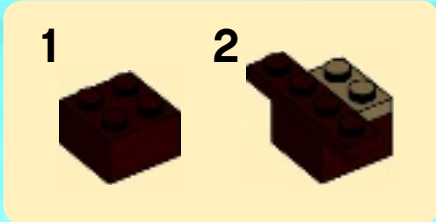

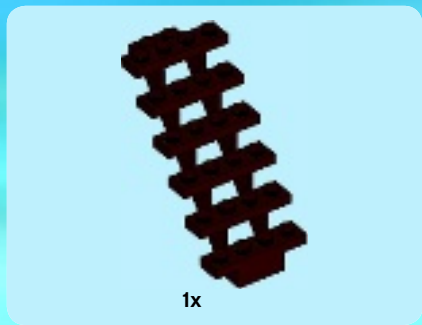

16

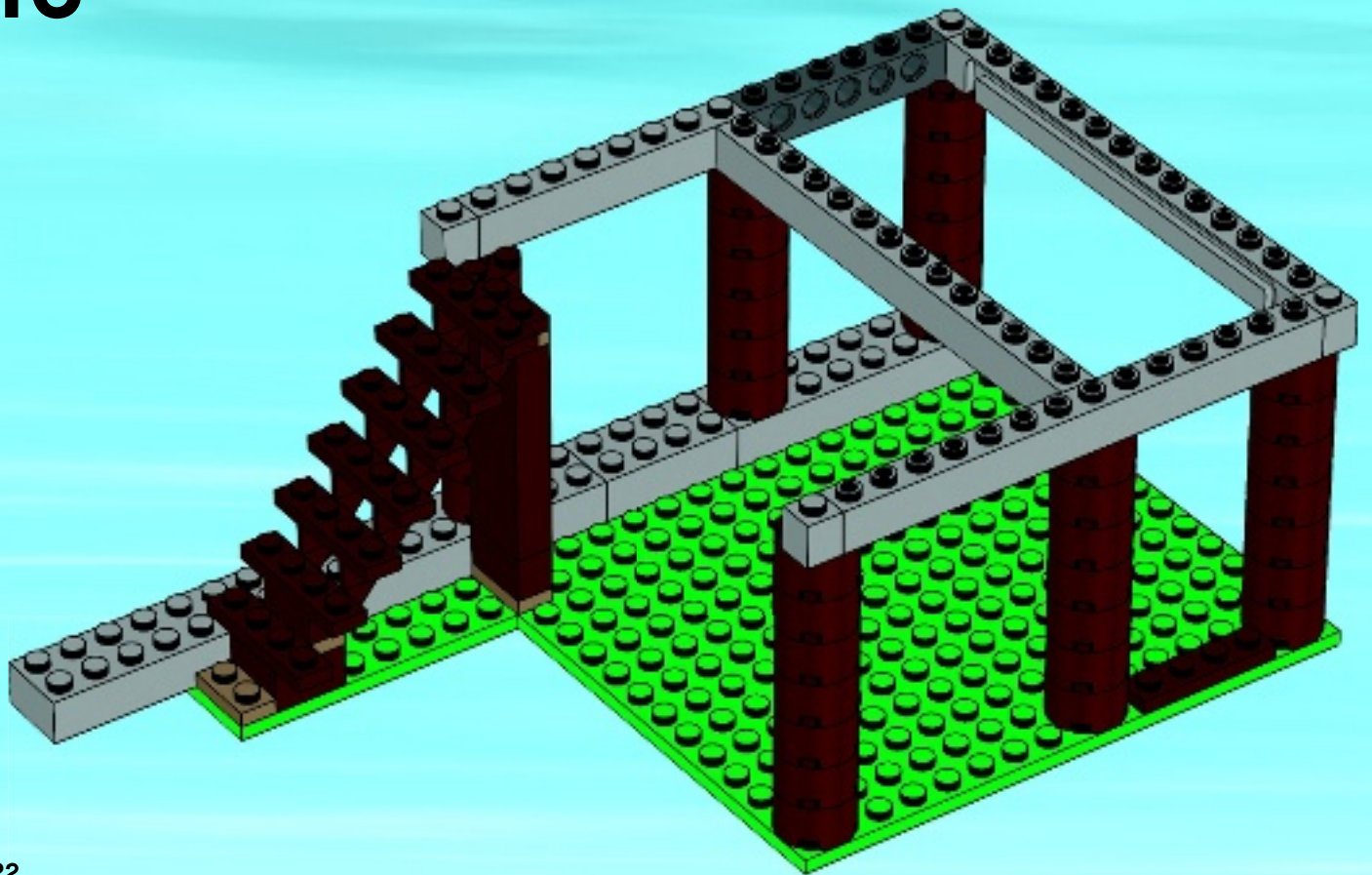

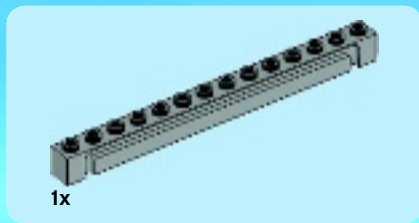

17

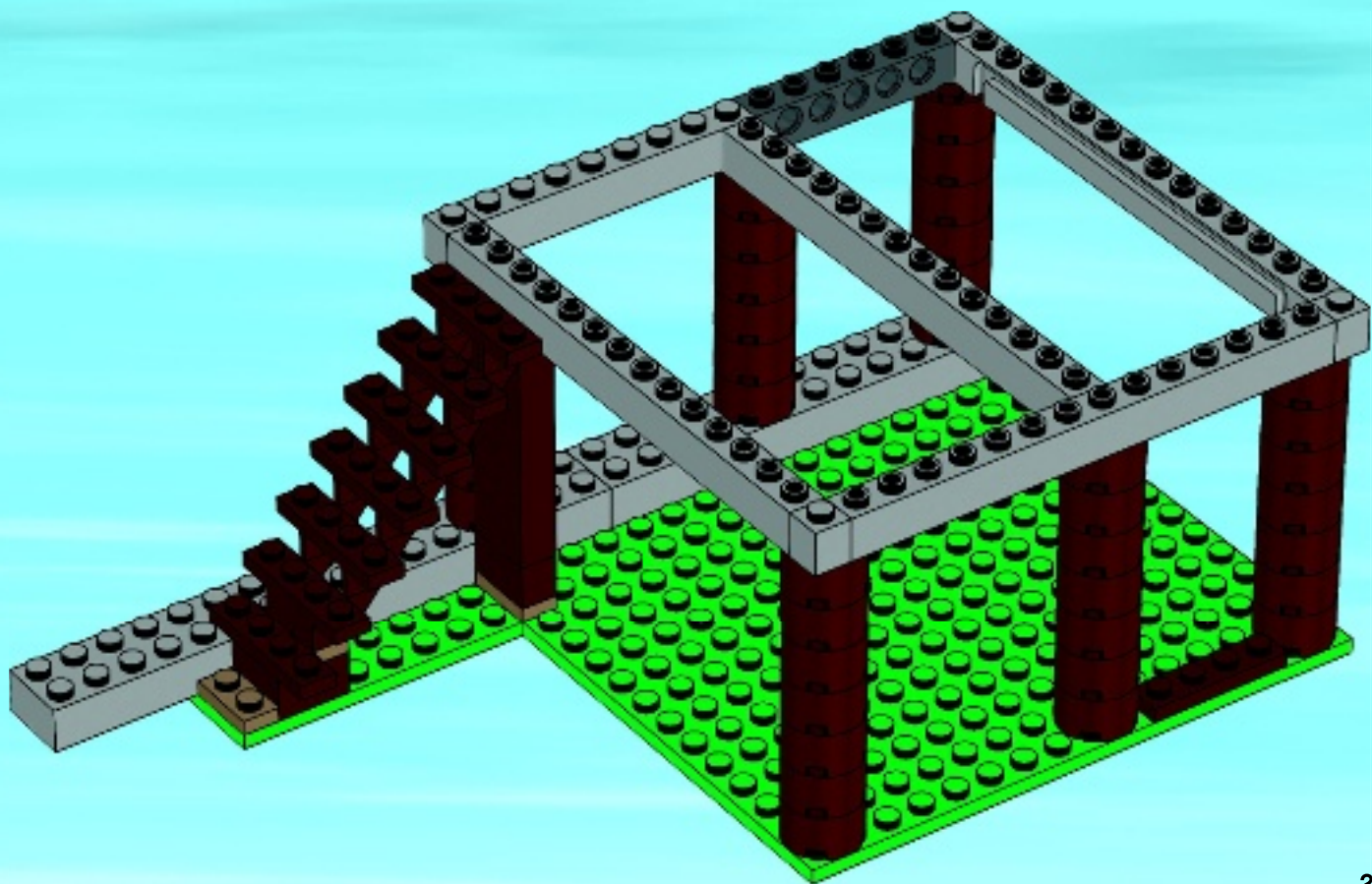



1x



1x

# 18

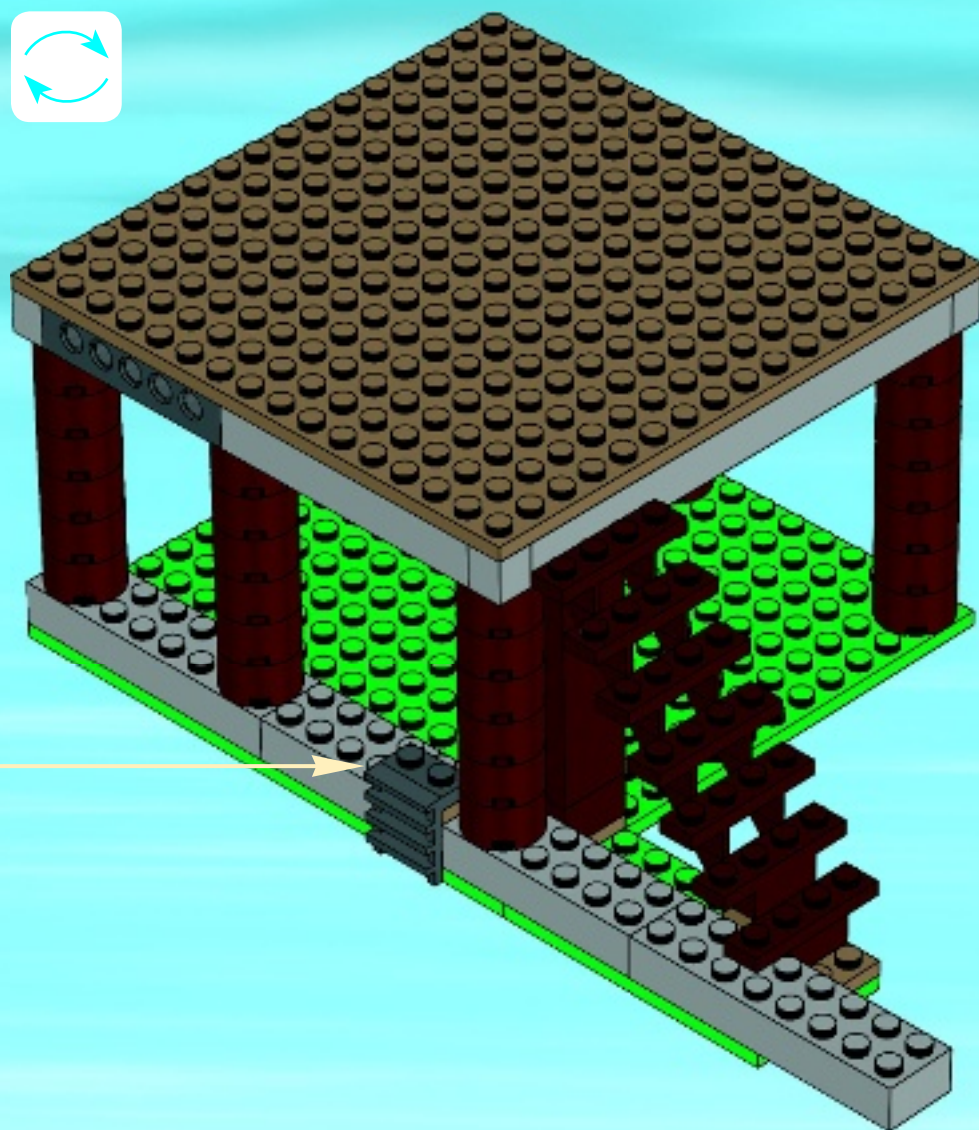



# 19

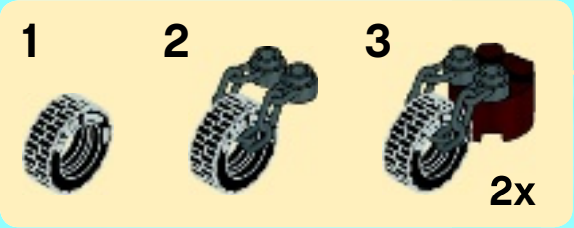
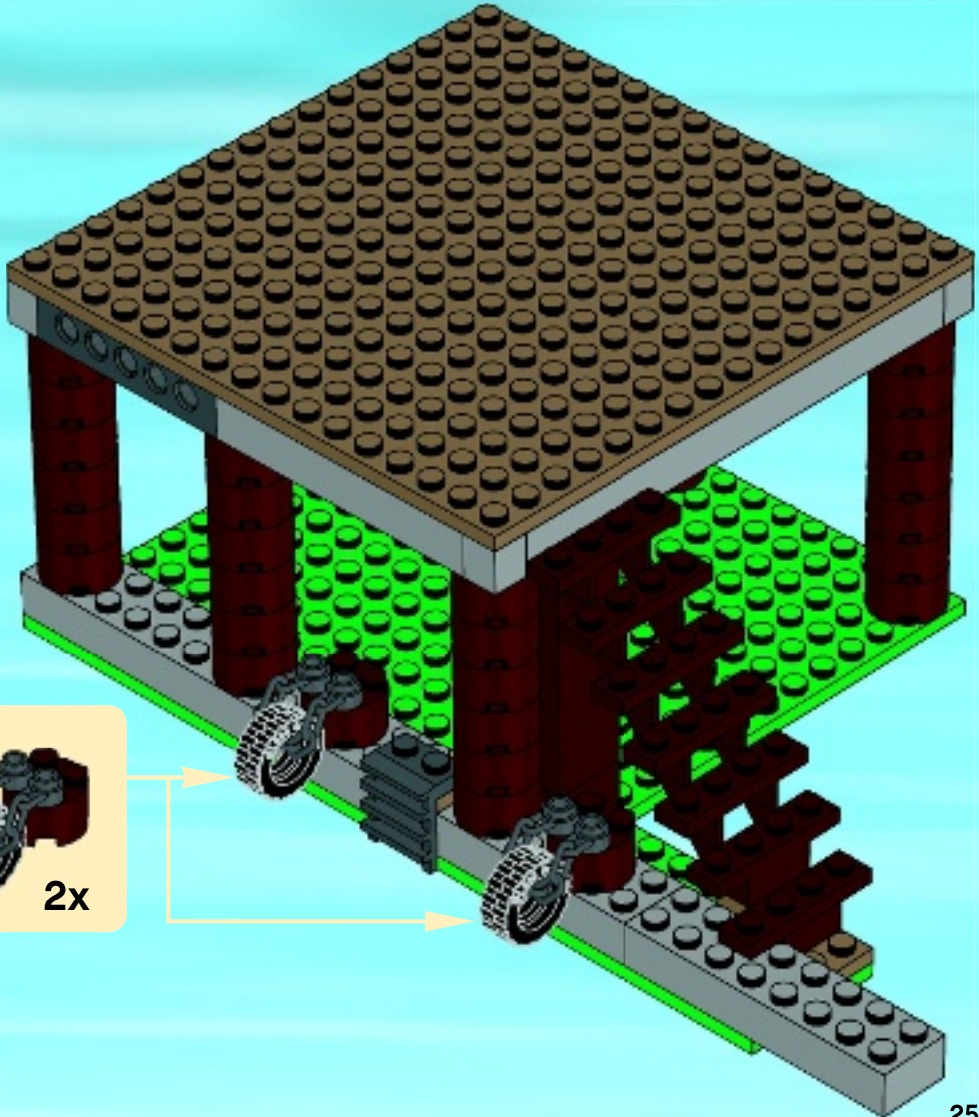

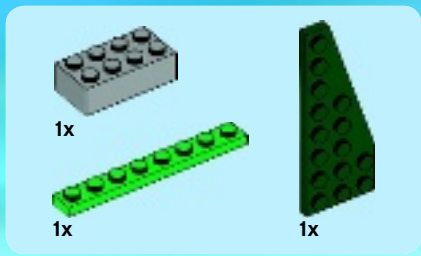

20

1

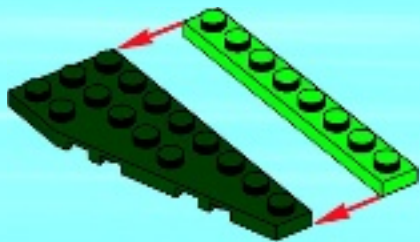

2

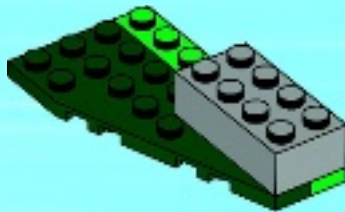

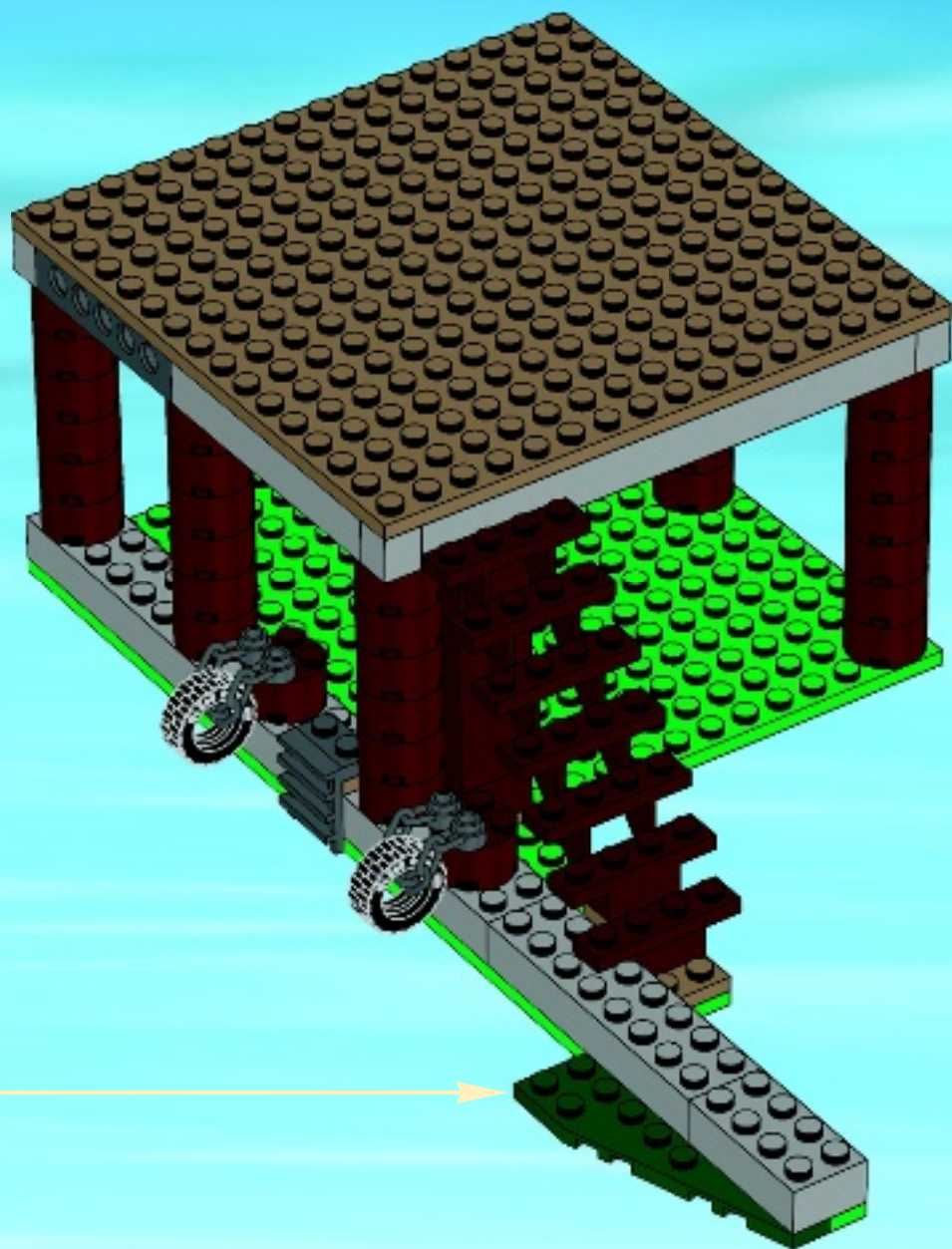



1x



2x

# 21

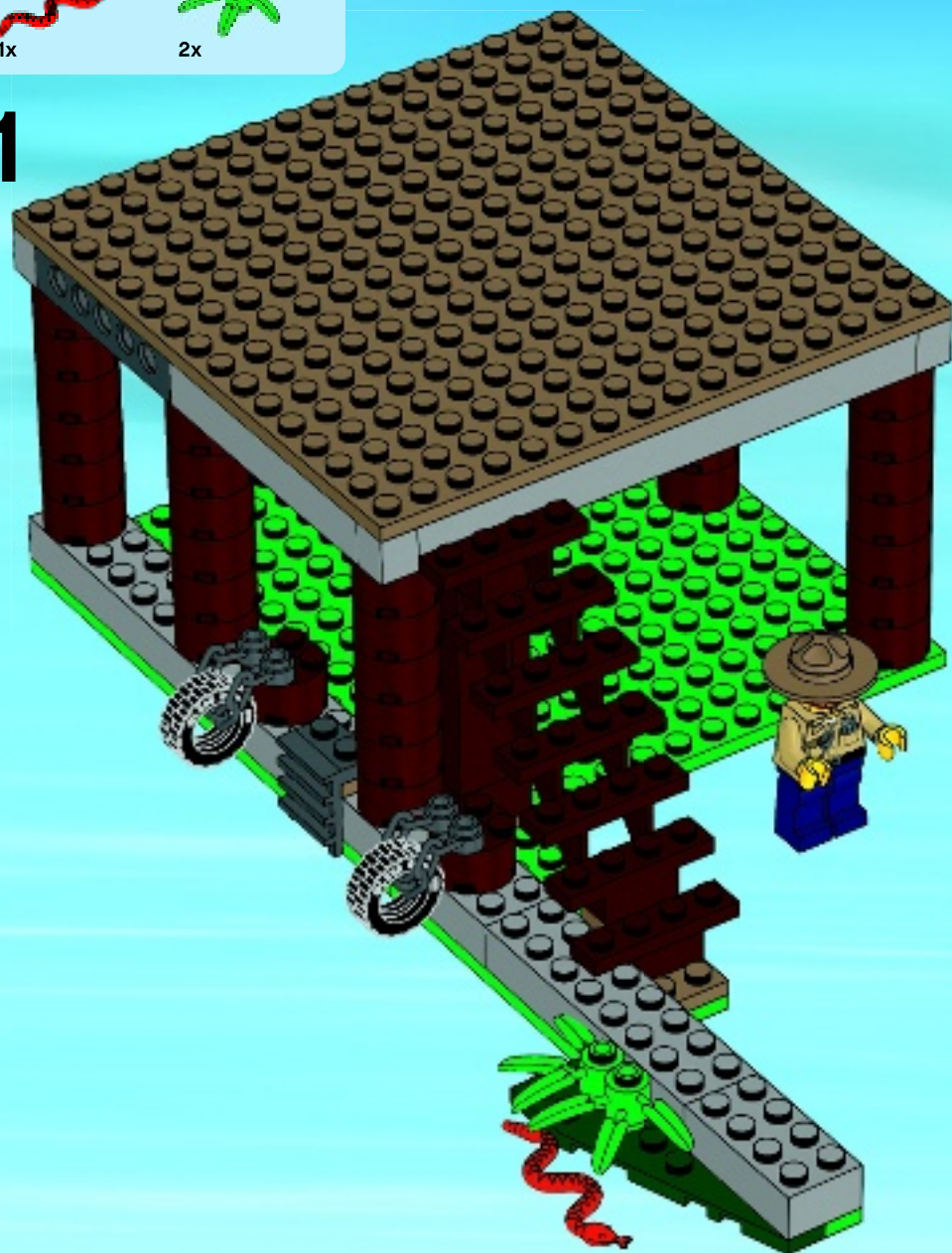





4

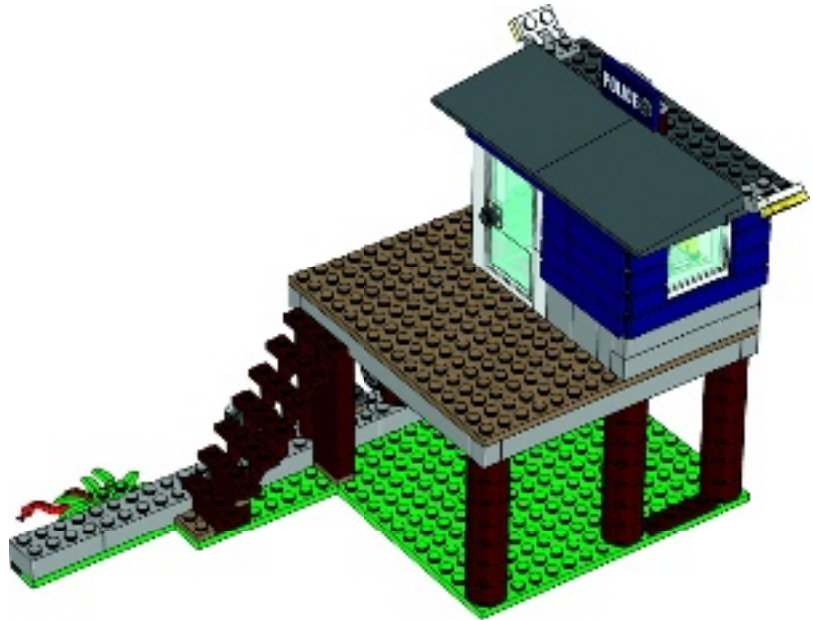



2x

# 22

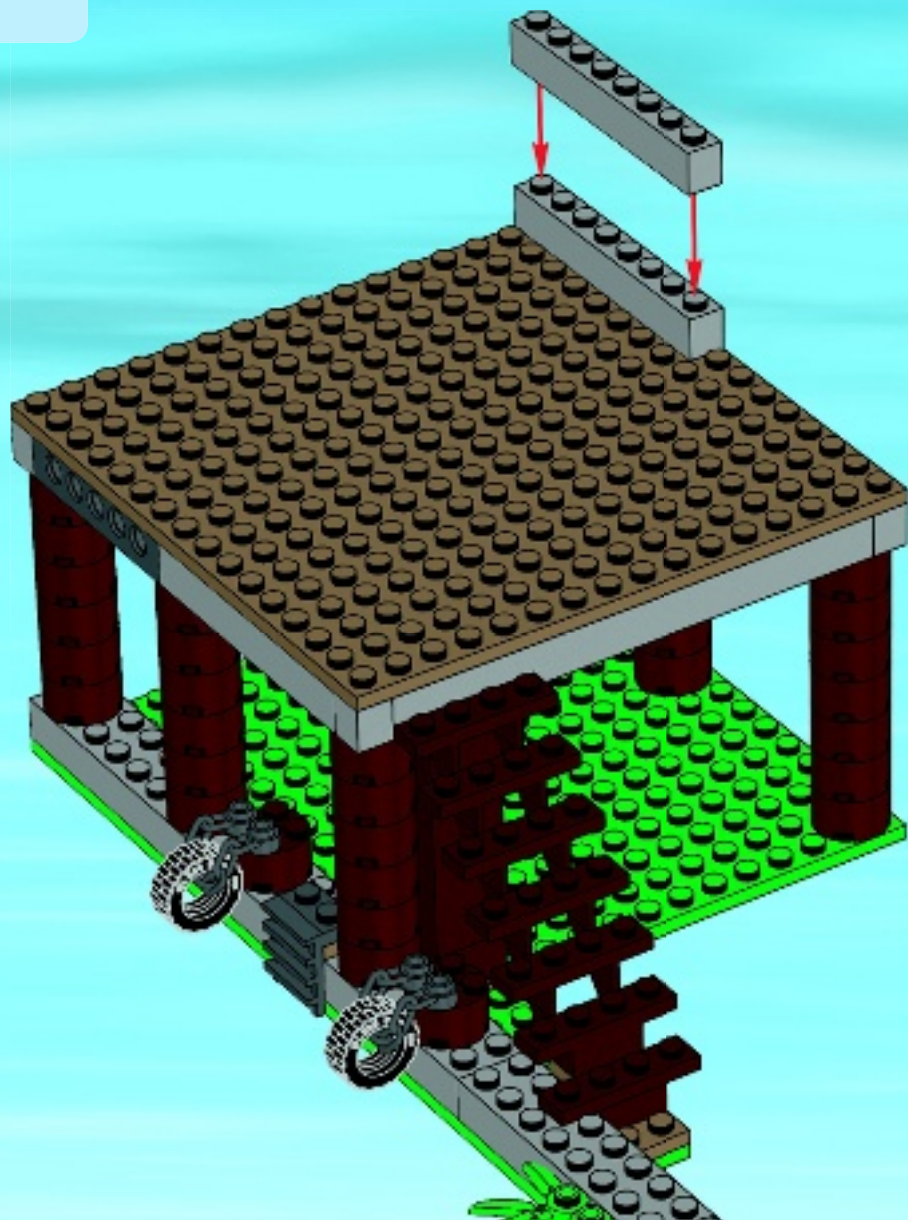



2x

# 23

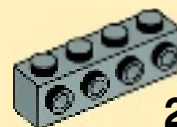

2x

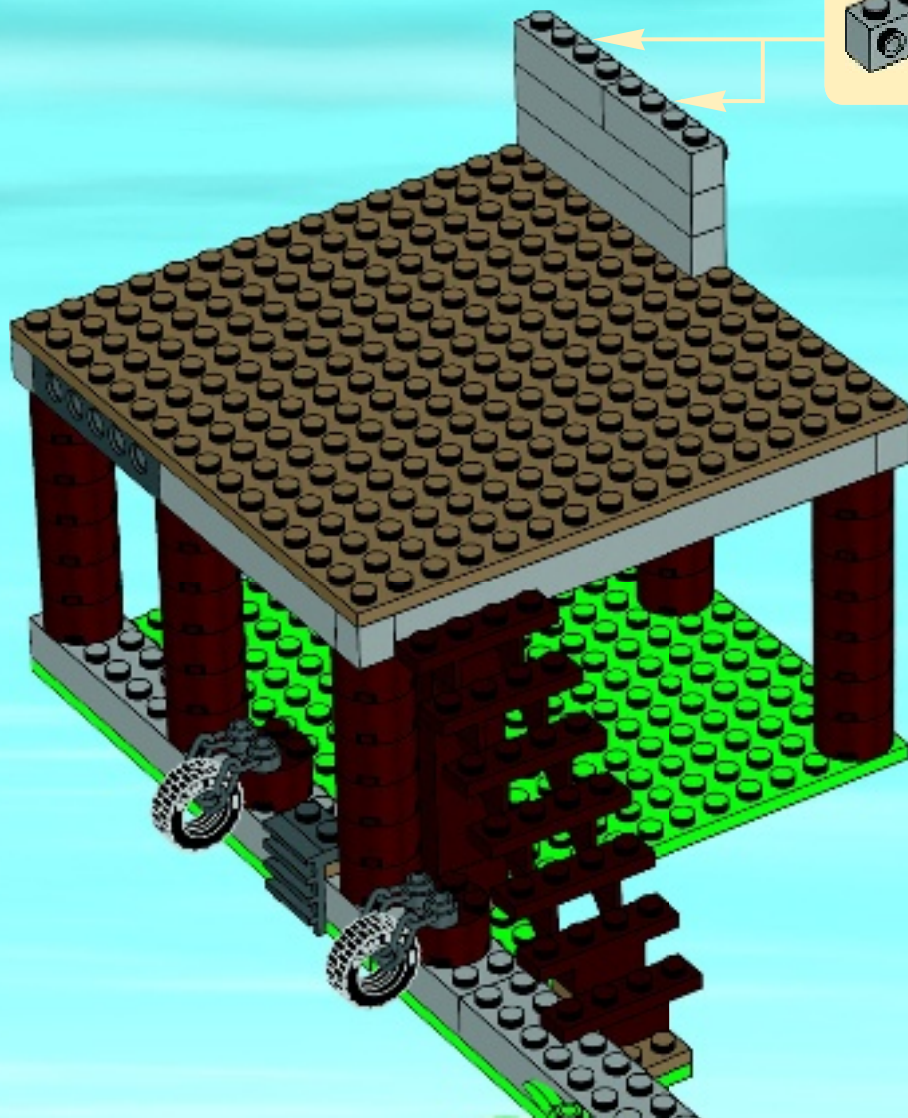



2x



1x

# 24

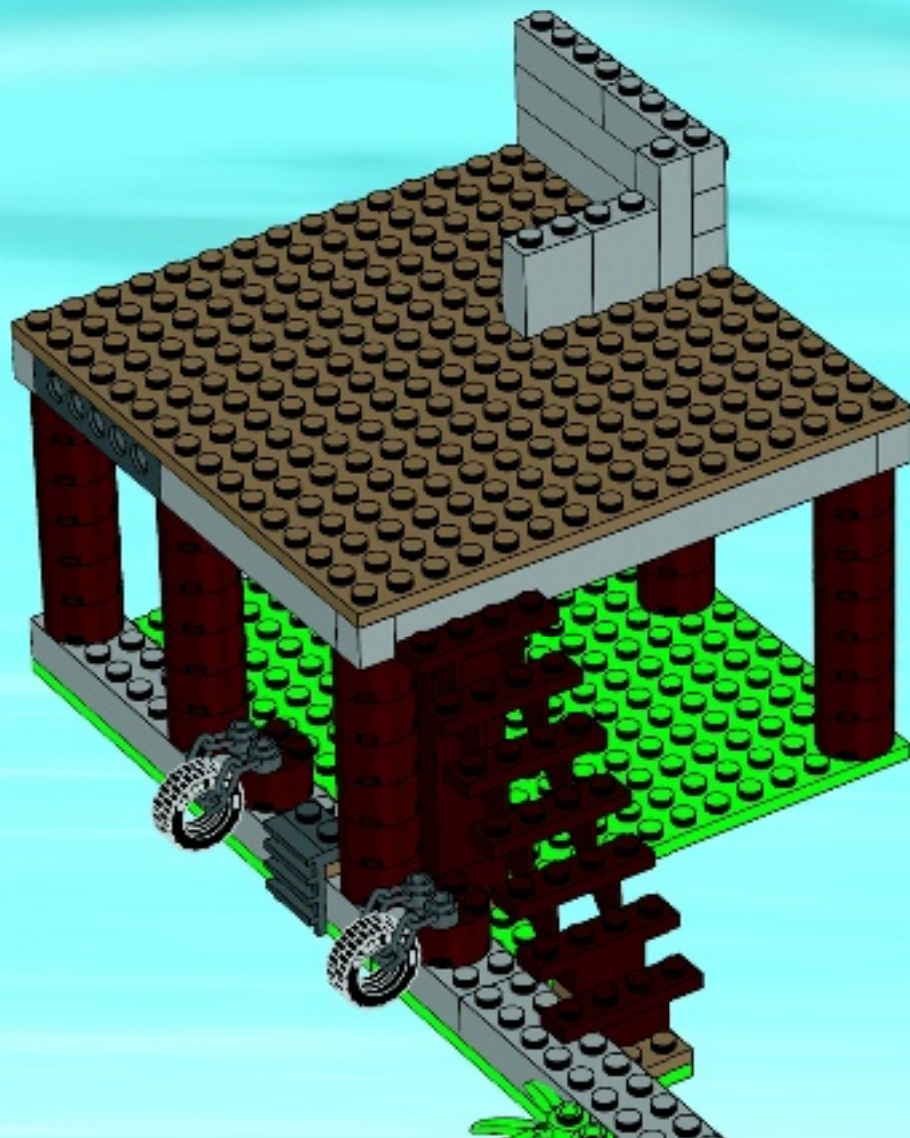



1x



1x

# 25

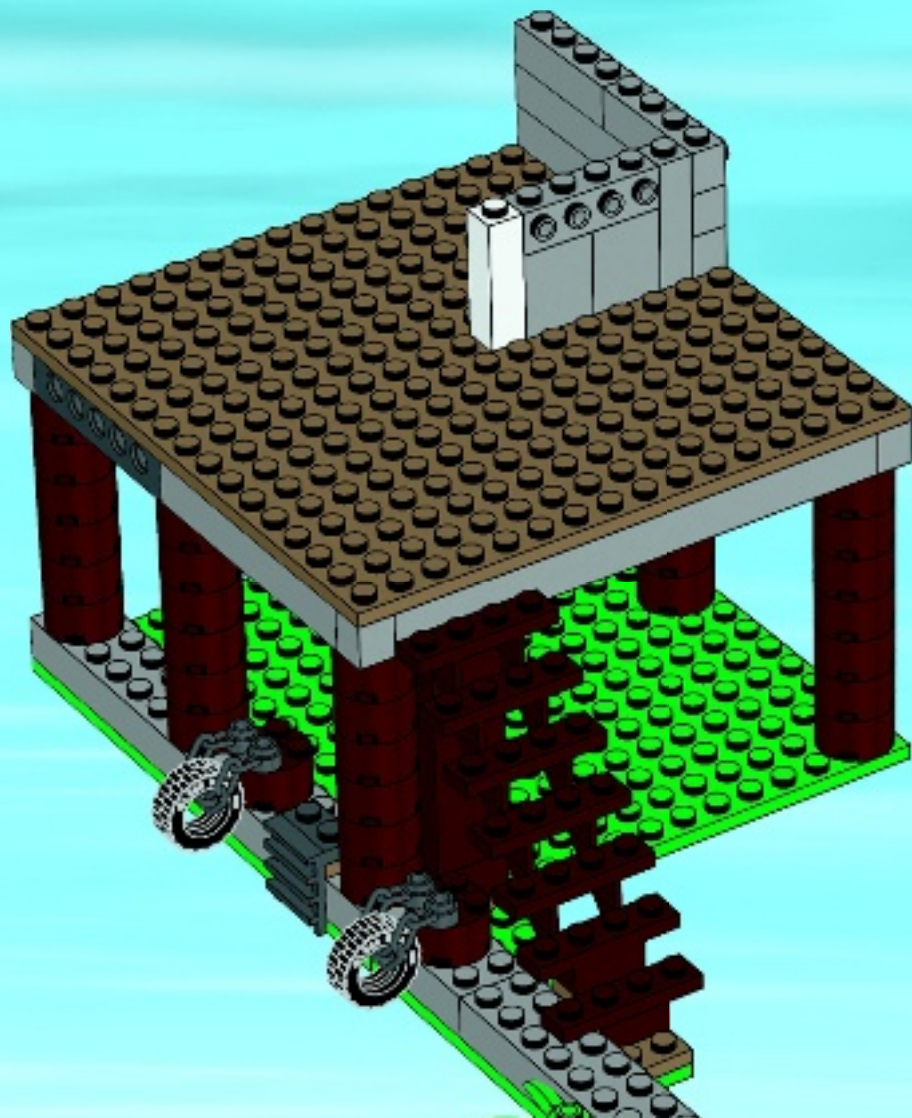



6x



6x

# 26

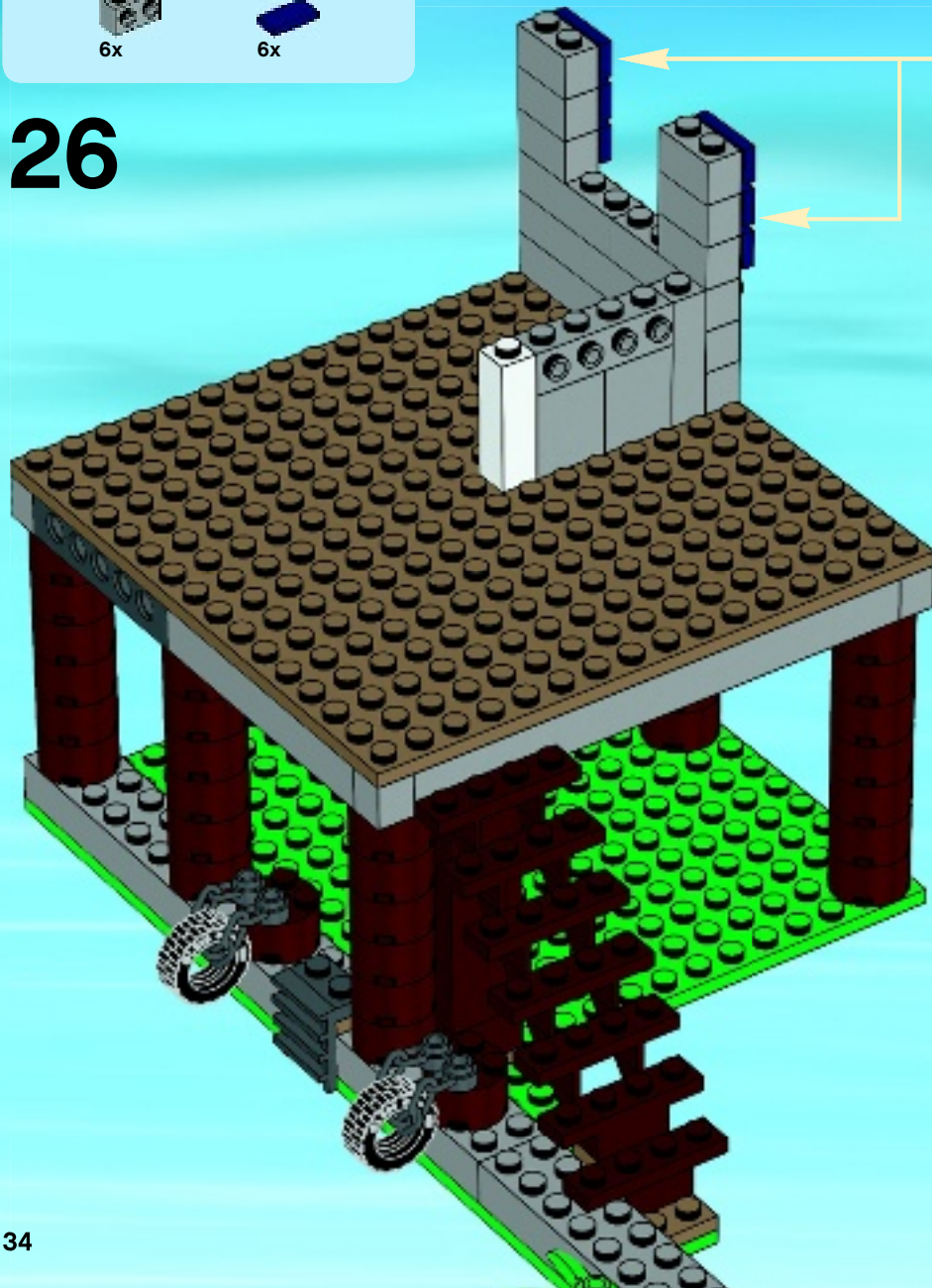

1

2

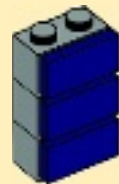

2x

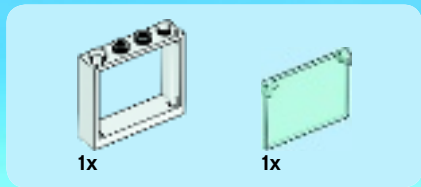

27

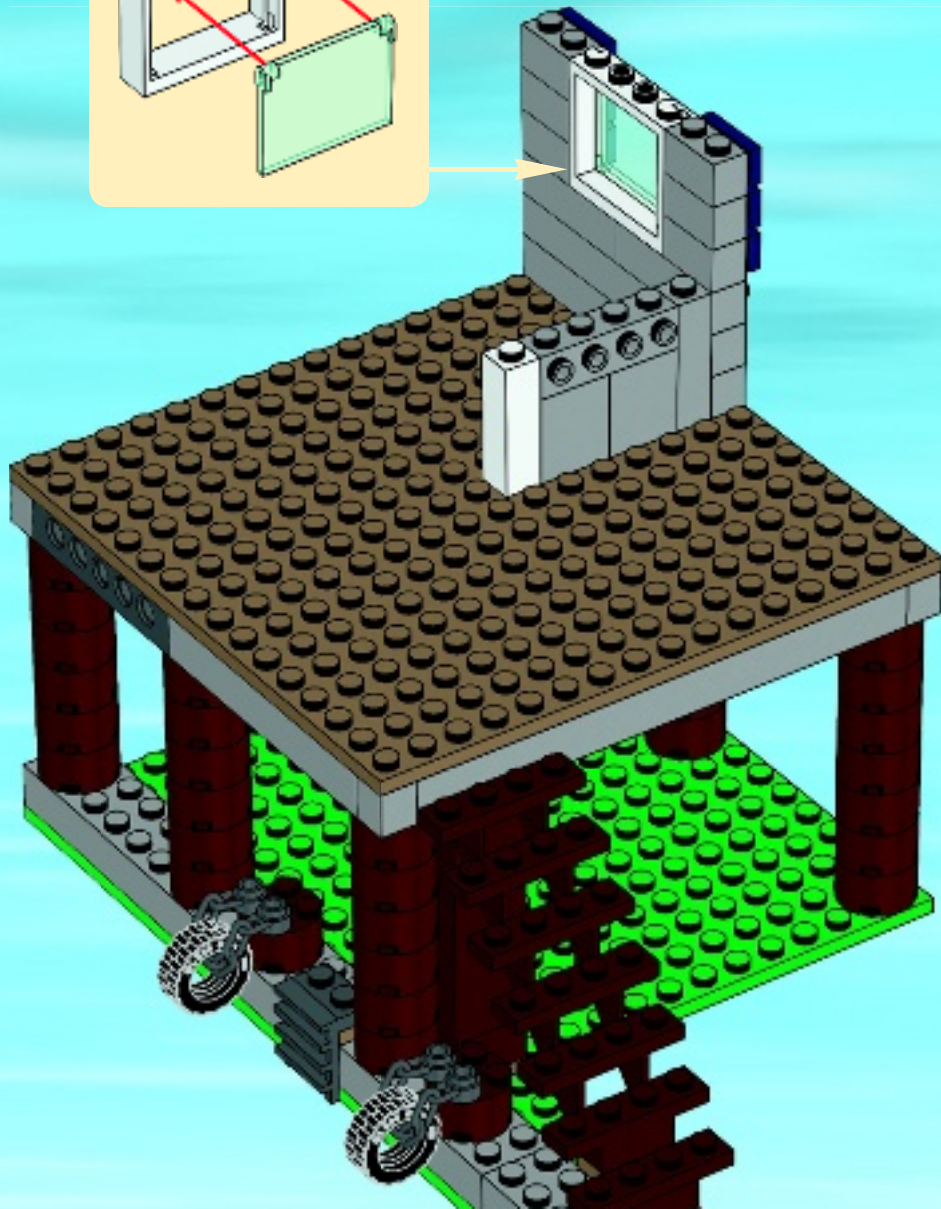
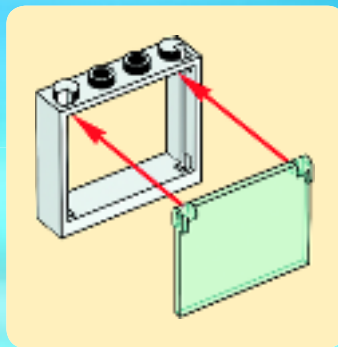



1x



1x

# 28

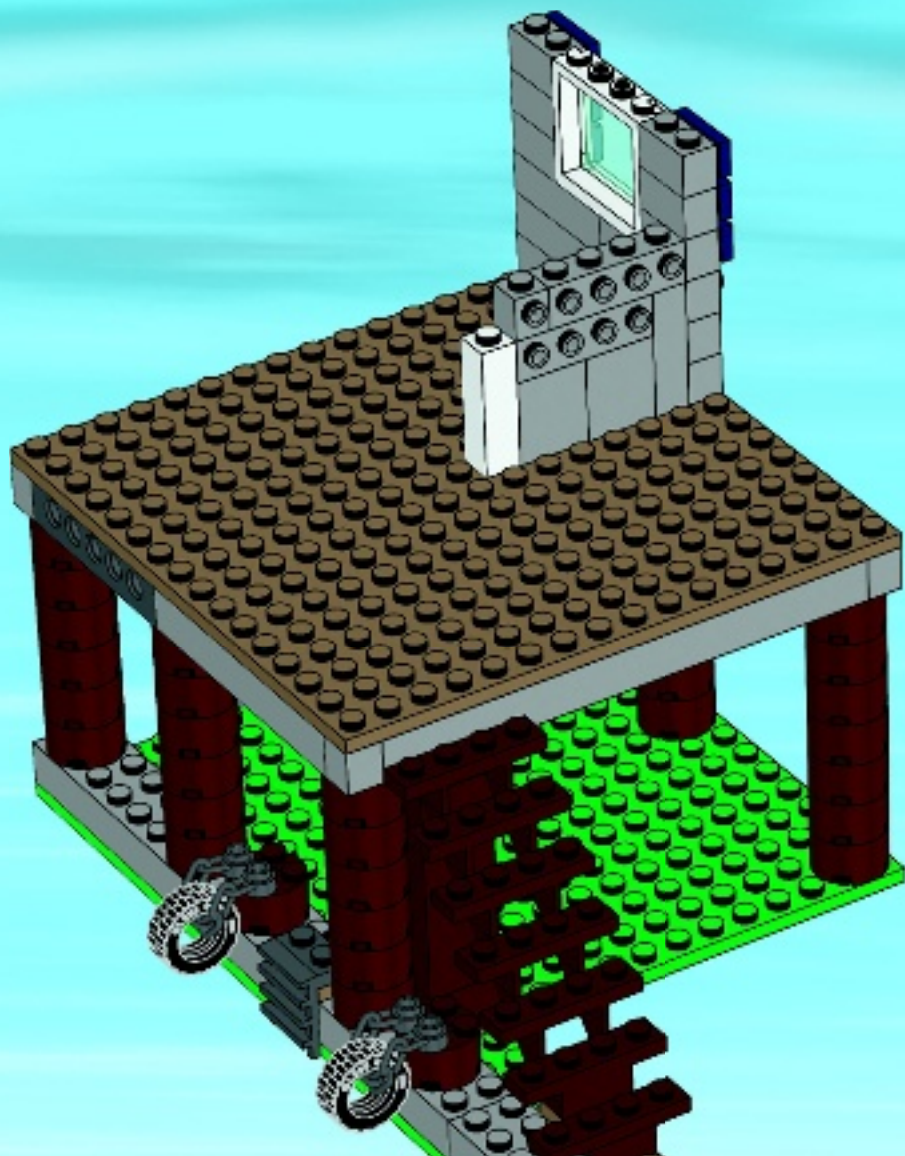



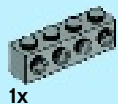

1x



1x

# 29

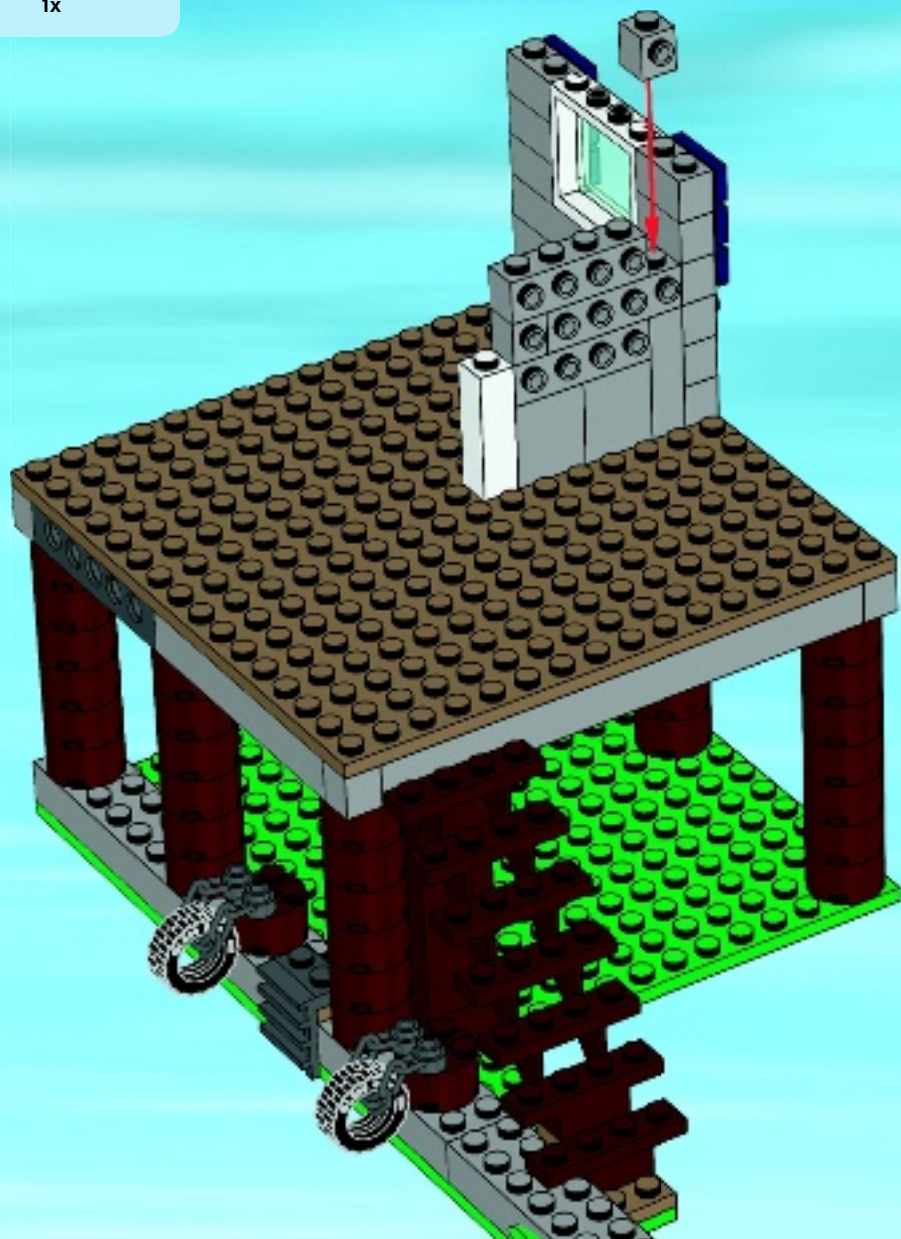

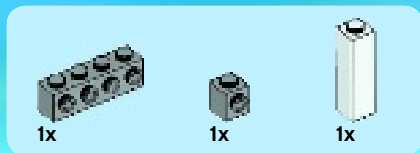

30

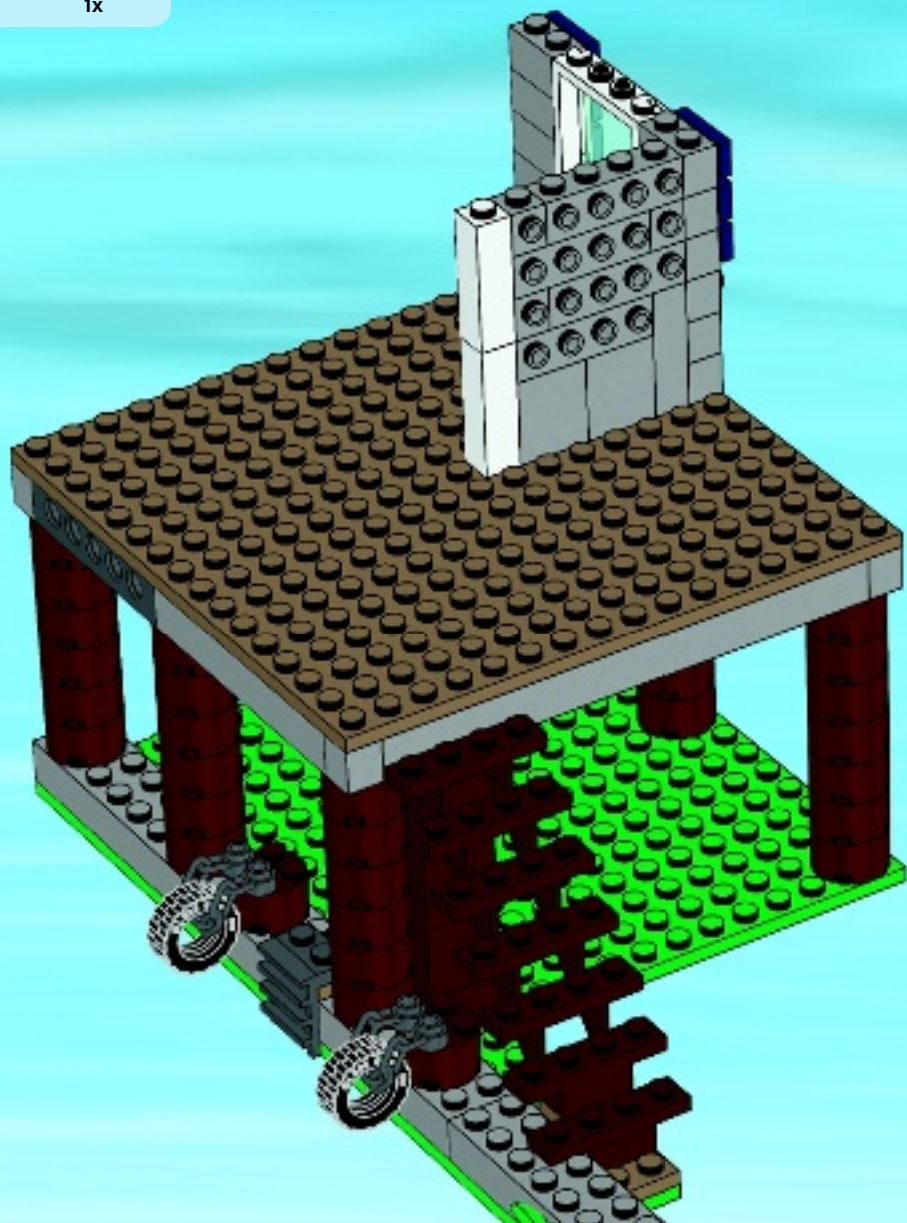

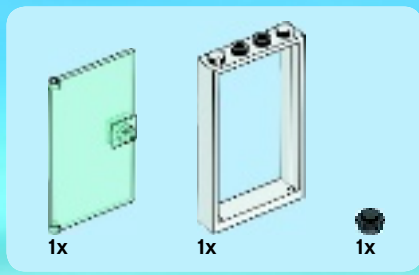

# 31

## 1

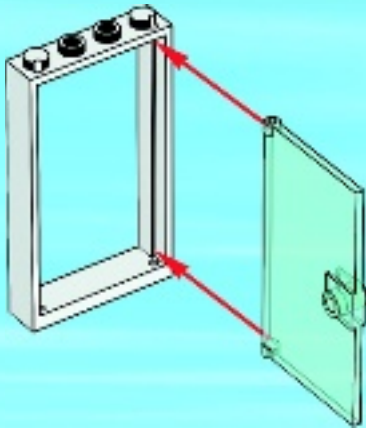

## 2

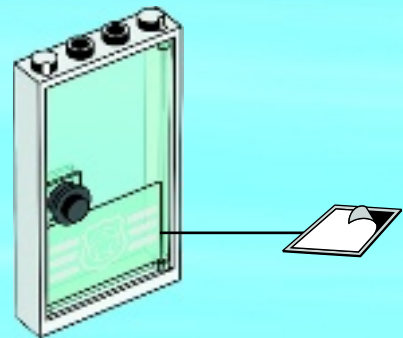

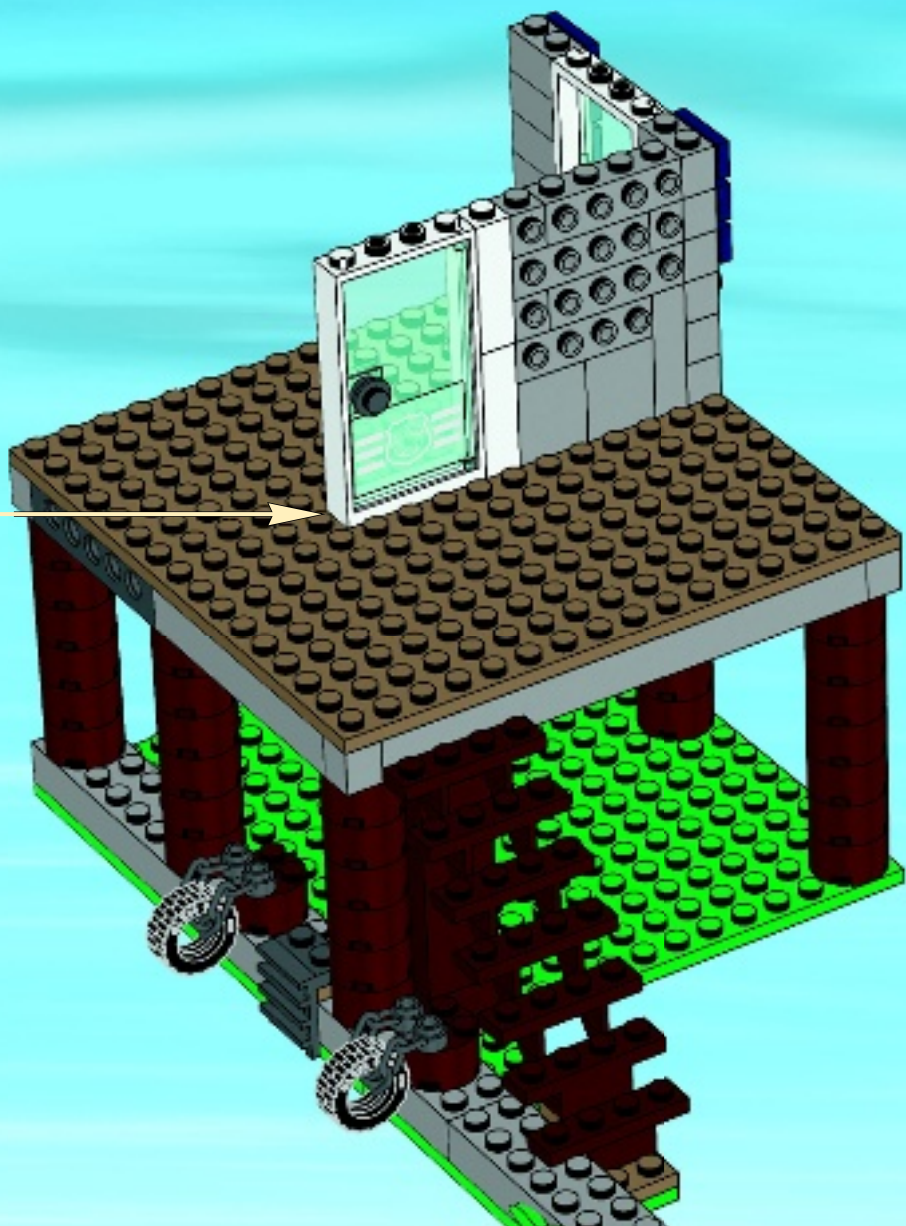

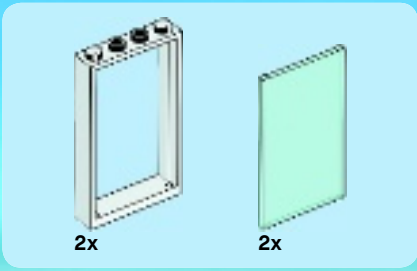

**32**

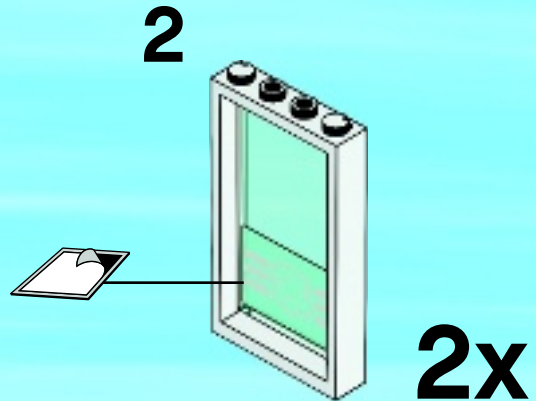
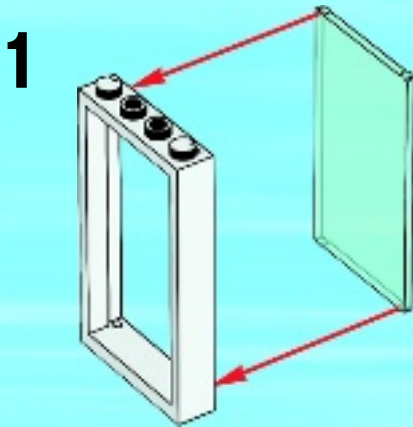

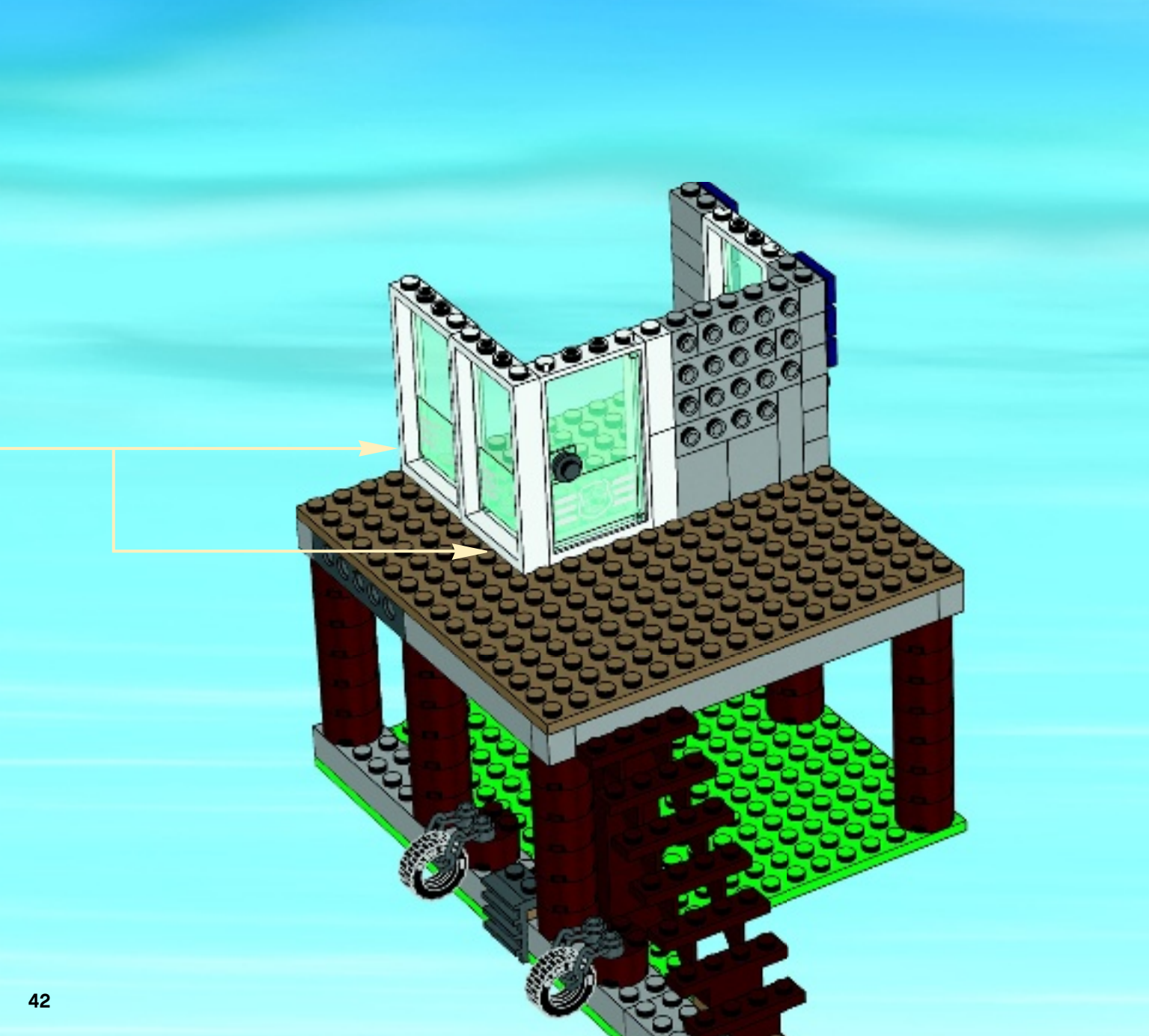



2x



2x

# 33

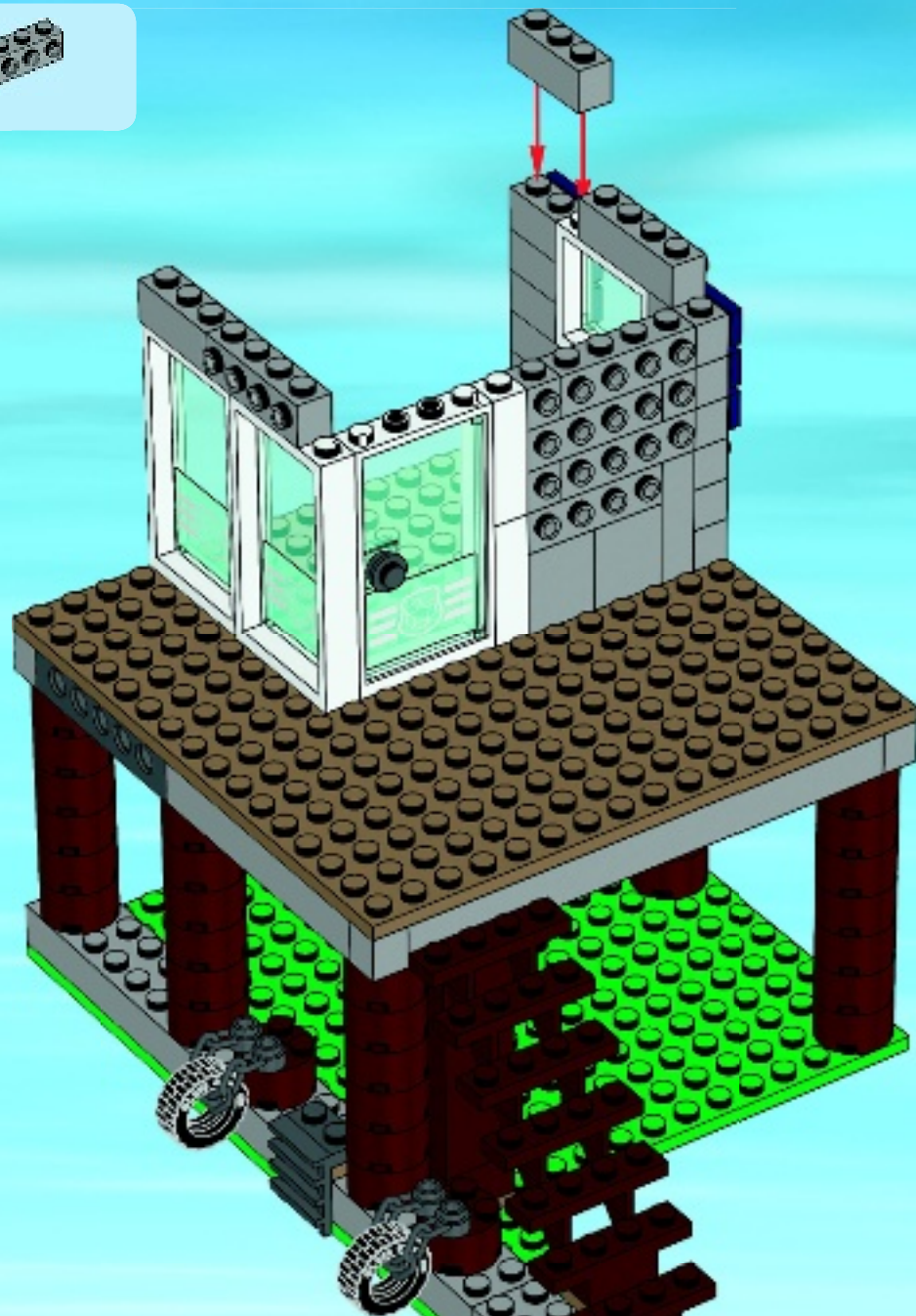



3x

# 34

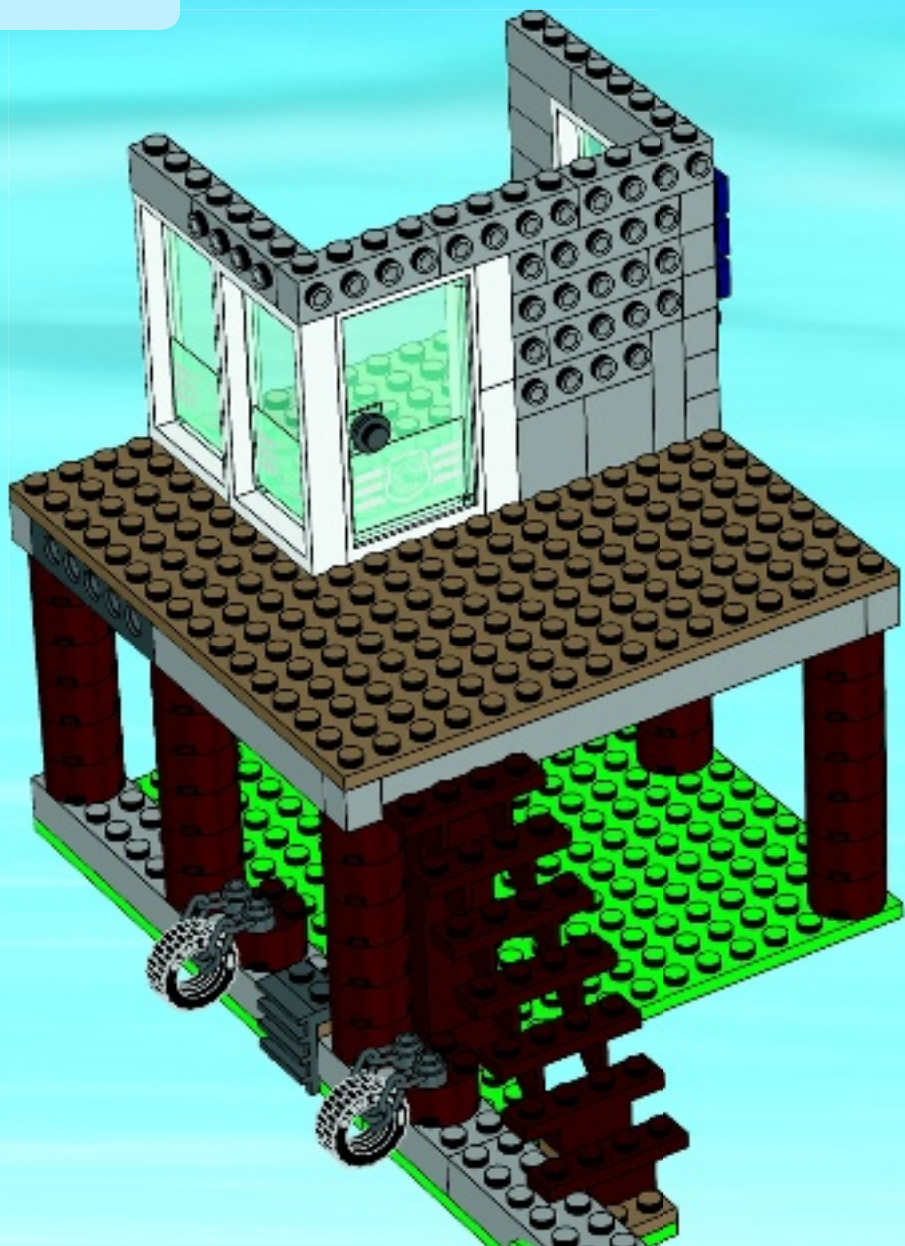





4x

# 35

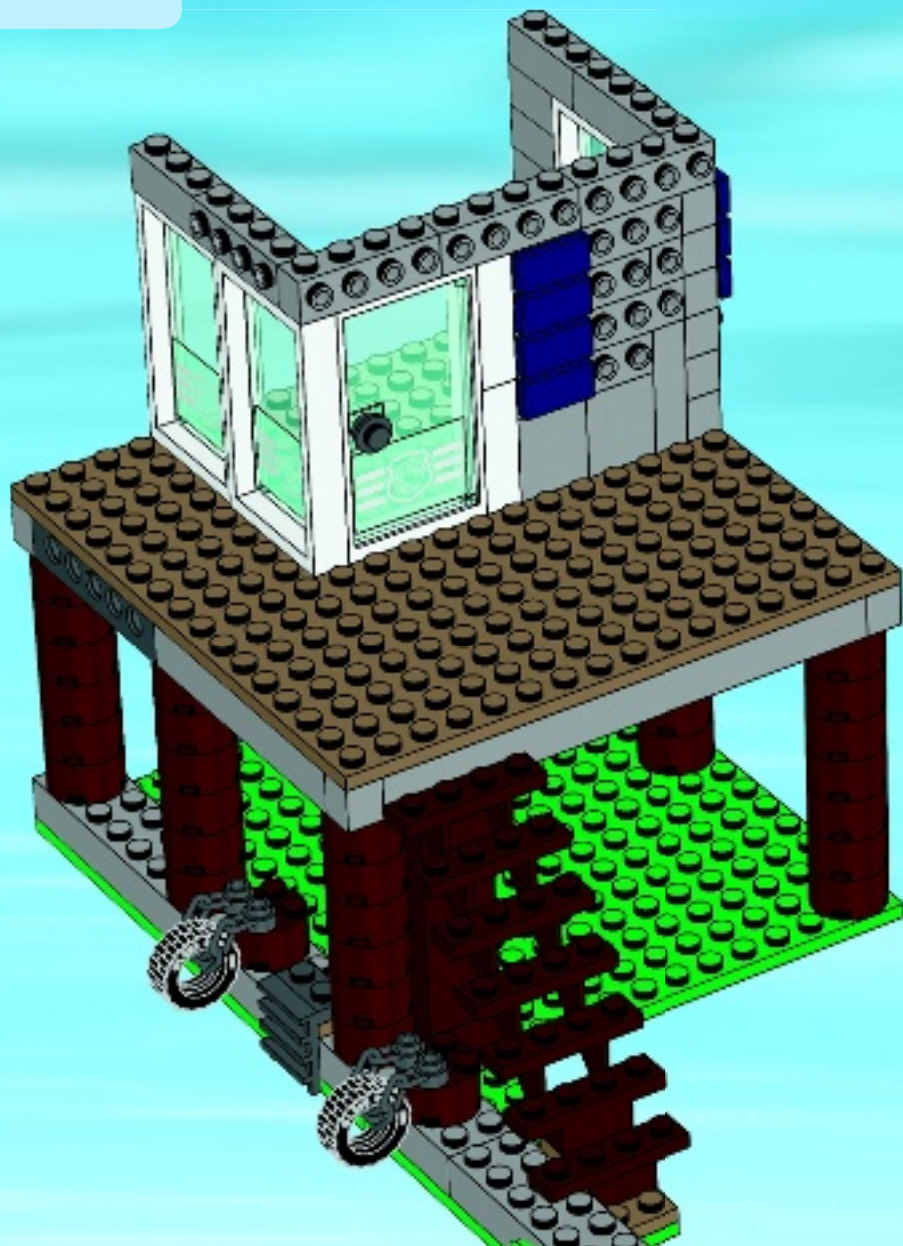



5x

# 36

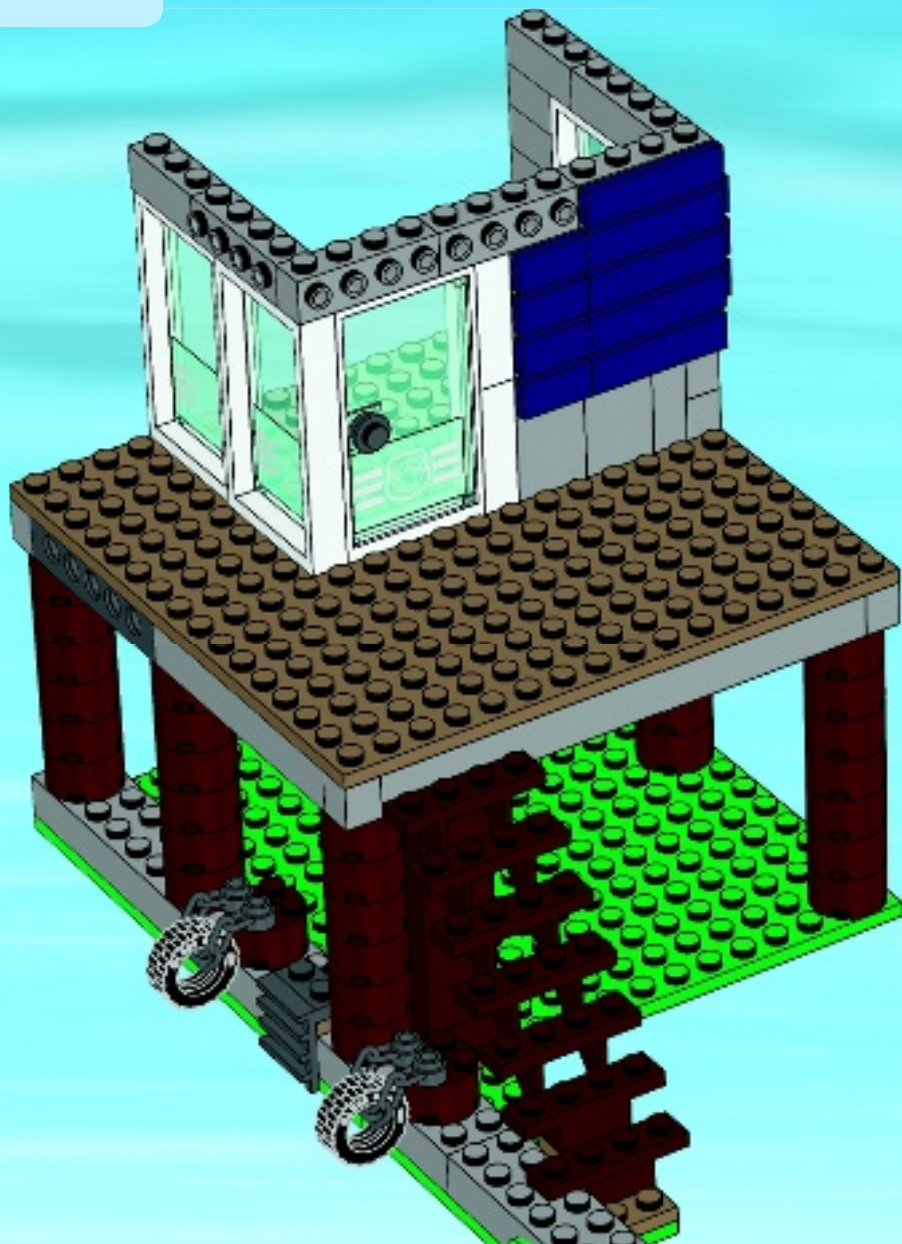

2x

37

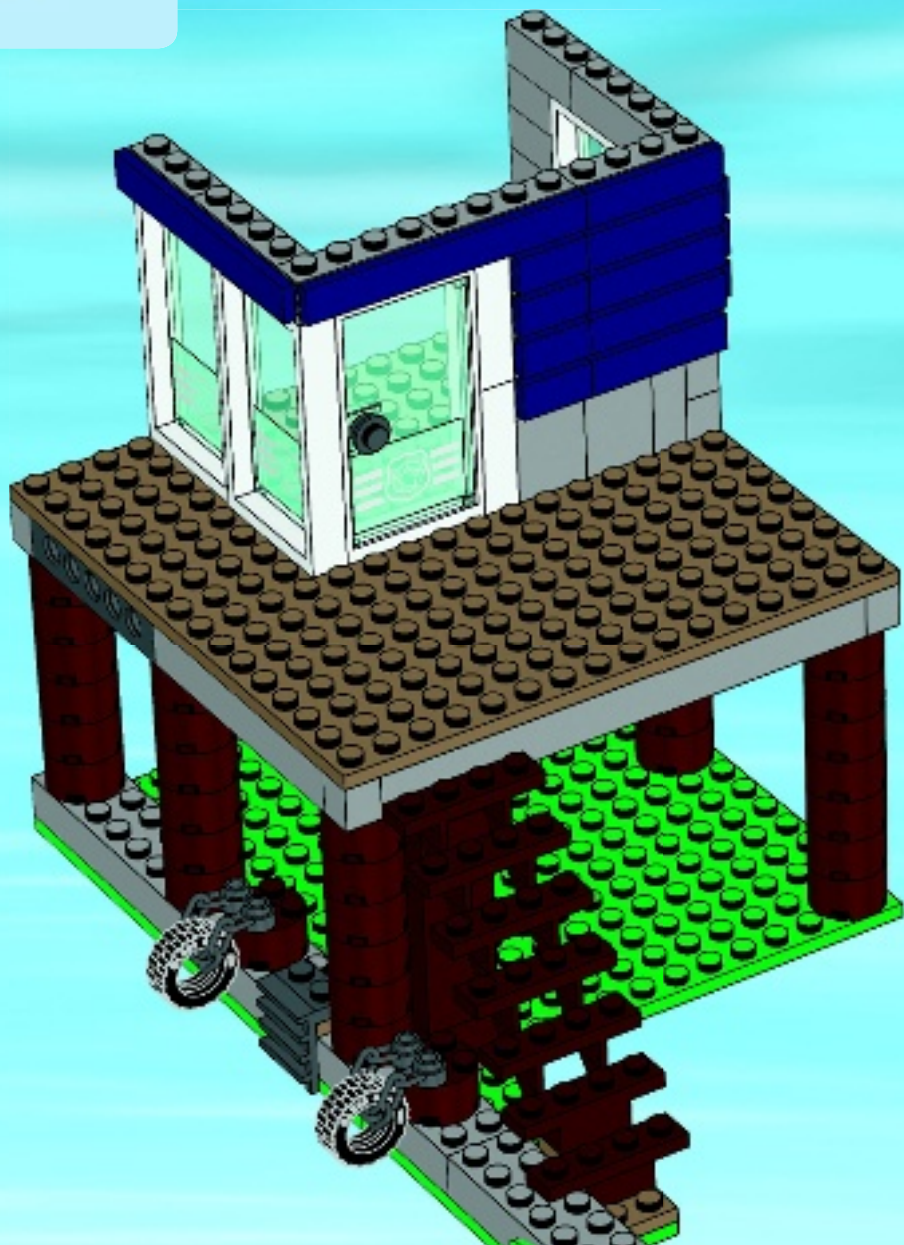



2x

38

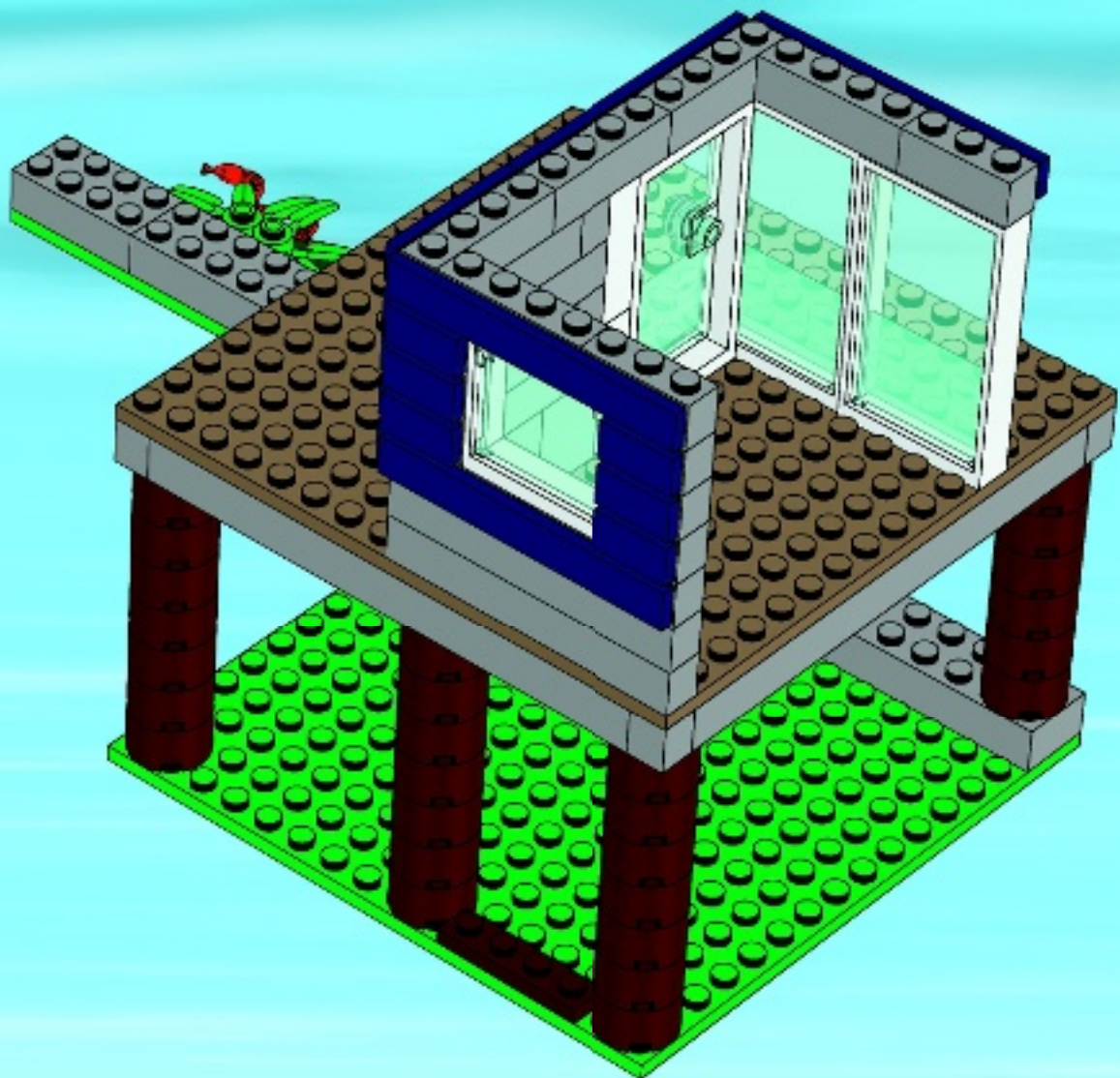



1x



1x



1x



1x



1x



1x

# 39

1



2



3



4





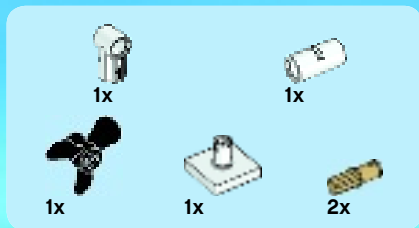

# 40

1



2



3



4



5



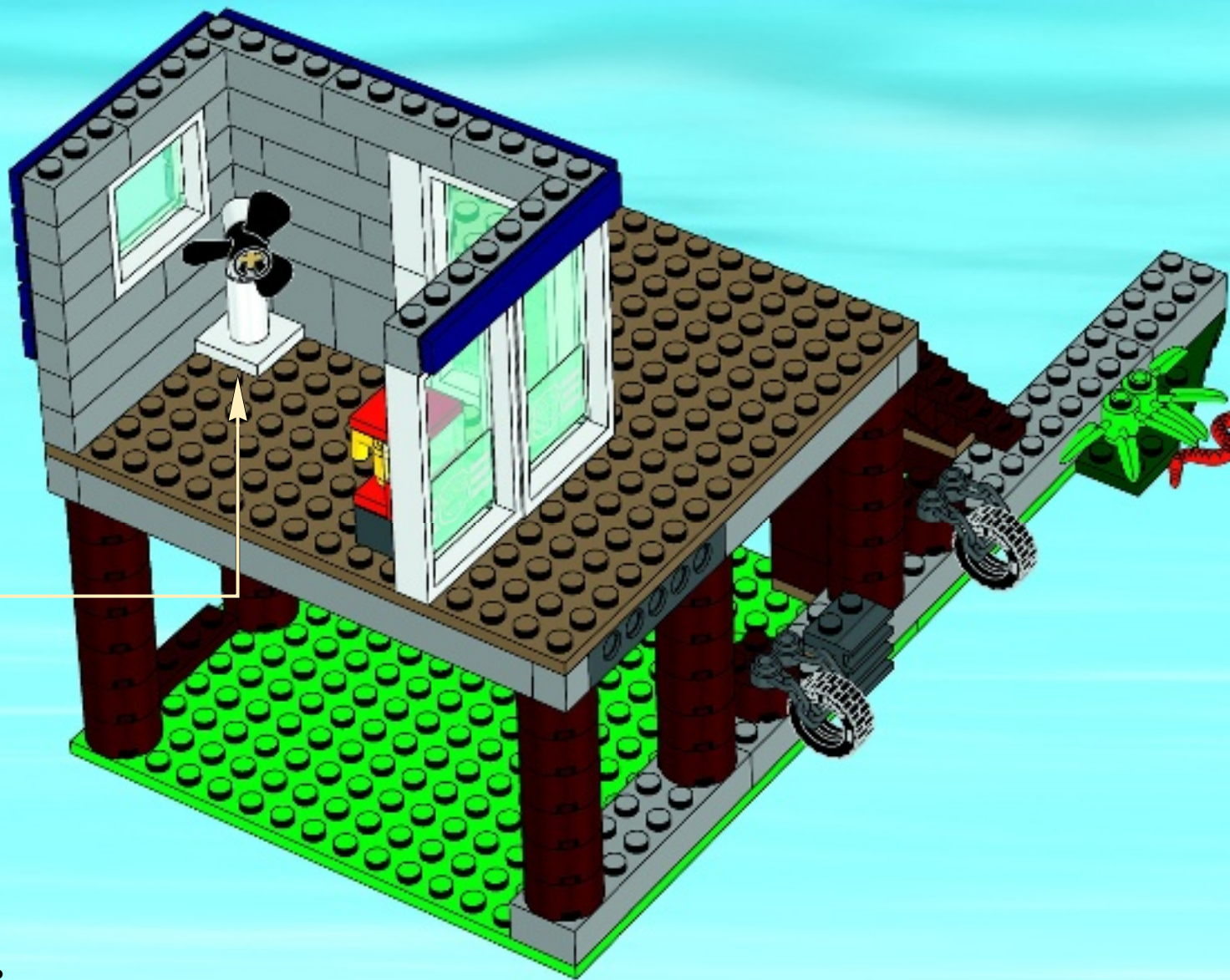





1x



1x

# 41

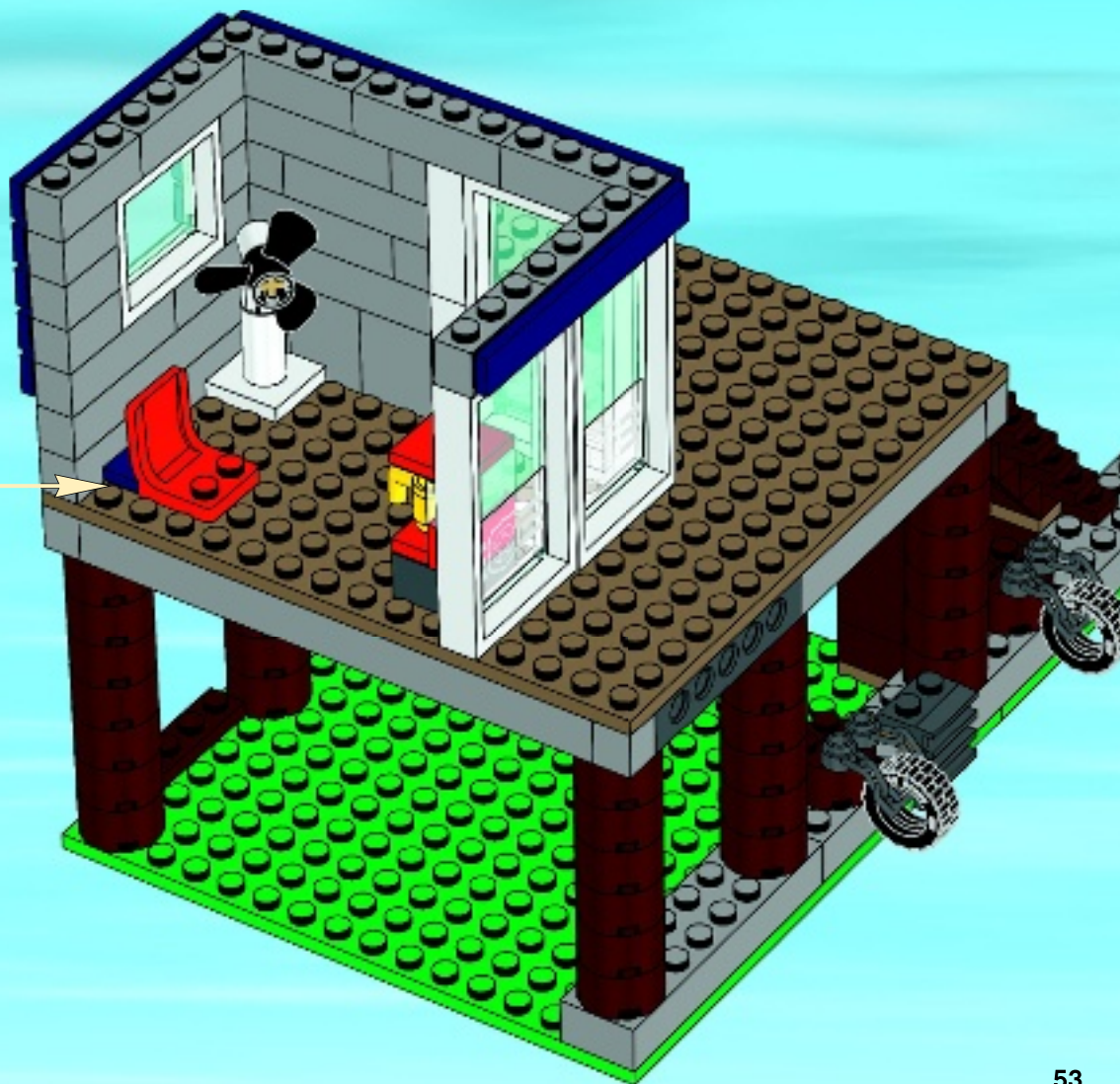



# 42

1



2

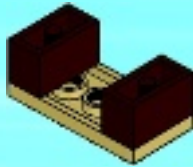

3



4



5

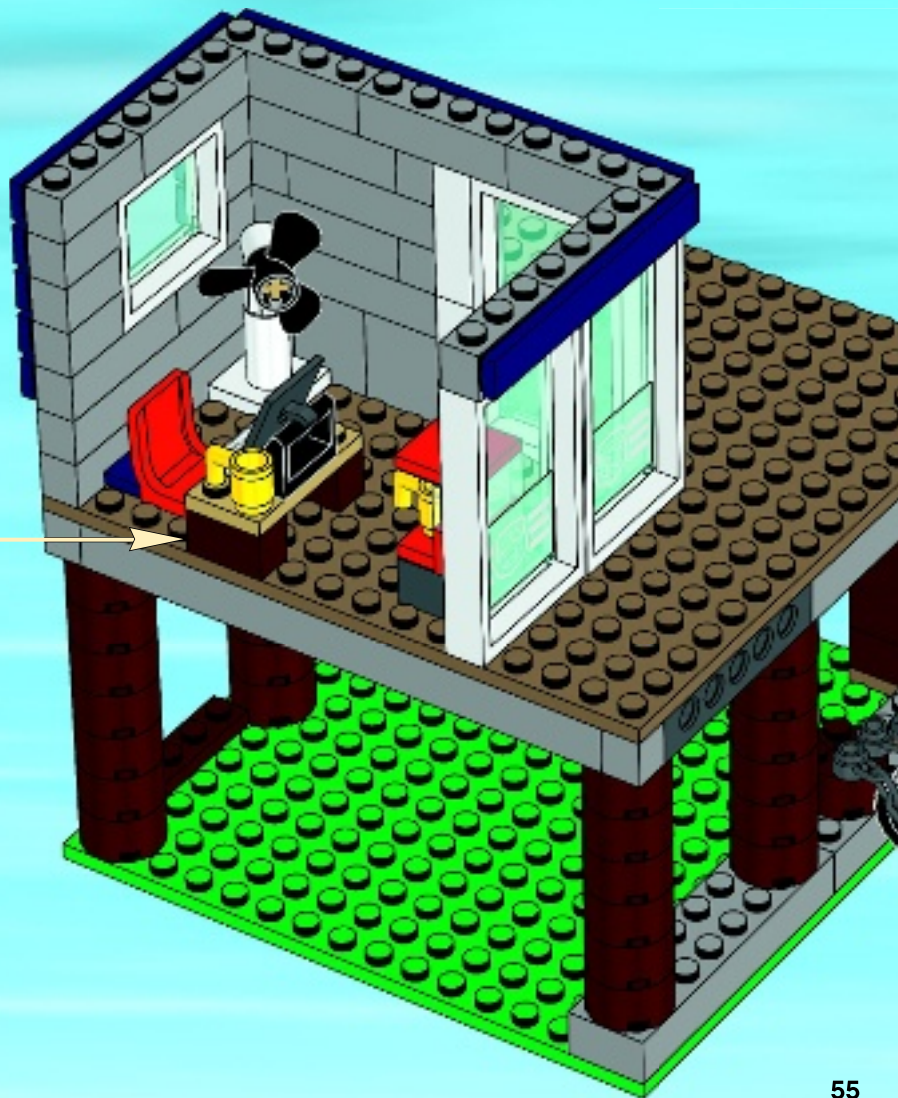

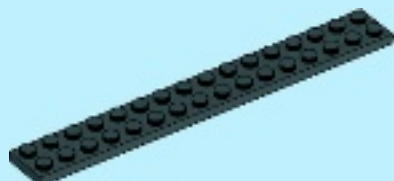

2x

43

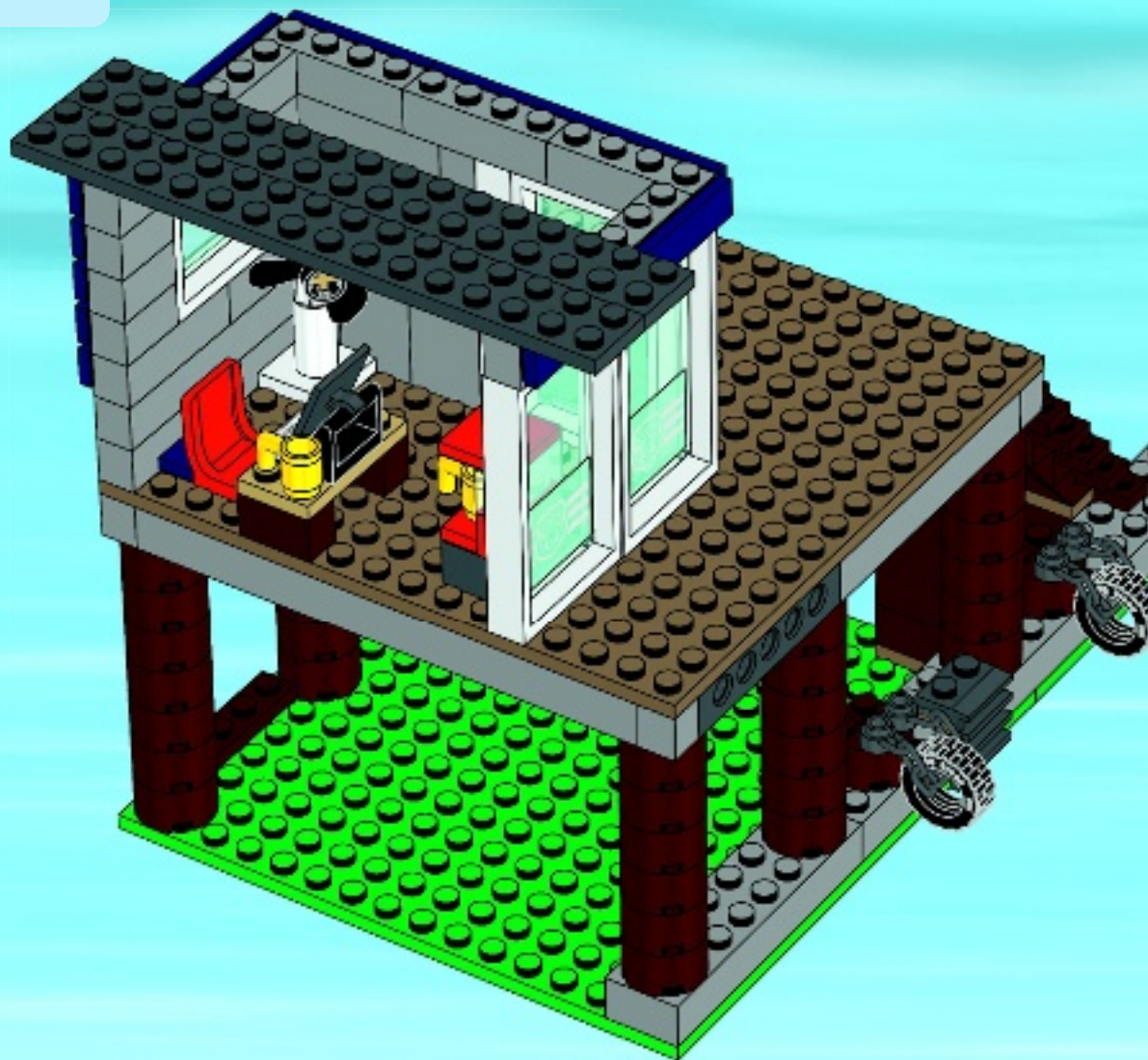

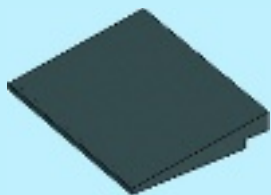

2x

44

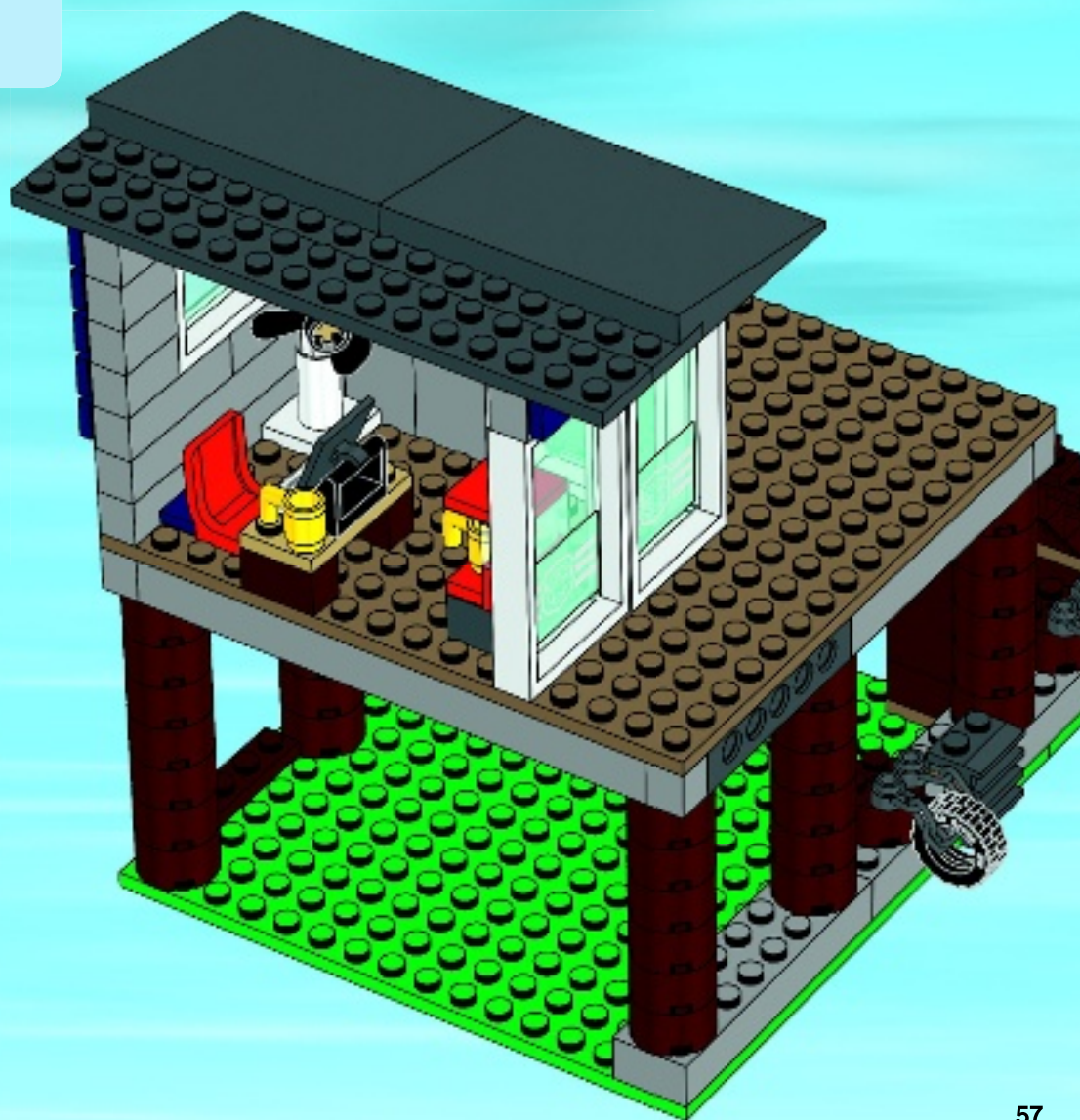



1x



2x

# 45

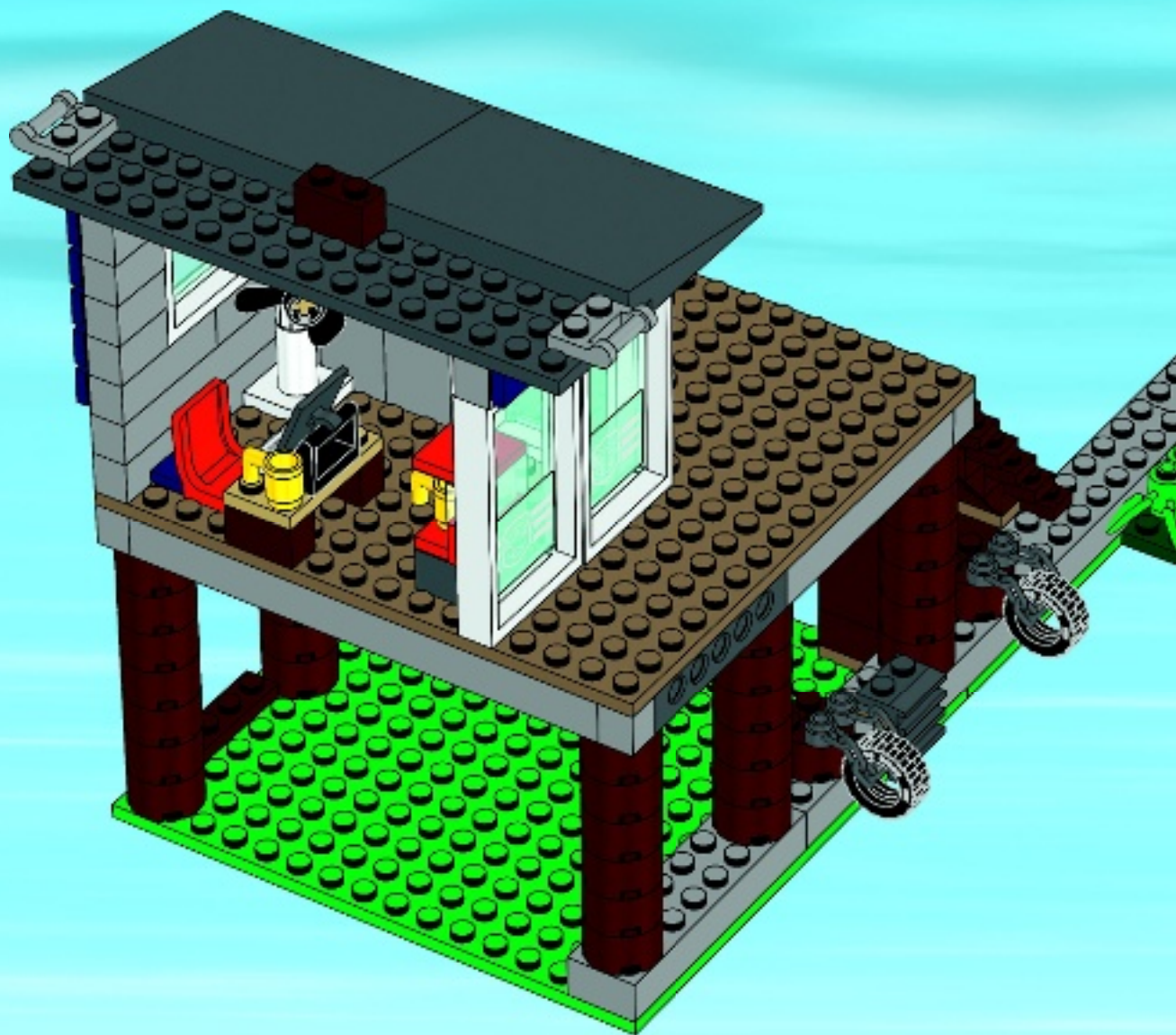



2x



2x

1



2



2x

# 46

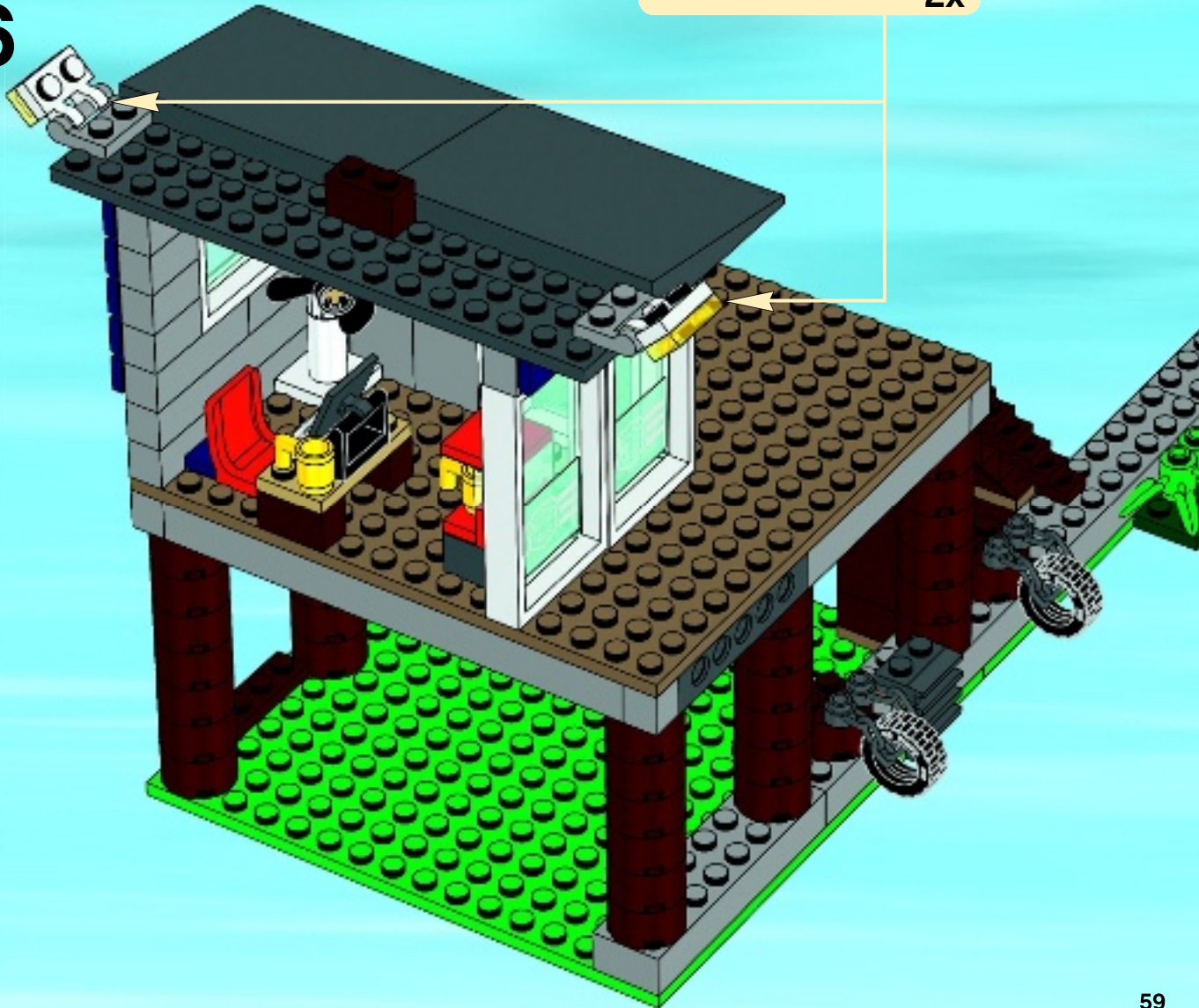



1x



1x

1



2

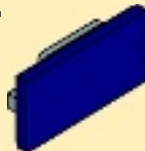

3



# 47

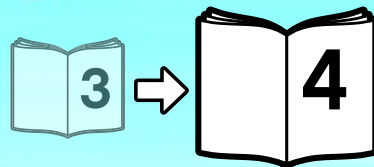
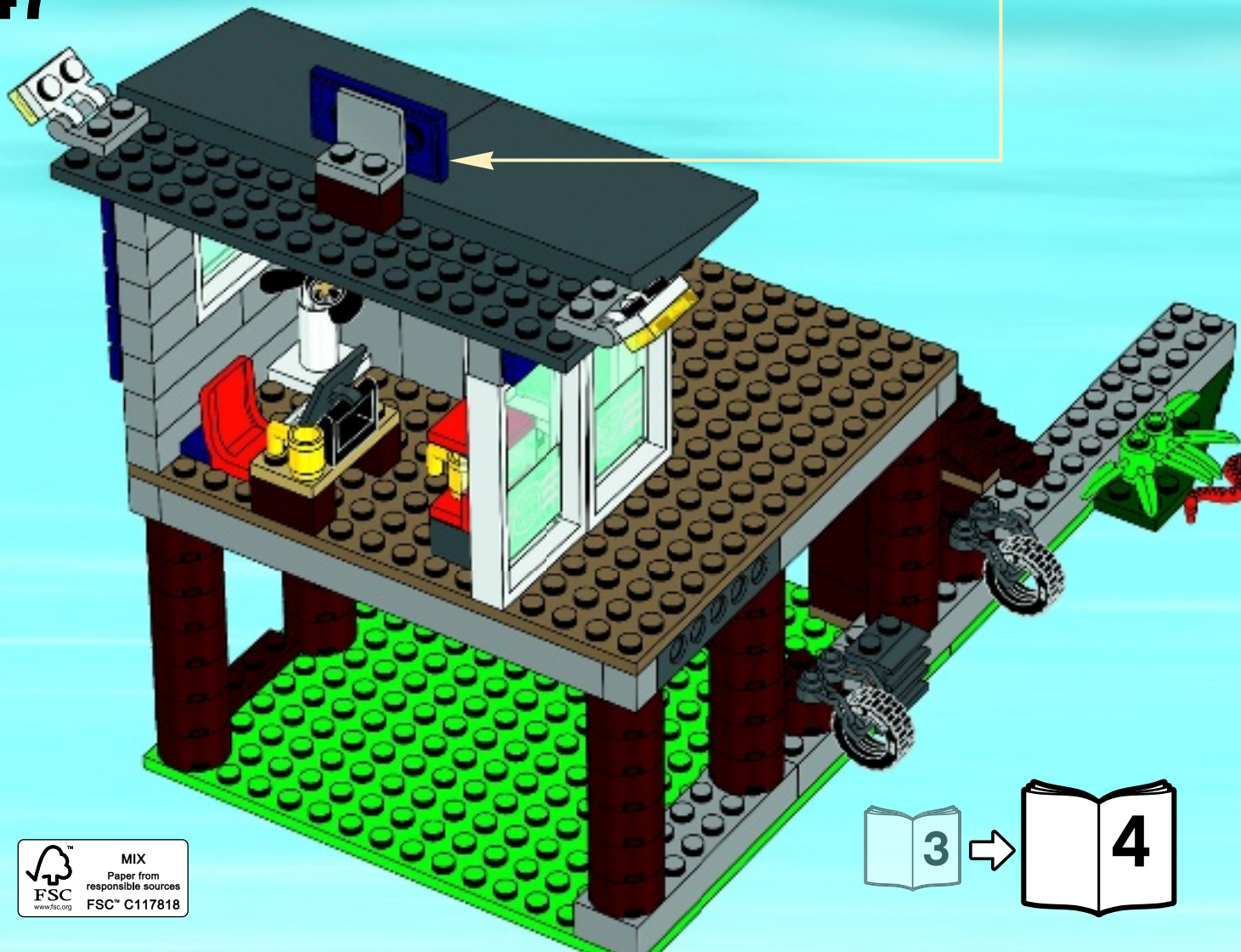





# CITY

60069







1x

48

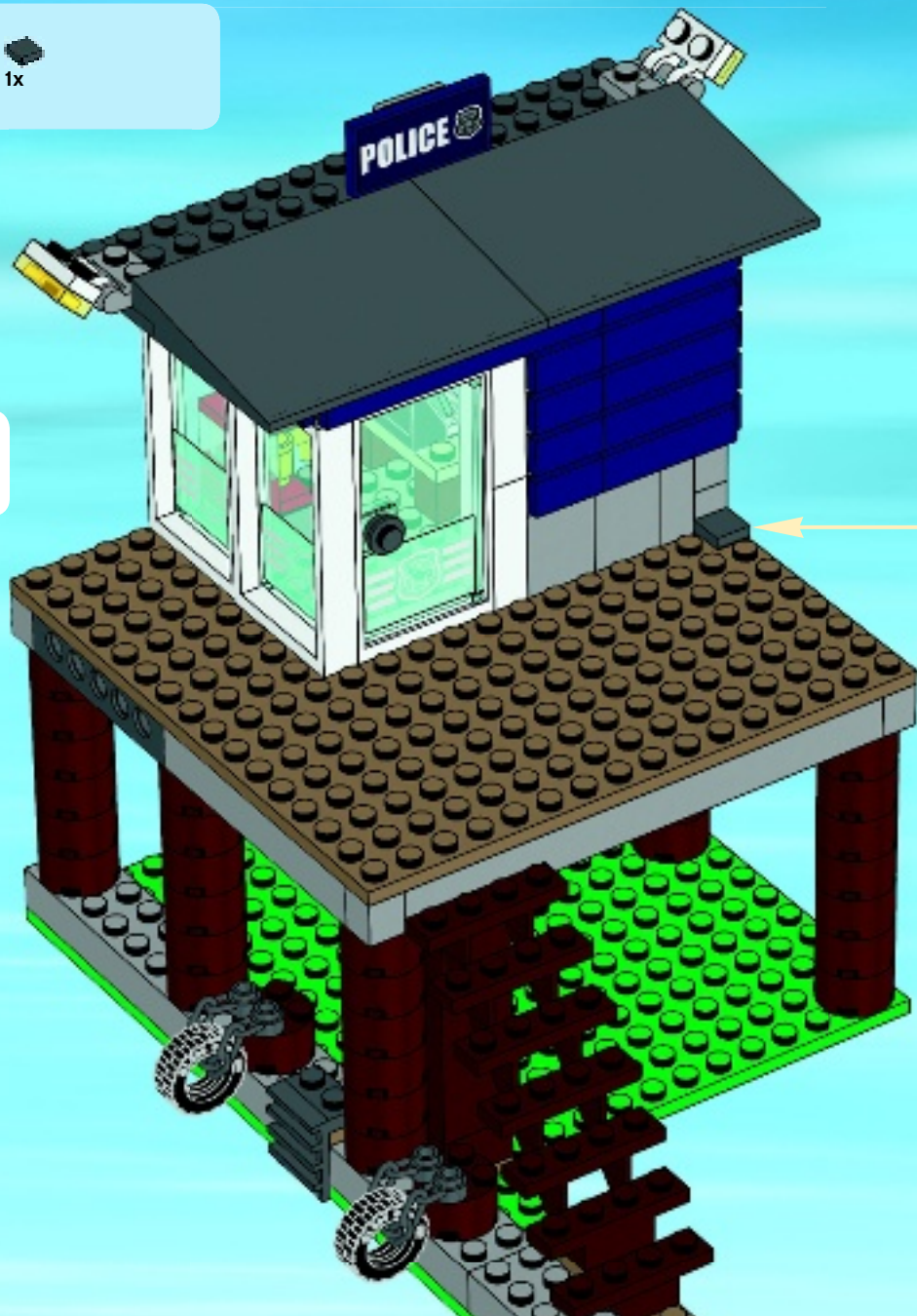



1x



3x



1x

# 49

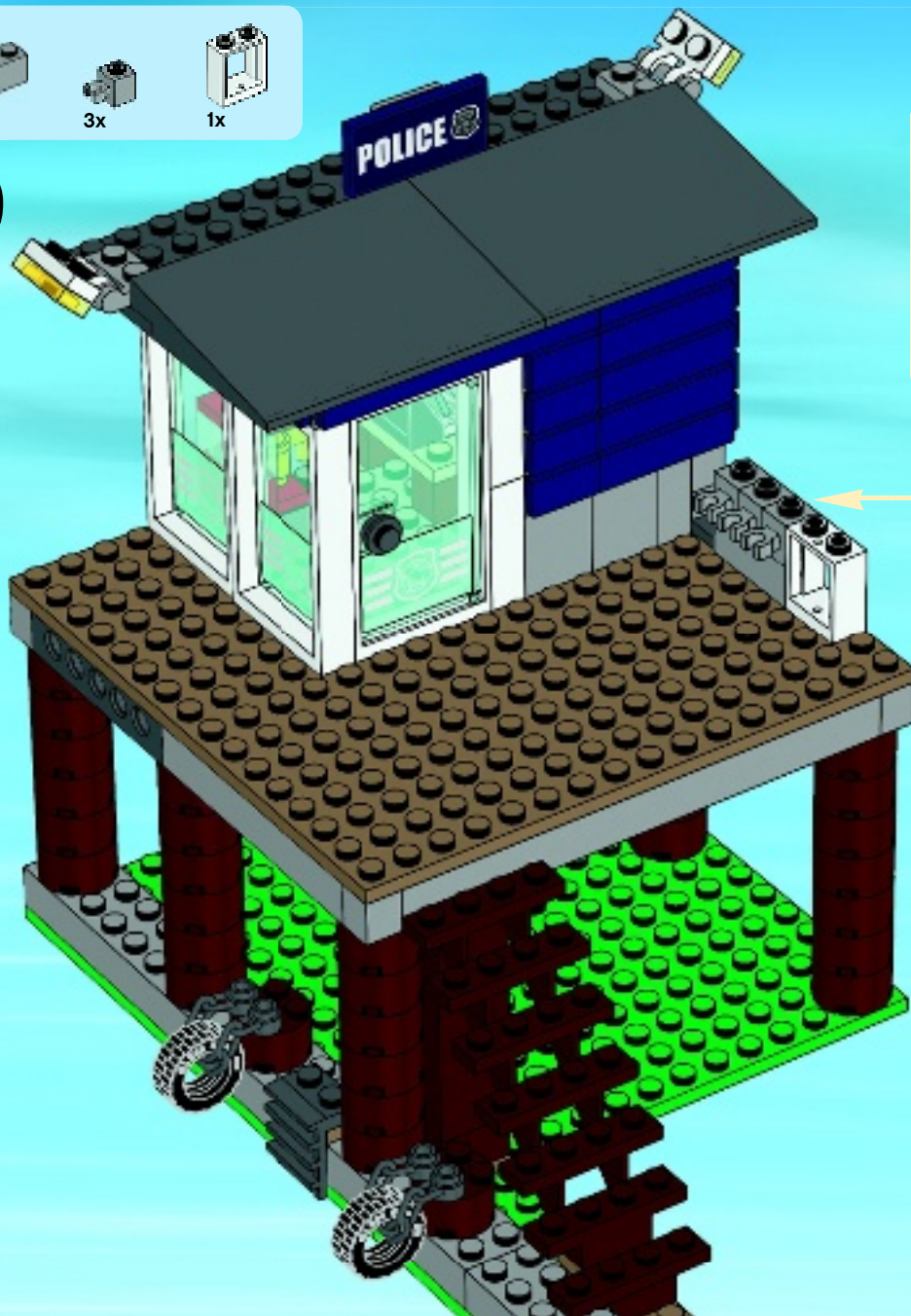

1

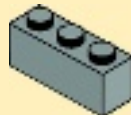

2

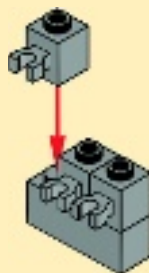



4x



4x

# 50

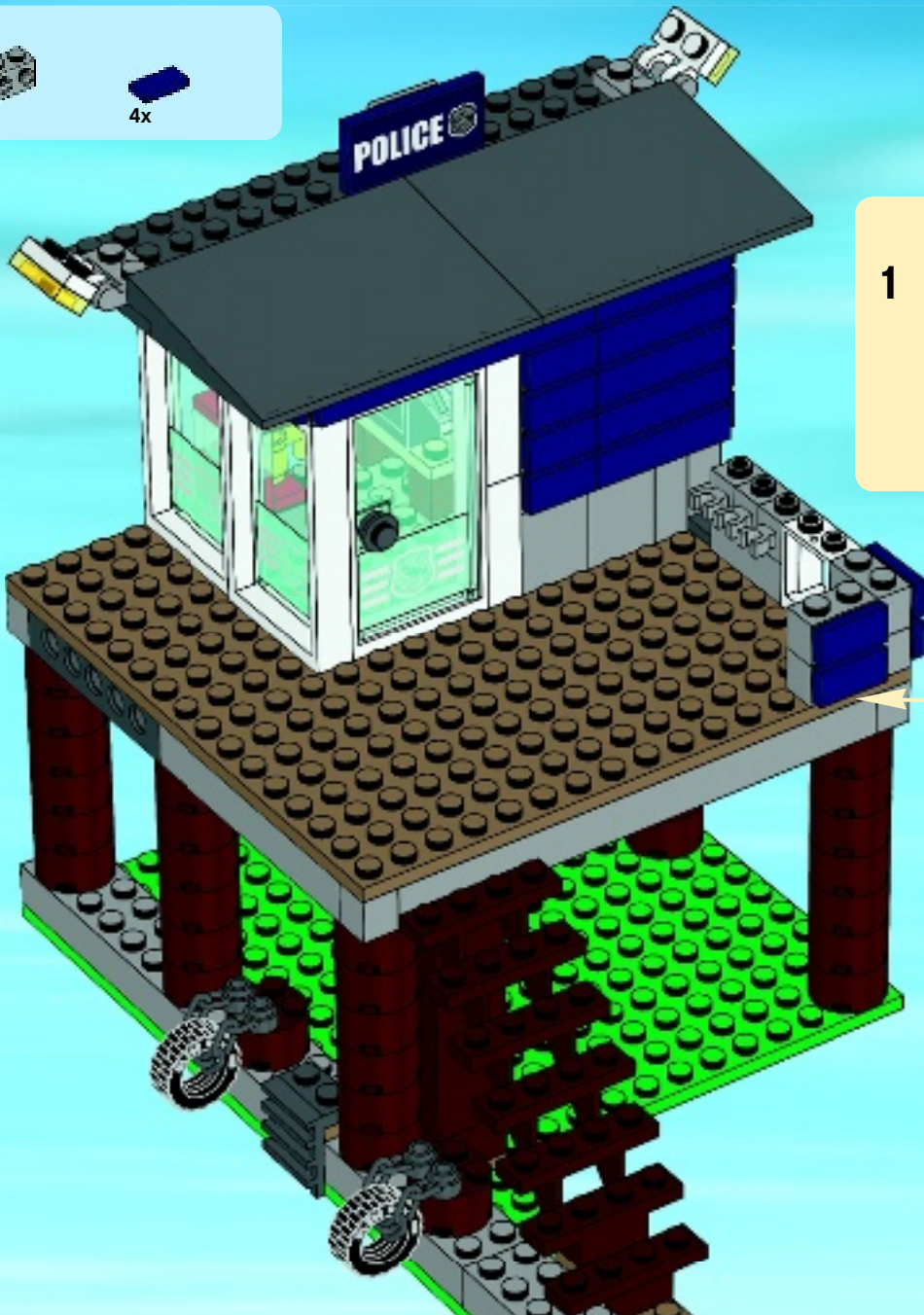

1

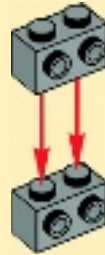

2



2x



3x

51

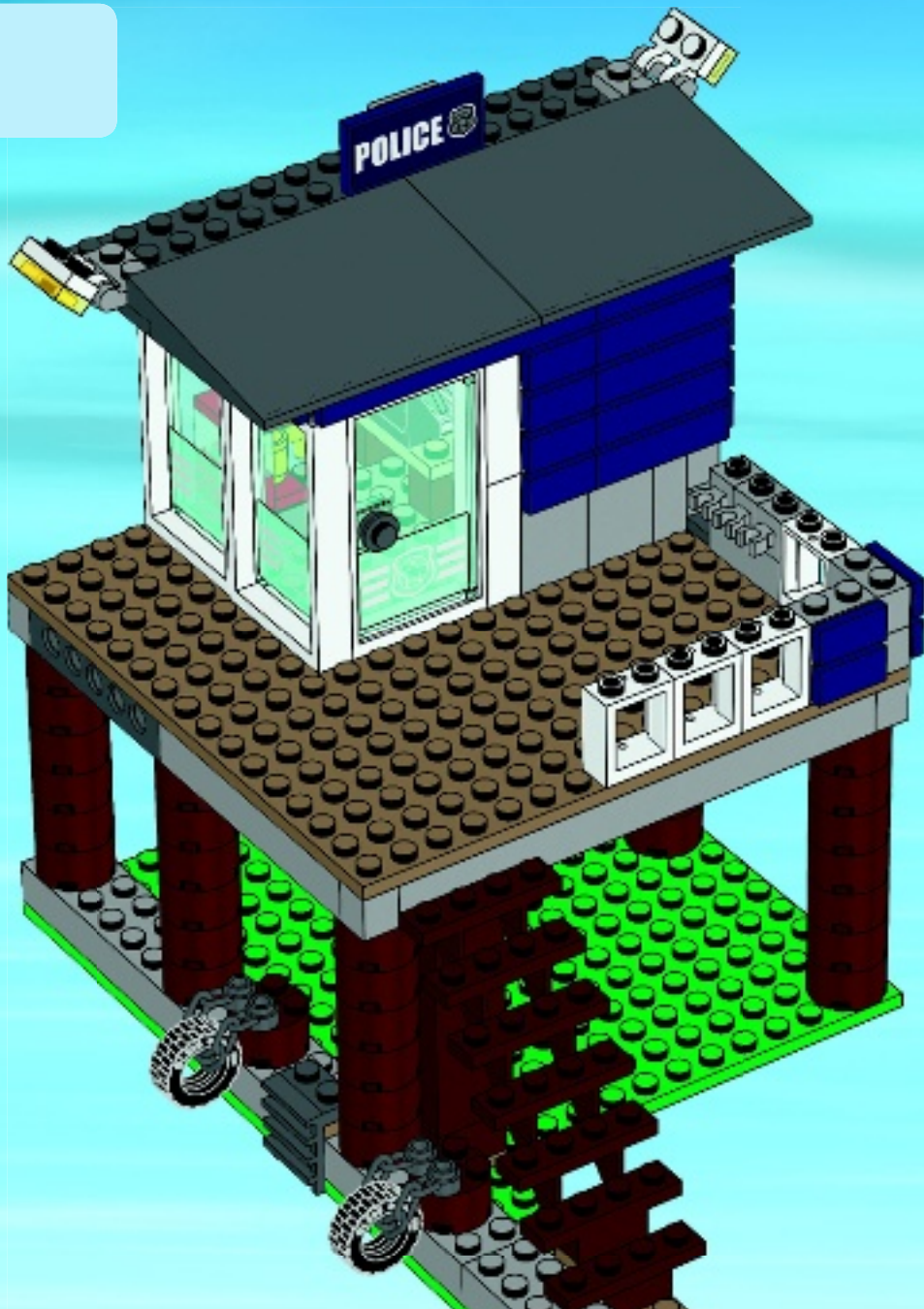



2x



2x

# 52

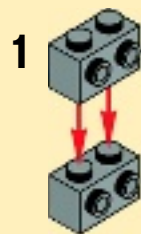

2

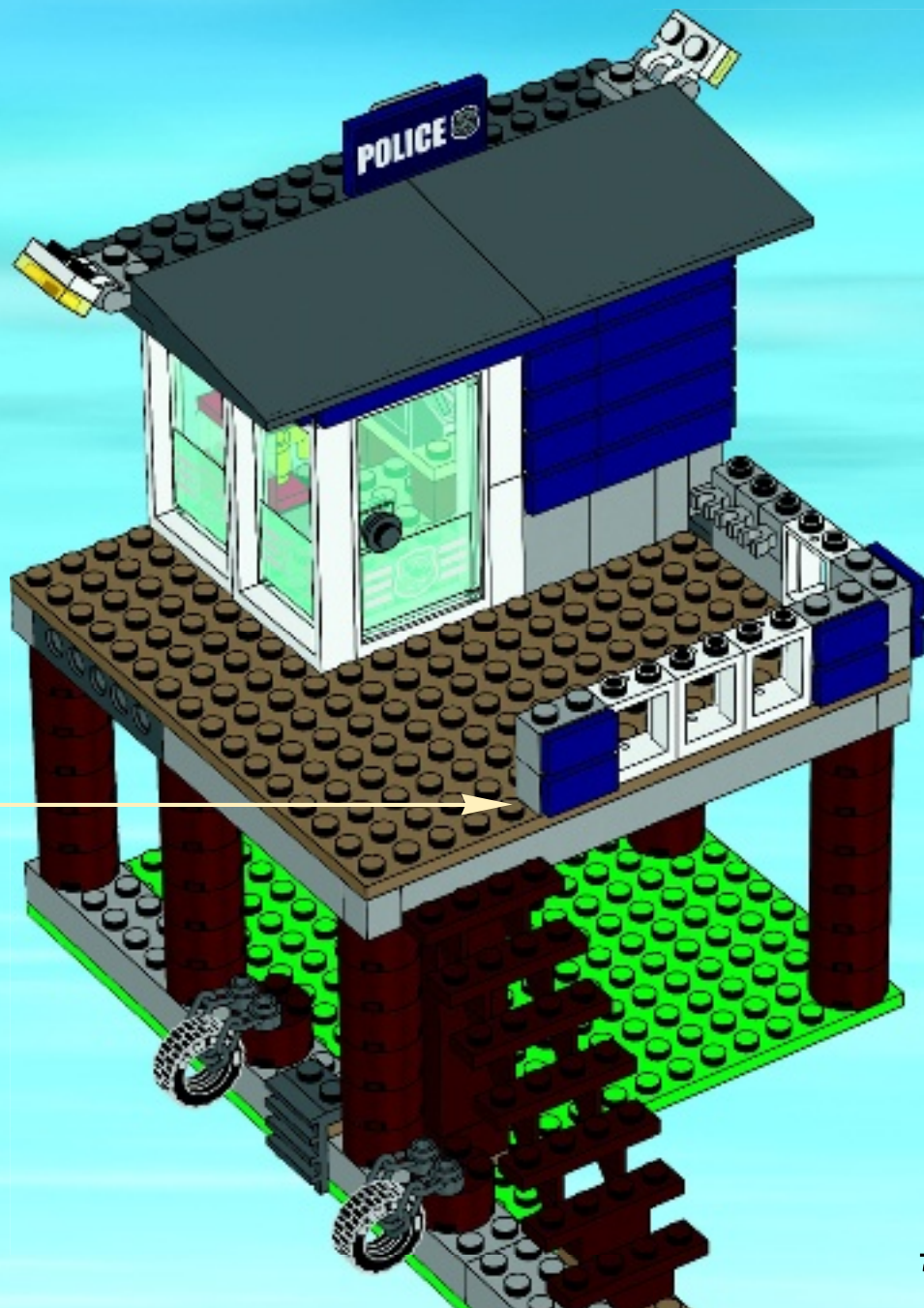



1x



1x

# 53

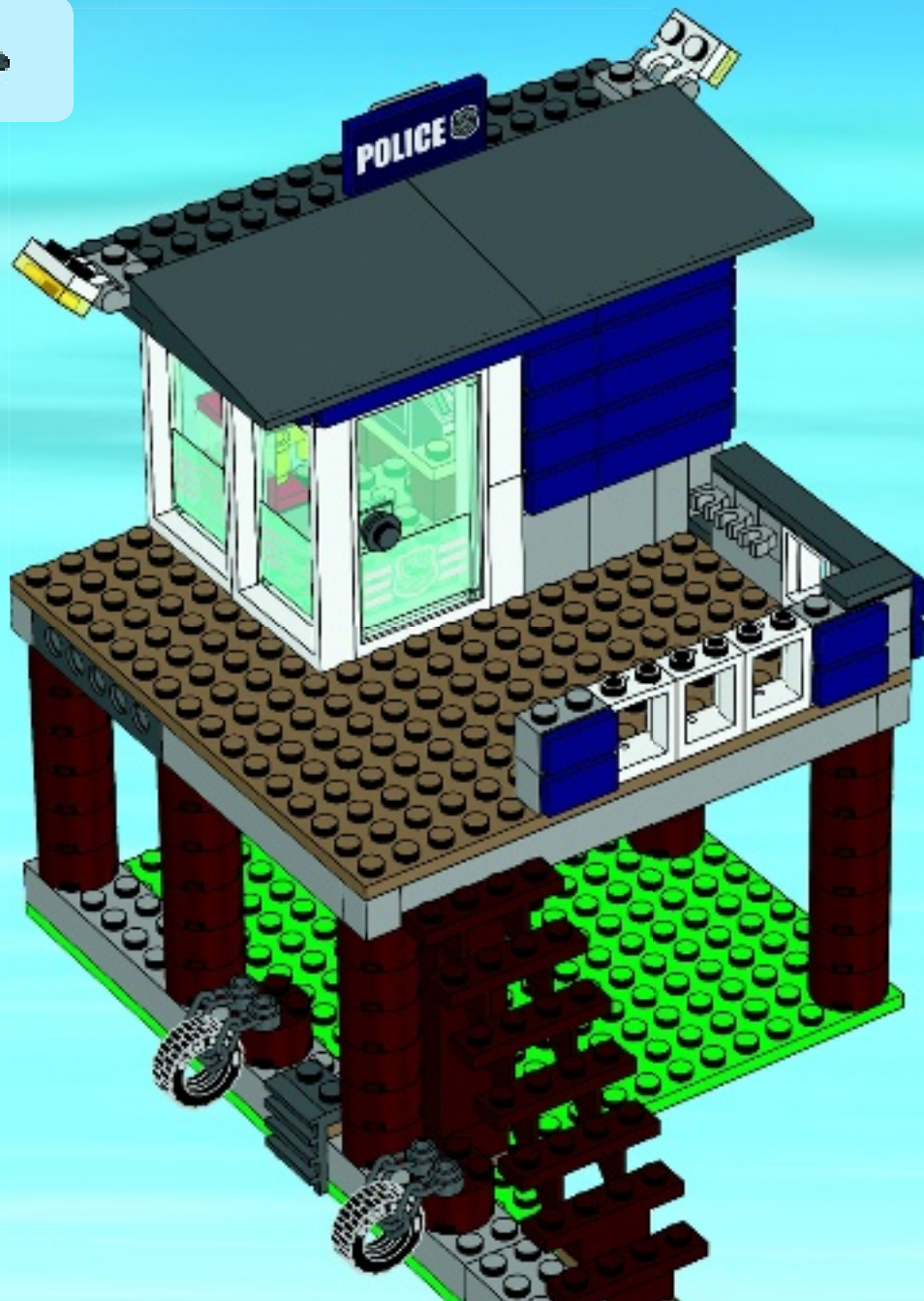



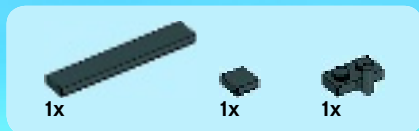

54

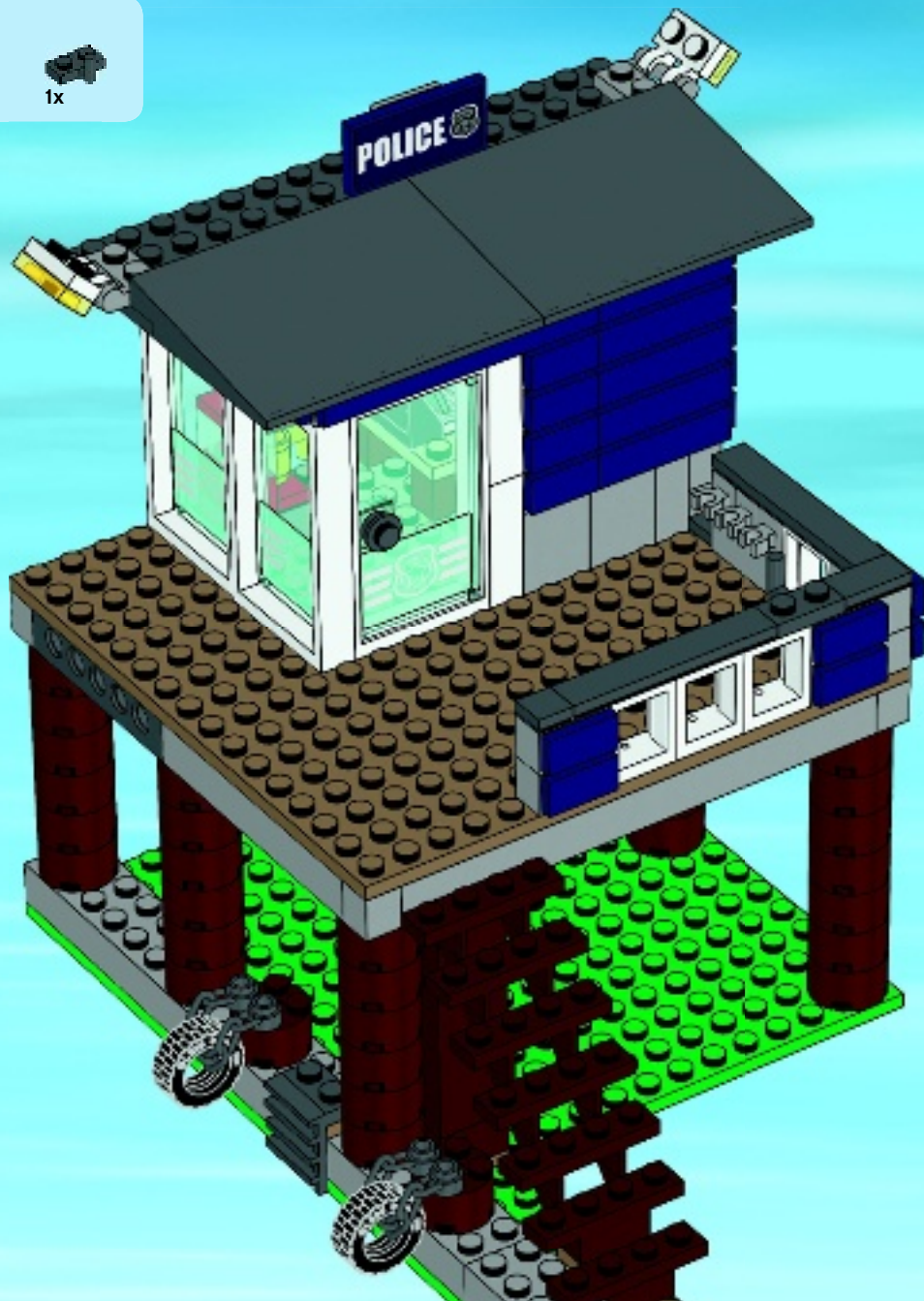

- 1x 
- 1x 
- 1x 
- 1x 

55





1x



1x

# 56





4x



4x

# 57

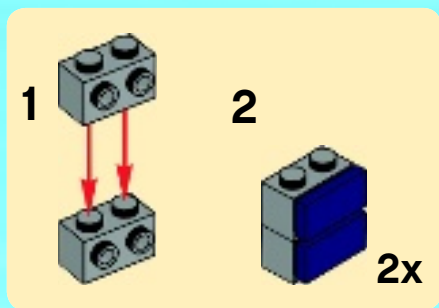



1x



3x

# 58





2x

# 59



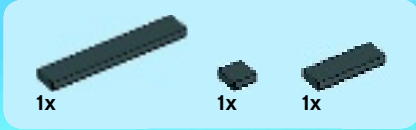

60





1x

1

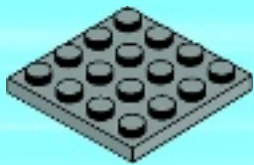

2x

2

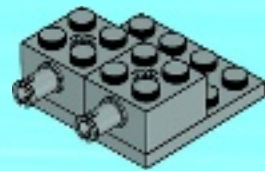



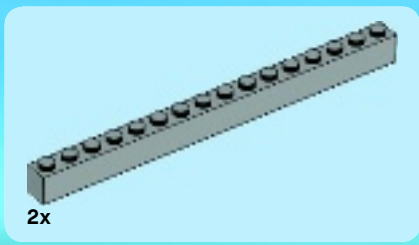

**3**

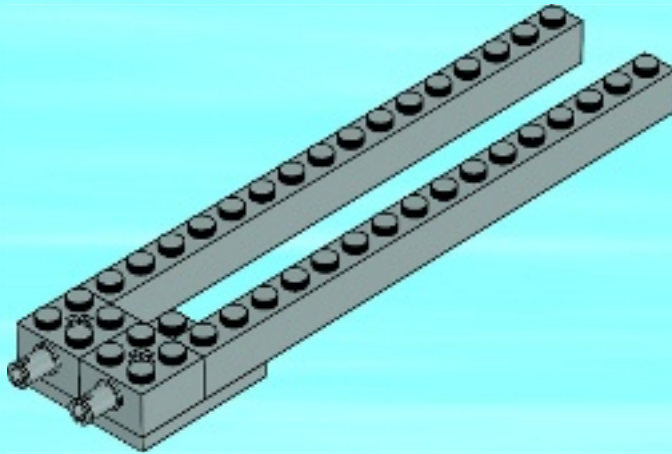

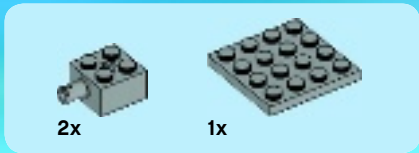

4

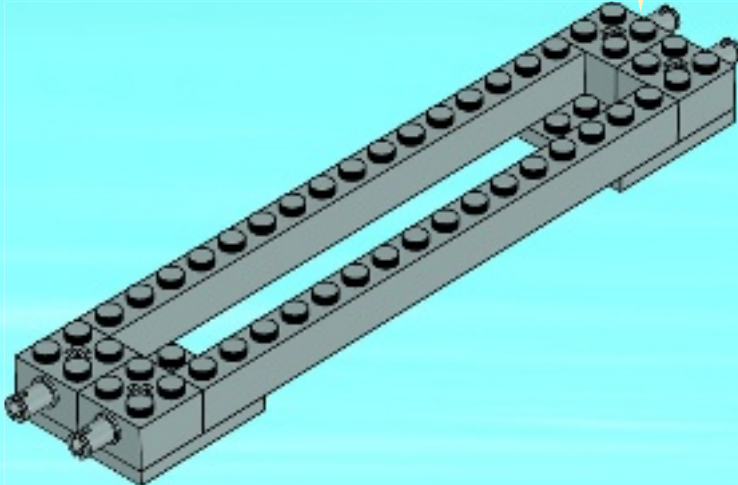
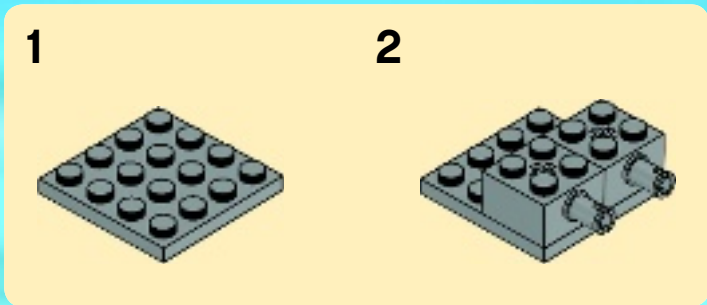

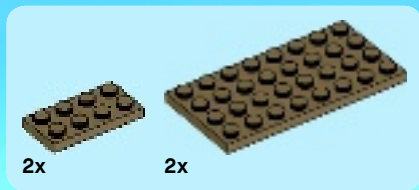

5

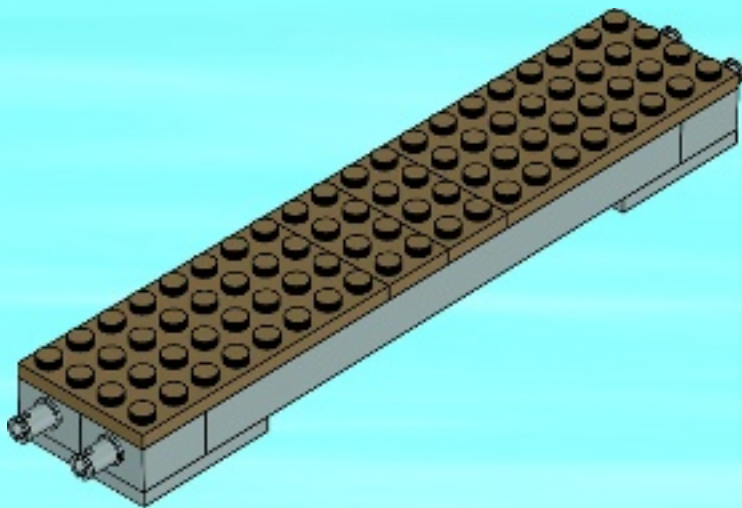



# 6

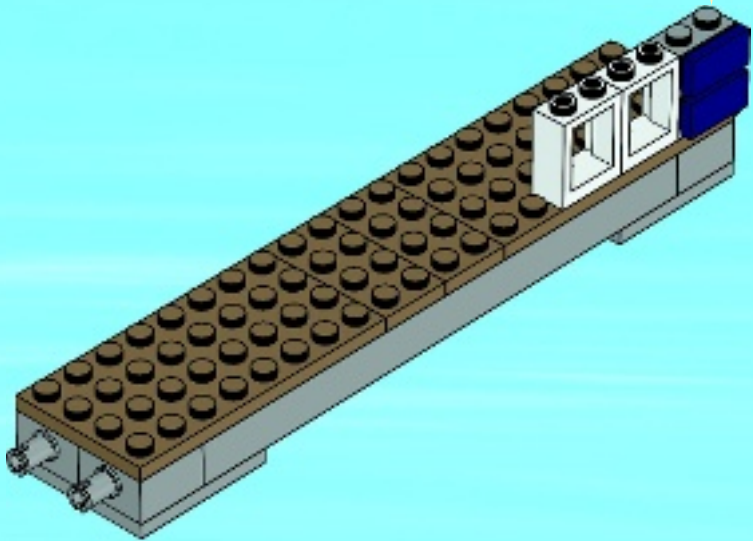
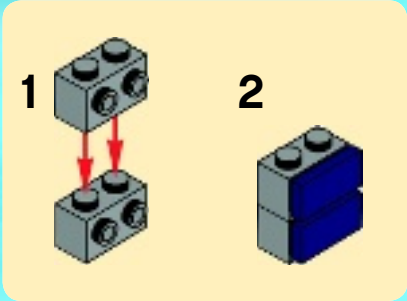



1x



1x



1x



1x

# 7

1

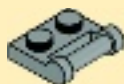

2

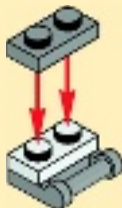

3

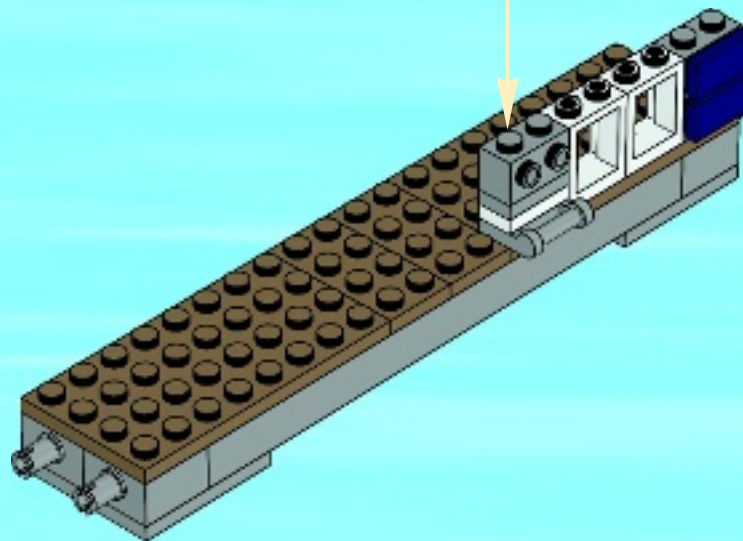
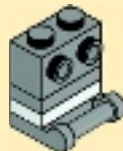



2x



2x



2x

# 8

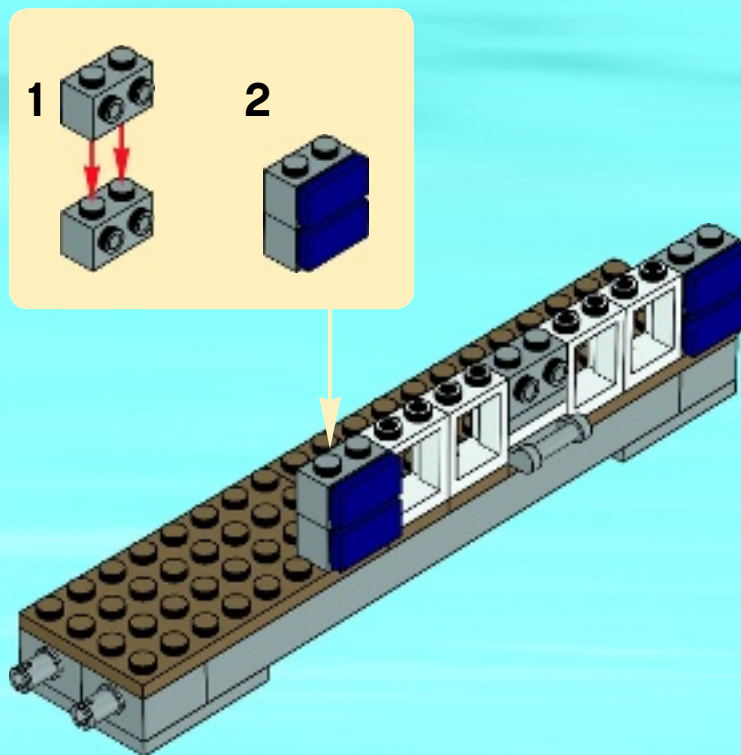



9

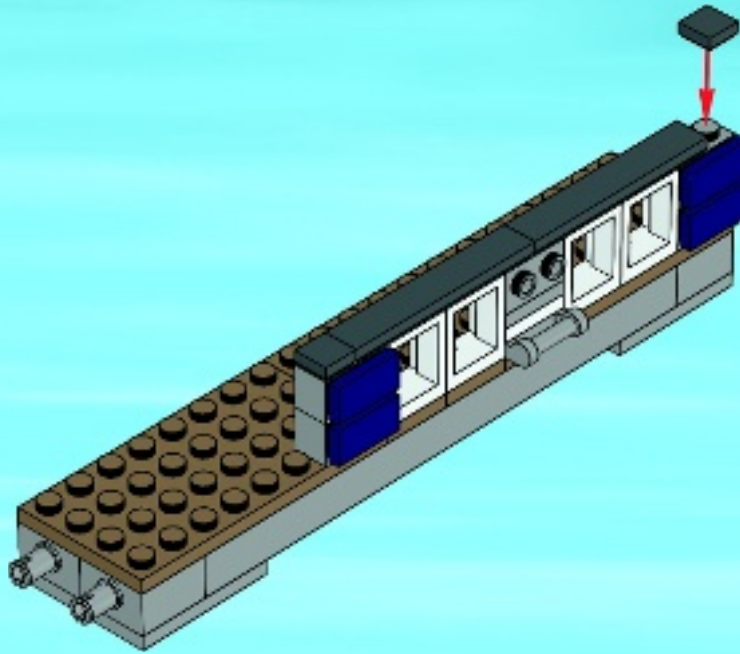



1x



1x

# 10

1



2

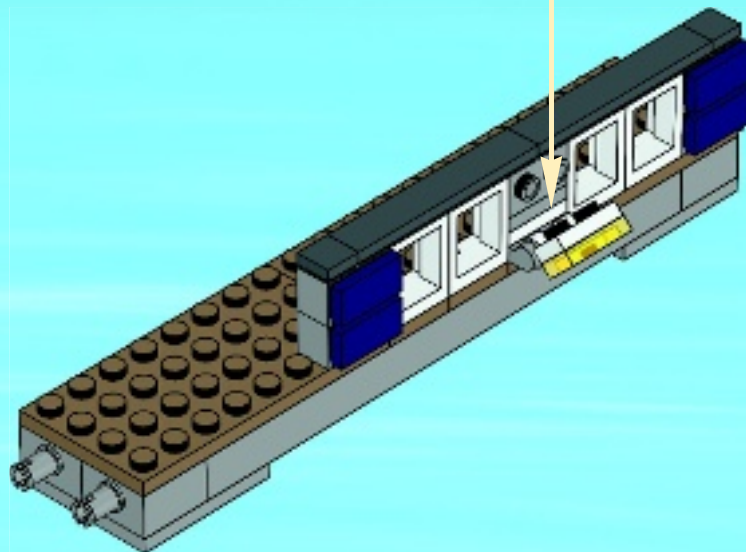





1x

# 11

1



2

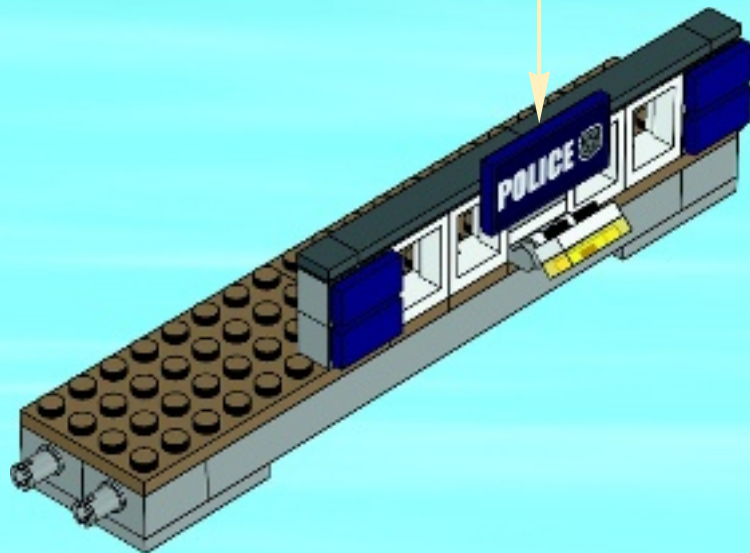

12

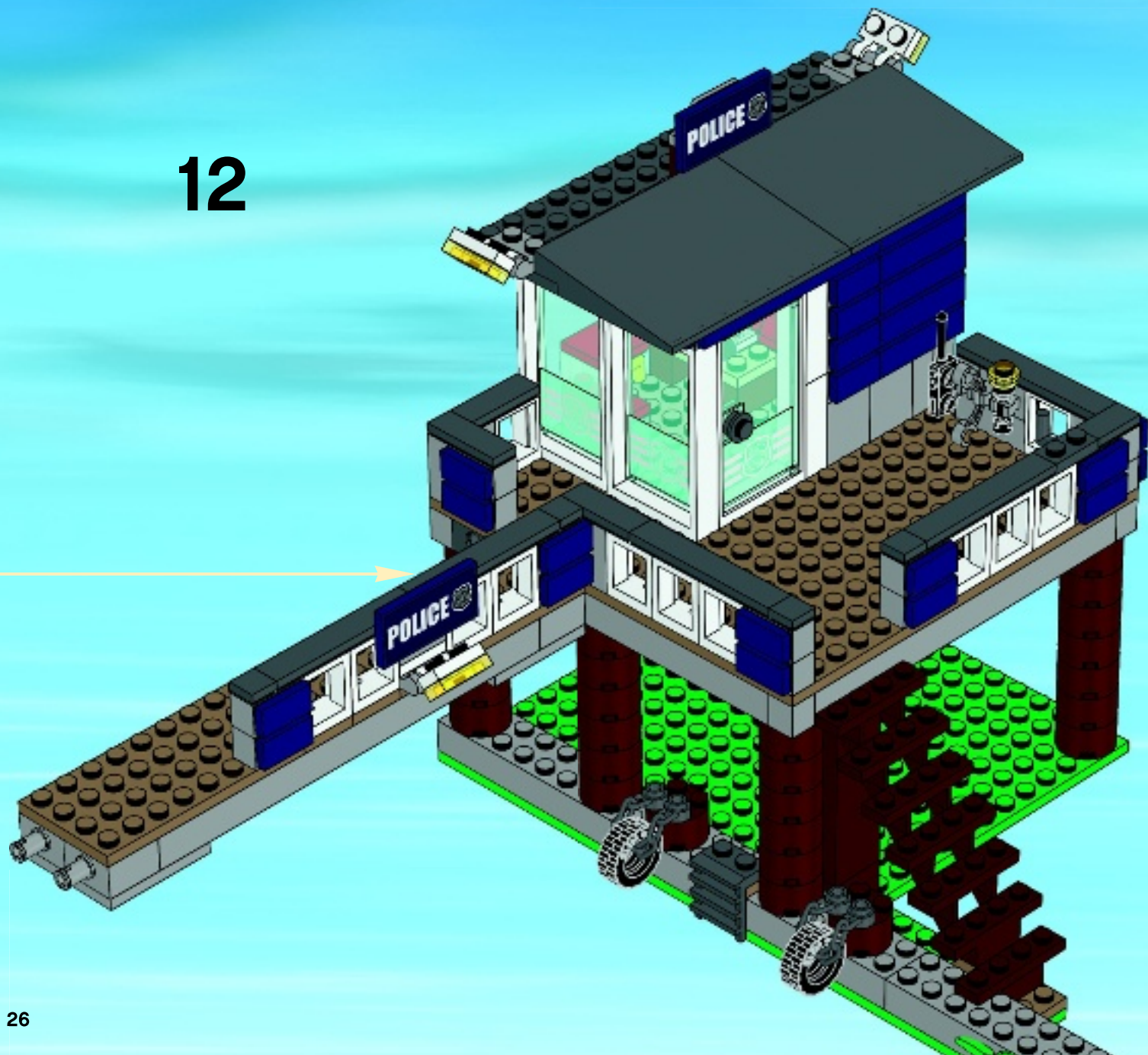



1x

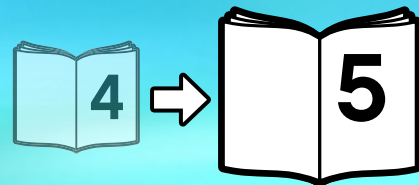

# 13



# WIN

GO TO [WWW.LEGO.COM/PRODUCTFEEDBACK](http://WWW.LEGO.COM/PRODUCTFEEDBACK) AND  
GIVE US YOUR SHORT **FEEDBACK** ABOUT THIS  
LEGO® SET FOR A CHANCE TO WIN  
A COOL LEGO PRIZE.



## LEGO.com/productfeedback

### GEWINNE



Erzähle uns auf  
[www.LEGO.com/productfeedback](http://www.LEGO.com/productfeedback)

*etwas über die Erfahrungen, die du mit  
diesem LEGO® Set gemacht hast, und  
sichere dir die Chance auf einen coolen  
LEGO Preis!*

### GAGNE



Rends-toi sur  
[www.LEGO.com/productfeedback](http://www.LEGO.com/productfeedback)

*et donne-nous quelques commentaires  
sur ce produit LEGO® pour avoir une  
chance de gagner un prix LEGO !*

### GANA



Visita  
[www.LEGO.com/productfeedback](http://www.LEGO.com/productfeedback)

*y envíanos tu opinión acerca de este set  
LEGO®. ¡Participarás en el sorteo de un  
premio LEGO!*

### 获取奖品



登录  
[www.LEGO.com/productfeedback](http://www.LEGO.com/productfeedback)

*给出关于此乐高®套装的简短反馈，  
就有机会获得炫酷乐高奖品*



# CITY

60069







+

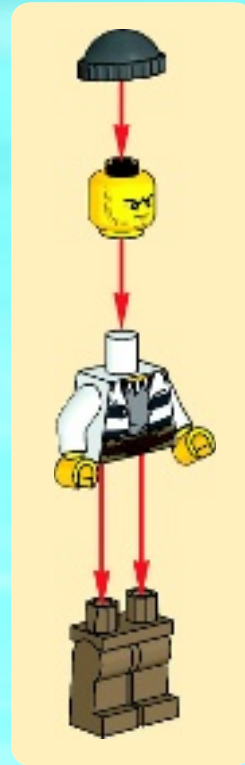

**1**

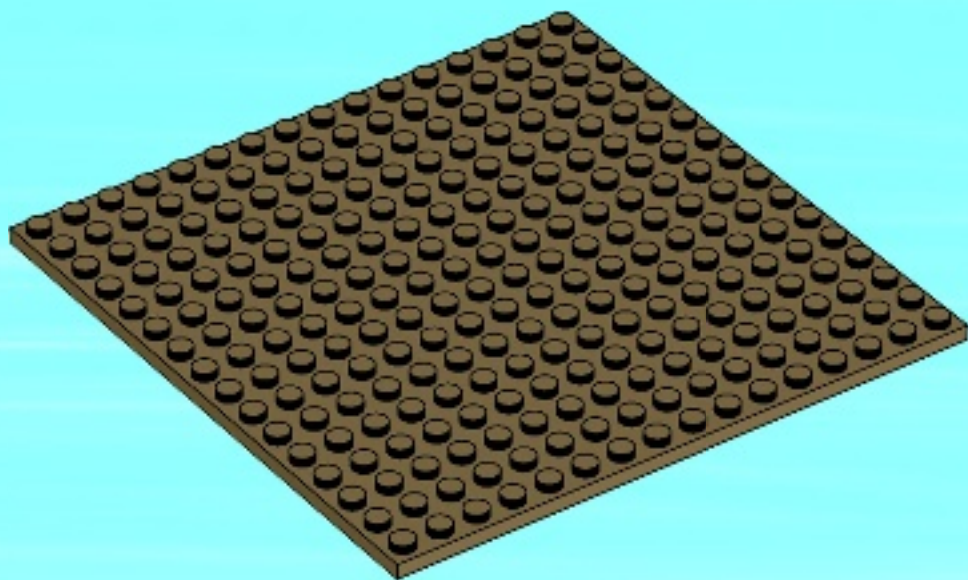





3x

2

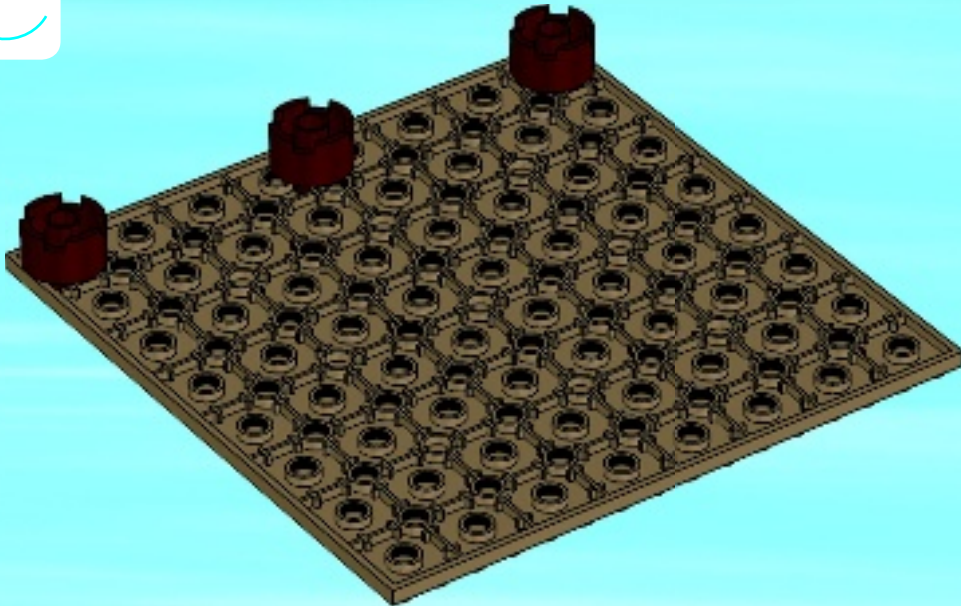



5x

3

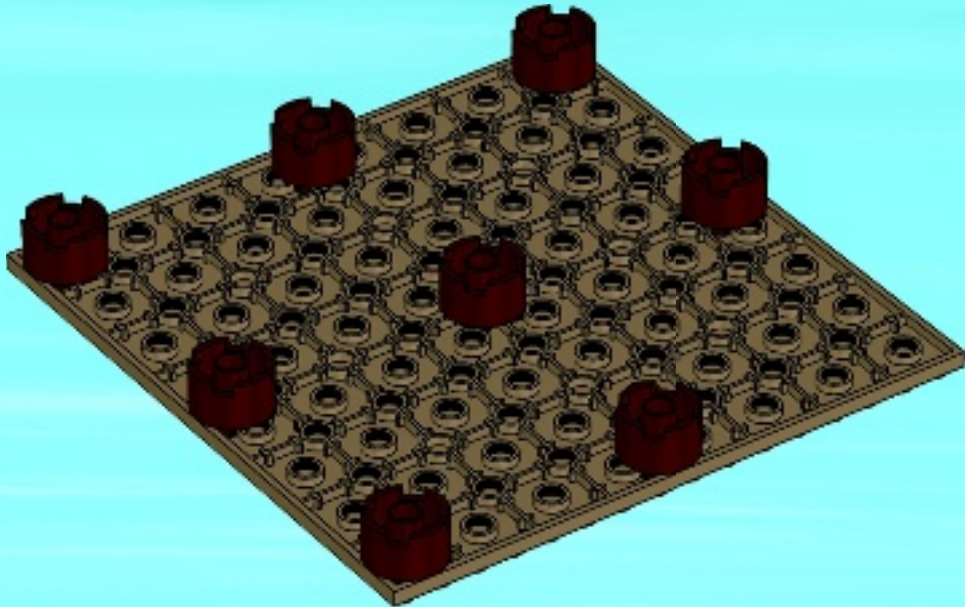

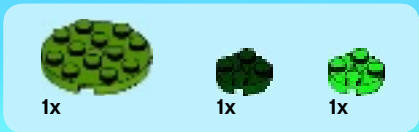

4

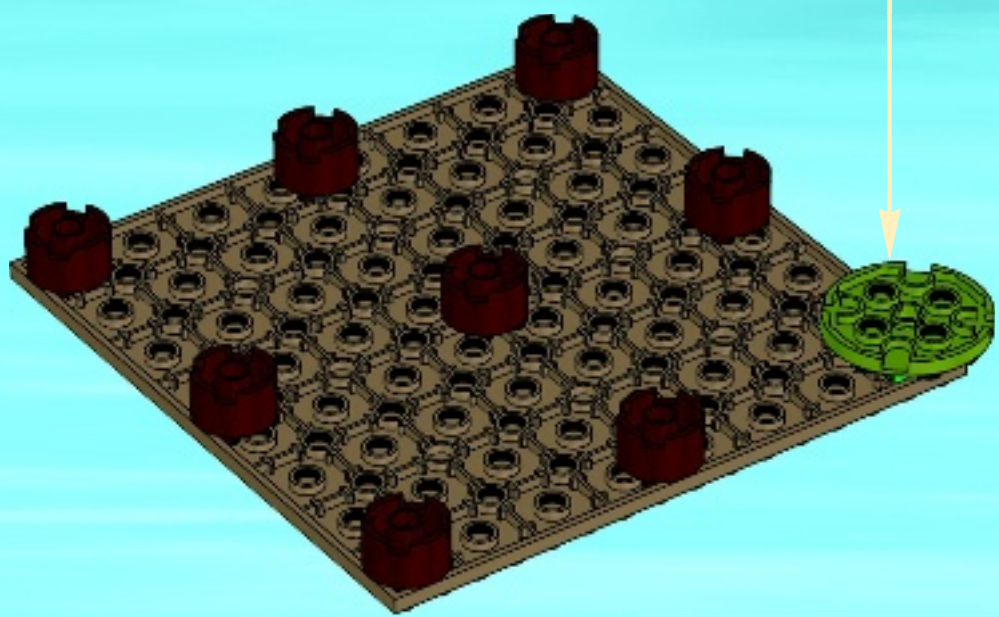



1x

5

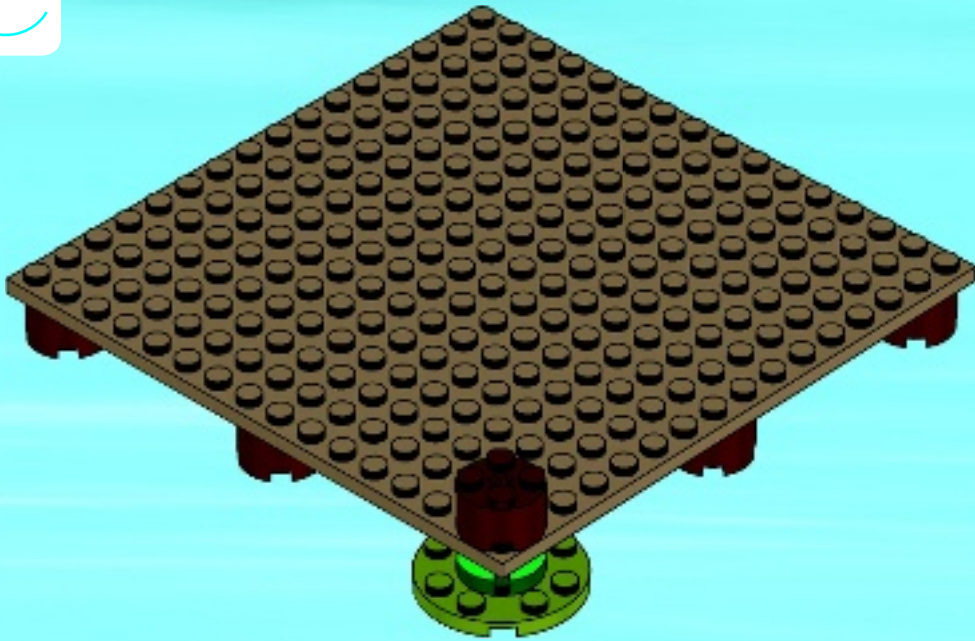



2x

6





4x

7

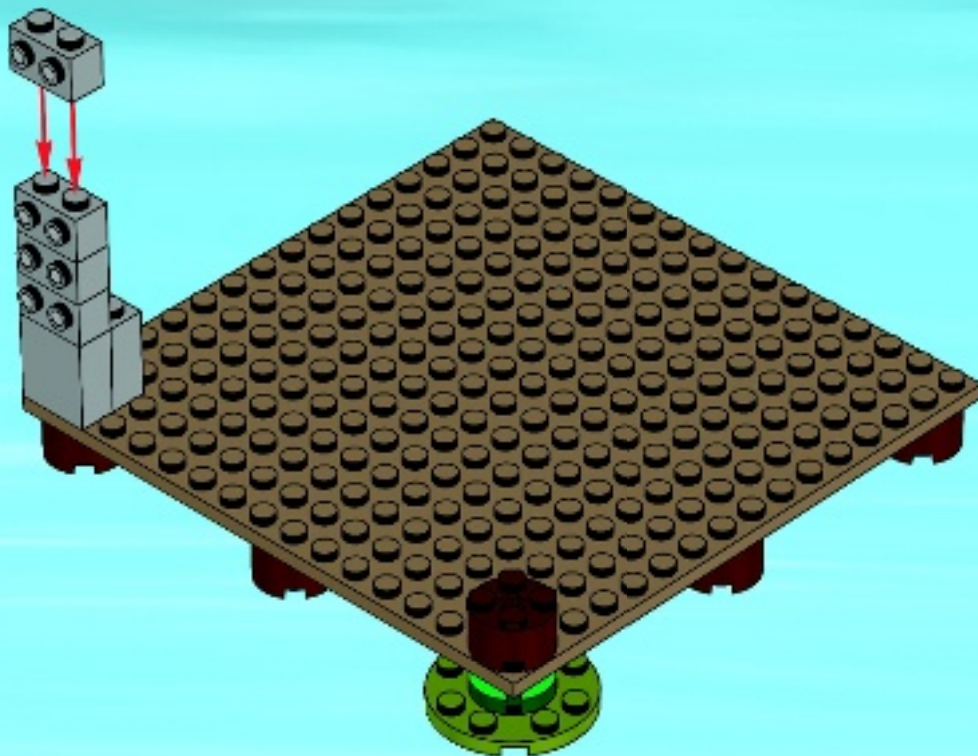

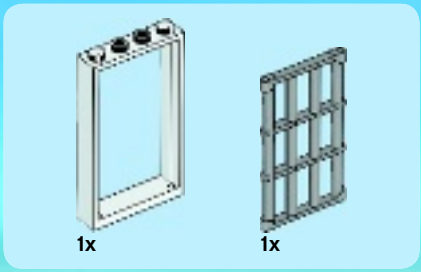

8

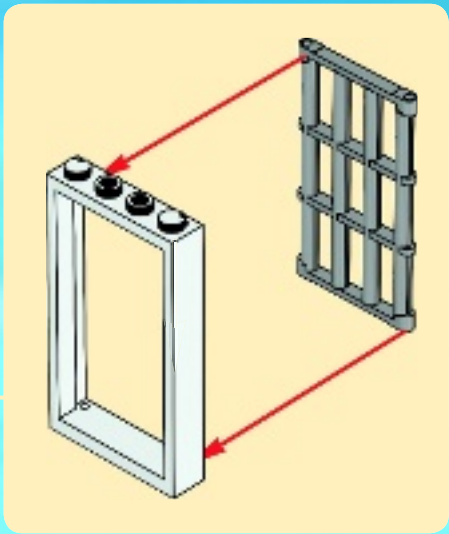



1x



1x

9







4x

# 10

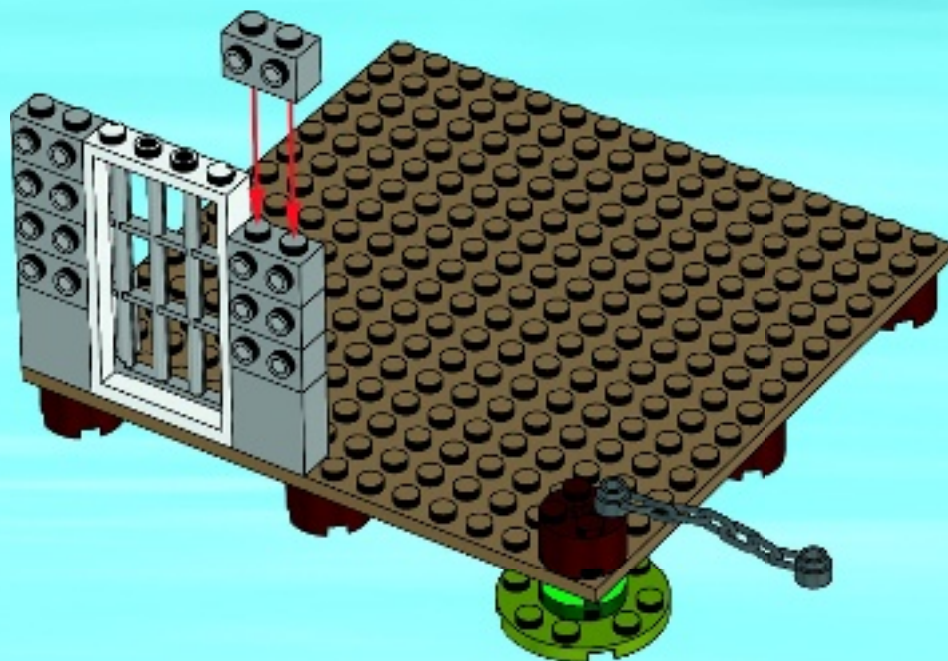



2x

11

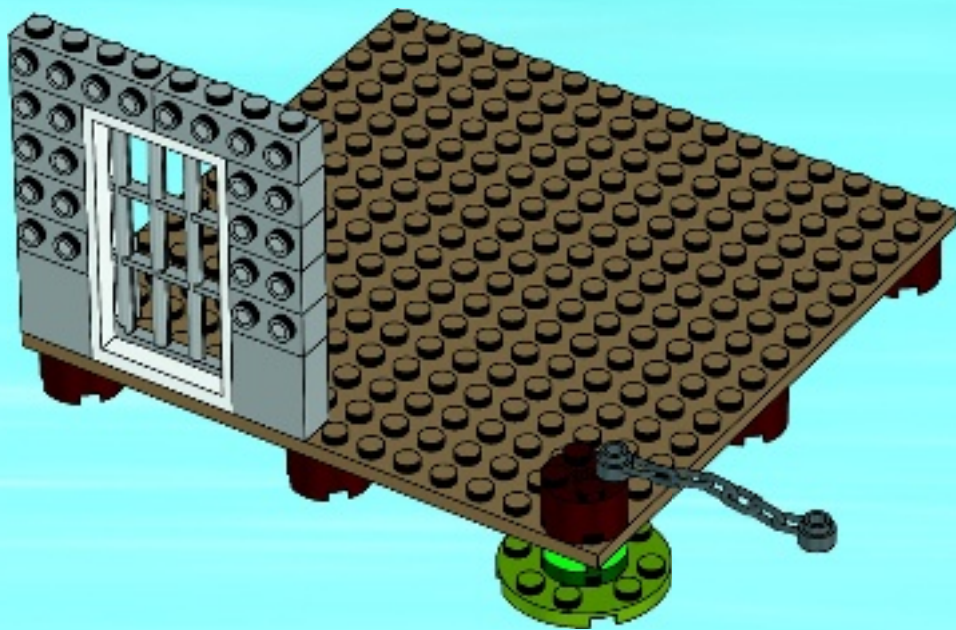



1x



1x

12

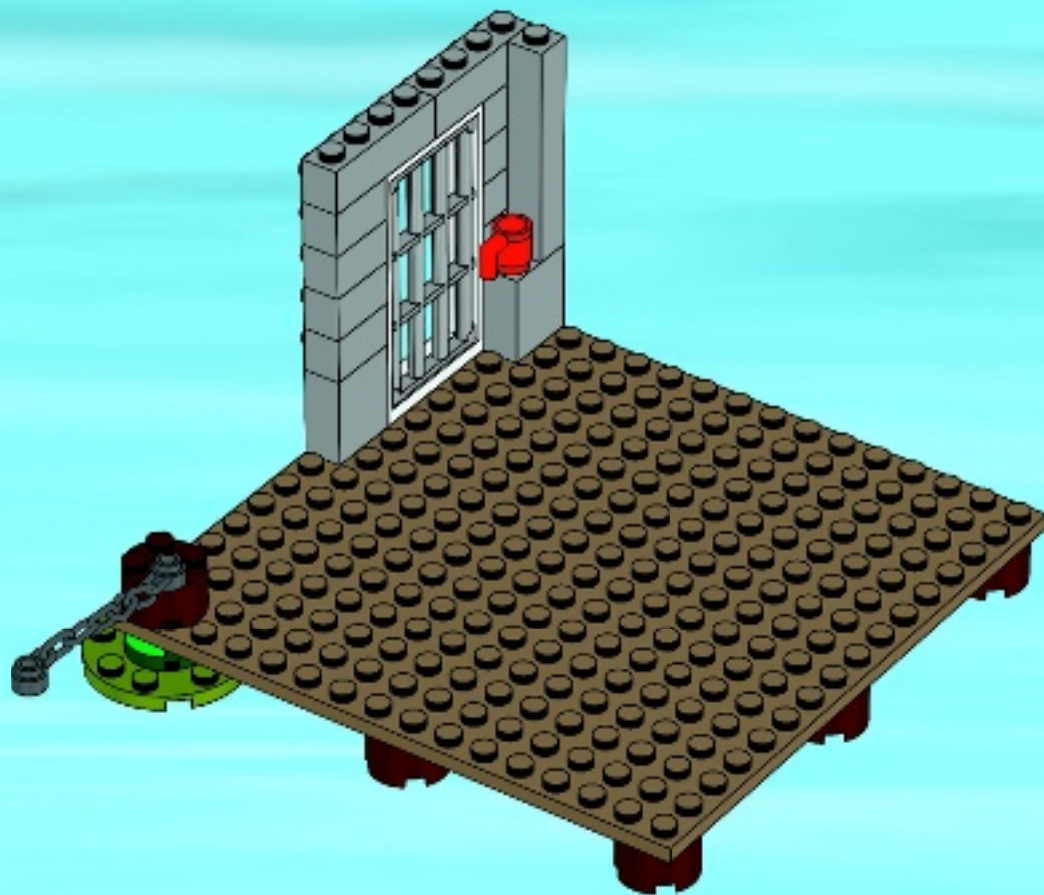

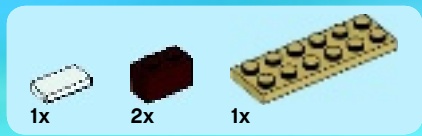

# 13

1

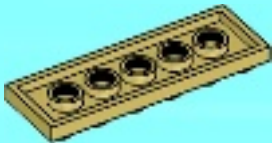

2

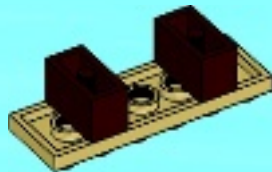

3



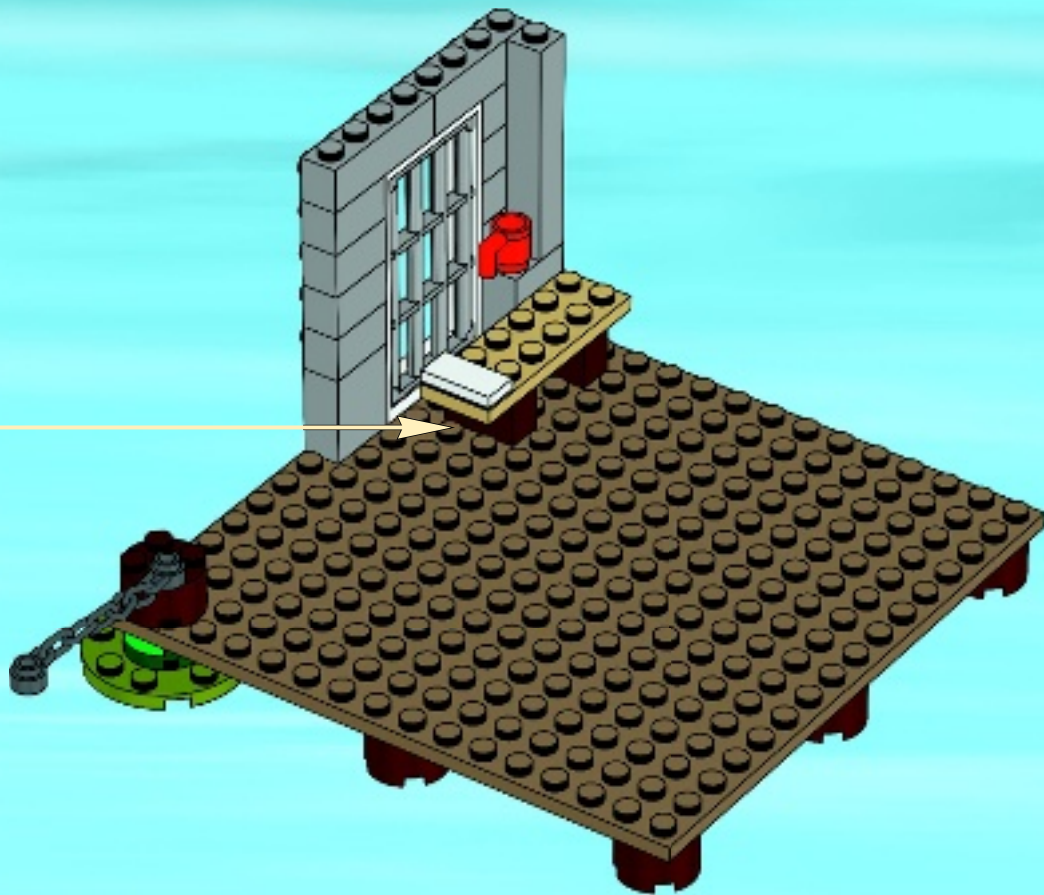

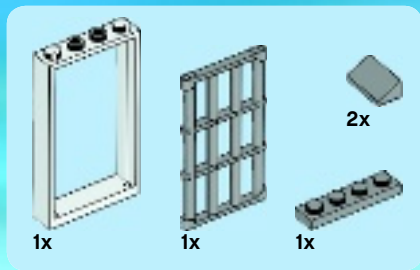

# 14

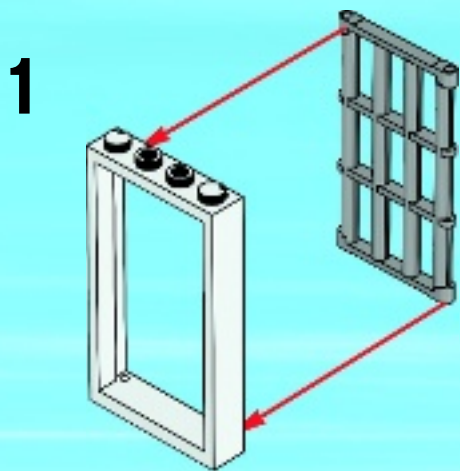

2

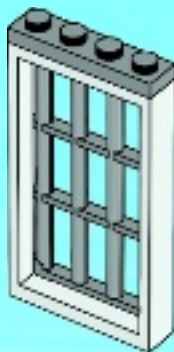

3

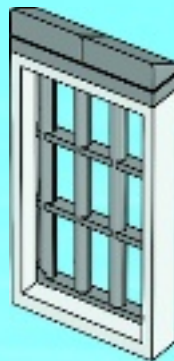

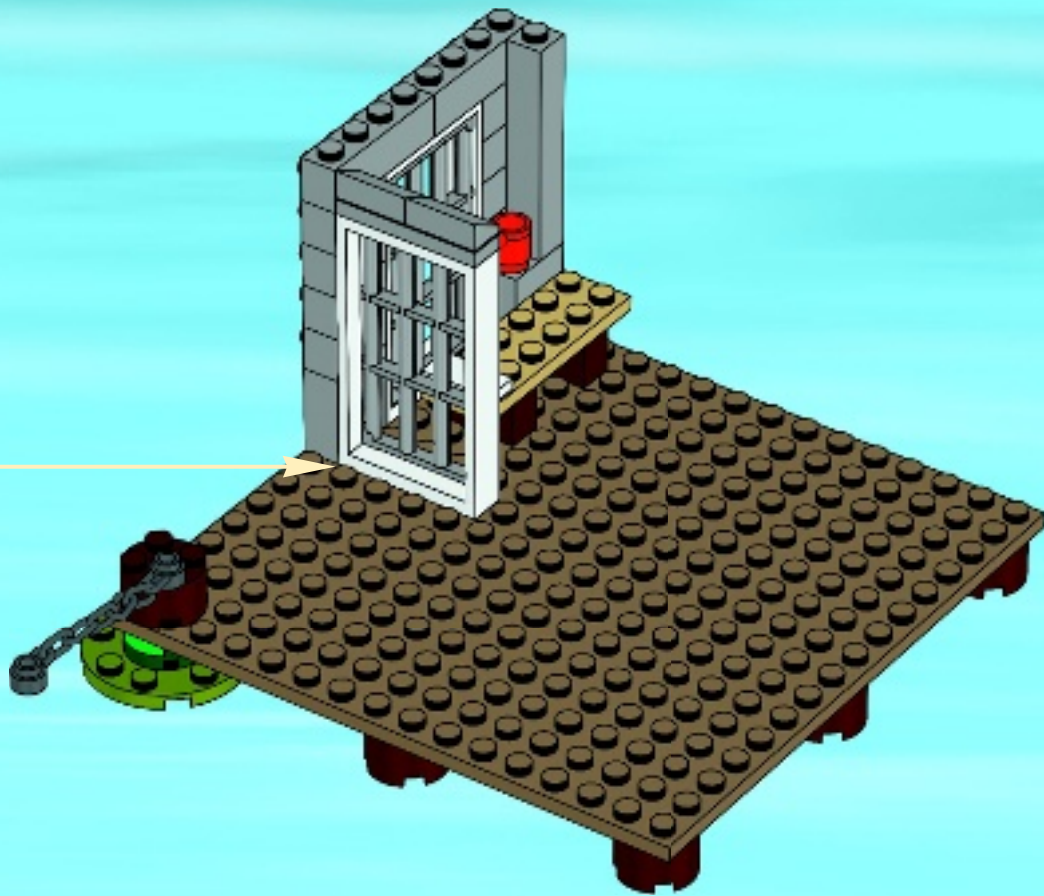

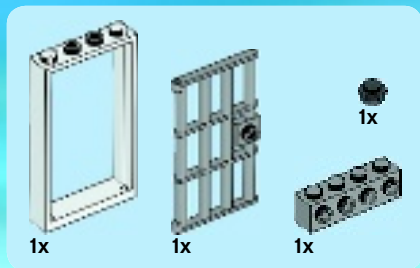

# 15

1

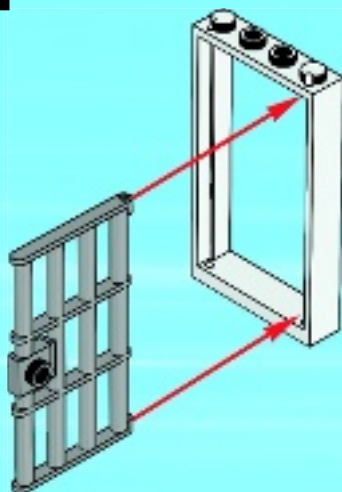

2

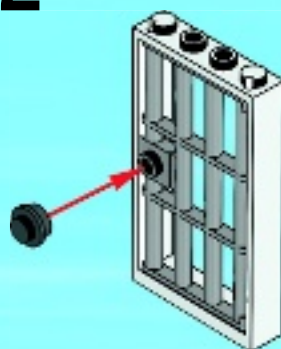

3





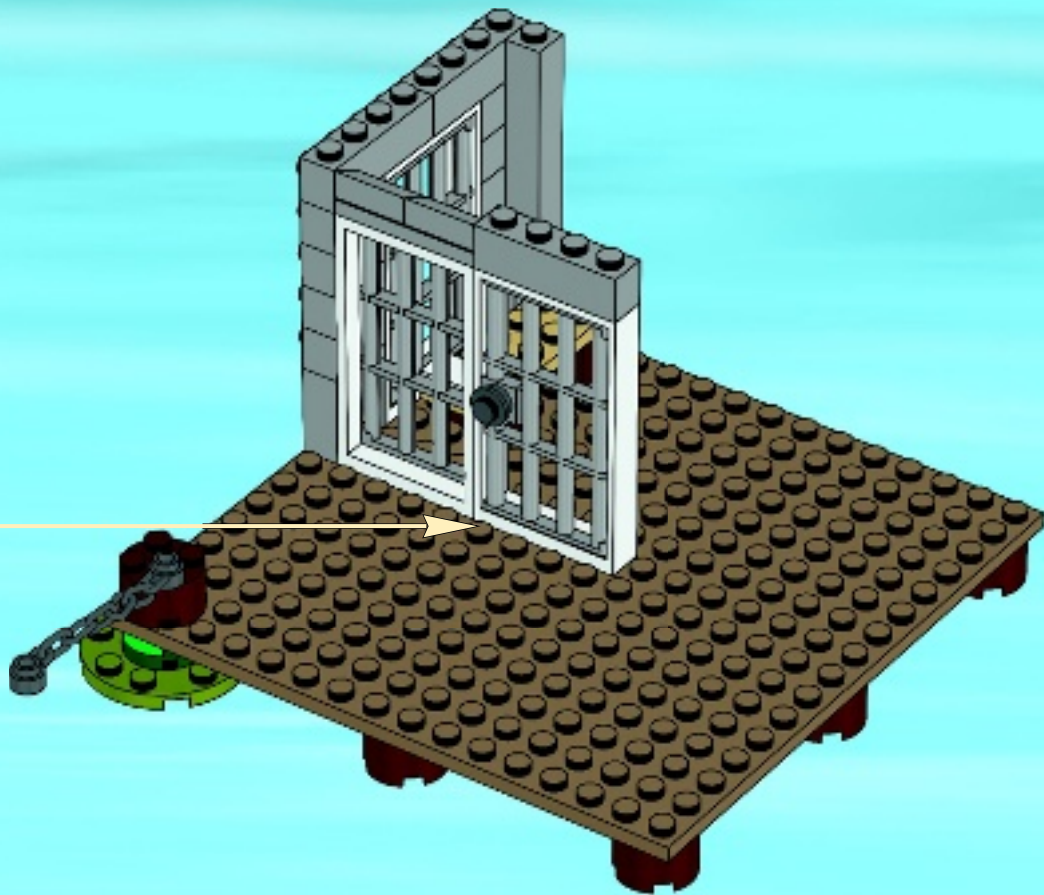



1x

# 16

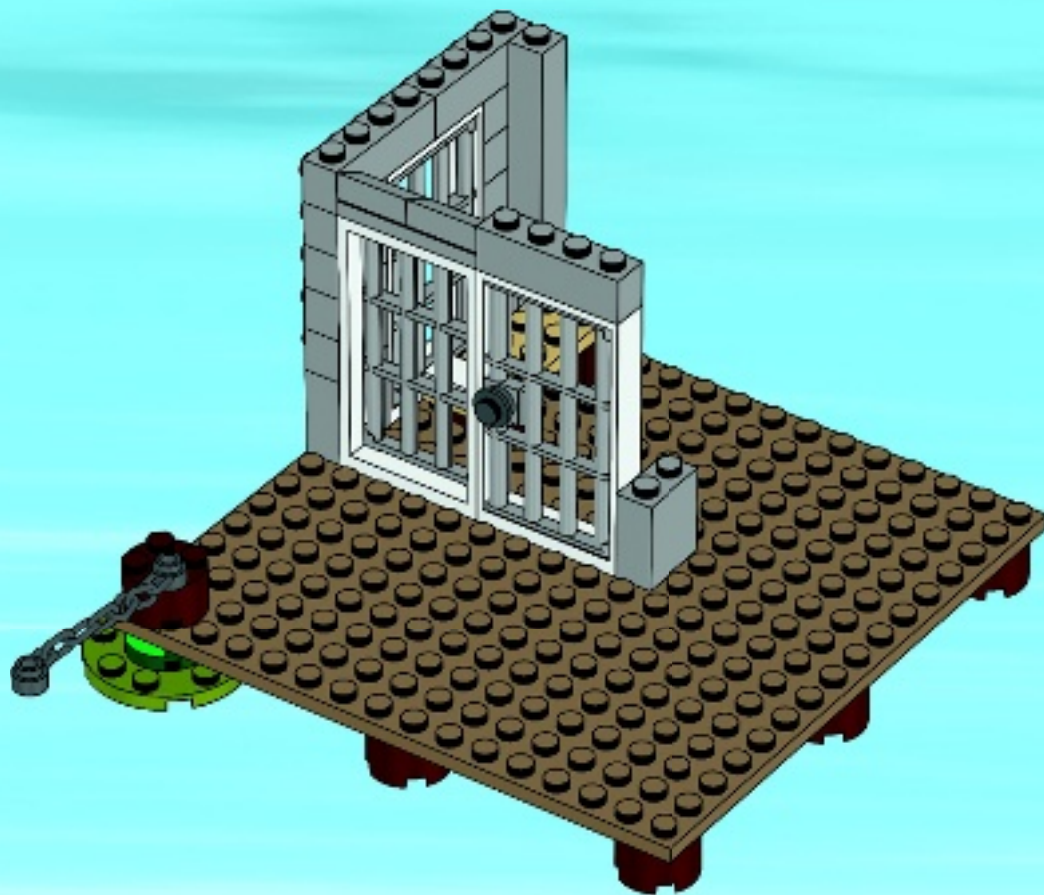

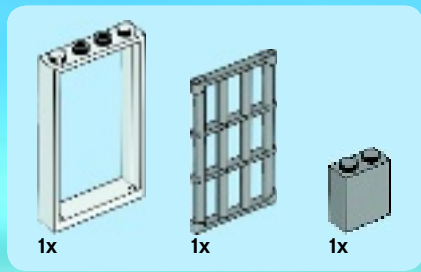

17

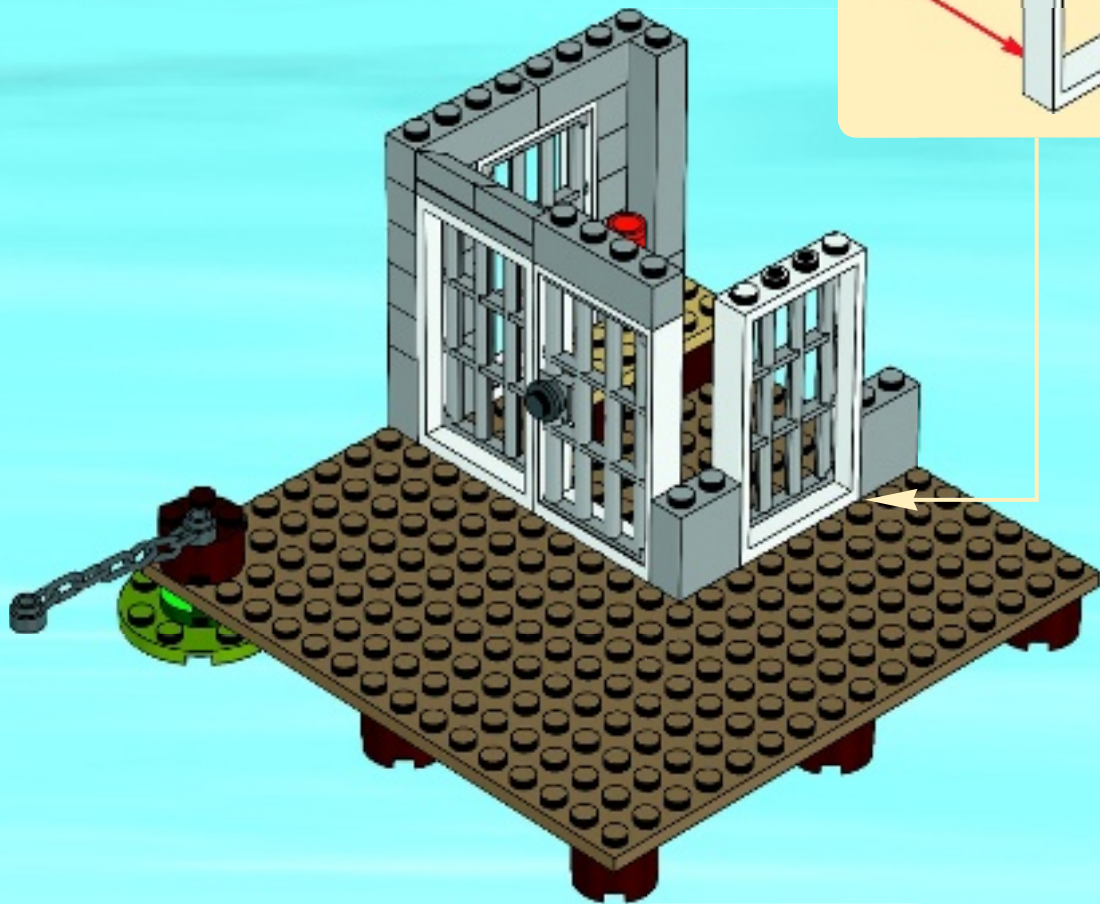
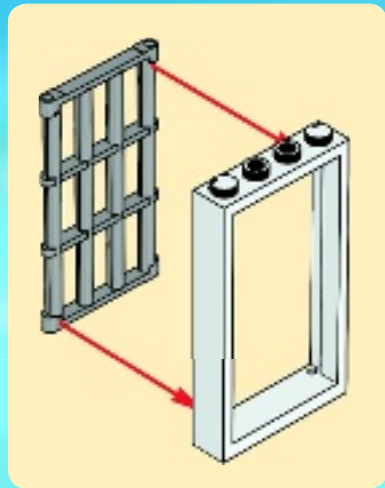



5x

# 18

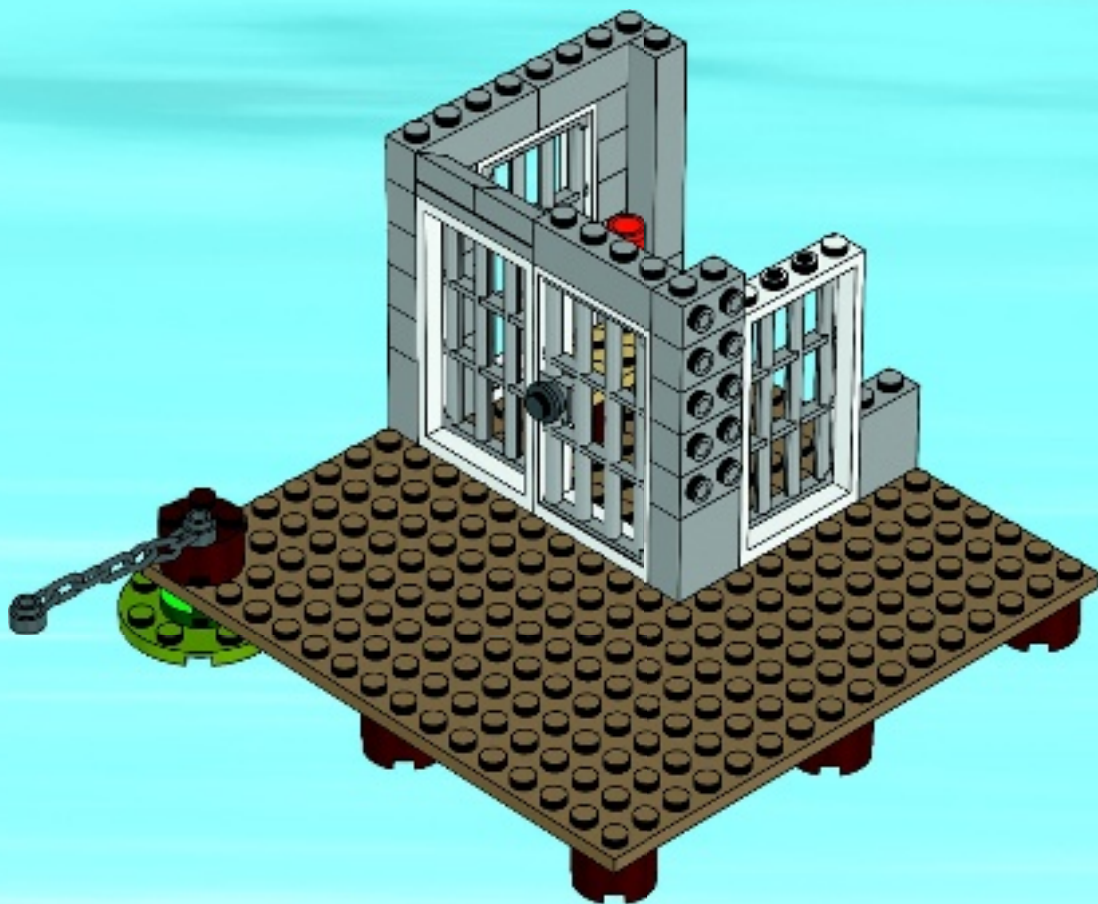

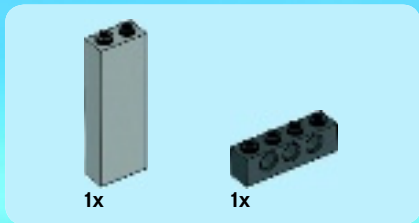

# 19

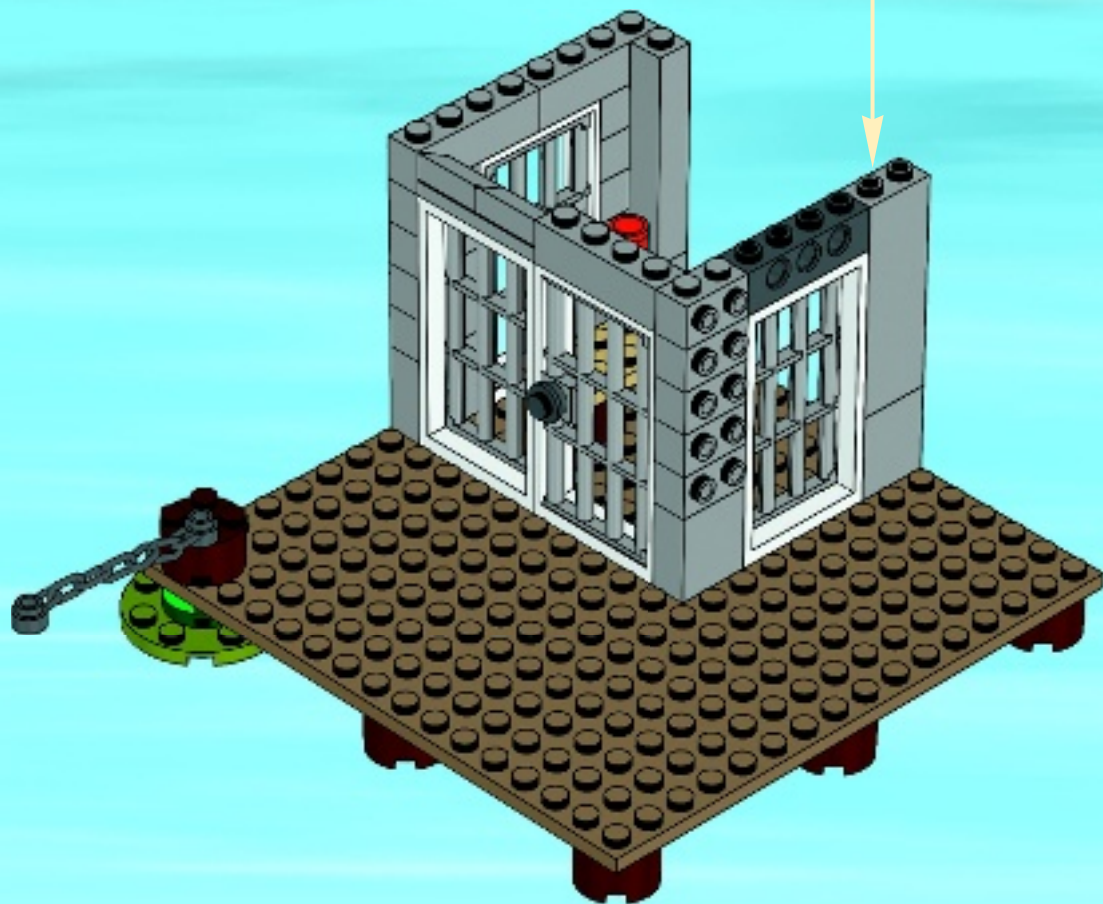
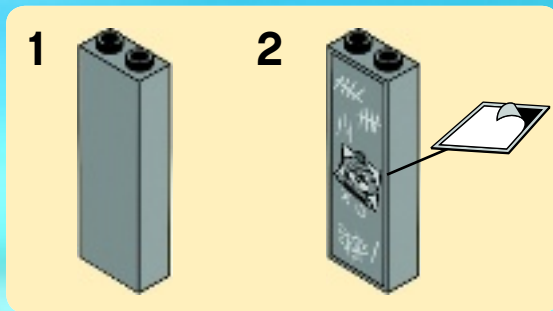

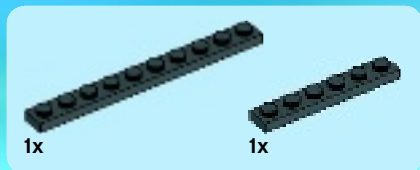

20

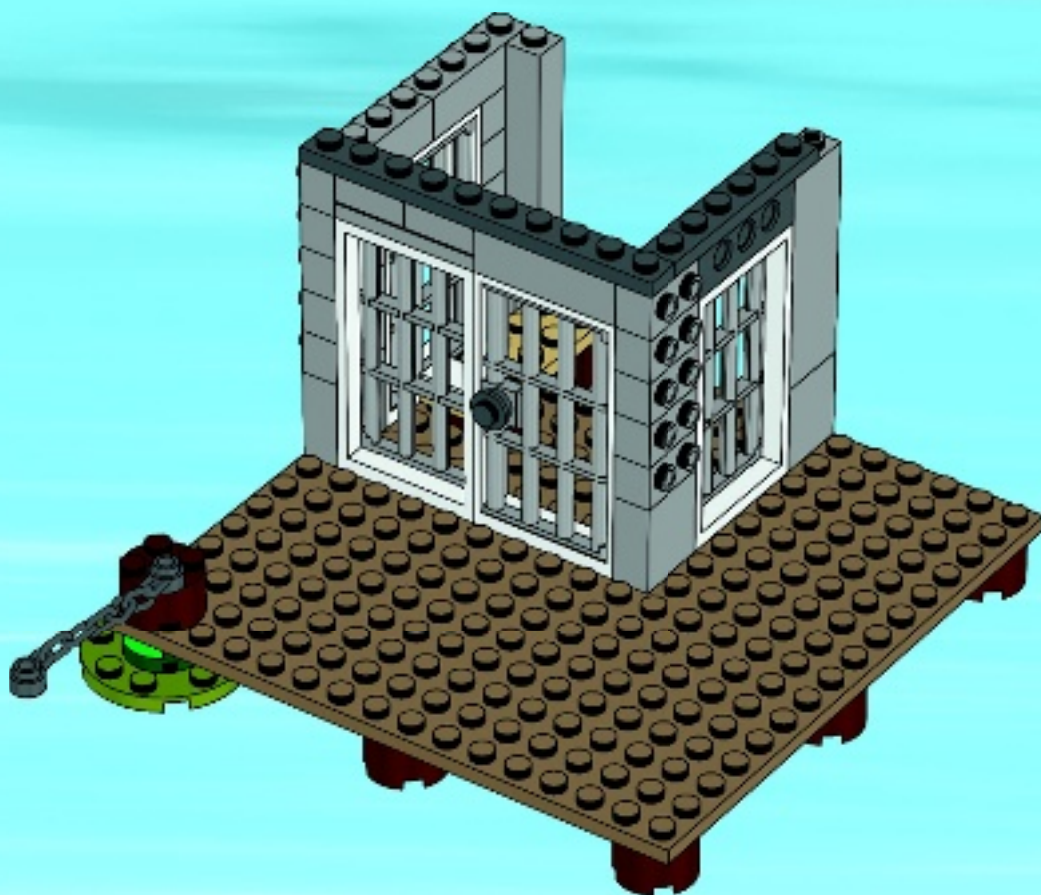



1x



1x

# 21

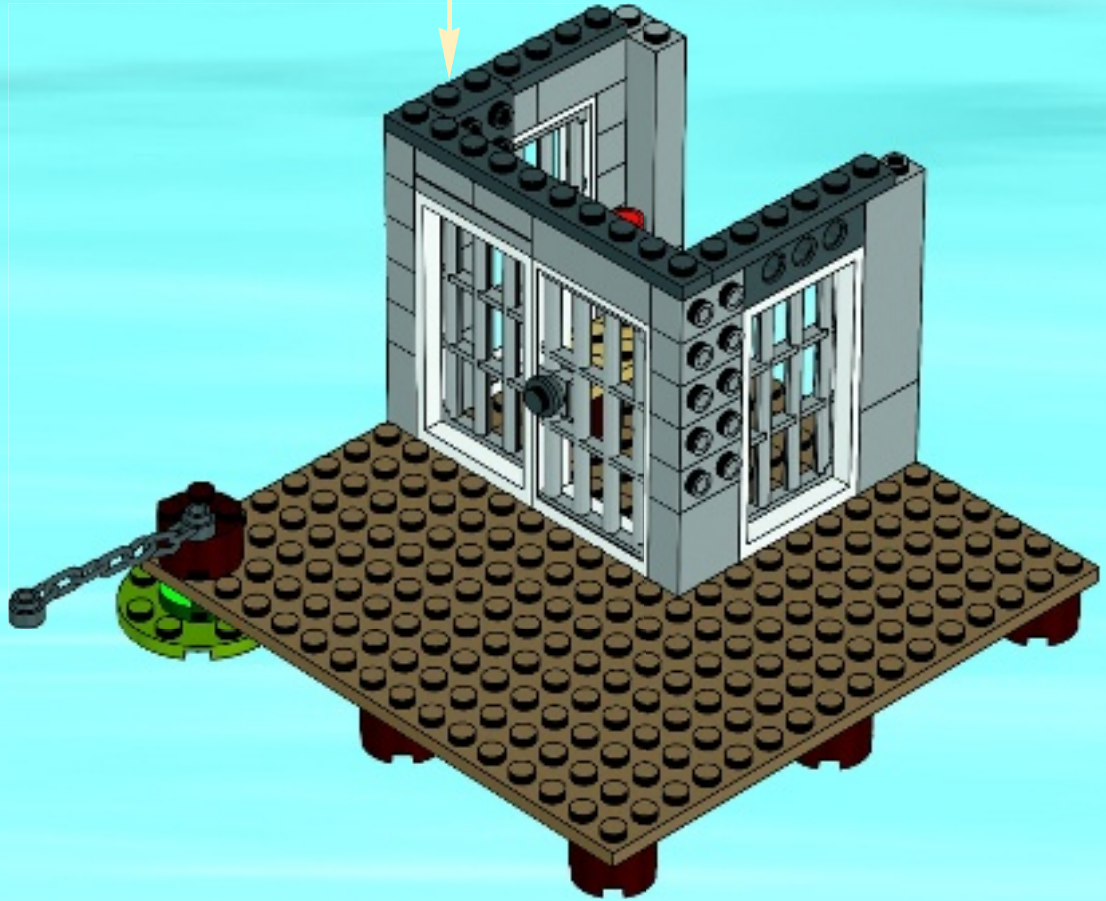



5x

# 22

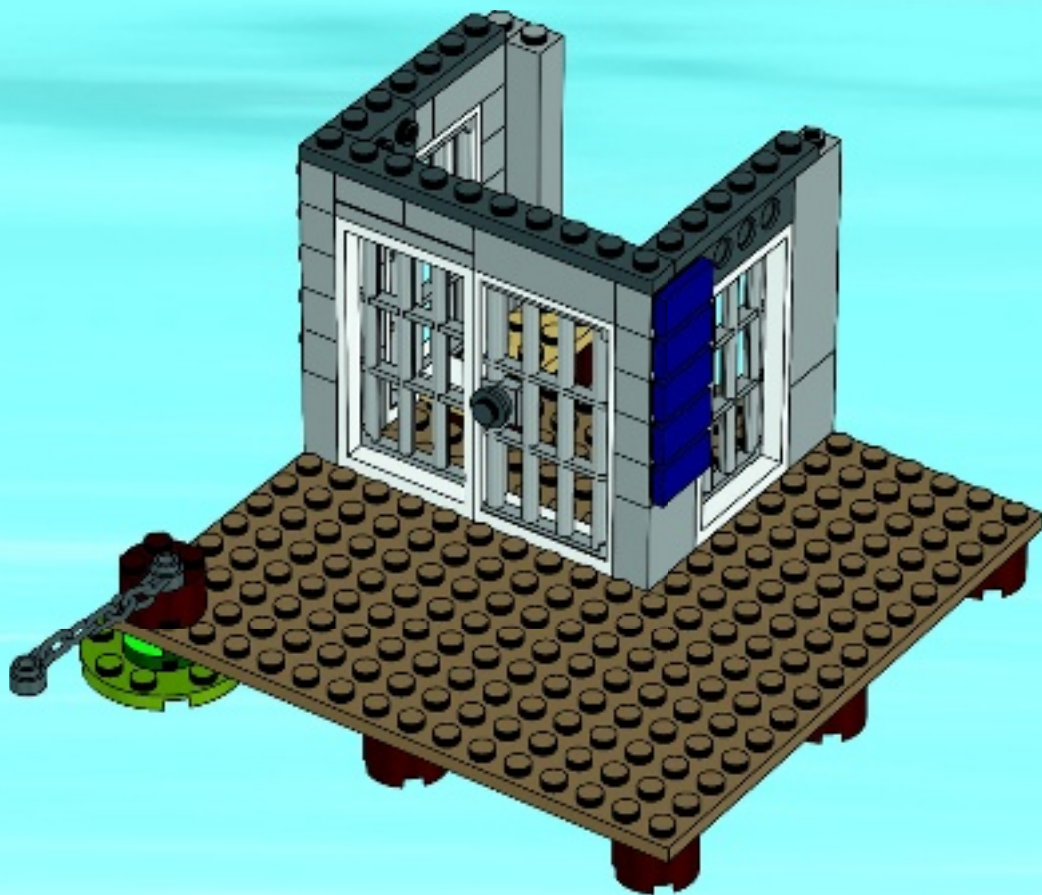





1x



2x

# 23

1



2

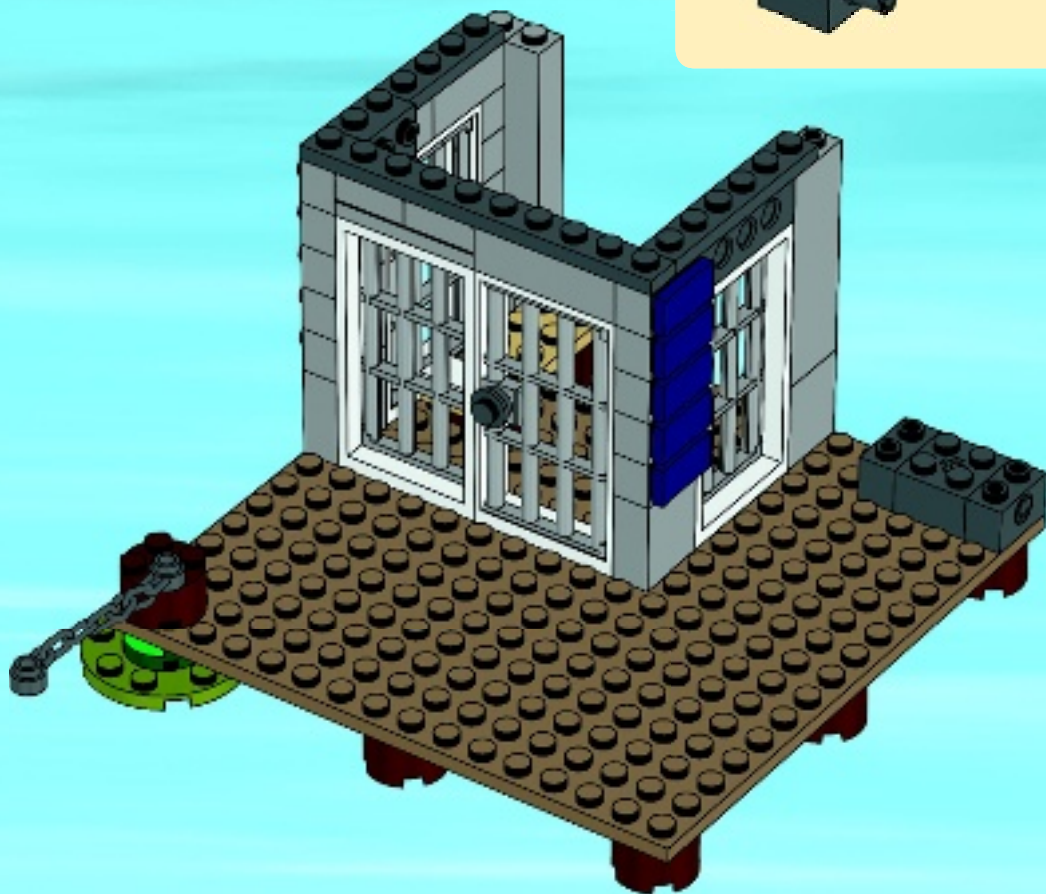
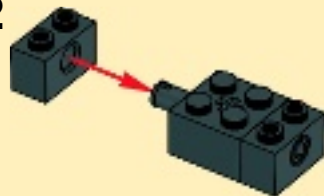



2x



1x

# 24

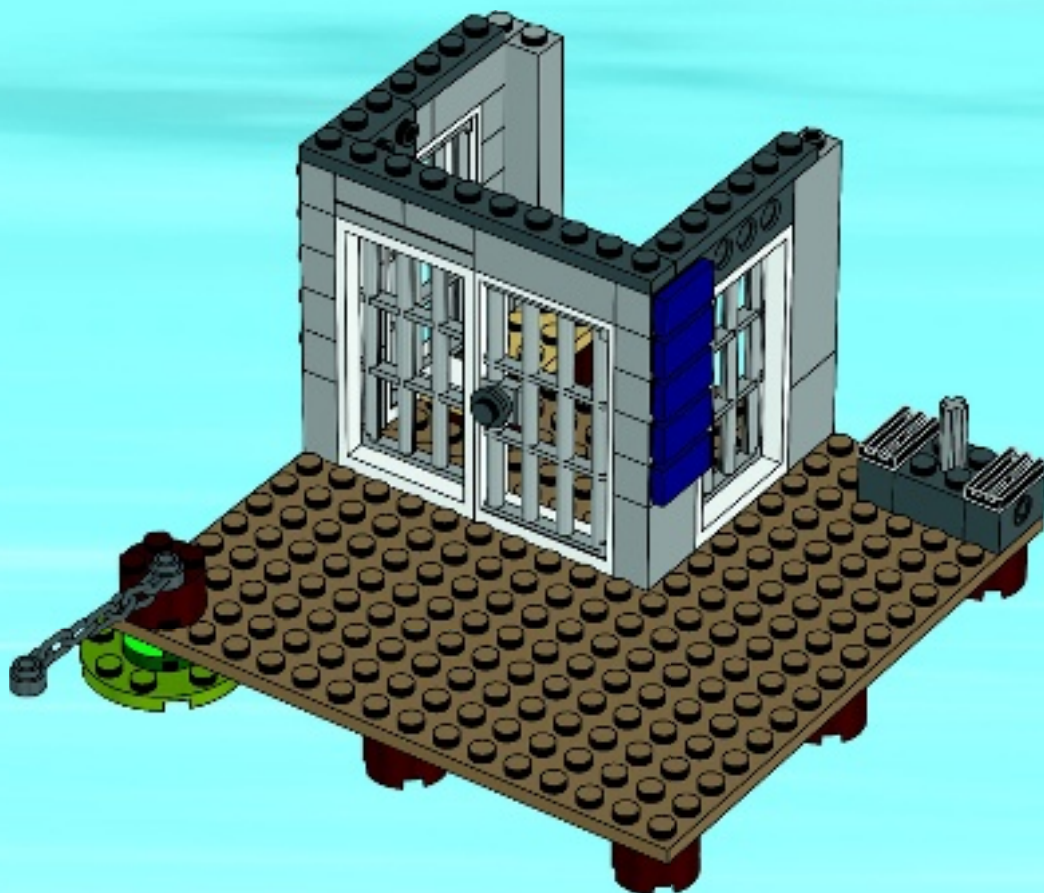



1x



2x



1x



1x

# 25

1



2



3

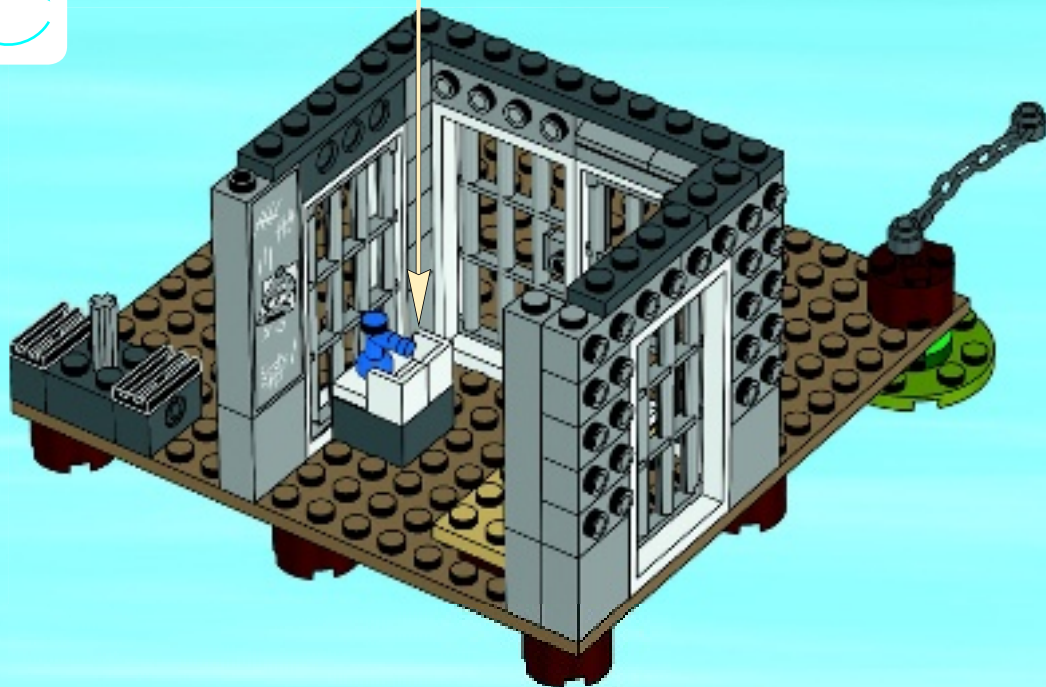



1x



1x



1x



1x

# 26

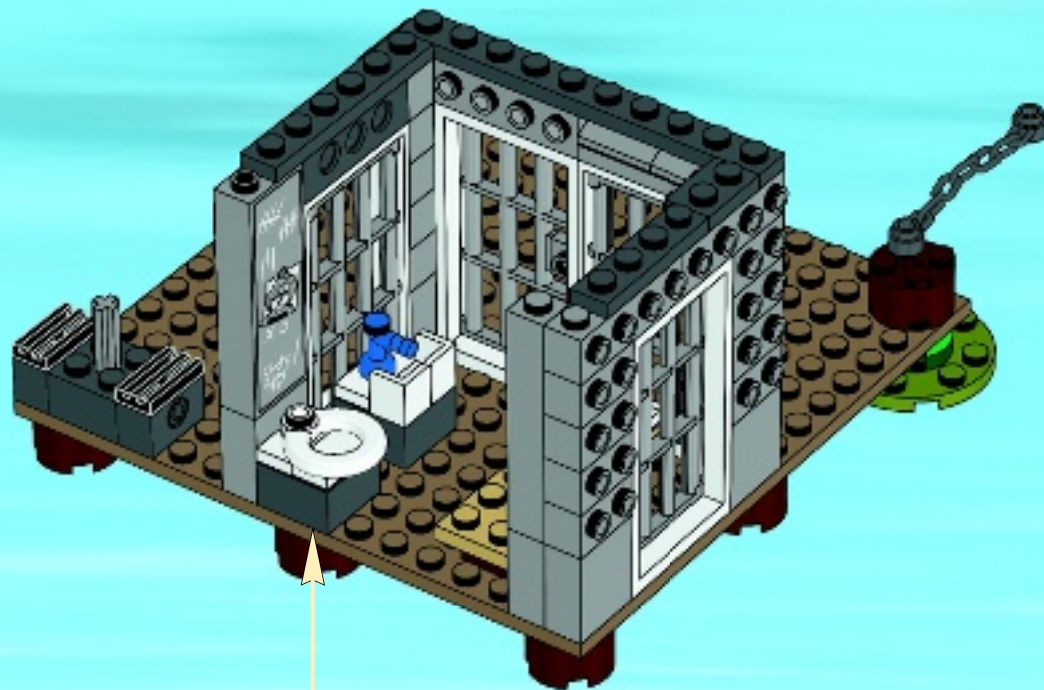

1



2



3





1x

# 27

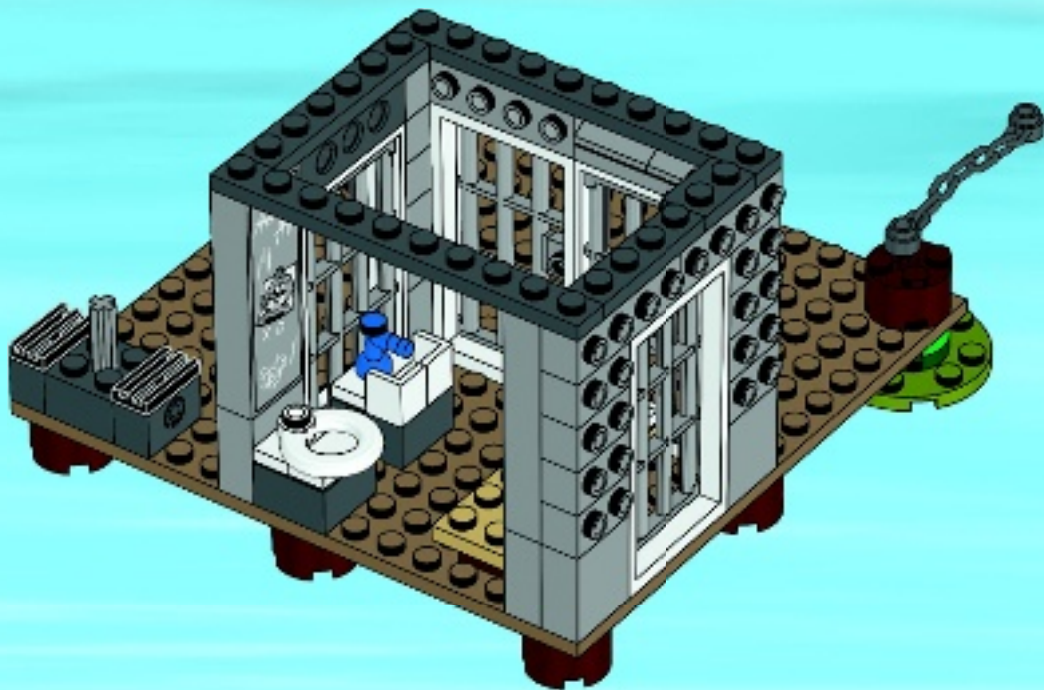

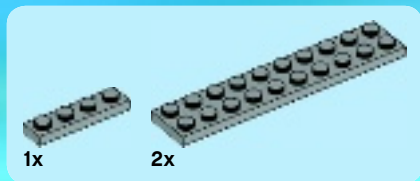

# 28

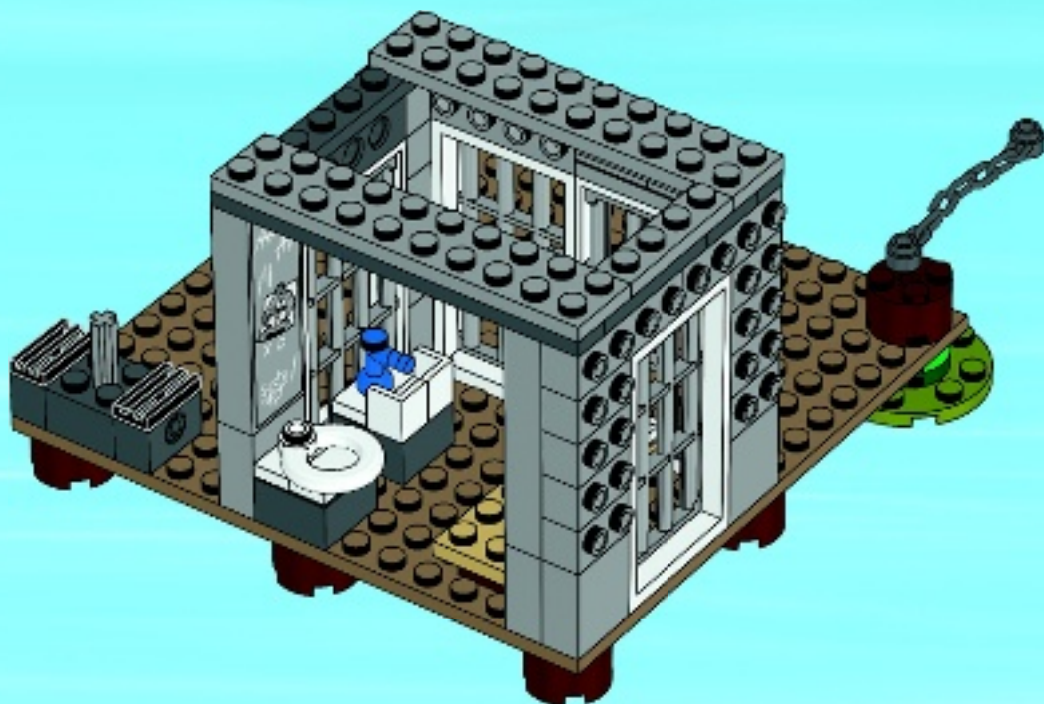

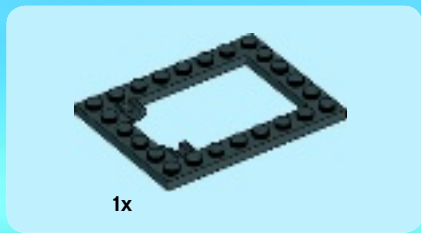

29

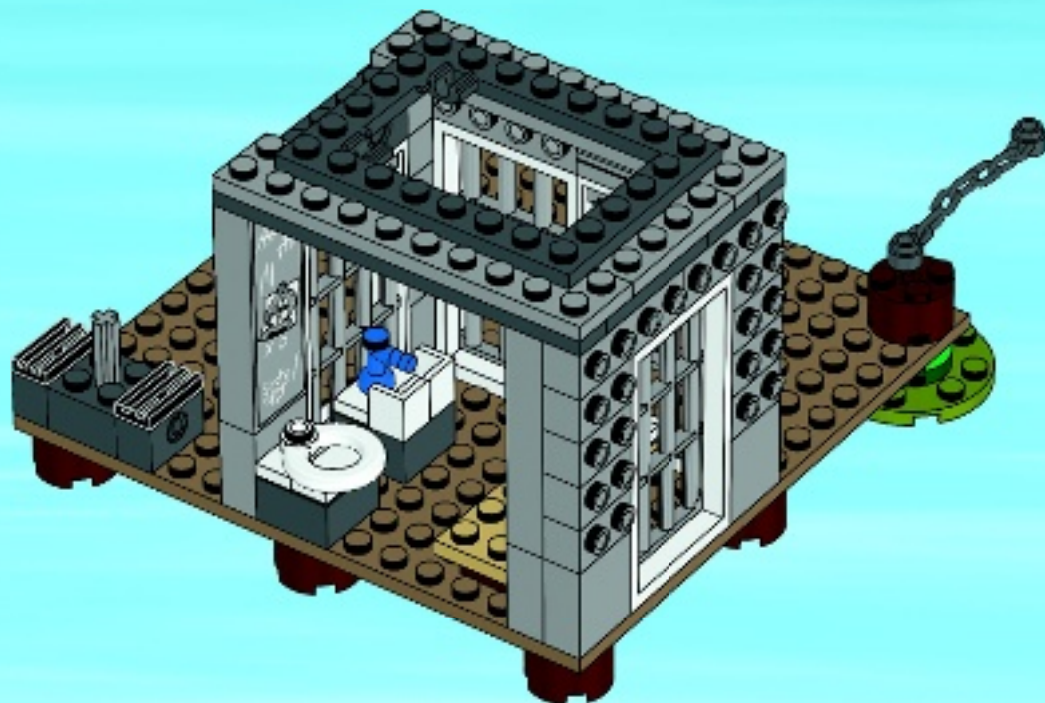

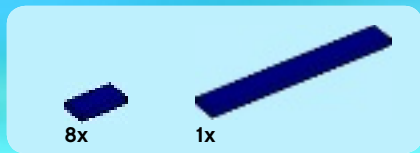

30

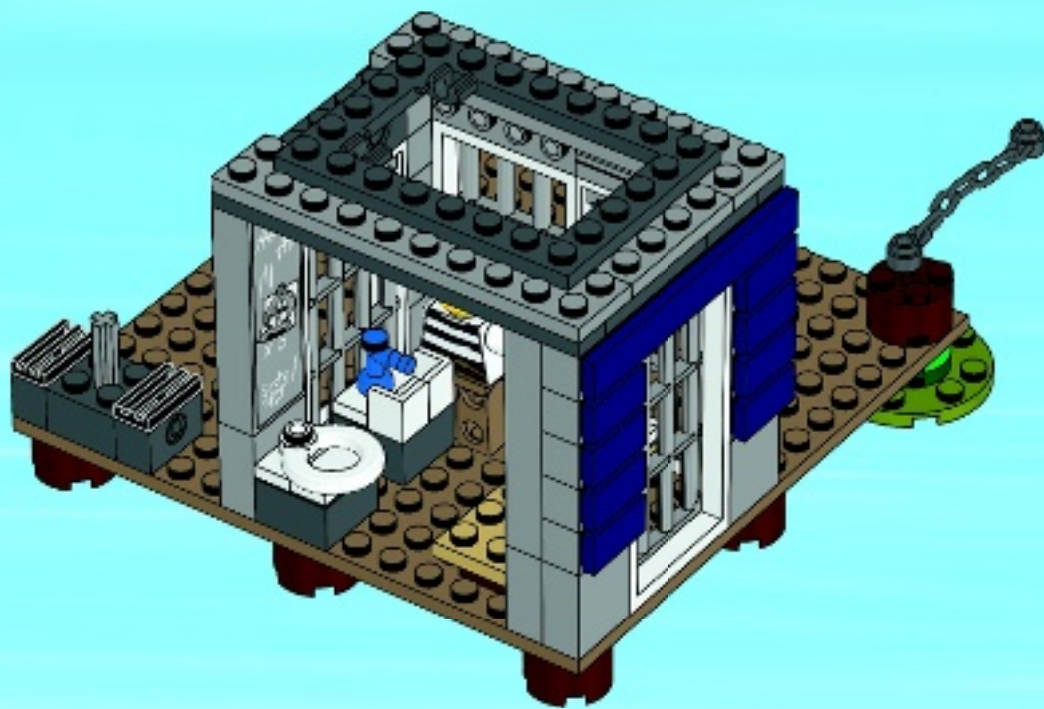



# 31

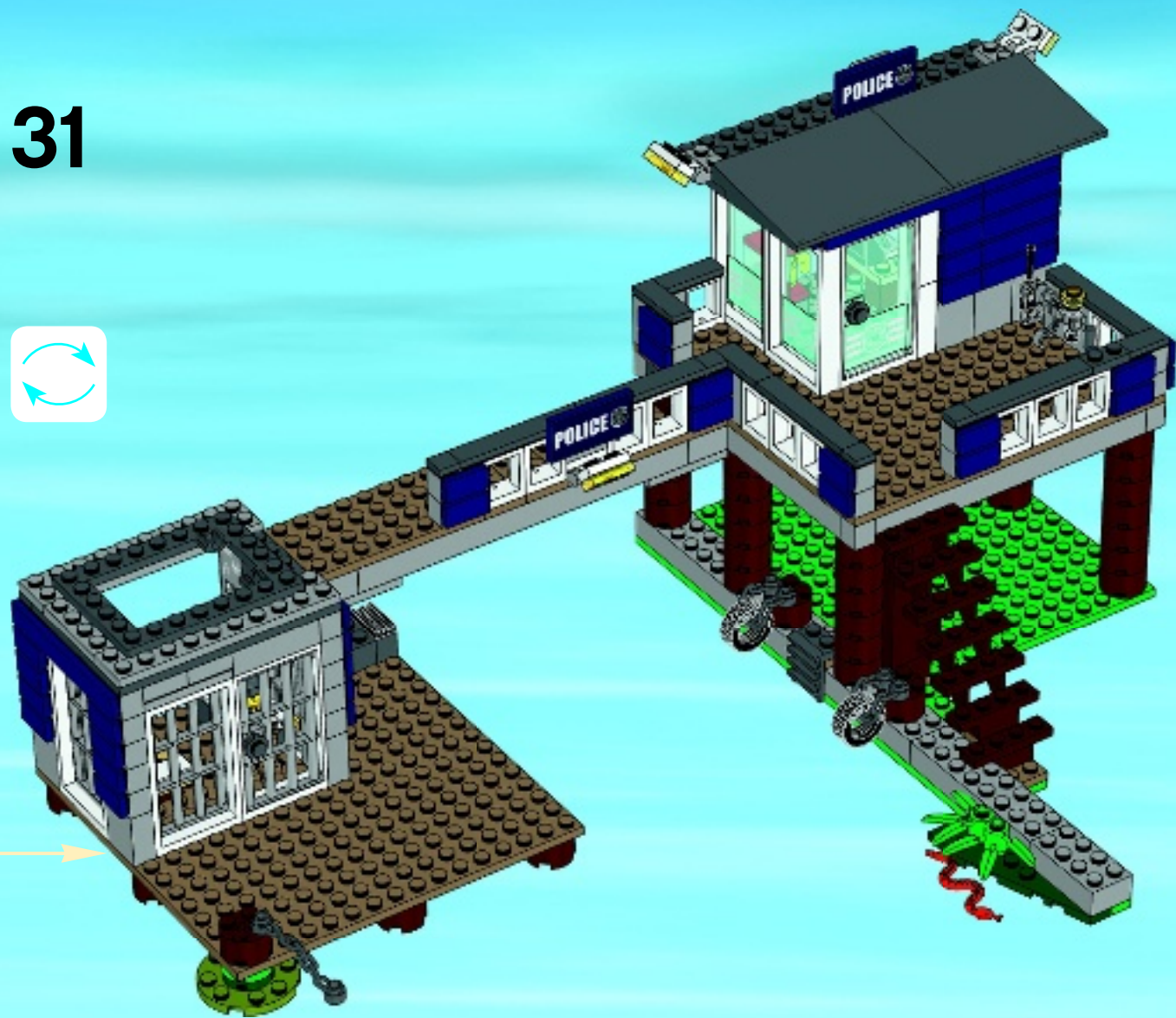

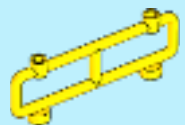
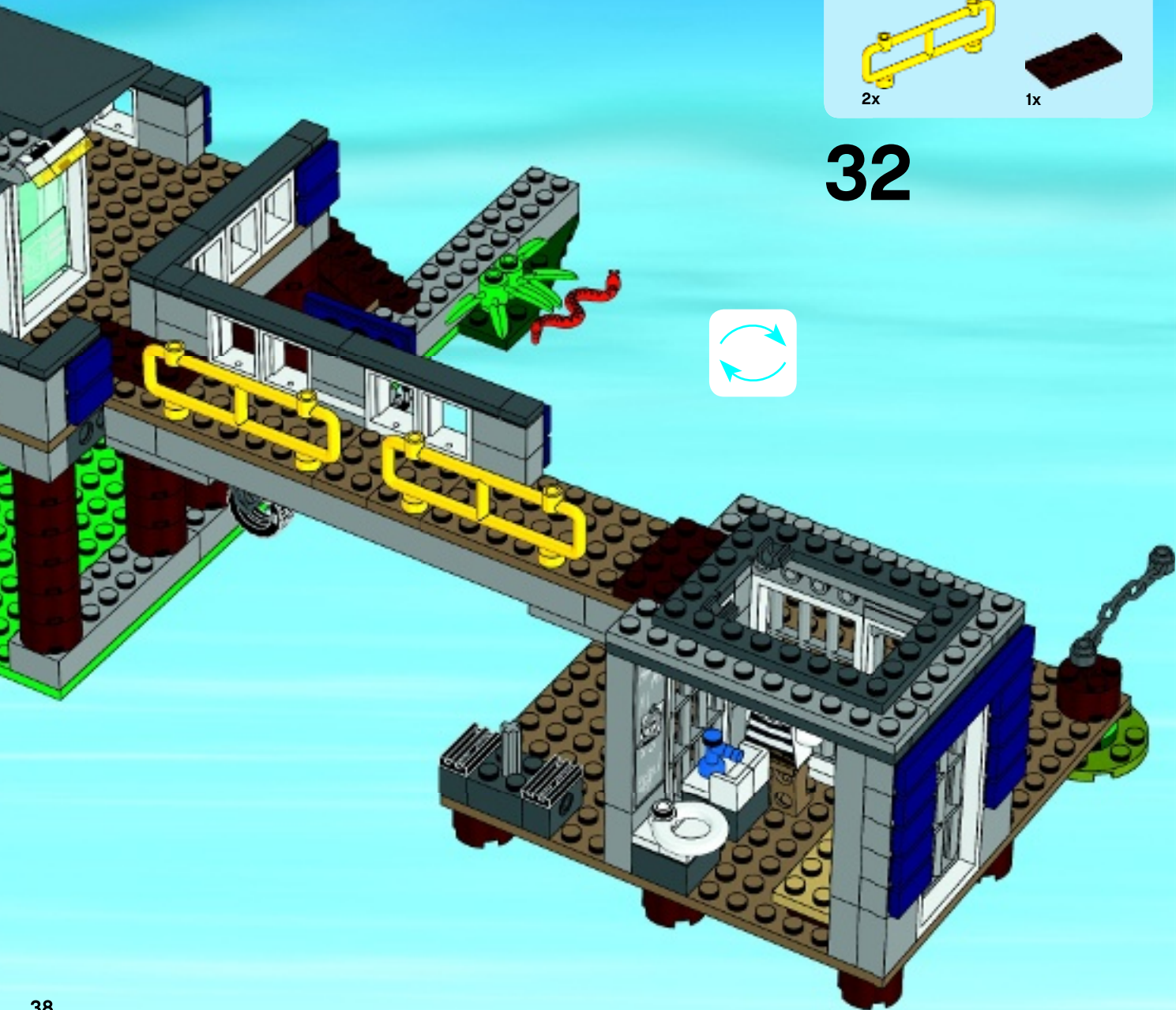

2x



1x

# 32





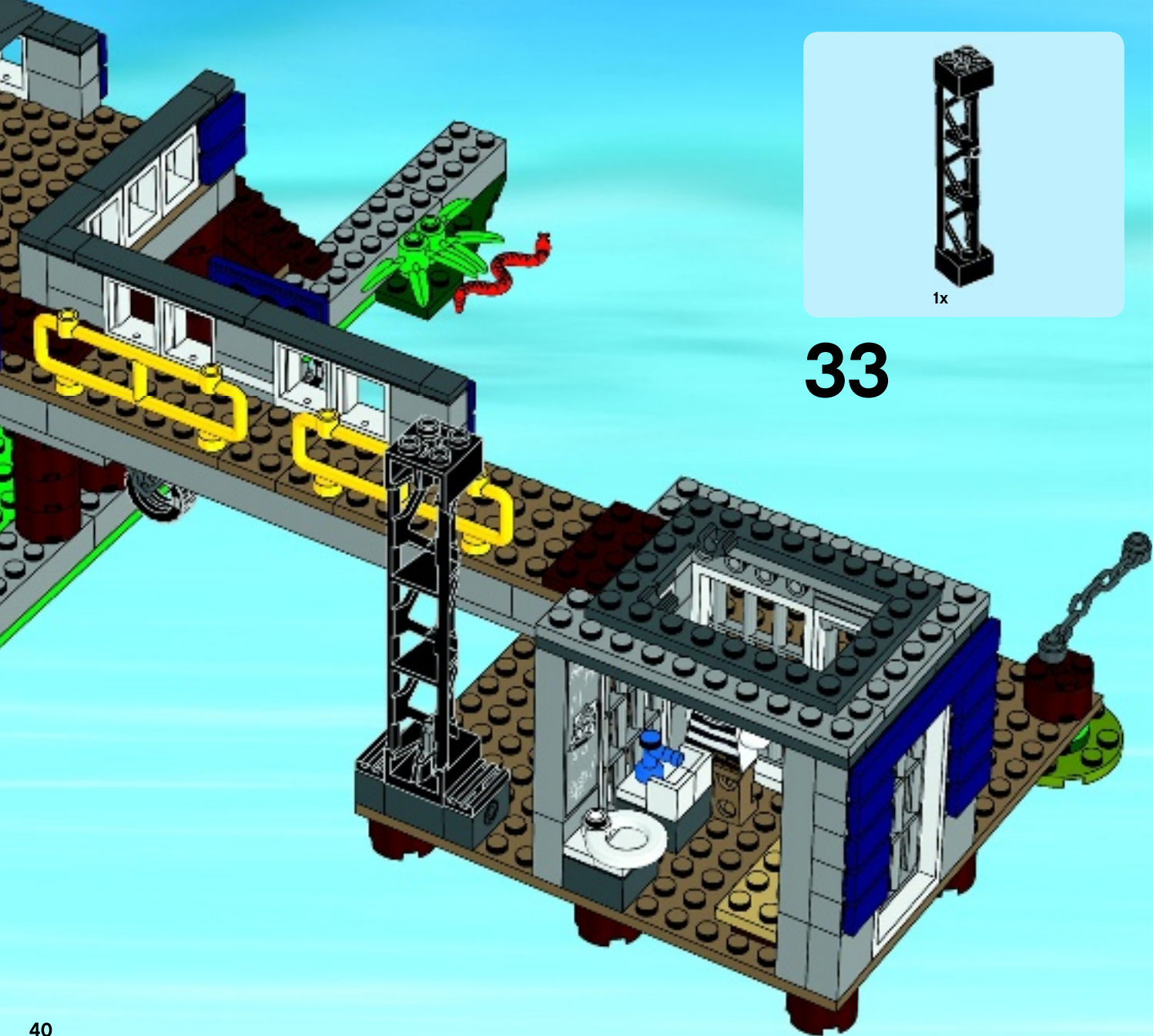

1x

33

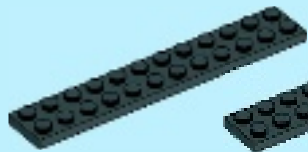

2x



2x



# 34

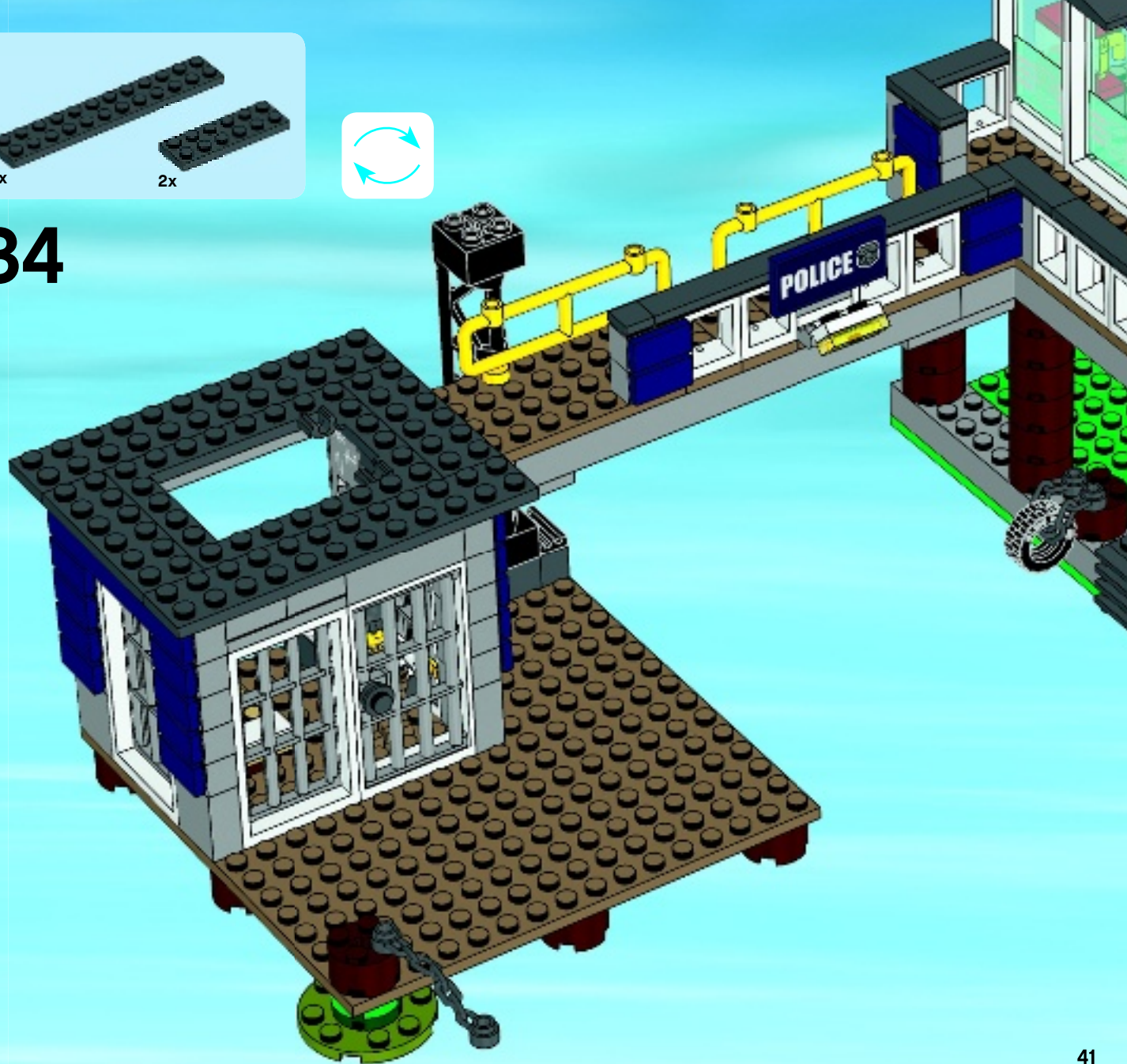



2x



2x

# 35





10x

# 36





# 37

## 1



## 2









1x

# 38





1x



1x

# 39

1



2





2x



1x

# 40





1x



1x

# 41



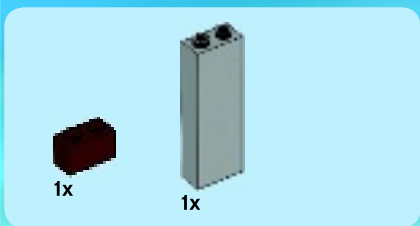

42

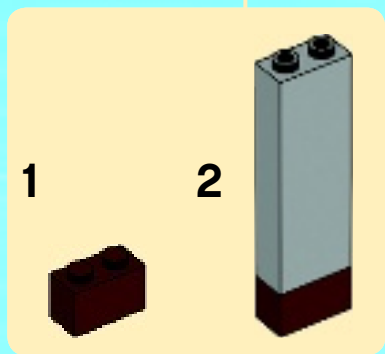
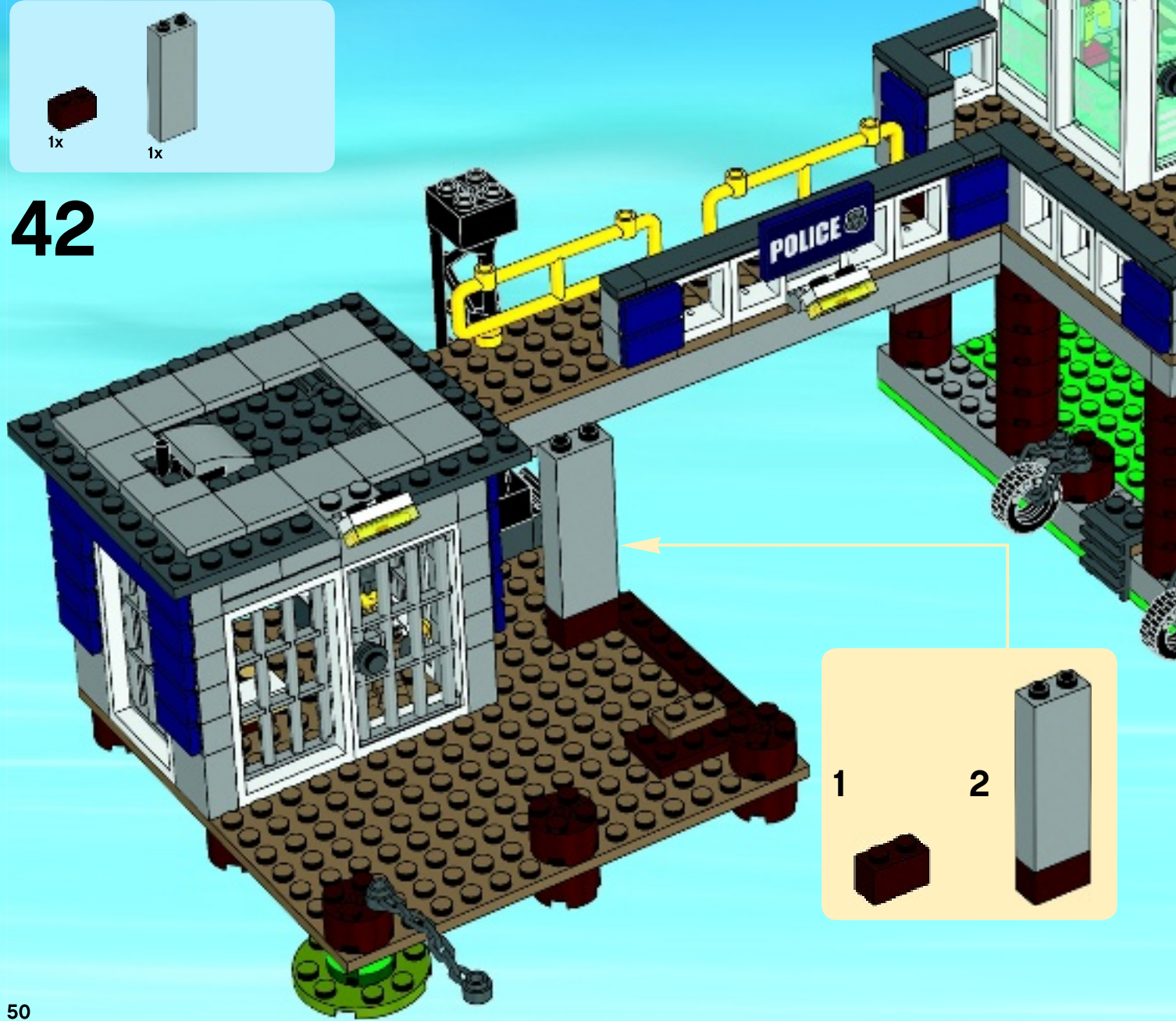



1x

43





1x

44

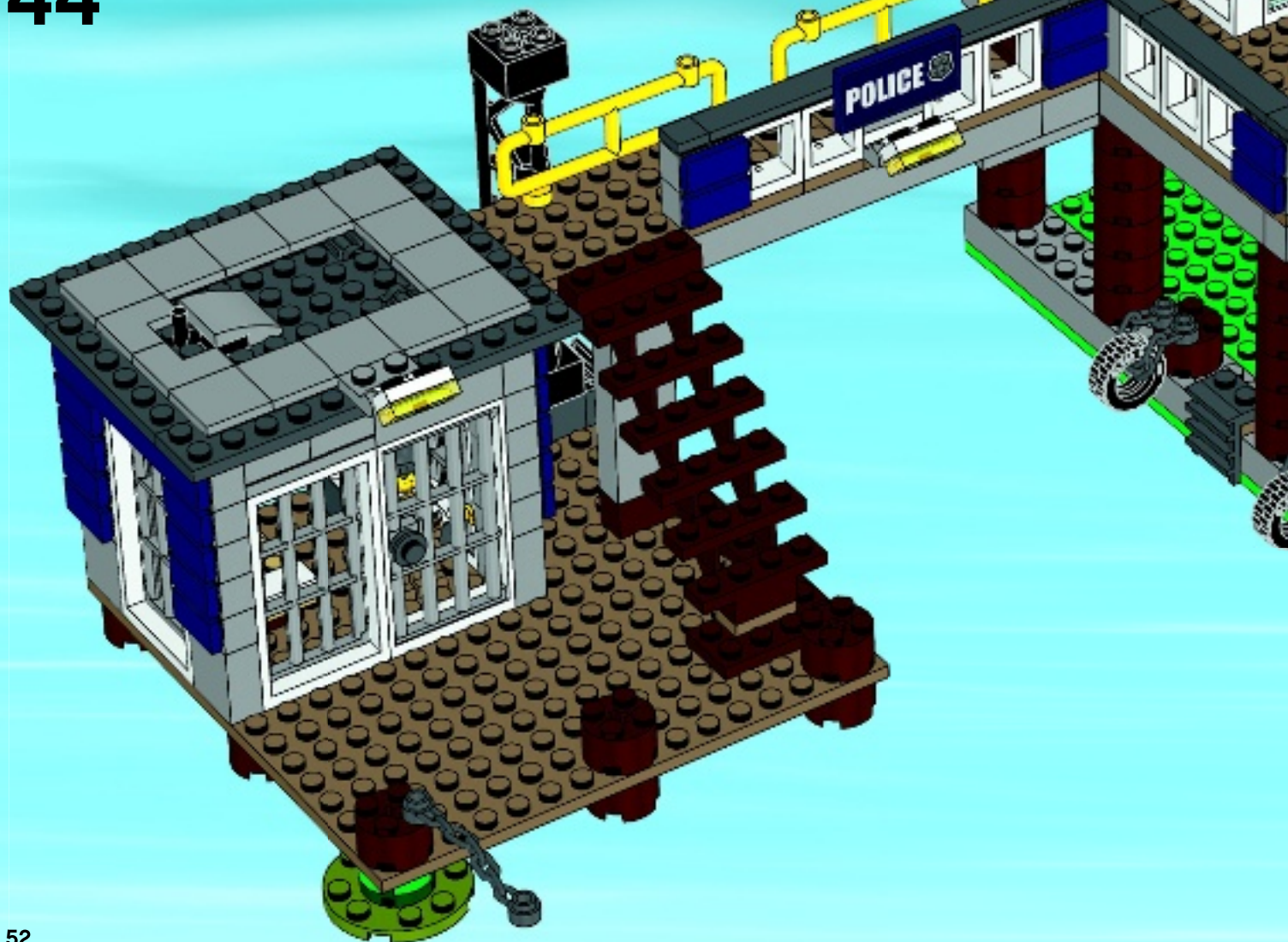





1x

# 45





3x



2x

# 46



1



2



2x



1x

47





1x



1x



1x

# 48

1



2



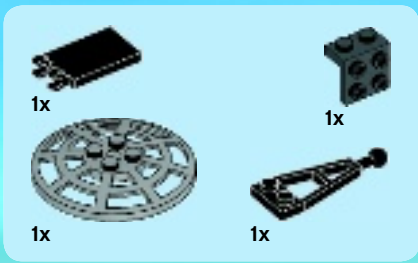

# 49

1



2



3



4







2x



1x

# 50





# CITY



[LEGO.COM/CITY](http://LEGO.COM/CITY)



60069



60068



60067



60066



60065



2x 6055541	1x 371001	1x 6100770	1x 4113993	4x 302324	2x 241226	1x 604126	1x 4520866
1x 300401	2x 416201	1x 6104351	2x 6100765	4x 407924	2x 243226	1x 4599984	2x 6022905
2x 362201	1x 303401	1x 4298609	2x 6103711	2x 4189225	1x 4569733	2x 4667463	1x 6013633
2x 300801	1x 4293350	1x 4297083	2x 4666579	1x 74156	1x 6021678	1x 4297713	1x 6013633
3x 4649167	6x 4598527	1x 390001	2x 300421	1x 6104356	1x 4274405	2x 368026	1x 382342
1x 6100792	2x 6070698	4x 4646576	1x 6092565	1x 6100203	1x 459926	5x 4295260	1x 403228
6x 366501	4x 4556152	2x 234001	1x 306821	1x 6112622	1x 6112622	3x 6100054	7x 4646861
2x 4234525	1x 246001	1x 368001	1x 302221	1x 6112620	1x 6112620	1x 383526	2x 3005744
2x 4515359	2x 623101	1x 407921	1x 389921	1x 6021844	1x 6021844	1x 4598897	1x 4278415
4x 6051511	12x 4521210	1x 407921	1x 4599453	1x 6018687	1x 6018687	6x 4617848	1x 4163306
2x 306901	1x 4526981	1x 389921	2x 4114052	2x 389924	2x 389924	1x 606428	1x 4267425
1x 302301	1x 6024495	1x 4113233	2x 4527354	2x 4527354	2x 4527354	2x 4244573	
1x 243101	6x 4114309	6x 4114309	1x 4648281	1x 4648281	1x 4648281	1x 4654448	
	1x 4530590	1x 4143005	2x 9553	2x 9553	2x 6064174		



- 1x 6102357
- 3x 4211350
- 2x 6066097
- 1x 4211398
- 2x 4211414
- 2x 6065824
- 13x 4211413
- 2x 4211445
- 1x 4560183
- 2x 4243797
- 4x 4211462
- 2x 4598526
- 1x 4654580
- 6x 4244627
- 1x 4613165
- 3x 4599496
- 1x 4610149
- 3x 4211524
- 2x 4221775
- 2x 4641048
- 4x 4299119
- 2x 4590443
- 3x 4540203
- 1x 4211815
- 2x 4211508
- 2x 4514192
- 1x 4237084
- 4x 4211060
- 3x 4211105
- 4x 4529240
- 2x 4211111
- 1x 4211024
- 1x 4213607
- 1x 4210917
- 2x 4567887
- 2x 4294180
- 1x 4549999
- 1x 4611703
- 2x 6117972
- 2x 4210636
- 2x 6071261
- 5x 4210848
- 1x 4211052
- 2x 4210631
- 3x 4568734
- 1x 4211001
- 5x 4211056
- 6x 4210651
- 2x 4211002
- 2x 4509884
- 6x 4543086
- 4x 4581225
- 2x 6013082
- 1x 4611708
- 1x 4595710
- 1x 4595708
- 1x 6031896
- 2x 4654618
- 1x 4516456
- 6x 4600437
- 1x 4211115
- 2x 4257526
- 5x 4211067
- 2x 4210796
- 2x 6071226
- 2x 4587212
- 2x 4210633
- 1x 6063616
- 1x 4210934
- 1x 4521512
- 1x 4211051
- 1x 6055312
- 2x 4603504
- 1x 6093516
- 1x 6093518
- 1x 306540
- 2x 4244363
- 4x 3000841
- 1x 4614195
- 1x 6055651
- 1x 6076604
- 2x 4632100
- 3x 6009086
- 1x 6024666



**Customer Service**  
**Kundenservice**  
**Service Consommateurs**  
**Servicio Al Consumidor**

**LEGO.com/service or dial**



**: 00800 5346 5555**  
**: 1-800-422-5346**



# CITY

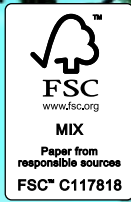

## FREE ONLINE GAME & APP!

KOSTENLOSES ONLINE-SPIEL & APP! · JEU EN LIGNE ET APLUS GRATUITES!  
 ¡JUEGO ONLINE Y APP GRATIS! · JOGO e APLICACÃO ONLINE GRÁTIS!  
 INGYENES ONLINE JÁTÉK ÉS APP! · 免費在線遊戲和 APP 應用!



LEGO.COM/CITY

ANDROID: APP ON Google play

Available on the App Store



Apple, the Apple logo, iPad, iPhone and iPod touch are trademarks of Apple Inc., registered in the U.S. and other countries.  
 App Store is a service mark of Apple Inc.  
 Google Play is a trademark of Google Inc.

LEGO and the LEGO logo are trademarks of the LEGO Group. ©2015 The LEGO Group. 6117229



# CITY

60069

 [LEGO.com/city](http://LEGO.com/city)





+

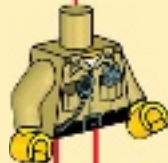
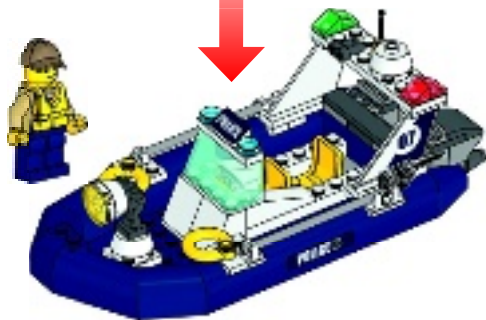

1

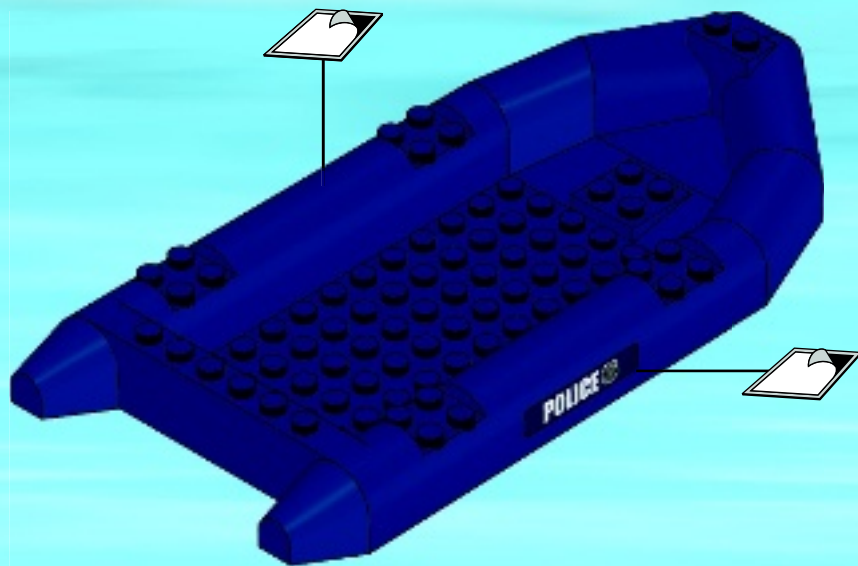



4x

2

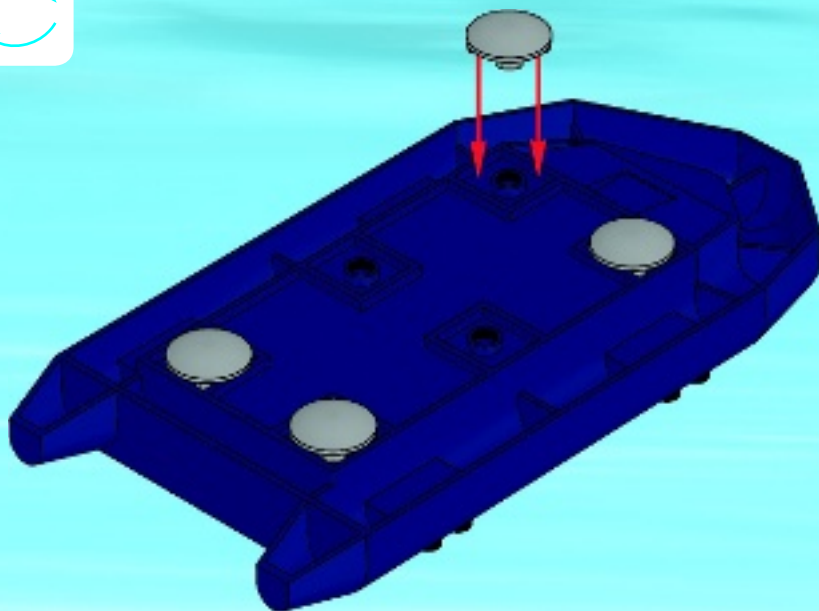





2x



1x

3

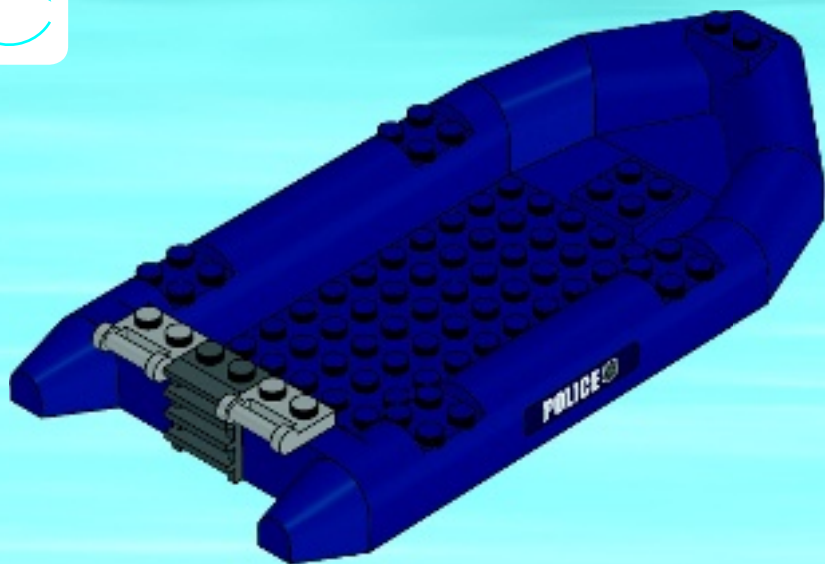



1x

4

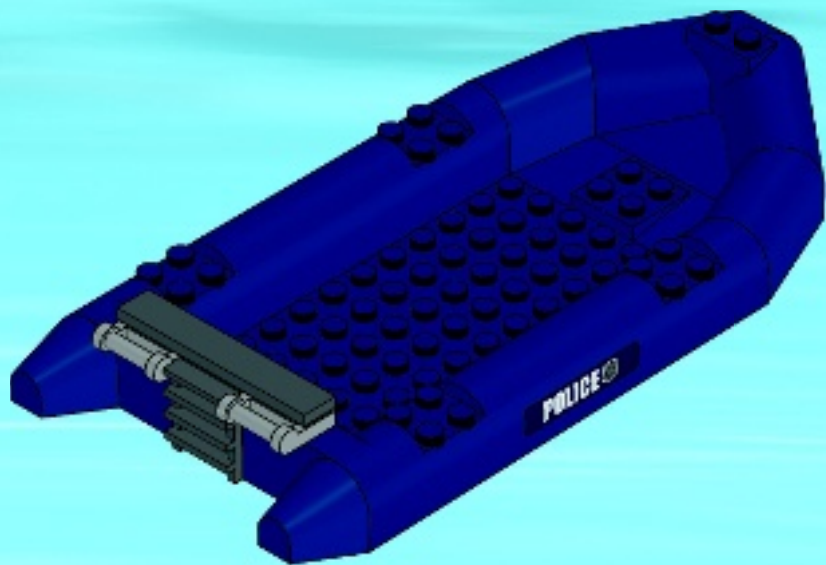

6



1x

1



1x



1x

2

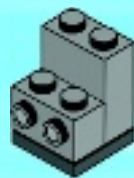



1x

3

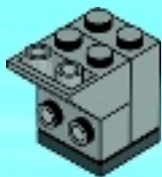

2x

4





1x



1x

**5**

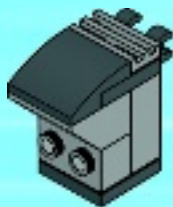

2x

**6**



**2x**

5

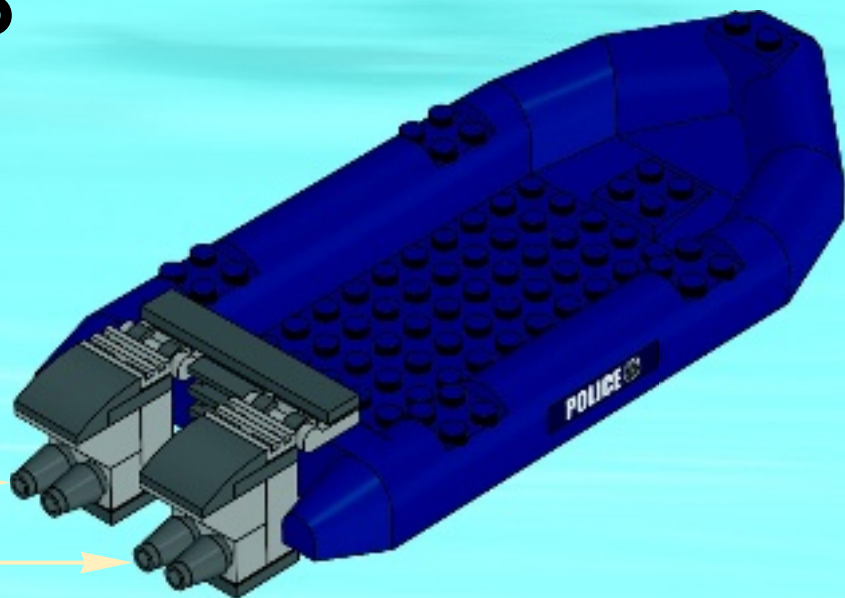



1x



1x



1x

1



2



6

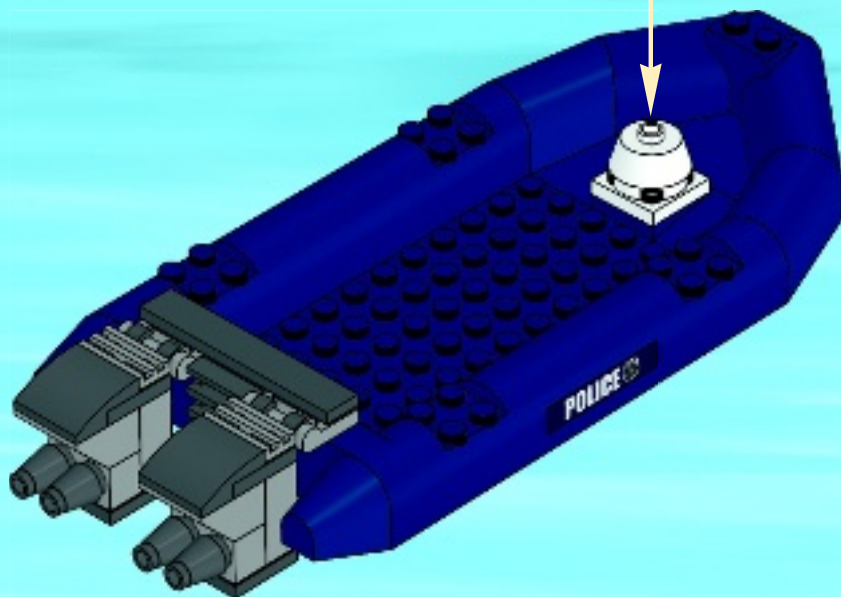



1x

7







1x



1x

8

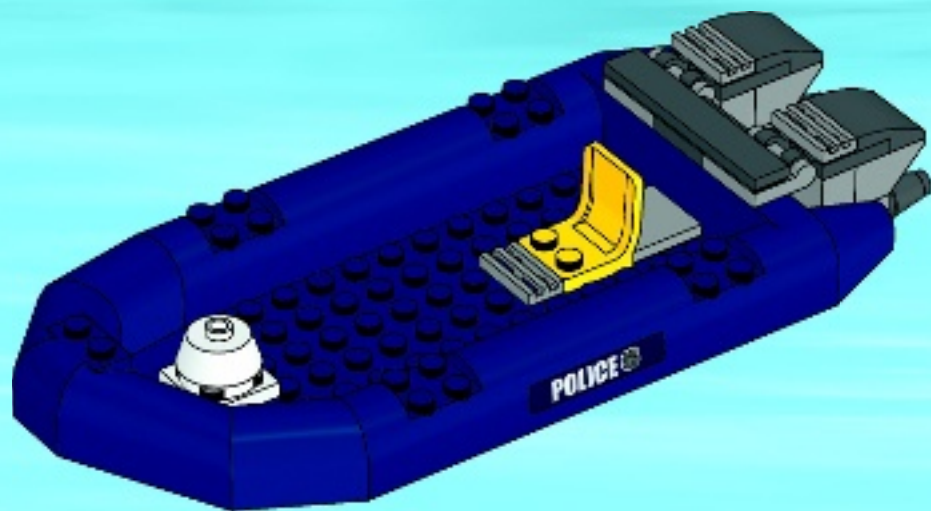



1x



1x

9

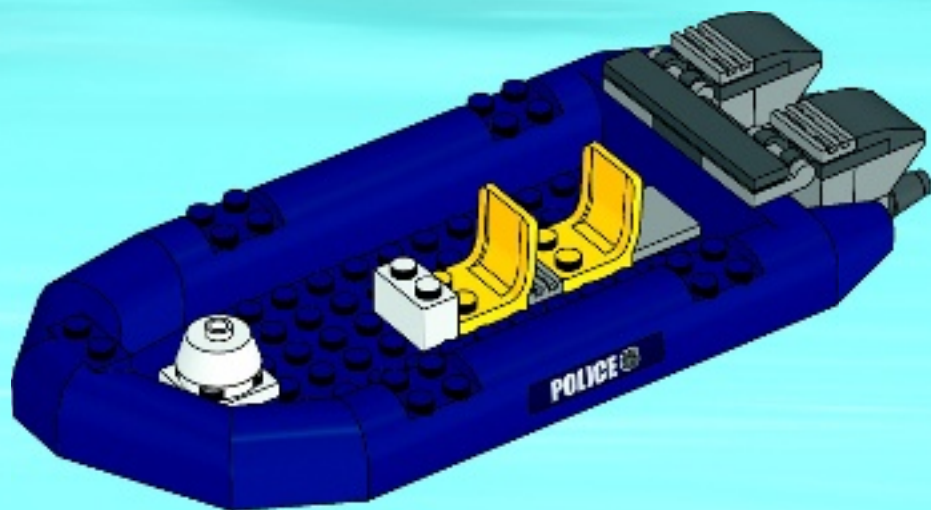

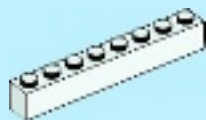

2x

10

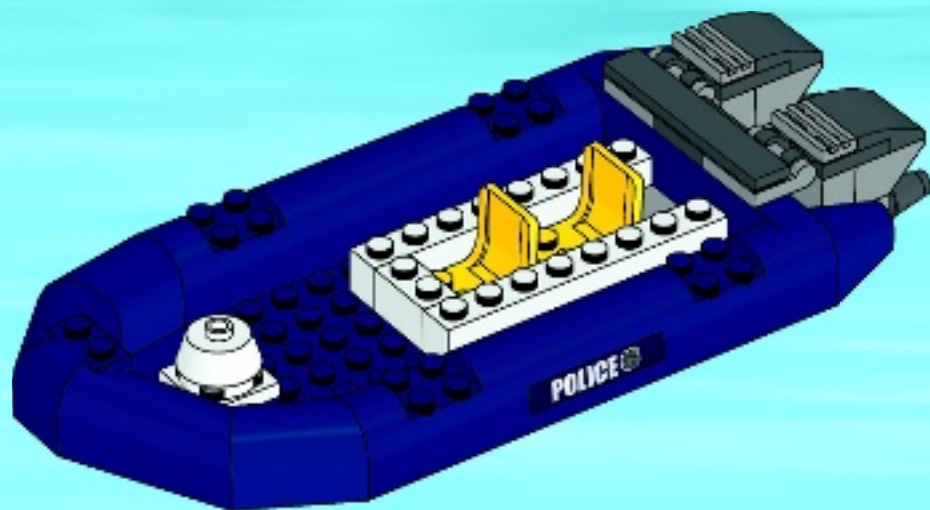



1x



2x

# 11

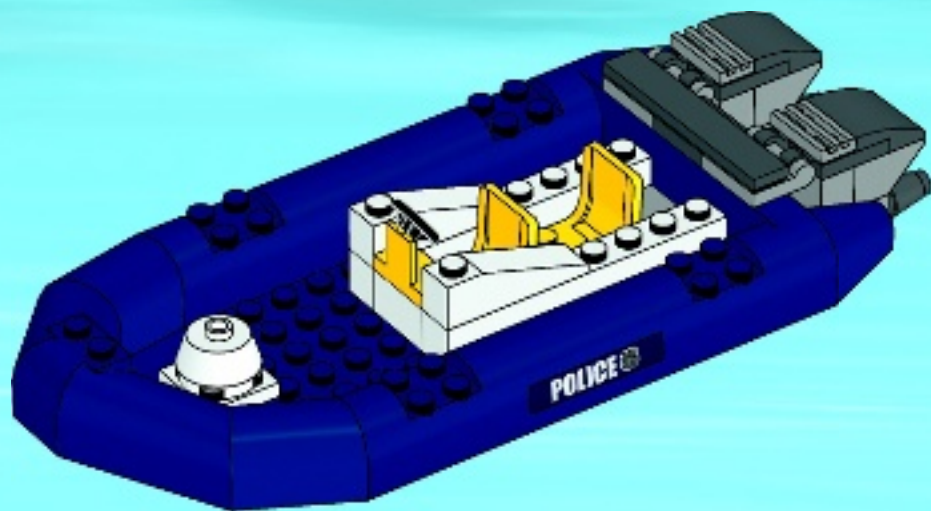



2x

12

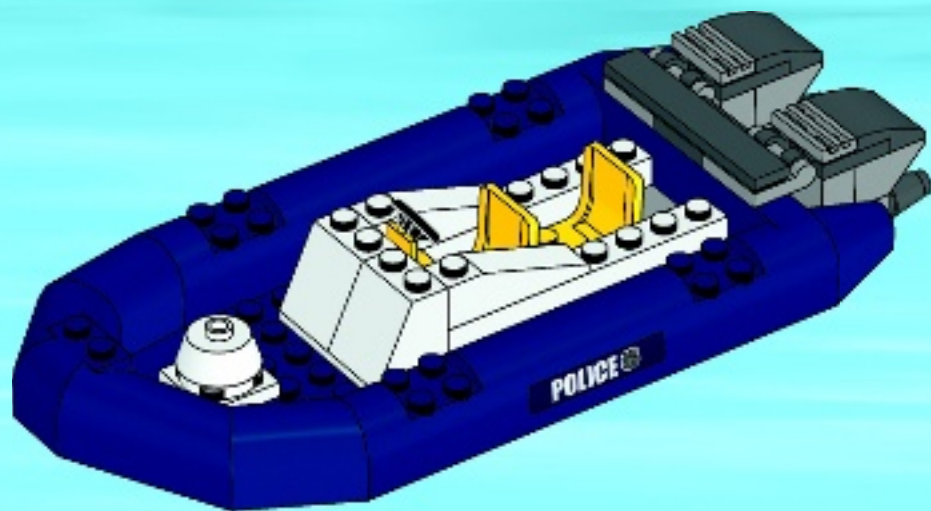



4x

# 13

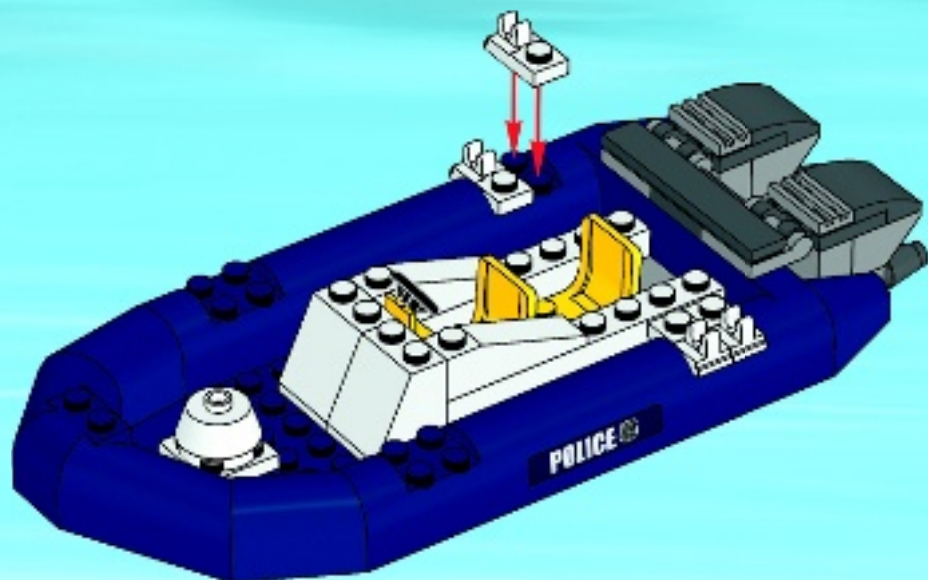



2x



2x

# 14

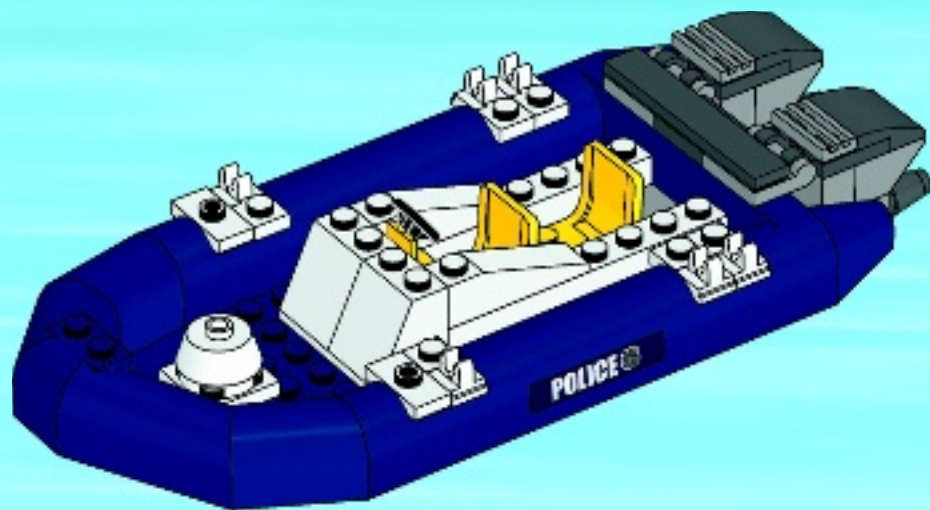



1x



1x

# 15

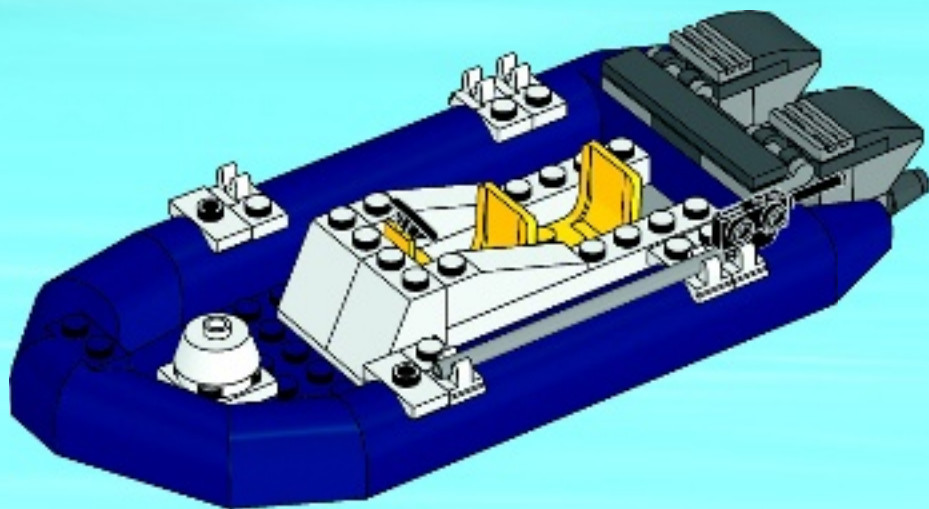



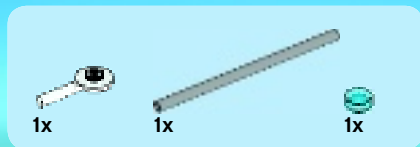

16

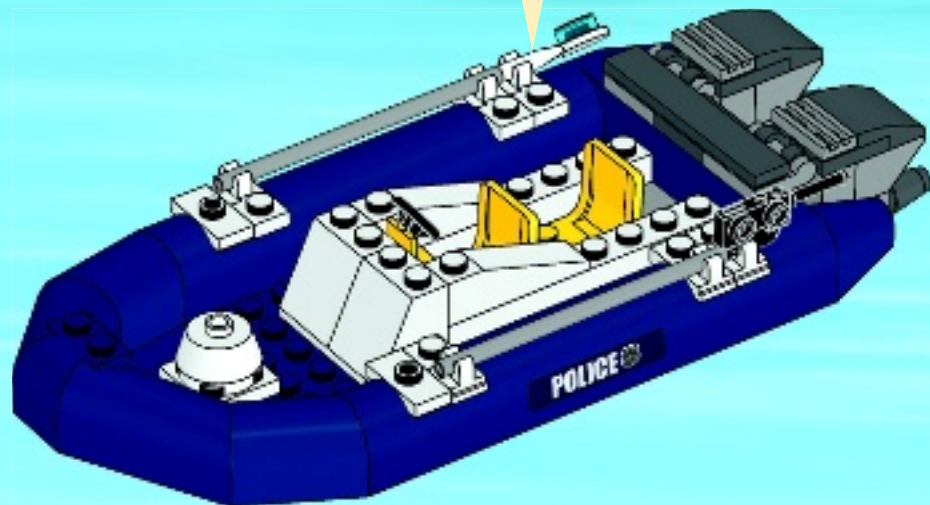

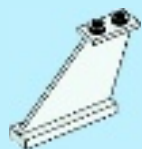

1x

# 17

## 1

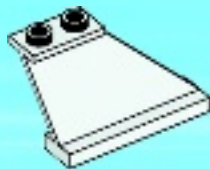

## 2

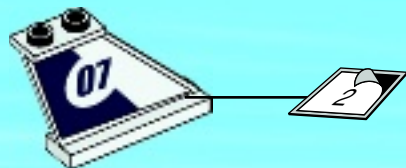

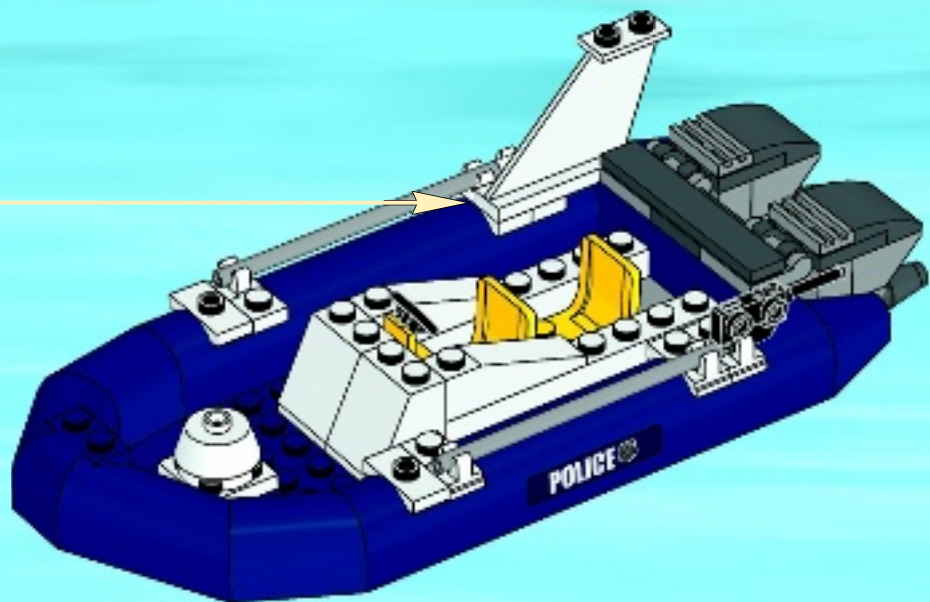

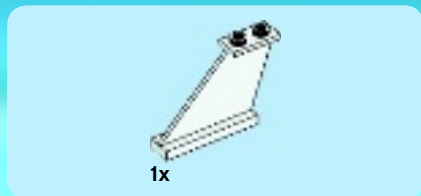

18

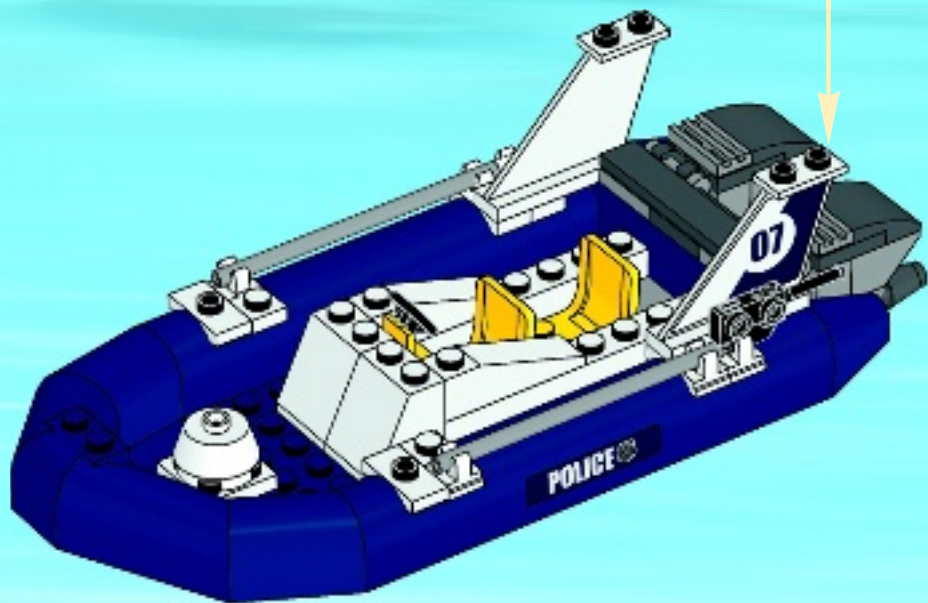
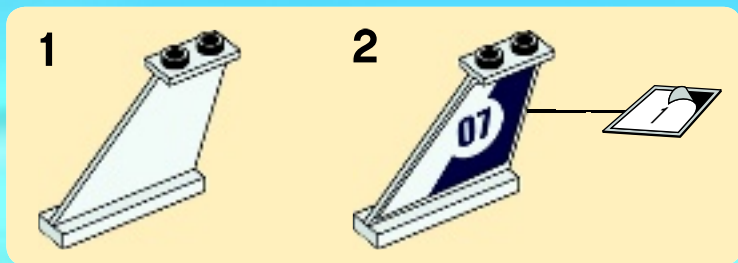



1x



2x



2x



1x



1x



1x

# 19

## 1

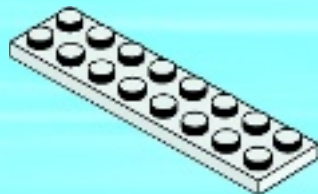

## 2

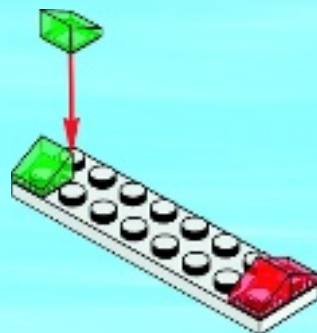

3

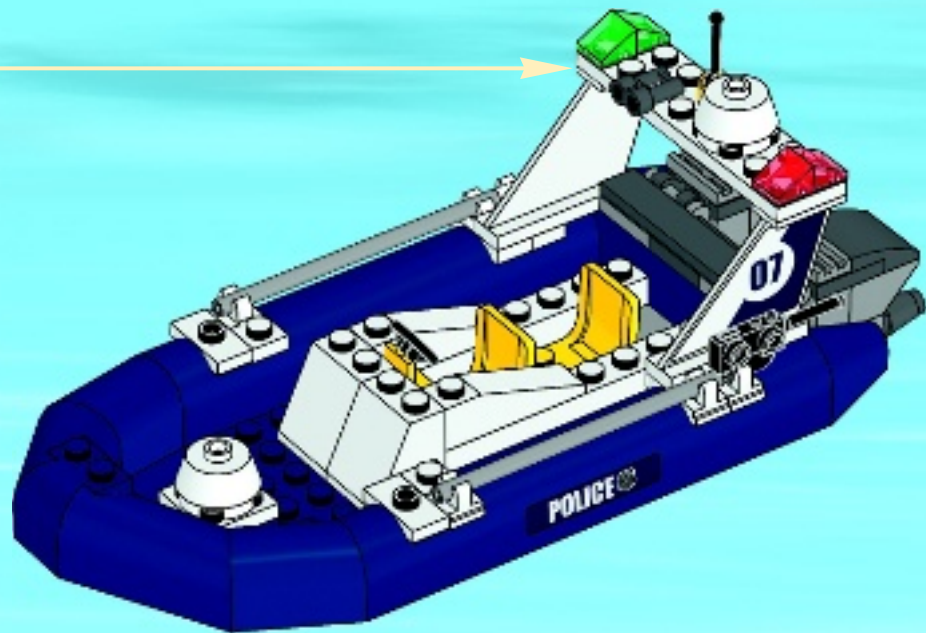
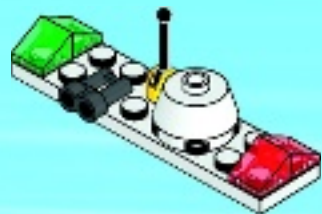

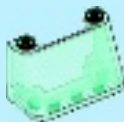

1x

20

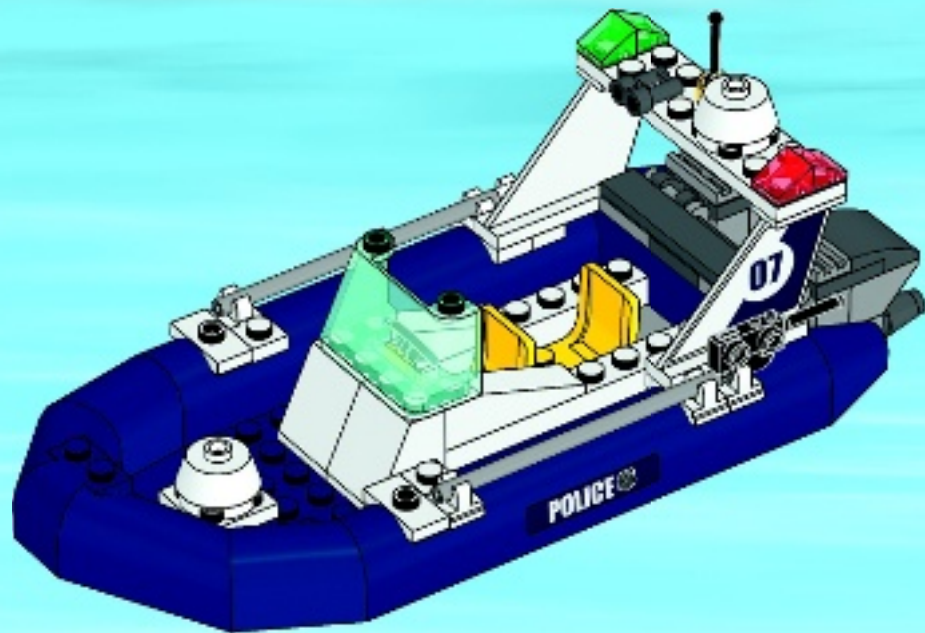



1x



1x



2x

1

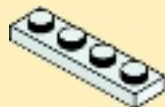

2



# 21

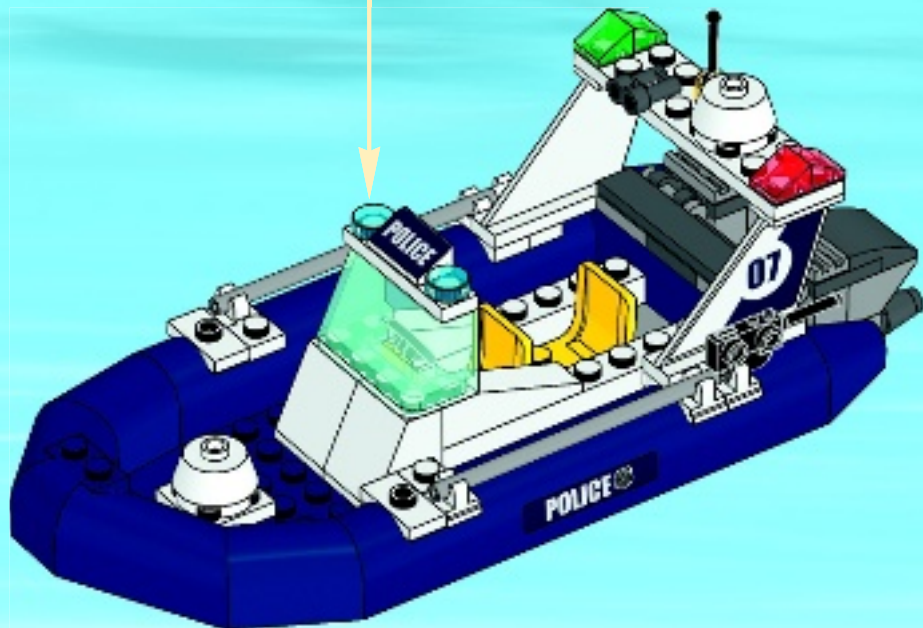





2x

22

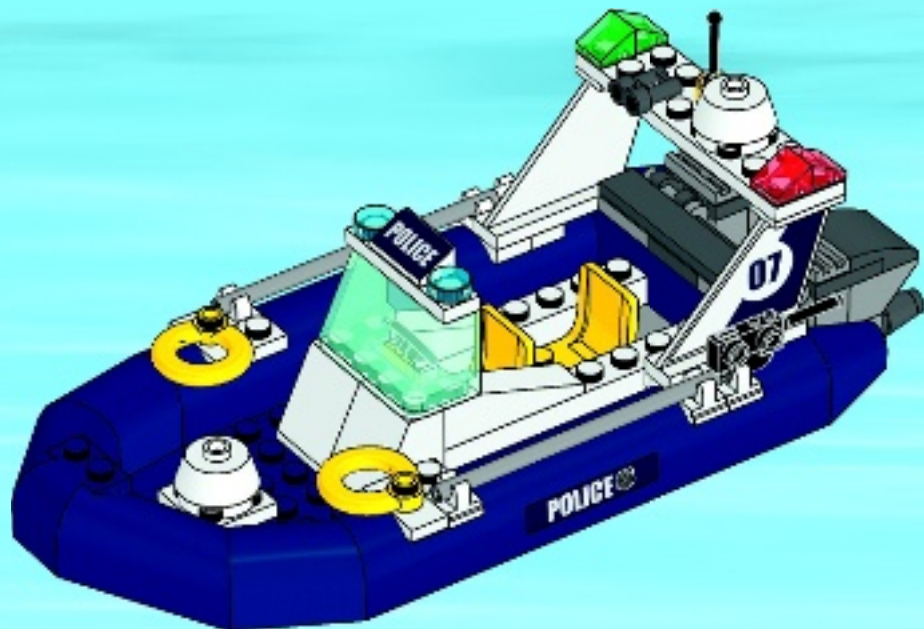



1x



2x



1x



1x

# 23

1



2



3



4





